

TEC

TEC Electronic Cash Register

FS-2600-1 SERIES

Owner's Manual

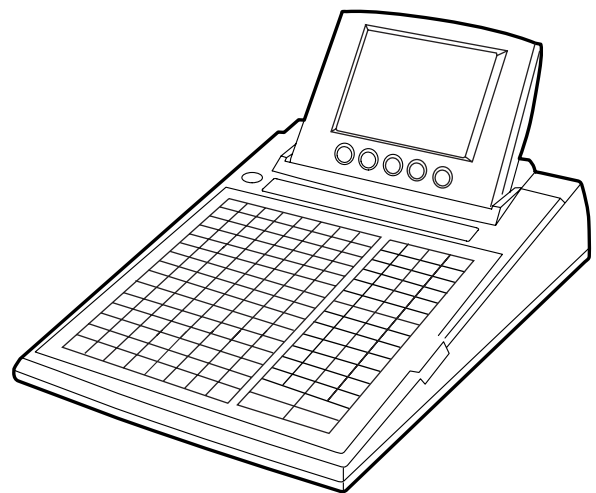

TOSHIBA TEC CORPORATION

NOTICE

This equipment has been tested and found to comply with the limits for a Class A digital device, pursuant to Part 15 of the FCC Rules. These limits are designed to provide reasonable protection against harmful interference when the equipment is operated in a commercial environment. This equipment generates, uses, and can radiate radio frequency energy and, if not installed and used in accordance with the instruction manual, may cause harmful interference to radio communications. Operation of this equipment in a residential area is likely to cause harmful interference in which case the user will be required to correct the interference at his own expense. Changes or modifications not expressly approved by manufacturer for compliance could void the user's authority to operate the equipment.

WARNING

"This Class A digital apparatus meets all requirements of the Canadian Interference-Causing Equipment Regulations."

"Cet appareil numérique de la classe A respecte toutes les exigences du Règlement sur le matériel brouilleur du Canada."

1. STAND-ALONE LEVEL OPERATOR'S GUIDE

TABLE OF CONTENTS

	Page
1. INTRODUCTION	1-1
1.1 Applicable Model	1-1
1.2 Accessories	1-1
2. SPECIFICATION	2-1
2.1 ECR	2-1
2.2 Hardware Option	2-2
3. APPEARANCE AND NOMENCLATURE	3-1
3.1 Front View	3-1
3.2 Rear View	3-2
4. MODE LOCK AND MODE SELECTOR KEYS	4-1
4.1 Mode Lock	4-1
4.2 Mode Selector Keys	4-1
5. DISPLAY	5-1
5.1 Operator Display	5-1
5.2 Customer Display	5-3
6. KEYBOARD	6-1
6.1 Keyboard Layout	6-1
6.2 Functions of Each Key	6-2
7. PROCEDURE BEFORE OPERATION	7-1
8. CASHIER SIGNING OR CASHIER KEY OPERATIONS	8-1
8.1 Code Entry Method	8-1
8.2 Cashier Key Method ([CLK] Keys)	8-2
8.3 Training Mode Start and End	8-3
8.4 "Cashier Exclusive" Option	8-4
9. TRANSACTION ENTRIES	9-1
9.1 Receipt-Issue/Non-issue Selection	9-2
9.2 Store Message Display	9-2
9.3 No-sale	9-2
9.4 Loan	9-3
9.5 Check Cashing (No-sale cashing of a non-cash media)	9-4
9.6 No-sale Exchange from Foreign Currency to Domestic Currency	9-4
9.7 No-sale Exchange from Domestic Currency to Foreign Currency	9-5

9.8	PLU (menu item) Entry through the Keyboard	9-5
9.9	PLU (menu item) Entry through the Menu Window	9-6
9.10	Repeat Entry	9-7
9.11	Quantity Extension (Multiplication)	9-7
9.12	Set Menu Entry	9-8
9.13	Modifier Entry	9-9
9.14	Other Income PLU Entry	9-9
9.15	PLU Code Shift Entry	9-10
9.16	PLU Price Shift Entry	9-10
9.17	Combo (Combination) Sale Entry	9-11
9.18	Scale Entry	9-11
9.19	Subtotal Read	9-12
9.20	Tray Total Read	9-13
9.21	Item Correct	9-14
9.22	Void (Designated Line Voiding and Returned Merchandise)	9-14
9.23	All Void	9-15
9.24	Order Entry Control	9-15
9.25	Order Entry Control with Table No.	9-17
9.26	Temporary Release of Order Table No. Entry Compulsion	9-18
9.27	Guest Check Merge	9-18
9.28	Guest Check Transfer	9-18
9.29	Guest Check Split	9-19
9.30	Sale Finalization by Media Keys (Payment of a Sale)	9-20
9.31	Charge Posting by Check Track	9-20
9.32	Sale Paid in Foreign Currencies	9-21
9.33	Media Transfer	9-21
9.34	Tax Status Modification	9-22
9.35	Automatic Tax Calculation	9-22
9.36	Manual Tax Entry	9-22
9.37	Tax Exemption	9-23
9.38	Listing Capacity Open	9-23
9.39	Selective Itemizer (SI) Status Modification	9-23
9.40	Selective Itemizer (SI) Total Read	9-23
9.41	PLU Preset Price Read	9-24
9.42	PLU Stock Read	9-24
9.43	Dollar Discount	9-25
9.44	Percent Discount, Percent Charge	9-25
9.45	Non-add Number Print	9-26
9.46	Number-of-guests Entry	9-26
9.47	Function Key Entry	9-26
9.48	Tip Paid	9-27
9.49	Charge Tip	9-27
9.50	Received-on-Account	9-27

9.51	Paid-Out	9-28
9.52	Print Mode Invert	9-28
9.53	RKP (remote kitchen printer) Receipt Cut	9-29
9.54	RKP (remote kitchen printer) Message Print	9-30
9.55	Guest Check Print	9-30
9.56	Check Print	9-31
9.57	Receipt Post-issue (Receipt Reprint & Guest Check Reprint)	9-32
9.58	Server Transfer	9-33
9.59	Employee Clock-in/Clock-out	9-34

10. Troubleshooting **10-1**

10.1	Problems concerning the Power Supply	10-1
10.2	Problems concerning the Keyboard	10-1
10.3	Problems concerning the Drawer	10-2
10.4	Problems concerning the Display	10-2
10.5	Problems during Normal Operations	10-2

CAUTION:

- 1. This manual may not be copied in whole or in part without prior written permission of TOSHIBA TEC.*
- 2. The contents of this manual may be changed without notification.*
- 3. Please refer to your local Authorized Service representative with regard to any queries you may have in this manual.*

1. INTRODUCTION

Thank you for choosing the TEC electronic cash register FS-2600-1 series. This owner's manual provides a description of the functions and handling of this register and should be read carefully to ensure optimum performance. Since every consideration has been given to safety and reliability, there is no danger of damaging the machine by incorrect operation.

Please refer to this manual whenever you have any questions concerning the machine. This machine has been manufactured under strict quality control and should give you full satisfaction.

- Be sure to keep this manual for future reference.

1.1 Applicable Model

- FS-2600-1MD-US
- FS-2600-1MD-C-US

The description of the model number is as follows.

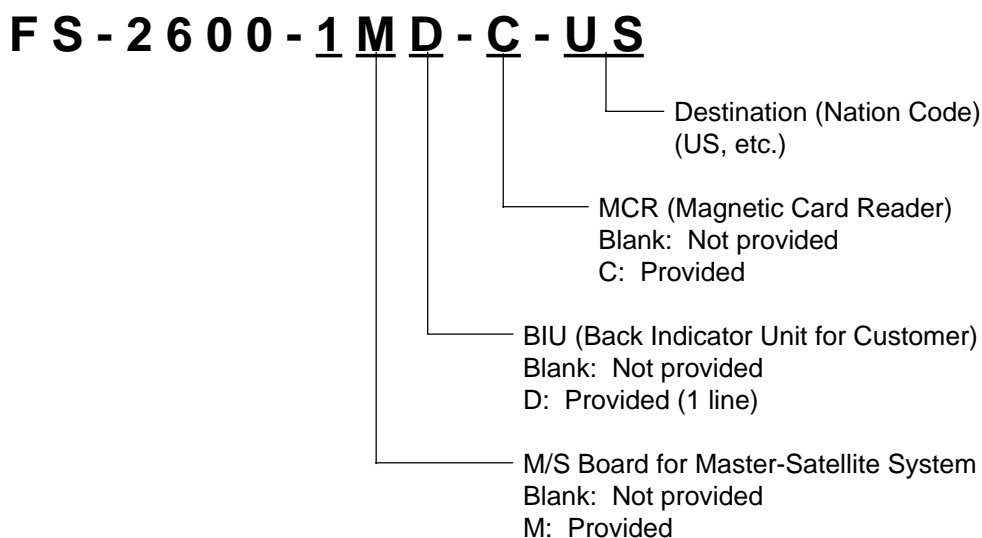

1.2 Accessories

Owner's Manual
(EO1-11138; 1 pc.)

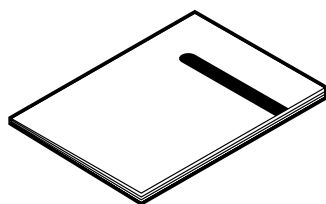

Control Key
(REG Key, MGR Key, MA Key,
S Key; 2 pcs. respectively)



Double Sems Screw
(M-3x8; 1pc.)



* Used to secure the Cable Blind Plate
Refer to 3.2 Rear View (page 3-2).

2. SPECIFICATION

2.1 ECR

2.1.1 Software Item

Capacity of Department Memory	Max. 99 departments	
Capacity of Group Memory	Max. 30 groups	
Capacity of Major Group Memory	Max. 10 major groups	
Capacity of Cashier Memory	Max. 8 cashiers for the [CLK] key	
	Using Standard Memory	Using Expansion Memory
	Max. 15 cashiers	Max. 99 cashiers
Capacity of Employee Memory	Max. 200 employees	Max. 200 employees
Capacity of Customer File Table	Max. 5000 tables	Max. 5000 tables
Capacity of PLU Memory	Without the option "Collecting the PLU data by each price level"	
	Max. 1000 PLUs	Max. 2500 PLUs
	With the option "Collecting the PLU data by each price level"	
	Max. 500 PLUs	Max. 1500 PLUs
Capacity of PLU Group Memory	Max. 99 PLU groups	
Unit Price Programmable	Max. 6 digits; 0.00 to 9999.99	

2.2.1 Hardware Item

Size	280 mm (width) x 442 mm (depth) x 235.6 mm (height) (or 475.5 mm (depth) and 129.5 mm (height) when the operator display is in its full opened position.)
Weight	4.0 kg
Power Required	117 V, 60 Hz (US)/240V, 50 Hz (AU)
Power Consumed	0.3 A (operating; US)/0.14 A (operating; AU)
Ambient Temperature	0 C to 40 C
Relative Humidity	10% to 90% RH (non-condensing)
Interface Port	COM 1 & 2, PC and M/S
Memory Protection	Long-lasting rechargeable lithium battery is provided.

Specifications are subject to change without notice.

2.2 Hardware Option

Option Name	Description	Source
IF-2600RS	The 3rd printer can be connected to the FS-2600 by installing this interface board.	Contact your TOSHIBA TEC representative.
KRAM-H-2600	Expansion memory of 0.5 MB	
KRAM-1-2600	Expansion memory of 1 MB	
KRAM-2-2600	Expansion memory of 2 MB	
KRAM-4-2600	Expansion memory of 4 MB	
KBD-2600-2	2- line back indicator unit (16-digit dot display and 7-digit 7-segment display)	
KRD-2600-1	1-line remote indicator unit (7-digit 7- segment display)	
KRD-2600-2	2- line remote indicator unit (16-digit dot display and 7-digit 7-segment display)	
IF-1650C	Interface board to connect a scale to the FS-2600	
MD-6	A maximum of 2 remote drawers can be connected to the FS-2600 to realize the multi-drawer feature. Either the "multi-drawer feature controlled by a cashier" or "multi-drawer feature controlled by a currency" can be selected.	

3. APPEARANCE AND NOMENCLATURE

3.1 Front View

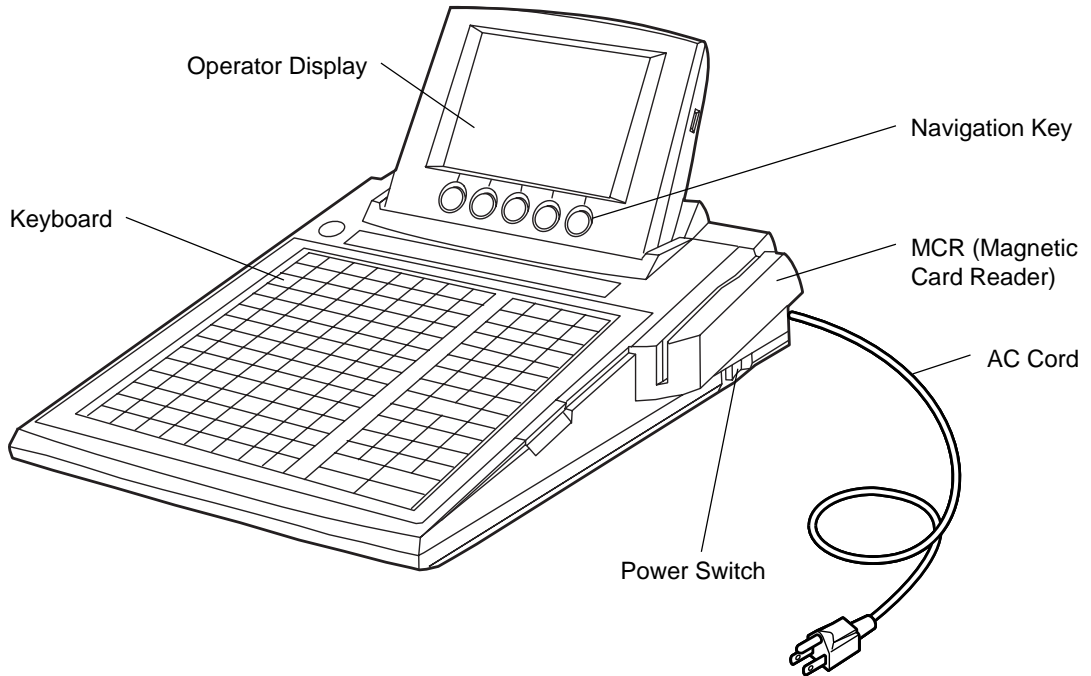

- Power Switch Insure that the power switch is in the OFF position before connecting AC power.

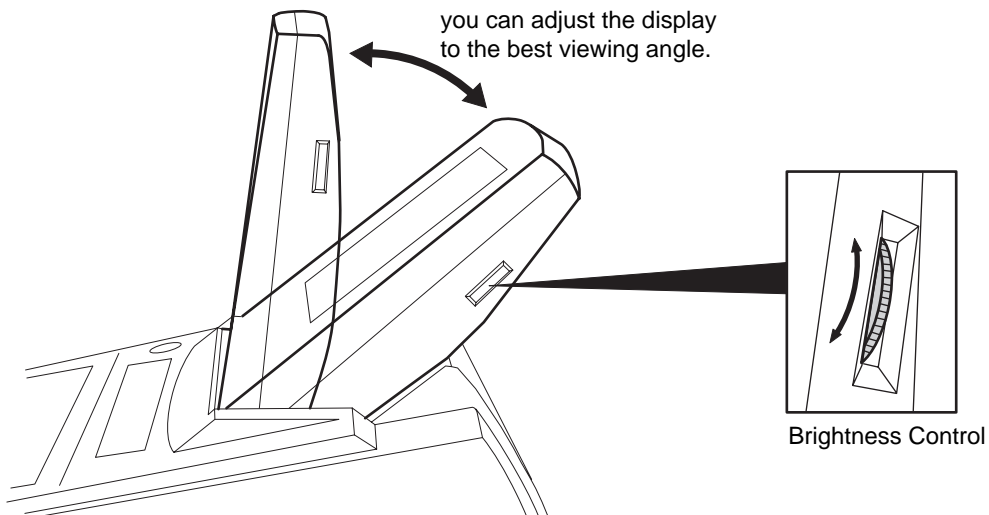

CAUTION!

1. Do not try to force the display beyond its full opened position.
2. Do not press on or put any pressure on the MCR unit as it may be easily broken.

3.2 Rear View

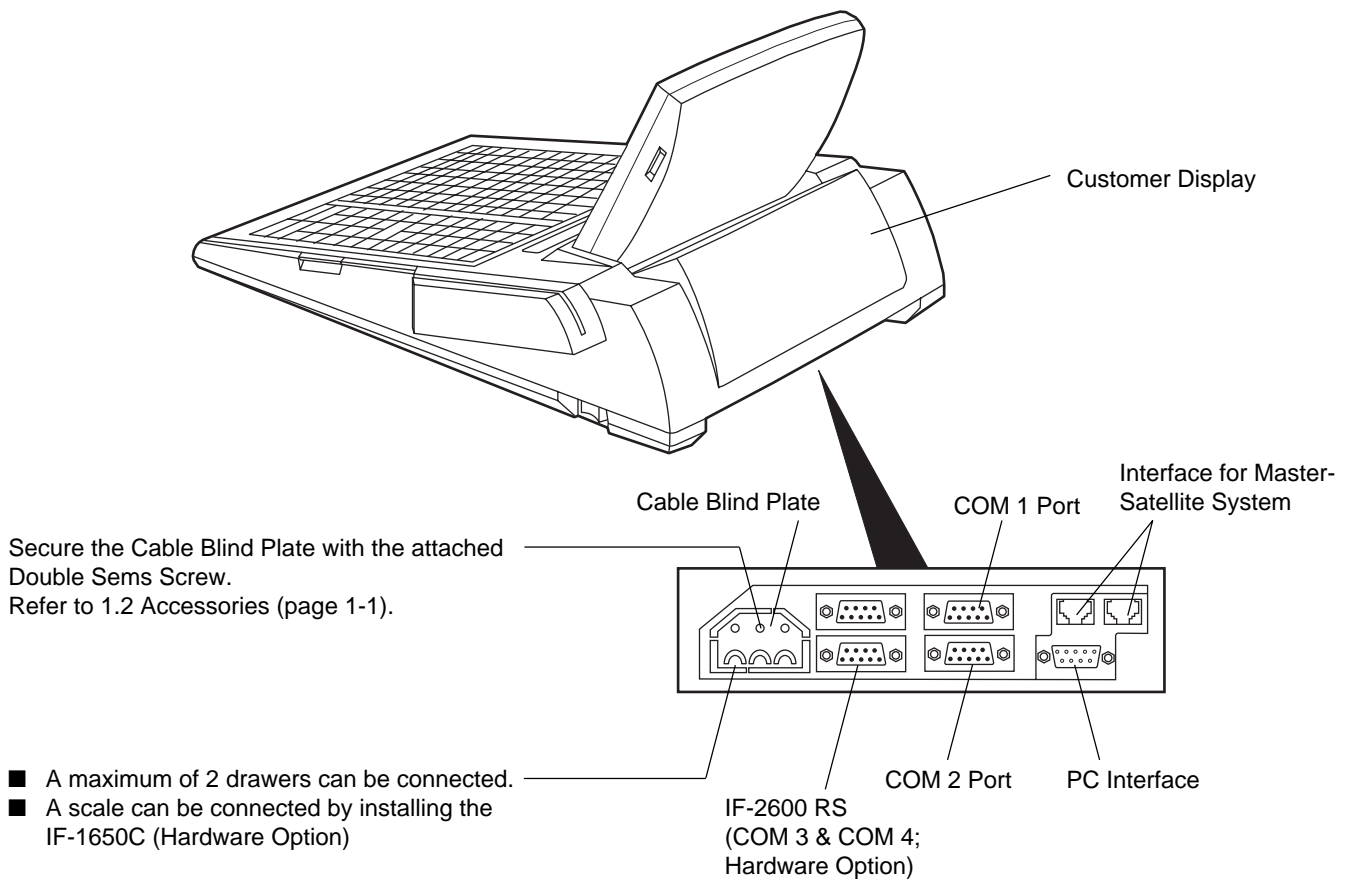

- A maximum of 2 drawers can be connected.
- A scale can be connected by installing the IF-1650C (Hardware Option)
- The following printers can be connected to each port (COM 1 to COM 3; COM 4 is for future use).
 - BRST-10 (Used for Receipt)
 - TM-300 (Used for Receipt, Journal, RKP; Remote Kitchen Printer)
 - TM-T88 (Used for Receipt, RKP; Remote Kitchen Printer)

4. MODE LOCK AND MODE SELECTOR KEYS

4.1 Mode Lock

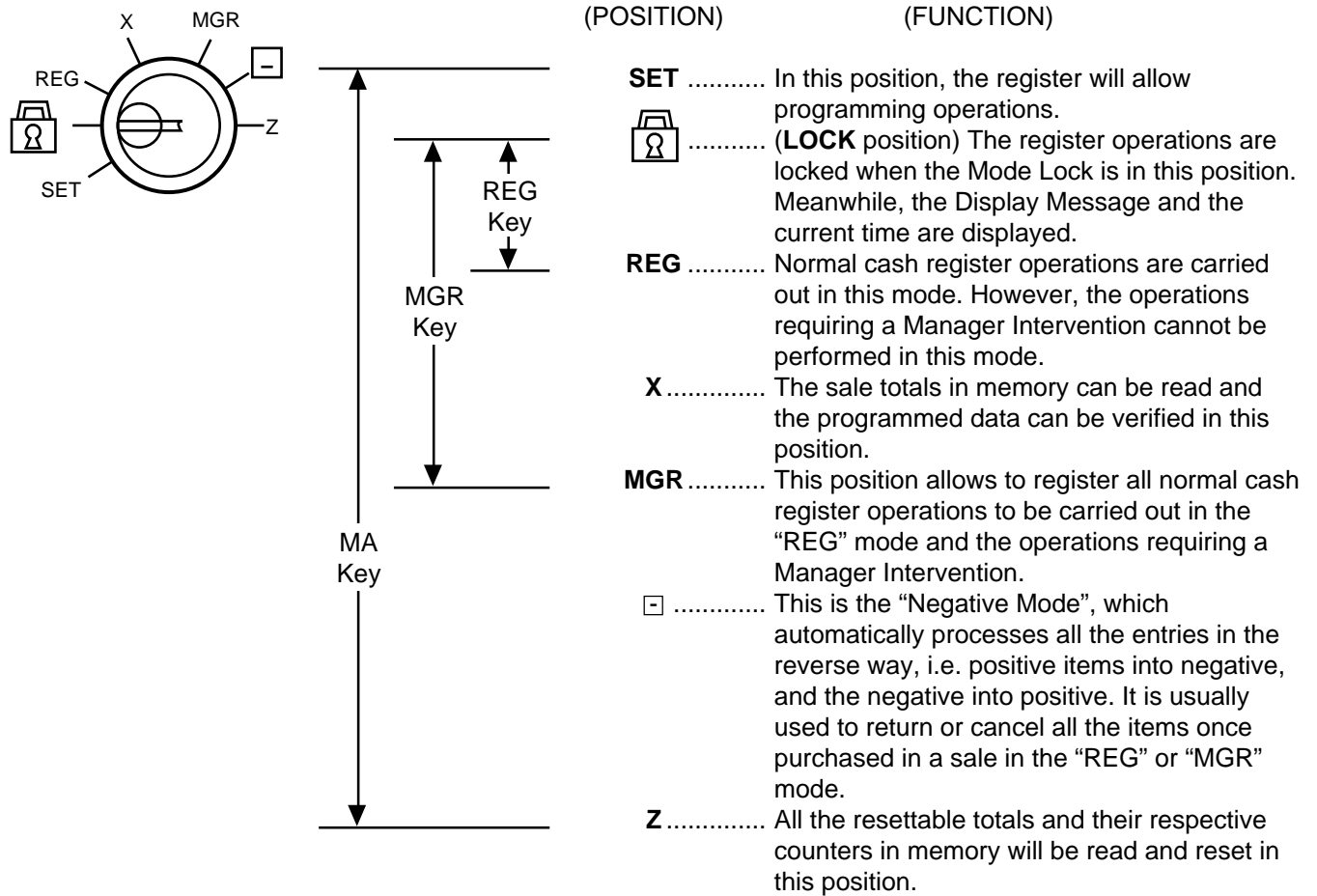

4.2 Mode Selector Keys

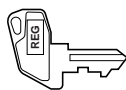

REG Key: The REG Key is used by the cashier or clerk who operates the register.

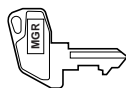

MGR Key: The MGR Key is used by the store manager or a person authorized by the manager.

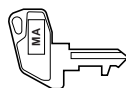

MA Key: The MA Key is used by the store manager who will daily supervise the collection of money and the printout of transactions recorded by the register. This key is also used when programming the register.

The keys may be inserted or pulled out at the "LOCK" or "REG" position.

In the OPERATOR'S GUIDE, functions and operations will be described within the range of the Mode Lock positions of **LOCK** and **REG** using the REG key. Since operations requiring other positions and keys are controlled by the store manager, they are described in the MANAGER'S GUIDE.

5. DISPLAY

The FS-2600 is provided with the LCD operator display and the 7-segment customer display.

5.1 Operator Display

5.1.1 Basic Screen (common to all the mode lock positions)

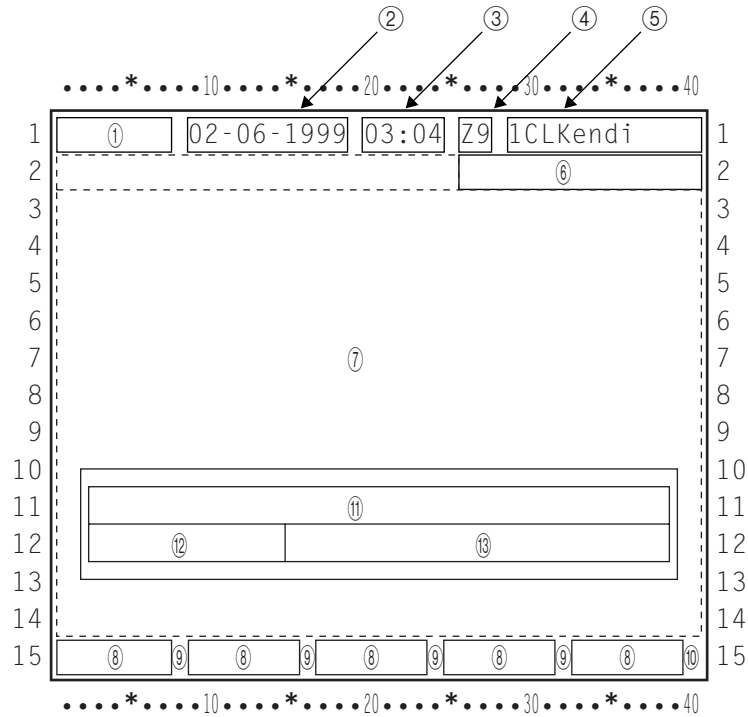

■ Description of each Display Item

Display Item	Display Line	Description
① Mode Lock Position	1	Displays the current mode lock position. (7 digits) SET: * SET * ☒: * REG * REG: * REG * X: *X/GTX* MGR: *REG * ☐: *REG- * Z: *Z/GTZ* BLIND: * SET *
② Date	1	Displays the date. (10 digits)
③ Time	1	Displays the time. (5 digits)
④ Cashier Code	1	Displays the cashier code. (2 digits)
⑤ Cashier Name	1	Displays the cashier name. (12 characters)
⑥ Terminal Status Indicator	2	Displays the indicator which shows the terminal status. For details, refer to the next section "Description of each Indicator".
⑦ Display Area for each Mode Position	2 ~ 14	Refer to the display configuration for each mode position.
⑧ Navigation Key	15	For details, refer to "Description of each Navigation Key" attached to the display configuration for each mode position.

■ Description of each Display Item (continued)

Display Item	Display Line	Description
⑨ Printer Error Indicator	15	Displays the error indicator "X" to indicate that an error status has occurred on the printer which is connected to the terminal. From the left; Port 1, Port 2 and Port 3. The rightmost one will be used for the future.
⑩ Print Data Reception Indicator	15	Displays the indicator "★" while the print data is being received from another terminal.
⑪ Sales Item Name Guidance Message	11	Displays a sales item which has been just entered with a double-width sized character. (16 double-width sized characters) Also, displays an operation guidance message. (Max. 36 characters)
⑫ Quantity	12	Displays a quantity with a double-width sized numeral. (max. 3-digit integral portion and 2-digit decimal portion)
⑬ Numeric Sales Total	12	Displays a numeric value entered and a sales total with a double-width sized numeral.

5.1.2 Description of each Indicator

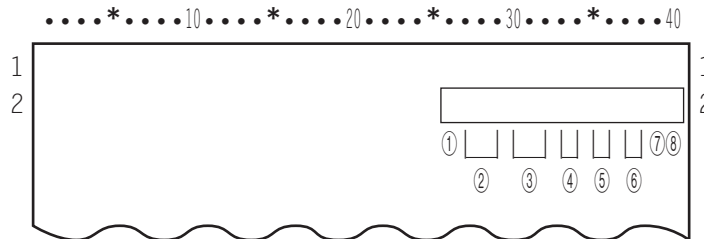

■ Description of each Display Item

Display Item	Description
① For Future Use	For Future Use (1 digit)
② Receipt ON/OFF Indicator	Displays OFF while the receipt-issue mode is in "OFF". (3 digits)
③ RTR (Register-to-Register) Indicator	Displays RTR while the RTR declaration is in ON. (3 digits)
④ Price Level Indicator	Displays the PLU price level currently selected. (2 digits) <ul style="list-style-type: none"> • PRICE 1 (1st PRICE): P1 • PRICE 2 (2nd PRICE): P2 • PRICE 3 (3rd PRICE): P3 • PRICE 4 (4th PRICE): P4 • PRICE 5 (5th PRICE): P5
⑤ Menu Shift Level Indicator	Displays the PLU menu shift level currently selected. (2 digits) <ul style="list-style-type: none"> • MENU SHIFT 1: S1 • MENU SHIFT 2: S2 • MENU SHIFT 3: S3 • MENU SHIFT 4: S4 • MENU SHIFT 5: S5
⑥ Caps Lock and Double-width Designation	Displays the following during the programming operation including the character entries. (2 digits) <ul style="list-style-type: none"> Small Letter/Normal Size: a Capital Letter/Normal Size: A Small Letter/Double-width Size: a Capital Letter/Double-width Size: A

■ Description of each Display Item *(continued)*

Display Item	Description
⑦ Previous Screen	Displays the indicator "↑" when the menu has previous screens. (1 digit)
⑧ Continuation Screen	Displays the indicator "↓" when the menu has continuation screens. (1 digit)

5.2 Customer Display

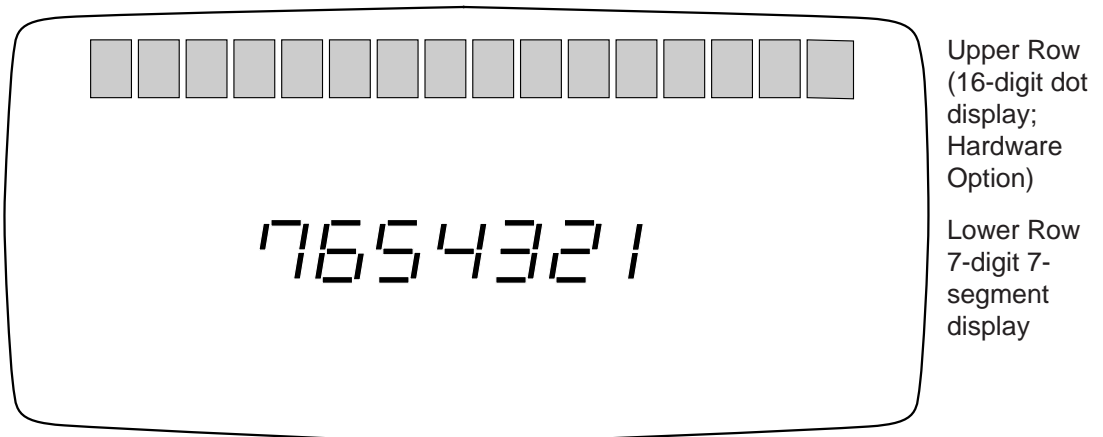

6. KEYBOARD

The following is the standard keyboard layout, which was initially set at the factory. This register is designed to be capable of programming most of the keys at the desired locations or adding keys. For details of the keyboard layout change, ask your TOSHIBA TEC representative.

6.1 Keyboard Layout

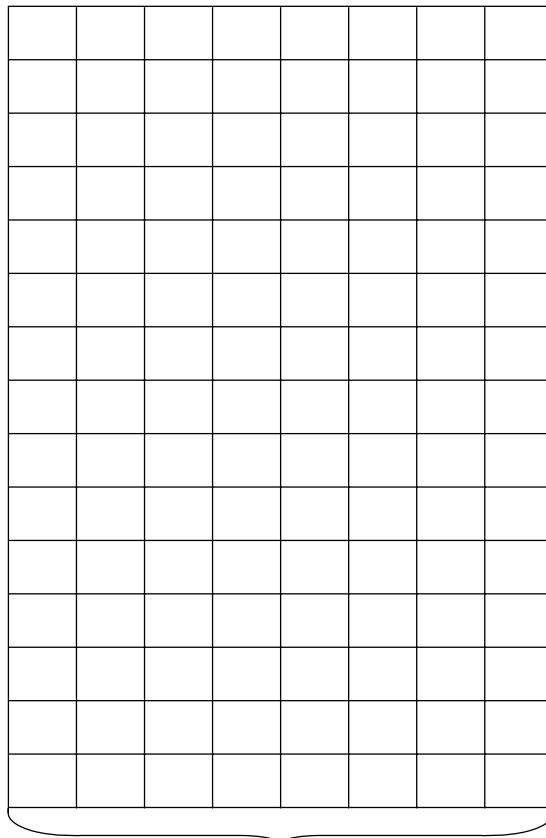

PLU Preset-code Keys

VOID	RECEIPT ISSUE	R/A	PO
BREAK IN	BREAK OUT	IN	OUT
TX1/M	TX2/M	TAKE OUT	EAT IN
SERVER TRANS.	CHG TIP	TIP PAID	POSITION #
CHECK MERGE	CHECK TRANS.	SPLIT CHECK	PRINT CHECK
ESC	↑	ENTER	NEXT
←	↓	→	PAGE UP
ALL VOID	ITEM CORR	OPEN	PAGE DOWN
#	C		NS
START CHECK	7	8	9
X	4	5	6
SERVER #	1	2	3
PLU	0	00	.
RECALL		ST	
TOTAL		AT/TL	

Other Optional Key:

[000] (Triple-zero Key)
 [CHECK]
 [Chg]
 [MISC]
 [CPN]
 [CREDIT 1] to [CREDIT 5]
 [%+] (%1)
 [%-] (%2)
 [DISC]
 [PR OPEN]
 [LC OPEN]
 [TAX]
 [TX3/M], [TX4/M]
 [EX]
 [SI1/M], [SI1/TL]
 [SI2/M], [SI2/TL]
 [RPT]
 [STOCK]

[AMT]
 [SCALE]
 [TARE]
 [SERVER #/RECEIPT]
 [CUR 1] to [CUR 5]
 [TRAY TL]
 [RECEIPT]
 [CLK 1] to [CLK 8]
 [CARD NO.]
 [READ]
 [RKP Msg 1] to [RKP Msg 10]
 [INVERT]
 [MANUAL TARE]
 [RKP Msg #]
 [FUNCTION 1] to [FUNCTION 20]
 [GUEST #]
 [MENU 1] to [MENU 5]
 [RECEIPT CUT]

[PRICE 1] to [PRICE 5]
 [PUB MODE]
 [END]
 [RECEIPT PRINT]
 [PICKUP BAL]
 [CODE OPEN]
 [DISPLAY]
 [CODE SHIFT 1] to
 [CODE SHIFT 5]
 [RKP]
 [TENDER UP]
 [COMBO]
 [SELECT]
 [HOME]
 [LCD OFF]
 Additional [%-] Keys (%3 to %8)
 [RTR] (for Master-Satellite System)

6.2 Functions of Each Key

KEY	FUNCTIONS	REFERENCE PAGE
	Percent Discount key. Used to subtract a percent rate from a sale.	9-25
	Item Correct key. Used to delete the last item from the bill.	9-14
	Void key. Used to delete an item entered previously (before the last item) in the current transaction.	9-14
	All Void key. Used to cancel all the items entered in the current sale.	9-15
	Received-on-Account key. Used to enter payments received on account, i. e. not relating to a sale. Also used for change reserve amounts loaned from the store.	9-3 9-27
	Paid-Out key. Used to record amounts paid out of the cash drawer not relating to a sale. Also used for Pick Up operations, such as money collections for banking purposes.	9-28
	Subtotal key. Used to obtain the subtotal of the current transaction.	9-12
	Cash Amount Tendered/Cash Total key. Used to record all cash paid transactions, and will be able to finalize a sale operation.	9-20
	Check key. This is one of the non-cash media keys, and used to cash a check when the register is outside a sale, or to finalize the transaction as a check payment.	9-20
	Charge key. This is another non-cash media key, and usually programmed as "Charge Sale Total" key. This key can also be used for payments in credit cards, if the [CARD NO.] key is installed.	9-20
	Media-Coupon key. This is another non-cash media key, and usually programmed as "Coupon Tender" key.	9-20
	Miscellaneous Media Key. This is one of additional non-cash media keys that may be installed besides [CHECK] and [Chg]. This key has the same functions and programmabilities as the [CHECK] key, and usually used as Tender-only key.	9-20
	Credit 1 to Credit 5 keys. These are additional non-cash media keys that may be installed besides those already described, according to the requirements of each store.	9-20
	Card No. key. Used to enter the code number (1 to 12) which classifies the credit card company followed by the sale finalization with the [Chg] key.	9-20
	SI (Selective Itemizer) Total key. Used to display (and print) the selective itemizer contents.	9-23

KEY	FUNCTIONS	REFERENCE PAGE
	Server # key. Used in case of Server/Cashier Code Entry Method, to declare start or end of normal operation by cashier.	8-1
	Receipt key. Used to change the receipt-ON/OFF mode.	9-2
	Server #/Receipt key. This is a dual-function key that has both [SERVER #] and [RECEIPT] functions.	See pages for [SERVER #] and [RECEIPT]
	Receipt Post-issue key. Used to issue the receipt of a sale when the sale has already been finalized in the Receipt-OFF mode.	9-32
	Numeric keys. Used to enter numeric values. Depressing the [00] key once is the same as depressing the [0] key twice consecutively. Depressing the [000] key once is the same as depressing the [0] key three times consecutively. The [.] key is used to designate the decimal point of a percentage rate or a quantity.	-----
	PLU (Price-Look-Up) key. Used to enter a PLU that is linked to a department.	9-5
	Clear key. Used to clear numeric entries or a declaration key entry.	-----
	Non-add Number Print. Used to print a non-adding number on the receipt and journal for future reference.	9-26
	No-sale key. Used to open the cash drawer without relating to a sale.	9-2 9-4
	Amount key. Used to enter a manual amount of PLU item.	9-5
	Preset Open key. Used to release a preset-price PLU item for a manual price entry.	9-5
	Listing Capacity Open key. Used to release the high or low amount limit preprogrammed on each PLU.	9-23
	Preset and Listing Capacity Open key. This is a dual-function key that has both [PR OPEN] and [LC OPEN] functions.	See pages for [PR OPEN] and [LC OPEN].
	Quantity Extension (Multiplication) key. Used to multiply a PLU item entry by a quantity.	9-7
	Dollar Discount key. Used to subtract an amount from the sale such as a discount during a sale.	9-25
	Percent Charge key. Used to add a percent rate to a sale.	9-25

KEY	FUNCTIONS	REFERENCE PAGE
	Number-of-Guests Key. Used to enter the number of guests in a party.	9-26
	Position Table No. Key. Used to enter a table position # of a guest party.	9-17
	Price Shift Key. Used to shift the PLU price.	9-10
	Pub Mode Key. Used to temporarily release the Order Table No. entry compulsion.	9-18
	End Key. Used to end the Modifier Entry and the Open Set Menu Entry.	9-8 9-9
	Guest Check Split Key. Used to split a guest order table account.	9-19
	Guest Check Merge Key. Used to merge two order tables accounts into one.	9-18
	Guest Check Transfer Key. Used to change an order table in use into another table at a guest's request.	9-18
	Server Transfer Key. Used to transfer an order table account to another server/cashier.	9-33
	PLU Price-Read Key. Used to read the preset price of the designated PLU from the memory.	9-24
	Takeout key. Used to declare a takeout entry.	9-13
	Eat-in key. Used to declare an eat-in entry.	9-13
	IN/OUT key. Used to record a cashier clock-in/-out.	9-34 9-35
	Break-in/Break-out Key. Used to record a cashier break-in/-out.	9-34 9-35
	Manual Tax Key. Used to enter an irregular tax amount that cannot be calculated on the basis of the programmed tax table.	9-22
	Scale Key. Used to enter a scaled item.	9-11
	Tare Key. Used to enter the preset tare weight data before a scaled item is entered.	9-12
	Manual Tare Key. Used to manually enter the tare weight data before a scaled item is entered.	9-12
	Pickup Balance Key. Used for the customer check track entry.	9-20
	Customer File Code Open Key. Used for the customer check track entry.	9-20
	Charge Tip Key. Used to enter a charge tip amount.	9-27

KEY	FUNCTIONS	REFERENCE PAGE
	SI (Selective Itemizer) Modifier key. Used to reverse the SI (Selective Itemizer) status programmed on each PLU.	9-23
	Tax Modifier key(s). Used to reverse the taxable/non-taxable status on PLUs, or other tax-status programmable keys.	9-22
	Tax Exempt key. Used to declare the exemption of the taxes from the sale.	9-23
	Repeat key. Used to repeat a PLU item entry.	9-7
	Foreign Currency keys. Used in tendering or exchange with foreign currencies.	9-4 9-21
	Stock key. Used to control stock quantity of the PLU with the stock-process status. Also used to read the remaining stock quantity of the designated PLU from the memory.	9-24
	Cashier 1 to Cashier 8 keys. Used to declare start or end of normal operation by cashier (instead of using [SERVER #] or [SERVER #/RECEIPT]) key).	8-2
	Function 1 to Function 20 keys. Used to execute a command of key string preprogrammed on each of these keys. An operation series of maximum 10 keys can be programmed on each key, thus eliminating time in daily operation routines.	9-26
	Print Mode Invert Key. Used to temporarily change from the Single/Double Print Mode to the Itemized Print Mode.	9-28
	RKP Receipt Cut Key. Used to cut an itemized RKP receipt.	9-29
	RKP Message Print key. Used to print the respective programmed messages on an RKP receipt.	9-30
	RKP Message Print Key. Used to print the respective programmed messages on an RKP receipt.	9-30
	Total Key. Used to finalize the order item entries and transfer the total amount to the new balance.	9-15
	Receipt Print Key. Used to print the guest check contents on the receipt roll paper instead of a slip.	9-31
	Print Check Key. Used to issue a presentation.	9-31
	Order Table # Key. Used to enter an Order Table No. of a guest party.	9-15
	Menu Shift Key. Used to designate the keyboard No. for [PLU Preset-code key] located on the keyboard.	2-2 (MG)
	Tray Total Key. Used to obtain the total of an individual guest tray in a guest party.	9-13

KEY	FUNCTIONS	REFERENCE PAGE
TIP PAID	Tip Paid Key. Used to enter a cash tip amount.	9-27
RECALL	Recall Key. Used to recall the order table.	9-16
DISPLAY	Display Key. Used to display the menu table.	9-6
CODE SHIFT 1 to CODE SHIFT 5	PLU Code Shift Key. Used to shift the PLU code.	9-10
RKP	RKP Key. Used to temporarily change the RKP connection.	2-3 (MG)
TENDER UP	Tender Up Key. This is the speed tender key.	9-20
COMBO	Combo Key. Used for the combo entry.	9-11
LCD OFF	LCD Off Key. Used to turn off the LCD display.	-----
RTR	RTR Key. Used for the master-satellite system.	See M/S System.
↑ ↓ ← → ESC ENTER NEXT PAGE UP PAGE DOWN SELECT	<p>Cursor (Up Arrow) Key These 10 keys are used for operations through the LCD.</p> <p>Cursor (Down Arrow) Key</p> <p>Cursor (Left Arrow) Key</p> <p>Cursor (Right Arrow) Key</p> <p>Escape Key</p> <p>Enter Key</p> <p>Next Key</p> <p>Page Up Key</p> <p>Page Down Key</p> <p>Select Key</p>	-----
PLU Preset-code Keys	Each of these keys is programmed with a PLU Code. That is, depressing one of those keys is equal to entering a PLU Code then depressing the [PLU] key.	See pages for [PLU].

7. PROCEDURE BEFORE OPERATION

1. Unpack the accessories and the cash register from the carton.
2. Place the cash register at a proper location, referring to the Safety Precautions at the beginning of the Operator's Guide.
3. Remove the tapes and seals for holding parts or protecting the cash registers surfaces.
4. Plug the power cord plug into a wall outlet.
5. Insert the **REG** key into the Control Lock, then turn it to the **REG** position.
6. Before starting actual transaction entries on the cash register, ask your manager if you need additional setting or the initial programmed data needs to be changed. For programming, refer to the following chapters in the Manager's Guide:
 5. PROGRAMMING OPERATION (page 5-1)
 6. VERIFICATION OF PROGRAMMED DATA (page 6-1)

8. CASHIER SIGNING OR CASHIER KEY OPERATIONS

The FS-2600 adopts one of the following cashier-identifying operations.

- CODE ENTRY METHOD, using the [SERVER #] key.
- CASHIER KEY METHOD, using [CLK] keys.

8.1 Code Entry Method

Each cashier will sign-ON, sign-OFF, sign-IN, and sign-OUT through the [SERVER #] key.

OPERATION: Mode Lock: REG (or, MGR or with Manager Intervention)

When you turn the Mode Lock to the REG (or MGR,), the following screen will appear on the LCD.

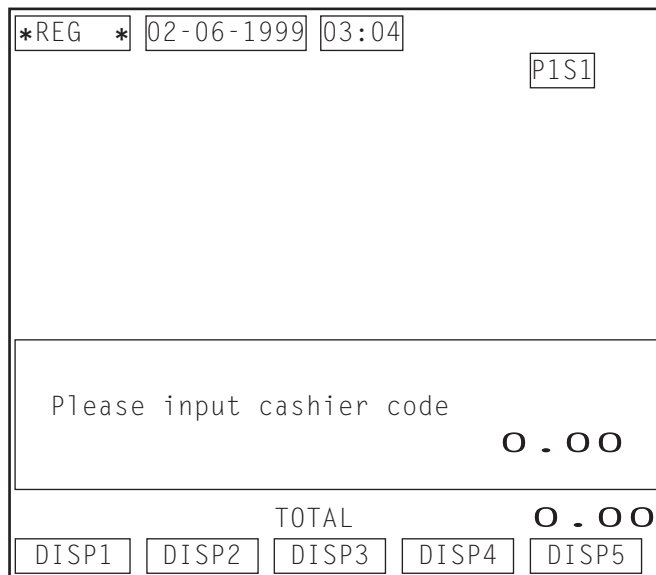

8.1.1 Single-drawer Machines

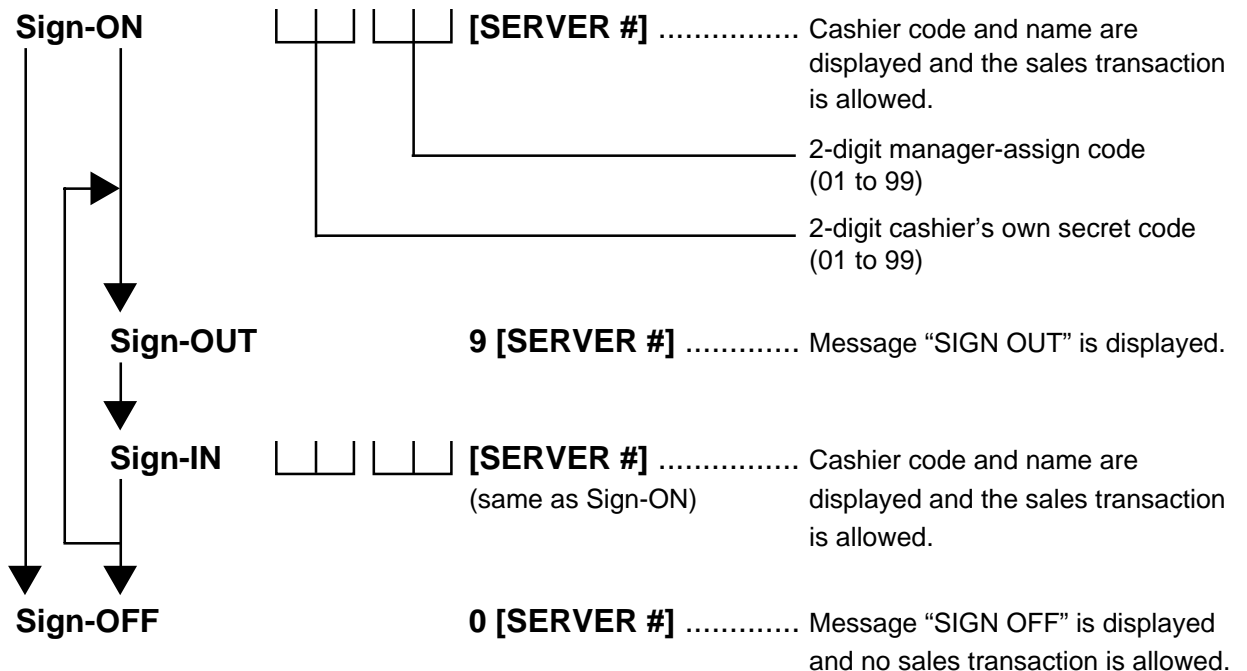

Sign-ON to be operated to start the job.
Sign-OUT to be operated to leave the register for a while expecting to come back soon.
Sign-IN to be operated when the cashier comes back from a break declared by Sign-OUT.
Sign-OFF to be operated to end the job.

8.1.2 Multi-drawer Machines

Operations are basically the same as those for Single-drawer Machines, except that a one-digit drawer No. is entered through the [X] key prior to the Sign-ON entry:

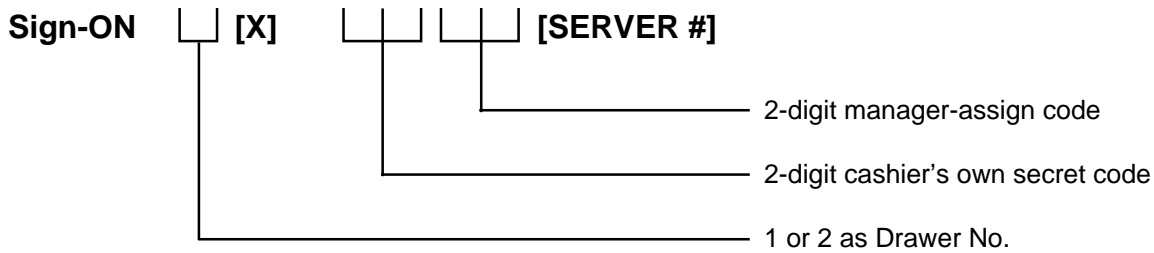

Entry of a drawer No. opens the designated drawer on finalizing the sale transaction. Designation of the drawer No. which is being used by another cashier causes an error.

Sign-OUT
Sign-IN
Sign-OFF } Same as those for Single-drawer Machines.

NOTE: When the drawer No. entry and the [X] key depression are skipped in the sign-ON, the drawer 1 will be automatically assigned to the cashier, if the drawer 1 is not being used by another cashier.

8.2 Cashier Key Method ([CLK] Keys)

When the [SERVER #] key is not installed, [CLK] keys ([CLK 1] to [CLK 8]; max. 8 keys) may be provided on the ECR keyboard. Sale entries will be possible only when one of the [CLK] keys is depressed (in "REG", "MGR", or "☐" mode). When the same [CLK] key is again depressed, the cashier is in Cashier OFF status.

NOTE: When a cashier key is set ON, the cashier name will be displayed in the LCD.

8.3 Training Mode Start and End

This section describes the training function provided for newly employed cashiers. After entering the training mode, a cashier may operate the same transaction entries as those in the REG mode. The data in the Training Mode is processed into the training cashier memory, therefore it will not affect any actual sales data in business.

CONDITION Outside a sale, and in Cashier Signed-OFF condition for CASHIER CODE ENTRY Method

8.3.1 Operation for Training Modes Start

■ Code Entry Method

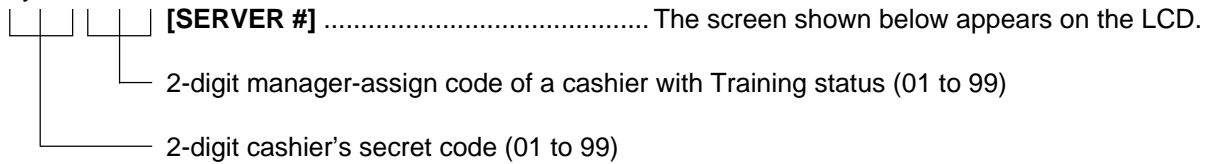

■ Cashier Key Method

Set the Cashier Key programmed with Training status.

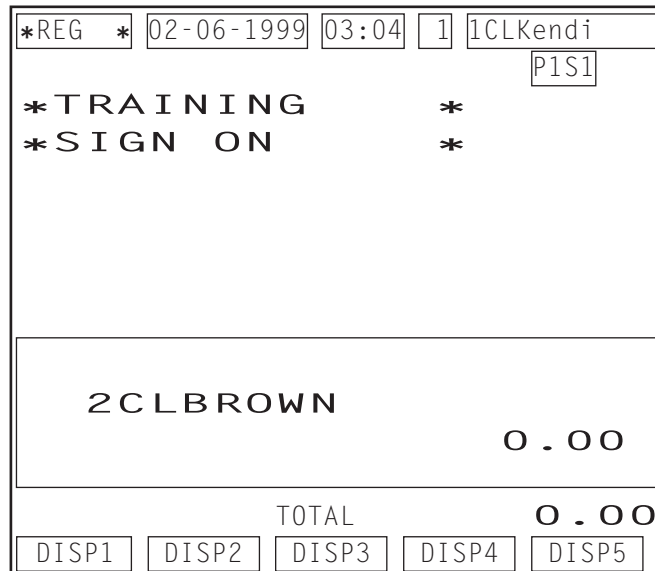

8.3.2 Entries in Training Mode

A trainee can operate all the transaction entries described in the next chapter.

- except:
- 1) The drawer will not open.
 - 2) The Consecutive No. on the receipt will not be incremented.
 - 3) Training symbol is printed on the receipt and the guest check.
 - 4) Sales items entered in the Training Mode will not be printed on the journal.
 - 5) If the remote kitchen printer is connected, the sales items entered in the Training Mode will be printed on it with the training symbol.

8.3.3 Operation for Training Mode End

■ Code Entry Method

0 → [SERVER #]

■ Cashier Key Method

Change the current Cashier Key to another.

8.4 "Cashier Exclusive" Option

When the program option "Cashier Not exclusive" is selected:

Every Cashier can access the other cashiers' guest order table accounts as well as his/her own.

When the program option "Cashier Exclusive" is selected:

Cashiers with the status "Own Tables only"

The Cashier can only access the guest order tables from which he/she first takes orders or has reserved. An error results on attempting to access the other cashiers' tables.

Cashiers with the status "All Tables"

The Cashier can access any order table besides those he/she reserves or takes orders from. In this case, the same is applied to the cashier as described for the program option "Cashier Not exclusive" selection above.

NOTE: *When the program option "Cashier Exclusive" is selected, even a cashier with the status "All Tables" cannot handle the order table which a cashier with Training status has opened.*

9. TRANSACTION ENTRIES

WARNING!

When opening the cash drawer, be careful not to let the drawer hit any person.

■ Condition Necessary to Start Transaction Entries

Mode Lock: Insert the “REG” key and set it to the “REG” position.

Cashier Sign-ON: If the [SERVER #] key is used for identifying a cashier, you must sign-ON or sign-IN. (See Section 8.1)
 If Cashier Keys are installed, you must set your cashier key to the ON status. (See Section 8.2)

■ Description of each Navigation Key (REG, MGR, □)

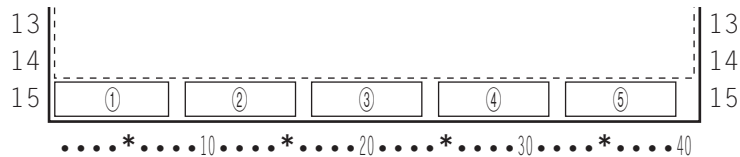

1) Except the case 2) below

Display Item	Description
① Navigation Key 1	DISP1
② Navigation Key 2	DISP2
③ Navigation Key 3	DISP3
④ Navigation Key 4	DISP4
⑤ Navigation Key 5	DISP5

2) While the menu window is displayed

Display Item	Description
① Navigation Key 1	↓
② Navigation Key 2	↑
③ Navigation Key 3	Select
④ Navigation Key 4	Enter
⑤ Navigation Key 5	Pg dw

9.1 Receipt-Issue/Non-issue Selection

This operation determines whether or not the receipt is issued.

Mode Lock may be in any position: Pressing the **[SERVER #/RECEIPT]** key without a prior numeric entry or pressing the **[RECEIPT]** key (whichever key is installed on the keyboard) will change the receipt ON/OFF status. Each time the key is pressed the receipt ON/OFF status is changed.

- NOTES:**
1. The "R OFF" status at the starting of a transaction entry decides whether a receipt will be issued for the transaction or not. Switching the Receipt ON/OFF status during a transaction will not be effective.
 2. If a transaction entered with the "R OFF" status and finalized but a receipt is required, the **[RECEIPT ISSUE]** (Post-issue Receipt) key can be operated to issue a receipt.

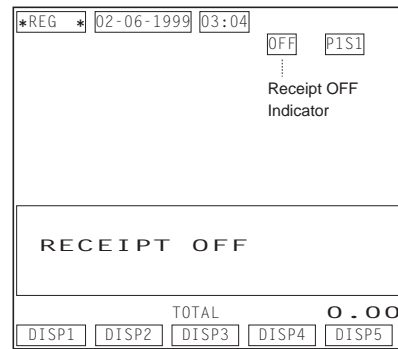

9.2 Store Message Display

This operation designates and displays one of the 4 messages programmed to be displayed in the REG or MGR mode when the register is outside a sale. The message is displayed on the operator display and the dot display area in the customer display.

OPERATION (must be operated outside a sale)

Display Message Code **[NS]**

1 to 4
(corresponding to Line No.
1 to 4 in programming)

NOTE: This operation is effective when the program options "Display Message Method 16 CHARACTERS HELD" and "Display Message DISPLAY in REG and MGR mode (as well as in LOCK mode)" are both selected.

9.3 No-sale

The no-sale transaction is used to open the cash drawer without affecting any sales, such as for giving change, testing the receipt/journal print condition, etc.

OPERATION (must be operated outside a sale)

[NS]..... The drawer opens and a No-sale receipt is issued.

-- Receipt Print Format --

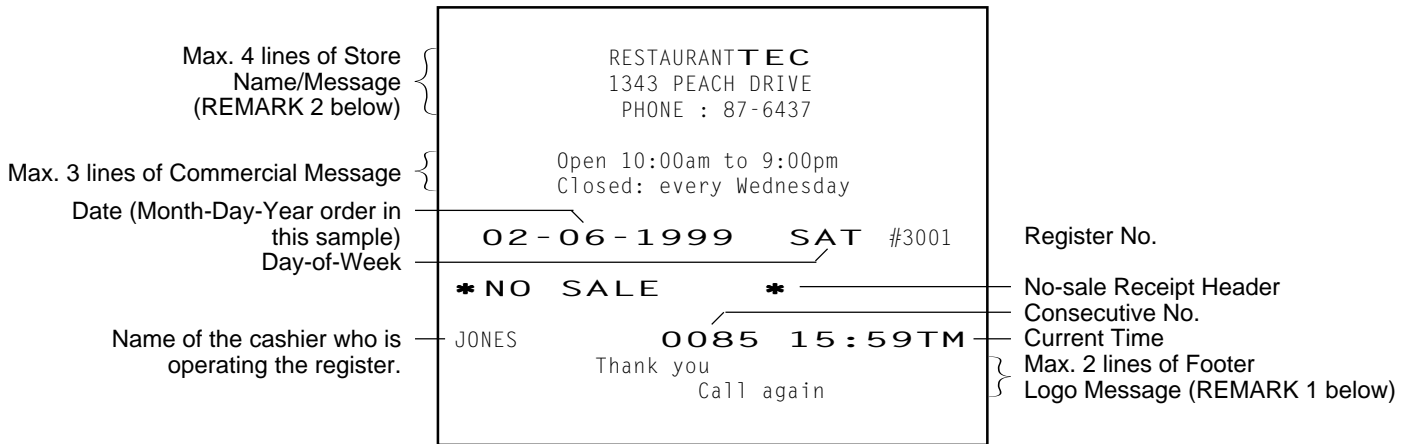

- NOTES:**
1. A no-sale transaction after a non-add number print can be prohibited by the program option.
 2. A no-sale transaction after an Order Table No. entry is not possible.

- REMARKS:**
1. When the program option "Footer Logo Message Print" is selected, a maximum of 2-line Footer Logo Message will be additionally printed on the receipt issued for the sales transaction without the Order Table No. entry.
 2. If your printer is the BRST-10 or the TM-T88, you can make and print your own logo on the Store Name/Message area.

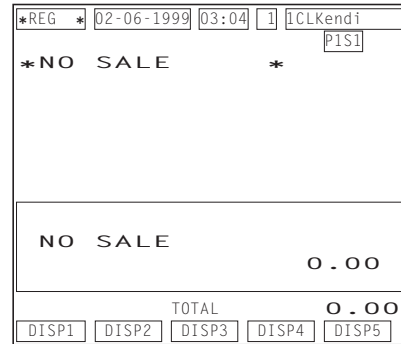

9.4 Loan

This operation is used to record the cash amounts loaned from the store as the change reserve in the drawer.

OPERATION

(must be operated outside a sale)

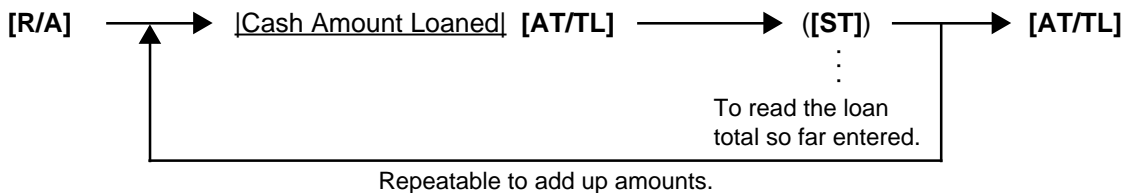

NOTE: A loan transaction after an Order Table No. entry is not possible.

*REG *	02-06-1999	03:04	1	[CLKendi]
				[PIS1]
*START	BANK	*		
CASH				20.00
CASH				30.00
CASH				50.00
TOTAL				100.00
TOTAL				100.00
TOTAL				100.00
[DISP1]	[DISP2]	[DISP3]	[DISP4]	[DISP5]

9.5 Check Cashing (No-sale cashing of a non-cash media)

OPERATION (must be operated outside a sale)

[Check Amount to be Cashed] [CHECK] → [NS] The drawer opens to enable the exchange.
 Max. 8 digits 1 to 99999999

- NOTES:**
1. Other non-cash media keys may be used for this purpose if programmed to allow no-purchase cashing.
 2. A check cashing transaction after an Order Table No. entry is not possible.

9.6 No-sale Exchange from Foreign Currency to Domestic Currency

OPERATION (must be operated outside a sale)

[CUR1] → [Amount of Foreign Currency 1 to be exchanged] [NS]
 Max. 8 digits 1 to 99999999

- NOTES:**
1. The [CUR 2] to [CUR 5] keys operate in the same way.
 2. The fraction process method is fixed to Round OFF.

*REG *	02-06-1999	03:04	1	[CLKendi]
				[PIS1]
CUR1				20.00
0.365*				
CHANGE				7.30
CHANGE				7.30
TOTAL				0.00
[DISP1]	[DISP2]	[DISP3]	[DISP4]	[DISP5]

9.7 No-sale Exchange from Domestic Currency to Foreign Currency

OPERATION (must be operated outside a sale)

[Amount of Domestic Currency to be exchanged] **[CUR 1]** → **[NS]**

- NOTES:**
1. The **[CUR 2]** to **[CUR 5]** keys operate in the same way.
 2. A program option allows you to prohibit the No-sale Exchange from domestic currency to foreign currency.
 3. The fraction process method is fixed to Round OFF.

*REG *	02-06-1999	03:04	1	[CLKendi]
				[P1S1]
CATEND				20.00
	1.214*			
CUR2				16.47
CUR2				16.47
TOTAL				0.00
DISP1	DISP2	DISP3	DISP4	DISP5

9.8 PLU (menu item) Entry through the Keyboard

Each PLU is preprogrammed as the "PRESET" type (with a price preset) or "OPEN" type (with no price preset). Perform the operation depending on the type selected.

OPERATION

■ *Open PLU Type*

- [Open-PLU Code] **[PLU]** [Price] **[AMT]**

Max. 7 digits
1 to 9999999

- [Price] **[PLU Preset-Code Key]** of Preset-PLU

Max. 7 digits
1 to 9999999

■ *Preset PLU Type*

- [Preset-PLU Code] **[PLU]**

- **[PLU Preset-Code Key]** of Preset-PLU

■ *Preset-price Open Entry through Preset PLU Type*

- **[PR OPEN]** (or **[OPEN]**) [Preset-PLU Code] **[PLU]** [Price] **[AMT]**

Max. 7 digits
1 to 9999999

- **[PR OPEN]** (or **[OPEN]**) [Price] **[PLU Preset-Code Key]**

Max. 7 digits
1 to 9999999

*REG *	02-06-1999	03:04	1	[CLKendi]
				[P1S1]
1	PLU000001			1.00T
PLU000001				1.00
1 TOTAL				1.15
DISP1	DISP2	DISP3	DISP4	DISP5

T: Taxable Symbol

9.9 PLU (menu item) Entry through the Menu Window

This register allows you to select and enter a PLU (menu item) through the Menu Window.

OPERATION

- Through the **[DISPLAY]** key
[DISPLAY] Displays the corresponding menu table window as follows.
([DISPLAY 1] to [DISPLAY 99])

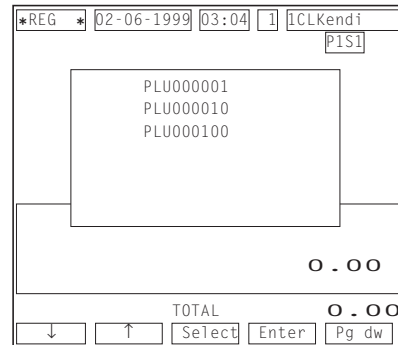

- Through the **[PLU]** key with the menu table programmed
[PLU] Displays the corresponding menu table window as follows.

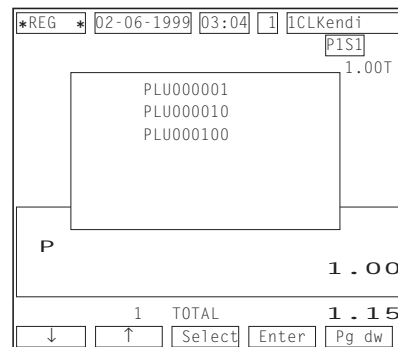

Function Keys while the Menu Window is displayed

- [↑] [↓]:** Cursor
- [SELECT]:** PLU (menu item) Selection
- [Quantity] [SELECT] ([ENTER]):** Quantity Selection
- [NEXT]:** Screen Skip or Next Screen Request
- [ENTER]:** PLU (menu item) Selection and Entry

Operation Example 1) You select and enter the following item from the menu window shown above.
 PLU 000001 (1 item)

[DISPLAY 1] → ([SELECT]) → [ENTER]

Operation Example 2) You select and enter the following items from the menu window shown above.
 PLU 000010 (1 item), PLU 000100 (3 items)

[DISPLAY 1] → [↓] → ([SELECT]) → [ENTER] → [↓] → [3] → [SELECT] → [ENTER]
 Press once. Press twice.

- NOTES:**
1. While the menu window is displayed, operate as follows to cancel a PLU (menu item) already selected by the **[SELECT]** key.
[0] → **[SELECT]**
 2. While the menu window is displayed, you cannot perform the following sales transactions.
 - Subtotal Read
 - Void
 - Dollar Discount, % Operations

9.10 Repeat Entry

To repeat the same item of the last entry, simply depress the last key of the PLU entry sequence or depress the **[RPT]** key.

OPERATION

■ **Open PLU Type**

- **[Open-PLU Code] [PLU] [Price] [AMT] [AMT] (or [RPT])**
Max. 7 digits
1 to 9999999

- **[Price] [PLU Preset-Code Key] [Same key] (or [RPT])**
Max. 7 digits
1 to 9999999

■ **Preset PLU Type**

- **[Preset-PLU Code] [PLU] [PLU] (or [RPT])**

- **[PLU Preset-Code Key] [Same key] (or [RPT])**

■ **Preset-price Open Repeat**

- **[PR OPEN] (or [OPEN]) [Preset-PLU Code] [PLU] [Price] [AMT] [RPT]**
Max. 7 digits
1 to 9999999

- **[PR OPEN] (or [OPEN]) [Price] [PLU Preset-Code Key] [RPT]**
Max. 7 digits
1 to 9999999

*REG	*	02-06-1999	03:04	1	LCLEndi
					P1S1
1		PLU000004			2.00T
1		PLU000004			2.00T
1		PLU000004			2.00T
PLU000004					
3					
2.00					
3 TOTAL 7.32					
DISP1	DISP2	DISP3	DISP4	DISP5	

- NOTES:**
1. If the first item of those repeated is modified with **[SI/M]** or **[TX/M]**, the modified status will be effective through the last item of the repeated.
 2. Please note that the **Preset-price Open Repeat** can only be performed by the **[RPT]** key.
 3. A negative PLU item cannot be repeated.

9.11 Quantity Extension (Multiplication)

OPERATION

■ **Open PLU Type**

- **[Open-PLU Code] [PLU] [Quantity] [X] [Price] [AMT]**
- **[Quantity] [X] [Price] [PLU Preset-Code Key]** of Open-PLU

■ **Preset PLU Type**

- **[Quantity] [X] [Preset-PLU Code] [PLU]**
- **[Quantity] [X] [PLU Preset-Code Key]** of Preset-PLU

■ Preset-price Open Repeat

- [PR OPEN] (or [OPEN]) |Preset-PLU Code| [PLU] |Quantity| [X] |Price| [AMT]
- |Quantity| [X] [PR OPEN] (or [OPEN]) |Price| [PLU Preset-Code Key] of Preset-PLU

- NOTES:**
1. Quantity Max. 3 integral + 3 decimal digits (Use the [.] key for entering decimal digits.)
Price (Unit Price) Max. 6 digits
Product Must not exceed 8 digits.
 2. When the Quantity is 1-digit integer (1 to 9) followed by a Code-preset PLU key with a price preset, the [X] key is omissible.
 3. The product obtained by multiplication cannot be repeated.
 4. The decimal portion of the Quantity entry itself is processed down to the two digits below the decimal point. The fraction rounding in this case is fixed to ROUND OFF.
 5. You can select the rounding process of the fractions of the product (result of multiplication) by a program option: ROUND OFF (initial setting), ROUND UP, or ROUND DOWN.

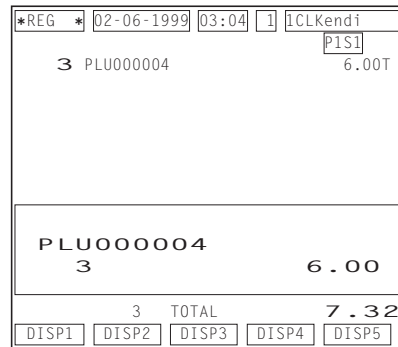

9.12 Set Menu Entry

Up to 50 set menu tables are available. You can select two kinds of the set menu table; Preset Menu Type and Open Menu Type.

OPERATION

■ Preset Menu Table Type

- One Set Menu Entry
PLU Entry of main menu → Sub menu PLUs are automatically entered.
- Quantity Extension
|Quantity| [X] → PLU Entry of main menu → Sub menu PLUs are automatically multiplied and entered.
0.001 to 999.999

■ Open Menu Table Type

- One Set Menu Entry
PLU Entry of main menu → PLU Entries of sub menus → [END]
- Quantity Extension
|Quantity| [X] → PLU Entry of main menu → PLU Entries of sub menus → [END]
0.001 to 999.999

- NOTES:**
1. Repeat Entry is not possible for the set menu items.
 2. Modifier Entry is not possible for the set menu items.
 3. Void Entry is not possible for the set menu items.
 4. As for the Preset Menu Table Type, up to seven menu items can be programmed to each table.

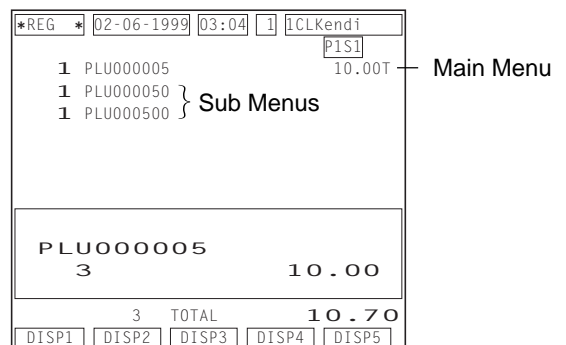

5. As for the Open Menu Table Type, if the quantity of sub menu items to be entered is programmed, the set menu entry is completed when the quantity of sub menu items reaches the programmed quantity. In this case, depressing the **[END]** key is unnecessary.
6. As for the Open Menu Table Type, Quantity Extension is available for a sub menu PLU. Even when a main menu PLU is multiplied by the Quantity Extension, sub menu PLUs will not be multiplied.

9.13 Modifier Entry

You can select and enter "MODIFIER" PLUs (such as "PEPPER", "RARE", "MEDIUM" for grilling a steak item, and toppings for dishes, etc.).

OPERATION

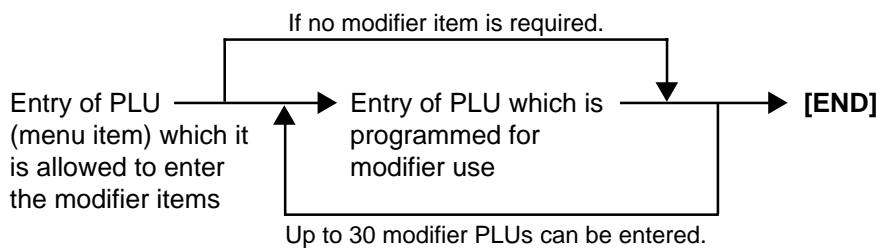

- NOTES:**
1. The **[END]** key depression is omissible in the following cases and the modifier entry is automatically finalized.
 - Ordinary PLU item is entered after a modifier PLU.
 - The **[TOTAL]** key is operated after a modifier PLU.
 - Sale finalization by the media keys is performed after a modifier PLU.
 2. Quantity Extension is available for a modifier PLU. Multiplied sales item count is displayed for a modifier PLU. When a modifier PLU with preset price programmed is multiplied by the Quantity Extension, the preset price will also be multiplied.

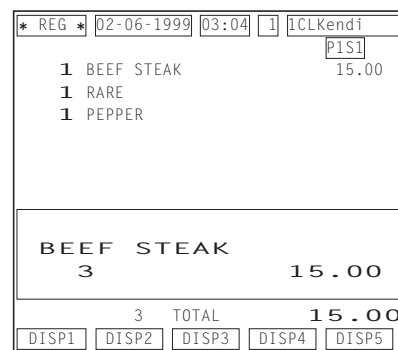
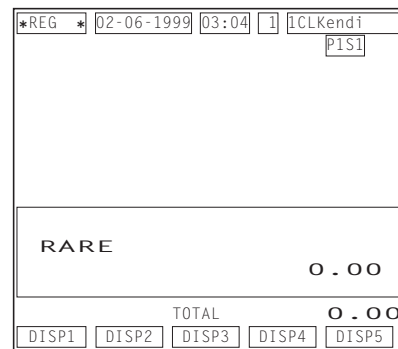

9.14 Other Income PLU Entry

This operation is used to enter items which do not directly become sales for the restaurant, such as postage, gift wrapping fee, utility (payment of electricity and gas), and donation.

OPERATION

The same key operation as "PLU (menu item) Entry". However, use the PLU which has been linked to the Other Income Department.

9.15 PLU Code Shift Entry

Depressing the **[CODE SHIFT]** key designates and enters a PLU item, adding the printed number (1 to 4) to an entered PLU code.

OPERATION

- [CODE SHIFT 1]** → PLU Entry (To enter a PLU item of the entered code plus 1)
- [CODE SHIFT 2]** → PLU Entry (To enter a PLU item of the entered code plus 2)
- [CODE SHIFT 3]** → PLU Entry (To enter a PLU item of the entered code plus 3)
- [CODE SHIFT 4]** → PLU Entry (To enter a PLU item of the entered code plus 4)

Example) When the PLU code 7 is designated after the **[CODE SHIFT 2]** is depressed, this sales transaction will result in the sales item entry of the PLU code 9.

- NOTES:**
1. Depressing the **[C]** key immediately after the **[CODE SHIFT]** key results in the cancellation of the PLU Code Shift Entry.
 2. You can depress the **[CODE SHIFT]** key any number of times before the PLU Entry. The last depressed **[CODE SHIFT]** key becomes effective.
 3. Function of the **[CODE SHIFT]** key is effective for the next PLU Entry only.

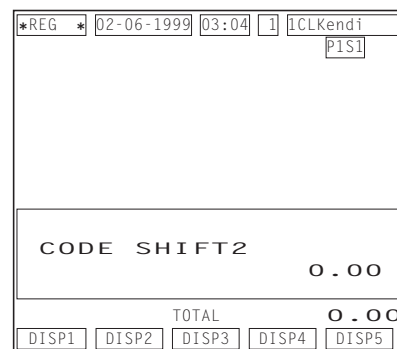

9.16 PLU Price Shift Entry

Up to five different unit prices can be programmed for each PLU and you can select either of the following two features.

9.16.1 Price Shift Entry “Effective only for One PLU Entry” Feature

OPERATION

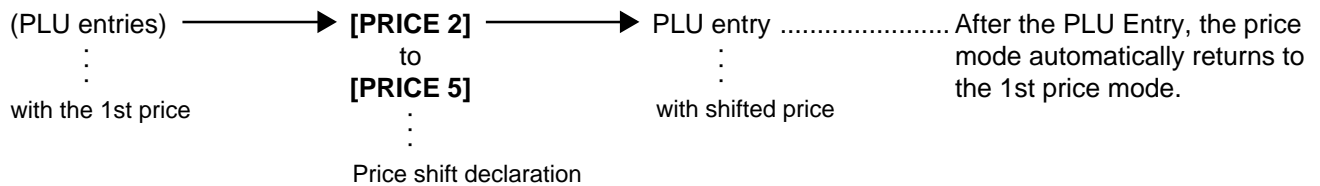

9.16.2 Price Shift Entry “Keeping the shifted Price Level” Feature

You can shift the PLU price level to another in the following three cases.

- Using the **[PRICE]** key
The same key operation as “Effective only for One PLU Entry” Feature. However, the shifted price level is held until another **[PRICE]** key is depressed.
- Using the Hourly Range Designation
Hourly range to start shifting each price level can be programmed. If programmed, the price level will be automatically shifted to another when the hourly range starts.
- Using the Price Level for each Customer
Price level can be programmed to each customer. PLU entry will be performed on the basis of the programmed information. For details, refer to the section 9.31 Charge Posting by Check Track on page 9-20.

NOTE: A program option allows you to prohibit operating the **[PRICE]** key in the REG mode.

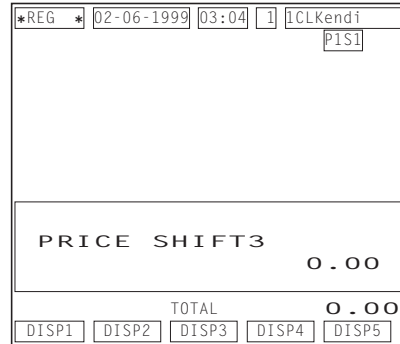

9.17 Combo (Combination) Sale Entry

This operation is used to perform the special discount (%-, Dollar Discount, Free of Charge) to the PLU Entry on the basis of the Combo Table information. You can select either of the following two features.

Manual Combo Sale Entry Feature

Combo sale entry becomes effective and is performed only when you depress the **[COMBO]** key before the sale finalization.

Automatic Combo Sale Entry Feature

Combo sale entry is automatically performed when the sale transaction is finalized. To temporarily prohibit the combo sale entry, the use of the **[COMBO]** key is effective.

OPERATION

Depress the **[COMBO]** key any time before When the combo sale entry is effective, the descriptor "COMBO" is displayed on the operator display. When not effective, the descriptor disappears. The descriptor "DISC" is displayed when the special discount is performed.

NOTE: In the combo sale entry, the 1st preset price programmed for each PLU is used. Also in this entry, only the preset-price PLUs can be used.

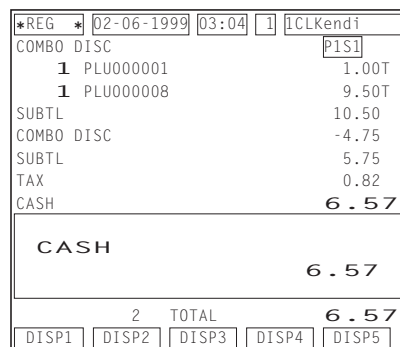

9.18 Scale Entry

OPERATION (Scale entry is allowed only for the scale type PLUs)

9.18.1 Automatic Scale Entry (without tare or by the tare automatic subtraction)

- Through Preset-PLU: Place the item on the scale platter. \longrightarrow **[SCALE]** \longleftarrow (M)
- \longrightarrow **[Preset PLU Code] [PLU]**

- Through Open-PLU: Place the item on the scale platter. → **[SCALE]** ← (M)
- [Open-PLU Code] **[PLU]** [Unit Price] **[AMT]**
per Unit Weight

NOTE: When the PLU is programmed with a Tare Table No., the tare weight is automatically subtracted from the scaled weight, and thus only the net weight is processed.

9.18.2 Scale Entry by entering the Tare Table No.

[Tare Table No.] **[TARE]** → to be continued to the arrows marked with "(M)" in the above two operations of the Automatic Scale Entry.
1 to 9

9.18.3 Scale Entry by manually entering the Tare Weight

[Tare Weight] **[MANUAL TARE]** → to be continued to the arrows marked with "(M)" in the above two operations of the Automatic Scale Entry.
Any value other than 0, however, less than the weight of scaled item

9.18.4 Manual Scale Entry

[Net Weight] of the item → **[SCALE]** → to be continued to the arrows marked with "(M)" in the above two operations of the Automatic Scale Entry.
1 to 99999
(unit: g or 1/100 LB. for example, enter 5 for 0.05LB.)

9.18.5 Scale Entry for the Void Item

[VOID] → to be continued to the top of the "Manual Scale Entry" sequence above.

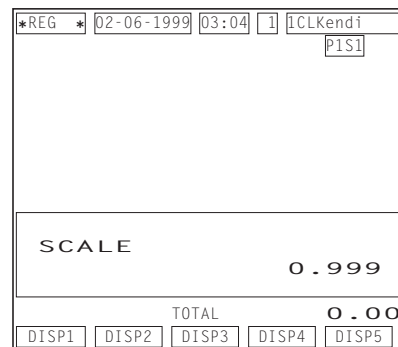

9.19 Subtotal Read

You can select one of the following three types of subtotal.

9.19.1 Tax included Subtotal

Depress the **[ST]** key any time during the sales transaction. The sales subtotal including tax will be displayed.

*REG *	02-06-1999	03:04	1	ICLKendi
				PIS1
1	PLU000001			1.00T
SUBTL				1.10
1 TOTAL				1.10
DISP1	DISP2	DISP3	DISP4	DISP5

9.19.2 Net Subtotal (tax not included)

Depress the [ST] key any time during the sales transaction. The net sales subtotal (excluding tax) will be displayed.

9.19.3 Eat-in/Takeout Subtotal

Depress the [EAT IN] or the [TAKEOUT] key before the sale transaction is finalized. The register calculates and displays the subtotal according to the programmed Eat-in/Takeout tax status.

*REG *	02-06-1999	03:04	1	ICLKendi
				PIS1
1	PLU000015			25.00T
SUBTL				25.00
CASH				25.00
*TAKE OUT *				
CASH				25.00
1 TOTAL				25.00
DISP1	DISP2	DISP3	DISP4	DISP5

9.20 Tray Total Read

Depress the [TRAY TOTAL] key after entering PLU items. The contents of the tray total itemizer which include tax is displayed.

*REG *	02-06-1999	03:04	1	ICLKendi
				PIS1
1	PLU000001			1.00T
1	PLU000010			1.50
TAX				0.25
TRAY TL				2.75
TRAY TL				2.75
2 TOTAL				2.75
DISP1	DISP2	DISP3	DISP4	DISP5

9.21 Item Correct

If you make an incorrect entry in the following sales transactions, depress the **[ITEM CORR]** key to delete the last entered item.

OPERATION

- PLU ENTRY
- REPEAT ENTRY
- QUANTITY EXTENSION
- DOLLAR DISCOUNT
- PERCENT CHARGE/DISCOUNT
- RECEIVED-ON-ACCOUNT
- PAID-OUT



- NOTES:**
1. When **[ITEM CORR]** is depressed after the Repeat Entry, only the last item of those repeated will be deleted.
 2. When **[ITEM CORR]** is depressed after the Quantity Extension entry, the entire product (result of multiplication) will be deleted.

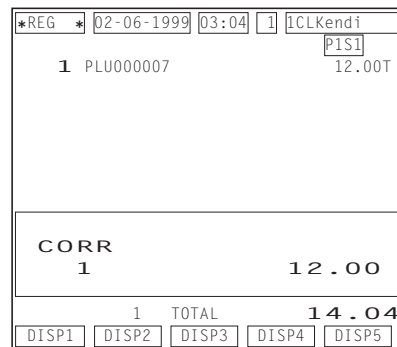

9.22 Void (Designated Line Voiding and Returned Merchandise)

This operation deletes a PLU item (not necessarily the last entered item) already entered in the sales transaction. It is also used outside a sale to return an item already purchased.

OPERATION

- Void through the **[PLU]** key
 Depress the **[VOID]** key prior to or any time during the entry sequence of the following operations:
 PLU Entries (except Repeat Entry)
 Percent Discount/Charge on a PLU item
- Void through the Operator Display

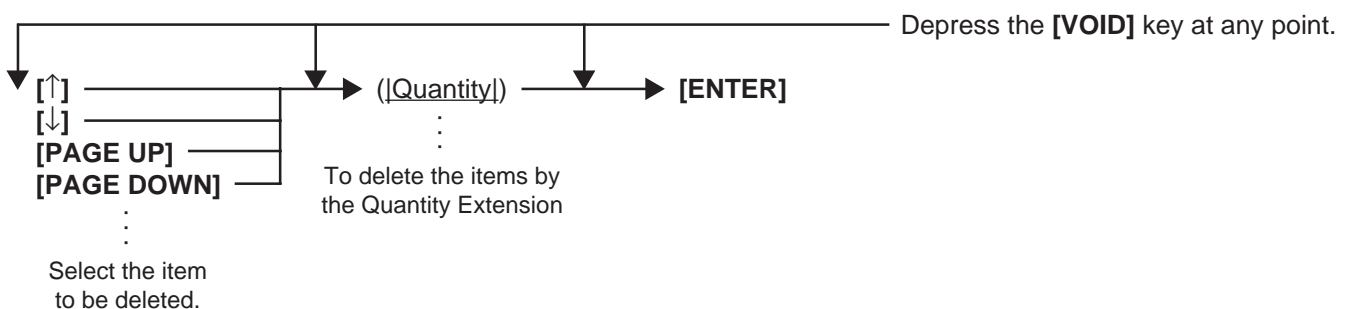

*REG *	02-06-1999	03:04	1	ICLKendi
				PIS1
1	PLU000007			12.00T
1	PLU000008			9.50T
*VOID				
1	PLU000007			-12.00T
PLU000007				-12.00
1 TOTAL				10.17
DISP1	DISP2	DISP3	DISP4	DISP5

9.23 All Void

When the current sales transaction now being entered must be canceled before the sale finalization, the All Void operation is effective.

OPERATION

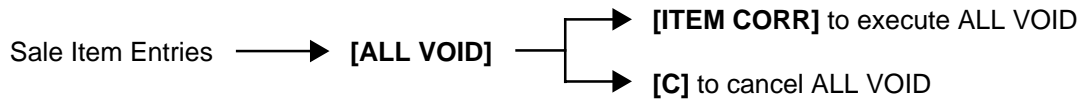

NOTE: You cannot perform the All Void if the sales items of 31 or more have already been entered in the sales transaction.

*REG *	02-06-1999	03:04	1	ICLKendi
				PIS1
1	PLU000001			1.00T
1	PLU000010			1.50T
1	PLU000100			2.00T
1	PLU000002			3.00T
1	PLU000020			3.50T
SUBTL				11.00
*ALL VD				
ALL VD				0.00
TOTAL				0.00
DISP1	DISP2	DISP3	DISP4	DISP5

9.24 Order Entry Control

You can select either of the following two features.

9.24.1 Order Entry Control (Order Table No. Manual Entry)

OPERATION

■ To start new order table:

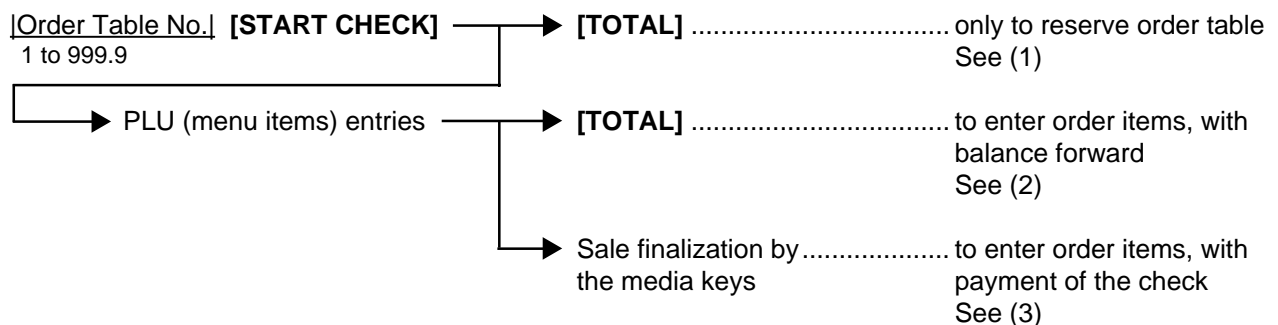

- To cancel the order table already reserved:
 [Order Table No. in reservation] [START CHECK] → [AT/TL] See (4)
- To enter order items for the reserved order table, or to enter additional order items for the order table in use:
 [Order Table No. in reservation or in use] [START CHECK] → PLU (menu items) entries
 See (5)

9.24.2 Order Entry Control (Order Table No. Automatic Entry)

OPERATION

- To start new order table:

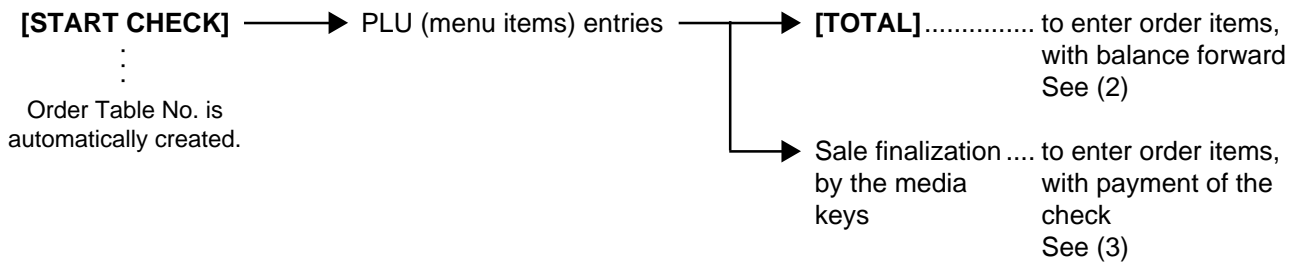

- To enter additional order items for the order table No. in use:

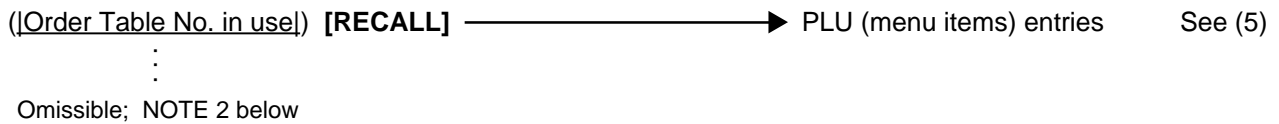

- NOTES:**
1. You cannot perform the following sales transactions after entering the order table No.
 - No-sale, Received-on-Account, Paid Out
 - Negative PLU Entry
 - All Void
 - Tray Total Read
 - Percent Charge/Discount and Dollar Discount on PLU item
 2. Entry of the order table No. before depressing the [RECALL] key is omissible. In this case, the oldest-recorded order table No. among all of the opened order tables will be read out.

(1)

*REG *	02-06-1999	03:04	1	[i]CLKendi
TABLE NO	001			[P]ISi
RESERVATION001				
				0.00
TOTAL				0.00
[DISP1]	[DISP2]	[DISP3]	[DISP4]	[DISP5]

(2)

*REG *	02-06-1999	03:04	1	[i]CLKendi
TABLE NO	001			[P]ISi
1	PLU000001			1.00T
1	PLU000010			10.00T
NEW BALANCE001				
				11.90
2 TOTAL				11.90
[DISP1]	[DISP2]	[DISP3]	[DISP4]	[DISP5]

(3)

*REG *	02-06-1999	03:04	1	ICLKendi
TABLE NO	001			PIS1
1	PLU000001			1.00T
1	PLU000010			10.00T
SUBTL				11.00
TAX				0.90
CASH				11.90
CASH				
11.90				
				2 TOTAL
				11.90
DISP1	DISP2	DISP3	DISP4	DISP5

(4)

*REG *	02-06-1999	03:04	1	ICLKendi
TABLE NO	001			PIS1
CANCEL				
001				
0.00				
				0 TOTAL
				0.00
DISP1	DISP2	DISP3	DISP4	DISP5

(5)

*REG *	02-06-1999	03:04	1	ICLKendi
TABLE NO	001			PIS1
1	PLU000001			1.00T
1	PLU000010			10.00T
SUBTL				
11.90				
				2 TOTAL
				11.90
DISP1	DISP2	DISP3	DISP4	DISP5

9.25 Order Entry Control with Table No.

OPERATION

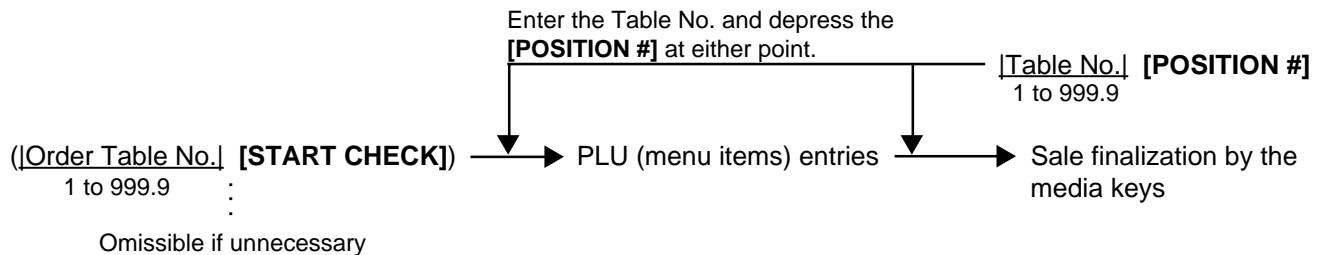

*REG *	02-06-1999	03:04	1	ICLKendi
2' nd NO.	005			PIS1
1	PLU000010			10.00T
SUBTL				10.00
TAX				0.80
CASH				10.80
CASH				
10.80				
				1 TOTAL
				10.80
DISP1	DISP2	DISP3	DISP4	DISP5

9.26 Temporary Release of Order Table No. Entry Compulsion

This operation releases one sales transaction from the compulsory status of the order table No. entry. It is effective only when the program option "Compulsion of the Order Table No. Entry" has been programmed.

OPERATION (must be operated outside a sale)

[PUB MODE] → PLU (menu items) Entries

NOTE: After finalizing the sale, the status of the Order Table No. entry compulsion is automatically resumed.

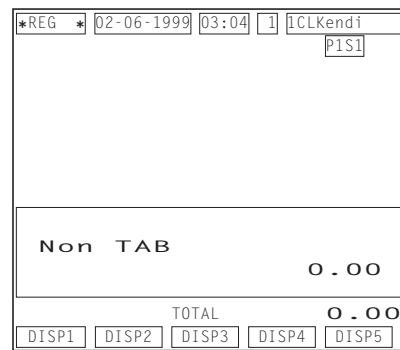

9.27 Guest Check Merge

Two different guest check accounts can be merged together.

OPERATION

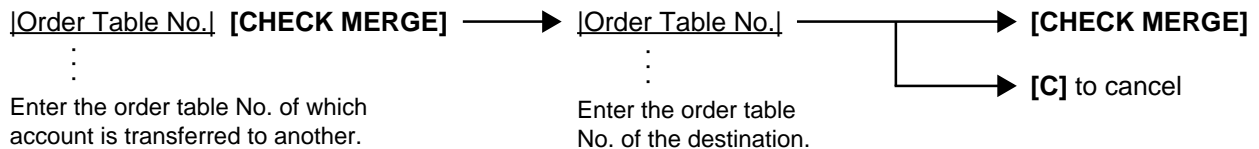

NOTES:

1. This operation is available only to the opened order table account. Entry of unopened or reserved order table No. causes an error.
2. If the item buffers of the two order tables to be merged exceed 100, this operation will result in an error.

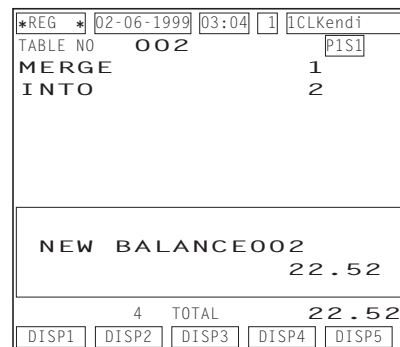

9.28 Guest Check Transfer

Guest check account can be transferred to another of the order table not in use.

OPERATION

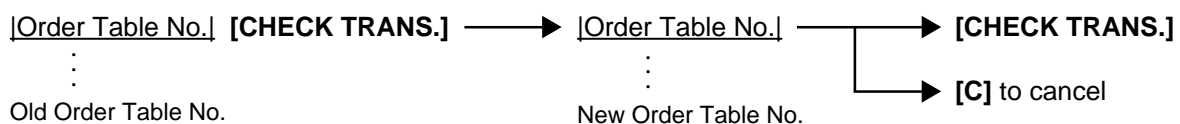

- NOTES:**
1. As for the old order table, you can use reserved or opened one. As for the new order table, you can use reserved or unopened one.
 2. When the register adopts the feature "Order Entry Control by automatic entry of the Order Table No.", you cannot enter the new order table No. and it will be automatically designated.

*REG *	02-06-1999	03:04	1	ICLKendi
TABLE NO	002			PIS1
TRANSFER			1	
INTO			2	
TABLE TRANS002				
43.20				
4 TOTAL				43.20
DISP1	DISP2	DISP3	DISP4	DISP5

9.29 Guest Check Split

Guest check account can be partially transferred to another of the order table not in use.

OPERATION

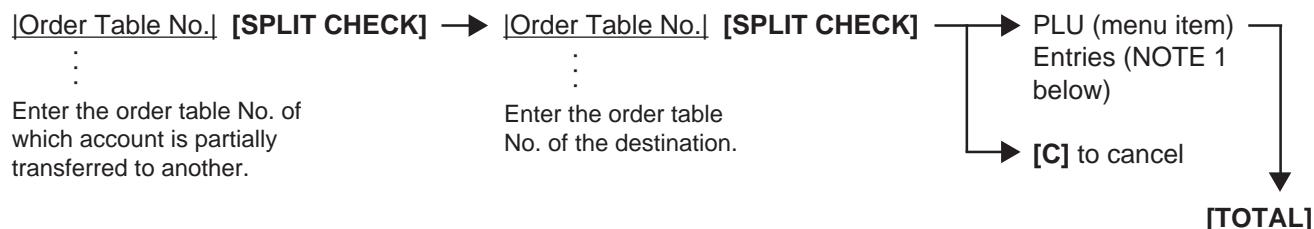

- NOTES:**
1. You can only enter the sales items which have been stored in the item buffer of the order table of which account is transferred.
 2. When the register adopts the feature "Order Entry Control by automatic entry of the Order Table No.", you cannot enter the order table No. of the destination and it will be automatically designated.
 3. After the PLU entries, you can check the contents of the two order tables using the [←] and [→] keys.

If a guest wants to pay the check partially or entirely.....

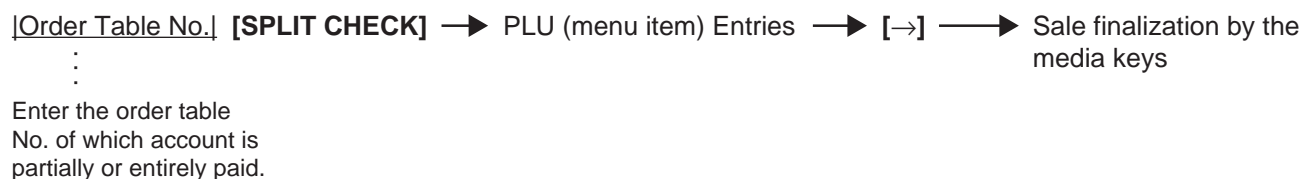

*REG *	02-06-1999	03:04	1	ICLKendi
TABLE NO	001			PIS1
SPLIT			1	
			2	
4	PLU000010			40.00T
NEW BALANCE002				
43.20				
4 TOTAL				43.20
DISP1	DISP2	DISP3	DISP4	DISP5

9.30 Sale Finalization by Media Keys (Payment of a Sale)

OPERATION

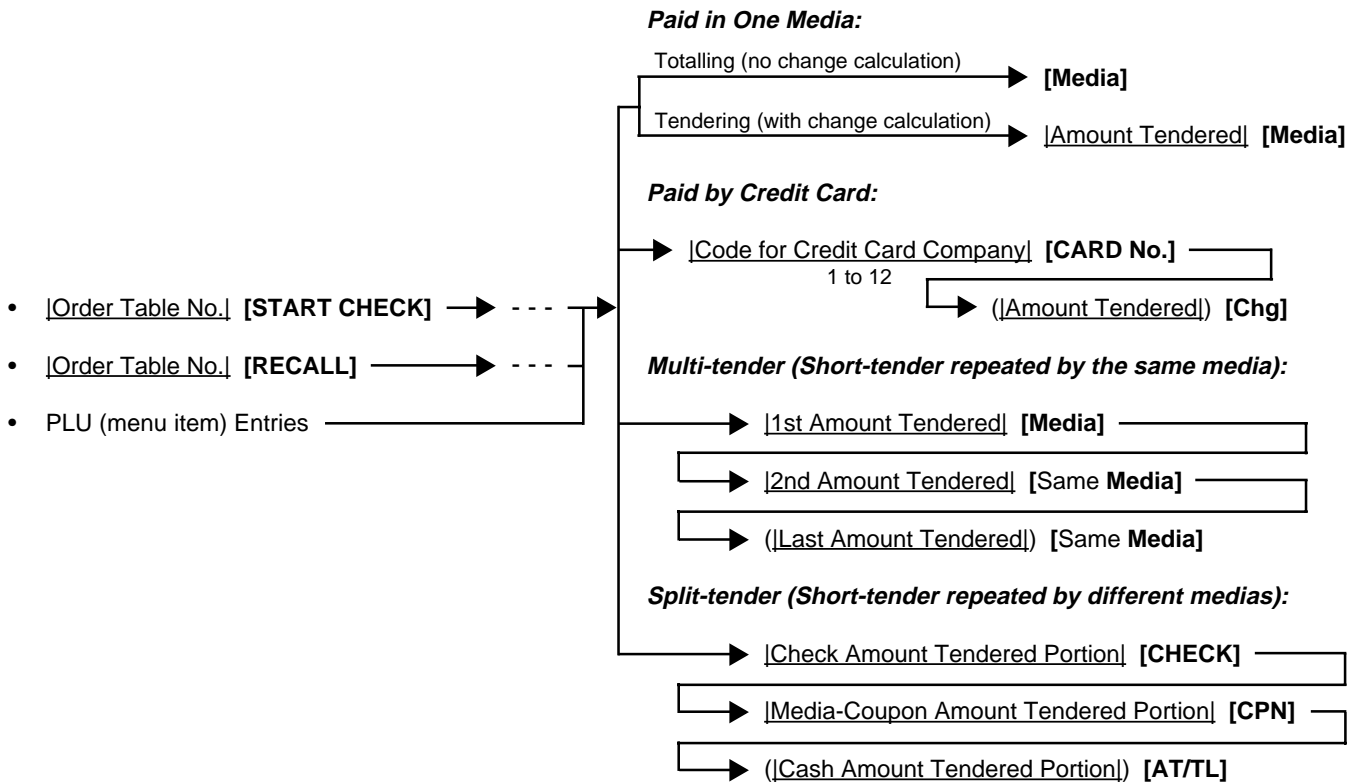

NOTE: If the [TENDER UP] key is installed on the keyboard, the cash tendering operation corresponding to the sales total will be automatically performed by depressing its key. Example) The following value is programmed to the Tender Up table:
\$5.00, \$10.00 and \$20.00
When you depress the [TENDER UP] key for the sale total \$7.00, the cash tendering operation by \$10.00 will be automatically performed.

REG	02-06-1999	03:04	1	ICLKendi
				PIS1
1	PLU000010			7.00T
	SUBTL			7.00
	TOTAL			7.00
	CATEND			10.00
	CHANGE			3.00
	CHANGE			3.00
	1	TOTAL		7.00
	DISP1	DISP2	DISP3	DISP4
				DISP5

9.31 Charge Posting by Check Track

This operation is used for the charge posting, and the entry of customer code reads out the customer account balance.

OPERATION

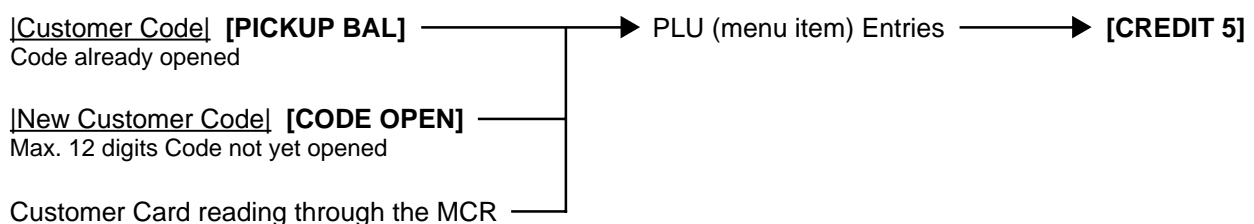

NOTE: If the PLU price level is programmed to each customer, the PLU (menu item) entry will be fixedly performed by the corresponding price level. In this case, using the **[PRICE]** key to change the level causes an error, and also the hourly range price level is ignored if programmed.

*REG *	02-06-1999	03:04	1	[CLKendi	
				PIS1	
	No999999999999				
SMITH					100.00
SMITH					100.00
TOTAL					100.00
DISP1	DISP2	DISP3	DISP4	DISP5	

Customer Code

9.32 Sale Paid in Foreign Currencies

OPERATION

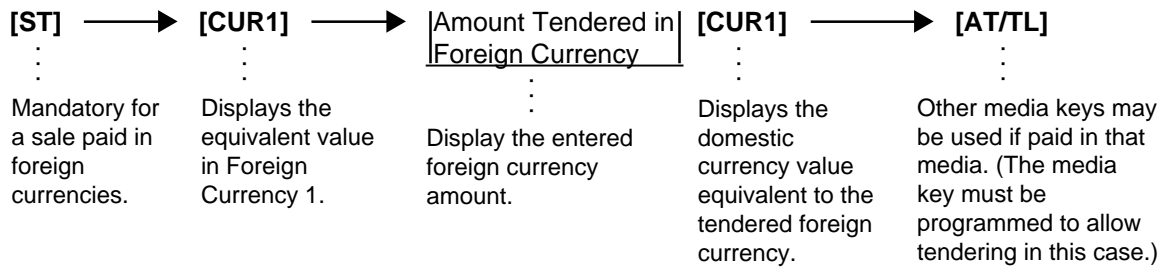

- NOTES:**
1. The **[CUR 2]** to **[CUR 5]** keys operate the same as **[CUR 1]**, except that each of these keys has its own exchange rate programmed corresponding to each foreign currency.
 2. Multi-tendering with the same foreign currency or Split-tendering with other medias or foreign currencies are possible.
 3. The foreign currency keys cannot be used to finalize Received-on-Account payments, or Paid-out items.
 4. When a tendering by a foreign currency occurs after a short-tendered condition, the **[ST]** key will not be mandatory.
 5. A sale of zero or negative balance cannot be finalized using any of the foreign currency keys.

*REG *	02-06-1999	03:04	1	[CLKendi	
				PIS1	
SUBTL					20.00
TAX					1.60
TOTAL					21.60
CUR1					100.00
	0.365*				
CATEND					36.50
CHANGE					14.90
CHANGE					14.90
2 TOTAL					21.60
DISP1	DISP2	DISP3	DISP4	DISP5	

9.33 Media Transfer

This operation is used to change a media already paid and finalized into a different one.

OPERATION

(must be operated outside a sale)

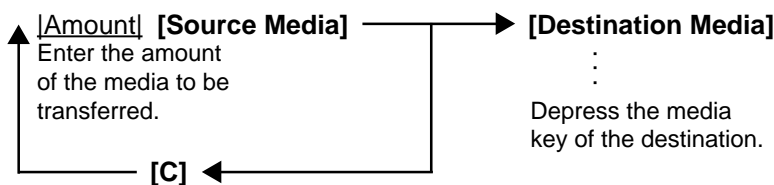

*REG *	02-06-1999	03:04	1	ICLKendi
				PIS1
*CHANGE *				
CHANGE		CPN		
INTO		CASH		
				10.00
CASH				10.00
TOTAL				0.00
DISP1	DISP2	DISP3	DISP4	DISP5

9.34 Tax Status Modification

Tax status of the PLU or required key is reversed:

OPERATION

Depress the [TX1/M] to [TX4/M] of which tax status is to be modified prior to or any time (before the final key at the latest) during the entry sequence of the following operations. More than one modifier key can be depressed for the same item entry:

- PLU Entries
- Percent Discount/Charge
- Dollar Discount

NOTE: If the inclusive-tax feature is selected to the [TX3/M] and [TX4/M] keys, the tax status modification using those keys is not allowed.

9.35 Automatic Tax Calculation

When the tax table (or tax rate) and the tax status of each PLU have been programmed for the register, the tax calculation is automatically performed on any taxable PLU item.

9.36 Manual Tax Entry

The register allows you to manually enter the tax after the PLU entries.

OPERATION

|Irregular Tax Amount to be Added| [TAX]

*REG *	02-06-1999	03:04	1	ICLKendi
				PIS1
1	PLU000001			1.00T
TAX5				0.12
TAX5				0.12
1 TOTAL				1.12
DISP1	DISP2	DISP3	DISP4	DISP5

9.37 Tax Exemption

OPERATION

■ *Selective Tax Exemption*

- Examples) [TX1/M] [EX] → Sale Finalization to exempt Tax 1 from the sale
 [TX1/M] [TX2/M] [EX] → Sale Finalization to exempt Tax 1 & Tax 2 from the sale
 [TX1/M] [TX2/M] [TX3/M] [EX] → Sale Finalization to exempt Tax 1, Tax 2 and Tax 3 from the sale

■ *All Tax Exemption*

- [EX] → Sale Finalization } to exempt all the
 [TX1/M] [TX2/M] [TX3/M] [TX4/M] [EX] → Sale Finalization } taxes from the sale

NOTE: If the inclusive-tax feature is selected to the [TX3/M] and [TX4/M] keys, the tax exemption of Tax 3 and Tax 4 is not allowed.

*REG *	02-06-1999	03:04	1	ICLKendi
				PIS1
1	PLU000010			10.00T
	TAX2EX			10.00
TOTAL				10.00
	1	TOTAL		10.00
DISP1	DISP2	DISP3	DISP4	DISP5

9.38 Listing Capacity Open

■ *For Departments and PLUs*

Depress the [LC OPEN] (or [OPEN]) key prior to or any time during the PLU entry (including REPEAT and QUANTITY EXTENSION entries). Please note that the [LC OPEN] or [OPEN] key must be pressed, at the latest, before the final key of the entry sequence. The High Amount Limit for the PLU will be extended with two higher digits, and the Low Amount Limit will be extended with one lower digit. For entering an amount still exceeding these limits, you must call for Manager Intervention.

■ *For Media Tender Amounts*

Depress the [LC OPEN] (or [OPEN]) key before or after the tender amount entry. The High Amount Limit for the media tendering will be extended with one higher digit. For entering an amount still exceeding this limit, you must call for Manager Intervention.

9.39 Selective Itemizer (SI) Status Modification

Depress the [SI/M] ([SI1/M], [SI2/M]) key for entering the required PLU item, the same way as [LC OPEN] is operated. The SI-net status is reversed to non-net status, and vice versa.

9.40 Selective Itemizer (SI) Total Read

Depressing the [SI/TL] key during the sales transaction displays the selective itemizer total calculated.

OPERATION

- PLU (menu item) Entry → [SI/TL]
 ([SI1/TL], [SI2/TL])

NOTE: Selective Itemizer Total Read after the order table No. entry is possible.

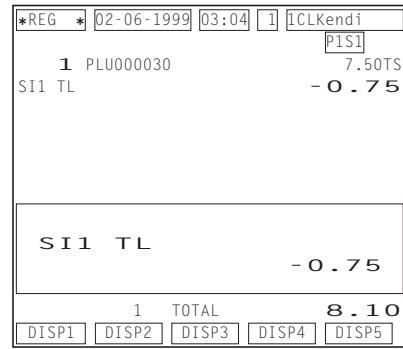

S: SI-net Symbol

9.41 PLU Preset Price Read

You can check the preset price of each PLU.

OPERATION (Any time inside or outside a sale, but prohibited during a short-tendered condition.)

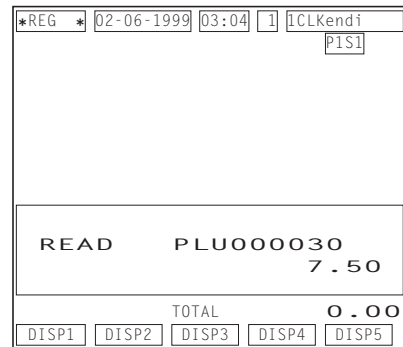
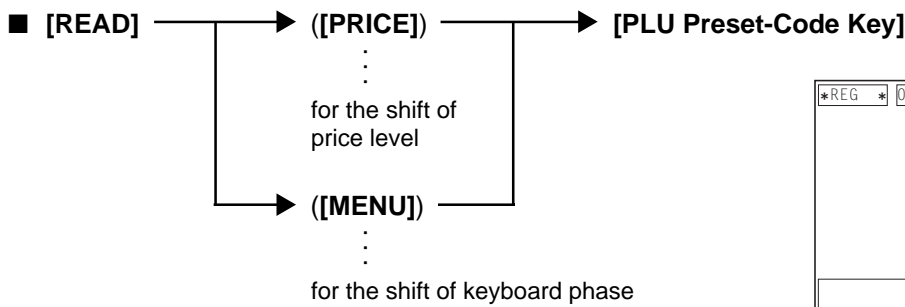
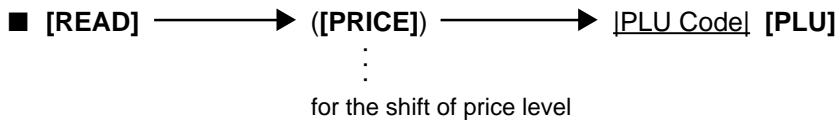

9.42 PLU Stock Read

You can check the current stock of each PLU.

OPERATION (Any time inside or outside a sale, but prohibited during a short-tendered condition.)

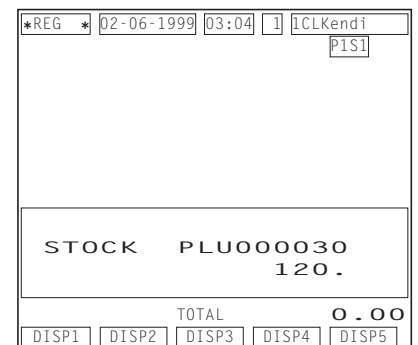
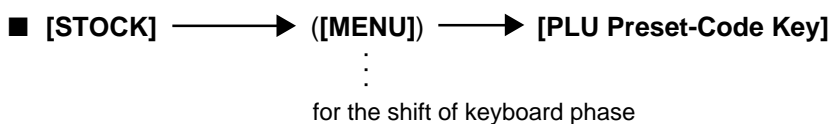

9.43 Dollar Discount

OPERATION

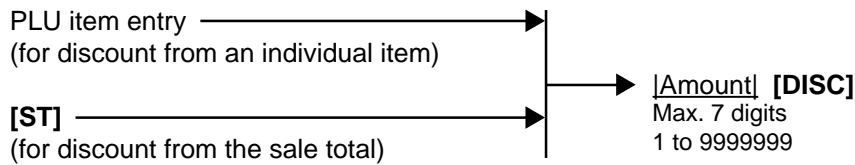

- NOTES:**
- Discount from the sale total
 - An amount exceeding the sale total cannot be entered without the "Credit Balance" option. However, the amount exceeding the sale total cannot be entered even with the "Credit Balance" option when the sales transaction includes the order table No. entry.
 - After the Dollar Discount entry, additional item entry cannot be performed.
 - Dollar Discount can be performed only once in a sale.
 - Discount from an individual item
 - Dollar Discount can be performed only when the sales transaction does not include the order table No. entry.

*REG *	02-06-1999	03:04	1	[CLKendi
				[PIS]
1	PLU000010			10.00T
	DISC			-0.10
DISC				
				- 0.10
1 TOTAL				10.70
DISP1	DISP2	DISP3	DISP4	DISP5

9.44 Percent Discount, Percent Charge

OPERATION

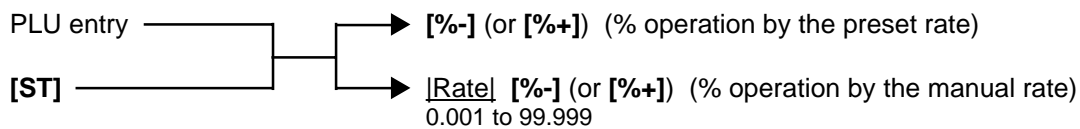

- NOTES:**
- You can perform the manual rate % operation by manually entering a % rate even when the preset rate has been programmed on the [%] key.
 - % operation for the sale total
 - After the % operation, additional item entry cannot be performed.
 - % operation can be performed only once in a sale.
 - % operation for an individual item
 - % operation can be performed only when the sales transaction does not include the order table No. entry.

*REG *	02-06-1999	03:04	1	[CLKendi
				[PIS]
1	PLU000010			10.00T
%-	5%			-0.50
% -				
				- 0.50
1 TOTAL				10.30
DISP1	DISP2	DISP3	DISP4	DISP5

9.45 Non-add Number Print

Non-add numbers can be entered for future reference, to indicate guest code, media checks, credit cards, etc. The entered numbers do not affect any sale total data.

OPERATION (allowed any time during a sale or transaction)

Number [#]
Max. 18 digits

- NOTES:**
1. A program option allows you to prohibit operating the No-sale transaction after entering a non-add number.
 2. Non-add number print immediately after entering the order table No. is not possible.

*REG *	02-06-1999	03:04	1	ICLKendi
				PIS1
#123000				
#				
				1230.00
TOTAL				0.00
DISP1	DISP2	DISP3	DISP4	DISP5

9.46 Number-of-guests Entry

Number of the guests of sale can be entered.

OPERATION (allowed any time during a sale or transaction)

Number of Guests [GUEST #]
Max. 3 digits

- NOTE:** When you enter the number of the guests more than once, the last entered number will be effective.

*REG *	02-06-1999	03:04	1	ICLKendi
				PIS1
1	PLU000010			10.00T
GUEST				2CU
GUEST				
				0.02
1 TOTAL				10.80
DISP1	DISP2	DISP3	DISP4	DISP5

9.47 Function Key Entry

Once you depress the [FUNCTION] key, the programmed key operation sequence is automatically performed.

OPERATION

[FUNCTION]

⋮

[FUNCTION 1] to [FUNCTION 20]

Example) Key operation sequence shown below has been previously programmed on the [FUNCTION 1] key:
[1] [PLU] [2] [0] [PLU] [ST] [5] [%-]

*REG *	02-06-1999	03:04	1	ICLKendi
				PIS1
1	PLU000001			1.00T
1	PLU000020			8.50T
SUBTL				9.50
%-	5%			-0.48
SUBTL				
				10.65
2 TOTAL				10.65
DISP1	DISP2	DISP3	DISP4	DISP5

9.48 Tip Paid

When a guest pays the tip by credit card, this operation can divide the tip and pay it to each cashier in cash.

OPERATION (must be operated outside a sale)

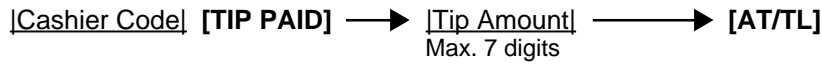

* REG *	02-06-1999	03:04	1	ICLKendi
2CL	2			PIS1
TIP PAID				
CASH				10.00
CASH				10.00
TOTAL				0.00
DISP1	DISP2	DISP3	DISP4	DISP5

9.49 Charge Tip

OPERATION

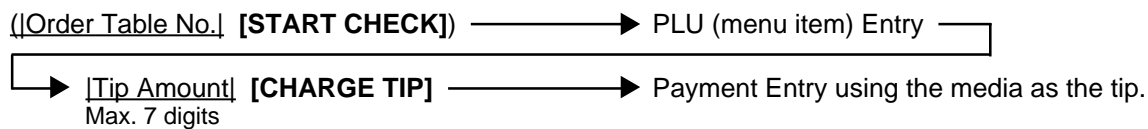

NOTE: You cannot use the [AT/TL] key for the first tender operation after depressing the [CHARGE TIP] key.

* REG *	02-06-1999	03:04	1	ICLKendi
				PIS1
1	PLU000010			10.00T
CHG TIP				0.50
CHG TIP				0.50
1 TOTAL				11.30
DISP1	DISP2	DISP3	DISP4	DISP5

9.50 Received-on-Account

A received-on-account transaction is used to identify money which is in the drawer but not from the daily business.

OPERATION (must be operated outside a sale)

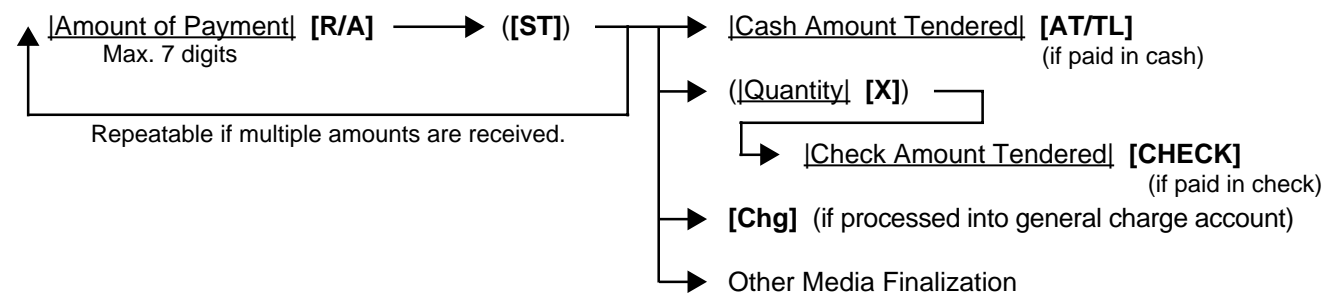

- NOTES:**
1. The media keys used for this operation must be programmed to allow received-on-account entries.
 2. A received-on-account transaction after an order table No. entry is not possible.

* REG *	02-06-1999	03:04	1	[ICLKendi]
				[PIS1]
R/A				5.00
R/A				10.00
SUBTL				15.00
CASH				15.00
CASH				15.00
TOTAL				15.00
[DISP1]	[DISP2]	[DISP3]	[DISP4]	[DISP5]

9.51 Paid-Out

A paid-out transaction is used when money is removed from the drawer without totaling to a sale.

OPERATION (must be operated outside a sale)

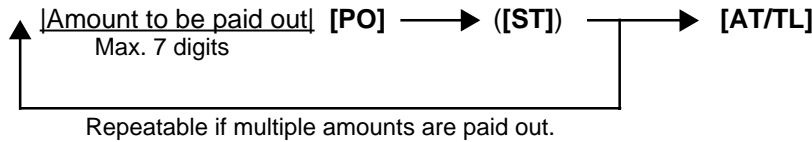

- NOTES:**
1. Only the [AT/TL] key can finalize a paid-out transaction (i.e. must be paid out in cash).
 2. A paid-out transaction after an order table No. entry is not possible.

* REG *	02-06-1999	03:04	1	[ICLKendi]
				[PIS1]
PO				10.00
SUBTL				10.00
TOTAL				10.00
TOTAL				10.00
TOTAL				10.00
[DISP1]	[DISP2]	[DISP3]	[DISP4]	[DISP5]

9.52 Print Mode Invert

When the option “Single/Double Print” is selected for the RKP (remote kitchen printer) receipt, the [INVERT] key operation can temporarily change the print mode to “Itemized Print”.

OPERATION

Pattern 1: To enter all the PLU items in the itemized mode

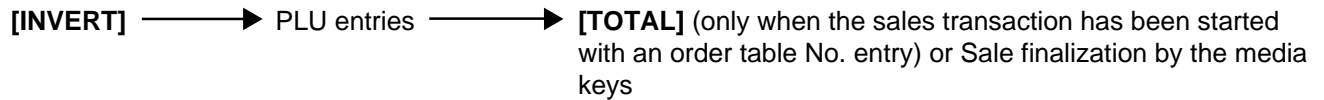

Pattern 2: To enter only the designated PLU items in the itemized mode

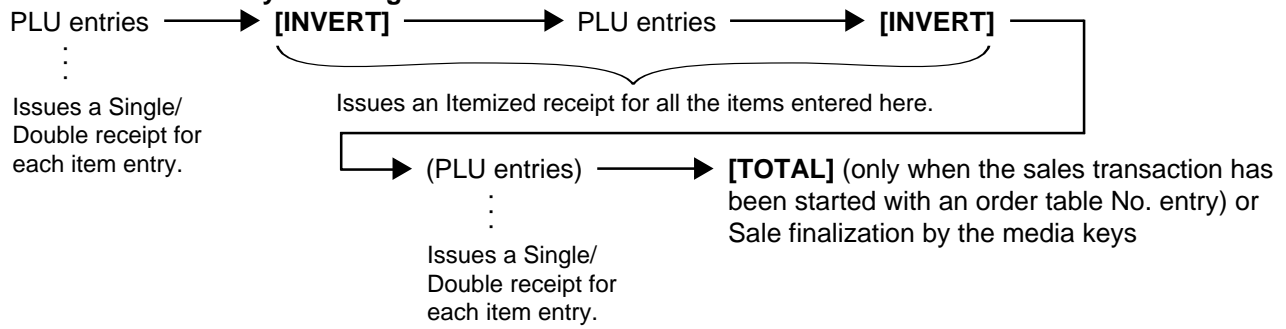

- NOTES:**
1. When the option "Itemized Print" is selected, the Print Mode Invert operation is not possible.
 2. The Itemized Print Mode once declared by the **[INVERT]** key is automatically cancelled by a finalizing operation (by **[TOTAL]** or media keys).

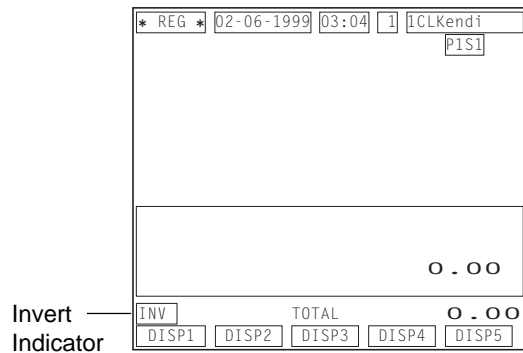

9.53 RKP (remote kitchen printer) Receipt Cut

This operation issues an RKP (remote kitchen printer) receipt while the print mode is in the "itemized print".

OPERATION

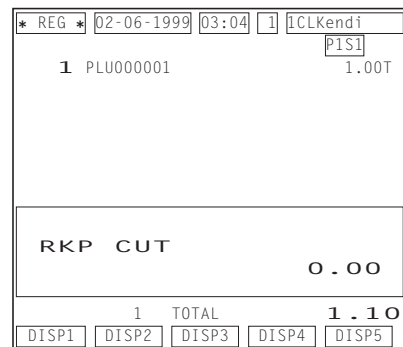
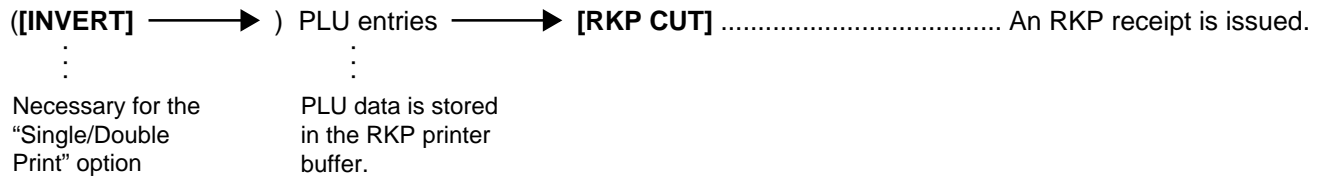

9.54 RKP (remote kitchen printer) Message Print

This operation prints a message on the RKP.

OPERATION

- **[RKP Msg]**
([RKP Msg 1] to [RKP Msg 10])
- Message No. [RKP Msg #]
1 to 20

RKP Print

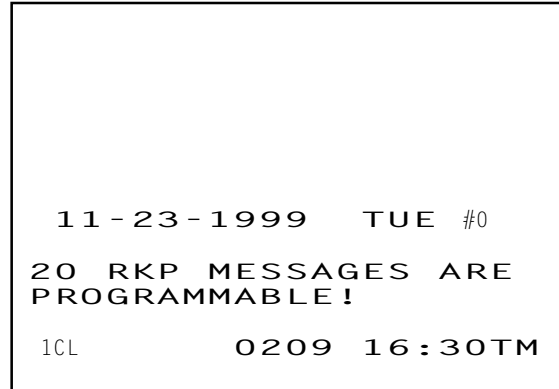

This operation is possible during a sales transaction.

ex.) PLU Entry → **[RKP Msg]** → PLU Entry

- NOTES:**
1. A message programmed in the RKP Message Table is printed on the RKP. No print occurs on receipt.
 2. A message output to the RKP consists of double-sized characters.

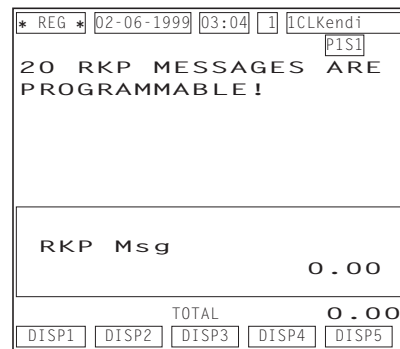

9.55 Guest Check Print

A guest check print is required when a sales transaction with an order table No. entry has been finalized by the media keys (for payment).

OPERATION

- Case 1:** When the option “Guest check is printed on the receipt roll paper” has been selected:
When a sales transaction is finalized by the media keys (for payment), a guest check will be automatically issued from the receipt.

Case 2: When the option "Guest check is printed on the slip" has been selected:
When a sale transaction is finalized by the media keys.

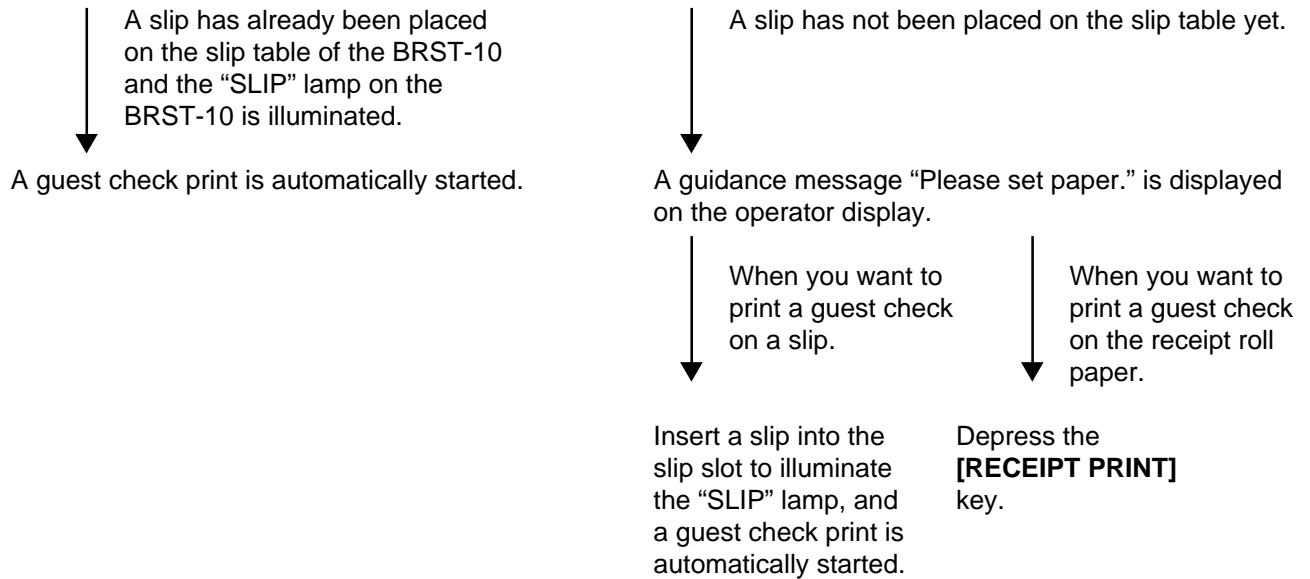

NOTE: If a guest check print requires two slips or more, the "SLIP" lamp starts to blink after auto-ejecting a slip which has just been printed. In this case, insert a new slip and the guest check print is automatically restarted.

Guest Check Receipt

TABLE NO	1	11-24-1999 WED	#0
	1	PLU000010	10.00T
	1	PLU000020	8.50T
SUBTL			18.50
TAX			2.33
CASH			20.83
1CL	0276	12:52TM	

Guest Check Slip

TABLE NO	1	11-24-1999 WED	#0
	1	PLU000010	10.00T
	1	PLU000020	8.50T
SUBTL			18.50
TAX			2.33
CASH			20.83
1CL	0280		12:53TM

9.56 Check Print

You can issue a presentation for a sale transaction which has been temporarily finalized by the **[TOTAL]** key.

OPERATION

[Table No.] **[PRINT CHECK]** → When your receipt printer is the TM-T88 or the TM-300, a presentation print is automatically started.
1 to 999.9
When your receipt printer is the BRST-10, the print procedure is the same as that of "Guest Check Print" shown on the preceding page.

NOTES: 1. The header "PRESENTATION" is printed at the top of a presentation. This operation can be operated any number of times for the same order table No. The receipt consecutive No. is not printed. Additional PLU items, if any, can still be entered after issuing a presentation.

2. A program option allows you to use a presentation as a real guest check. If so programmed, the header "PRESENTATION" is not printed. After issuing a guest check, only the sale finalization by the media keys is allowed for the order table No.

Used as a presentation

TABLE NO	3	11-24-1999 WED	#0
PRESENTATION			
1	PLU000010		10.00T
1	PLU000020		8.50T
SUBTL			18.50
TAX			2.33
TOTAL			20.83
1CL			18:23TM

The header "PRESENTATION" is printed.

Used as a real guest check

TABLE NO	3	11-24-1999 WED	#0
1	PLU000010		10.00T
1	PLU000020		8.50T
SUBTL			18.50
TAX			2.33
TOTAL			20.83
1CL			0355 18:23TM

Consecutive No. is printed

9.57 Receipt Post-issue (Receipt Reprint & Guest Check Reprint)

OPERATION (must be operated outside a sale)

9.57.1 Receipt Reprint

- Operated while the receipt-issue status is "ON".
 A sale transaction is finalized by the media keys → A receipt for the sale is issued. → **[RECEIPT ISSUE]** A copy receipt for the sale which has just been finalized is issued.
- Operated while the receipt-issue status is "OFF".
 A sale transaction is finalized by the media keys → **[RECEIPT ISSUE]** A receipt for the sale which has just been finalized is issued.

Programmable options:

- A post-issue receipt operation after issuing an ordinary receipt is prohibited.
- A post-issue receipt is always issued as a total-only receipt. If this option is not selected then the post-issue receipt will be an itemized-receipt for a sales transaction of which print lines are below 50 or less. When the print lines exceeds 50, a post-issue receipt becomes a total-only receipt.
- Operation of a post-issue receipt can be performed any number of times. If this option is not selected then the operation can be performed only once.

NOTE: A post-issue receipt for the received-on-account or the paid-out transaction cannot be issued.

9.57.2 Guest Check Reprint

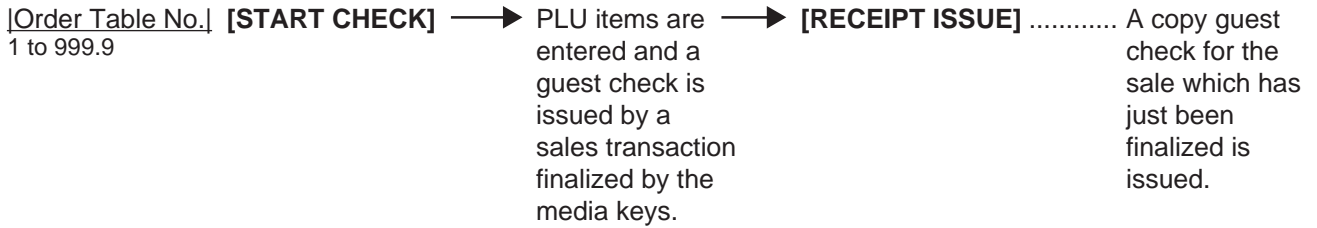

The following operation is allowed when the program option "Presentation is used as a real guest check" has been selected.

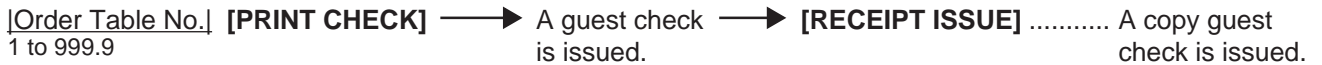

Programmable option:

- Operation of the guest check print can be performed any number of times. If this option is not selected then the operation can be performed only once.

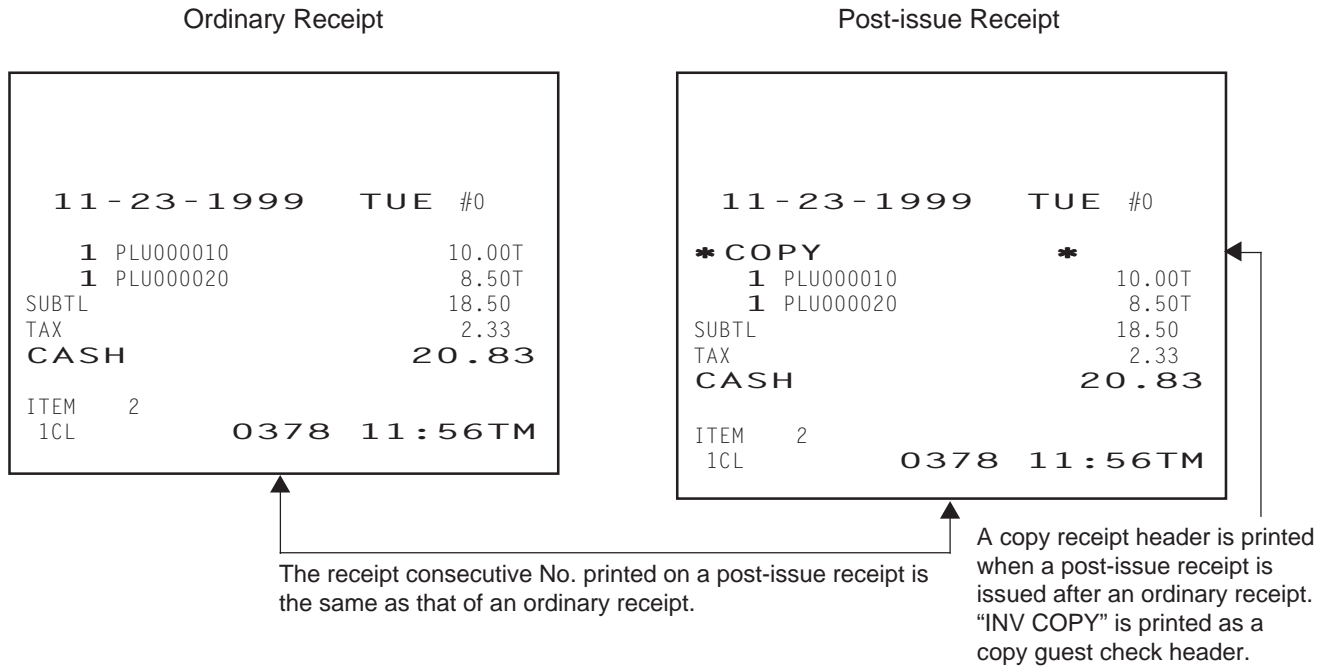

9.58 Server Transfer

Account of order tables which are handled by a cashier can be partially or entirely transferred to another cashier's account.

OPERATION (must be operated outside a sale)

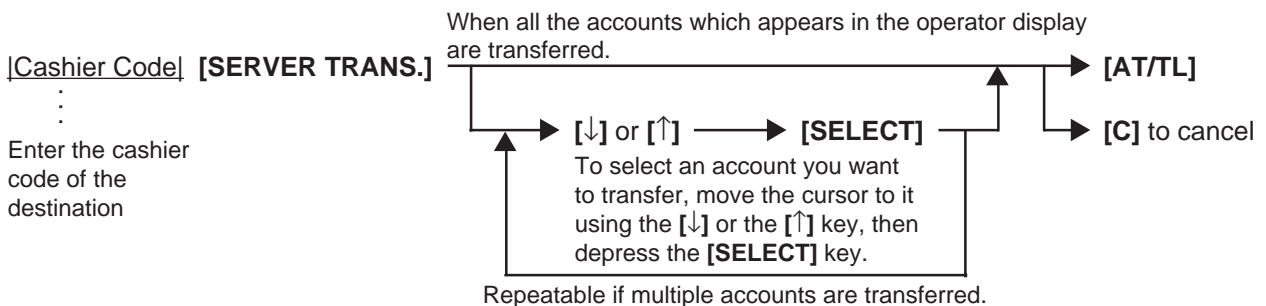

* REG *	02-06-1999	03:04	1	ICLKendi
SERVER TRANSFER	2			PIS1
1				8.50
3				10.00
TOTAL				18.50
ITEM				2
SERVER TRANSFER				
2				0.00
TOTAL				0.00
DISP1	DISP2	DISP3	DISP4	DISP5

9.59 Employee Clock-in/Clock-out

This operation records working total hours of each employee.

OPERATION (must be operated outside a sale)

■ *Clock-in*

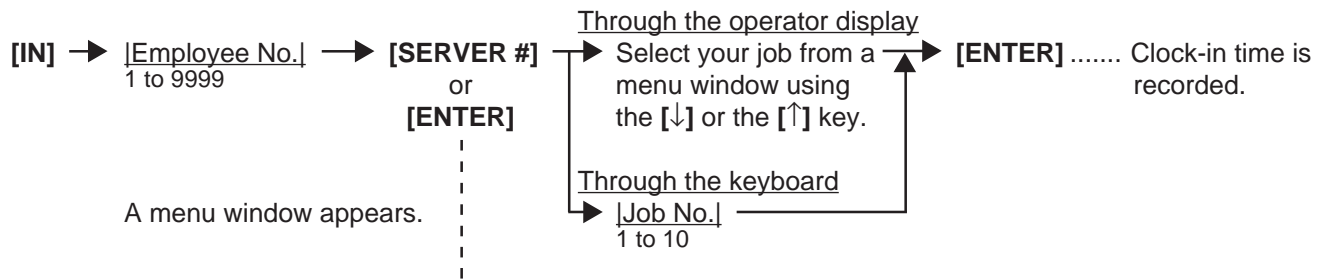

* REG *	02-06-1999	03:04	1	ICLKendi
CLOCK IN	0001			PIS1
01	CASHIER			
02	COOK			
03	SERVER			
				0.01
TOTAL				0.00
Pg up	Pg dw	Enter	↑	↓

Jobs assigned to each employee

■ *Break-in*

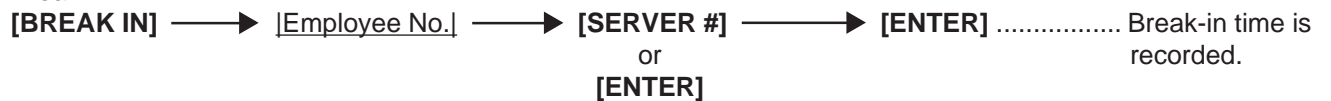

* REG *	02-06-1999	03:04	1	ICLKendi
BREAK IN	0001			PIS1
Please verify name and hit Enter.				0.01
TOTAL				0.00
DISP1	DISP2	DISP3	DISP4	DISP5

■ Break-out

[BREAK OUT] → [Employee No.] → [SERVER #] → [ENTER] Break-out time is recorded.

or
[ENTER]

⋮

* REG *	02-06-1999	03:04	1	ICLKendi
BREAK OUT	0001			PIS1
Please verify name and hit Enter.				
				0 . 0 1
TOTAL				0 . 0 0
DISP1	DISP2	DISP3	DISP4	DISP5

■ Clock-out

[OUT] → [Employee No.] → [SERVER #] → [ENTER] Clock-out time is recorded.

or
[ENTER]

⋮

* REG *	02-06-1999	03:04	1	ICLKendi
CLOCK OUT	0001			PIS1
Please verify name and hit Enter.				
				0 . 0 1
TOTAL				0 . 0 0
DISP1	DISP2	DISP3	DISP4	DISP5

NOTES:

1. This operation is allowed only when the program options "Employee Management Adopted" and "Floating Cashier Adopted" have been selected.
2. Clock-in/clock-out entry is allowed up to three times in a day.
3. Data of working total hours of each employee is collected to the employee clock-in/clock-out report.

10. TROUBLESHOOTING

IN CASE OF A POWER FAILURE

If a power failure occurs during business hours, all the sales data stored in the memory will be automatically protected by the battery installed in the register. When the power returns, the register will resume displaying the screen which had been displayed just before the power failure.

The following are possible causes and countermeasures against typical problems. When a problem occurs, refer to this chapter to find a cause of the problem, then take appropriate countermeasures. If a problem not described here occurs, or a problem still exists after taking the following countermeasures, ask the store manager to contact your authorized TOSHIBA TEC representative for assistance. In this case, inform the store manager of your problem in detail.

1. Problems concerning the Power Supply
2. Problems concerning the Keyboard
3. Problems concerning the Drawer
4. Problems concerning the Display
5. Problems during Normal Operations

WARNING!

If you cannot solve a problem with the following solutions, do not attempt to repair it yourself. Turn the power off, then contact your TOSHIBA TEC representative for assistance.

10.1 Problems concerning the Power Supply

■ Power is not turned ON.

Cause 1: Register is not plugged in.
Action: Plug in an outlet.

Cause 2: The power switch provided to the register is in the OFF position.
Action: Turn the power switch ON.

Cause 3: The outlet does not supply the power.
Action: Use another outlet.

10.2 Problems concerning the Keyboard

■ Key on the keyboard does not function.

Cause 1: Mode Lock is in the OFF position.

Action: Turn the Mode Lock to the positions other than OFF using the Mode Selector Key.

Cause 2: Failure of the keyboard itself

Action: Ask the store manager to contact your authorized TOSHIBA TEC representative for assistance.

10.3 Problems concerning the Drawer

■ Drawer does not open.

Cause 1: Drawer blocked by foreign substance (coin, etc.).

Action: Try to open the drawer by removing the foreign substance, using a ruler or something. If you are still unable to open the drawer ask the store manager to contact your authorized TOSHIBA TEC representative for assistance.

Cause 2: Failure of the drawer itself

Action: Ask the store manager to contact your authorized TOSHIBA TEC representative for assistance.

10.4 Problems concerning the Display

10.4.1 Operator Display

■ Display blank.

Cause 1: Register is not securely plugged in.

Action: Securely plug in an outlet.

Cause 2: The operator display is in the power-save mode.

Action: Depress any key.

Cause 3: The brightness control provided to the operator display is adjusted improperly.

Action: Adjust it properly.

Cause 4: Failure of the LCD

Action: Ask the store manager to contact your authorized TOSHIBA TEC representative for assistance.

10.4.2 Customer Display

■ Some segment is not displayed, display shimmers, or illumination of the display is uneven.

Cause 1: Failure of the display tube

Action: Ask the store manager to contact your authorized TOSHIBA TEC representative for assistance.

10.5 Problems during Normal Operations

NOTE on changing the Mode Lock position:

Changing the Mode Lock position during sales entries or programming causes an error. To clear the error, return the Mode Lock to the original position. However, changing the Mode Lock position to the OFF does not cause an error. Error caused by changing the Mode Lock position cannot be cleared by the **[C]** key.

■ Normal operations cannot be carried out.

Cause 1: Mode Lock position does not correspond to the operation you attempted.

Action: Check whether or not the Mode Lock position corresponds to the operation. (Especially, check whether or not the operation you attempted requires the MGR position. Ask your manager about the operations which requires the MGR position.)

2. STAND-ALONE LEVEL MANAGER'S GUIDE

TABLE OF CONTENTS

	Page
1. MANAGER INTERVENTION	1-1
1.1 Items Programmed to Require Manager Intervention	1-1
1.2 Other Operations Requiring Manager Interventions	1-2
2. MANAGER’S OWN OPERATIONS IN “MGR” MODE	2-1
2.1 Pick Up Operation	2-1
2.2 Enforced Sign-off of a Cashier (Code Entry Method)	2-1
2.3 Enforced Clock-out of an Employee	2-2
2.4 PLU Menu Shift Entry	2-2
2.5 RKP Table Change	2-3
3. OPERATIONS IN “ □ ” MODE	3-1
4. READ (X) AND RESET (Z) REPORTS	4-1
4.1 How to Access a Report Item	4-1
4.2 Time Edit for Employee Clock-in/Clock-out	4-8
4.3 Combination Reports	4-9
4.4 General Notes on Report Takings	4-10
4.5 Report Sample Format	4-10
5. PROGRAMMING OPERATIONS	5-1
5.1 Before you enter the SET Mode	5-1
5.2 Character Entries	5-2
5.3 Condition Required for Programming Operations	5-4
5.4 How to Access a Program Item	5-5
■ Store Name/Message, Commercial Message, Footer Logo Message Programming (Submode 1)	5-7
■ Cashier Programming (Submode 2)	5-8
■ Department Table Programming (Submode 3)	5-11
■ PLU Table Programming (Submode 4)	5-17
■ Time Setting or Adjustment (Submode 5)	5-24
■ Date Setting or Adjustment (Submode 6)	5-25
■ Hourly Range Setting (Submode 7)	5-26
■ Amount Limit Setting for Function Keys (Submode 8)	5-27
■ Non-taxable Amount Limit Setting (for Canada)/ Gratuity Rate Setting (Submode 12)	5-28
■ Minor Group Name Programming (Submode 13)	5-29
■ Major Group Name Programming (Submode 14)	5-30
■ Customer File Table Setting (Submode 15)	5-31
■ Combination Report Table Programming (Submode 19)	5-32
■ PLU Stock Loading or Changing (Submode 24)	5-34

- Tare Table and General Unit Weight Setting (Submode 26) 5-35
- PLU Preset-code Key/Display Key Setting (Submode 27) 5-36
- PLU Group Name Programming (Submode 29) 5-38
- RKP Message Programming (Submode 30) 5-39
- Display Message Programming (Submode 31) 5-40
- Amount Limit Setting for the [DISC] Key (Submode 35) 5-41
- Set Menu Table Programming (Submode 42) 5-42
- Combo Sale Table Programming (Submode 43) 5-43
- Guest Check Commercial Message Programming (Submode 45) 5-47
- Day Part Setting (Submode 46) 5-48
- Employee Table Setting (Submode 50) 5-49
- Job Code/Working Hours Setting (Submode 51) 5-50
- Tender Up Table Setting (Submode 52) 5-52
- Display Menu Table Setting (Submode 53) 5-53
- PLU Preset Price Setting or Changing (Submode 60) 5-55
- Printer Table Setting (Submode 71) 5-56
- %+ and %- Preset Rate Setting 5-58
- Preset Rate Setting for Selective Itemizers (SI1 and SI2) 5-59
- Foreign Currency Exchange Rate Setting 5-61
- Store/Register No. Setting 5-62

6. Verification of Programmed Data 6-1

- 6.1 How to verify a Programmed Data through the Operator Display 6-1
- 6.2 How to verify a Programmed Data through the Keyboard 6-2

1. MANAGER INTERVENTION

1.1 Items Programmed to Require Manager Intervention

During daily sale entry operations, a cashier may call for Manager Interventions.

- 1) During operations, a cashier comes across an item that requires Manager Intervention. The cashier, already informed of it, may immediately call for Manager Intervention. Or the cashier, without knowing of it, attempts the operation, and an error results with the Error Message "MANAGER REQUIRED" displayed, clears the error by the **[C]** key, and then calls for Manager Intervention.
- 2) The manager goes to the cashier counter with the **MGR** or **MA** key.
- 3) The cashier explains what kind of operation is attempted, and removes the **REG** key from the Mode Lock at the "**REG**" position.
- 4) The manager inserts the **MGR** or **MA** key and turns it to the "**MGR**" position.
- 5) The cashier operates the required item.
- 6) The manager returns the **MGR** or **MA** key to the "**REG**" position and removes it .
- 7) The cashier sets the **REG** key to the "**REG**" position again and continues registering operations.

The following is the table of the keys and operations that are programmable with Manager Intervention. Fill in the table by marking in the "Not Required" or "Required" column of each item.

KEYS/OPERATIONS AND MANAGER INTERVENTION STATUS TABLE

KEY	Manager Intervention		Reference
	Not required	Required	
[DISC]			As for the key status change, ask your TOSHIBA TEC representative.
[RECALL]			
[TIP PAID]			
[CHARGE TIP]			
[%] ([% 1] to [% 8])			
[VOID]			
[PO]			
[MENU 1] to [MENU 5]			
[PRICE 1] to [PRICE 5]			
[EX]			
[ALL VOID]			
[NS]			
[RTR]			

KEYS/OPERATIONS AND MANAGER INTERVENTION STATUS TABLE (continued)

OPERATION	Manager Intervention		Reference
	Not required	Required	
Credit Balance (NOTE 1 below)			As for the status change, ask your TOSHIBA TEC representative.
Negative-balance Sale Finalization by Media Keys (except [AT/TL]) (NOTE 2)			
Negative PLU Entries			
Media Transfer			
Guest Check Transfer			
Guest Check Merge			
Guest Check Split			
PLU Price Read			
PLU Stock Read			

- NOTES:**
1. The "Credit Balance" means that amount entries through [DISC], [VOID] will result in over-subtraction of the subtotal amount at the time of the entry through any of those keys. If the status "Not required" is selected, over-subtraction using these keys will be allowed in the "REG" mode. However, over-subtraction using the [DISC] or [VOID] key is prohibited regardless of the credit balance option if a sales transaction has been entered with an order table No. entry.
 2. The "Negative-balance Sale" may be caused by:
 1. Credit Balance of which status "Allowed" is selected.
 2. Amounts entered through the [VOID] key (without an order table No. entry).
 3. Amounts entered through negative PLUs.
 4. Other negative amounts.

1.2 Other Operations Requiring Manager Interventions

Amount Limit Release

Amount Limits may be programmed on PLUs, Tender Media, [DISC]. These limits are programmed to check an excessively high or low amount entry by cashier's mistake at the earliest stage.

- 1) During sale entries by a cashier, an error occurs when a PLU item has been entered, or a key (one of the media keys, the [DISC] key) has been depressed.
- 2) The cashier clears the error by the [C] key. The cashier confirms the amount and operates the item again.
- 3) If the same error occurs again, the cashier attempts to enter the amount using the [LC OPEN] or [OPEN] key.
- 4) If the operation results in an error again, the Amount Limit cannot be released by the [LC OPEN] or [OPEN] key.
- 5) The cashier calls for Manager Intervention.

The procedure thereafter is the same as Steps 2) to 7) for the Items Programmed to Require Manager Intervention on the preceding page.

Reference:

For reading the high and low amount limits of each PLU:

Chapter 6. VERIFICATION OF PROGRAMMED DATA Department Status Read
(Amount limit of each PLU is restricted by the amount limit of its linked department.)

For setting the item above:

Chapter 5. PROGRAMMING OPERATION Department Table Programming (Submode 3)
(Amount limit of each PLU is restricted by the amount limit of its linked department.)

For reading the common high and low amount limits of all the PLUs, and the high amount limit of each tender media key:

Chapter 6. VERIFICATION OF PROGRAMMED DATA Function Key Amount Limit Read

For setting the item above:

Chapter 5. PROGRAMMING OPERATION Amount Limit Setting for Function Keys
(Submode 8)

For reading an amount limit of the **[DISC]** key:

Chapter 6. VERIFICATION OF PROGRAMMED DATA Dollar Discount Amount Limit Read

For setting the item above:

Chapter 5. PROGRAMMING OPERATION Amount Limit Setting for the **[DISC]** Key
(Submode 35)

2. MANAGER'S OWN OPERATIONS IN "MGR" MODE

The following are operations possible only in the "MGR" position of the Mode Lock, which are performed by the manager.

2.1 Pick Up Operation

This operation is used to collect money from a drawer, during the day, for banking purpose, etc.

CONDITION Any time outside a sale, in a Signed-ON condition.

OPERATION Mode Lock: **MGR**

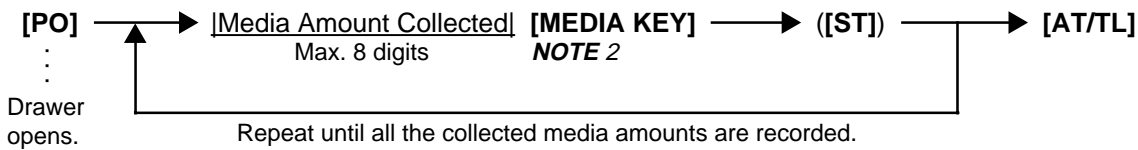

- NOTES:**
1. Each media key can be programmed with its in-drawer limit. On reaching this limit in sale entries (on finalizing a sales transaction), the Error Message "DRAWER LIMIT" is displayed with an alarm generated to notify a cashier that the Pick Up operation is needed.
 2. Depress the media keys corresponding to the collected media ([AT/TL] for cash). The media keys that can be operated here are those programmed to print their media-in-drawer amounts in reports.
 3. Depress [ST], if necessary, to obtain the subtotal amount of the medias so far collected.

* REG *	02-06-1999	03:04	1	[CLKendi]
				[PIS1]
* SERVER DROP *				
CASH				300.00
CPN				150.00
TOTAL				450.00
TOTAL				450.00
DISP1	DISP2	DISP3	DISP4	DISP5

2.2 Enforced Sign-off of a Cashier (Code Entry Method)

If a cashier once signed ON, then signed OUT to take a break does not come back, no one can operate the register. In this case, the manager can perform this operation to forcibly release the cashier signed-OUT condition.

CONDITION In a Signed-OUT condition

OPERATION Mode Lock: **MGR**

[2-digit manager-assign code] [SERVER #] Same as a normal sign-OFF
01 to 99

2.3 Enforced Clock-out of an Employee

If an employee who once clocked in forgets to perform the clock-out operation, the manager can perform this operation.

CONDITION In a Clock-IN and Signed-OFF condition

OPERATION Mode Lock: **MGR**

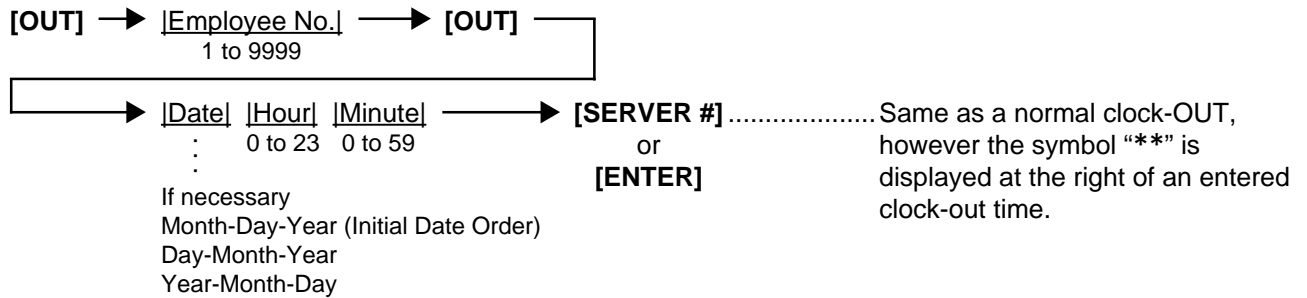

2.4 PLU Menu Shift Entry

Up to five different menus can be programmed for each [PLU Preset-code Key] and you can select either of the following two features.

2.4.1 Menu Shift Entry "Effective only for One PLU Entry" Feature

OPERATION Mode Lock: **MGR**

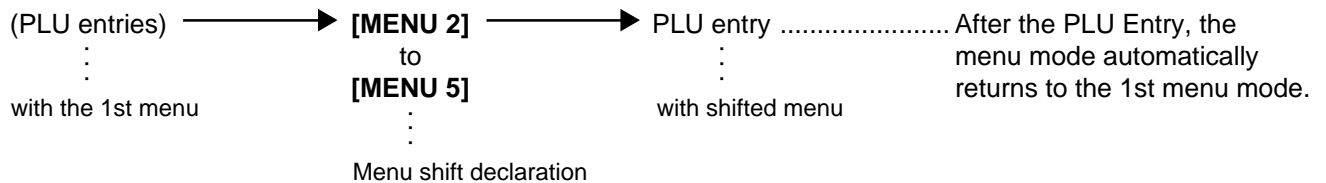

2.4.2 Menu Shift Entry "Keeping the shifted Menu Level" Feature

You can shift the PLU menu level to another in the following two cases.

- Using the [MENU] key
The same key operation as "Effective only for One PLU Entry" Feature. However, the shifted menu level is held until another [MENU] key is depressed.
- Using the Hourly Range Designation
Hourly range to start shifting each menu level can be programmed. If programmed, the menu level will be automatically shifted to another when the hourly range starts.

NOTE: A program option allows you to perform this operation in the REG mode.

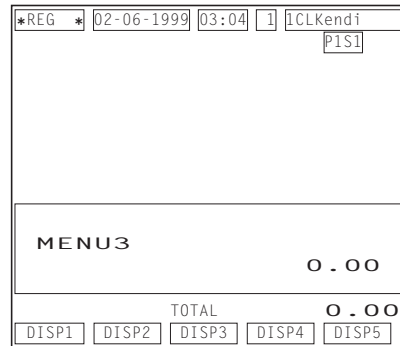

2.5 RKP Table Change

This operation changes an RKP (remote kitchen printer) on which the data is outputted.

CONDITION Any time outside a sale

OPERATION Mode Lock: **MGR**

■ RKP Designation

[RKP No.] → [RKP]
1 to 4

RKP of which No. is entered will be designated as the destination of the data output.

Example) If you operate 123 then [RKP], the RKPs of Nos. 1 to 3 will be designated.
If you operate 0 then [RKP], no RKPs will be designated.

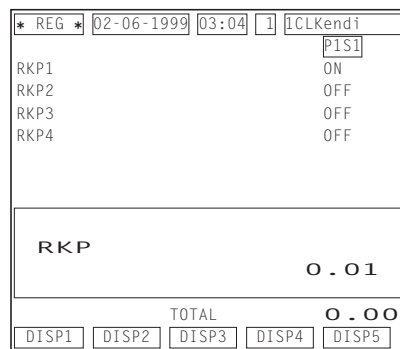

■ RKP Connection Table Change

[RKP] Each time you depress the [RKP] key, the RKP connection table is changed from 1 to 2, and vice versa.

RKP Connection Table No. (1 or 2)

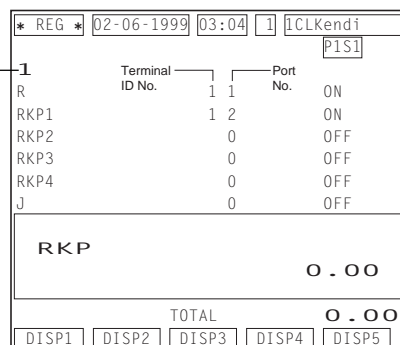

3. OPERATIONS IN “☐” MODE

When a cashier has entered some data in a guest order table buffer memory (started with an order table No. entry and ended with the [TOTAL] key) and then all the entries must be cancelled, you can quickly delete them in the ☐ position of the Mode Lock instead of deleting items one by one using the [VOID] key. For a sale entered without an order table No. entry, the ☐ mode is available by doing the same operation in REG or MGR mode.

CONDITION Any time outside a sale
Turn the Mode Lock to the ☐ position.

■ **To delete sale items without an order table No. entry:**

Enter the same items that were purchased in “REG” mode and the amount is subtracted from the memory.

Operator display in the REG or MGR mode

*REG	02-06-1999	03:04	1	ICLKendi
				PIS1
1	PLU000010			10.00T
	SUBTL			10.00
	TAX			0.80
	CASH			10.80
CASH				
				10.80
1 TOTAL				10.80
DISP1	DISP2	DISP3	DISP4	DISP5



Operator display in the ☐ mode

*REG-	02-06-1999	03:04	1	ICLKendi
				PIS1
* REG -				*
1	PLU000010			10.00T
	SUBTL			10.00
	TAX			0.80
	CASH			10.80
CASH				
				10.80
1 TOTAL				10.80
DISP1	DISP2	DISP3	DISP4	DISP5

■ **To delete items ordered with an order table No. entry (Order Table No. Manual Entry):**

[Order Table No.] [START CHECK] → [ALL VOID]All the entry data of the table is deleted.

■ **To delete items ordered with an order table No. (Order Table No. Automatic Entry):**

[Order Table No.] [RECALL] → [ALL VOID]All the entry data of the table is deleted.

Operator display in the REG or MGR mode

*REG	02-06-1999	03:04	1	ICLKendi
				PIS1
TABLE NO	001			
1	PLU000001			1.00T
1	PLU000010			10.00T
NEW BALANCE001				
				11.90
2 TOTAL				11.90
DISP1	DISP2	DISP3	DISP4	DISP5



Operator display in the ☐ mode

*REG-	02-06-1999	03:04	1	ICLKendi
				PIS1
TABLE NO	001			
* REG -				*
1	PLU000001			1.00T
1	PLU000010			10.00
ALL VD				
				0.00
TOTAL				0.00
DISP1	DISP2	DISP3	DISP4	DISP5

NOTE: You can cancel only an order table which has been temporarily finalized by the [TOTAL] key.

4. READ (X) AND RESET (Z) REPORTS

This chapter describes the operation to take each report and its contents.

- A read (X) report allows you to read the totals but not clear the memory. After issuing a read report, only a header of its report is written into the electronic journal buffer memory.
- A reset (Z) report allows you to read the totals and, at the same time, clear all the resettable totals. After issuing a reset report, all the data of its report is written into the electronic journal buffer memory.
- A symbol “X” is printed at the top of a read report, while “Z” is printed on a reset report to indicate the type of report.
- A reset report counter is printed on each reset report only.
- A daily report covers the data obtained during a certain period on that day until the corresponding reset report is issued, while a periodic report covers the data obtained during a certain period defined by the store.
- When you issue a read report, make sure that the receipt-issue status is in “ON”. If the receipt-issue OFF message is displayed in the operator display, depress the [SERVER#/RECEIPT] key so that the message disappears. As for a reset report, it can be issued even while the receipt-issue OFF message is displayed.

WARNING!

When opening the cash drawer, be careful not to let the drawer hit any person.

4.1 How to Access a Report Item

Two ways are available to access a report item you want to issue; through the operator display and through the keyboard.

4.1.1 How to Access a Report Item through the Operator Display

When you turn the mode selector key to the X or Z position, the initial screens shown below will appear.

X Mode	Z Mode
<div style="border: 1px solid black; padding: 5px; width: 100%;"> <div style="display: flex; justify-content: space-between; border-bottom: 1px solid black; margin-bottom: 5px;"> *X/GTX* 02-06-1999 03:04 </div> <div style="margin-bottom: 5px;"> 1 X 2 GTX 3 PROGRAM READ 4 E-JOURNAL 5 OTHERS </div> <div style="border: 1px solid black; padding: 2px; margin-bottom: 5px; text-align: center;"> Please select operation by Enter key. O . O O </div> <div style="display: flex; justify-content: space-between; border-top: 1px solid black;"> COMB1 COMB2 COMB3 EJ ↓ </div> </div>	<div style="border: 1px solid black; padding: 5px; width: 100%;"> <div style="display: flex; justify-content: space-between; border-bottom: 1px solid black; margin-bottom: 5px;"> *Z/GTZ* 02-06-1999 03:04 </div> <div style="margin-bottom: 5px;"> 1 Z 2 GTZ 3 E-JOURNAL 4 OTHERS </div> <div style="border: 1px solid black; padding: 2px; margin-bottom: 5px; text-align: center;"> Please select operation by Enter key. O . O O </div> <div style="display: flex; justify-content: space-between; border-top: 1px solid black;"> COMB1 COMB2 COMB3 EJ ↓ </div> </div>

■ Description of each Navigation Key (Initial screen in X or Z)

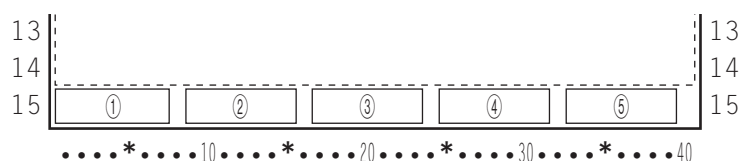

Display Item	Description
① Navigation Key 1	<input type="text" value="COMB1"/> X Mode: Start key for the daily combination read report 1 Z Mode: Start key for the daily combination reset report 1
② Navigation Key 2	<input type="text" value="COMB2"/> X Mode: Start key for the daily combination read report 2 Z Mode: Start key for the daily combination reset report 2
③ Navigation Key 3	<input type="text" value="COMB3"/> X Mode: Start key for the daily combination read report 3 Z Mode: Start key for the daily combination reset report 3
④ Navigation Key 4	<input type="text" value="EJ"/> X Mode: Start key for the all electronic journal data read report Z Mode: Start key for the all electronic journal data reset report
⑤ Navigation Key 5	<input type="text" value="↓"/> Cursor key

Example) If you want to issue the daily all cashiers read report, operate as follows.

Select "1 X" from the initial screen using the cursor key, then depress the [ENTER] key. The screen shown below appears.

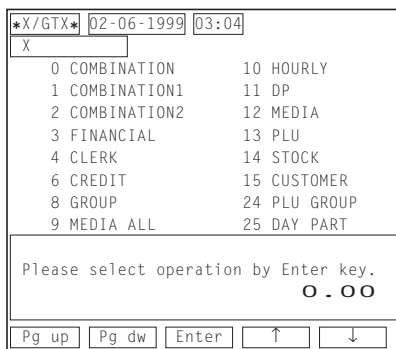

In the X or Z mode, the navigation keys are changed as follows from the second screen or later.

Display Item	Description
① Navigation Key 1	<input type="text" value="Pg up"/> Requests the preceding report item screen.
② Navigation Key 2	<input type="text" value="Pg dw"/> Requests the next report item screen.
③ Navigation Key 3	<input type="text" value="Enter"/> Decides a selected item.
④ Navigation Key 4	<input type="text" value="↑"/> Cursor Key
⑤ Navigation Key 5	<input type="text" value="↓"/> Cursor key

↓
To be Continued



Continued

Select "4 CLERK" from the screen using the cursor key, then depress the **[ENTER]** key. The screen shown below appears.

X/GTX	02-06-1999	03:04
X		
1 ALL		
2 INDIVIDUAL		
Please select operation by Enter key.		
O . O O		
Pg up	Pg dw	Enter
	↑	↓



Select "1 ALL" from the screen using the cursor key, then depress the **[ENTER]** key. The screen shown below appears.

X/GTX	02-06-1999	03:04
X	CLERK	
1 PRINT OUT		
2 DISPLAY		
Please select operation by Enter key.		
O . O O		
Pg up	Pg dw	Enter
	↑	↓



If you want to print out the report, select "1 PRINT OUT", then depress the **[ENTER]** key.

If you only want to verify the report on the display, select "2 DISPLAY", then depress the **[ENTER]** key.

- NOTES:**
1. If you want to cancel a selected item already decided by the **[ENTER]** key and go back to the preceding screen, depress the **[ESC]** key.
 2. If you want to interrupt a report print-out or a report display already started by the final **[ENTER]** key, depress the **[ITEM CORR]** or the **[VOID]** key.

■ Daily Reports (Continued)

Report Name	Mode Lock	Key Operation	Sample Page
PLU STOCK READ <ul style="list-style-type: none"> Individual PLU Stock Zone PLU Stock All PLU Stock 	<p>X</p> <p>X</p> <p>X</p>	<p>14 [#] ↑ PLU Code [PLU] → [AT/TL] Repeatabe</p> <p>14 [#] Zone-start [X] Zone-end [AT/TL] PLU Code PLU Code </p> <p>14 [AT/TL]</p>	4-17
CUSTOMER FILE READ AND RESET <ul style="list-style-type: none"> Individual File Read Zone File Read Zone File Reset All File Read All File Reset Inactive File Read 	<p>X</p> <p>X</p> <p>Z</p> <p>X</p> <p>Z</p> <p>X</p>	<p>15 [#] File Code [X] [AT/TL]</p> <p>15 [#] Zone-start [X] Zone-end [AT/TL] File Code File Code </p> <p>15 [AT/TL]</p> <p>15 [#] 0 [AT/TL]</p>	4-17
PLU GROUP SALES READ AND RESET <ul style="list-style-type: none"> PLU Group Sales Read PLU Group Sales Reset 	<p>X</p> <p>Z</p>	<p>24 [AT/TL]</p>	4-18
DAY PART READ AND RESET <ul style="list-style-type: none"> Day Part Read Day Part Reset 	<p>X</p> <p>Z</p>	<p>25 [AT/TL]</p>	4-19
CHECK TRACK (Guest Order Table) WITH SALES READ AND RESET <ul style="list-style-type: none"> All Cashier Read All Cashier Reset Individual Cashier Read Individual Cashier Reset <p>NOTE: You can check opened order tables.</p>	<p>X</p> <p>Z</p> <p>X</p> <p>Z</p>	<p>30 [ST]</p> <p><i>Code Entry Method:</i> 30 [#] Cashier ID Code [AT/TL] (2-digit manager-assign code)</p> <p><i>Cashier Key Method:</i> Depress the required Cashier Key, then 30 [AT/TL]</p>	4-19
CHECK TRACK (Guest Order Table) WITHOUT SALES READ <ul style="list-style-type: none"> All Cashier Individual Cashier <p>NOTE: You can check reserved order tables.</p>	<p>X</p> <p>X</p>	<p>31 [ST]</p> <p><i>Code Entry Method:</i> 31 [#] Cashier ID Code [AT/TL] (2-digit manager-assign code)</p> <p><i>Cashier Key Method:</i> Depress the required Cashier Key, then 31 [AT/TL]</p>	4-20

■ Daily Reports (Continued)

Report Name	Mode Lock	Key Operation	Sample Page
COMBO SALE READ AND RESET <ul style="list-style-type: none"> Individual Combo Read All Combo Read All Combo Reset All Combo Read (detail) All Combo Reset (detail) 	X X Z X Z	43 [#] ↑ Combo Code [#] ((ST)) → [AT/TL] Repeatabe	4-20
HOURLY COMBO SALE READ AND RESET <ul style="list-style-type: none"> Hourly Combo Sale Read Hourly Combo Sale Reset 	X Z	44 [AT/TL]	4-21
EMPLOYEE CLOCK-IN/CLOCK-OUT READ AND RESET <ul style="list-style-type: none"> Employee Clock-in/Clock-out Read Employee Clock-in/Clock-out Reset 	X Z	47 [AT/TL]	4-22
ELECTRONIC JOURNAL DATA READ AND RESET <ul style="list-style-type: none"> All Data Read All Data Reset Consecutive No./Date Read All Guest Check Read Cashier/Date Read Clock-in/Clock-out/Date Read Transmission History Read EJ Buffer Remaining Line Read 	X Z X X X X X X	50 [AT/TL] 50 [#] 2 [#] Consecutive No. [#] Date [AT/TL] Max. 4 digits Month-Day-Year 8 digits (NOTE below) 50 [#] 3 [#] [AT/TL] 50 [#] 4 [#] Cashier ID Code [#] (Date) [AT/TL] (2-digit manager-assign Code) Month-Day-Year 8 digits (NOTE below) * omissible 50 [#] 5 [#] (Date) [AT/TL] Month-Day-Year 8 digits (NOTE below) * omissible 50 [#] 6 [#] [AT/TL] 50 [#] 7 [#] [AT/TL] (Display only)	4-23

NOTE: A program option allows you to select the date order as follows.

- Month-Day-Year (Initial Date Order)
- Day-Month-Year
- Year-Month-Day

■ GT Reports -- to be taken on weekly or monthly basis --

Report Name	Mode Lock	Key Operation	Sample Page
FINANCIAL GT READ AND RESET <ul style="list-style-type: none"> Financial GT Read Financial GT Reset 	X Z	203 [AT/TL] (Drawer opens.)	4-24
CASHIER GT READ AND RESET <ul style="list-style-type: none"> All Cashier GT Read All Cashier GT Reset Individual Cashier GT Read Individual Cashier GT Reset 	X Z X Z	204 [ST] (Drawer opens.) <i>Code Entry Method:</i> 204 [#] Cashier ID Code [AT/TL] (2-digit manager-assign code) <i>Cashier Key Method:</i> Depress the required Cashier Key, then 204 [AT/TL]	4-24
CREDIT CARD COMPANY SALES GT READ AND RESET <ul style="list-style-type: none"> Credit Card Company Sales GT Read Credit Card Company Sales GT Reset 	X Z	206 [AT/TL]	4-24
DEPARTMENT GROUP GT READ	X	208 [AT/TL]	4-24
DEPARTMENT GT READ AND RESET <ul style="list-style-type: none"> All Department GT Read All Department GT Reset 	X Z	211 [AT/TL]	4-24
PLU GT READ AND RESET <ul style="list-style-type: none"> Individual PLU GT Read Zone PLU GT Read Zone PLU GT Reset All PLU GT Read All PLU GT Reset Inactive PLU GT Read 	X X Z X Z X	213 [#] PLU Code [PLU] ([ST]) [AT/TL] * (May be replaced by [PLU Preset-code Key]) 213 [#] Zone-start [X] Zone-end [AT/TL] PLU Code PLU Code 213 [AT/TL] 213 [#] 0 [AT/TL]	4-24
PLU GROUP SALES GT READ AND RESET <ul style="list-style-type: none"> PLU Group Sales GT Read PLU Group Sales GT Reset 	X Z	224 [AT/TL]	4-24
EMPLOYEE CLOCK-IN/CLOCK-OUT GT READ AND RESET <ul style="list-style-type: none"> Employee Clock-in/Clock-out GT Read (weekly) Employee Clock-in/Clock-out GT Reset (weekly) Employee Clock-in/Clock-out GT Read (periodic) Employee Clock-in/Clock-out GT Reset (periodic) 	X Z X Z	247 [AT/TL] 248 [AT/TL]	4-24

4.2 Time Edit for Employee Clock-in/Clock-out

This operation is used to edit the recorded time of an employee clock-in/clock-out and total break hours.

- CONDITION** An employee of which recorded time is edited must be “Clock OUT”. Furthermore if the employee has a cashier code, “Sign OFF” is also necessary.
- OPERATION** Mode Lock: Z (Allowed only through the operator display)

As described in section 4.1.1, select “47 EMPLOYEE” from the screen using the cursor key, then depress the [ENTER] key. The screen shown below appears.

Select “2 EDIT TIME” from the screen using the cursor key, then depress the [ENTER] key. The screen shown below appears.

```

*Z/GTZ* 02-06-1999 03:04
Z      EMPLOYEE
1 ALL
2 EDIT TIME

Please select operation by Enter key.
0.00

Pg up Pg dw Enter ↑ ↓
    
```



```

*Z/GTZ* 02-06-1999 03:04
Z      EMPLOYEE
EMPLOYEE COD 0

Please input Employee code.
0.00

Pg up Pg dw Enter ↑ ↓
    
```



Select an item you want to edit from the screen using the cursor key, enter time, then depress the [ENTER] key. In this case, the clock-out time is changed from 17:40 to 18:40. A symbol “**” is displayed at the right of the edited time and “TOTAL HOURS” is automatically recalculated.

Enter an employee code, then depress the [ENTER] key. The screen shown below appears.

```

*Z/GTZ* 02-06-1999 03:04
Z      EMPLOYEE
0001 0001
01 CASHIER
IN      09:30
OUT     18:40**
TOTAL BREAK 00:10
TOTAL HOURS 09:00

Please input data.
0.00

Pg up Pg dw Enter ↑ ↓
    
```



```

*Z/GTZ* 02-06-1999 03:04
Z      EMPLOYEE
0001 0001
01 CASHIER
IN      09:30
OUT     17:40
TOTAL BREAK 00:10
TOTAL HOURS 08:00

Please input data.
0.00

Pg up Pg dw Enter ↑ ↓
    
```

NOTE: You can designate and enter the date before the time entry, if necessary. A program option allows you to select the date order as follows.

- Month-Day-Year (Initial Date Order)
- Day-Month-Year
- Year-Month-Day

4.3 Combination Reports

You can issue a combination report which consists of a maximum of 5 reports selected from the list shown below, and you can program your own 3 combination reports. As for the programming, refer to the next chapter PROGRAMMING OPERATIONS.

REPORT NAME	REPORT AVAILABLE			
Financial Report	X	Z	GTX	GTZ
All Cashier Report	X	Z	GTX	GTZ
Credit Company Sales Report	X	Z	GTX	GTZ
Department Group Report	X		GTX	
Media Sales and In-drawer Report	X			
Hourly Range Report	X	Z		
All Department Report	X	Z	GTX	GTZ
All Media Sales & Cash-in-drawer Report	X			
All PLU Report	X	Z	GTX	GTZ
All PLU Stock Report	X			
All Guest File Report	X	Z		
PLU Group Sales Report	X	Z	GTX	GTZ
Day Part Report	X	Z		
Check Track with Sales Report (All Cashier)	X	Z		
Check Track without Sales Report (All Cashier)	X			
All Combo Sale Report (detail)	X	Z		
Hourly Combo Sale Report	X	Z		
Employee Clock-in/Clock-out Report	X	Z		
Employee Clock-in/Clock-out Report (weekly)			GTX	GTZ
Employee Clock-in/Clock-out Report (periodic)			GTX	GTZ

KEY OPERATION: Mode Lock: X for Read Z for Reset → [AT/TL]

Enter the Report No.:

- None (simply depress [AT/TL]): Daily Combination Report 1
- 200: GT Combination Report 1
- 1: Daily Combination Report 2
- 201: GT Combination Report 2
- 2: Daily Combination Report 3
- 202: GT Combination Report 3

* As for the daily combination reports 1 to 3, you can issue them by simply depressing the corresponding navigation keys COMB1 to COMB3.

- NOTES:**
1. If a report in which the issue mode does not match the mode lock position to take a combination report is contained in a combination report table, that report issuance will be skipped.
 2. The all department report and the financial report are initially programmed to the combination report 1 (daily and GT).
 3. Whether the drawer opens or not depends on the reports contained in a combination report table.

4.4 General Notes on Report Takings

1. The cashier signed-OFF or signed-OUT condition is required for taking any X or Z reports in the Code Entry Method. (Otherwise, an error will result when the Mode Lock is turned to the "X" or "Z" position.)
2. The [ITEM CORR] (or [VOID]) key may be depressed anytime during the printing of a report, for the purpose of aborting the receipt issuance. When a report abort has been operated for a reset report, the memory of the report data will not be cleared.
3. The drawer opens at the start of printing for those reports which are noted with "(Drawer opens)" in the Daily and GT report table. However, a program option allows you to take the financial report while the drawer remains closed.

4.5 Report Sample Format

Shown below are sample formats of the respective reports. In referring to those formats, please note the following:

- The data contents are merely examples to show a report format. The numeric data may not balance correctly.

4.5.1 Financial Read or Reset Report (Daily or Periodic)

11 - 29 - 1999 MON #3001			
Z03	Z__FINANCIAL		
GT			1177.40
NET GT			1177.20
GS	161		1177.40
%+		1	0.13
NS	150		990.94
TAX1			37.35
TAX2			61.80
TAX5			4.56
NS	150		1094.65
CHG TIP		1	2.80
HASH DP	1		18.00
%-		2	1.36
DISC		1	0.10
GRATUITY		4	3.21
TOTAL		39CU	1117.20
OPEN TABLE		6CU	184.06
CASH		25CU	481.31
CHECK		0CU	60.00
Chg		7CU	242.59
MISC		0CU	15.00
CPN		0CU	1.00
CRT TL5		2CU	117.45
R/A		2	30.00
PO		1	5.00
LOAN			171.37
PICK UP		1	5.00

See NOTE on the next page.

-- To be continued --

Date, Day-of-Week, Register No.	Percent Discount 2 to 8 on Subtotal Operation Count, Amount if any
Report Symbol, Report Name	
Grand Total	
Net GT	Negative Other
Gross Sale Item Count, Amount	Income
Percent Charge Operation Count, Amount	Department
Net Sale without Tax Item Count, Amount	Item Count, Amount if any
Tax 1 Amount	
Tax 2 Amount	Tax 3 & Tax 4 Amount if any
Manual Tax Amount	
Net Sale with Tax Item Count, Amount	
Charge Tip Operation Count, Amount	
Positive Other Income Department Item Count, Amount	
Percent Discount on Subtotal Operation Count, Amount	
Dollar Discount on Subtotal Operation Count, Amount	
Gratuity Operation Count, Amount	
All Media Sales Customer Count, Amount	
Open Order Table (Unpaid Account) Customer Count, Amount	
Cash Sales Customer Count, Amount	
Check Sales Customer Count, Amount	
Charge Sales Customer Count, Amount	
Misc. Media Sales Customer Count, Amount	
Coupon Sales Customer Count, Amount	
Charge Posting by Check Track Customer Count, Amount	
Received-on-Account Operation Count, Amount	
Paid Out Operation Count, Amount	
Loan Amount	} if selected to print by a program option
Pick Up Operation Count, Amount	
Credit 1 to Credit 4 Sales Customer Count, Amount if any	
Combo Sale Discount Amount if the option "Combo Sale" has been selected.	

-- Continued --

See
NOTE
below

CASH ID		171.37
CHECK ID	4	160.00
Chg ID	7	242.59
MISC ID	3	15.00
CPN ID	1	1.00
CRT ID5	2	117.45
TIP PAID	1	24.50
CORR	2	11.00
VOID	2	13.00
ALL VD	1	49.50
%-	1	0.24
-DP TL	1	3.00
-SALE	2CU	3.00
TXBL1		391.45
TXBL2		904.40
TAX EX	1CU	
TAX1EX		5.00
GUEST	41CU	
CUR1	3	315.96
CUR2	3	115.00
ITEM/CUS	3.85	
NS /CUS		25.41
NO SALE	2	
TRAY_CTR	35	

0001Z

0290 21:54TM

- Cash-in-drawer Amount
- Operation Count & In-drawer Amount for each non-cash media
- Tip Paid Operation Count, Amount
- Item Correct Operation Count, Amount
- Void Operation (for PLU item) Count, Amount
- All Void Operation Count, Amount
- Percent Discount on PLU item Operation Count, Amount
- Negative Department Total Item Count, Amount
- Negative Balance Sale Customer Count, Amount
- Taxable Total 1 (Sale Amount subject to Tax 1 taxation)
- Taxable Total 2 (Sale Amount subject to Tax 2 taxation)
- Tax Exempted Customer Count
- Sale Portion Exempted from Tax 1
- Guest Total
- Foreign Currency 1 Operation Count, Amount
- Foreign Currency 2 Operation Count, Amount
- Sales Item Count per Customer
- Net Sale per Customer
- No-sale Operation Count
- Tray Total Operation Count
- Financial Reset Report Count (printed on the reset report only)
- Receipt Consecutive No., Time
- Eat-in/Takeout Customer Count, Amount if the option "Eat-in/Takeout" has been selected.
- Operation Count & Amount for each Foreign Currency 3 to 5 if any
- Sale Portions Exempted from Tax 2 to 4 if any
- Taxable Total 3 & 4 if any
- Selective Itemizer 1 & 2 Operation Count, Amount if any
- Negative Mode () Operation Count, Amount if any
- Negative Tax Amount if any
- Percent Discount 2 to 8 on PLU item Operation Count, Amount if any
- Dollar Discount on PLU item Operation Count, Amount if any
- Misc. Void Operation (other than PLU item) Count, Amount if any

NOTE: Print items surrounded by a dotted line are printed on a daily report only but not on a periodic report.

4.5.2 Cashier Read or Reset Report (Daily or Periodic)

■ Individual Cashier Read Report Sample

```

11 - 29 - 1999  MON  #3001
X04  X_CLERK
O2  2CLDYER
GS          50          354.90
NS          43          269.00
TAX1                9.40
TAX2                16.64
TAX5                4.56
NS          43          299.60
CHG TIP                1          2.80
DISC                1          0.10
TOTAL                11CU        302.30
OPEN TABLE          3CU         84.40
CASH                5CU         91.10
Chg                3CU        114.31
MISC                0CU          5.00
CPN                0CU          1.00
CASH ID                1.60
Chg ID                3        114.31
MISC ID                1          5.00
CPN ID                1          1.00
TIP PAID                1         24.50
ALL VD                1         49.50
-DP TL                1          3.00
-SALE                1CU          3.00
TXBL1                102.00
TXBL2                245.00
TAX EX                1CU
TAX1EX                5.00
GUEST                12CU
CUR1                1        200.00
ITEM/CUS            3.91
NS /CUS                25.45
TRAY CTR                8
0243  22:33TM
    
```

Cashier Code and Cashier Name

Same contents as the financial report except:

- Data of GT and Net GT is not printed.
- Data of Server Transfer and Tip Percentage, if any, is printed.

4.5.3 Credit Card Company Sales Read or Reset Report (Daily or Periodic)

```

11 - 29 - 1999  MON  #3001
X06  X_CREDIT
O1  CRT01          1          21.97
O2  CRT02          1          50.77
O3  CRT03          1          28.46
TOTAL                3          101.20
0240  22:29TM
    
```

Company Code, Company Name, Operation Count, Amount

Total of Operation Count and Amount

4.5.4 Department Group Read Report (Daily or Periodic)

11 - 29 - 1999 MON #3001				
X08	X_GROUP			
GP01	93	42.01%	413.05	Minor Group 1 Item Count, Sales Percentage, Amount
GP02	50	56.47%	555.26	
GP03	1	1.53%	15.00	
TOTAL	144		983.31	Total of Item Count and Amount
MGP01	44	6.81%	66.95	Major Group 1 Item Count, Sales Percentage, Amount
MGP02	49	35.20%	346.10	
MGP03	34	36.94%	363.26	
MGP04	16	19.53%	192.00	
MGP05	1	1.53%	15.00	
TOTAL	144		983.31	Total of Item Count and Amount
0239 22:29TM				

4.5.5 Media Sales and In-drawer Total Read Report (Daily)

11 - 29 - 1999 MON #3001				
X09	X_MEDIA_ALL			
TOTAL	38CU		1087.57	All Media Sales Customer Count, Amount
CASH	23CU		451.68	Each Media Sale Customer Count, Amount
CHECK	0CU		60.00	
Chg	7CU		242.59	
MISC	0CU		15.00	
CPN	0CU		1.00	
CRT TL5	2CU		117.45	Each Media-in-drawer Operation Count, Amount (operation count for cash is not printed)
CASH ID			141.74	
CHECK ID	4		160.00	
Chg ID	7		242.59	
MISC ID	3		15.00	
CPN ID	1		1.00	Each Foreign Currency-in-drawer Operation Count, Amount
CRT ID5	2		117.45	
CUR1	3		315.96	
CUR2	3		115.00	
0226 22:18TM				

4.5.6 Hourly Range Read or Reset Report (Daily)

11 - 29 - 1999 MON #3001			
X10	X_HOURLY		
10:00TM	8	3CU	63.64
12:00TM	24	6CU	160.53
14:00TM	44	11CU	326.54
16:00TM	19	4CU	174.64
18:00TM	5	1CU	32.76
20:00TM	24	8CU	143.03
22:00TM	19	5CU	167.09
0238 22:28TM			

Hourly Range 10:01 to 12:00
 Item Count, Customer Count, Amount
 Hourly Range 12:01 to 14:00
 Hourly Range 14:01 to 16:00
 Hourly Range 16:01 to 18:00
 Hourly Range 18:01 to 20:00
 Hourly Range 20:01 to 22:00
 Hourly Range 22:01 and thereafter

4.5.7 Department Read or Reset Report (Daily or Periodic)

11 - 29 - 1999 MON #3001			
X11	X_DP_ALL		
DP01	28	2.86%	27.65
DISC		0	0.00
DP02	16	4.06%	39.30
DISC		0	0.00
DP03	19	9.69%	93.80
DISC		0	0.00
DP04	30	26.06%	252.30
DISC		0	0.00
DP05	17	20.94%	202.76
DISC		1	0.24

Department 1
 Item Count, Sales Percentage (NOTE below), Amount
 Dollar Discount or %- Operation Count, Amount (Optional Print)

TOTAL	143		968.31
-TOTAL	1		-3.00
0237 22:27TM			

Total of Positive Departments Item Count, Amount
 Total of Negative Departments Item Count, Amount

NOTE: A program option allows you to print "Customer Count" instead of "Sales Percentage".

4.5.8 All Media Sales Total and Cash-in-Drawer Read Report (Daily)

```

11 - 29 - 1999  MON  #3001
X12  X_MEDIA
TOTAL          38CU  1087.57
CASH ID                141.74

                0227  22:19TM
    
```

All Media Sales Customer Count, Amount
Cash-in-drawer Amount

4.5.9 PLU Read or Reset Report (Daily or Periodic)

■ Individual PLU Read Report (Daily or Periodic)

```

11 - 29 - 1999  MON  #3001
X13  X_PLU_INDIV
000001  PLU000001
P1      27      27.00
P2      0       0.00
P3      1       0.65
P4      0       0.00
P5      0       0.00
TL      28      27.65
000002  PLU000002
P1      15      37.50
P2      0       0.00
P3      1       1.80
P4      0       0.00
P5      0       0.00
TL      16      39.30

TOTAL
P1      42      64.50
P2      0       0.00
P3      2       2.45
P4      0       0.00
P5      0       0.00
TL      44      66.95

                0230  22:22TM
    
```

PLU Code 1, PLU Name

Price Levels 1 ~ 5 Item Count, Amount

Total Item Count, Amount of Price Levels 1 to 5
PLU Code 2 Data

Total Data of PLU Code 1 and PLU Code 2

■ All PLU Read or Reset Report (Daily or Periodic)

```

11 - 29 - 1999 MON #3001
X13      X_PLU_ALL
000001  PLU000001
  P1      27      27.00
  P3      1       0.65
  TL      28      27.65
000002  PLU000002
  P1      15      37.50
  P3      1       1.80
  TL      16      39.30
000003  PLU000003
  P1      18      90.00
  P3      1       3.80
  TL      19      93.80
000004  PLU000004
  P1      27      229.50
  P2      2       15.60
  P3      1       7.20
  TL      30      252.30
000005  PLU000005
  P1      16      192.00
  P2      1       11.00
  TL      17      203.00
    
```

PLU Code 1, PLU Name
 Price Level 1 Item Count, Amount
 Total Item Count, Amount of Price Levels 1 to 5
 PLU Code 2 Data
 PLU Code 3 Data
 PLU Code 4 Data
 PLU Code 5 Data

```

TOTAL
  P1      135     920.00
  P2      4       35.10
  P3      4       13.45
  TL      143     968.55
-TOTAL
  P1      1       -3.00
  TL      1       -3.00
          0232  22:24TM
    
```

Total of Positive PLUs Item Count, Amount
 Total of Negative PLUs Item Count, Amount

NOTE: All PLU Report can be programmed to not print items and price levels having zero totals.

■ Zone PLU Read or Reset Report (Daily or Periodic)

The format is the same as "All PLU Read or Reset Report" above. The only difference is that the Zone Read or Reset Report outputs the PLUs in the zone designated by the key operation to take the report.

```

X13      X_PLU_ZONE
          000001 - 000005
    
```

■ Inactive PLU Read Report (Daily or Periodic)

```

11 - 29 - 1999 MON #3001
X13      X_PLU_ZERO
000015  PLU000015
          0233  22:25TM
    
```

PLU Code, PLU Name

4.5.10 PLU Stock Read Report (Daily)

■ Individual PLU Stock Read Report (Daily)

```

11 - 29 - 1999  MON  #3001
X14  X_STOCK_INDI
000007  PLU000007
                0          348
                0234  22 : 25TM
    
```

PLU Code 7, PLU Name
Minimum Stock Quantity, Current Stock Quantity

■ All PLU Stock Read Report (Daily)

```

11 - 29 - 1999  MON  #3001
X14  X_STOCK_ALL
000004  PLU000004
                0          520
000005  PLU000005
                0          133
000006  PLU000006
                0          433
000007  PLU000007
                0          348
000008  PLU000008
                0          176
                0236  22 : 27TM
    
```

PLU Code 4, PLU Name
Minimum Stock Quantity, Current Stock Quantity

■ Zone PLU Stock Read Report (Daily)

The format is the same as "All PLU Stock Read Report" above. The only difference is that the Zone Read Report outputs the stock data of the PLUs in the zone designated by the key operation to take the report.

```

X14  X_STOCK_ZONE
      000004 - 000007
    
```

Zone designation

4.5.11 Customer File Read or Reset Report (Daily)

■ Individual Customer File Read Report (Daily)

```

11 - 29 - 1999  MON  #3001
X15  X_CUST_INDIV
#0000000000001  RENO
                1          54.70
                0247  22 : 36TM
    
```

Customer File Code 1, Customer Name
Operation Count, Balance

■ All Customer File Read or Reset Report (Daily)

```

11 - 29 - 1999 MON #3001
X15   X_CUST_ALL
#0000000000001 RENO
                1      54.75
#0000000000002 SMITH
                1      62.75
                0246 22:35TM
    
```

Customer File Code 1, Customer Name
 Operation Count, Balance
 Customer File Code 2 Data

■ Zone Customer File Read or Reset Report (Daily)

The format is the same as "All Customer File Read or Reset Report" above. The only difference is that the Zone Read or Reset Report outputs the data of the customer files in the zone designated by the key operation to take the report.

```

X15   X_CUST_ZONE
      000000000001_000000000010
    
```

■ Inactive Customer File Read Report (Daily)

```

11 - 29 - 1999 MON #3001
X15   X_CUST_ZERO
#0000000000003 BECKHAM
#0000000000004 JOHNSON
#0000000000005 SHEARER
                0249 22:37TM
    
```

Customer File Code, Customer Name

4.5.12 PLU Group Read or Reset Report (Daily or Periodic)

```

11 - 29 - 1999 MON #3001
X24   X_PLU_GROUP
PLU GP01      44      6.81%      66.95
PLU GP02      49     35.19%     346.10
PLU GP03      34     36.96%     363.50
PLU GP04      16     19.52%     192.00
PLU GP05       1      1.53%      15.00
TOTAL      144
                0250 22:37TM
    
```

PLU Group 1
 Item Count, Sales Percentage, Amount

Total of Item Count and Amount

4.5.13 Day Part Read or Reset Report (Daily)

11 - 29 - 1999 MON #3001		
X25	X_DAY_PART	
10 : OOTM		
MGP01		
	11	15.50
MGP02	13	93.00
MGP03	4	45.50
MGP04	4	52.00
MGP05	1	15.00
14 : OOTM		
MGP01	16	20.95
MGP02	20	145.10
MGP03	19	196.00
MGP04	8	92.00
18 : OOTM		
MGP01	17	30.50
MGP02	16	108.00
MGP03	11	121.76
MGP04	4	48.00
0251 22:37TM		

Hourly Range 10:01 to 14:00
Major Group 1
Item Count, Amount

Hourly Range 14:01 to 18:00

Hourly Range 18:01 and thereafter

4.5.14 Check Track (Guest Order Table) with Sales Read or Reset Report (Daily)

■ Individual Cashier Read Report Sample

11 - 29 - 1999 MON #3001		
X30	X_CT_W_INDI	
O2	2CLDYER	
	#018	43.40
	#021	32.50
	#025	8.50
TOTAL	3	84.40
0253 22:38TM		

Cashier Code, Cashier Name
Order Table No., Amount remaining unpaid

4.5.15 Check Track (Guest Order Table) without Sales Read Report (Daily)

■ Individual Cashier Read Report Sample

```

11 - 29 - 1999 MON #3001
X31 X_CT_WO_INDI
O2 2CLDYER
    #003 #004 #005 #011
    #015
TOTAL 5
0256 22:40TM
    
```

Cashier Code, Cashier Name
Reserved Order Table
Total of reserved Order Table

4.5.16 Combo Sales Read or Reset Report (Daily)

Available only when the feature "Combo Sales" has been selected.

■ Combo Sales Total Read or Reset Report (Daily)

```

11 - 29 - 1999 MON #3001
X43 X_COMBO_SUM
COMBO TOTAL 1235.12
           100 423.89
0121 20:30TM
    
```

Combo Sales Total
Total of Operation Count and Combo Discount Amount

■ Combo Sales Detail Read or Reset Report (Daily)

```

11 - 29 - 1999 MON #3001
X43 X_COMBO_ALL
O1 COMB01 98.56
    9 21.20
O2 COMB02 153.41
    5 43.00
    
```

Combo Code, Combo Name, Combo Sales Amount
Operation Count, Combo Discount Amount

```

COMBO TOTAL 1235.12
           100 423.89
0122 20:30TM
    
```

Combo Sales Total
Total of Operation Count and Combo Discount Amount

■ Individual Combo Sale Read Report (Daily)

11 - 29 - 1999 MON #3001		
X43	X_COMBO_INDI	
01	COMBO1	98.56
		21.20
	9	
COMBO TOTAL		98.56
	9	21.20
0123 20:30TM		

Combo Code, Combo Name, Combo Sales Amount
Operation Count, Combo Discount Amount

Combo Sales Total
Total of Operation Count and Combo Discount Amount

4.5.17 Hourly Range Combo Sales Read or Reset Report (Daily)

Available only when the feature "Combo Sales" has been selected and also a combo sale table has been linked to each hourly range.

11 - 29 - 1999 MON #3001		
X44	X_COMBO_PERI	
10:00TM		
COMBO TOTAL		96.24
	9	41.12
11:00TM		
COMBO TOTAL		100.62
	9	48.28

Hourly Range 10:01 to 11:00
Combo Sales Amount
Operation Count, Combo Discount Amount

COMBO TOTAL		324.28
	56	198.22
0124 20:31TM		

Combo Sales Total
Total of Operation Count and Combo Discount Amount

4.5.18 Employee Clock-in/Clock-out Read or Reset Report (Daily, Weekly or Periodic)

```

11 - 29 - 1999  MON  #3001
X47  X_EMPLOYEE
0001  JONES
  01  CASHIER
      CLOCK IN           09 : 30
      CLOCK OUT          22 : 30
      TOTAL BREAK        04 : 09
      TOTAL HOURS        08 : 51
      *****
  01  CASHIER
      REGULAR HOUR       08 : 00
      O/T HOURS          00 : 51
      *****
      TOTAL
      REGULAR HOUR       08 : 00
      O/T HOURS          00 : 51
  
```

Employee Code, Employee Name
 Job Code, Job Name
 Job Start Time
 Job End Time
 Break Hours Total on each Job
 Working Hours Total on each Job

 Regular Working Hours on each Job
 Overtime Hours on each Job

 Regular Working Hours Total
 Overtime Hours Total

```

0005  FELDER
  03  COOK
      CLOCK IN           09 : 33
      CLOCK OUT          22 : 12
      TOTAL BREAK        00 : 00
      TOTAL HOURS        12 : 39
      *****
  03  COOK
      REGULAR HOUR       08 : 00
      O/T HOURS          04 : 39
      *****
      TOTAL
      REGULAR HOUR       08 : 00
      O/T HOURS          04 : 39
      0251  22 : 37 TM
  
```

4.5.19 Electronic Journal Read or Reset Report (Daily)

■ **All Electronic Journal Read or Reset Report (Daily)**

```

11-29-1999 MON #3001
X50 X_EJ_ALL
11-29-1999 MON #3001
*CLOCK IN * 1
0001 1 09:30
0066 09:30TM
11-29-1999 MON #3001
*CLOCK IN * 2
0002 1 09:31
0067 09:31TM
11-29-1999 MON #3001
*CLOCK IN * 3
0003 1 09:31
0068 09:31TM
11-29-1999 MON #3001
    
```

```

X47 X_EMPLOYEE
0261 22:44TM
11-29-1999 MON #3001
X248 GTX_EMPLOYEE
0262 22:45TM
0263 22:45TM
    
```

All the data stored in the electronic journal buffer memory is printed.

■ **Electronic Journal (Consecutive No./Date) Read Report (Daily)**

```

X50 X_EJ_CONSNO
    
```

Data corresponding to the designated consecutive No./date is printed.

■ **Electronic Journal (All Guest Check) Read Report (Daily)**

```

X50 X_EJ_INVOICE
    
```

Data of all the guest checks is printed.

■ **Electronic Journal (Cashier/Date) Read Report (Daily)**

```

X50 X_EJ_CLERK
    
```

Data corresponding to the designated cashier/date is printed.

■ Electronic Journal (Clock-in & Clock-out/Date) Read Report (Daily)

```
X50      X_EJ_EMPLOYE
```

Data regarding the employee clock-in/clock-out is printed.

■ Electronic Journal (Transmission History) Read Report (Daily)

```
X50      X_EJ_HISTORY
```

Data of the transmission history is printed.

4.6 GT Reports

The print form and items of a GT report are the same as those of its corresponding daily report, except the report header portion. Please also note that some items provided in the daily report are not provided in its GT reports. The counters and totals in a GT report are records accumulated for a certain period (week, month, etc.) while those counters and totals in the daily report are usually records for a day. The accumulated record data in each GT report will be reset when its GTZ report has been taken.

Header Example

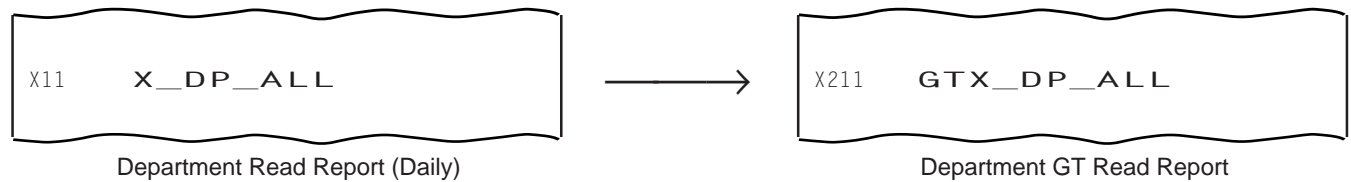

5. PROGRAMMING OPERATIONS

This chapter is provided for the store programmer or the store manager who may have to change the programmed data of the FS-2600 series ECR on the daily, weekly, or monthly basis. Usually, all the basic program data required for your store should have already been set before delivery of the product by your local TOSHIBA TEC representative. However, if it becomes necessary to change or add program data, please refer to this chapter. It is also recommended that you read the OPERATOR'S GUIDE as well as other chapters of the MANAGER'S GUIDE in order to thoroughly understand the descriptions in this chapter. If there are any unclear points or program data other than listed here that must be changed or added, please contact your TOSHIBA TEC representative.

WARNING!

Never try to access a program item other than those shown in this chapter. If you access it and mistakenly change important data, a malfunction may occur on your completed system.

5.1 Before you enter the SET Mode

Please note that you should use the REG Mode Keyboard Sheet or the SET Mode Keyboard Sheet that is proper for each program item. The SET Mode Keyboard Sheet is printed on the reverse side of the REG Mode Keyboard Sheet. Refer to the following list.

5.1.1 Program items that require the REG Mode Keyboard Sheet

- PLU Stock Loading and Changing (Submode 24)
- PLU Preset-code Key and Display Key Setting (Submode 27)
- PLU Preset Price Setting and Changing (Submode 60)
- %+ and %- Rate Setting
- Selective Itemizer Rate Setting
- Foreign Currency Exchange Rate Setting
- Store/Register No. Setting

5.1.2 Program items that require the SET Mode Keyboard Sheet

- Store Name/Message, Commercial Message, Footer Logo Message Programming (Submode 1)
- Cashier Programming (Submode 2)
- Department Table Programming (Submode 3)
- PLU Table Setting (Submode 4)
- Time Setting and Adjustment (Submode 5)
- Date Setting and Adjustment (Submode 6)
- Hourly Range Setting (Submode 7)
- Amount Limit Setting for Function Keys and Guests (Submode 8)
- Non-taxable Limit Amount and Gratuity Rate Setting (Submode 12)
- Minor Group Name Programming (Submode 13)
- Major Group Name Programming (Submode 14)
- Guest File Table Setting (Submode 15)
- Combination Report Table Programming (Submode 19)
- Tare Table and Scale Unit Weight Programming (Submode 26)
- PLU Group Name Programming (Submode 29)
- RKP Message Programming (Submode 30)
- Display Message Programming (Submode 31)
- Amount Limit Setting for the **[DISC]** Key (Submode 35)
- Set Menu Table Programming (Submode 42)
- Combo Sale Table Programming (Submode 43)
- Guest Check Commercial Message Programming (Submode 45)

- Day Part Setting (Submode 46)
- Employee Table Setting (Submode 50)
- Job Code/Working Hour Setting (Submode 51)
- Tender Up Table Setting (Submode 52)
- Display Menu Table Setting (Submode 53)
- Printer Setting (Submode 71)

5.2 Character Entries

Two ways are available to enter characters for the various names and messages; character code entry method and direct character entry method.

CHARACTER CODE ENTRY Method

This method is to set a character by entering a Character Code and depressing the [#] key.

DIRECT CHARACTER ENTRY Method

This method is to set a character by directly depressing a character key which has been printed on the SET mode keyboard sheet.

5.2.1 Character Code Entry Method

■ Character Code Table

Column Code →

Row Code ↓		2	3	4	5	6	7	8	9	10	11	12	13	14	15
	00		0	@	P	`	p			▨	á	Å	\		→
	01	!	1	A	Q	a	q			°	é	å			←
	02	"	2	B	R	b	r			Γ	í	Ø			↓
	03	#	3	C	S	c	s			J	ó	ø			↑
	04	\$	4	D	T	d	t			,	ú	Æ	—		1/2
	05	%	5	E	U	e	u			•	â	æ	Ð		1/4
	06	&	6	F	V	f	v			Ä	ê	Œ	ð		★
	07	'	7	G	W	g	w			Ë	î	œ	€		◇
	08	(8	H	X	h	x			Ö	ô	β			kg
	09)	9	I	Y	i	y			Ü	û	ç			lb
	10	*	:	J	Z	j	z			É	à	£			No
	11	+	;	K	[k	{			ä	è	Φ			x
	12	,	<	L	¥	l				ë	ì	Σ			▽
	13	-	=	M]	m	}			ï	ç	÷			△
	14	.	>	N	^	n	~			ö	Ñ	—			□
	15	/	?	O	_	o	☐			ü	ñ	(

NOTE: Characters corresponding to the following codes can be used only for display but not for print.
 715, 1206, 1207, 1214, 1215, 1301, 1302, 1303, 1304, 1500, 1501, 1502, 1503, 1506, 1507, 1508, 1509, 1510, 1512, 1513, 1514, 1515, 1305 (applicable to the TM-300 only)

■ How to Set a Character

- To set a regular-sized character, enter a column code and then a row code, followed by the [#] key.
 ex.) To set “%”, enter 205 and depress [#].
 To set “kg”, enter 1508, and depress [#].
- To set a blank instead of a character, simply depress [#] without a prior code entry, or enter 200 and depress [#].
- Depress the [X] key once prior to a regular-sized character entry, and it will be a double-sized character (a blank will also be double-sized).
 ex.) To set “GROUP”, “G” in double-sized, and “ROUP” in regular-sized:

[X] 407 [#]
G
502 [#]
R
415 [#]
O
505 [#]
U
500 [#]
P

- Depress the [X] key twice prior to the first character code entry to set the entire message line or entered name with all double-sized characters.
 ex.) To set “GROUP” all in double-sized:

[X] [X]
407 [#]
G
502 [#]
R
415 [#]
O
505 [#]
U
500 [#]
P

All Double-sized Declaration

5.2.2 Direct Character Entry Method

■ SET Mode Keyboard Sheet

Detach the keyboard sheet frame from the register, then turn over the REG Mode Keyboard Sheet so that the SET Mode Keyboard Sheet printed on the reverse side can be used.

1	2	3	4	5	6	7	8	9	0	DOUBLE	DOUBLE SHIFT
Q	W	E	R	T	Y	U	I	O	P	CAPS LOCK	SMALL LOCK
A	S	D	F	G	H	J	K	L			
SPACE	Z	X	C	V	B	N	M	,	.		ST
!	#	\$	%	&	'	()				
-	=	@	:	+	/	*		ESC	↑	Enter	NEXT
€	1/2	1/4				ç		←	↓	→	Pg Up
ß	Σ	ú	á	é	ê	â	è	ALL VOID	ITEM CORR	OPEN	Pg Dw
Ä	Ö	Ü	Å	Æ	Ñ	£	¢	#	C		NS
									7	8	9
								X	4	5	6
									1	2	3
								PLU	0	00	.
											ST
								DP#			AT/TL

■ Functions of Keys

[DOUBLE]	Used to enter all the characters of one line in double-size. Depress this key before all character entries.
[DOUBLE SHIFT]	Depress this key prior to a character entry, and it will be a double-sized character. The double-size modification using this key is effective for only one character to follow.
[CAPS LOCK]	Used to enter the capital-letter mode, which is held until [SMALL LOCK] is depressed.
[SMALL LOCK]	Used to enter the small-letter mode, which is held until the [CAPS LOCK] is depressed.
[SPACE]	Depress this key to enter a blank instead of a character.
[←] or [ITEM CORR]	Depressing this key once deletes one character just entered. Subsequent depressions of the key will further delete the characters in the backward direction.
[ESC]	Used to cancel all the characters of one line just entered before the [Enter] key depression.
Character Keys	Simply depress each key corresponding to the required character. Number Keys [1] to [0] located on the top line of the keyboard merely function as character keys (i.e. entered numbers are part of print descriptors but not numeric value of Program No., Address No., Item Code, etc.).

Numeric Keys [.], [00], [0] to [9] (located near the bottom right of the keyboard)

These keys are used to enter codes (Program No., Address No., etc.) . These key entries will not be part of descriptors.

NOTE: *You can enter a character not shown on the SET Mode Keyboard Sheet by the character code entry method.*

5.3 Condition Required for Programming Operations

At the top of each programming operation a "CONDITION" is given. Unless the register satisfies this condition, the programming operations will not be allowed.

There are two types of conditions:

"Any time outside a sale"

It means that the programming operation is allowed when a sale is finalized before going into any other sale entry.

"After ...Reset"

It means that the designated reset report must be taken before entering the programming operation. And an error will result if the operation is attempted without taking the report. However, the words "After ... Reset" do not necessarily mean "immediately after ...".

When the designated reset report has already been taken and then some operations are performed in the SET, X, or Z mode, the condition "After ... Reset" is still satisfied and the programming operation is still allowed.

On the contrary, when the designated reset report has been taken but then some sales data relating to that report's output data are entered in the REG, MGR, or □ mode, the programming operation will no longer be allowed and the same reset report must be taken.

Thus the condition “After ... Reset” indicates that all the sales data relating to the report data must be zero (except non-resettable memory data). Because of this “CONDITION” requirement, the report data will be protected from any inconsistencies of sales data entered in the period from a resetting of the report to another resetting of the same report next time.

5.4 How to Access a Program Item

Same as in the X or Z mode, two ways are available to access a program item; through the operator display and through the keyboard.

5.4.1 How to Access a Program Item through the Operator Display

When you turn the mode selector key to the SET position, the initial screens shown below will appear.

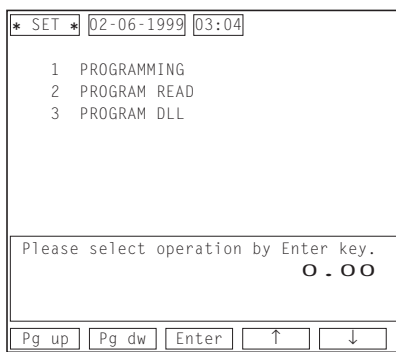

■ Description of each Navigation Key

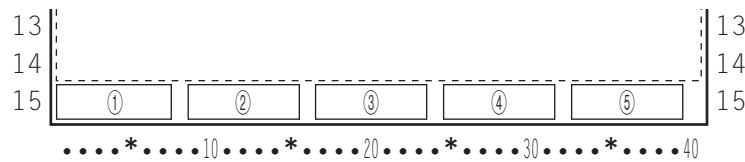

Display Item	Description	
① Navigation Key 1	<input type="button" value="Pg up"/>	Requests the preceding program menu screen.
② Navigation Key 2	<input type="button" value="Pg dw"/>	Requests the next program menu screen.
③ Navigation Key 3	<input type="button" value="Enter"/>	Decides a selected item. Also decides an entered numeric value or character.
④ Navigation Key 4	<input type="button" value="↑"/>	Cursor Key
⑤ Navigation Key 5	<input type="button" value="↓"/>	Cursor key

Example) If you want to perform the time setting or adjustment (submode 5), operate as follows.

Select "1 PROGRAMMING" from the initial screen using the cursor key, then depress the **[ENTER]** key. The program menu screen shown below appears.

* SET *		02-06-1999	03:04
PROGRAMMING			
0 MISC	8 AMOUNT LIMIT		
1 STORE NAME	9 FINANCIAL		
2 CASHIER	10 PRINT L NAME		
3 DEPARTMENT	11 SYSTEM OP1		
4 PLU	12 CA TAX & TIP		
5 TIME	13 MINOR GROUP		
6 DATE	14 MAJOR		
7 HOURLY	15 CUSTOMER		
Please select operation by Enter key.			
0 . 00			
Pg up	Pg dw	Enter	↑ ↓



Select "5 TIME" from the screen using the cursor key, then depress the **[ENTER]** key. The screen shown below appears.

* SET *		02-06-1999	12:34
PROGRAMMING TIME			
01 TIME			12:34
Please input data.			
0 . 00			
Pg up	Pg dw	Enter	↑ ↓



Enter a time value you want to set according to the guidance message "Please input data". (In this case, 1530 for 15:30)

* SET *		02-06-1999	12:34
PROGRAMMING TIME			
01 TIME			12:34
Please input data.			
15 . 30			
Pg up	Pg dw	Enter	↑ ↓



Depress the **[AT/TL]** key to finalize the setting and the screen automatically returns to the program menu screen.

NOTES: 1. Use the **[ESC]** key to return to the program menu screen after finalizing a program item "0 MISC". Using the **[AT/TL]** key in this case causes an error.

2. When you obtain an open-price PLU in the PLU Table Setting (Submode 4), depress the **[OPEN]** key before the **[Enter]** key depression in a step to input a PLU price.
3. If a journal printer is connected to the register, data you have just programmed will be printed on it. No print occurs on a receipt printer, however its data will be stored in the electronic journal buffer memory.

5.4.2 How to Access a Program Item through the Keyboard

You can directly access a program item you want to perform through a key operation on the keyboard.

■ Store Name/Message, Commercial Message, Footer Logo Message Programming (Submode 1)

CONDITION Any time outside a sale

When you enter 1 and depress the **[X]** key, the screen shown below will appear.

OPERATION Mode Lock: SET

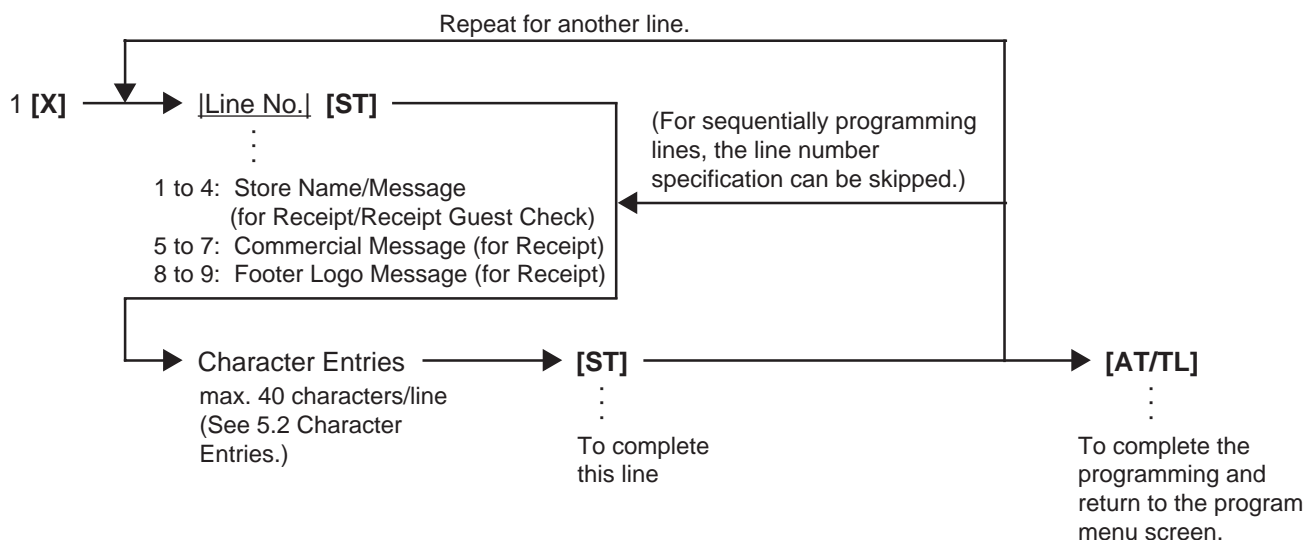
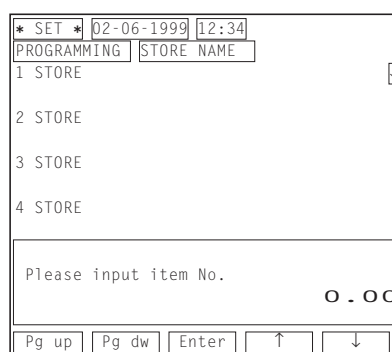

- NOTES:**
1. For each line, a maximum of 40 regular-sized characters or 20 double-sized characters may be entered. A combination of both types is also available.
 2. When you fill one print line with all blanks, the line will be one line space.
 3. If no commercial message is required on a receipt, fill the three print lines assigned to the commercial message with all blanks. As a result, no extra lines will be fed.
 4. As for the four print lines assigned to the store name/message, if you fill the area with all blanks, it will be four lines space.
 5. If your printer is the BRST-10 or the TM-T88, you can make and print your own logo on the store name/message area.
 6. When the program option "Footer Logo Message Print" is selected, a maximum of a 2-line footer logo message can be programmed and it will be additionally printed on a receipt issued for a sales transaction without an order table No. entry.

ex.) To program the following draft on the first line of the store name/message area.

R E S T A U R A N T T E C 1 3 4 3 P E A C H D R I V E

Mode Lock: SET

Enter 1, depress [X].

1 [ST] RESTAURANT [DOUBLE] [SPACE] TEC [DOUBLE] [SPACE]

1343 [SPACE] PEACH [SPACE] DRIVE [ST] [AT/TL]

Journal Print

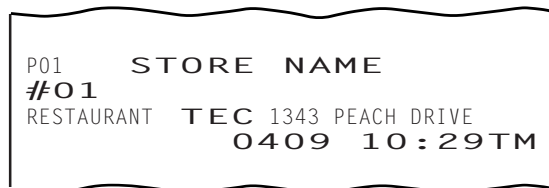

Cashier Programming (Submode 2)

Programming

CONDITION

Any time outside a sale

OPERATION

Mode Lock: SET

When you enter 2 and depress the [X] key, the screen shown below will appear.

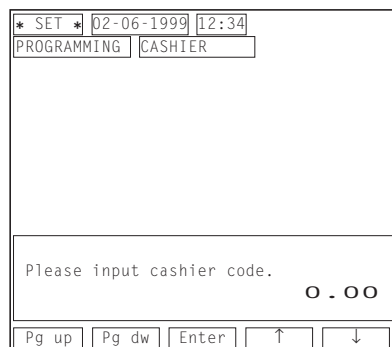

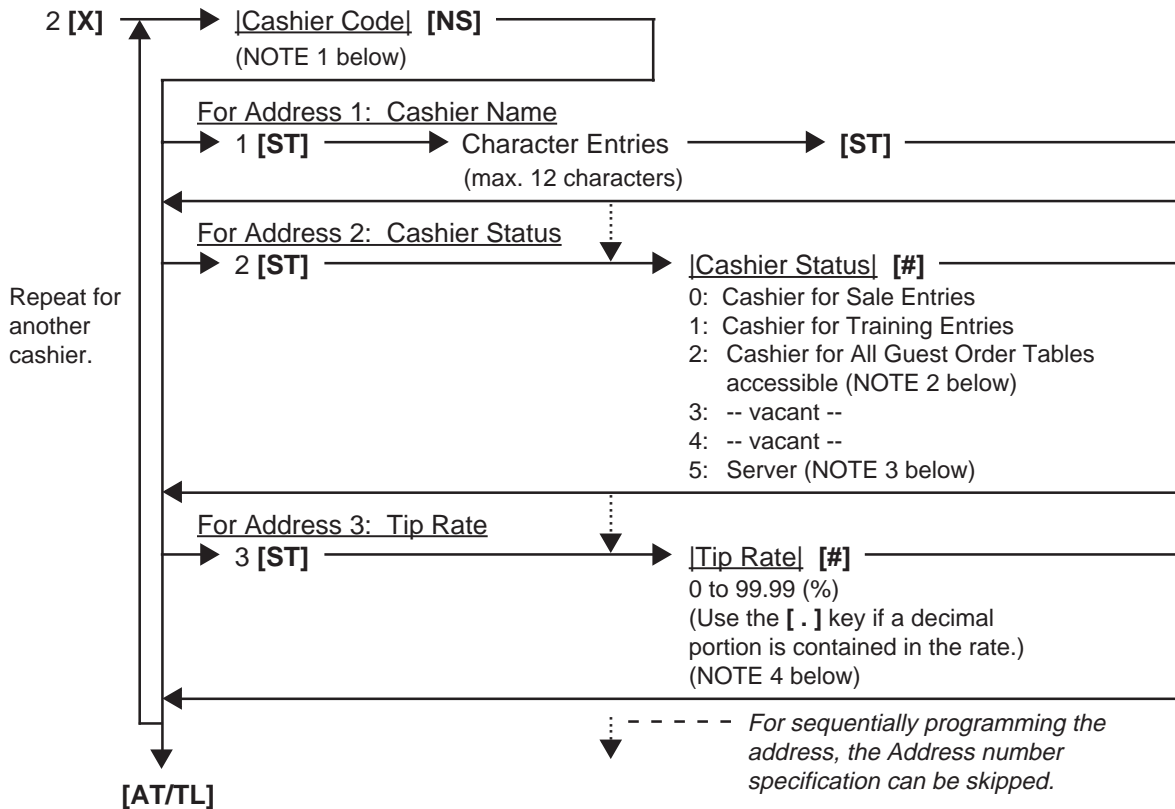

NOTES: 1. The following table shows the Cashier Codes that can be entered. (The capacity is determined by the RAM Allocation Setting.) However, the actual maximum number of the cashiers are preprogrammed. Therefore, ask your TOSHIBA TEC representative for further information.

	Standard Memory	Expansion Memory
Code Entry Type	1 to 15	1 to 99
[CLK] Key Type	1 to 8	---

2. Cashier status 2 (Cashier for All Guest Order Tables accessible) is effective only when the program option "Cashier Exclusive" is selected.
3. A cashier whose status is "server" can only take an order from a guest, but not finalize a sales transaction.
4. The following shows the way to calculate the tip amount:
 $Tip\ Amount = (Net\ Sale\ Without\ Tax) \times (Tip\ Rate)$
5. For a name of each cashier, a maximum of 12 regular-sized or 6 double-sized characters can be entered. A combination of both types is also available.

ex.) To program the following to a cashier code 1.

Cashier Code 1: Name: JONES
 Status: 5 (Server)
 Tip Rate: 3%

Mode Lock: SET

Enter 2, depress [X].

1 [NS] 1 [ST] JONES [ST]

(2 [ST]) 5 [#] (3 [ST]) 3 [#] [AT/TL]

Journal Print

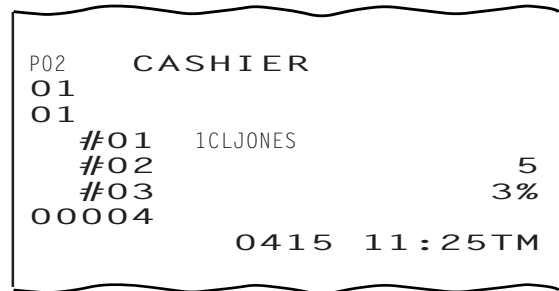

• Deletion

CONDITION

After the Daily and GT Cashier Reset, (A cashier whose code is deleted must be in "Sign OFF" for the code entry type. Furthermore, if the program option "Employee Management System adopted" has been selected, the "Clock OUT" status of that cashier is necessary.)

OPERATION

Mode Lock: SET

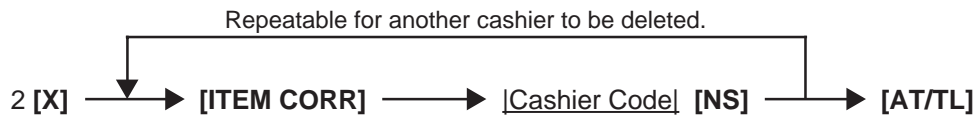

- NOTES:**
1. The Cashier Reset Report Count of the deleted cashier is cleared.
 2. A cashier whose code has been deleted by this operation cannot perform a sign-ON nor a sales transaction.

ex.) To delete the cashier code 1 "JONES".

Journal Print



■ Department Table Programming (Submode 3)

• Programming

CONDITION

To change the Positive/Negative Status:
 After Department Daily & GT and PLU Daily & GT Reset
 To change any other programmed data or to program new departments:
 Any time outside a sale

When you enter 3 and depress the [X] key, the screen shown below will appear.

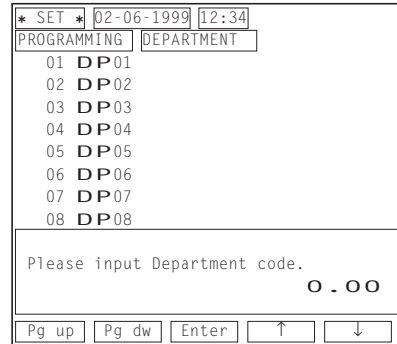

OPERATION

Mode Lock: SET

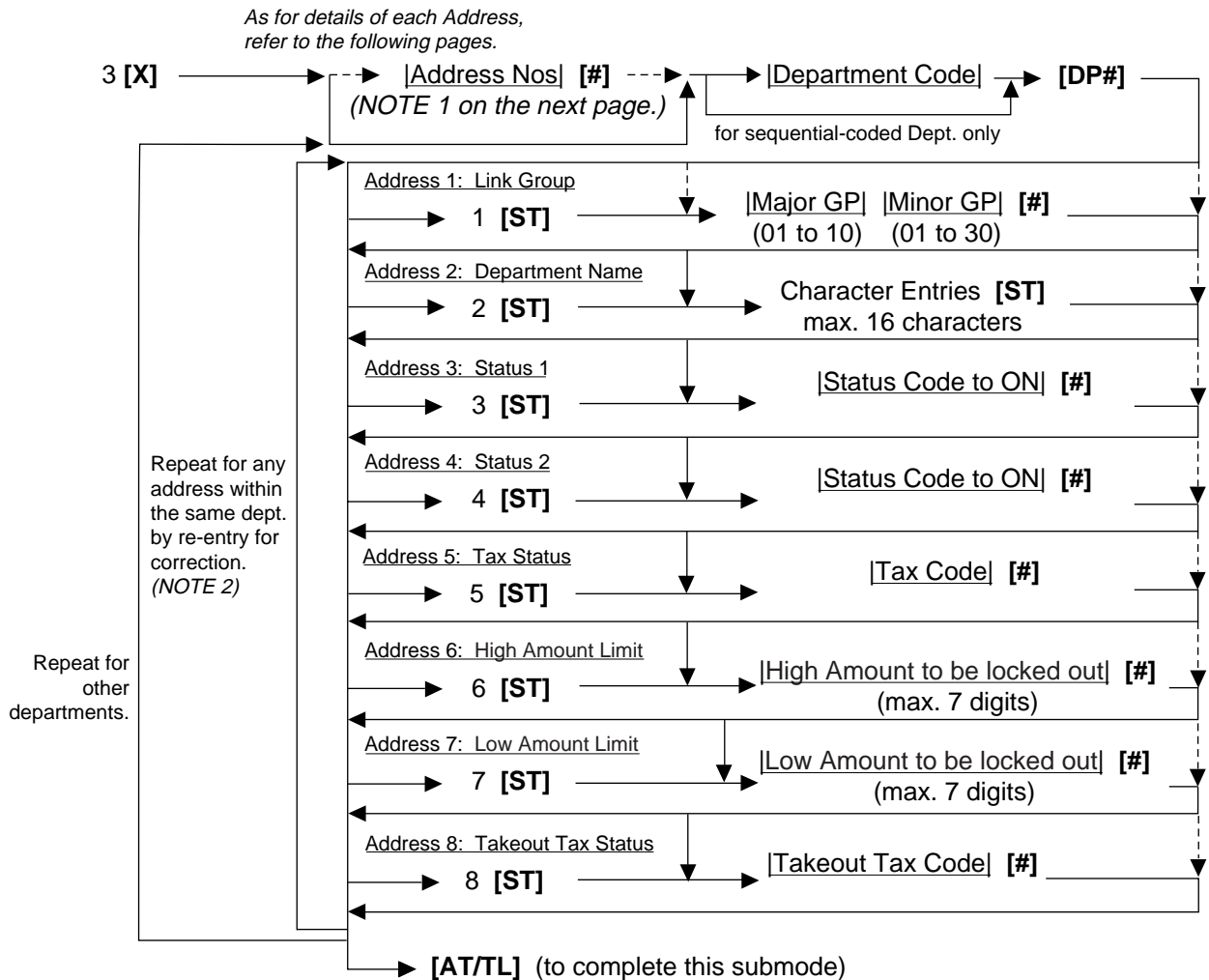

- NOTES:**
1. The "Address Nos" designation at the top after "3 [X]" can be skipped if not necessary. If entered, the designated Address (es) will be automatically accessed after the department designation. For example, if you enter [0204] [#] here (designate each address by entering a two-digit code; 01 for Address 1, 02 for Address 2, you will then enter:
 Dept Code + [DP#] key,
 Character Entries [ST] ("2 [ST]" can be skipped), then
 Status Code for Status 2 Selection [#] ("4 [ST]" can be skipped), then you may go on to another department setting for the same address designations.
 But still in this case, you can go to other addresses by first entering the Address No. and depressing [ST]. The Address Designation feature may be useful when you want to program or change contents of only one or two specific Addresses of multiple departments. (For example, when you want to change only the names, but not any other programmed contents, of 15 departments.)
 2. When the Address No. is sequential from the preceding address (if the Address Designation feature has not been used), the Address No. and the following [ST] can be omitted.
 3. The programming contents of each address are further described in the DEPARTMENT TABLE PROGRAMMING CONTENTS below.

DEPARTMENT TABLE PROGRAMMING CONTENTS

Address No.	Description of Programming Contents									
1	<p><u>Linked Group Code</u> Enter a 4-digit code, composed of a 2-digit Major Group Code and 2-digit Minor Group Code.</p> <div style="margin-left: 40px;"> <table style="border-collapse: collapse;"> <tr> <td style="border: 1px solid black; width: 20px; height: 20px;"></td> <td style="border: 1px solid black; width: 20px; height: 20px;"></td> <td style="padding-left: 10px;">[#]</td> </tr> <tr> <td colspan="2" style="border: none;"></td> <td style="padding-left: 40px;">Minor Group Code 01 to 30</td> </tr> <tr> <td colspan="2" style="border: none;"></td> <td style="padding-left: 20px;">Major Group Code 01 to 10</td> </tr> </table> </div> <p>ex.) To link Major Group No. 1 and Minor Group No. 1: Enter: <u>0</u> <u>1</u> <u>0</u> <u>1</u> Major Group Minor Group Code Code</p> <div style="margin-left: 100px;"> <p>Enter 00 when the department is not linked to any Minor Group.</p> <p>Enter 0 (or 00) when the department is not linked to any Major Group.</p> </div> <p>NOTE: The "Major Group" and "Minor Group" here are merely names for those two grouping total memories. In the memory process, those two totals are independent from the other and no logical check is made for a combination of the Major and Minor group codes to be linked to each department. In other words, you may regard them as "A" grouping and "B" grouping. See the examples on the next page:</p>			[#]			Minor Group Code 01 to 30			Major Group Code 01 to 10
		[#]								
		Minor Group Code 01 to 30								
		Major Group Code 01 to 10								

-- Continued on next page --

Address No.	Description of Programming Contents
-------------	-------------------------------------

-- Continued --

Major-Minor Grouping Method Example:

(In this case, you should check the logical linkage between the Major Groups and Minor Groups.)

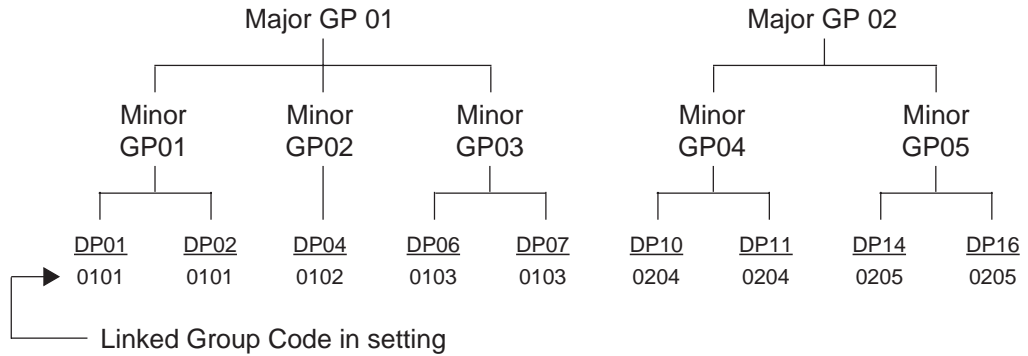

“A” Grouping and “B” Grouping Method Example:

(In this case, you may think that each department data are processed into max. 2 different types of groupings.)

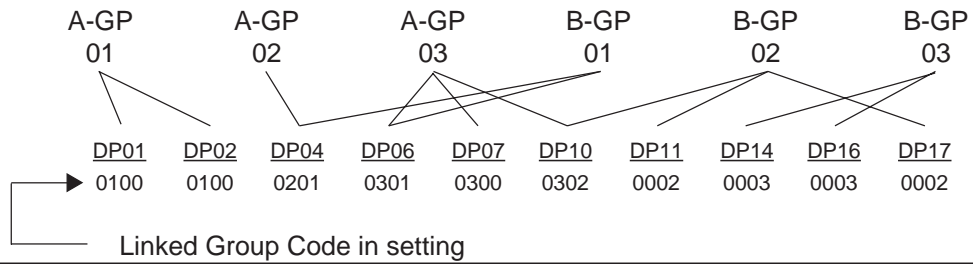

2

Department Name

Enter a maximum of 16 regular-sized or 8 double-sized characters. See the section 5.2 Character Entries. End with **[ST]**.

When no name is programmed for a department, the following will be the auto-program name (initial setting) for printing:

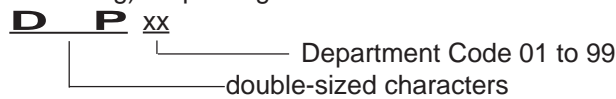

-- Continued on next page --

Address No.	Description of Programming Contents
-------------	-------------------------------------

-- Continued --

3	<p><u>Status 1 Selection</u></p> <ul style="list-style-type: none"> Enter the Status Codes 1 to 3 of which status must be set to ON. More than one code may be entered. Enter 0 when none of the statuses should be set to ON. <table border="1" style="margin-left: 40px;"> <thead> <tr> <th rowspan="2">Status Code</th> <th rowspan="2">Item</th> <th colspan="2">Selective Status</th> </tr> <tr> <th>OFF</th> <th>ON</th> </tr> </thead> <tbody> <tr> <td style="text-align: center;">1</td> <td>Receipt Type</td> <td style="text-align: center;">Single</td> <td style="text-align: center;">Double</td> </tr> <tr> <td style="text-align: center;">2</td> <td>Ordinary or Other Income Dept.</td> <td style="text-align: center;">Ordinary</td> <td style="text-align: center;">Other Income</td> </tr> <tr> <td style="text-align: center;">3</td> <td>Positive or Negative Dept.</td> <td style="text-align: center;">Positive</td> <td style="text-align: center;">Negative</td> </tr> </tbody> </table> <p>NOTE: The selection of Status Code 1 (Receipt Print Type) is effective only when the program option "Receipt Single/Double Print" has been selected.</p> <p>Setting Examples: To set only Status 2 to ON Enter 2 [#] To set Statuses 1, 2 to ON Enter 12 [#] To set none of statuses to ON Enter 0 [#]</p>	Status Code	Item	Selective Status		OFF	ON	1	Receipt Type	Single	Double	2	Ordinary or Other Income Dept.	Ordinary	Other Income	3	Positive or Negative Dept.	Positive	Negative				
Status Code	Item			Selective Status																			
		OFF	ON																				
1	Receipt Type	Single	Double																				
2	Ordinary or Other Income Dept.	Ordinary	Other Income																				
3	Positive or Negative Dept.	Positive	Negative																				
4	<p><u>Status 2 Selection</u></p> <ul style="list-style-type: none"> Enter Status Codes 5 to 8 of which status must be set to ON. More than one code may be entered. Enter 0 when none of the statuses should be set to ON. <table border="1" style="margin-left: 40px;"> <thead> <tr> <th rowspan="2">Status Code</th> <th rowspan="2">Item</th> <th colspan="2">Selective Status</th> </tr> <tr> <th>OFF</th> <th>ON</th> </tr> </thead> <tbody> <tr> <td style="text-align: center;">5</td> <td>Output to RKP-1?</td> <td style="text-align: center;">No</td> <td style="text-align: center;">Yes</td> </tr> <tr> <td style="text-align: center;">6</td> <td>Output to RKP-2?</td> <td style="text-align: center;">No</td> <td style="text-align: center;">Yes</td> </tr> <tr> <td style="text-align: center;">7</td> <td>Output to RKP-3?</td> <td style="text-align: center;">No</td> <td style="text-align: center;">Yes</td> </tr> <tr> <td style="text-align: center;">8</td> <td>Output to RKP-4?</td> <td style="text-align: center;">No</td> <td style="text-align: center;">Yes</td> </tr> </tbody> </table>	Status Code	Item	Selective Status		OFF	ON	5	Output to RKP-1?	No	Yes	6	Output to RKP-2?	No	Yes	7	Output to RKP-3?	No	Yes	8	Output to RKP-4?	No	Yes
Status Code	Item			Selective Status																			
		OFF	ON																				
5	Output to RKP-1?	No	Yes																				
6	Output to RKP-2?	No	Yes																				
7	Output to RKP-3?	No	Yes																				
8	Output to RKP-4?	No	Yes																				
5	<p><u>Tax Status</u></p> <ul style="list-style-type: none"> Enter one-to four-digit Status Codes for applicable Tax. <table style="margin-left: 40px;"> <tr> <td style="border: 1px solid black; width: 20px; height: 20px;"></td> <td style="border: 1px solid black; width: 20px; height: 20px;"></td> <td style="border: 1px solid black; width: 20px; height: 20px;"></td> <td style="border: 1px solid black; width: 20px; height: 20px;"></td> <td style="padding-left: 5px;">[#]</td> </tr> </table> <p style="margin-left: 40px;"> Tax Status</p> <p style="margin-left: 40px;">0: Non-taxable 1: Tax 1 2: Tax 2 3: Tax 3 4: Tax 4</p> <p>(More than one code can be entered for combining 1 to 4 taxable status. For example, enter 12 to select Tax 1 and Tax 2 taxable status.)</p>					[#]																	
				[#]																			

-- Continued on next page --

Address No.	Description of Programming Contents
<i>-- Continued --</i>	
6	<p><u>High Amount Limit</u> Enter a maximum of 7 digits to be set as the high amount to be locked out. ex.) To prohibit any amount equal to or larger than \$40.00: 4000 [#] (Allows any amount equal to or smaller than \$39.99.)</p> <p>NOTES:</p> <ol style="list-style-type: none"> 1. To cancel the preset limit (i.e. to allow any amount), enter 0. 2. The limit amount set here will be applied to entries in REG mode only, but not in MGR or <input type="checkbox"/> mode. 3. Zeros must be entered as all the digits other than the highest digit. If any other value is entered, it will be regarded as a zero. ex.) Entering 4001 to 4999 will all result in setting 4000.
7	<p><u>Low Amount Limit</u> Enter a maximum of 7 digits to be set as the low amount limit. ex.) To allow any amount equal to or larger than \$4.00: 400 [#] (Allows any amount equal to or larger than \$4.00.)</p> <p>NOTES:</p> <ol style="list-style-type: none"> 1. To cancel the preset limit (i.e. to allow any amount), enter 0. 2. The limit amount set here will be applied to entries in REG mode only, but not in MGR or <input type="checkbox"/> mode. 3. Zeros must be entered as all the digits other than the highest digit. If any other value is entered, it will be regarded as a zero. ex.) Entering 401 to 499 will all result in setting 400.
8	<p><u>Takeout Tax Status Setting</u> This tax status is applied to a takeout transaction when the program option "Takeout feature" has been selected. (For an eat-in transaction, a tax status which has been programmed in Address 5 is applied.)</p> <ul style="list-style-type: none"> • Enter one-to four-digit Status Codes for applicable Takeout Tax. _ _ _ _ [#] 0: Non-taxable 1: Tax 1 2: Tax 2 3: Tax 3 4: Tax 4 (More than one code can be entered for combining 1 to 4 taxable status. For example, enter 12 to select Tax 1 and Tax 2 taxable status.)

NOTE: You can use a maximum of 99 departments. The memories of the departments 1 to 30 have already been opened before delivery of the register.
 If you want to open a memory and use a department other than the departments 1 to 30, enter a department code you want to designate, then depress the **[DP#]** key in the key sequence of the Department Table Programming. The memory of the department will be opened automatically.
 When you only want to open a memory other than the departments 1 to 30, operate as follows.

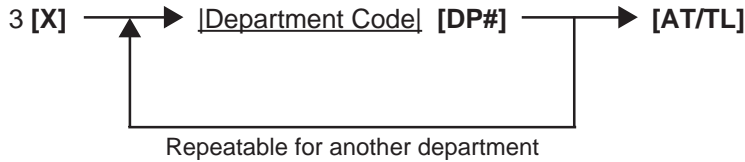

ex.) To program the following to a department code 1.

Department Code 1:	Address 1 (Major Group/Minor Group):	03/11
	Address 2 (Name):	VEGETABLE
	Address 3 (Status 1):	0 (no ON-status)
	Address 4 (Status 2):	7 (Sales data outputted to RKP3)
	Address 5 (Tax Status):	2 (Tax 2 taxable)
	Address 6 (High Amount Limit):	5000 (\$50.00)
	Address 7 (Low Amount Limit):	100 (\$1.00)

Mode Lock: SET

Enter 3, depress **[X]**.

1 **[DP#]** 1 **[ST]** 0311 **[#]** (2 **[ST]**) VEGETABLE **[ST]**

(3 **[ST]**) 0 **[#]** (4 **[ST]**) 7 **[#]** (5 **[ST]**) 2 **[#]** (6 **[ST]**) 5000 **[#]** (7 **[ST]**) 100 **[#]** **[AT/TL]**

Journal Print

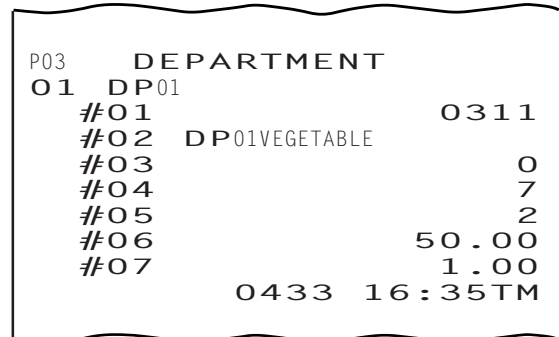

• **Deletion**

CONDITION After Department Daily & GT and PLU Daily and GT Reset

OPERATION Mode Lock: SET

Individual Department Deletion



All Department Deletion

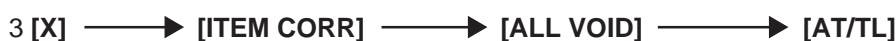

PLU Table Programming (Submode 4)

This submode can be operated when new PLU items are to be added, PLU program data is to be changed, or PLUs are to be deleted.

Programming or Changing

CONDITION

To program new PLUs or to change any programmed contents of PLUs except the following case:

- Any time outside a sale
- To change the linked Department of a PLU with sales data not zero:
- After PLU Reset

When you enter 4 and depress the **[X]** key, the screen shown below will appear.

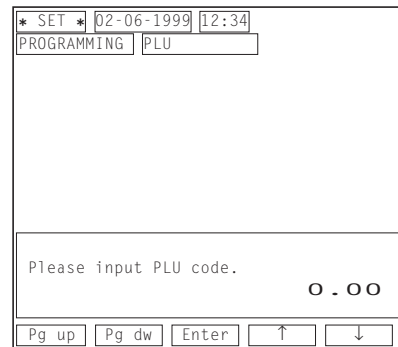

OPERATION

Mode Lock: SET

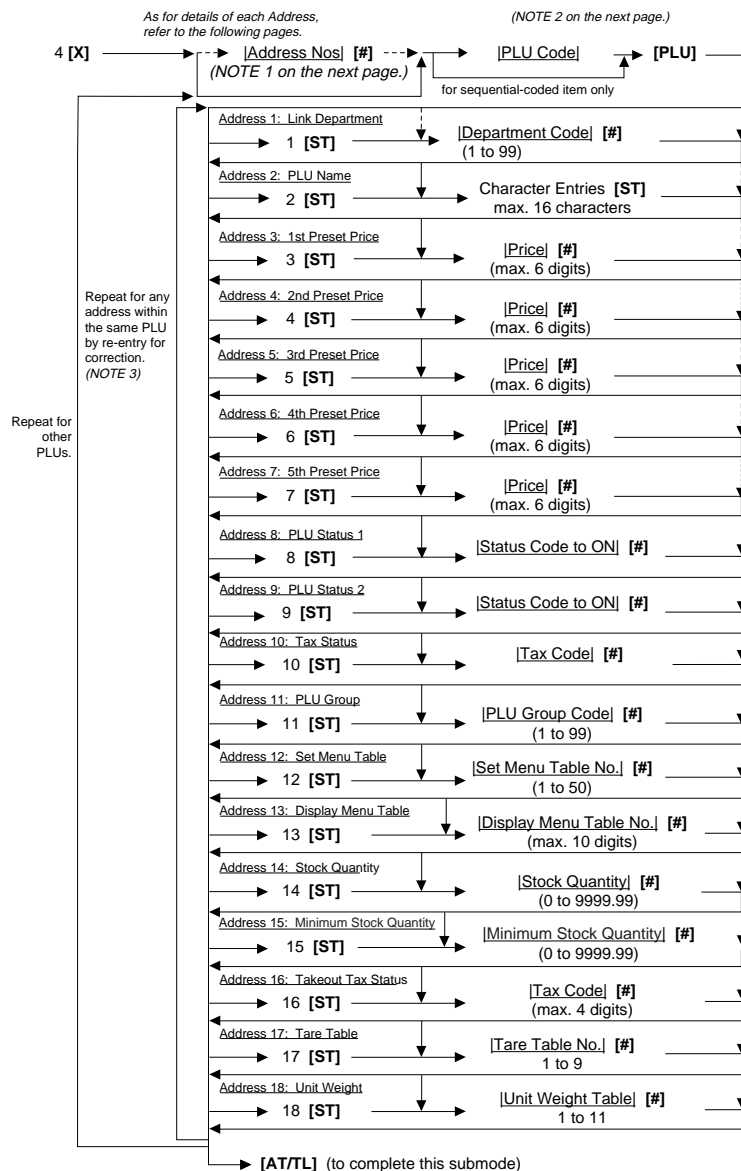

- NOTES:**
1. The "Address Nos" designation at the top after "4 [X]" can be skipped if not necessary. If entered, the designated Address (es) will automatically be accessed after the PLU Code designation.
 2. A maximum of 2500 PLUs are programmable (varies depending on the capacity and allocation of the RAM) . The "[PLU]" key here indicates the key labeled simply as "PLU" but not any PLU Preset-code Keys.
 3. When the Address No. is sequential from the preceding address (if the Address Designation feature has not been used), the Address No. and the following [ST] can be omitted.

PLU TABLE PROGRAMMING CONTENTS

Address No.	Description of Programming Contents
1	<p><u>Linked Department Code</u> Enter the 2-digit code of the department to which the PLU is linked. When a new PLU is programmed, this entry is compulsory (an error will result if this entry is skipped.)</p> <p style="text-align: center;"> <input type="text"/> <input type="text"/> [#] 1 to 99 </p>
2	<p><u>PLU Name</u> Enter a maximum of 16 regular-sized or 8 double-sized characters. See the section 5.2 Character Entries. End with [ST]. When no name is programmed for a PLU, the following will be the auto-program name for printing: PLUxxxxxx <div style="margin-left: 100px;"> <input type="text"/> PLU Code </div></p>
3	<p><u>1st Preset Price</u></p> <ul style="list-style-type: none"> • For a preset PLU (preset-price PLU), enter a maximum of 6-digit price, and depress [#]. 1 to 999999 (result: \$0.01 to \$9999.99) • A zero-price (\$0.00) may be preset by entering 0 in the above operation. • When no numerics are entered and the [#] key is simply depressed, the PLU will be an open PLU (open-price PLU).
4	<p><u>2nd Preset Price</u></p> <ul style="list-style-type: none"> • For a preset PLU (preset-price PLU), enter a maximum of 6-digit price, and depress [#]. 1 to 999999 (result: \$0.01 to \$9999.99) • A zero-price (\$0.00) may be preset by entering 0 in the above operation. • When no numerics are entered and the [#] key is simply depressed, the PLU will be an open PLU (open-price PLU). • If this address entry is skipped, the 1st preset price will be automatically programmed as the 2nd preset price.
5	<p><u>3rd Preset Price</u></p> <ul style="list-style-type: none"> • For a preset PLU (preset-price PLU), enter a maximum of 6-digit price, and depress [#]. 1 to 999999 (result: \$0.01 to \$9999.99) • A zero-price (\$0.00) may be preset by entering 0 in the above operation. • When no numerics are entered and the [#] key is simply depressed, the PLU will be an open PLU (open-price PLU). • If this address entry is skipped, the 1st preset price will be automatically programmed as the 3rd preset price.
6	<p><u>4th Preset Price</u></p> <ul style="list-style-type: none"> • For a preset PLU (preset-price PLU), enter a maximum of 6-digit price, and depress [#]. 1 to 999999 (result: \$0.01 to \$9999.99) • A zero-price (\$0.00) may be preset by entering 0 in the above operation. • When no numerics are entered and the [#] key is simply depressed, the PLU will be an open PLU (open-price PLU). • If this address entry is skipped, the 1st preset price will be automatically programmed as the 4th preset price.

-- Continued on next page --

Address No.	Description of Programming Contents
-------------	-------------------------------------

-- Continued --

7	<p><u>5th Preset Price</u></p> <ul style="list-style-type: none"> For a preset PLU (preset-price PLU), enter a maximum of 6-digit price, and depress [#]. 1 to 999999 (result: \$0.01 to \$9999.99) A zero-price (\$0.00) may be preset by entering 0 in the above operation. When no numerics are entered and the [#] key is simply depressed, the PLU will be an open PLU (open-price PLU). If this address entry is skipped, the 1st preset price will be automatically programmed as the 5th preset price.
---	--

8	<p><u>Status 1 Selection</u></p> <ul style="list-style-type: none"> Enter the Status Codes 1 to 7 of which status must be set to ON. More than one code may be entered. Enter 0 when none of the statuses should be set to ON. <table border="1" style="width: 100%; border-collapse: collapse; text-align: center;"> <thead> <tr> <th rowspan="2">Status Code</th> <th rowspan="2">Item</th> <th colspan="2">Selective Status</th> </tr> <tr> <th>OFF</th> <th>ON</th> </tr> </thead> <tbody> <tr> <td>1</td> <td>Stock Process</td> <td>Non-stock</td> <td>Stock</td> </tr> <tr> <td>2</td> <td>Net to S.I. 1?</td> <td>No</td> <td>Yes</td> </tr> <tr> <td>3</td> <td>Net to S.I. 2?</td> <td>No</td> <td>Yes</td> </tr> <tr> <td>4</td> <td>-- vacant --</td> <td></td> <td></td> </tr> <tr> <td>5</td> <td>Modifier Entry for this PLU</td> <td>Prohibited</td> <td>Allowed</td> </tr> <tr> <td>6</td> <td>This PLU is used as:</td> <td>Menu item</td> <td>Modifier item</td> </tr> <tr> <td>7</td> <td>Lock or Unlock?</td> <td>Unlock (in use)</td> <td>Lock (not in use)</td> </tr> </tbody> </table> <p>Setting Examples: To set only Status 2 to ON Enter 2 [#] To set Statuses 2, 3, 7 to ON Enter 237 [#] To set none of statuses to ON Enter 0 [#]</p>	Status Code	Item	Selective Status		OFF	ON	1	Stock Process	Non-stock	Stock	2	Net to S.I. 1?	No	Yes	3	Net to S.I. 2?	No	Yes	4	-- vacant --			5	Modifier Entry for this PLU	Prohibited	Allowed	6	This PLU is used as:	Menu item	Modifier item	7	Lock or Unlock?	Unlock (in use)	Lock (not in use)
Status Code	Item			Selective Status																															
		OFF	ON																																
1	Stock Process	Non-stock	Stock																																
2	Net to S.I. 1?	No	Yes																																
3	Net to S.I. 2?	No	Yes																																
4	-- vacant --																																		
5	Modifier Entry for this PLU	Prohibited	Allowed																																
6	This PLU is used as:	Menu item	Modifier item																																
7	Lock or Unlock?	Unlock (in use)	Lock (not in use)																																

9	<p><u>Status 2 Selection</u></p> <ul style="list-style-type: none"> Enter the Status Codes 1 to 5 of which status must be set to ON. More than one code may be entered. Enter 0 when none of the statuses should be set to ON. <table border="1" style="width: 100%; border-collapse: collapse; text-align: center;"> <thead> <tr> <th rowspan="2">Status Code</th> <th rowspan="2">Item</th> <th colspan="2">Selective Status</th> </tr> <tr> <th>OFF</th> <th>ON</th> </tr> </thead> <tbody> <tr> <td>1</td> <td>Scale Entry</td> <td>Prohibited</td> <td>Compulsory</td> </tr> <tr> <td>2</td> <td>Manual Tare Entry</td> <td>Optional</td> <td>Compulsory</td> </tr> <tr> <td>3</td> <td>Canada Tax Symbol Print (NOTE below)</td> <td>Non-print</td> <td>Print (A symbol "F")</td> </tr> <tr> <td>4</td> <td>Combo Exemption Flag</td> <td>No</td> <td>Exemption</td> </tr> <tr> <td>5</td> <td>Using the [CODE SHIFT] key for this PLU</td> <td>Possible</td> <td>Not possible</td> </tr> </tbody> </table> <p>NOTES:</p> <ol style="list-style-type: none"> Canada tax symbol is assigned as follows. "T" for the PST, "F" for the GST Status Code 1 (Scale Entry) and Status Code 1 (Stock Process) of the preceding address cannot be combined with one PLU. 	Status Code	Item	Selective Status		OFF	ON	1	Scale Entry	Prohibited	Compulsory	2	Manual Tare Entry	Optional	Compulsory	3	Canada Tax Symbol Print (NOTE below)	Non-print	Print (A symbol "F")	4	Combo Exemption Flag	No	Exemption	5	Using the [CODE SHIFT] key for this PLU	Possible	Not possible
Status Code	Item			Selective Status																							
		OFF	ON																								
1	Scale Entry	Prohibited	Compulsory																								
2	Manual Tare Entry	Optional	Compulsory																								
3	Canada Tax Symbol Print (NOTE below)	Non-print	Print (A symbol "F")																								
4	Combo Exemption Flag	No	Exemption																								
5	Using the [CODE SHIFT] key for this PLU	Possible	Not possible																								

-- Continued on next page --

Address No.	Description of Programming Contents																																										
-- Continued --																																											
16	<p><u>Takeout Tax Status Setting</u> This tax status is applied to a takeout transaction when the program option "Takeout feature" has been selected. (For an eat-in transaction, a tax status which has been programmed in Address 10 is applied.)</p> <ul style="list-style-type: none"> Enter one-to four-digit Status Codes for applicable Takeout Tax. <table style="margin-left: 40px;"> <tr> <td style="border: 1px solid black; width: 20px; height: 20px;"></td> <td style="border: 1px solid black; width: 20px; height: 20px;"></td> <td style="border: 1px solid black; width: 20px; height: 20px;"></td> <td style="border: 1px solid black; width: 20px; height: 20px;"></td> <td style="padding-left: 5px;">[#]</td> </tr> </table> <p style="margin-left: 40px;">0: Non-taxable 1: Tax 1 2: Tax 2 3: Tax 3 4: Tax 4</p> <p style="margin-left: 40px;">(More than one code can be entered for combining 1 to 4 taxable status. For example, enter 12 to select Tax 1 and Tax 2 taxable status.)</p> <p>NOTE: <i>When a tax status has not been programmed to a PLU in this address, the tax status of the PLU is determined by that of a linked department.</i></p>					[#]																																					
				[#]																																							
17	<p><u>Tare Table No.</u> (for Scale-compulsory PLUs only) <table style="margin-left: 40px;"> <tr> <td style="border: 1px solid black; width: 20px; height: 20px;"></td> <td style="padding-left: 5px;">[#]</td> </tr> </table> </p> <p>Enter the Tare Table No. (1 to 9). The content of each Tare Table is set later in a separate operation (Submode 26). In a scale item entry of a PLU with a Tare Table No. set, the tare weight preset in the Tare Table will automatically be subtracted from the total weight read from the scale. Enter 0 to cancel a Tare Table No. once set. Or skip this address setting for PLUs not needing any tare weight calculations.</p>		[#]																																								
	[#]																																										
18	<p><u>Individual PLU Unit Weight Table Code</u> (for Scale-compulsory PLUs only) <table style="margin-left: 40px;"> <tr> <td style="border: 1px solid black; width: 20px; height: 20px;"></td> <td style="border: 1px solid black; width: 20px; height: 20px;"></td> <td style="padding-left: 5px;">[#]</td> </tr> </table> </p> <table style="margin-left: 40px; border-collapse: collapse;"> <thead> <tr> <th style="text-align: left;"></th> <th style="text-align: left;"><u>LB unit</u></th> <th style="text-align: left;"><u>Kg unit</u></th> </tr> </thead> <tbody> <tr> <td>0:</td> <td colspan="2"><i>General Unit Weight (set in Submode 26)</i></td> </tr> <tr> <td>1:</td> <td>1 LB</td> <td>1 Kg</td> </tr> <tr> <td>2:</td> <td>2 LB</td> <td>2 Kg</td> </tr> <tr> <td>3:</td> <td>3 LB</td> <td>3 Kg</td> </tr> <tr> <td>4:</td> <td>4 LB</td> <td>4 Kg</td> </tr> <tr> <td>5:</td> <td>5 LB</td> <td>5 Kg</td> </tr> <tr> <td>6:</td> <td>6 LB</td> <td>6 Kg</td> </tr> <tr> <td>7:</td> <td>7 LB</td> <td>7 Kg</td> </tr> <tr> <td>8:</td> <td>8 LB</td> <td>8 Kg</td> </tr> <tr> <td>9:</td> <td>9 LB</td> <td>9 Kg</td> </tr> <tr> <td>10:</td> <td>1/2 LB</td> <td>100 g</td> </tr> <tr> <td>11:</td> <td>1/4 LB</td> <td><i>not applicable</i></td> </tr> </tbody> </table> <p>NOTE: <i>Whether the ECR adopts the LB or Kg unit system is determined by a program option selection.</i></p>			[#]		<u>LB unit</u>	<u>Kg unit</u>	0:	<i>General Unit Weight (set in Submode 26)</i>		1:	1 LB	1 Kg	2:	2 LB	2 Kg	3:	3 LB	3 Kg	4:	4 LB	4 Kg	5:	5 LB	5 Kg	6:	6 LB	6 Kg	7:	7 LB	7 Kg	8:	8 LB	8 Kg	9:	9 LB	9 Kg	10:	1/2 LB	100 g	11:	1/4 LB	<i>not applicable</i>
		[#]																																									
	<u>LB unit</u>	<u>Kg unit</u>																																									
0:	<i>General Unit Weight (set in Submode 26)</i>																																										
1:	1 LB	1 Kg																																									
2:	2 LB	2 Kg																																									
3:	3 LB	3 Kg																																									
4:	4 LB	4 Kg																																									
5:	5 LB	5 Kg																																									
6:	6 LB	6 Kg																																									
7:	7 LB	7 Kg																																									
8:	8 LB	8 Kg																																									
9:	9 LB	9 Kg																																									
10:	1/2 LB	100 g																																									
11:	1/4 LB	<i>not applicable</i>																																									

ADDITIONAL NOTES

If a PLU is linked to an Other Income Department, the PLU is automatically set as Other Income PLU.

If a PLU is linked to a negative Department, the PLU is automatically set as negative PLU.

Amount Limits (High Amount, Low Amount) of each open-price PLU will be determined by those of its link department.

Receipt type (Itemized receipt or Single/Double receipt) of each PLU will be determined by those of its link department.

Whether or not each PLU data is output to the Remote Kitchen Printers will be determined by the status of its link department.

ex.) To program the following to a PLU code 20.

PLU Code 20: Address 1 (Link Department):	2
Address 2 (Name):	CHEESE BURGER
Address 3 (1st Price):	\$2.00
Address 4 (2nd Price):	\$1.80
Address 8 (Status 1):	5 (Condiment Entry Allowed)
Address 10 (Tax Status):	12 (Tax 1 & 2 taxable)
Address 11 (PLU Group):	3
Address 12 (Set Menu Table No.):	1
Address 13 (Display Menu Table No.):	03 (Table 3)
Address 16 (Takeout Tax Status):	1 (Tax 1 taxable)

Mode Lock: SET

Enter 4, depress [X].

20 [PLU] 1 [ST] 2 [#] (2 [ST]) CHEESE BURGER [ST]
 (3 [ST]) 200 [#] (4 [ST]) 180 [#] 8 [ST] 5 [#] 10 [ST] 12 [#] (11 [ST]) 3 [#] (12 [ST]) 1 [#]
 (13 [ST]) 03 [#] 16 [ST] 1 [#] [AT/TL]

Journal Print

```

P04      PLU
000020  PLU000020
  #01                      02
  #02  CHEESE BURGER
  #03                      2.00@
  #04                      1.80@
  #08                      5
  #10                      12
  #11                      03
  #12                      01
  #13                      03
  #16                      1
00013
                        0003 10:17TM
    
```

• **Deletion**

CONDITION To delete a PLU with sales data of zero: Any time outside a sale
 To delete a PLU with sales data of not zero: After PLU Reset

OPERATION Mode Lock: SET

Individual PLU Deletion

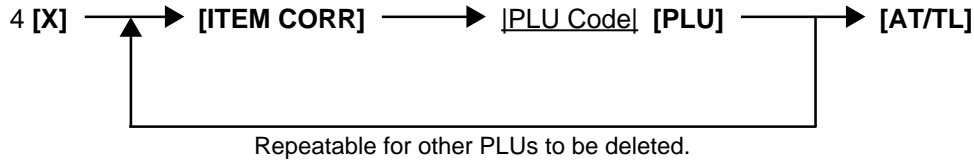

ex.) To delete PLU Code 120001 that was once programmed:
 Mode Lock: SET
 Enter 4, depress [X].

[ITEM CORR] 120001 **[PLU]**
[AT/TL]

Journal Print

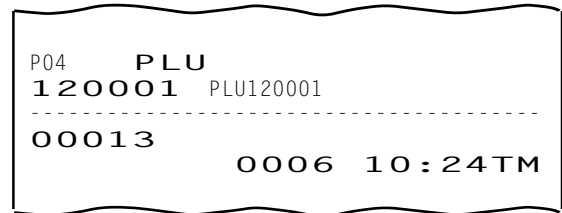

All PLU Deletion

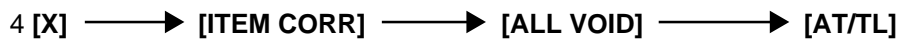

• **PLU Programmed Data Copying**

This operation is used to copy the programmed data of a PLU item and to use it in programming another PLU item, thus eliminating time in PLU programming operation.

CONDITION To program new PLUs or to change any programmed contents of PLUs:
 Any time outside a sale (except the following case)
 To change the PLU of the copy-destination with sales data not zero:
 After PLU Reset

OPERATION Mode Lock: SET

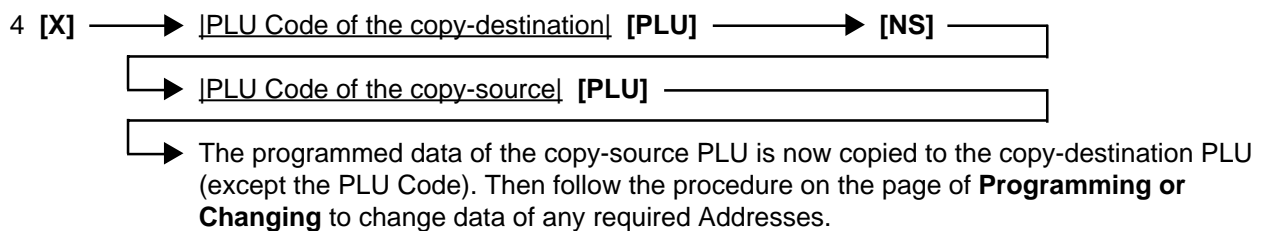

ex.) To program the PLU Code 22 (BIG CHEESE BURGER) by copying the programmed data of the PLU Code 20 (CHEESE BURGER).

Mode Lock: SET, enter 4, depress [X]
 22 **[PLU]** (PLU Code of the copy-destination)
[NS]
 20 **[PLU]** (PLU Code of the copy-source)
 2 **[ST]** BIG CHEESEBURGER **[ST]** (Address 2, Name changed into: BIG CHEESEBURGER)
 3 **[ST]**) 300 **[#]** (Address 3, the 1st price changed into: \$3.00)
 4 **[ST]**) 250 **[#]** (Address 4, the 2nd price changed into: \$2.50)
[AT/TL]

Journal Print

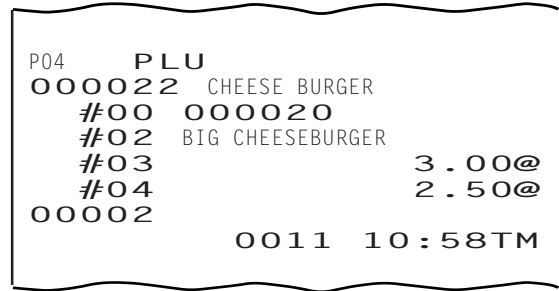

■ Time Setting or Adjustment (Submode 5)

- CONDITION Any time outside a sale
- OPERATION Mode Lock: SET

When you enter 5 and depress the [X] key, the screen shown below will appear.

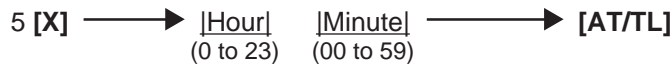
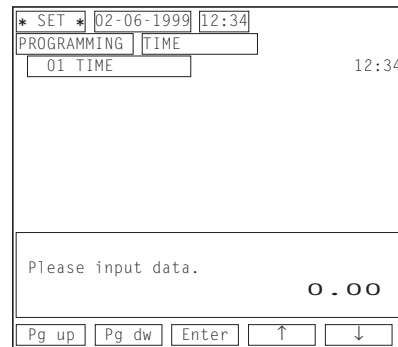

ex.) To set the time to "1:35 p.m. (13:35)":
 Mode Lock to SET, enter 5, depress [X].
 Enter 1335, depress [AT/TL].

Journal Print



NOTE: If an hour value of more than 23 or a minute value of more than 59 is entered, it will result in an error. The current date will not be changed by setting or adjusting the time.

Date Setting or Adjustment (Submode 6)

- CONDITION** Any time outside a sale
- OPERATION** Mode Lock: SET

When you enter 6 and depress the **[X]** key, the screen shown below will appear.

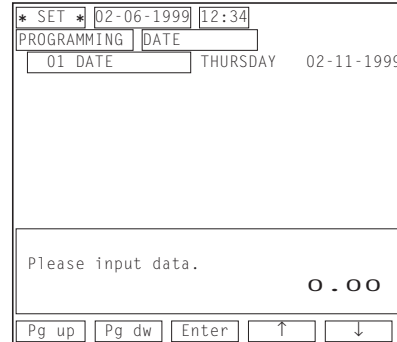

- 6 **[X]** → |Day-of-Week Code| |Month| |Day| |Year| → **[AT/TL]**
 (01 to 12) (01 to 31) (1999, etc.)
- 0: SUN (Sunday)
 - 1: MON (Monday)
 - 2: TUE (Tuesday)
 - 3: WED (Wednesday)
 - 4: THU (Thursday)
 - 5: FRI (Friday)
 - 6: SAT (Saturday)

ex.) To set the date to Tuesday, 21st of December, 1999:
 Mode Lock: SET, enter 6, depress **[X]**
 Enter 212211999, depress **[AT/TL]**

Journal Print

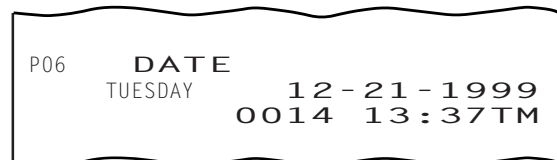

- NOTES:**
1. A program option allows you to select the date order as follows.
 - Month-Day-Year (Initial Date Order)
 - Day-Month-Year
 - Year-Month-Day
 2. The Day-of-week is programmable not to be printed on receipts.

Hourly Range Setting (Submode 7)

A maximum of 48 hourly ranges can be set. You can obtain sales data by each hourly range, also you can designate a price level and a menu level for each day of the week.

CONDITION After Hourly Range Reset and Combo Sale Hourly Range Reset

When you enter 7 and depress the **[X]** key, the screen shown below will appear.

OPERATION Mode Lock: SET

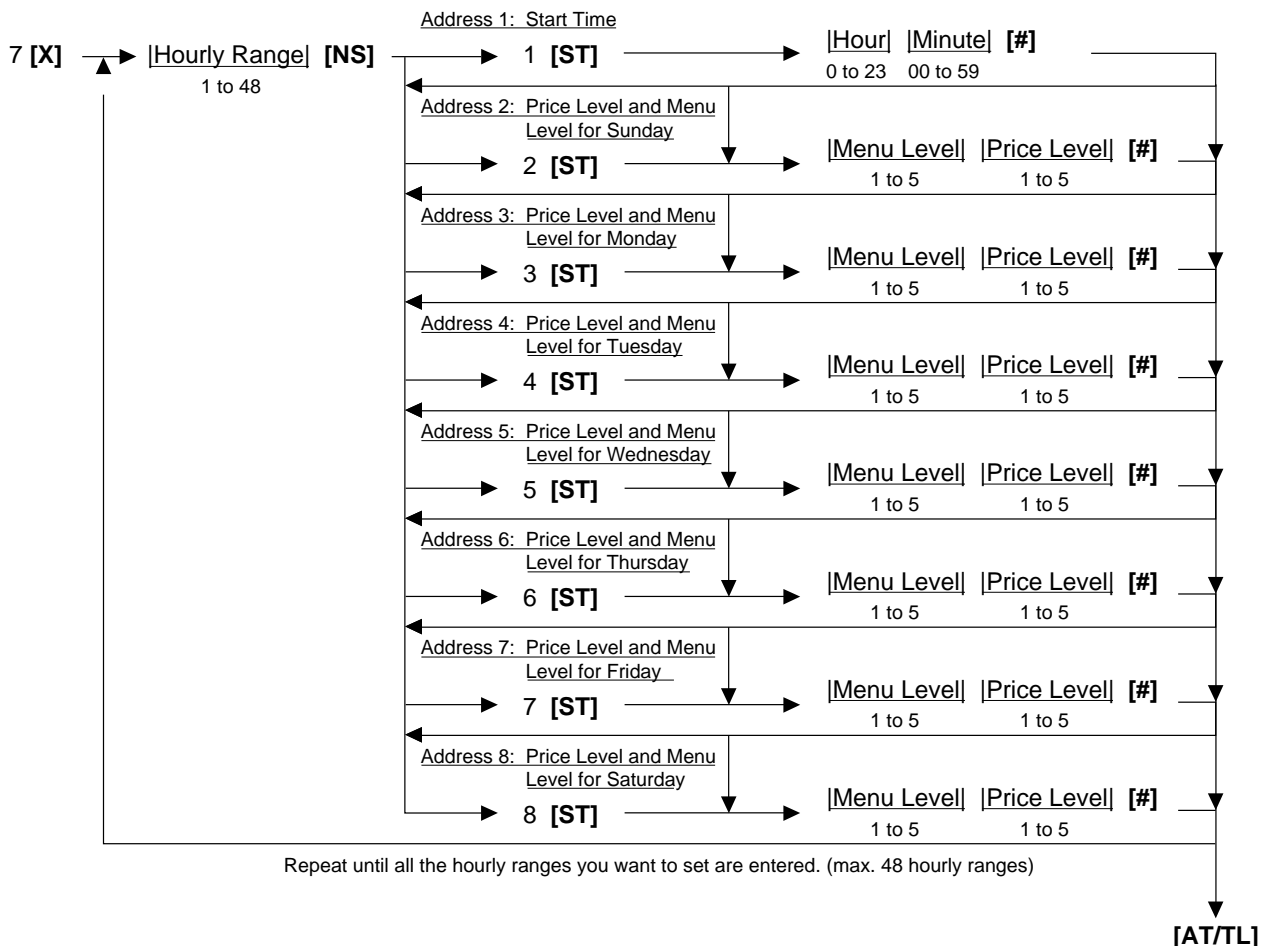
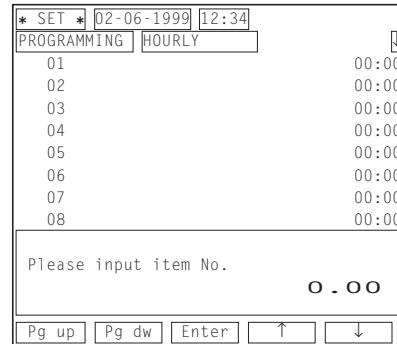

- NOTES:**
1. When you enter only a 1-digit code (1 to 5) for a price & menu level portion, the price level of which code is entered will be designated.
 2. Do not set an hourly range across 24:00, such as "from 23:00 to 1:00". If set, no data will be processed into that hourly range.
 3. To reset the hourly range table once set, operate as follows.
7 [X] 0 [#] [AT/TL]

ex.) To set the following to a hourly range 1.

Hourly Range 1: Address 1 (Start Time): 1000 (10:00)
 Address 2 (Sunday): 55 (Menu Level 5/Price Level 5)
 Address 3 (Monday): 11 (Menu Level 1/Price Level 1)
 Address 4 (Tuesday): 12 (Menu Level 1/Price Level 2)
 Address 5 (Wednesday): 13 (Menu Level 1/Price Level 3)
 Address 6 (Thursday): 23 (Menu Level 2/Price Level 3)
 Address 7 (Friday): 34 (Menu Level 3/Price Level 4)
 Address 8 (Saturday): 45 (Menu Level 4/Price Level 5)

Mode Lock: SET

Enter 7, depress [X].

1 [NS] 1 [ST] 1000 [#] (2 [ST]) 55 [#] (3 [ST]) 11 [#] (4 [ST]) 12 [#] (5 [ST]) 13 [#] (6 [ST]) 23 [#]
 (7 [ST]) 34 [#] (8 [ST]) 45 [#] [AT/TL]

Journal Print

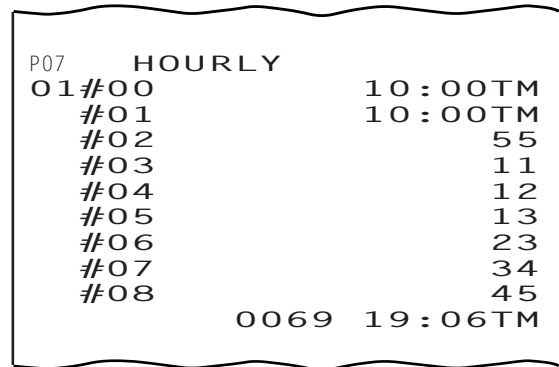

Amount Limit Setting for Function Keys (Submode 8)

This programming is used to set a high or low amount limit for the items shown in the following list.

- CONDITION** Any time outside a sale
- OPERATION** Mode Lock: SET

When you enter 8 and depress the [X] key, the screen shown below will appear.

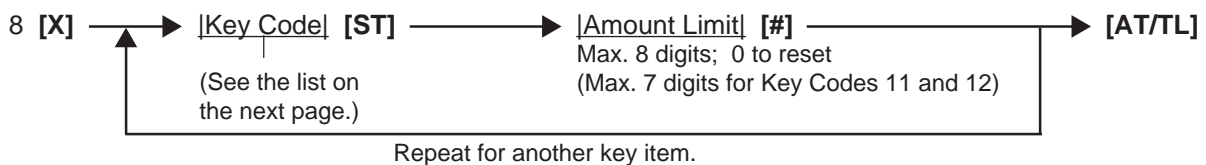
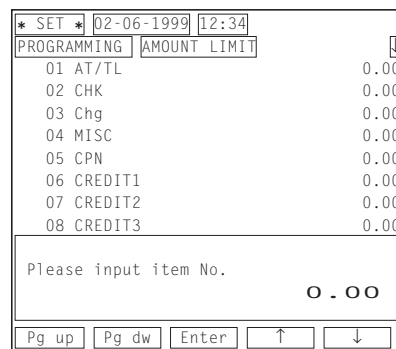

Key Code	Item or Key to be applied
1	[AT/TL] (Cash Tender)
2	[CHECK] (Check Tender)
3	[Chg] (Charge Tender)
4	[MISC] (Misc. Tender)
5	[CPN] (Media-Coupon Tender)
6	[CREDIT 1] (Credit 1 Tender)
7	[CREDIT 2] (Credit 2 Tender)

Key Code	Item or Key to be applied
8	[CREDIT 3] (Credit 3 Tender)
9	[CREDIT 4] (Credit 4 Tender)
10	[CREDIT 5] (Credit 5 Tender)
11	High Amount Limit common to all depts.
12	Low Amount Limit common to all depts.
13	Charge Posting Limit Amount common to all customers

ex.) To set a tender limit amount \$100.00 on the [CHECK] key

Journal Print

Mode Lock: SET
 Enter 8, depress [X].
 2 [ST] 10000 [#] [AT/TL]



- NOTES:**
1. If the individual High or Low Amount Limit of a department has been set, it prevails over the Common High or Low Limit for all departments here.
 2. The Amount Limit Set Value of each tender media is the high amount limit and is effective only when the media key is used for tendering but not when used as total key.

Non-taxable Amount Limit Setting (for Canada)/Gratuity Rate Setting (Submode 12)

This programming is used to set a non-taxable amount limit applied to Ontario, Canada. It is also used to set a gratuity rate.

- CONDITION After Daily Financial Reset
- OPERATION Mode Lock: SET

When you enter 12 and depress the [X] key, the screen shown below will appear.

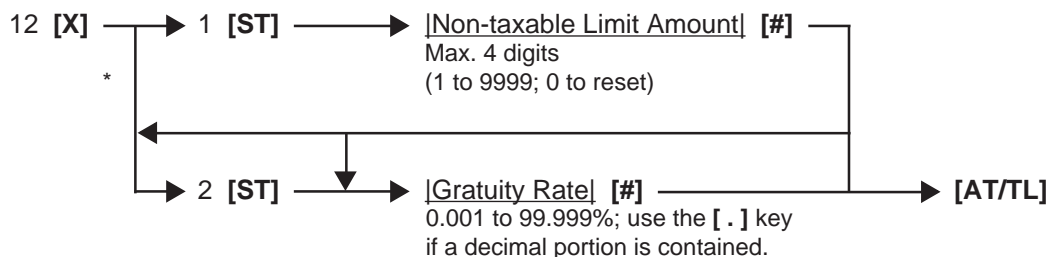
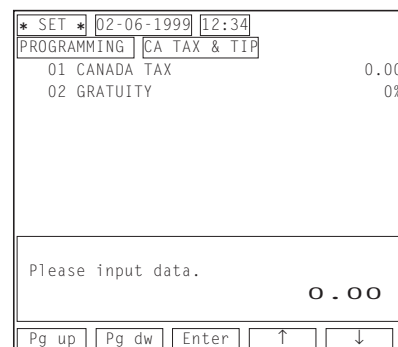

* When a gratuity rate only is programmed

ex.) To set the following

- Non-taxable Amount Limit: \$20.00
- Gratuity Rate: 5%

Mode Lock: SET
 Enter 12, depress [X].
 1 [ST] 2000 [#] (2 [ST]) 5 [#] [AT/TL]

Journal Print



■ Minor Group Name Programming (Submode 13)

This programming is used to set each minor group name. Association among a department, a minor group and a major group should be set in the Department Table Programming (Submode 3).

- CONDITION Any time outside a sale
- OPERATION Mode Lock: SET

When you enter 13 and depress the [X] key, the screen shown below will appear.

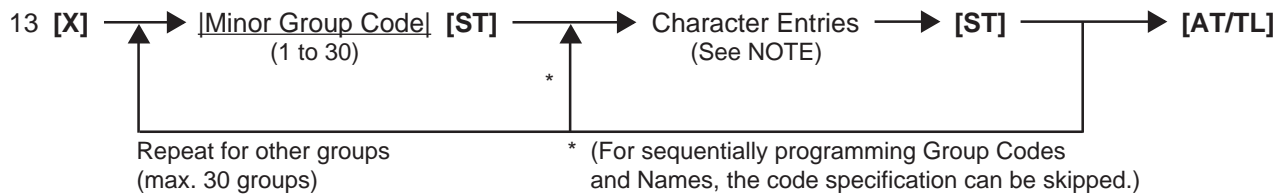
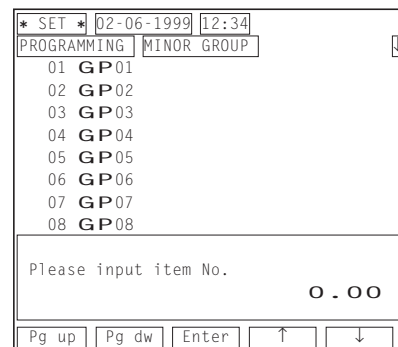

ex.) To set "GREENSTUFF" for a minor group1

Mode Lock: SET
 Enter 13, depress [X].
 1 [ST] GREENSTUFF [ST] [AT/TL]

Journal Print



NOTE: A maximum of 12 regular-sized characters may be set for each Minor Group name. One double-sized character occupies two regular-sized character's space. Also see the CHARACTER ENTRIES at the beginning of this chapter. If no name is programmed for a Minor Group, an auto-preset data is assigned as the Minor Group Name (GPxx; xx = Minor Group Code 01 to 30).

Major Group Name Programming (Submode 14)

This programming is used to set each major group name. Association among a department, a minor group and a major group should be set in the Department Table Programming (Submode 3).

CONDITION Any time outside a sale

When you enter 14 and depress the **[X]** key, the screen shown below will appear.

OPERATION Mode Lock: SET

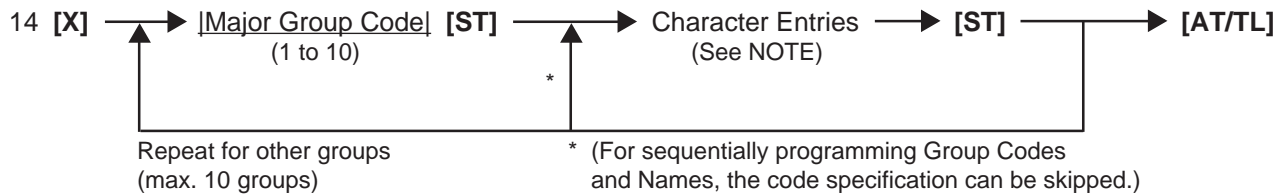
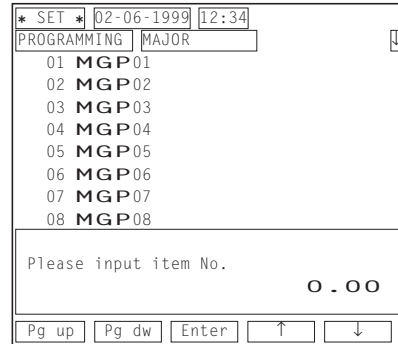

ex.) To set "OTHER" for a major group10

Mode Lock: SET
 Enter 14, depress **[X]**.
 10 **[ST]** OTHER **[ST]** **[AT/TL]**

Journal Print



NOTE: A maximum of 12 regular-sized characters may be set for each Major Group name. One double-sized character occupies two regular-sized character's space. Also see the CHARACTER ENTRIES at the beginning of this chapter. If no name is programmed for a Major Group, an auto-preset data is assigned as the Major Group Name (**MGPxx**; xx = Major Group Code 01 to 10).

■ Combination Report Table Programming (Submode 19)

This programming is used to make a combination report table which is described in the section 4.3 Combination Reports on page 4-9.

CONDITION Any time outside a sale

OPERATION Mode Lock: SET

When you enter 19 and depress the **[X]** key, the screen shown below will appear.

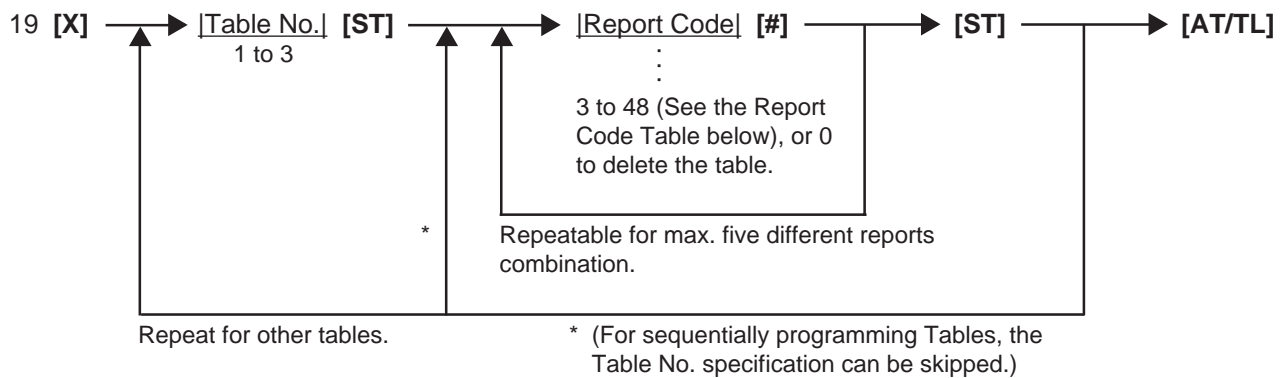
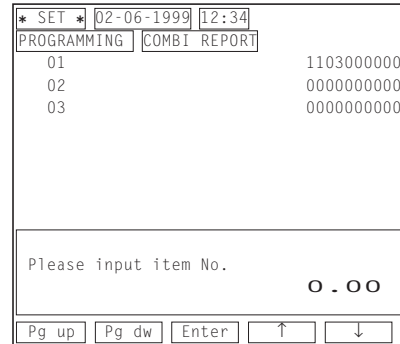

Report Code Table

Report Code	Report Name	Mode for output			
		X	Z	GTX	GTZ
3	Financial	*	*	*	*
4	All Cashier	*	*	*	*
6	Credit Card Company Sales	*	*	*	*
8	Department Group	*		*	
9	Each Media Sales and In-drawer Total	*			
10	Hourly Range	*	*		
11	All Department	*	*	*	*
12	All Media Sales and Cash-in-drawer	*			
13	All PLU Sales	*	*	*	*
14	All PLU Stock	*			
15	All Customer File	*	*		
24	PLU Group	*	*	*	*

*: output
Blank: no output

Report Code Table

Report Code	Report Name	Mode for output			
		X	Z	GTX	GTZ
25	Day Part	*	*		
30	Check Track with Sales	*	*		
31	Check Track without Sales	*			
43	Combo Sales	*	*		
44	Hourly Combo Sales	*	*		
47	Employee Clock-in/Clock-out	*	*	*	*
48	Employee Clock-in/Clock-out (periodic)			*	*

*: output
Blank: no output

ex.) To program the following reports to a combination report table 1.

- 3: Financial
- 4: All Cashier
- 47 Employee Clock-in/Clock-out

Mode Lock: SET

Enter 19, depress [X].

1 [ST] 3 [#] 4 [#] 47 [#] [ST] [AT/TL]

Journal Print



- NOTES:**
1. When changes are made on report combination in a table, entirely or partially, program all the reports in that table again.
 2. An error will result if a Report Code that has already been entered is attempted to enter again in the same table.
 3. In Table No.1, auto-preset report combination of Report 11 (All Depts) and Report 3 (Financial) is programmed. It will be active as Table No.1 content unless no data are programmed for Table No.1.

PLU Stock Loading or Changing (Submode 24)

This submode loads or changes the stock quantities of PLUs with the Stock-process status, as part of stock controls. The stock of a PLU may be entered initially in the PLU TABLE PROGRAMMING operation (Submode 4), and may be adjusted in this operation, from day to day, as the stock increases due to delivery from wholesalers, etc. or as the stock decreases due to damages or losses.

- CONDITION** Any time outside a sale
- OPERATION** Mode Lock: SET

When you enter 24 and depress the [X] key, the screen shown below will appear.

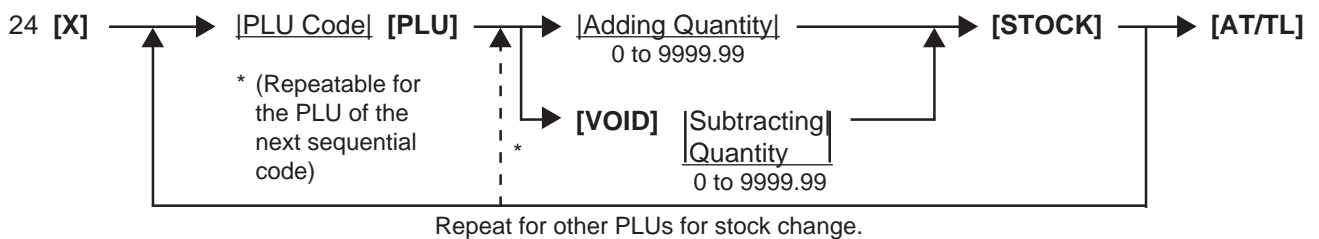
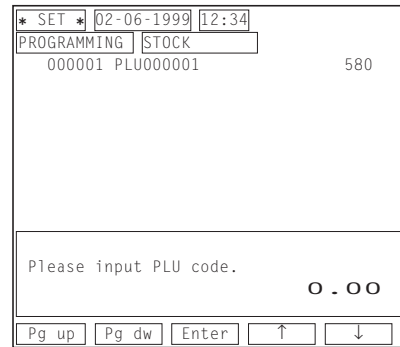

ex.) To subtract 150 from 580 of a current stock quantity of a PLU 1.

Mode Lock: SET
 Enter 24, depress [X].
 1 [PLU] [VOID] 150 [STOCK] [AT/TL]

Journal Print

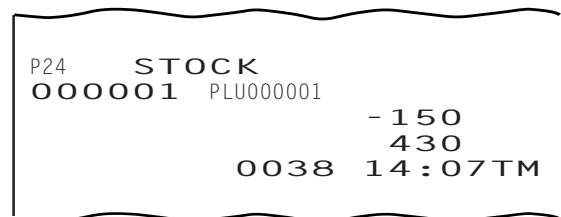

- NOTES:**
1. When you enter 24 and depress the [X] key, a current stock quantity of each PLU will be displayed.
 2. The total stock quantity of a PLU after the addition or subtraction must not exceed the value range from 0 through 9999.99. Otherwise, the Adding or Subtracting Quantity entry will result in an error. Use the [.] key if decimal portion is contained.
 3. The PLU Code here must exist in the PLU Table file and the PLU must be set with Stock-process status.

Tare Table and General Unit Weight Setting (Submode 26)

In the PLU Table Programming operation (Submode 4), some of Scale-compulsory PLUs may be set with a Tare Table No. The actual tare weight is set to each Tare Table here. Also, the General Unit Weight is set here so that the Unit Weight may be effective to scale items entered through departments or PLUs without any Individual Unit Weight designation.

- CONDITION** Any time outside a sale
- OPERATION** Mode Lock: SET

When you enter 26 and depress the [X] key, the screen shown below will appear.

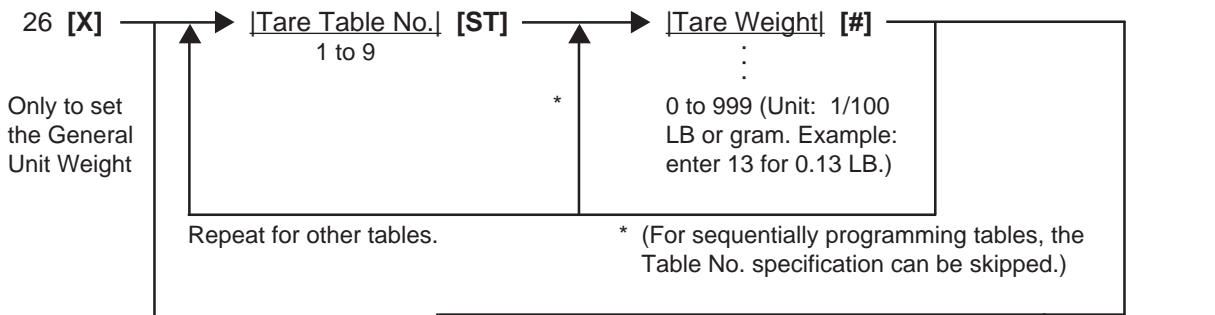
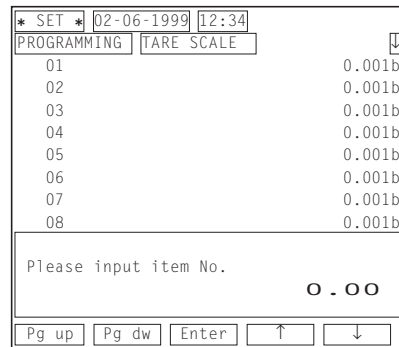

	LB Unit	Kg Unit	
1:	1 LB	1 Kg	** Only to set the Tare Weight
2	2 LB	2 Kg	
3	3 LB	3 Kg	
4	4 LB	4 Kg	
5	5 LB	5 Kg	
6	6 LB	6 Kg	
7	7 LB	7 Kg	
8	8 LB	8 Kg	
9	9 LB	9 Kg	
10	1/2 LB	100 g	
11	1/4 LB	Not applicable	

- ex.) To set the following.
- Tare Table No. 1 with Tare Weight 0.13 LB
 - General Weight 2 LB (Code 2).

Mode Lock: SET
 Enter 26, depress [X].
 1 [ST] 13 [#] 10 [ST] 2 [#] [AT/TL]

Journal Print



NOTE: The initial value for the General Unit Weight is set to Code 1 (1LB or 1Kg).

PLU Preset-code Key/Display Key Setting (Submode 27)

This programming is used to assign a PLU code to each PLU Preset-code key (SFKC 96), and also used to assign a display menu table No. to each display key (SFKC 210). You can assign a maximum of 5 different PLU codes or 5 different display menu table Nos. to one key of the keyboard.

CONDITION Any time outside a sale

When you enter 27 and depress the **[X]** key, the screen shown below will appear.

OPERATION Mode Lock: SET

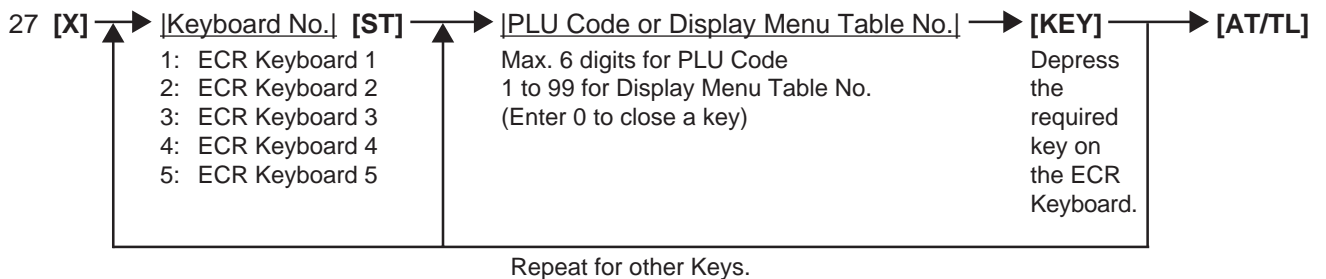
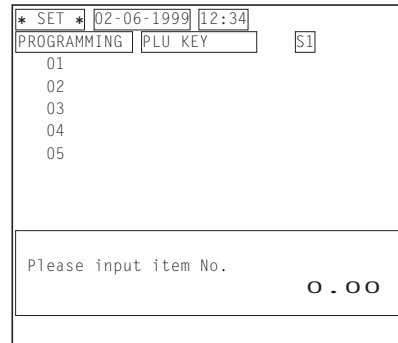

ex.) To assign the PLU code 9 to the required key on the ECR Keyboard 2 and the display menu table No. 2 to the required key on the ECR Keyboard 5.

Mode Lock: SET

Enter 27, depress **[X]**.

2 **[ST]** 9 **[required key of SFKC 96]** 5 **[ST]** 2 **[required key of SFKC 210]** **[AT/TL]**

Journal Print

Keyboard Phase No.
Location Code (left); refer to REMARK on the next page.
PLU Code assigned to a key (right)

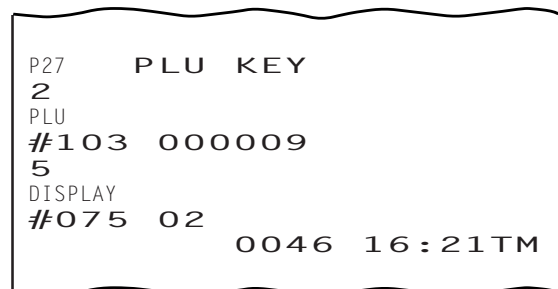

- NOTES:**
1. When an entry of PLU code or display menu table No. is skipped and a **[KEY]** is simply depressed in the above key operation, the preprogrammed PLU code or display menu table No. of the KEY will be displayed.
 2. If "0" is entered as PLU Code or display menu table No. in the above sequence, the KEY will be closed. Pressing the closed KEY in sale entry will be ignored.
 3. The five phases of the keyboard can be shifted by the **[MENU]** keys in actual sales transaction.

REMARK: When a PLU code (display menu No.) is assigned to a PLU Preset-code Key (Display Key) on the ECR Keyboard in the operation on the preceding page, the Hardware Key Code which indicates the absolute location of the key will be printed to the left of the assigned PLU Code (display menu No.). The Hardware Key Codes of the ECR keyboard are shown below.

ECR Keyboard

1	16	31	46	61	76	91	106	121	136	151	166
2	17	32	47	62	77	92	107	122	137	152	167
3	18	33	48	63	78	93	108	123	138	153	168
4	19	34	49	64	79	94	109	124	139	154	169
5	20	35	50	65	80	95	110	125	140	155	170
6	21	36	51	66	81	96	111	126	141	156	171
7	22	37	52	67	82	97	112	127	142	157	172
8	23	38	53	68	83	98	113	128	143	158	173
9	24	39	54	69	84	99	114	129	144	159	174
10	25	40	55	70	85	100	115	130	145	160	175
11	26	41	56	71	86	101	116	131	146	161	176
12	27	42	57	72	87	102	117	132	147	162	177
13	28	43	58	73	88	103	118	133	148	163	178
14	29	44	59	74	89	104	119	134	149	164	179
15	30	45	60	75	90	105	120	135	150	165	180

Navigation Key



PLU Group Name Programming (Submode 29)

This programming is used to set each PLU group name. Grouping of each PLU should be set in the PLU Table Programming (Submode 4).

CONDITION Any time outside a sale

OPERATION Mode Lock: SET

When you enter 29 and depress the **[X]** key, the screen shown below will appear.

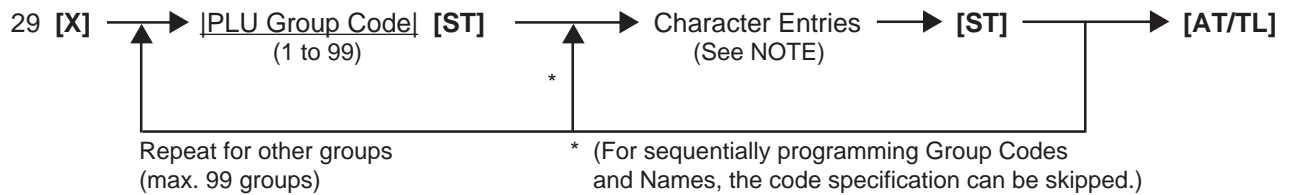
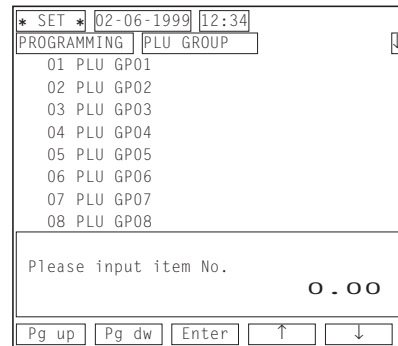

ex.) To set "BEER" for a PLU group 2

Mode Lock: SET
 Enter 29, depress **[X]**.
 2 **[ST]** BEER **[ST]** **[AT/TL]**

Journal Print



NOTE: A maximum of 16 regular-sized characters may be set for each PLU Group name. One double-sized character occupies two regular-sized characters' space. Also see the CHARACTER ENTRIES at the beginning of this chapter. If no name is programmed for a PLU Group, an auto-preset data is assigned as the PLU Group Name (PLU GPxx; xx = PLU Group Code 01 to 99).

RKP Message Programming (Submode 30)

This programming is used to set 20 RKP messages (a maximum of 20 characters x 2 lines for each), and also used to designate an RKP on which each message is outputted. If your printer is the TM-300, you can select a color for each message.

- CONDITION** Any time outside a sale
- OPERATION** Mode Lock: SET

When you enter 30 and depress the **[X]** key, the screen shown below will appear.

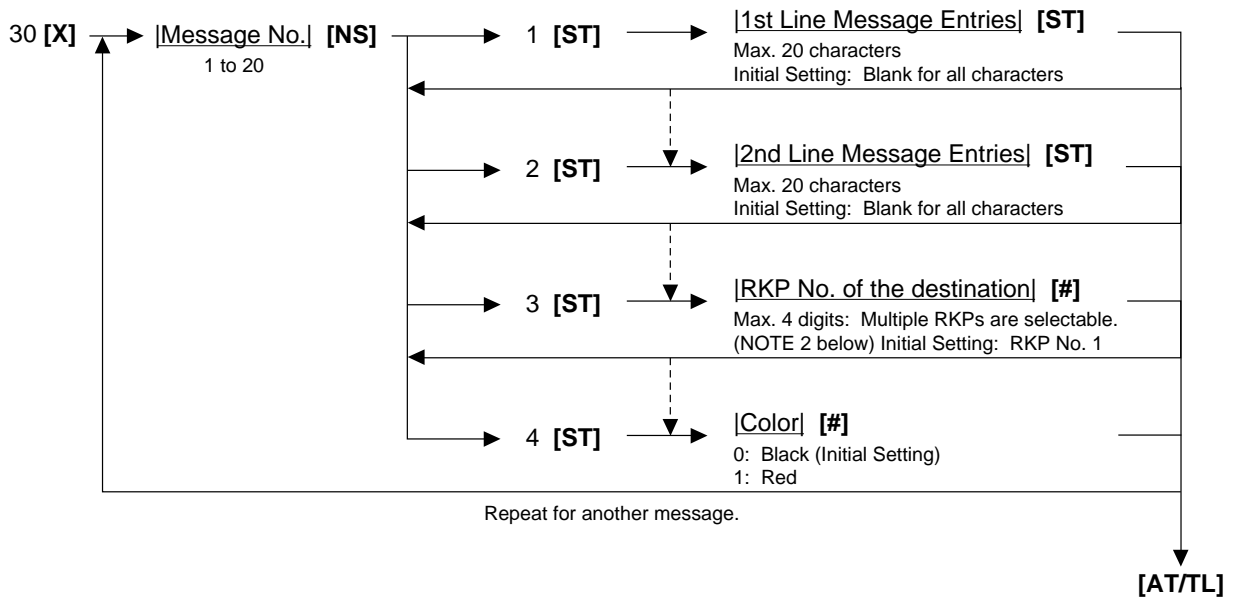
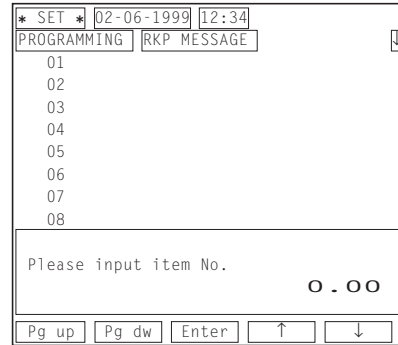

ex.) To set the following to the RKP message 1.

- 1st Line: 20 RKP MESSAGES ARE
- 2nd Line: PROGRAMMABLE!
- Destination: 13 (RKP Nos. 1 and 3)

Mode Lock: SET
 Enter 30, depress **[X]**.
 1 **[NS]** 1 **[ST]** 20 **[SPACE]** RKP **[SPACE]**
 MESSAGES **[SPACE]** ARE **[SPACE]** **[ST]**
 (2 **[ST]**) PROGRAMMABLE! **[ST]** (3 **[ST]**)
 13 **[#]** **[AT/TL]**

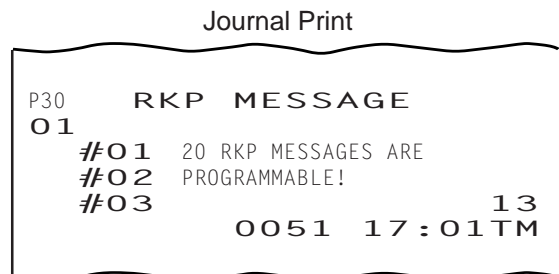

- NOTES:**
1. When you fill one whole line with all blanks, it will result in a one line space.
 2. When you want to designate the RKP Nos. 1 and 3 as the destinations, enter 13, then depress the **[#]** key.

Display Message Programming (Submode 31)

This programming is used to set a display message which is displayed in the 16-digit dot window provided to the customer display and the LCD operator display while the mode lock of the register is in "LOCK" position. A display message can be used for information, welcome greeting, etc.

- CONDITION Any time outside a sale
- OPERATION Mode Lock: SET

When you enter 31 and depress the [X] key, the screen shown below will appear.

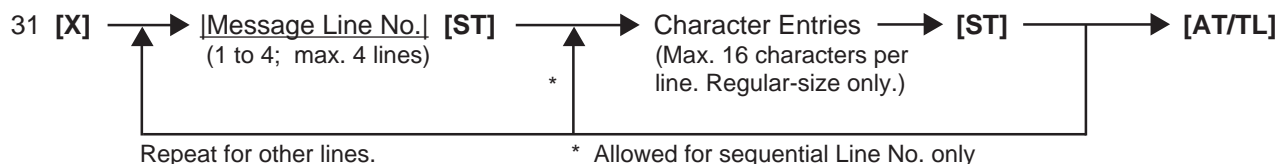
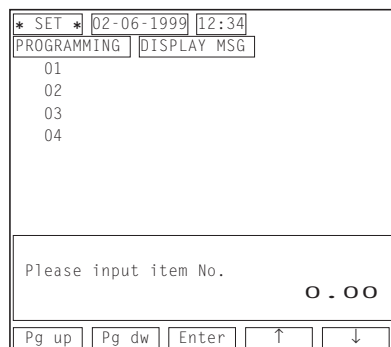

ex.) To set a message "WE SERVE THE CHOICEST FOOD. PLEASE ENJOY YOUR DINNER."

Mode Lock: SET

Enter 35, depress [X].

- 1 [ST] WE [SPACE] SERVE [SPACE] THE [SPACE] CHO [ST]
- (2 [ST]) ICEST [SPACE] FOOD. [ST] (3 [ST]) PLEASE [SPACE] ENJOY [SPACE] YOU [ST]
- (4 [ST]) R [SPACE] DINNER. [ST] [AT/TL]

Journal Print



- NOTES:**
1. You can select either of two features; "Scrolling Display; initial setting" or "16 Characters Held Display". If you select the feature "16 Characters Held Display", refer to the section 9.2 Store Message Display on page 9-2 (Operator's Guide) to display each message.
 2. When the "SCROLLING DISPLAY" feature is selected, a maximum of 64 characters can be entered consecutively after designating Line No. 1 at first and depressing [ST] for each line end.
 3. A character must be regular-sized only.
 4. A DISPLAY MESSAGE set here will also appear in the REG or MGR mode if so selected by a program option.
 5. A message display on the LCD operator display is possible when the feature "16 Characters Held Display" has been selected.

Amount Limit Setting for the [DISC] Key (Submode 35)

This programming is used to set an amount limit for the [DISC] key.

- CONDITION Any time outside a sale
- OPERATION Mode Lock: SET

When you enter 35 and depress the [X] key, the screen shown below will appear.

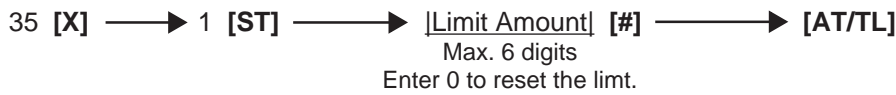
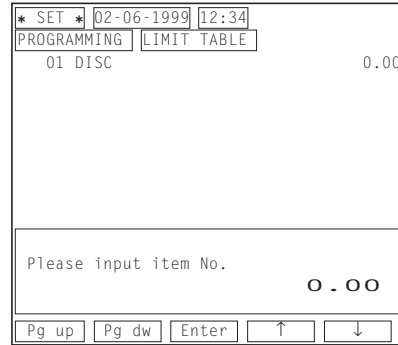

ex.) To set \$5.00 as a limit amount

Mode Lock: SET
 Enter 35, depress [X].
 1 [ST] 500 [#] [AT/TL]

Journal Print



NOTE: The limit set here cannot be released by the [LC OPEN] (or [OPEN]) key in transaction entries.

■ Set Menu Table Programming (Submode 42)

This programming is used to set a Set Menu Table and their respective Sub Menu PLUs. If a PLU is programmed with a Set Menu Table No. (Address 12 of the PLU TABLE PROGRAMMING), the PLU will be a main menu PLU of the Set Menu Table. When the main menu PLU is entered in a sale, the sub menu PLUs which have been programmed in the Set Menu Table will be automatically entered (Preset Set Menu), or other PLUs can be manually entered as sub menu items (Open Set Menu).

• **Programming**

- CONDITION** Any time outside a sale
- OPERATION** Mode Lock: SET

When you enter 42 and depress the **[X]** key, the screen shown below will appear.

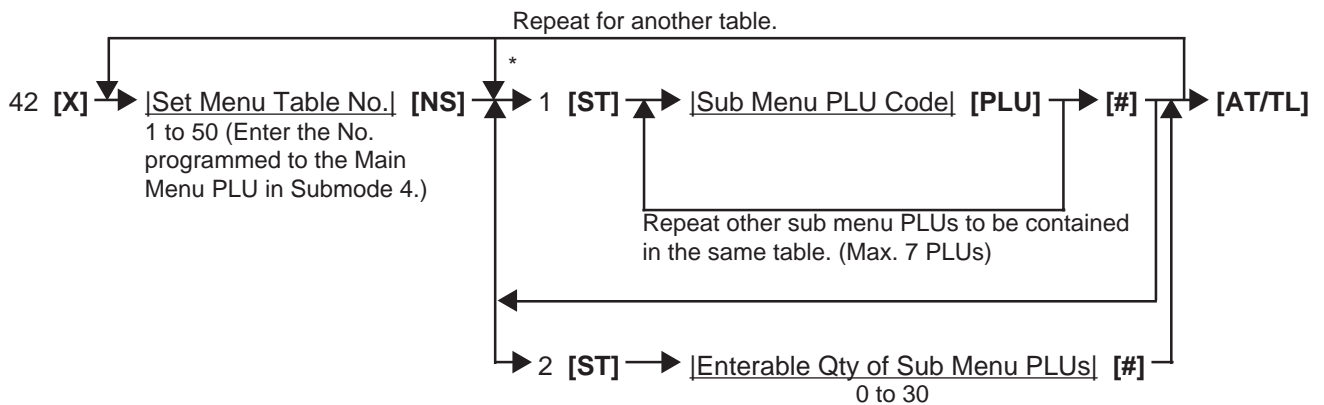
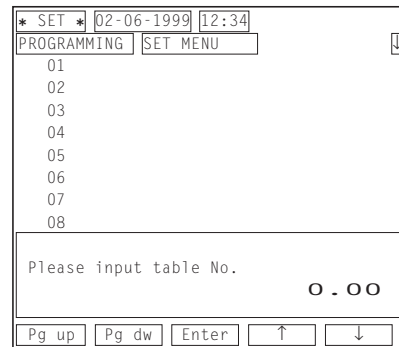

* (For sequentially programming tables, the Table No. specification can be skipped.)

ex.) To set the following sub menu PLUs to a set menu table No. 1.
Sub Menu PLUs: 30, 40, 50

Journal Print

Mode Lock: SET
Enter 42, depress **[X]**.
1 **[NS]** 1 **[ST]** 30 **[PLU]** 40 **[PLU]**
50 **[PLU]** **[#]** **[AT/TL]**



- NOTES:**
- To make a preset set menu, enter PLUs after the key sequence "1 **[ST]**" as shown above. If changing a preset set menu into an open set menu, operate the key sequence "1 **[ST]** 0 **[#]**" after designating the table No.
 - To make an open set menu, depress the **[#]** key immediately after the key sequence "1 **[ST]**". The setting of the enterable quantity of sub menu PLUs is applied only to an open set menu. If its quantity is programmed, the set menu entry will be automatically finalized when the quantity of sub menu PLUs reaches the programmed quantity.

• **Deletion**

CONDITION Any time outside a sale

OPERATION Mode Lock: SET

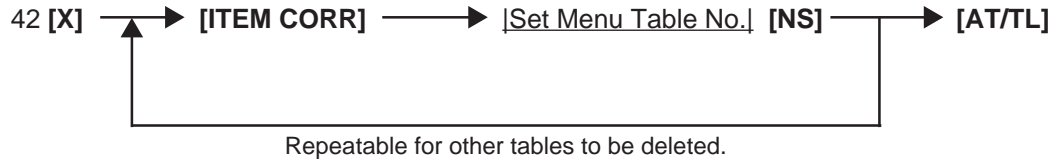

Journal Print



■ **Combo Sale Table Programming (Submode 43)**

This programming is used to set a combo sales table.

• **Programming**

CONDITION Any time outside a sale

OPERATION Mode Lock: SET

When you enter 43 and depress the [X] key, the screen shown below will appear.

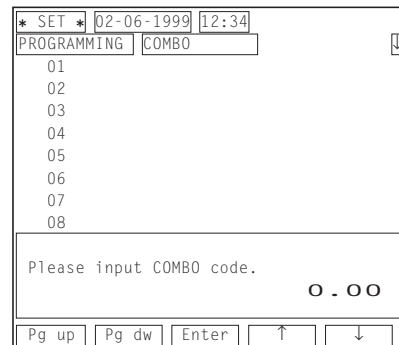

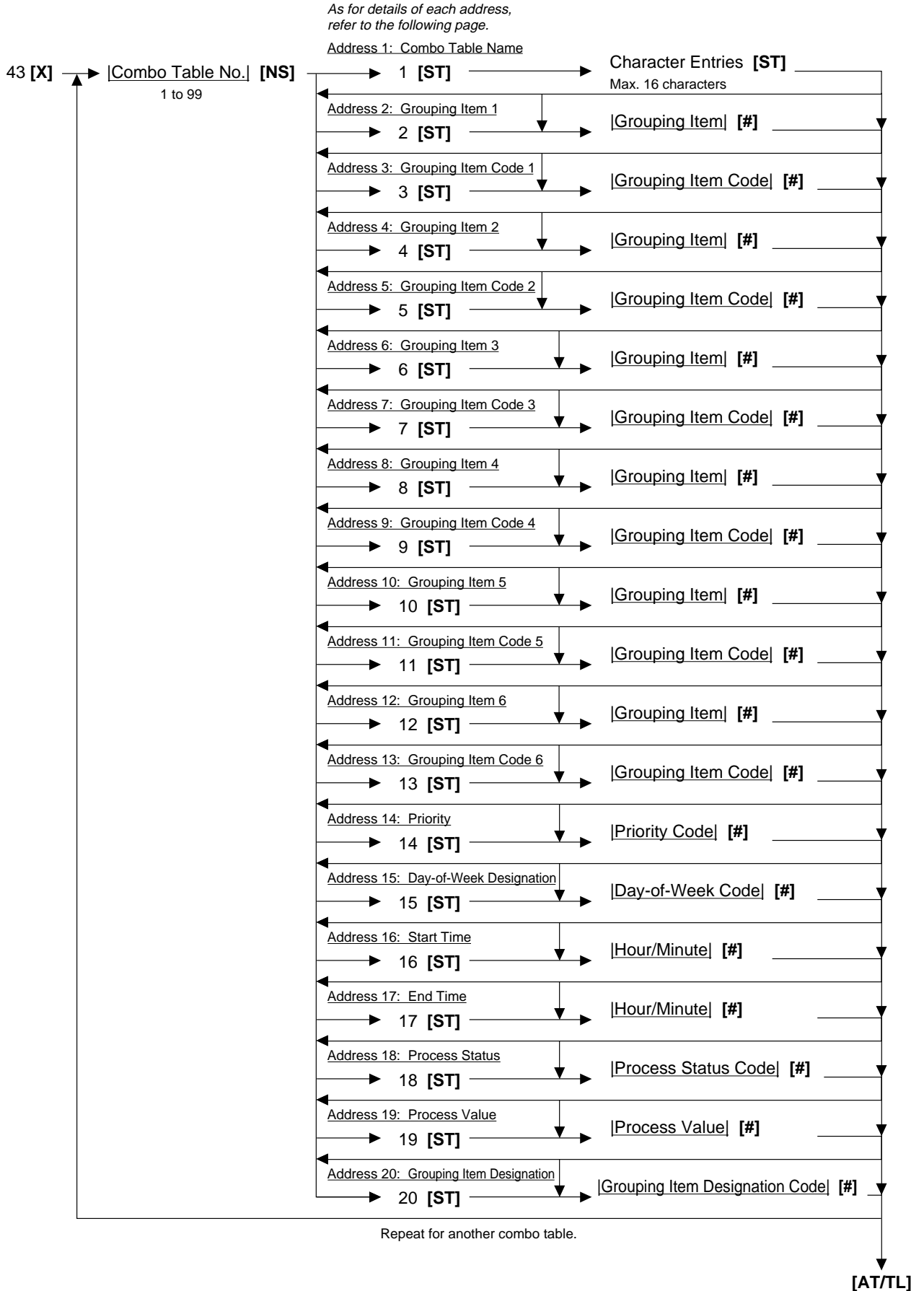

Mode Lock: SET

Enter 43, depress [X].

1 [NS] 1 [ST] COMBO A [ST] (2 [ST]) 2 [#] (3 [ST]) 100 [#] (4 [ST]) 2 [#] (5 [ST]) 200 [#]
 (6 [ST]) 2 [#] (7 [ST]) 300 [#] 14 [ST] 10 [#] (15 [ST]) 1 [#] (16 [ST]) 1030 [#] (17 [ST]) 1400 [#]
 (18 [ST]) 1 [#] 20 [ST] 2 [#] [AT/TL]

Journal Print

P43	COMBO	
O1		
#01	COMBO A	
#02		2
#03		000100
#04		2
#05		000200
#06		2
#07		000300
#14		10
#15		1
#16		10:30TM
#17		14:00TM
#18		1
#20		2
	0078	22:37TM

• Deletion

CONDITION After Combo Sale Reset

OPERATION Mode Lock: SET

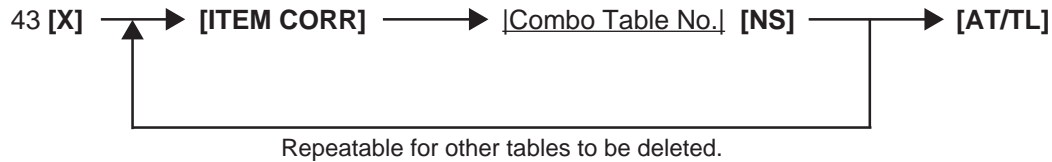

Journal Print

P43	COMBO	
O1		

	0079	22:50TM

Guest Check Commercial Message Programming (Submode 45)

This programming is used to set a commercial message printed on a guest check.

CONDITION Any time outside a sale

When you enter 45 and depress the **[X]** key, the screen shown below will appear.

OPERATION Mode Lock: SET

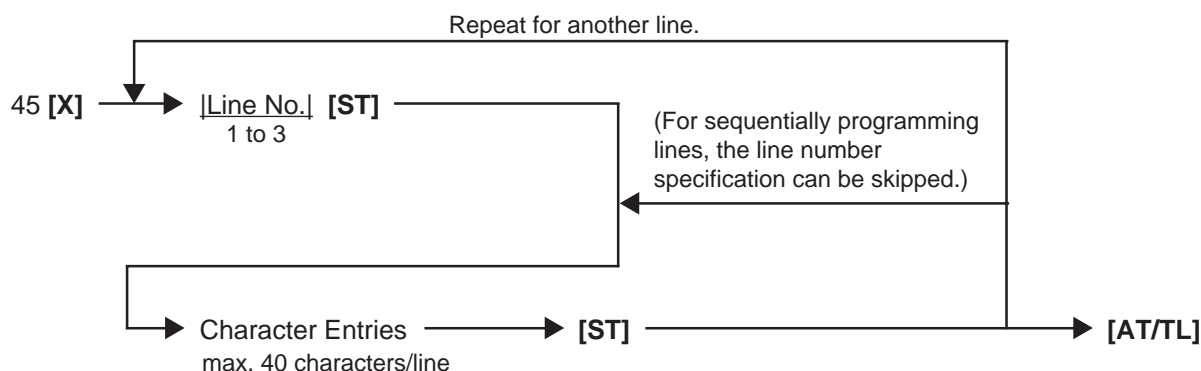
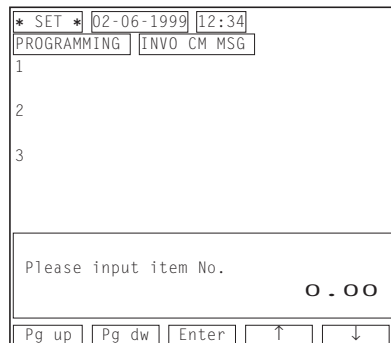

ex.) To set a commercial message "SPECIAL LUNCH MENU FROM 11:00 TO 13:00" on the line No. 1.

Mode Lock: SET

Enter 45, depress **[X]**.

1 **[ST]** SPECIAL LUNCH **[SPACE]** MENU **[SPACE]** FROM **[SPACE]** 11:00 **[SPACE]** TO **[SPACE]** 13:00 **[ST]** **[AT/TL]**

Journal Print



- NOTES:**
1. For each line, a maximum of 40 regular-sized characters or 20 double-sized characters may be entered. A combination of both types is also available.
 2. If programming blanks for all three lines, no extra lines will be fed. If any one of the three lines is programmed, the two other lines will result in two lines space.

Day Part Setting (Submode 46)

A maximum of 6 day parts can be set. You can obtain major group sales data by each day part.

- CONDITION After Day Part Reset
- OPERATION Mode Lock: SET

When you enter 46 and depress the **[X]** key, the screen shown below will appear.

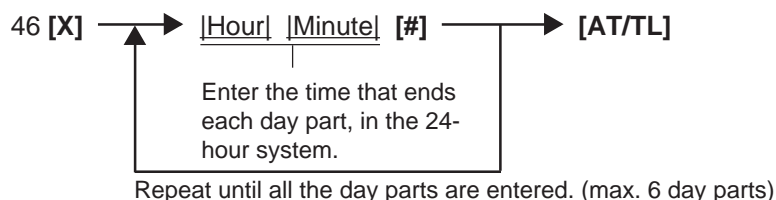
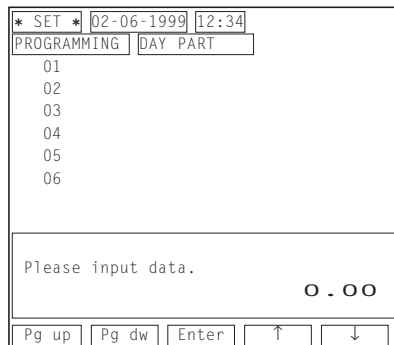

ex.) To set the following day part table.

Day Part 1: Up to 10:00*

Day Part 2: 10:01 to 14:00

Day Part 3: 14:01 to 18:00

Day Part 4: 18:01 to 22:00

* (The first day part is automatically continued from 22:01 of the preceding day.)

Mode Lock: SET

Enter 46, depress **[X]**.

1000 [#] 1400 [#] 1800 [#] 2200 [#] **[AT/TL]**

Journal Print

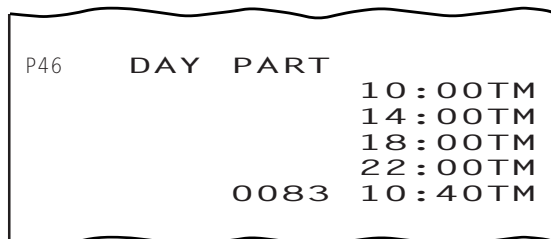

NOTES:

1. A maximum of 6 day parts can be set.
2. To change the table of day parts once set, partially or entirely, do the entire setting operation over again.
2. To reset the day parts table once set, operate:
 Mode Lock: SET
 46 **[X]** 0 [#] **[AT/TL]**
 Then no day part sales data will be outputted on the reports.
3. Do not set a day part across 24:00, such as "from 23:00 to 1:00". If set, no data will be processed into that day part.

Employee Table Setting (Submode 50)

This programming is used to assign a cashier code and a job code to each employee.

CONDITION After Employee Clock-in/Clock-out Daily and GT Reset

When you enter 50 and depress the **[X]** key, the screen shown below will appear.

OPERATION Mode Lock: SET

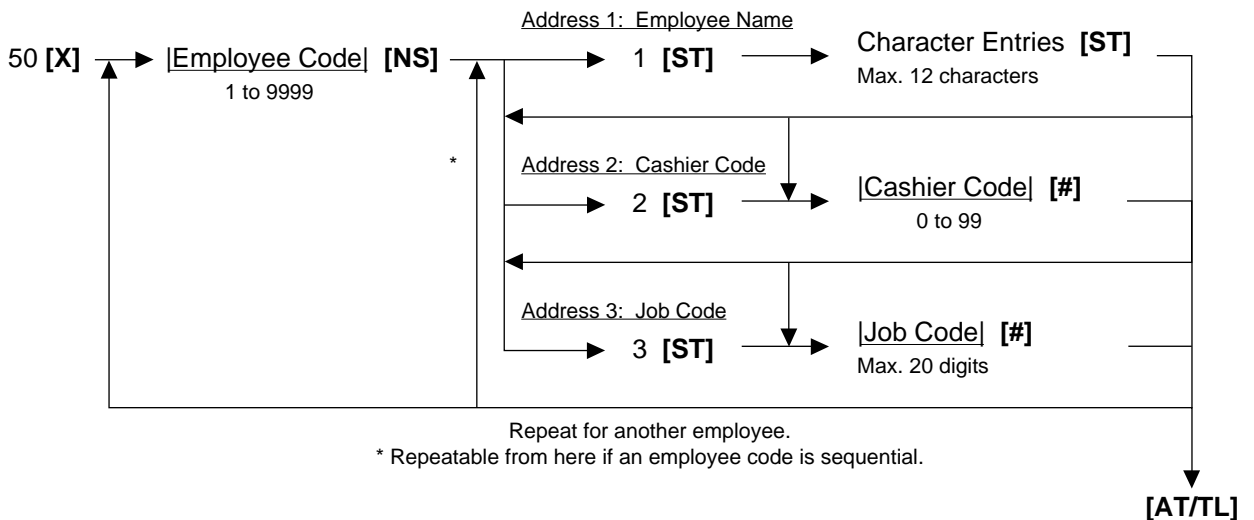
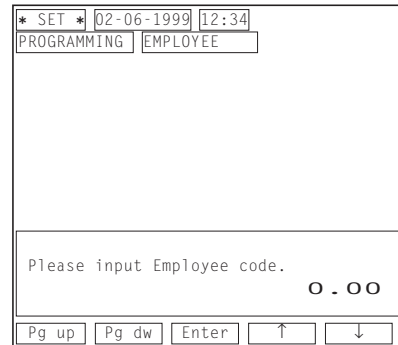

Employee Table Programming Contents

Address No.	Description of Programming Contents
2	<p><u>Cashier Code</u> Enter a manager-assign code (1 to 99). A cashier for which 0 has been entered for a cashier code cannot sign ON on the register. NOTE: Do not set the same cashier code for multiple employees.</p>
3	<p><u>Job Code</u> Enter a max. 20-digit value combining the job codes 1 to 10. (When you enter a 1-digit numeric 1 to 9, add 0 before the numeric.) As a result, a maximum of 10 job codes can be assigned to each employee. NOTE: Each job definition should be programmed in the Job Code/ Working Hours Setting (Submode 51).</p>

NOTE: A maximum of 200 employees can be managed.

ex.) To set the following to an employee No. 1.

Employee No. 1: Address 1 (Name): JONES
 Address 2 (Cashier Code): 1
 Address 3 (Job Code): 010203 (Job Code 1,2,3)

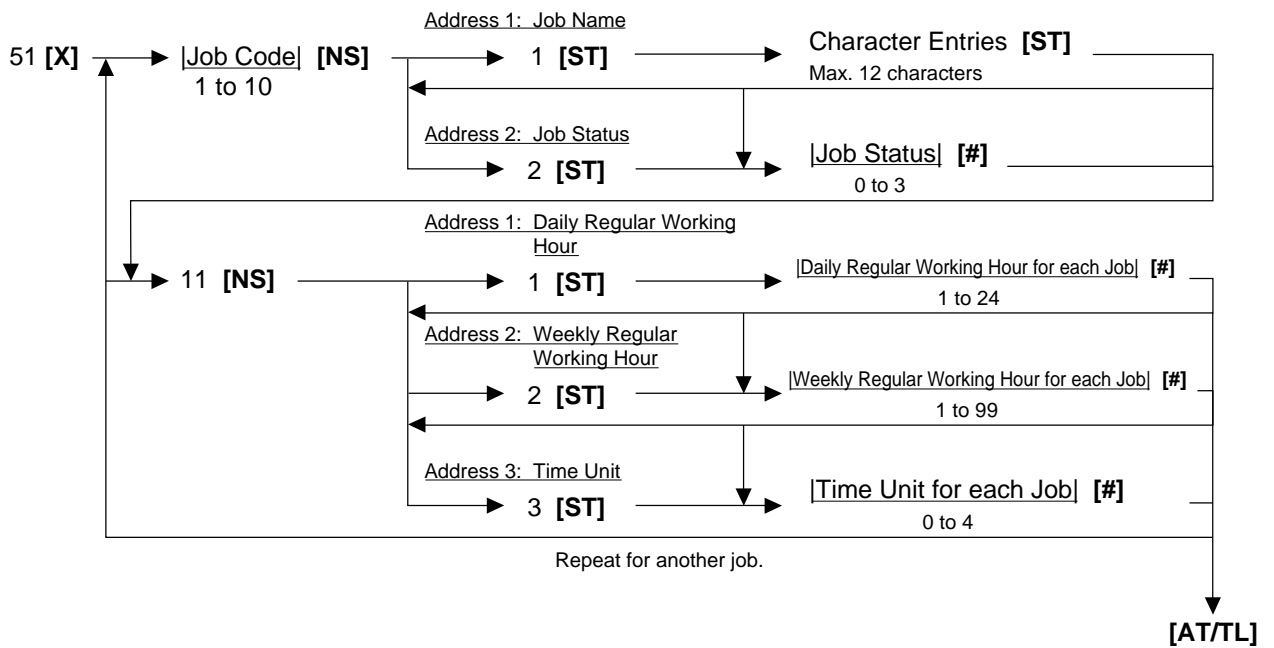

Job Code Programming Contents

Address No.	Description of Programming Contents
2	<u>Job Status</u> Select one status from the following. 0: Normal 1: Chief Cashier 2: Server 3: ECR Operation Prohibited

Working Hour Programming Contents

Address No.	Description of Programming Contents
1	8 hours is initially set as a regular working hours for each job.
2	40 hours is initially set as a weekly working hours for each job.
3	Select one unit from the following. 0: None 1: 5 minutes unit 2: 15 minutes unit 3: 30 minutes unit 4: 60 minutes unit

ex.) To set the following.

Job Code 1: Job Code Address

Address 1 (Job Name): CASHIER

Address 2 (Job Status): 0 (Normal)

Working Hour Address

Address 1 (Daily Regular Working Hour): 7 (7 Hours)

Address 2 (Weekly Regular Working Hour): 35 (35 Hours)

Address 3 (Time Unit): 0 (None)

Job Code 2: Job Code Address

Address 1 (Job Name): COOK
 Address 2 (Job Status): 3 (ECR Operation Prohibited)

Working Hour Address

Address 1 (Daily Regular Working Hour): 9 (9 Hours)
 Address 2 (Weekly Regular Working Hour): 45 (45 Hours)
 Address 3 (Time Unit): 0 (None)

Mode Lock: SET

Enter 51, depress [X].

1 [NS] 1 [ST] CASHIER [ST] (2 [ST]) 0 [#] 11 [NS] 1 [ST] 7 [#] (2 [ST]) 35 [#] (3 [ST]) 0 [#]
 2 [NS] 1 [ST] COOK [ST] (2 [ST]) 3 [#] 11 [NS] 1 [ST] 9 [#] (2 [ST]) 45 [#] (3 [ST]) 0 [#] [AT/TL]

Journal Print

P51	JOB CODE	
01	#01 CASHIER	
	#02	0
11	#01	7
	#02	35
	#03	0
02	#01 COOK	
	#02	3
11	#01	9
	#02	45
	#03	0
	0089 15:43TM	

■ **Tender Up Table Setting (Submode 52)**

This programming is used to set an amount table for the [TENDER UP] key. On how to use the [TENDER UP] key, refer to section 9.30 Sale Finalization by Media Keys (Payment of A Sale) on page 9-20 (Operator's Guide).

CONDITION Any time outside a sale

OPERATION Mode Lock: SET

When you enter 52 and depress the [X] key, the screen shown below will appear.

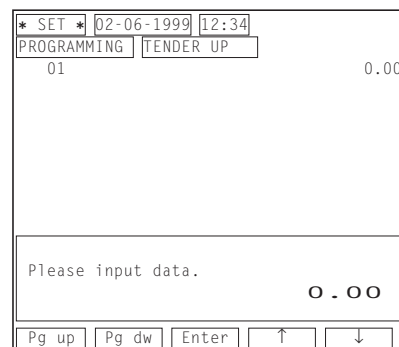

Repeatable for 10 amounts. (NOTE 1 on the next page)

ex.) To set the following tender up table.
 \$50.00, \$100.00, \$150.00, \$200.00

Mode Lock: SET
 Enter 52, depress [X].
 5000 [#] 10000 [#] 15000 [#] 20000 [#] [AT/TL]

Journal Print

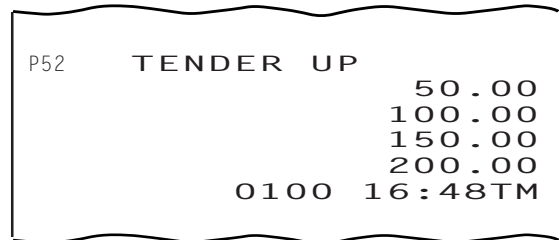

- NOTES:**
1. A tender up amount should be set from a smaller to a larger.
 2. If a tender up table has been programmed as follows, \$50.00, \$100.00, \$150.00, an error will occur when you depress the [TENDER UP] key for a sales total of more than \$150.
 3. To reset the tender up table once set, operate as follows.
 52 [X] 0 [#] [AT/TL]

■ Display Menu Table Setting (Submode 53)

This programming is used to set a display menu table corresponding to each [DISPLAY] key.

• Programming

- CONDITION Any time outside a sale
- OPERATION Mode Lock: SET

When you enter 53 and depress the [X] key, the screen shown below will appear.

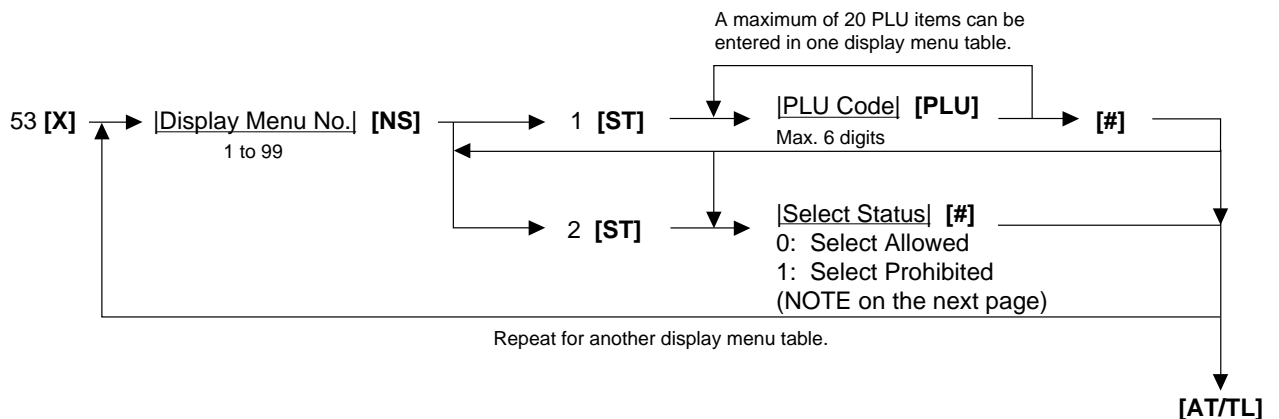
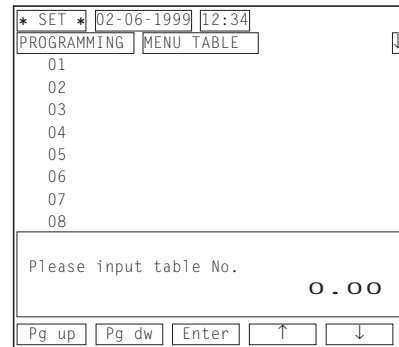

PLU Preset Price Setting or Changing (Submode 60)

This programming is used to set or change each PLU price.

CONDITION

Any time outside a sale

When you enter 60 and depress the **[X]** key, the screen shown below will appear.

OPERATION

Mode Lock: SET

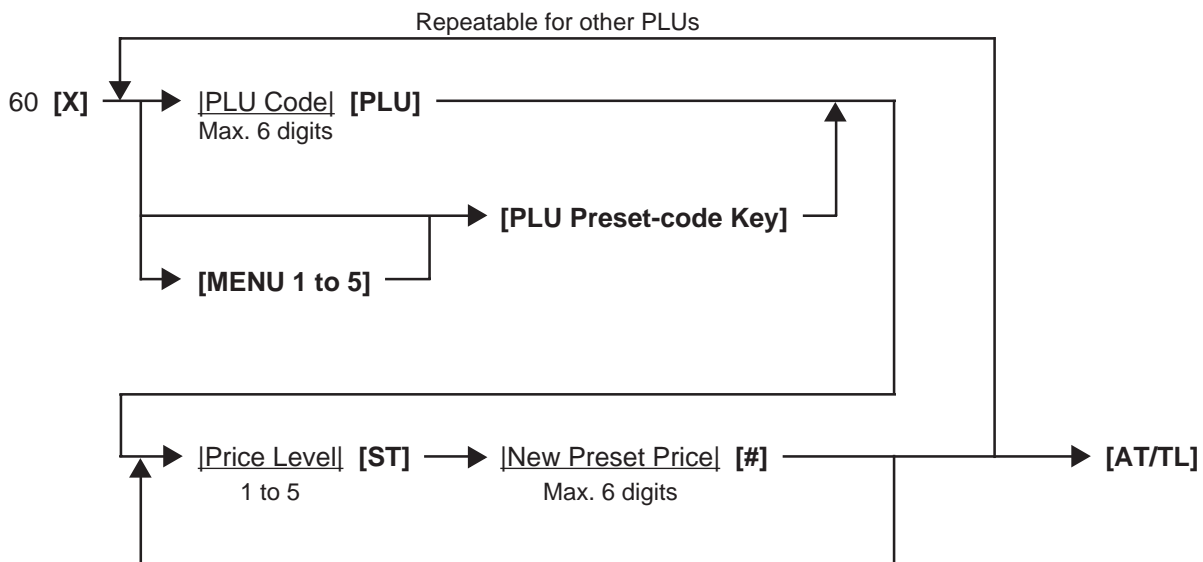
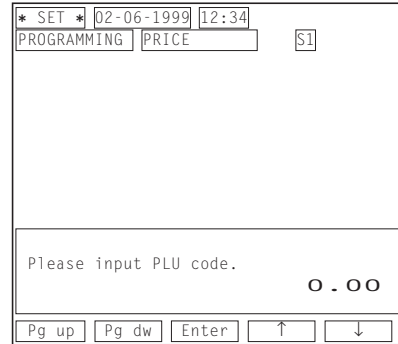

Repeatable for a price change of another price level. When you change the price of each price level in numerical order, the price level designation can be skipped.

- When a **[MENU]** key is depressed, a Keyboard No. will be displayed on the LCD operator display.
- After a **[MENU]** key is depressed, a Keyboard No. will be held until another **[MENU]** key is depressed.
- When the programming is completed by the **[AT/TL]** key depression, the Keyboard No. 1 will be automatically regained.

To change a preset-price PLU into an open-price PLU, skip the "New Preset Price" entry and simply depress the **[#]** key. Presetting a zero-price is also possible.

ex.) To change a price of the PLU Code 21 as follows.

- \$5.00 (Price Level 1)
- \$2.80 (Price Level 3)

Mode Lock: SET

Enter 60, depress **[X]**.

21 **[PLU]** 1 **[ST]** 500 **[#]** 3 **[ST]** 280 **[#]** **[AT/TL]**

Journal Print

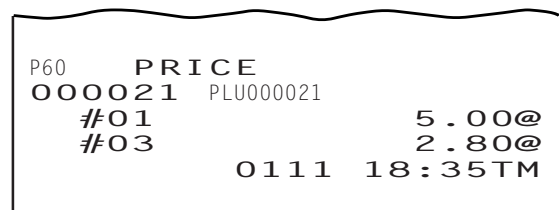

Printer Table Setting (Submode 71)

This programming is used to set a printer table. You can set two printer tables.

- CONDITION Any time outside a sale
- OPERATION Mode Lock: SET

When you enter 71 and depress the [X] key, the screen shown below will appear.

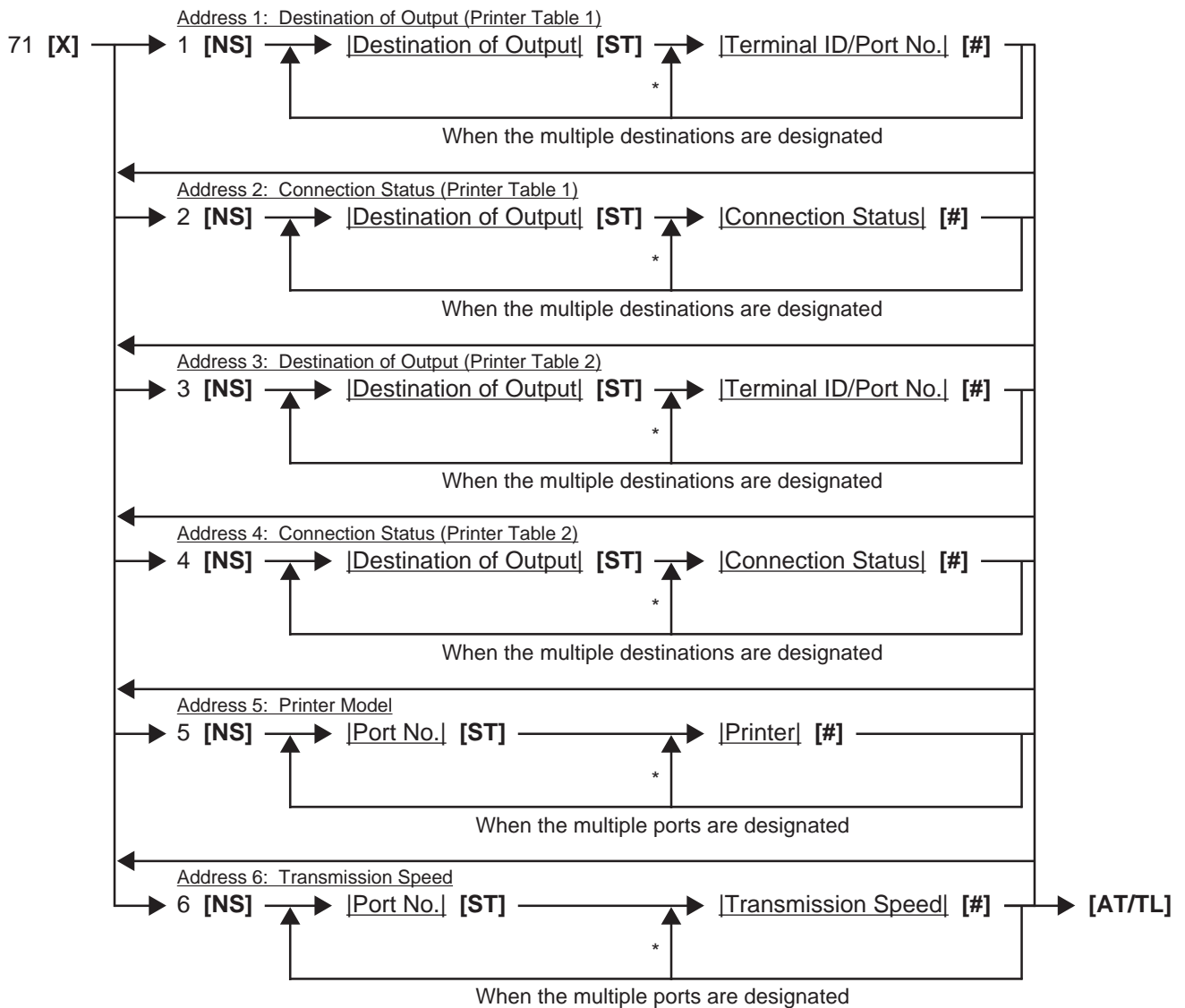
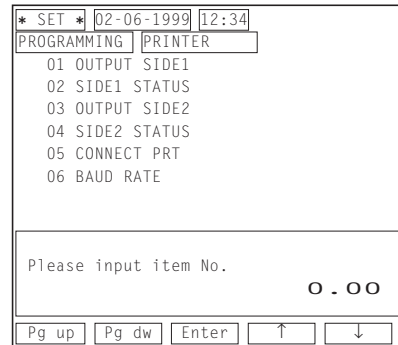

* Repeatable from here if each code is sequential.

Printer Table Setting Contents

Address No.	Description of Programming Contents								
1, 3	<p><u>Destination of Output</u> Destination of data output is as follows.</p> <table> <tr> <td>1: Receipt</td> <td>4: RKP 3</td> </tr> <tr> <td>2: RKP 1</td> <td>5: RKP 4</td> </tr> <tr> <td>3: RKP 2</td> <td>6: Journal</td> </tr> </table> <p><u>Terminal ID/Port No.</u> Enter a 2-digit terminal ID No. and a 1-digit port No. NOTE: If your system is the standalone system, enter only a 1-digit port No.</p>	1: Receipt	4: RKP 3	2: RKP 1	5: RKP 4	3: RKP 2	6: Journal		
1: Receipt	4: RKP 3								
2: RKP 1	5: RKP 4								
3: RKP 2	6: Journal								
2, 4	<p><u>Destination of Output</u> Destination of data output is as follows.</p> <table> <tr> <td>1: Receipt</td> <td>4: RKP 3</td> </tr> <tr> <td>2: RKP 1</td> <td>5: RKP 4</td> </tr> <tr> <td>3: RKP 2</td> <td>6: Journal</td> </tr> </table> <p><u>Connection Status</u> Connection status is as follows.</p> <table> <tr> <td>0: OFF (Disconnection)</td> <td>1: ON (Connection)</td> </tr> </table> <p>NOTE: When a terminal ID/port No. is entered, a connection status will be automatically set to "ON" (Connection).</p>	1: Receipt	4: RKP 3	2: RKP 1	5: RKP 4	3: RKP 2	6: Journal	0: OFF (Disconnection)	1: ON (Connection)
1: Receipt	4: RKP 3								
2: RKP 1	5: RKP 4								
3: RKP 2	6: Journal								
0: OFF (Disconnection)	1: ON (Connection)								
5	<p><u>Port No.</u> Port No. is as follows.</p> <table> <tr> <td>1: Port 1</td> </tr> <tr> <td>2: Port 2</td> </tr> <tr> <td>3: Port 3 (Hardware Option)</td> </tr> </table> <p><u>Printer</u> A printer connectable is as follows.</p> <table> <tr> <td>1: TM-300 (Receipt, RKP 1 to 4, Journal)</td> <td>3: BRST-10 (Receipt)</td> </tr> <tr> <td>2: TM-T88 (Receipt, RKP 1 to 4)</td> <td>0: None</td> </tr> </table>	1: Port 1	2: Port 2	3: Port 3 (Hardware Option)	1: TM-300 (Receipt, RKP 1 to 4, Journal)	3: BRST-10 (Receipt)	2: TM-T88 (Receipt, RKP 1 to 4)	0: None	
1: Port 1									
2: Port 2									
3: Port 3 (Hardware Option)									
1: TM-300 (Receipt, RKP 1 to 4, Journal)	3: BRST-10 (Receipt)								
2: TM-T88 (Receipt, RKP 1 to 4)	0: None								
6	<p><u>Port No.</u> Port No. is as follows.</p> <table> <tr> <td>1: Port 1</td> </tr> <tr> <td>2: Port 2</td> </tr> <tr> <td>3: Port 3 (Hardware Option)</td> </tr> </table> <p><u>Transmission Speed</u></p> <table> <tr> <td>0: 19200 bps</td> <td>1: 9600 bps</td> </tr> </table>	1: Port 1	2: Port 2	3: Port 3 (Hardware Option)	0: 19200 bps	1: 9600 bps			
1: Port 1									
2: Port 2									
3: Port 3 (Hardware Option)									
0: 19200 bps	1: 9600 bps								

ex.) To set the following to a printer table 1.

Printer Table 1	Address 1 (Destination of Output):	1 (Receipt)/1 (Port 1) 2 (RKP 1)/2 (Port 2) 6 (Journal)/2 (Port 2)
	Address 2 (Connection Status):	1: ON for all the destinations
	Address 5 (Printer):	1 (Port 1) for 3 (BRST-10) 2 (Port 2) for 1 (TM-300)

Mode Lock: SET

Enter 71, depress [X].

1 [NS] 1 [ST] 1 [#] (2 [ST]) 2 [#] 6 [ST] 2 [#] 2 [NS] 1 [ST] 1 [#] (2 [ST]) 1 [#] 6 [ST] 1 [#] 5 [NS]
1 [ST] 3 [#] (2 [ST]) 1 [#] [AT/TL]

Journal Print

P71	PRINTER		
1	#01	1	1
	#02	1	2
	#06	1	2
2	#01		1
	#02		1
	#06		1
5	#01		3
	#02		1
		0131	10:20TM

NOTE: A connection status of each RKP can also be changed by an operation in the MGR mode. For details, refer to the section 2.5 RKP Table Change on page 2-3 of the manager's guide.

■ **%+ and %- Preset Rate Setting**

A preset rate may be set on each of the [%+] and [%-] keys, one independent rate for each key. Once a rate is preset, the % key will simply be depressed without a prior rate entry to activate the preset rate. If a rate is entered prior to the depression of the key, the entered rate (manual rate) will be activated instead.

CONDITION Any time outside a sale

OPERATION Mode Lock: SET

When you complete the following programming, the screen shown below will appear. Depress the [ESC] key to go back to the program menu screen.

* SET *	02-06-1999	12:34
PROGRAMMING	MISC	
01	%1RATE	0%
02	%2RATE	0%
03	%3RATE	0%
04	%4RATE	0%
05	%5RATE	0%
06	%6RATE	0%
07	%7RATE	0%
08	%8RATE	0%
Please input data.		0.00
Pg up	Pg dw	Enter
	↑	↓

[Preset Rate] [%+] (For Percent Charge Preset Rate)

⋮

(0.001 to 99.999 (%);
use the [.] key if a decimal portion is contained.)

⋮

[Preset Rate] [%-] (For Percent Discount Preset Rate)

[%3] to [%8] (For Percent Discount Preset Rates for Additional %- Keys)

Journal Print



- NOTES:**
1. Whether the calculated amount by the preset SI % rate affects (i.e. add to or subtract from) the sale total is determined by a program option.
 2. To reset the rate once set, enter 0 as the rate. (Then the rate is regarded as 100% if the option "Non-affect" is selected. With the option "SI Affects Sale Total", some rate other than "0" should be programmed.)

Selective Itemizer Functions and Applications

The "Selective Itemizer" is a temporary total memory for each sale and is activated separately from the Main Itemizer (i.e. sale total memory). If certain PLU items are programmed with the SI (selective itemizer) "net" status, the Selective Itemizer will function to add up amounts of the SI-net status items in registering the items, while the Main Itemizer will function to add up all the items in the sale. Thus, near the sale finalization, the operator may read the SI content by depressing the **[SI/TL]** key.

A preset % rate may be programmed for each of SI1 and SI2 (on the preceding page), and whether the calculated amount will add to, subtract from, or non-affect the sale total is a program option. Whether the amount resulted by depressing the **[SI/TL]** key will print or non-print is another program option.

The applications of this function may vary from store to store. Some stores may use it for counting the service stamps to be issued to the customers according to the sale amount of service-stampable items. In this case, the option "SI Total Non-affects Sale Total" should be selected, and a preset % rate, 1% for example, may be set to issue one service stamp for every \$1.00. Thus the number of stamps to be issued to the customer is displayed (and printed if so programmed) as a result of calculation with the preset % rate, but the resulted value (the number of stamps in this case) will not affect the sale total.

Example 1) With option "SI Total Non-affects Sale Total":

Key Operation in REG Mode

Receipt/Journal Print

1 **[PLU]** (SI-net)
 2 **[PLU]** (non-SI)
 3 **[PLU]** (SI-net)
[SI/TL] (1% is preset)
[AT/TL]

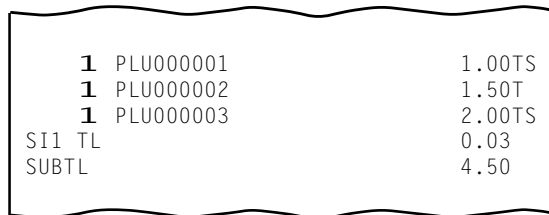

S: SI-net Status
 Number of stamps to be issued.

PLU 1 and PLU 3 are programmed with SI-net-status. On depressing **[SI/TL]**, "0.03" (which is 1% of total amount of PLU 1 "1.00" + PLU 3 "2.00") is displayed and printed, and 3 stamps are to be issued to the customer in this case. The sale total "4.50," is not affected by the SI calculation.

Other stores may use it for calculating the discount amount for certain sales items during a special discount sales period by presetting the discount % rate on the SI and programming SI-net status to certain PLUs which are subject to the special discount.

Example 2) With option "SI Special Discount":

Key Operation in REG Mode

Receipt/Journal Print

1 [PLU] (SI-net)
 2 [PLU] (non-SI)
 3 [PLU] (SI-net)
 [SI/TL] (10% is preset)
 [AT/TL]

1	PLU000001	1.00TS
1	PLU000002	1.50T
1	PLU000003	2.00TS
	SI1 TL	-0.30
	SUBTL	4.20

Discount Amount
 resulted by SI %

On depressing [SI/TL], "-0.30" (which is 10% discount from the total amount of PLU 1 + PLU 3 items) is displayed and printed, and that amount is subtracted from the sale total. (4.50 - 0.30 = 4.20)

Foreign Currency Exchange Rate Setting

In this program, the exchange rate of each foreign currencies (corresponding to the [CUR 1] to [CUR 5] keys) will be set. By setting an exchange rate on each Foreign Currency Key, reading the sale total and tendering in the foreign currency value will be possible for sale finalization.

CONDITION

Any time outside a sale

OPERATION

Mode Lock: SET

When you complete the following programming, the screen shown below will appear. Depress the [ESC] key to go back to the program menu screen.

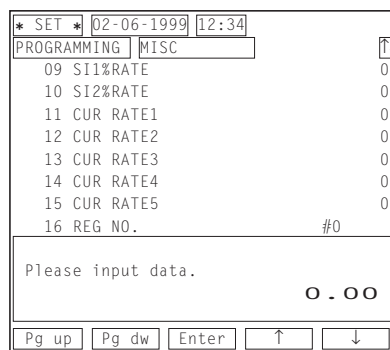

[Exchange Rate for Foreign Currency 1] —————> [CUR 1]
 0.000001 to 9999.999999
 (Use the [.] key if decimal portion is contained in the rate.)

⋮

[Exchange Rate for Foreign Currency 5] —————> [CUR 5]
 As for how to calculate the Exchange Rate, see the description below.

Foreign Currency Exchange Rate Calculation

- The rate must be calculated in the subsidiary currency unit values for both the domestic and the foreign currencies. (In case of calculating the rate from the domestic to a foreign currency with the same zero-suppress form, such as from American \$ to French Franc, it will be no problem even if it is calculated in the main currency of \$ and Franc. However, in case of exchanging from a domestic currency such as \$ or Franc to Japanese yen or Italian Lira, or vice versa, this rule must be obeyed; otherwise a wrong rate will result.)
- Calculation of foreign currency exchange rate is formulated as follows.
 1 Foreign Currency = Domestic Currency/Rate

ex.) To obtain an exchange rate converted from the domestic currency of the Japanese ¥ into the foreign currency American \$.
 When \$1.00 is equal to ¥140, 1 cent = ¥140/100 cent, results in ¥1.4.

ex.) To set the rate on the preceding page for the **[CUR 1]** key.

Mode Lock: SET
1 [.] 4 **[CUR 1]**

Journal Print



Enter 0 to reset an exchange rate once set. You cannot use a foreign currency key of which the rate is 0.

Store/Register No. Setting

A maximum of 6 digits may be set as ID No. for the store and/or register. And once set, it will be printed on every receipt and every transaction on journal.

CONDITION Any time outside a sale

OPERATION Mode Lock: SET

When you complete the following programming, the screen shown below will appear. Depress the **[ESC]** key to go back to the program menu screen.

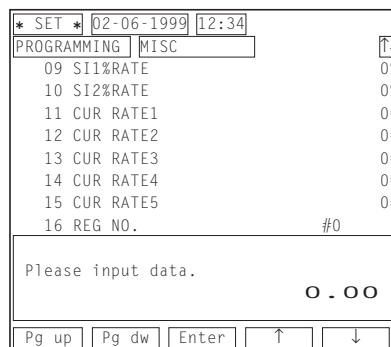

[Store/Register No.] → **[#]**
 ⋮
 Max. 6 digits; 0 to 999999

ex.) To set the following:
Register No. of this terminal: 3001

OPERATION: Mode Lock: SET
3001 **[#]**

Journal Print

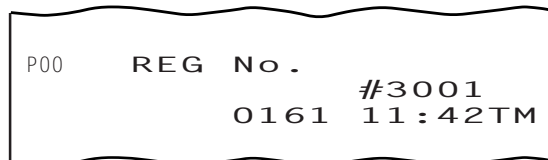

NOTE: The preceding zeros, if entered, will not be printed. For example, if "001234" is entered in the above operation, "#1234" will always be printed as the Register No.

6. VERIFICATION OF PROGRAMMED DATA

You can verify each data programmed in the preceding chapter. Two mode lock positions are available to verify the data; SET and X. Also two ways are available to access a programmed data you want to verify; through the operator display and through the keyboard.

6.1 How to verify a Programmed Data through the Operator Display

When you turn the mode selector key to the SET or X position, the initial screen shown below will appear.

SET Mode

* SET *	02-06-1999	03:04
1	PROGRAMMING	
2	PROGRAM READ	
3	PROGRAM DLL	
Please select operation by Enter key.		
0 . 00		
Pg up	Pg dw	Enter
>	f1	

X Mode

X/GTX	02-06-1999	03:04
1	X	
2	GTX	
3	PROGRAM READ	
4	E-JOURNAL	
5	OTHERS	
Please select operation by Enter key.		
0 . 00		
COMB1	COMB2	COMB3
EJ	f1	

A way to access an item you want to verify is the same as that described in the section 4.1.1 How to Access a Report Item through the Operator Display (on page 4-1 in the manager's guide) or 5.4.1 How to Access a Program Item through the Operator Display (on page 5-5 in the manager's guide). However, when you select "104 PLU", the register will ask you which to choose "NORMAL" or "SIMPLE" as follows.

X/GTX	02-06-1999	12:34
PROGRAM READ	PLU	
1	NORMAL	
2	SIMPLE	
Please select operation by Enter key.		
0 . 00		
Pg up	Pg dw	Enter
>	f1	

- Normal Verification You can verify all the programmed data of a PLU table.
- Simple Verification You can verify the following data of a PLU table.
(PLU code, PLU name, tax status, link department, 1st preset price)

NOTES:

1. You can verify the following data in the address "100 MISC".
(Preset rates for the [%], [SI/TL], [CUR] keys, tax table)
2. Addresses to verify time, date, PLU stock are not provided.

6.2 How to verify a Programmed Data through the Keyboard

You can directly access an item you want to verify through a key operation on the keyboard while the mode lock position is in "SET" or "X".

- To read out the data of programming operations with a Submode No., first enter "1," then each Submode No., and finally depress the **[AT/TL]** key.

For example, to read the programmed data entered in Submode 1 (Store Name/Message, Commercial Message, Footer Logo Message Programming), operate:

1 0 1 → **[AT/TL]**
 |
 | Submode No. (In case of a 1-digit number, add a "0" on top to be a 2-digit number.)
 |
 | Always attach "1" to the Program Submode No. for reading data.

NOTE: Key operations to verify time, date, PLU stock are not provided.

- To verify the data of the address "100 MISC":

1 0 0 → **[AT/TL]**

- To designate a zone for the PLU table verification:

1 0 4 → **[ST]** →

Zone-start
PLU Code

[X]

Zone-end
PLU Code

 → **[PLU]**

- To verify a PLU table data by "Simple" format:

1 0 4 **[PLU]**

NOTE: To verify the PLU preset-code keys programmed on ECR Keyboard phase Nos. 2 to 5:
 127 **[ST]** 2 to 5 **[AT/TL]**

3. M/S LEVEL OPERATOR'S GUIDE

TABLE OF CONTENTS

	Page
1. SYSTEM CONFIGURATION	1-1
2. ADDITIONAL FUNCTION KEY AND REGISTERING PROCEDURE	2-1

1. SYSTEM CONFIGURATION

Making the most of the functions of the previously described FS-2600 standalone, the FS-2600 can be developed into a master-satellite system.

By connecting a PC, the system can also be expanded to a transaction data capture system.

Operational functions on each terminal ECR basically stay the same as on a standalone ECR, except those deleted, changed, or added for this M/S system use which are described later.

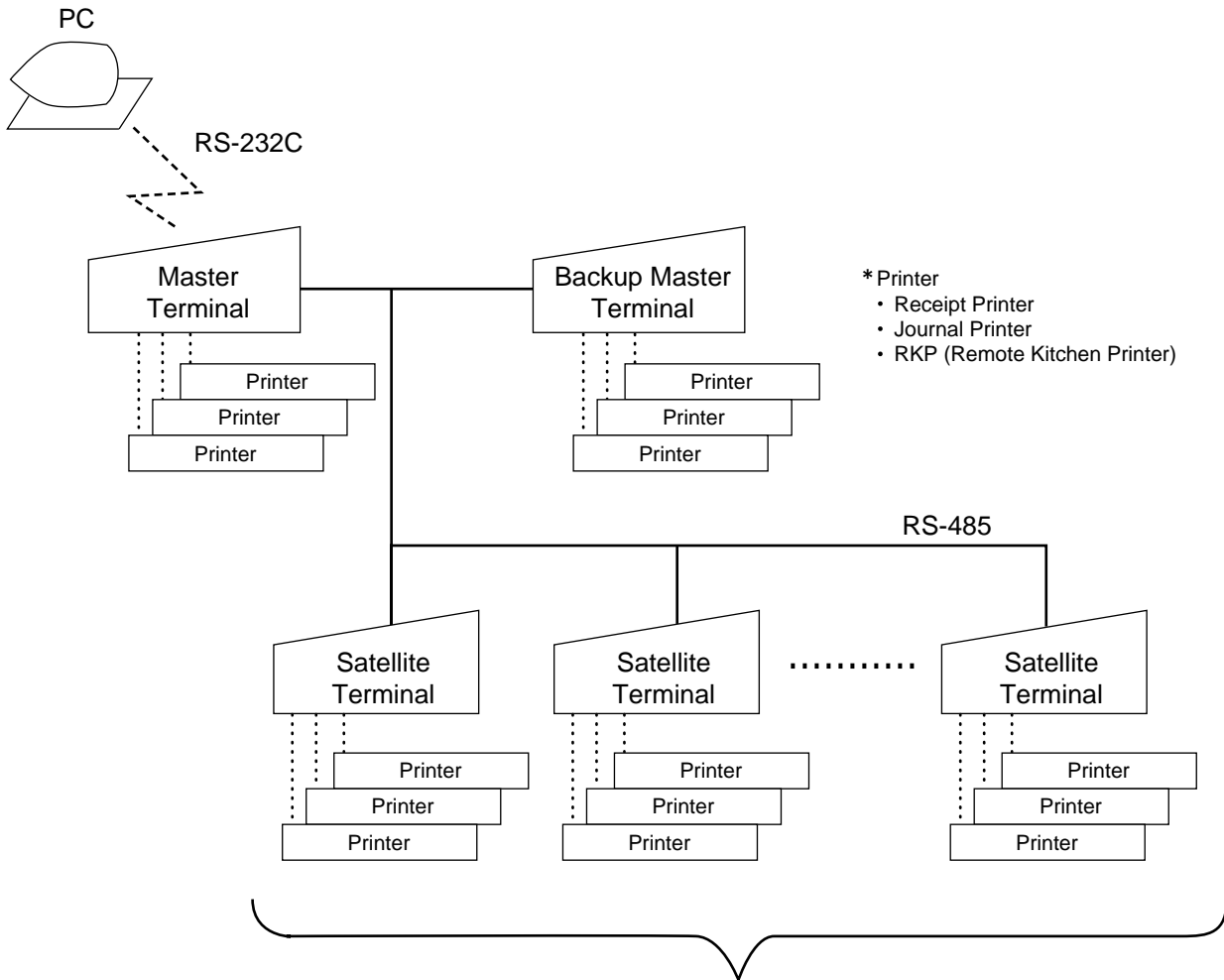

Max. 6 terminals

Max. 16 terminals

A system has the following features.

- RKP Connection
- Floating Cashier
- Order Entry controlled by Order Table No.

A system has none of the features shown left.

- Master Terminal: 1 unit
- Backup Master Terminal: 1 unit
- Satellite Terminals: 14 units

- Master Terminal: 1 unit
- Backup Master Terminal: 1 unit
- Satellite Terminals: 4 units

or

- Master Terminal: 1 unit
- Satellite Terminals: 5 units

2. ADDITIONAL FUNCTION KEY AND REGISTERING PROCEDURE

The following is the key that can be installed on the Master Terminal and Back up Master of an in-line system, in addition to the standalone specifications, and the registering procedure using the key.

RTR RTR (Register-to-Register) DECLARATION Key ([RTR])

- By depressing the **[RTR]** key on the Master Terminal, various in-line jobs (DLLs, Consolidated Read/Reset Report takings, etc.) can be performed.

PROCEDURE ON A MASTER TERMINAL FOR RTR DECLARATION

Mode Lock: SET, X, Z or MGR/Anytime outside a sale

Depress **[RTR]**.

- NOTES:**
- While a PC job is under way (a command of ULL, DLL, or Read/Reset from the PC), the RTR Declaration is not possible. Similarly, while the RTR Declaration is on, no PC jobs are possible.
 - While the RTR Declaration is on, no transaction entries in the REG, MGR or □ mode are possible.
 - While the RTR Declaration is on, no Backup Data Check is performed.
 - While the RTR Declaration is on, the following jobs are operable.
 - Programming Operations
 - DLL Operations (DLL to Satellite Terminals)
 - Consolidated Read/Reset Report takings
 - Manual Copying of Backup Data
 - The **[RTR]** key can be programmed to require Manager Intervention.
 - If the option "Auto Data Copying feature" is selected for Copying of Backup Data, the RTR Declaration is not possible while a backup data update process is under way.
 - If the option "Compulsion of Data Sending to PC" is selected, the RTR Declaration is not possible until the reset data (the consolidation data) transmission to the PC is completed.
- By depressing the **[RTR]** key on the Master Terminal while the RTR Declaration is on, the RTR Declaration ON status is canceled.

When the **[RTR]** key is depressed to declare "RTR ON", the following indicator will appear on the LCD operator display.

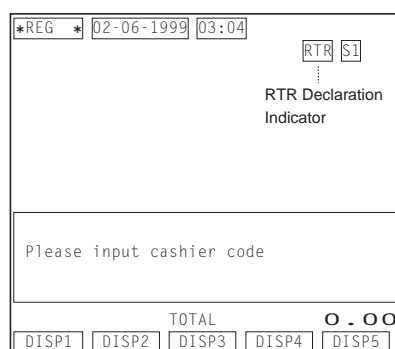

PROCEDURE ON A MASTER TERMINAL FOR RTR DECLARATION CANCEL

Mode Lock: SET, X, Z or MGR/RTR Declaration is ON

Depress **[RTR]**.

NOTE: *If the RTR declaration cancel is performed while a backup error flag is ON, a copy process of a backup data will be automatically performed regardless of a program option. (Automatic Copy or Manual Copy for Backup Data).*

4. M/S LEVEL MANAGER'S GUIDE

TABLE OF CONTENTS

	Page
1. OPERATIONS BEFORE IN-LINE SERVICE	1-1
1.1 Terminal Open Check	1-1
1.2 Terminal Designation	1-2
1.3 Terminal Condition Check	1-3
1.4 Printer Condition Check	1-4
2. READ AND RESET REPORTS	2-1
2.1 Terminal Reports	2-1
2.2 In-line Reports	2-1
2.3 Operations after In-line report Taking	2-8
3. PROGRAMMING OPERATIONS	3-1
3.1 Programming Operations Common with Standalone ECR Level	3-1
3.2 Programming Operations Added for In-line Terminals	3-2
3.3 Verification of Programmed Data Related to In-line Specifications	3-5
4. DLL (Down-Line-Loading) OPERATIONS	4-1
4.1 DLL Job List	4-1
4.2 Print Format of DLL Operations	4-2
5. PLU MAINTENANCE	5-1
5.1 PLU Table Addition/Change/Deletion with DLL (Submode 63)	5-1
5.2 PLU Price Change with DLL (Submode 73)	5-3
6. INQUIRY	6-1
7. BACKUP FUNCTION	7-1
8. DATA CAPTURE FUNCITON	8-1
9. MASTER AND BACKUP MASTER ALTERNATION	9-1
10. TRANSMISSION ERROR	10-1
10.1 Cause of Error	10-1
10.2 Error Display	10-1
10.3 Error Canceling Process	10-2
11. OTHER OPERATIONS RELATING TO IN-LINE SERVICE	11-1
11.1 Suspending	11-1
11.2 Retry	11-1
11.3 Incomplete Ending	11-1
11.4 Cancel	11-1

1. OPERATIONS BEFORE IN-LINE SERVICE

Before entering in-line service operations (In-line Report takings, DLLs, etc.), the following operations are available if necessary.

1.1 Terminal Open Check

This operation sends a dummy text to those terminals set in the Terminal Connection Table (Submode 69), and prints out the Register Nos. of the disconnected terminals (i.e. terminals not responding).

CONDITION Any time outside a sale (operable on the Master Terminal)

OPERATION Mode Lock: X and RTR Declaration ON

Through the Operator Display

Select "5 OTHERS".

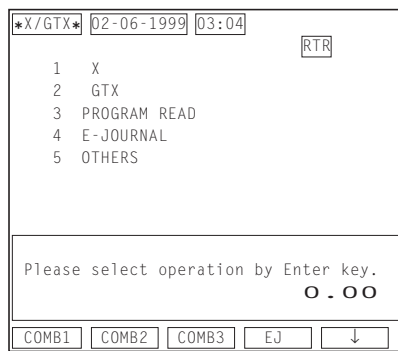

Select "80 T/M OPEN CHK".

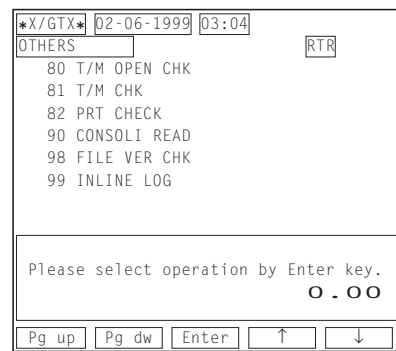

Through the Keyboard

80 [AT/TL]

Master Terminal Receipt Print

When the check result is normal:
Prints the Report Name only.

When any error status is found:
Prints the Register Nos. of the terminals not connected properly, as well as the Report Name.

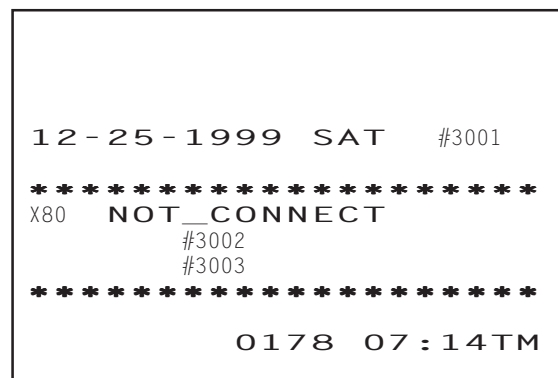
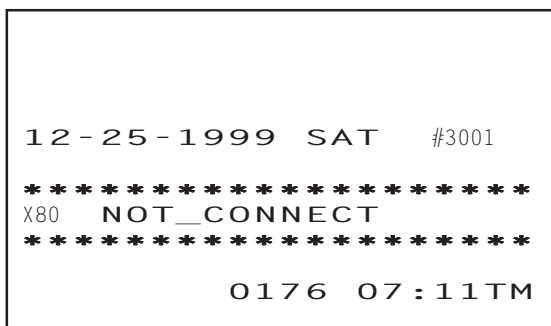

1.2 Terminal Designation

This operation can be performed before any in-line service operation. When this operation is skipped, no specific terminals are designated, i.e., the in-line service operations will be performed to all the terminals.

CONDITION Any time outside a sale (operable on the Master Terminal)

OPERATION Mode Lock: SET, X or Z (depending on the in-line service operations to follow) and RTR Declaration ON

Through the Operator Display (NOTE 2 below)

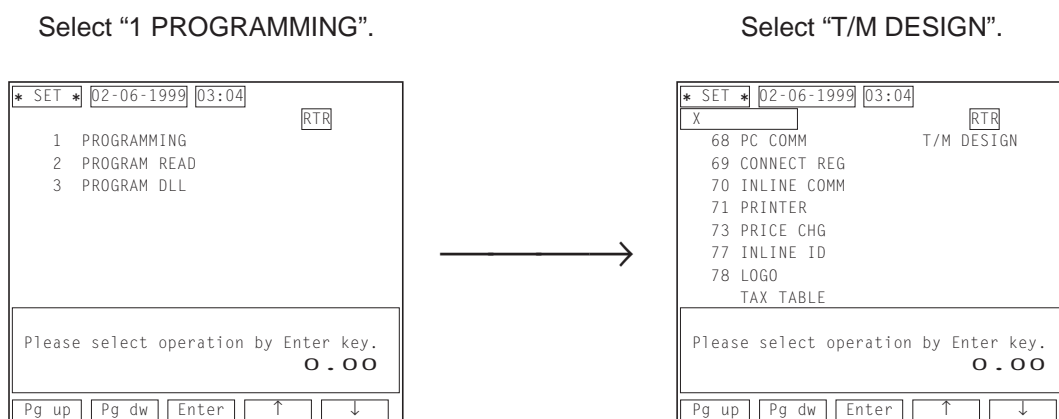

Through the Keyboard

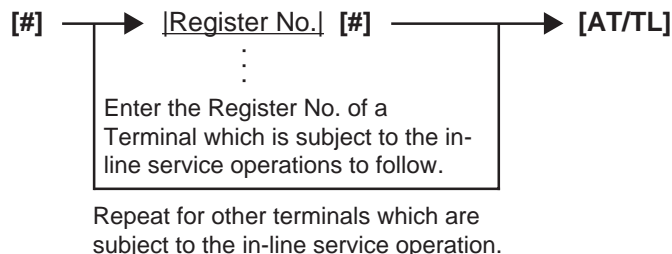

- NOTES:**
1. The Terminal Designation once declared by the above operation will be canceled by changing the position of the Mode Lock, or by RTR Declaration Cancel, or by turning OFF and ON the power of the terminal. The designation is automatically canceled on completion of the operation to follow or when a new designation is operated.
 2. You should perform the terminal designation through the operator display only when an in-line service operation to follow is that regarding the SET mode. As described in NOTE 1, the mode lock change after designating a terminal results in the cancellation of the terminal designation you declared.

ex.) To designate the following terminal.

Terminal ID No. 4: Register No. 3003

Mode Lock: SET, X or Z (depending on an inline-service operation to follow)/RTR Declaration ON

[#] 3003 **[#]** **[AT/TL]**

Journal Print



1.3 Terminal Condition Check

This operation checks the condition of the designated terminals, and prints out the status responded from the terminals.

CONDITION Any time outside a sale (operable on Master Terminal)

OPERATION Mode Lock: X and RTR Declaration ON

Through the Operator Display

Select "5 OTHERS".

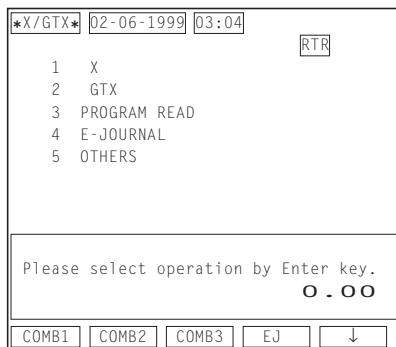

Select "81 T/M CHK".

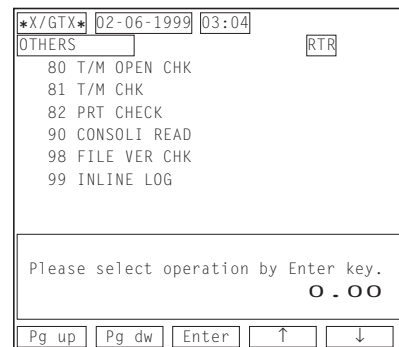

Through the Keyboard

81 [AT/TL]

Master Terminal Receipt Print

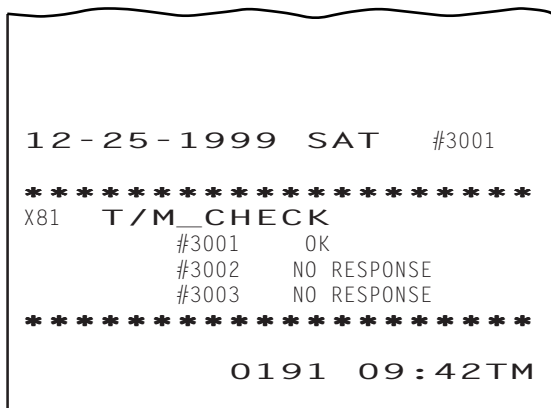

Status Symbol
 OK: The terminal condition is normal.
 NO RESPONSE: No response (power-OFF, etc.)
 Blank: Other statuses

1.4 Printer Condition Check

This operation checks the conditions of the printers connected to each terminal.

CONDITION Any time outside a sale (operable on each terminal)

OPERATION Mode Lock: X

Through the Operator Display

Select "5 OTHERS".

```

*X/GTX* 02-06-1999 03:04
RTR
1 X
2 GTX
3 PROGRAM READ
4 E-JOURNAL
5 OTHERS

Please select operation by Enter key.
0.00
COMB1 COMB2 COMB3 EJ ↓
    
```



Select "82 PRT CHECK".

```

*X/GTX* 02-06-1999 03:04
OTHERS
80 T/M OPEN CHK
81 T/M CHK
82 PRT CHECK
90 CONSOLI READ
98 FILE VER CHK
99 INLINE LOG

Please select operation by Enter key.
0.00
Pg up Pg dw Enter ↑ ↓
    
```

Through the Keyboard

82 [AT/TL]

Receipt Print

```

12-25-1999 SAT #3001
X82 X_PRT_CHECK
1
R OK
J OK
RKP1 OK

0192 10:06TM
    
```

OK: The printer condition is normal.
 ?: Transmission Error
 OFF LINE: No response (power-OFF, etc.)

2. READ AND RESET REPORTS

2.1 Terminal Reports

Since most reports are taken as in-line reports on the Master Terminal, some of the reports which are available on the individual standalone ECR basis cannot be taken on Master or Satellite ECRs of the in-line system. The following are the reports which are listed in the MANAGER'S GUIDE for the standalone level but cannot be taken on any ECRs of the in-line system. Other reports not listed below can be taken even in the in-line system. (Before taking those reports, however, please read the next section 2.2: In-line Reports.)

TERMINAL REPORTS that cannot be taken on any ECRs of the in-line system

DAILY REPORTS

REPORT NAME
CASHIER READ AND RESET REPORTS (when adopting the Floating Cashier Feature) <ul style="list-style-type: none"> • Individual Cashier Read • Individual Cashier Reset • All Cashier Read • All Cashier Reset
CHECK TRACK (Guest Order Table) WITH SALES READ AND RESET REPORTS <ul style="list-style-type: none"> • Individual Cashier Read • Individual Cashier Reset • All Cashier Read • All Cashier Reset
CHECK TRACK (Guest Order Table) WITHOUT SALES READ REPORTS <ul style="list-style-type: none"> • Individual Cashier • All Cashier
EMPLOYEE CLOCK-IN/CLOCK-OUT READ AND RESET REPORTS (Daily and Weekly)

GT REPORTS

REPORT NAME
CASHIER GT READ AND RESET REPORTS (when adopting the Floating Cashier Feature) <ul style="list-style-type: none"> • Individual Cashier GT Read • Individual Cashier GT Reset • All Cashier GT Read • All Cashier GT Reset
EMPLOYEE CLOCK-IN/CLOCK-OUT GT READ AND RESET REPORTS

2.2 In-line Reports

2.2.1 In-line Report Command Executions

Before taking in-line reports, please note the following:

- 1) In-line Reset Reports (as well as In-line Read Reports) can be taken on the Master Terminal as long as the Satellite Terminals are in the idle status ("Signed OFF" condition in case of the cashier code entry type). To check status of all the terminals connected to the in-line loop, Terminal Condition Check can be operated (refer to Chapter 1).
- 2) When In-line Reports are taken, the power of each Satellite terminal must be turned ON but the Mode Lock can be in any position.

The operation flow for taking In-line Reports is shown on the next page, and the table of In-line Reports is on the following pages.

The key operation for each In-line Report is the same as the corresponding terminal report available on the standalone ECR. However, the key operation can be executed only on the Master Terminal while the **[RTR]** key is turned on.

Conditions required on terminals for In-line Report takings:

Read/Reset Reports (Daily or GT)

- Master Terminal: Any time outside a sale
- Satellite Terminals: Signed-OFF condition (Code Entry Method)

Lock Positions Required:

- Master Terminal: Mode Lock: X/RTR Declaration: ON
Mode Lock: Z/RTR Declaration: ON
- Satellite Terminals: Any positions

WARNING!

When opening the cash drawer, be careful not to let the drawer hit any person.

OPERATION FLOW OF IN-LINE READ OR RESET REPORTS

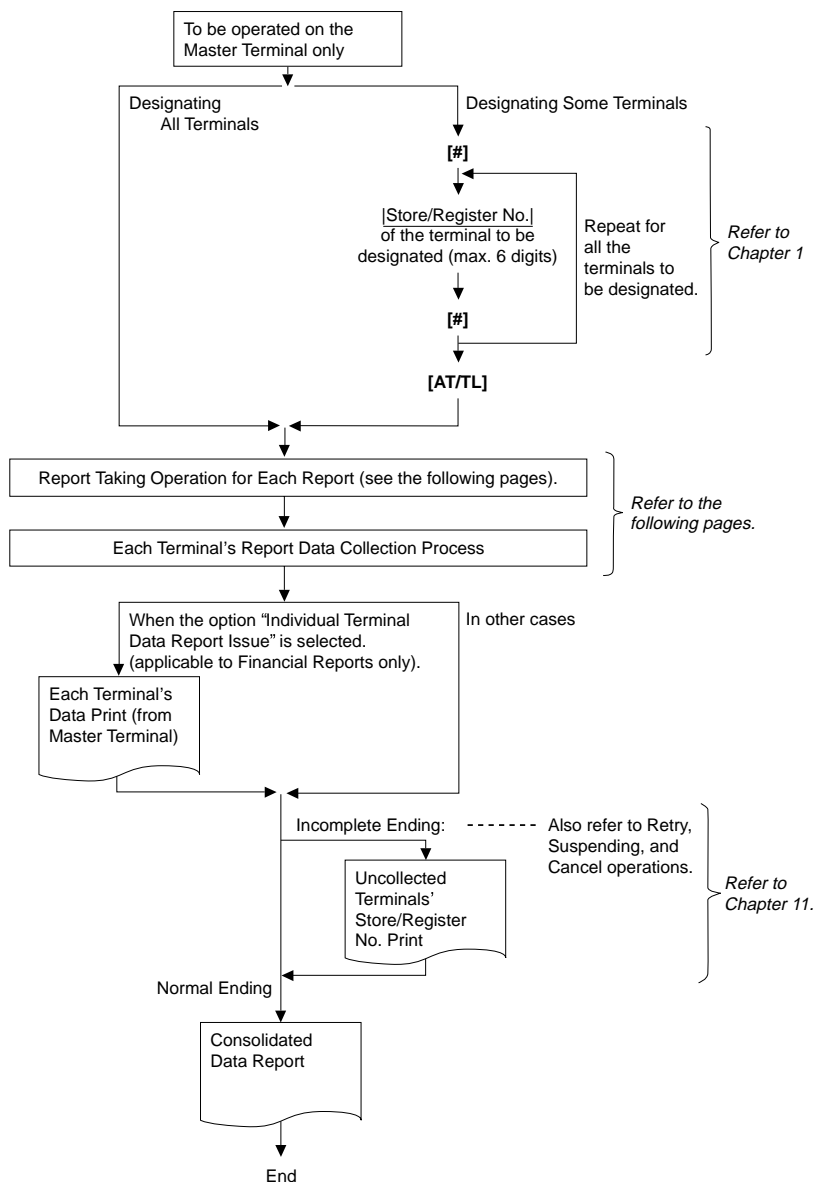

TABLE OF IN-LINE REPORT OPERATIONS

RTR Declaration: ON

Report Name	Mode Lock	Key Operation
COMBINATION REPORTS		
• Combination 1 Read: Daily	X	[AT/TL]
GT	X	200 [AT/TL]
• Combination 2 Read: Daily	X	1 [AT/TL]
GT	X	201 [AT/TL]
• Combination 3 Read: Daily	X	2 [AT/TL]
GT	X	202 [AT/TL]
• Combination 1 Reset: Daily	Z	[AT/TL]
GT	Z	200 [AT/TL]
• Combination 2 Reset: Daily	Z	1 [AT/TL]
GT	Z	201 [AT/TL]
• Combination 3 Reset: Daily	Z	2 [AT/TL]
GT	Z	202 [AT/TL]
FINANCIAL REPORTS		
• Financial Read: Daily	X	3 [AT/TL]
GT	X	203 [AT/TL]
• Financial Reset: Daily	Z	3 [AT/TL]
GT	Z	203 [AT/TL]
CASHIER REPORTS (for the Floating Cashier feature)		
• Individual Cashier Read: Daily	X	Code Entry Method: 4 [#] [Cashier ID Code] [AT/TL] (2-digit manager-assign code)
GT	X	Start with 204 instead of 4 in the above pattern.
• Individual Cashier Reset: Daily	Z	Code Entry Method: 4 [#] [Cashier ID Code] [AT/TL] (2-digit manager-assign code)
GT	Z	Start with 204 instead of 4 in the above pattern.
• All store All Cashier Read: Daily	X	4 [ST]
GT	X	204 [ST]
• All store All Cashier Reset: Daily	Z	4 [ST]
GT	Z	204 [ST]
CASHIER REPORTS (for the Non-Floating Cashier feature only)		
• Indiv. Terminal All Cashier Read: Daily	X	4 [ST]
GT	X	204 [ST]
• Indiv. Terminal All Cashier Reset: Daily	Z	4 [ST]
GT	Z	204 [ST]
CREDIT CARD COMPANY SALES REPORTS		
• Credit Card Company Sales Read: Daily	X	6 [AT/TL]
GT	X	206 [AT/TL]
• Credit Card Company Sales Reset : Daily	Z	6 [AT/TL]
GT	Z	206 [AT/TL]
DEPARTMENT GROUP REPORTS (Read only)		
• Department Group Read: Daily	X	8 [AT/TL]
GT	X	208 [AT/TL]
MEDIA SALES AND IN-DRAWER READ (Daily only)		
	X	9 [AT/TL]

(to be continued on next page)

TABLE OF IN-LINE REPORT OPERATIONS (continued)

RTR Declaration: ON

Report Name	Mode Lock	Key Operation
HOURLY RANGE REPORTS <ul style="list-style-type: none"> Hourly Read (Daily only) Hourly Reset (Daily only) 	X Z	10 [AT/TL] 10 [AT/TL]
DEPARTMENT REPORTS <ul style="list-style-type: none"> All Department Read: Daily GT All Department Reset: Daily GT 	X X Z Z	11 [AT/TL] 211 [AT/TL] 11 [AT/TL] 211 [AT/TL]
ALL MEDIA SALES TOTAL AND CASH-IN-DRAWER READ (Daily only)	X	12 [AT/TL]
PLU REPORTS <ul style="list-style-type: none"> All PLU Read: Daily GT All PLU Reset: Daily GT Zone PLU Read: Daily GT Zone PLU Reset: Daily GT Individual PLU Read: Daily GT Inactive PLU Read: Daily GT 	X X Z Z X X Z Z X X X X	13 [AT/TL] 213 [AT/TL] 13 [AT/TL] 213 [AT/TL] 13 [#] → Zone-start PLU Code [X] → Zone-end PLU Code [AT/TL] Start with 213 instead of 13 in the above pattern. 13 [#] → Zone-start PLU Code [X] → Zone-end PLU Code [AT/TL] Start with 213 instead of 13 in the above pattern. (Process Reports; NOTE on page 2-5) 13 [#] → PLU Code [PLU] → ([ST]) [AT/TL] Repeat for required PLUs. Start with 213 instead of 13 in the above pattern. (Process Reports; NOTE on page 2-5) 13 [#] → 0 [AT/TL] Start with 213 instead of 13 in the above pattern.
PLU STOCK READ REPORTS (Daily only) <ul style="list-style-type: none"> Individual PLU Stock Zone PLU Stock All PLU Stock 	X X X	(Process Reports; NOTE page 2-5) 14 [#] → PLU Code [PLU] → [AT/TL] Repeatable 14 [#] Zone-start [X] Zone-end [AT/TL] PLU Code PLU Code 14 [AT/TL]
CUSTOMER FILE REPORTS (Daily only) <ul style="list-style-type: none"> Individual File Read Zone File Read Zone File Reset All File Read All File Reset Inactive File Read 	X X Z X Z X	15 [#] File Code [X] [AT/TL] 15 [#] Zone-start [X] Zone-end [AT/TL] File Code File Code 15 [AT/TL] 15 [#] 0 [AT/TL]
PLU GROUP REPORTS <ul style="list-style-type: none"> PLU Group Read: Daily GT PLU Group Reset: Daily GT 	X X Z Z	24 [AT/TL] 224 [AT/TL] 24 [AT/TL] 224 [AT/TL]

(to be continued on next page)

PROCESS REPORTS AND BASE REPORT DATA

The following table shows which process reports are available after which report data collections.

Reports Collection Required before Process Report takings (<i>CONSOLIDATION MEMORY CAPTURE: NOTE 1</i>)	Process Reports available
Any of the following PLU reports (NOTE2) All PLU Read Daily Zone PLU Read Daily All PLU Reset Daily Zone PLU Reset Daily	Individual PLU Read Daily Inactive PLU Read Daily
Any of the following PLU reports (NOTE2) All PLU Read GT Zone PLU Read GT All PLU Reset GT Zone PLU Reset GT	Individual PLU Read GT Inactive PLU Read GT
Either of the following PLU stock reports (NOTE 2) All PLU Stock Read Zone PLU Stock Read	Individual PLU Stock Read

- NOTES:**
- CONSOLIDATION MEMORY CAPTURE: When an in-line read or reset report is taken on the Master Terminal, the consolidated data is automatically stored in the Consolidation Memory of the Master Terminal. The consolidated data stored there is not only used as the data for a Process Report but also sent to the PC by a command from the PC when a PC is connected. However, Consolidation memory capturing of a PLU report and other reports cannot be performed at the same time. Only one job for the same Report No. can be captured in the Consolidated Memory (A Read and a Reset of the same report is regarded as one job), and it always holds the latest consolidated data.*
 - The process reports will be output based on the report data previously collected. For example, when an "Inactive PLU Read" report is taken after a "Zone PLU Read", only the inactive PLUs in the designated zone will be printed on the Inactive Read Report.*

2.2.2 In-line Report Print FormatIN-LINE REPORT TYPE

An in-line report can be classified into the following five types.

- Collects data from each terminal to print a consolidation result:
Credit Card Company Sales, Department Group, Hourly Range, All Department, All/Zone PLU, All/Zone PLU Stock, PLU Group, Day Part, Combo Sales, Hourly Combo Sales Reports
- Collects data from each terminal to print a collection result per terminal:
Indiv. Terminal All Cashier Report (Non-floating Cashier)
- Collects data from each terminal to print a collection result per terminal and then print the consolidation result:
Financial, Media Sales & In-drawer and All Media Sales Total & Cash-in-drawer Reports
- Creates a process data using consolidated data and prints a report:
Indiv. PLU, Inactive PLU and Indiv. PLU Stock Reports
- Prints data in the center file possessed by the master terminal:
Indiv./All Cashier (Floating Cashier), Guest File, Check Track with/without Sales, Employee Clock-in/ Clock-out Reports

The print format of each report is basically the same as the format of the corresponding standalone terminal report except that some indications are additionally printed as in-line operation job IDs.

```

12-25-1999 SAT #3001
*****
[-----]
[-----]
[-----]
#111101 0001Z
#222202 0001Z
  :
  :
#999909 0001Z
*****
#555505 XXXXXXXXXXXX
#666606 XXXXXXXXXXXX

0176 07:11TM
    
```

RTR-Symbol
Report Name
(When designating a zone, a zone range is printed.)

For print items, refer to the similar report described in the Stand-alone section.

Register No., Reset Count
(on Reset Report only)

RTR Symbol
Unfinished register No. and status
NO RESPONSE: No response
BUSY: The terminal is busy.
Blank: Other statuses

Consecutive No., Current Time

Journal Indications on Individual Terminals (when report data is collected)

Read Report Collection Indication

```

* X03  FINANCIAL  22:30TM *
    
```

Read Operation Descriptor

Time of Data Collection

Reset Report Collection Indication

```

* Z03  FINANCIAL  22:30TM *
= Z03  FINANCIAL  22:30TM =
    
```

Reset Operation Descriptor

Time of Data Collection

Time of Clear Command Reception

2.3 Operations after In-line report Taking

The following operations are available after taking in-line reports.

2.3.1 Consolidated report Data Read (Reprint)

This operation issues the report data which is remaining in the Consolidation Memory of the Master Terminal.

OPERATION ON MASTER TERMINAL: Mode Lock: X/RTR Declaration: ON

90 [AT/TL]

When no consolidated data is remaining in the memory, this read operation is not possible.

2.3.2 Enforced Clear of Hold Condition (on Individual Terminals)

This can be operated when the HOLD condition on a terminal can by no means be cleared because the terminal cannot receive a Clear Command from the Master Terminal for some reason (the Master Terminal becomes down, etc. before completion of the reset report data collection).

OPERATION ON ANY TERMINAL IN HOLD CONDITION: Mode Lock: Z

9999 [AT/TL]

On operating this, the HOLD condition is cleared, and allows any key-in operations. However, this operation is regarded as an emergency measure to cope with such trouble as the Master Terminal becomes down, etc. and thus no other solutions can be chosen, because the sales data memory of those reports can no longer be collected by the Master Terminal.

3. PROGRAMMING OPERATIONS

The system should be programmed fully by your local TOSHIBA TEC representative at the time of delivery according to the user's requirements so that daily operations can immediately start. However, some data must be added or changed daily or in a longer period. Since the volume of programming contents for the system is too large, this chapter and the following two chapters are provided as guide lines of the user's daily programming and maintenance operations. If there are any unclear points or program data other than listed here must be changed or added, please contact your TOSHIBA TEC representative. Please also note that some programming operations introduced in the Standalone Level are modified or not available on in-line terminals.

WARNING!

Never try to access a program item other than those in the following list. If you access it and mistakenly change important data, a malfunction may occur on your completed system.

3.1 Programming Operations Common with Standalone ECR Level

The following is the table of programming operations which are introduced in the Manager's Guide for the Standalone Level and can be operated on in-line terminals as well, with the Submode No. and operation sequence unchanged. However, on in-line terminals, these are usually operated on the Master Terminal only and down-line-loaded (DLLed) to all the Satellite Terminals. Therefore, if any program data is changed, a DLL is further necessary to load the new data (after the change) to all the Satellite Terminals (to be described in the next chapter).

PROGRAMMING JOB LIST

Master: Programming is possible on the master terminal while the RTR declaration is ON.

Satellite: Programming is possible on the master terminal (while the RTR declaration is OFF), the backup master terminal and the satellite terminals.

O: Available

Submode No.	Programming Job	Terminal	
		Master	Satellite
1	Store Name/Message, Commercial Message, Footer Logo Message Programming	O	O
2	Cashier Programming	O	
3	Department Table Programming	O	
4	PLU Table Programming	O	
5	Time Setting or Adjustment	O	O
6	Date Setting or Adjustment	O	O
7	Hourly Range Setting	O	
8	Amount Limit Setting for Function Keys and Guests	O	O
12	Non-taxable Limit Amount and Gratuity Rate Setting	O	
13	Minor Group Name Programming	O	
14	Major Group Name Programming	O	
15	Customer File Table Setting	O	
19	Combination Report Table Programming	O	O
24	PLU Stock Loading or Changing	O	O
26	Tare Table and Scale Unit Weight Programming	O	
27	PLU Preset-code Key and Display Key Setting	O	O

Submode No.	Programming Job	Terminal	
		Master	Satellite
29	PLU Group Name Programming	O	
30	RKP Message Programming	O	
31	Display Message Programming	O	O
35	Amount Limit Setting for the [DISC] Key	O	
42	Set Menu Table Programming	O	
43	Combo Sale Table Programming	O	
45	Guest Check Commercial Message Programming	O	O
46	Day Part Setting	O	
50	Employee Table Setting	O	
51	Job Code/Working Hour Setting	O	
52	Tender Up Table Setting	O	
53	Display Menu Table Setting	O	
60	PLU Preset Price Setting or Changing	O	
71	Printer Setting	O	O
No Sub-mode	% + and % - Preset Rate Setting	O	O
	Selective Itemizer Rate Setting	O	O
	Foreign Currency Exchange Rate Setting	O	
	Store/Register No. Setting	O	O

3.2 Programming Operations Added for In-line Terminals

3.2.1 Terminal Connection Table Setting (Submode 69)

This submode is required for in-line services. Enter the In-line ID No. and the Register No. of each terminal (including the Master Terminal) connected to the in-line cable.

CONDITION Any time outside a sale

OPERATION Mode Lock: SET and RTR Declaration is ON.
(Use the SET Mode Keyboard Sheet after depressing the [RTR] key on the REG Mode Keyboard Sheet.)

Through the Operator Display

Select "1 PROGRAMMING".

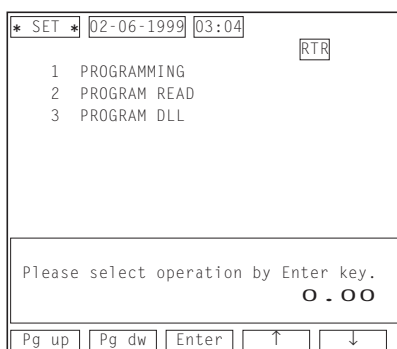

Select "69 CONNECT REG".

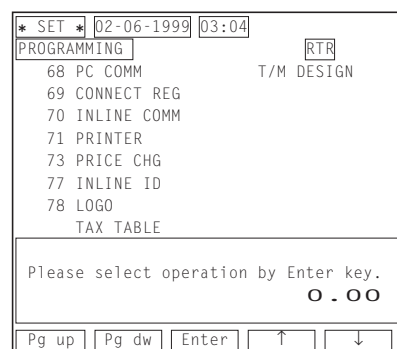

Through the Keyboard

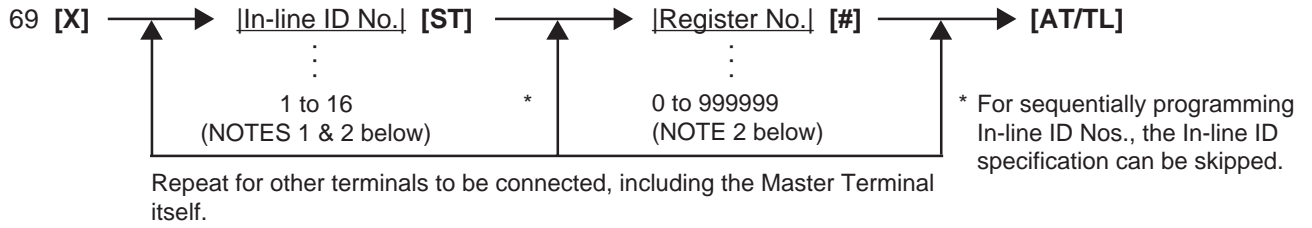

ex.) To set the following.

Master Terminal	ID No. 1	Register No. 3001
Satellite Terminal	ID No. 3	Register No. 3002

Mode Lock: SET/RTR Declaration is ON.

```
69 [X]
  1 [ST] 3001 [#]
  3 [ST] 3002 [#]
[AT/TL]
```

Journal Print



- NOTES:**
- In-line ID No.: Master Terminal 1 (fixed)
Backup Master Terminal (if connected) 2 (fixed)
Satellite Terminals..... 3 to 16 (max. 14 terminals)
However, a number of the connectable terminals differs depending on your system configuration. Refer to the chapter 1. SYSTEM CONFIGURATION of the Operator's Guide.
 - The In-line ID No. and Register No. of each terminal to be set here must be the same as those programmed for the terminal in In-line Terminal ID Setting (Submode 77) and Store/Register No. Setting (no submode) in Chapter 5 in the Manager's Guide for stand-alone level.
 - To delete an individual terminal from the Terminal Connection Table, enter 0 in place of the In-line ID No. in the above operation pattern.
 - To delete the entire Terminal Connection Table once set, operate:
69 [X] → 0 [AT/TL]
 - If a deleting operation (individual or entire deletion) is performed, the files occupied by the deleted terminal(s) (such as Floating Cashier File, etc.) are canceled. Therefore, a deleting operation should be performed only when the system is to be re-built or a terminal is to be detached from the system.

3.2.2 Terminal ID Setting (Submode 77)

This submode is available for in-line terminals (including the master and backup master terminals) . It must be operated separately on each terminal since the Terminal ID should vary from terminal to terminal. The data set in this submode is used as the in-line address of the terminal for in-line service operations.

CONDITION

Any time outside a sale

OPERATION

Mode Lock: SET and RTR Declaration is ON (for the Master Terminal)
 Mode Lock: SET (for other terminals)
 (Use the SET Mode Keyboard Sheet after depressing the [RTR] key on the REG Mode Keyboard Sheet.)

Through the Operator Display

Select "1 PROGRAMMING".

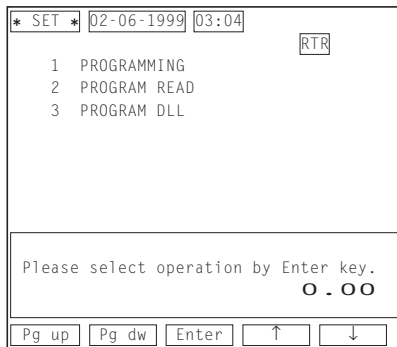

Select "77 INLINE ID".

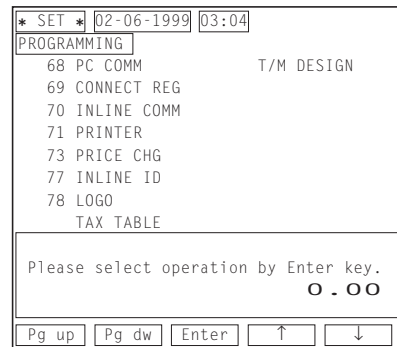

Through the Keyboard

77 [X] → [Terminal ID No.] → [AT/TL]
 1: Master
 2: Backup Master
 3 to 16: Satellites

ex.) To assign Terminal ID No. 4 to a satellite terminal of the in-line system:

Mode Lock: SET
 77 [X] 4 [AT/TL]

Journal Print



NOTE: Be certain not to set the same terminal ID No. to terminals on the in-line system. If terminals with the same ID No. exist on the in-line system, malfunction may occur.

3.3 Verification of Programmed Data Related to In-line Specifications

The programmed data related to in-line specifications can be read for verification purposes.

CONDITION

Anytime outside a sale (Sign OFF required under Cashier Signing Method)

OPERATION

Mode Lock: X or SET
(RTR Declaration is unnecessary on the Master Terminal.)

- Terminal Connection Table 169 **[AT/TL]**
- Terminal ID Setting 177 **[AT/TL]**

- NOTES:**
1. Verifications listed in the Manager's Guide of the standalone level are also available on all the terminals of the in-line system.
 2. The verification of Terminal Connection Table can be executed on the Satellite Terminals after the DLL operation.

4. DLL (Down-Line-Loading) OPERATIONS

In an in-line system (Master-Satellite system), most programming data are set on the Master Terminal and down-line-loaded (DLL) to the Satellite Terminals. The DLL operations introduced in this chapter are pure DLLs, i.e. merely loading the data programmed in the Master Terminal to Satellite Terminals. DLLs automatically performed with programmed data changes are introduced in the next chapter. If any other DLLs not introduced in this and next chapters are required, ask your TOSHIBA TEC representative. Please also note that Terminal Designation (see Chapter 1) can be operated prior to a specific DLL operation, to designate Satellite Terminals that receive the DLL.

WARNING!

Never try to perform a DLL operation other than those in the following list. If you perform it and mistakenly change important data, a malfunction may occur on your completed system.

4.1 DLL Job List

Submode No.	DLL Job	Remarks
501	Store Name/Message, Commercial Message, Footer Logo Message Programming	
502	Cashier Programming	NOTE on the next page
503	Department Table Programming	
504	PLU Table Programming	
505	Time/Date Setting	
507	Hourly Range Setting	
508	Amount Limit Setting for Function Keys and Guests	
512	Non-taxable Limit Amount and Gratuity Rate Setting	
513	Minor Group Name Programming	
514	Major Group Name Programming	
519	Combination Report Table Programming	
526	Tare Table and Scale Unit Weight Programming	
527	PLU Preset-code Key and Display Key Setting	
529	PLU Group Name Programming	
530	RKP Message Programming	
531	Display Message Programming	
535	Amount Limit Setting for the [DISC] Key	
542	Set Menu Table Programming	
543	Combo Sale Table Programming	
545	Guest Check Commercial Message Programming	
546	Day Part Setting	
552	Tender Up Table Setting	
553	Display Menu Table Setting	
569	Terminal Connection Table Setting	
500	%+ and %- Preset Rate Setting Selective Itemizer Rate Setting Foreign Currency Exchange Rate Setting	

NOTE: DLL is possible only when the non-floating cashier feature is used.

- CONDITION** Terminals including the Master: Any time outside a sale
(Sign OFF condition is necessary for the Code Entry Method)
- OPERATION** Satellite Terminals: Any position if the power is ON
Master Terminal: Mode Lock: SET
RTR Declaration: ON

Through the Operator Display

Select "3 PROGRAM DLL".

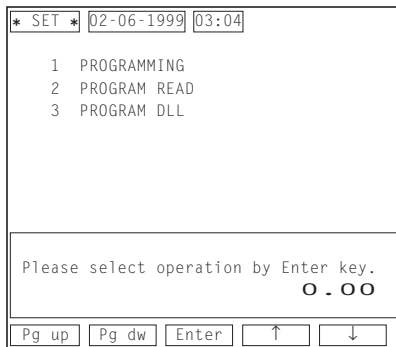

Select a DLL item you want to perform.

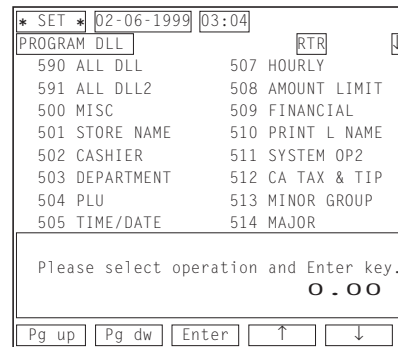

Through the Keyboard

[X X X] → [AT/TL]
Submode No.

4.2 Print Format of DLL Operations

Master Terminal Receipt

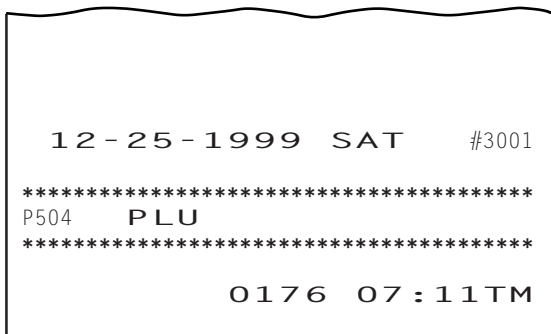

Satellite Terminal Journal



Time of receiving the DLL

5. PLU MAINTENANCE

In this chapter, adding, changing, or deleting operations related to PLU Table program data are described. These are operated on the Master Terminal only. All of these operations are loaded into Satellite Terminals at the same time.

5.1 PLU Table Addition/Change/Deletion with DLL (Submode 63)

This submode can be operated only on the Master Terminal in an in-line system. This submode allows additions/changes/deletions of PLUs in the PLU Table File (generated by Submode 4 in the Manager’s Guide for stand-alone level). The data entered in this submode is immediately loaded into Satellite Terminals, item by item.

■ Programming or Changing

CONDITION All the terminals: Anytime outside a sale

OPERATION Mode Lock: SET and RTR Declaration is ON
(Use the SET Mode Keyboard Sheet after depressing the **[RTR]** key on the REG Mode Keyboard Sheet.)

Through the Operator Display

Select “1 PROGRAMMING”.

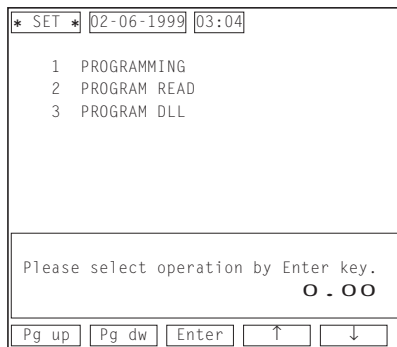

Select “63 PLU ADD/CHG” from the program menu screen.

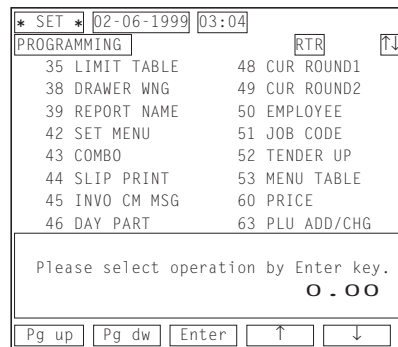

Through the Keyboard

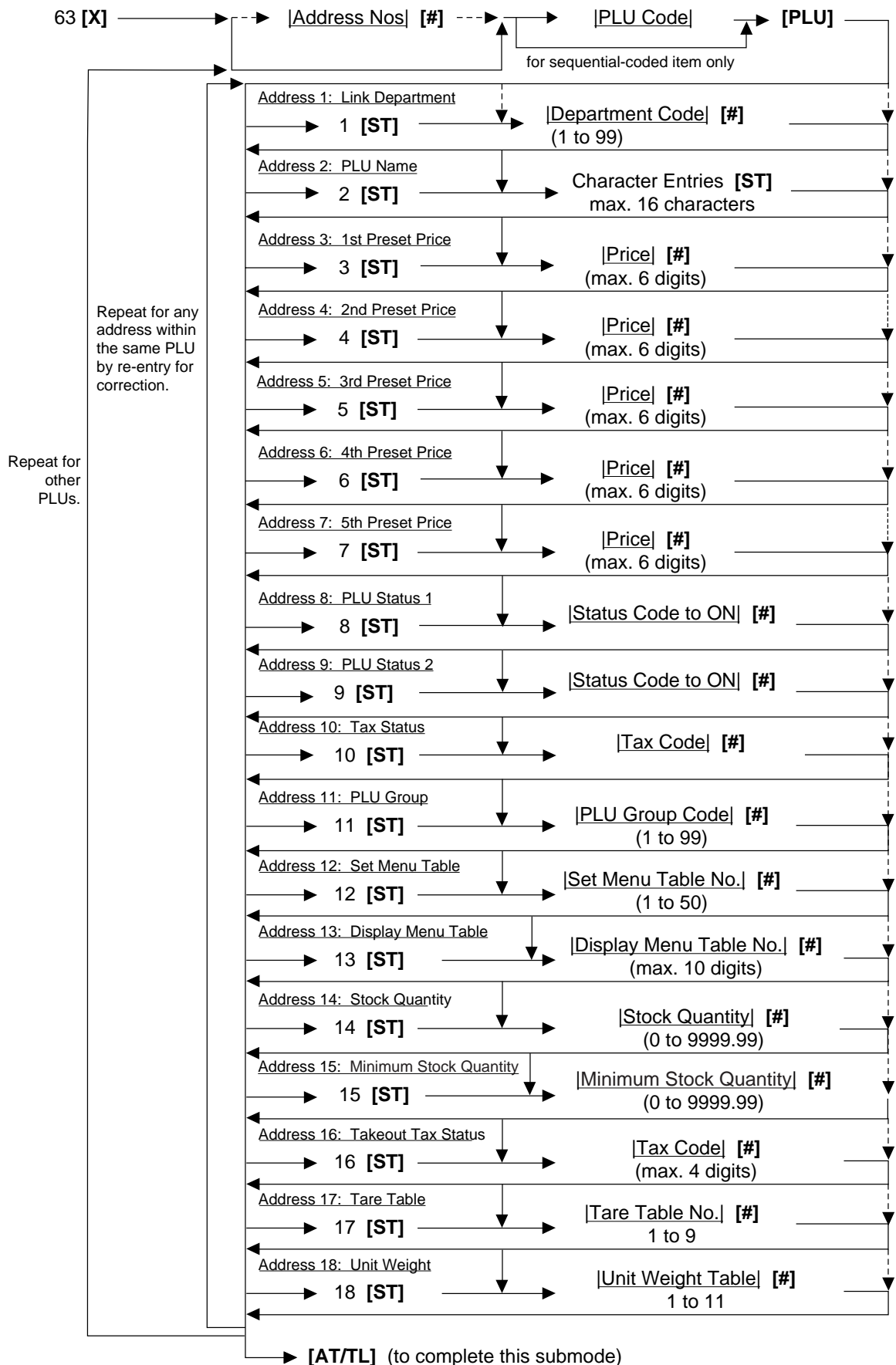

■ Deletion

CONDITION The sales data of the required PLUs are zero and all terminals are outside a sale, programming, or report taking operations.

OPERATION Mode Lock: SET and RTR Declaration is ON

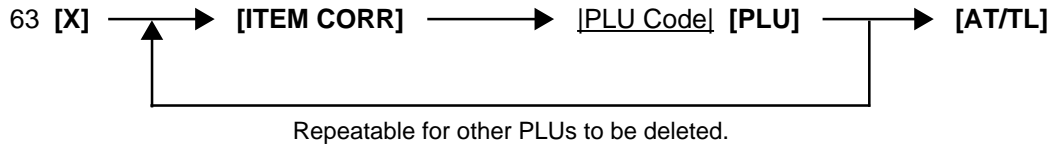

- NOTES:**
1. When the **[AT/TL]** key is depressed in the above operation, the master terminal sends each satellite terminal (or the designated satellite terminals) the DLL start command to make it "HOLD" condition. And then, the master terminal sends the DLL data to each terminal. After the DLL is completed, the master terminal sends each terminal the DLL end command to release it from "HOLD" condition. However, a program option allows you to perform a DLL operation even while each terminal is not in idle status.
 2. A maximum of 100 PLU tables can be added or changed in one DLL operation sequence.

5.2 PLU Price Change with DLL (Submode 73)

This DLL operation is used to change a PLU price on each price level, and send the data to each satellite terminals.

CONDITION Any time outside a sale for Master or Satellite

OPERATION Mode Lock: SET and RTR Declaration is ON

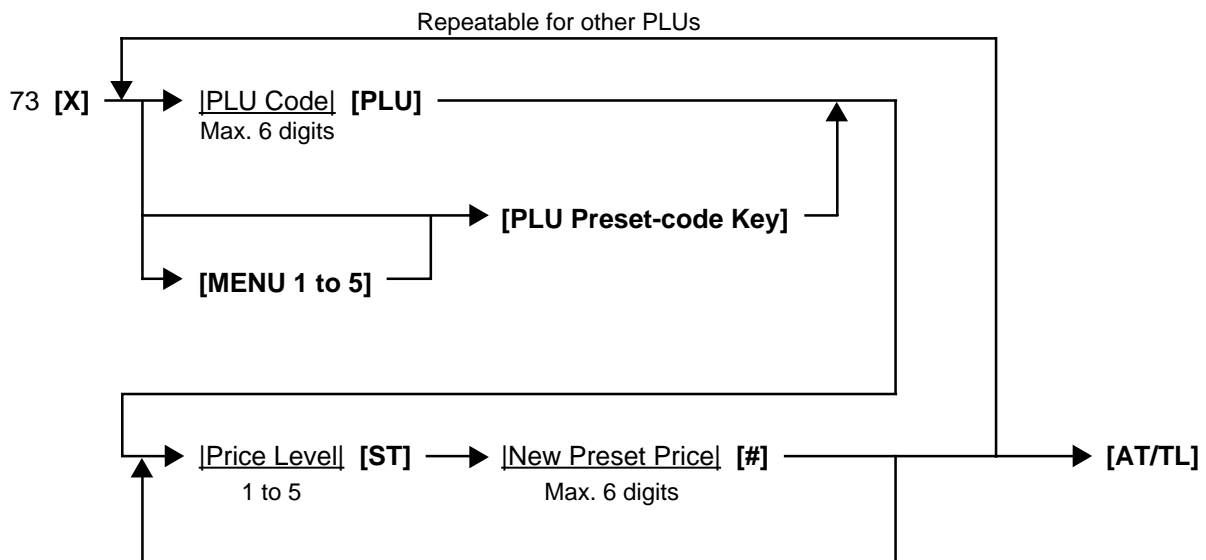

Repeatable for a price change of another price level. When you change the price of each price level in numerical order, the price level designation can be skipped.

- NOTES:**
1. When the **[AT/TL]** key is depressed in the above operation, the master terminal sends each satellite terminal (or the designated satellite terminals) the DLL start command to make it "HOLD" condition. And then, the master terminal sends the DLL data to each terminal. After the DLL is completed, the master terminal sends each terminal the DLL end command to release it from "HOLD" condition. However, a program option allows you to perform a DLL operation even while each terminal is not in idle status.
 2. A maximum of 100 PLU prices can be changed in one DLL operation sequence.
 3. When zero is entered as the New Preset Price value, the PLU is set with a zero price. When the New Preset Price entry is skipped and the **[#]** is simply depressed, it will be an open-price PLU.

6. INQUIRY

In the master-satellite system, the data files regarding the following inquiries between the master terminal and each satellite terminal are maintained in the master terminal center file. Each time an item regarding the data files are performed on each satellite terminal, the master terminal searches and checks the corresponding file and responds to the inquiring terminal by sending a result. Also, when an item is finalized on the satellite terminal, the master terminal will update the data file regarding the item.

- Cashier Occupy and Cancel Inquiry (Floating Cashier Feature)
- Check Track (Guest Order Table) Occupy and Cancel Inquiry
- Customer File (Regular Customer and New Customer) Inquiry
- Employee Clock-in/Clock-out Occupy and Cancel Inquiry
- Cashier Change Occupy and Cancel
- Receipt and Journal Print Data Transmission
- RKP Print Data Transmission
- Printer Status Check

7. BACKUP FUNCTION

(ONLY WHEN THE BACKUP MASTER IS CONNECTED)

(1) Function

- By connecting the backup master terminal (BM) , the various files stored in the master terminal (M) can be backed up.
- The terminal assigned to ID No. 2 will function as a backup master terminal (BM) . By programming ID No. 2 in the terminal connection table and downloading this data to each terminal, the system will function as a system in which the backup master terminal (BM) is connected.
- By changing terminal ID from 2 to 1, the backup master terminal (BM) will function as the master terminal (M).

<Files to be Backed Up>

Cashier Table (When the floating cashier system is used)	Program data Sales data
Check Track (Guest Order) Table	Sales data
Item Buffer	Sales data
PC Transmission Information Table	Program data
Employee Table	Program data Sales data
Job Code/Working Hour Table	Program data
Customer File Table	Program data Sales data

NOTE: *Data capture (DC) transaction files are not backed up.*

- Sales data is backed up on a real-time basis.
When sales data of the master terminal (M) is updated, sales data of the backup master terminal (BM) is updated at the same time.
- Backup data check function:
Correspondence between the center files and backup data is checked every certain period of time.
- Backup data update process:
When an error occurs in backup data, the following processing methods can be selected according to the program option setting.
 - (1) Automatic data copy
When the version of the center file stored in the master terminal (M) is different from that stored in the backup master terminal (BM) , registration jobs are automatically prohibited, the backup data is properly exchanged.
While updating the backup data, each inquiry from the terminals may result in a "MASTER IS BUSY" error.
 - (2) Manual data copy
When the version of the center file stored in the master terminal (M) is different from that of data stored in the backup master terminal (BM) , the master terminal (M) gives a short beep at the timing of issuing the long receipt to warn that the data is not backed up properly.
The operator should update the backup data manually.

(2) Procedure

1) Changing Program Data (DLL from the PC)

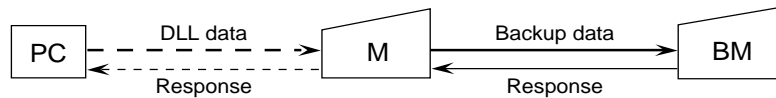

- When various center files from the PC are received via DLL, the master terminal (M) backs up program data and sales data of the backup master terminal (BM) automatically and sends the result to the PC.

2) Changing Program Data (Operated on the Master Terminal)

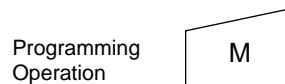

- When various center files are being programmed on the master terminal (M), the backup error flag of the relevant file is turned on. (At this time, backup data is not updated.)
- * For details about the backup error flag, refer to 5) Backup Error Flag.
- * For an explanation of the backup data update process, refer to 6) Backup Data Update Process.

3) Updating Sales Data

- After each satellite terminal sends an affect data of which sales data is subject to the data backup to the master terminal, the same data is sent to the backup master terminal and the sales data is updated.

4) Checking Backup Data

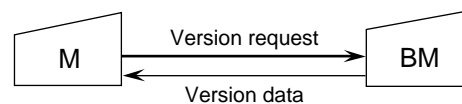

- The master terminal (M) sends the version request command to the backup master terminal (BM) every certain period of time and receives version information about the backup data.
- The master terminal (M) checks correspondence between the version information received from the backup master terminal (BM) and the center files (stored in the M). If an abnormality is found, the backup error flag is turned on.
- When a master job is being performed on the master terminal (M) ([RTR] key turned on), or a PC job is being performed backup data is not checked.

5) Backup Error Flag

- When there is any difference between the data stored in the master terminal (M) and the backup data stored in the backup master terminal (BM), the master terminal (M) turns on the backup error flag of the file in which a difference was found.
- There are the following five cases when the backup error flag is turned on.
 - ① The master terminal (M) changes the programming of the center files.
 - ② A version error is found at the backup data check.
 - ③ The backup job fails after the center file has been downloaded from the PC.
 - ④ Updating of the backup data fails after the center files have been reset.
 - ⑤ Updating of the backup data fails after the center file (containing Read counter) has been read.
 - ⑥ The backup master terminal (ID No. 2) is added to the terminal connection table.

- While the backup error flag is on, the following operation is performed.
The master terminal (M) gives a short beep at the timing when the long receipt is printed to warn that a backup error has occurred.
- There are two timings cases the backup error flag is turned off.
 - ① The backup data is properly backed up according to the backup data update process.
 - ② The backup master terminal (ID No. 2) is deleted from the terminal connection table.

6) Backup Data Update Process

(This is a process required when the backup data stored in the backup master terminal (BM) is not updated properly due to an error.)

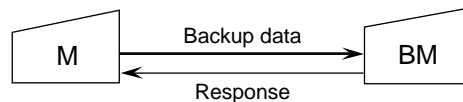

- The method for processing the backup error is selected according to a program option setting. Even if the automatic data copy operation is selected, data copy can also be performed manually.
 - ① Automatic data copy
When the backup error flag is on (or turned on) , the master terminal (M) automatically sends to the backup master terminal (BM) the file in which the error has occurred, and updates the backup data.
 - ② Manual data copy
The backup data is updated by the manual operations of the operator.
- * When the backup data is being updated, inquiries from terminals may result in a “MASTER IS BUSY” error.
- * When a “MASTER IS BUSY” error occurs, clear the error using the **[C]** key. Then, update the backup data again after the master job (backup process) is complete.
- * Only the files with the backup error flag turned on are sent to the backup master terminal (BM) to update the backup data.
- * When the master job is being done on the master terminal (M) (**[RTR]** key is turned on), backup data is not checked or updated.

7) Manual Copy of Backup Data

OPERATION ON MASTER TERMINAL: Mode Lock Z/RTR Declaration ON
900 **[AT/TL]**

8. DATA CAPTURE FUNCTION

- (1) Function
To make it possible to transfer data to the PC, the details of registration jobs performed on each terminal are pooled in the master terminal (M) as transaction data.
- (2) Buffering Transaction Data
When a terminal performs the finalize operation, transaction data entered in registrations is sent to the master terminal (M). The master terminal (M) receives the transaction data and pools it in the transaction buffer.
The transaction data is controlled usually in two buffers. One is for buffering transaction data and the other is for collecting data from the PC. (When one buffer becomes full, or when the collection request is issued from the PC, the buffer in use is released for the PC, and the other buffer is used for subsequent buffering.)
- (3) Collecting Transaction Data
The transaction data stored in the master terminal is sent to the PC according to the request from the PC. If the buffer becomes full when the master terminal receives the transaction data request command from the PC, the transaction data of the full buffer is sent to the PC. If the buffer is not full, the transaction data in the buffer (the buffer used for buffering) is sent to the PC.
- (4) Processing when the Transaction Buffer is Full
When transaction data is received from the terminal (BM, S), the master terminal checks the vacant area of the transaction buffer. If the received transaction data cannot be stored in the buffer, the master terminal sends to the terminal a response indicating that the buffer is full. The terminal receiving this response, performs journal printing indicating that the transaction data is missing.
- (5) Supplementary
 - Only when the transaction data capture function is selected by program option, transaction data can be sent/received and buffered.
 - There is no warning reporting the remaining capacity of the transaction buffer.
 - Once the transaction data collection command is issued, data in one buffer is collected.
(When data in two buffers is required, this command should be issued twice.)

9. MASTER AND BACKUP MASTER ALTERNATION

The Backup Master Terminal can be changed to be used as the Master Terminal for an accident that the Master Terminal becomes down, etc. And the Master Terminal can be changed to be used as the Backup Master when it comes back from repair, etc.

To switch from the Backup Master Terminal function to the Master Terminal function:

- ① Disconnect the master terminal from the line.
- ② When other terminals are in registration operation, finalize and cashier sign-off, or Cashier Key to OFF operations should be performed.
Since a transmission error occurs at this time, an inquiry job should be completed.
- ③ Change the backup master terminal address from 2 (BM) to 1 (M). (Therefore, the backup master terminal will function as the master terminal.)
Refer to Terminal ID Setting (Submode 77) on Chapter 3.
- ④ Delete the backup master terminal from the terminal connection table on the master terminal.
(Reprogramming is required.)
Refer to Terminal Connection Table Setting (Submode 69) on Chapter 3.
- ⑤ Download the terminal connection table.

The following files are guaranteed when the recovery process is performed. If a file is used in another terminal when the master terminal goes down, however, data stored in the terminal is not guaranteed.

- Files controlled in the master terminal (cashier file, etc.)
- PC transmission information

The following files and data are lost when the master terminal goes down.

- Transaction file for data capture
- Files controlled locally on the master terminal
- Data in the files which are used by other terminals when the master terminal goes down.

10. TRANSMISSION ERROR

When a terminal makes an inquiry but a communication error occurs for some reason and the inquiry to the other station is not possible, the message "IRC CONNECT ERR" is displayed on that terminal and operation is stopped.

When the Master Terminal cannot access the inquiring file because the Master Terminal is receiving DLL data, the backup data is being updated between the Master and the Backup Master terminals, etc., the message "MASTER IS BUSY" is displayed and operation is stopped.

10.1 Cause of Error

10.1.1 "IRC CONNECT ERR"

- Communication with the other station is not possible due to a connection error (cable cut, Master Terminal's Power-OFF, etc.).
- Communication was made, but due to a text error, the other station cannot recognize it correctly.

10.1.2 "MASTER IS BUSY"

Cannot access the inquiring file due to the following causes:

- The Master Terminal is receiving DLL data from the PC.
- Programming operations are under way on the Master Terminal.
- Backup data updating process is under way.

10.2 Error Display

IRC CONNECT ERR

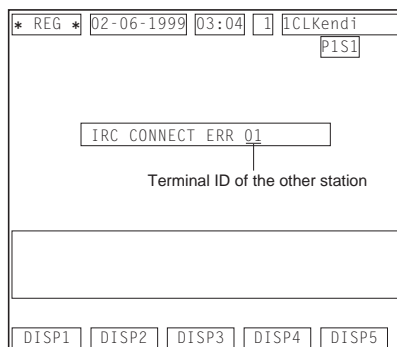

MASTER IS BUSY

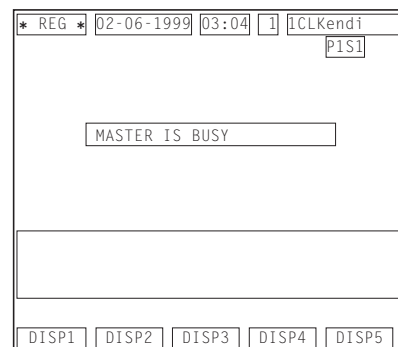

NOTE: Depressing the [C] key cancels the error status.

10.3 Error Canceling Process

There are two error-canceling processes in accordance with the inquiring job contents.

Type 1: Depressing the **[C]** key will return to the status before the inquiry.

Applicable Jobs:

- Check Track Occupy Declaration
- Check Track Sale Item Entry Inquiry
- Cashier Occupy Inquiry
- Guest Table Inquiry
- Employee Clock-in/Clock-out Occupy Inquiry
- Cashier Change Occupy Inquiry

Type 2: Depressing the **[C]** key will cancel the error status, displays the following message, and waits for **RETRY** or **CANCEL**.

Applicable Jobs:

- Check Track Affect
- Check Track Table Clear
- Check Track Occupy Cancel
- Cashier Affect
- Cashier Cancel Inquiry
- Guest Table Affect
- Employee Clock-in/Clock-out Affect
- Employee Clock-in/Clock-out Cancel Inquiry
- Cashier Change Affect
- Transaction Data Send

* REG *	02-06-1999	03:04	1	1CLKendi
				P1S1
RETRY?				
Please input AT/TL key.				
DISP1	DISP2	DISP3	DISP4	DISP5

For Retry **[AT/TL]** (Performs re-sending to the other station.)

For Cancel **[X]** → **[ST]** (Stops the inquiry, printing on journal "*** X → ST **")

NOTE: The "Cancel" in Type 2 above is only for the case that the other station is in trouble which cannot be recovered by a Retry operation.

11. OTHER OPERATIONS RELATING TO IN-LINE SERVICE

The following are other operations relating to in-line service operations.

11.1 Suspending

This is to be operated for the purpose of suspending an in-line service being executed, when any terminals remain unserved, and of going on to a "RETRY", "INCOMPLETE ENDING", or "CANCEL" operation as the next step.

OPERATION ON MASTER TERMINAL: (Same Lock positions as the in-line job being performed)

Depress **[ITEM CORR]** until the key-in tone is generated.

DESCRIPTION:

The SUSPENDING operation is allowed any time during an in-line service procedure.

If suspending by the **[ITEM CORR]** key is accepted, the Master terminal's display indicates the number of unserved terminals. (SUSPENDING of a service execution of one terminal is not possible). Now a "RETRY" or "INCOMPLETE ENDING" operation can be selected as the next step. (When no key-in operations are made in about 10 seconds after a SUSPENDING operation, a RETRY process will automatically be executed.)

11.2 Retry

This is to be operated for the purpose of re-attempting the in-line service that has been stopped due to "TIME OUT" or that has just been suspended by "SUSPENDING" operation.

OPERATION ON MASTER TERMINAL: (Same Lock positions as the in-line job being performed)

Depress **[AT/TL]**.

DESCRIPTION:

The in-line service will again be attempted to the unserved terminals. This operation is possible any number of times after a "TIME OUT" condition or a "SUSPENDING" operation as long as any terminals remain unserved. (When no key-in operations are made in about 10 seconds after a SUSPENDING operation, a RETRY process will automatically be executed.)

11.3 Incomplete Ending

This is to be operated to abandon services to unserved terminals, and ends the in-line service with the services to service-completed terminals only.

OPERATION MASTER TERMINAL: (Same Lock positions as the in-line job being performed)

Depress **[NS]**.

DESCRIPTION:

If an in-line service being executed does not seem to end normally due perhaps to some abnormal status of any Satellite Terminals after "TIME OUT", "SUSPENDING", and/or "RETRY" operations, the **[NS]** key can be depressed to end the in-line service with only the service-completed terminals served and the unserved terminals remaining unserved. In case of In-line X or Z Report Collection sequences, reports of only the service-completed terminals will be issued.

11.4 Cancel

This can be operated when a SUSPENDING condition arises due to a TIME OUT or a SUSPENDING operation. The entire in-line service being performed is canceled. This operation is effective to in-line read report operations but not to any in-line reset report operations.

OPERATION MASTER TERMINAL: (Mode Lock: X)

Depress **[X]**.



TEC

Free Manuals Download Website

<http://myh66.com>

<http://usermanuals.us>

<http://www.somanuals.com>

<http://www.4manuals.cc>

<http://www.manual-lib.com>

<http://www.404manual.com>

<http://www.luxmanual.com>

<http://aubethermostatmanual.com>

Golf course search by state

<http://golfingnear.com>

Email search by domain

<http://emailbydomain.com>

Auto manuals search

<http://auto.somanuals.com>

TV manuals search

<http://tv.somanuals.com>