

Owners Manual

TEC ELECTRONIC CASH REGISTER

MA-1040-100 SERIES

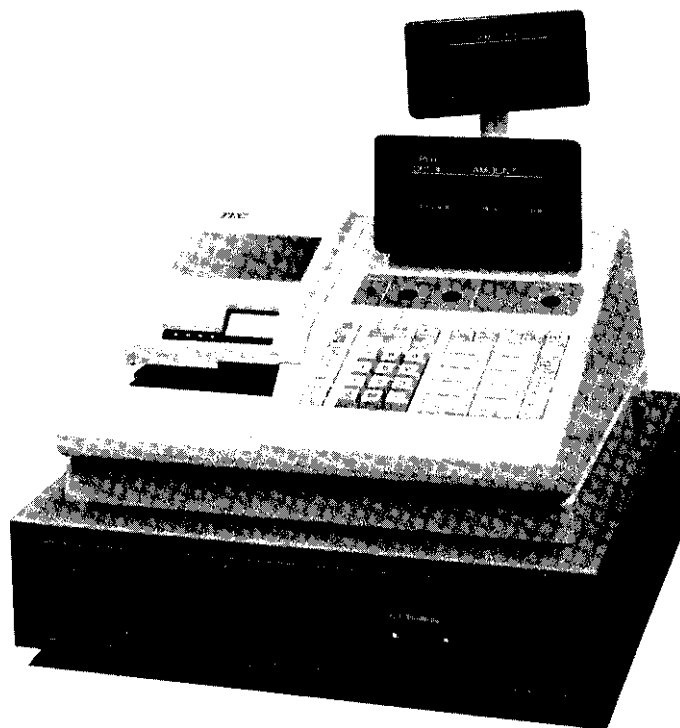

TEC TOKYO ELECTRIC CO.,LTD.

The receipt roll can be advanced even when the [RECEIPT ON/OFF] switch is in the OFF position. Receipt feeding during a sale is also allowed.

JF

JOURNAL FEED ([JF])

This key is used to advance the journal roll in the same fashion as the [RF] key. This key is useful if the cashier, due perhaps to an interruption whilst ringing up a sale, is unsure which items have already been entered. By using this key, the cashier can see which figures have actually been printed.

The [RF] and [JF] keys can not be operated simultaneously.

7	8	9
4	5	6
1	2	3
0	00	

NUMERIC KEYS (|_|)

These are used to enter numeric values such as amount, quantity, or code number.

Depressing the [00] key once is the same as depressing the [0] key twice consecutively.

The maximum listing capacity is 8 digits for inputting a numeric value only, and 7 digits for registration except that a non-add number (through the [#] or [# / NS] key) may be entered in maximum 8 digits.

DECIMAL POINT KEY ([.])

This key is used, as part of the numeric keys, to designate the position of the decimal point when entering a percent rate or a quantity with a decimal portion. For example, to enter 0.5%, index 0→[.]→5, or [.]→5.

When entering a price or amount such as \$0.25, just index 2→5. In this case, depression of the [.] key is not necessary and will cause an error.

000

TRIPLE-ZERO KEY ([000])

This key may be installed as part of numeric keys. Depressing the [000] key once is the same as depressing the [0] key three times consecutively or the same as depressing [0] and then [00] in series.

TABLE OF CONTENTS

	<i>page</i>
TO OUR CUSTOMERS	1
PRECAUTIONS	1
APPEARANCE AND NOMENCLATURE	1
CONTROL LOCKS AND MODE SELECTOR KEYS	2
DISPLAY	3
KEYBOARD LAYOUT	5
FUNCTION OF EACH KEY	5
REGISTERING PROCEDURE FOR SALES	19
REGISTERING RECEIPT SAMPLES	27
VALIDATION PRINT SAMPLES	33
READ (X) AND RESET (Z) REPORTS	35
REPORT PRINT SAMPLES	36
JOURNAL AND RECEIPT PAPER-END DETECTOR	42
PRINTER MOTOR LOCK DETECTOR	42
PAPER ROLL REPLACEMENT AND OTHER MAINTENANCE OPERATIONS	43
WHEN A POWER FAILURE OCCURS	47
SPECIFICATIONS	47

NUMERIC DISPLAY

- AMOUNT (8 digits): Displays the numeric data, such as amount, quantity, etc.
- DPT (2 digits): Displays the code which represents each Department key. It stays lit when repeating the same department entry.
- RPT (1 digit): Displays the repeat count of the same item. The count is indicated from the second entry on, and only the first digit will be displayed even if the count exceeds nine.)
- PLU (3 digits; the DPT and RPT digits are commonly used for this purpose.): Displays the PLU code when any PLU is entered. It goes out when repeating the same PLU entry.

MESSAGE DESCRIPTORS (TRI-MARK LAMPS)

- SLP: Lights up when a slip has properly been inserted to allow validation. It flickers to require a slip insertion when validation compulsion is programmed on the transaction key just operated.
- ALM: Lights up with the alarm buzzer to indicate that the last operation or numeric entry has resulted in an error. To clear the error condition, depress the [C] key.
- REG: Lights up when a sale item has been entered.
- (-): Lights up when the [RTN MDSE], [DOLL DISC], [%-], or [ITEM CORR] key has been operated.
It also lights up when the [ST], [TXBL TL], or one of the total keys has been depressed and the displayed amount is negative.
It lights up also when an amount is entered in the "[-]" mode.
- TXBL: Lights up when a taxable item has been entered. It also lights up when the [TXBL TL] key is depressed, indicating that the amount displayed is the sale total plus taxes due (in which case the "ST" lamp also lights up). This "taxable total display" function is also applied when the [ST] key is depressed if the option "Taxable Total Display on [ST] Key Depression" is selected.
- ST: Lights up when the subtotal amount is displayed after the [ST] key has been depressed.
- TL: Lights up on a finalizing operation with the total amount displayed when a sale is finalized without any amount tendered.
- CG: When an amount tendering operation has been performed, this lamp lights up with the change due displayed.
- SHORT: Lights up when the amount tendered is less than the sale total with the shortage amount displayed.

TO OUR CUSTOMERS

Thank you for choosing a TEC electronic cash register MA-1040-100 series. This instruction manual provides a description of the functions and handling of this register and should be read carefully to obtain maximum performance. Since every consideration has been given to safety, there is no danger of damaging the machine by incorrect operation.

Please refer to this manual whenever you have any doubts concerning the machine. This machine has been manufactured under strict quality control and should give you full satisfaction. However, if the machine is damaged during transit, or there are any unclear points in this manual, please contact your local TEC representative.

- The specifications described in this manual may be modified by TEC, if necessary.
- Be sure to keep this manual for future reference.

PRECAUTIONS

1. The keys on the keyboard work with a light touch. Avoid pressing the keys too hard.
2. Avoid handling the machine with wet hands.
3. Do not apply thinner or other volatile oils to the cabinet or other plastic parts. If dirty, wipe off with a piece of cloth soaked in neutral detergent and squeezed tighly.

APPEARANCE AND NOMENCLATURE

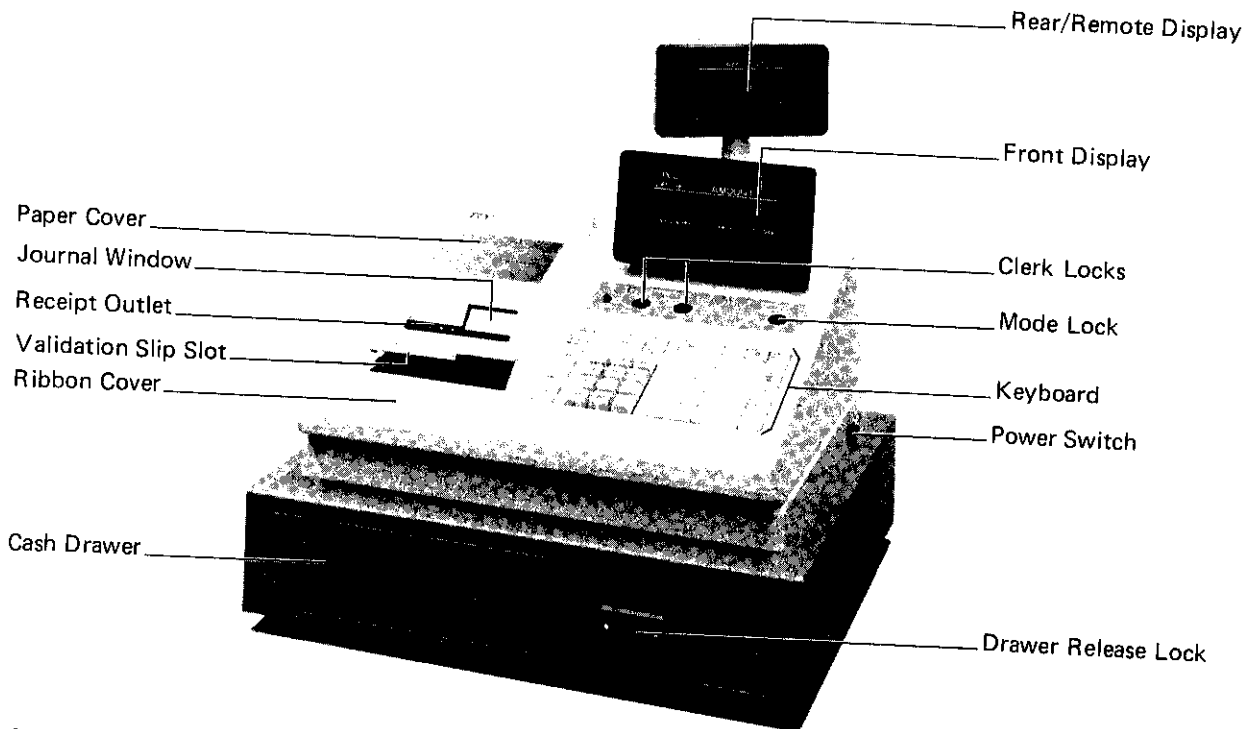

- **Power Switch ...** The power switch is provided at the righthand side of the cabinet. The AC power is turned on when the switch is pushed to ON, and turned off when the switch is pushed to OFF.

CONTROL LOCKS AND MODE SELECTOR KEYS

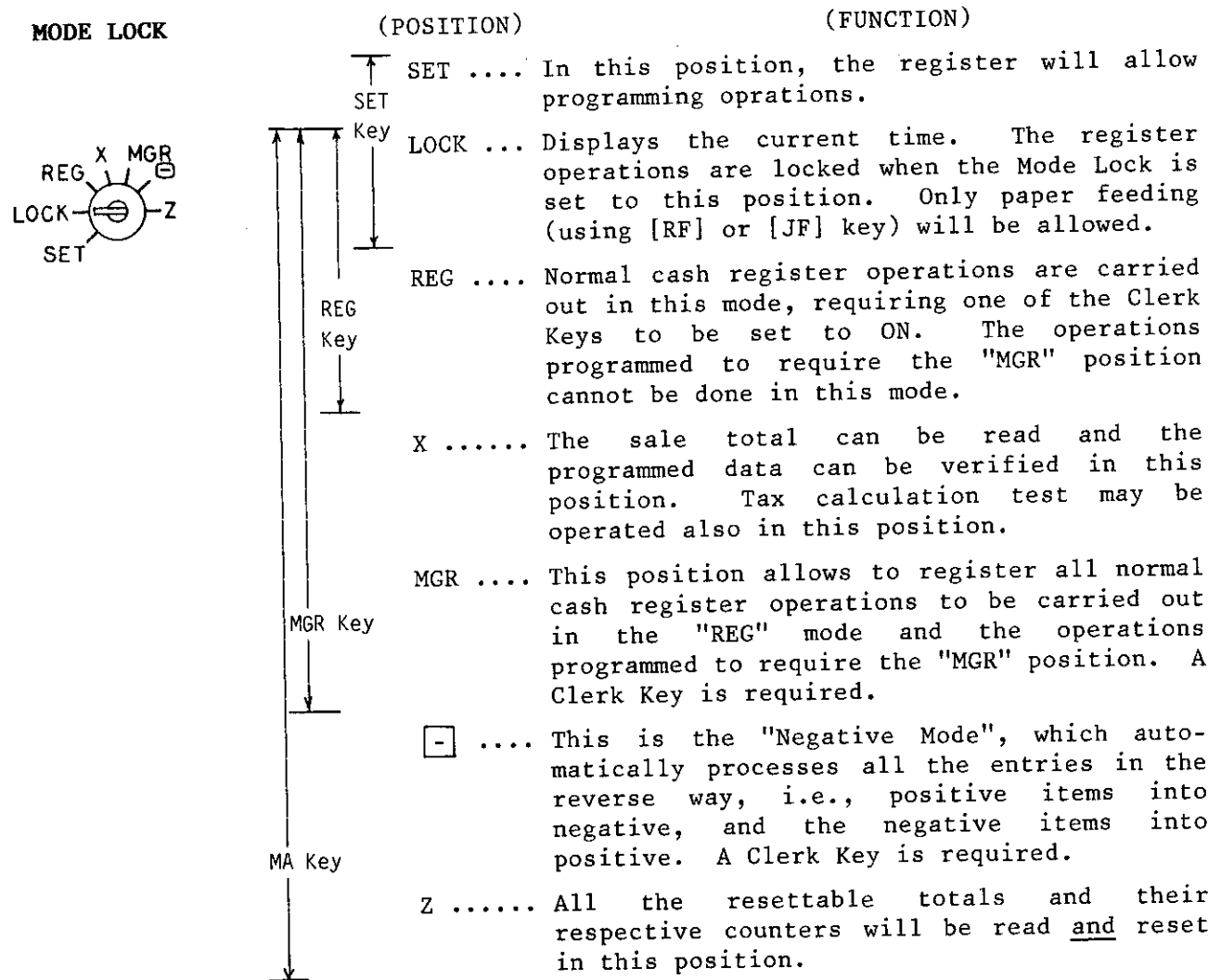

- REG Key:** The REG Key is used by the cashier who operates the register. This key can access the positions of LOCK and REG.
- MGR Key:** The MGR Key is used by the store manager or a person authorized by the manager. This key can access the positions of LOCK, REG, X, and MGR.
- MA Key:** The MA Key is used by the store manager who will daily supervise the collection of money and the printout of transactions recorded by the register. This key can access the positions of LOCK, REG, X, MGR, □, and Z.
- SET Key:** The SET Key is used by the programmer. This key can access the positions of LOCK and SET.

The keys may be inserted or pulled out at the "LOCK" or "REG" position.

1

~

10

DEPARTMENT KEYS ([DEPT])

These are department keys through which sales items are registered. These keys may be programmed as either 'OPEN' or 'PRESET' department keys:

OPEN DEPARTMENT KEY ([Open DEPT])

A department key which has no preset price programmed is an 'OPEN' key and must have a price entered into it manually each time. The price is rung up on the numeric keyboard and then the appropriate department key is depressed. The price is then displayed and printed on the receipt and journal rolls.

When the same department key is depressed more than once after a price entry, the price entry is repeated as many times as the department key is depressed.

To enter a price extended by multiplication, enter the quantity first, depress the [X] key, enter the unit price, and then depress the appropriate department key. A multiplication entry will not be repeated by depressing the department key again.

PRESET DEPARTMENT KEY ([Preset DEPT])

A preset key is a key which has already a price programmed in it. It is therefore unnecessary to enter the price of an item; simply depress the key to register the sale of one item.

To repeat the same preset item, depress the department key as many times as desired.

To multiply a preset department price by a quantity, enter the quantity first, depress the [X] key, and then depress the preset department key.

Each department can be programmed with a preset price, a HALC (High Amount Listing Capacity), positive or negative use, tax status, and a descriptor (the name of the department or its merchandise in a maximum of 8 alpha/numeric characters).

When a department is programmed as a negative department, a price entry can not be repeated by depressing the department key again. Neither can a price entry be repeated when the [RTN MDSE] or [PR OPEN] key has been depressed prior to any department key depression.

A department key may be programmed to be used as single-item entry keys. See the "Single-item Department Keys" description below.

Single-item Department Keys

A Single-item Department Key is used to quicken a single cash sale item entry process, instead of depressing an ordinary itemized department key and [AT/TL] key. On depressing this key, the sale is finalized and a receipt is issued. Any number of the department keys installed on the keyboard may be programmed as Single-item Department Keys.

Additional Department Keys

A maximum of 20 department keys (including the present department keys) are available.

C

CLEAR KEY ([C])

This key is used to correct a numeric entry error or a declaration key (such as [RTN MDSE]) entry error prior to depressing a motorized key (such as [DEPT]) or to correct any error condition and cancel the alarm tone.

If the [C] key is depressed after a subtotal is once obtained, the subtotal amount is again displayed. If the sale total plus taxes is once obtained by the [TXBL TL] key or the [ST] key with the "Taxable Total Display" option, depressing the [C] key thereafter will display the sale total plus taxes.

X

QUANTITY EXTENSION (MULTIPLICATION) KEY ([X])

This key is used to multiply a department or PLU item entry by a quantity.

The basic order of multiplication is:

QUANTITY → [X] → UNIT PRICE

As for details of multiplication for various cases, refer to the "REGISTERING PROCEDURE FOR SALES" section in this manual.

The QUANTITY can be a maximum of 3 integral digits and 3 decimal digits, and the UNIT PRICE may be a maximum of 6 digits. The product must not exceed 7 digits. When a decimal portion is required for the quantity, use the [.] key.

Usually, the fraction below the least significant digit will be rounded off. However, it may be programmed to be discarded or rounded up by the system option.

PR
OPEN

PRESET OPEN KEY ([PR OPEN])

This key is used to modify the status of preset department keys. When the [PR OPEN] key is depressed prior to depressing a preset department key (either before or after the numeric entry), the preset department key is reversed to non-preset (i.e. open) and allows amount entry through the numeric keyboard.

If a preset department is entered with a price through the numeric keyboard using the [PR OPEN] key in the manner just mentioned, no repeat operation for the same price entry is then possible for that department key.

The [PR OPEN] key can not be used with the [PLU] key.

LC
OPEN

LISTING CAPACITY OPEN KEY ([LC OPEN])

This key is used to release the listing capacity pre-programmed on each Department (or on each open PLU linked to the department accordingly). To operate, depress the [LC OPEN] key before depressing the department key (either before or after the amount entry), or any time before the [AMT] key in an open PLU entry sequence.

By depressing the [LC OPEN] key, the HALC (High Amount Listing Capacity) of the department will be released to allow a numeric entry with two further digits.

In order to allow an amount entry exceeding the value defined above, the Mode Lock must be turned to the 'MGR' position by the store manager.

Repeat operation will be possible on a department or an open PLU even when the [LC OPEN] key is depressed for the item entry.

OPEN

PR-AND-LC OPEN KEY ([OPEN])

This is a dual-function key that has both [LC OPEN] and [PR OPEN] key functions.

#

NON-ADD NUMBER PRINT KEY ([#])

When the Mode Lock is in the REG, MGR, or position, this key is used to print a non-adding number (such as Customer No., Check No., Credit Card No., etc.) on the receipt and journal for future reference.

To operate, enter a maximum of 8-digit number and then depress this key. The number is then printed. This operation may be performed any time between items, before or after all the sale items (if operated before finalizing the sale).

ITEM
CORR

ITEM CORRECT KEY ([ITEM CORR])

This key is used to delete the last item within a transaction.

Depressing this key once will remove the last line item from the bill, printing a line through that item on the receipt and journal.

The item-correct function is effective even when a numeric entry and a [C] key depression are already performed between the item-to-be-corrected and the [ITEM CORR] key depression. However, if any other key-in operation including an error comes inbetween, the item-correct will not function for the last line item any more.

The [ITEM CORR] key may function to delete the last item entered through a positive department, PLU, [%+], [%-], [DOLL DISC], [R/A], [PO], or [TAX](Manual Tax) key. But a department or PLU item entered with the [RTN MDSE] key cannot be item-corrected. Neither can a negative department or PLU, an entry through any media key, [ST], any line item of non-add number, or an item-correct entry itself be item-corrected.

VALI
DATE

VALIDATION KEY ([VALIDATE])

This key is used to print a validation slip.

To operate, after registering the required item, insert a slip into the validation slot and depress the [VALIDATE] key. The item and the amount will be printed on the slip.

If the "SLP" lamp flickers, it means that validation compulsion is programmed for the last item entered. In this case, operate a validation print as described above. No other operations will be allowed until the compulsory validation is executed.

Print or non-print of the date and/or the consecutive No. is a programmable option. Also programmable are single- or mutli-validation (number of times of validation print for the same item), validation compulsion on certain transaction keys, etc.

%+

PERCENT CHARGE KEY ([%+])

This key is used to add a percent rate to a sale. If the preset rate is to be added, depress the [%+] key without a prior numeric entry. If a rate different from the preset one is required, enter the desired rate on the numeric keyboard and then depress the [%+] key. The manual rate will take priority.

To operate, depress the [%+] key either immediately after a department or PLU entry if only that item requires the percent addition, or after the [ST] key has been depressed if required on the total bill. The percent rate and the amount are printed and added to the sale total.

TO ENTER THROUGH PRESET PLU:

[PLU Code] → [PLU] ... The preset price will automatically be read and entered.
1- to 3-digit number To repeat the same PLU price, depress the [PLU] key only, after the above operation.

TO ENTER THROUGH OPEN PLU:

[PLU Code] → [PLU] → [PRICE] → [AMT]
... The price indexed through the numeric keys will be entered.
To repeat the same PLU item and price, depress the [AMT] key only, after the above operation.

As for quantity extension involving PLUs, refer to the [X] key description and the "REGISTERING PROCEDURE FOR SALES" section.

Each PLU is programmed with a 3-digit PLU Code, a 2-digit linked Department Code, 6-digit Preset Price / Open-price Status, and 8-character descriptor (name of the PLU or its merchandise). The tax status, Single-item/Itemized Status, and the Positive/Negative Status will be ruled by the statuses of the department to which the PLU is linked. The listing capacity of an open PLU is also ruled by the HALC of the linked department.

AMT

AMOUNT KEY ([AMT])

This key is used to enter an amount or price for an open PLU. Refer to the description for the [PLU] key on the previous page to this page.

RTN
MDSE

RETURNED MERCHANDISE KEY ([RTN MDSE])

This key is used for refunding money to a customer who has returned goods to the store.

To operate, depress the [RTN MDSE] key any time during a department or PLU entry sequence (quantity extension is also possible) before depressing the final key of the sequence. (The final key: [DEPT] for a department entry, [PLU] for a preset PLU entry, [AMT] for an open PLU entry) The amount is automatically printed and deducted from the bill.

PO

PAID OUT KEY ([PO])

A paid-out transaction is used when an amount of money is removed from the cash drawer without relating to a sale. When the [PO] key is used, the amount entered is subtracted from the Cash-in-drawer Total but does not affect the sales totals.

To operate, enter an amount taken from the cash drawer and depress the [PO] key while the register is in an out-of-sale condition. This operation may be carried out as many times as required within a receipt if multiple paid-out items are registered in one transaction. The paid-out amounts recorded are finalized by the [AT/TL] key (i.e. for cash payments only).

The [ITEM CORR] is effective to delete a payment just recorded with a depression of the [PO] key, if before the transaction is finalized by the [AT/TL] key.

This key will not function when the Mode Lock is in the position.

ST

SUBTOTAL KEY ([ST])

This key is used to obtain the subtotal amount during a sale. When this key is depressed after all the items have been rung up, the subtotal of the sale is printed and displayed.

The displayed amount content differs depending on a system option selection:

"[ST] Key Displays Taxable Total" Option

In this case, the taxable total (sale total + taxes) will be displayed on depressing [ST], while the subtotal (sale total without taxes) will be printed.

"[ST] Key Displays Subtotal" Option

In this case, the subtotal (sale total before adding taxes) will be displayed and printed.

If the [ST] key is depressed more than once consecutively, the first depression only will print and display the amount; further depressions will only display but not print the amount.

A programmable option provides the selection not to print but only display the amount even on the first depression of the [ST] key.

Mandatory depression of this key prior to finalizing is another programmable option (applied only when the "[ST] Key Displays Taxable Total" option is selected).

The percent rate may be within the range from 0.001 to 99.999%. The fraction resulted from the percent calculation is usually programmed to be rounded off. However, it can be programmed to be rounded up or discarded.

Usually, [%+] key operations may be performed as many times as required after obtaining the subtotal. However, it can be programmed to prohibit more than once.

%-

PERCENT DISCOUNT KEY ([%-])

This key operates in the same fashion as the [%+] key except that operation will subtract from instead of adding to a sale.

DOLL
DISC

DOLLAR DISCOUNT KEY ([DOLL DISC])

This key is used to subtract an amount from the sale total such as a discount during a sale. This key can not normally be used outside a sale. An amount exceeding the sale total can not normally be entered. However, when the "Credit Balance" option has been selected, this key can be used inside or outside the sale and over-subtraction of the sale is allowed.

To operate, enter the discount amount on the numeric keyboard, and then depress the [DOLL DISC] key.

R/A

RECEIVED ON ACCOUNT KEY ([R/A])

A received-on-account transaction is used to identify money which in the drawer but not business. The amount entered is thus included in the In-drawer Total but not in the sales totals.

To operate, enter an amount of payment and then depress the [R/A] key. Repeat this operation if multiple payments are entered at a time. The payments thus entered may be finalized by the [AT/TL] (for cash payments). The [CHK TND] and/or [Chg] key may also function to finalize payments received on account if not prohibited in program option. The above operation can only be done when the register is outside a sale.

The [ITEM CORR] key is effective to delete a payment just recorded with a depression of the [R/A] key, if before the transaction is finalized by a media key.

This key will not function when the Mode Lock is in the position.

The [AT/TL] key is also used to finalize received on account payment or paid-out amount entries.

The sale total amount will be printed on the receipt in double-sized characters if it is within a 4-digit value.

CHK TND

CHECK TENDER KEY ([CHK TND])

This key is used to cash a check when the register is outside a sale, or to finalize the transaction as a check payment.

CHECK CASHING

When the register is outside a sale, enter the check amount and depress the [CHK TND] key. A receipt is issued and the drawer is opened to enable exchange. However, this cashing function may be prohibited by a program option.

FINALIZING AS CHECK PAYMENT

For finalizing a sale, enter the amount of the check tendered by the customer and depress the [CHK TND] key. If the amount received is larger than the sale total, the receipt is issued with the change due printed and displayed. Then the change is given to the customer in cash. If the amount tendered is smaller than the sale total, the shortage is displayed, and the customer may pay the additional amount in cash to finalize the sale by depressing the [AT/TL] key.

The [CHK TND] key is usually programmed, as just described, to function as "Tender" key. However, it may be programmed to be used as "Total" key, or as both "Tender and Total" key, just as in the case of the [AT/TL] key.

Over-tendering using the [CHK TND] key is usually allowed. However, it may be programmed to be prohibited.

The [CHK TND] key is also used to finalize received-on-account payment entries when paid in check. However, this function may be prohibited by a program option.

Chg

CHARGE TOTAL KEY ([Chg])

This key is usually programmed as "Credit Total" key. However, it may be programmed to be the key for other media such as payments in credit cards. Thus this key is used as an alternative method of payment for media other than cash and check. To operate, depress the [Chg] key, instead of [AT/TL], to obtain the total and finalize the sale.

This key may finalize received-on-account payments if not prohibited by a program option.

TXBL
TL

TAXABLE TOTAL KEY ([TXBL TL])

This key is used to obtain the amount of sale total plus taxes due. The amount will display only but not print. (This key is not necessary to be installed on the keyboard when the [ST] key is installed and at the same time the option "[ST] Key Displays Taxable Total" (refer to the [ST] key description on page 14) is selected.

In order to allow add-on operations to follow the use of this key, the taxes are not added into any totals until actual finalization is initiated.

Mandatory depression of this key prior to finalizing a sale is a programmable option (applied only when the option "[ST] Key Displays Subtotal" is selected).

AT/TL

CASH AMOUNT TENDER / CASH TOTAL KEY ([AT/TL])

This key is used to record all cash paid on transactions, and will be able to finalize a sale operation. Usually the key is programmed function as both cash tender and cash total key. However, the key may be programmed to operate with enforced tendering only or as a cash total key only.

AMOUNT TENDER FUNCTION

In payment of the sale, enter the amount tendered by the customer, and then depress the [AT/TL] key. The change is automatically computed, displayed, and printed.

When the amount tendered is smaller than the sale total, it prints the amount tendered on the receipt with the balance still due displayed, but the drawer is not yet opened. In this case, as the customer for additional payment in cash and repeat the same tendering operation, or use another media key ([CHK TND] or [Chg]) if the balance due is processed as a sale in that media.

TOTAL KEY FUNCTION

To obtain the total and finalize a cash sale, depress the [AT/TL] key only. The sale is finalized with the total printed and displayed, and the drawer opens.

NOTES: If the [AT/TL] key has been programmed to function as "Tender" key only and the sale total is "0" or negative, no amount tendered can be entered. In this case, the [AT/TL] key will function as the "Total" key, so just depress the [AT/TL] key to obtain the total and finalize the sale.

If the option "[TXBL TL] Key Compulsory" has been selected, the [TXBL TL] key (or the [ST] key programmed with the "Taxable Total Display" function) depression for obtaining the sale total is required before finalizing any sale.

This key is also used, if depressed without an amount entry within a sale, to display the total of only non-taxable items so far entered. Usually, this non-taxable items total is only displayed; however, it may also be programmed to print.

EX

TAX EXEMPT KEY ([EX])

This key is used to exempt the tax(es) from the sale, displaying the sale total of the post-tax-exemption, printing the sale amount portion subject to the designated tax exemption. Only a finalizing operation is possible after an [EX] key depression.

The [ITEM CORR] key can not function to delete an [EX] key entry.

When two tax modifier keys are installed, partial tax exemption as well as all tax exemption may be performed in the following ways:

- [TX1/M] → [EX] to exempt Tax 1 only
- [TX2/M] → [EX] to exempt Tax 2 only
- [EX] only
or
[TX1/M] [TX2/M] [EX]] to exempt all taxes

RECEIPT
ISSUE

RECEIPT POST-ISSUE KEY ([RECEIPT ISSUE])

This key is used to issue the receipt of a sale when the sale has already been finalized with the [RECEIPT ON/OFF] switch positioned to OFF (the sale receipt has not been issued accordingly).

To operate, depress the [RECEIPT ISSUE] key without a numeric entry. The receipt for the last sale is issued, with the sale total only printed but not detail line items. This key will not function if another sale has already been under way.

A program option enables to issue the post-receipt by depressing the [RECEIPT ISSUE] key regardless of the [RECEIPT ON/OFF] switch position.

This key has exactly the same functions and programmabilities as the [CHK TND] key except that the [Chg] key is usually programmed as a "Total" key but not a "Tender" key.

The [AT/TL], [CHK TND], and [Chg] keys are called finalizing (sale-finalizing) keys or media keys, and each of them will be used to finalize a sale according to the media paid by the customer. The short-tendering may be programmed to be prohibited as common program option for those three media keys.

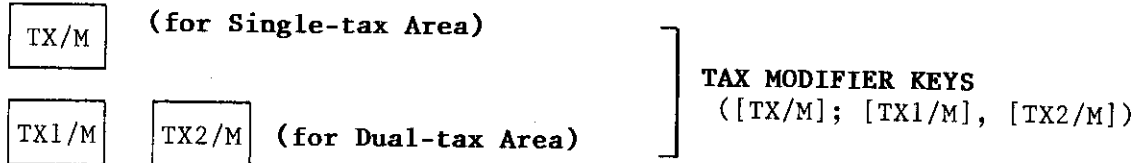

Each of these keys is used to reverse the tax status (taxable/non-taxable status) on departments/PLUs or other tax-status-programmable keys for one entry only. For dual-tax areas, a maximum of two keys should be provided -- [TX1/M] and [TX2/M] -- in place of the [TX/M] key for single-tax areas. The two tax modifier keys will function independently each from the other, with its own tax table pre-programmed for taxable items.

The tax modifier key(s) will be effective to reverse the tax programmed on departemnts, PLUs, [DOLL DISC], [%+], and [%-] keys.

To operate, depress the required tax modifier key(s) prior to depressing any of these function keys above listed, i.e., either before or after the amount entry. Please note that in dual-tax areas each tax modifier key corresponds to its own tax table status. For example, [TX1/M] corresponds to Tax 1 status (e.g. State Tax), [TX2/M] to Tax 2 status (e.g. City Tax), etc.

The tax modifier keys are also used, along with the [EX] key, to exempt required tax (Tax 1 or Tax 2) from the sale. Refer to the [EX] key description to be described later in this section.

TAX

MANUAL TAX KEY ([TAX])

This key is used to enter an irregular tax amount that can not be calculated on the basis of the programmed tax table, and to add it to the sale total by a manual operation.

To operate, enter the desired amount of tax and then depress the [TAX] key. The amount entered is then printed. This tax amount is processed into the Tax 2 memory. Therefore, the tax amount auto-calculated and printed at finalizing the sale (i.e. Tax 1) does not include a manual-entered tax, while the entire sale total printed on the receipt last line does include the manual-entered tax also.

- NOTES: 1. When [ITEM CORR] is depressed after a QUANTITY EXTENSION sequence, the entire product resulted from the multiplication will be deleted.
2. When [ITEM CORR] is depressed after a REPEAT ENTRY sequence, only the last item of the repeated will be deleted.
3. A negative department or PLU item or a returned merchandise item can not be deleted by the [ITEM CORR] key.

NON-ADD NUMBER PRINT

(--- →) |NUMBER, 8 digits maximum| [#](or[#/NS]) → ---

CHECK CASHING (Allowed only outside a sale)

|AMOUNT OF CHECK TO BE CASHED| → [CHK TND]

... The drawer opens and a receipt is issued.
Receive the check and pay the amount in cash to the customer.

- NOTE: 1. Check cashing may be programmed to be prohibited.
2. The [Chg] key may also be operated for cashing if so programmed.

SUBTOTAL READ, TAXABLE TOTAL READ

When "[ST] Key Display Taxable Total" Option is not selected:

--- → [ST] → --- ... The subtotal of the items (sale total not including taxes) entered so far is displayed and printed, but the sale is not finalized. (May not be printed if so programmed.)

--- → [TXBL TL] → --- ... The taxable total of the items (sale total plus taxes) entered so far is displayed but not printed, but the sale is not finalized.

When "[ST] Key Display Taxable Total" Option is selected:

--- → [ST] → --- ... The taxable total of the items (sale total plus taxes) entered so far is displayed, while the subtotal (sale total not including taxes) is printed; but the sale is not finalized. (May not be printed if so programmed.)

- NOTE: If the [C] key is depressed to clear an error or a numeric entry after once obtaining a subtotal or taxable total, the subtotal or taxable total amount will again be displayed.

REGISTERING PROCEDURE FOR SALES

The following are patterns for actual registering operations. In the following examples, " " indicates an input through the numeric keys, "[]" indicates a depression of the transaction key, and "---" indicates other registering and/or finalizing operations.

One of the Clerk Keys must be set to its ON position to start operations. The Mode Lock should usually be set to the "REG" position using the REG Key. However, if the "MGR Requirement" status is programmed on the transaction key or its operation sequence, the clerk must ask the store manager to turn the Mode Lock to the "MGR" position using the MGR or MA Key.

NO-SALE (Allowed only outside a sale)

[NS] (or [# / NS])

DEPARTMENT ENTRY

|PRICE| → [Open DEPT] → ---

[Preset DEPT] → ---

[PR OPEN] → |PRICE| [Preset DEPT] → ---

NOTE: [LC OPEN] may be depressed either before or after the price entry but must be depressed before the department key.

PLU ENTRY

|Preset PLU Code| [PLU] → ---
1 to 999

|Open PLU Code| [PLU] → |PRICE| [AMT] → ---
1 to 999

QUANTITY EXTENSION (MULTIPLICATION)

|QUANTITY| [X] → [Preset DEPT] → ---

[PR OPEN] → |QUANTITY| [X] → ([LC OPEN]) → |PRICE| [Preset DEPT] → ---

|QUANTITY| [X] → ([LC OPEN]) → |PRICE| [Open DEPT] → ---

|QUANTITY| [X] → |Preset PLU Code| [PLU] → ---

|Open PLU Code| [PLU] → |QUANTITY| [X] → |PRICE| [AMT] → ---

NOTES: QUANTITY ... max. 3 integral digits + 3 decimal digits
PRICE (Unit Price) ... max. 6 digits
PRODUCT ... must not exceed 7 digits.

SINGLE-ITEM DEPARTMENT OR PLU ENTRY

The operation patterns in DEPARTMENT ENTRY, PLU ENTRY, and QUANTITY EXTENSION (described on the previous page) are applied. When a single-item department or PLU is entered, the sale is immediately finalized as a cash payment without operating any media keys.

The following operations are not possible with a single-item department or PLU:

REPEAT ENTRY, [%+], [%-], [DOLL DISC], [ITEM CORR], [TAX], [EX], [ST], [TXBL TL], media keys

REPEAT ENTRY (examples to enter three of the same items)

[Preset DEPT] → [Same DEPT] → [Same DEPT] ... → ---

|PRICE|[Open Dept] → [Same DEPT] → [Same DEPT] ... → ---

|Preset PLU Code|[PLU] → [PLU] → [PLU] ... → ---

|Open PLU Code|[PLU] → |PRICE|[AMT] → [AMT] → [AMT] ... → ---

TAX STATUS MODIFICATION (TAXABLE/NON-TAXABLE STATUS REVERSING)

Depress [TX/M] (for tax status reversing in Single-tax Area), or [TX1/M] (for Tax 1 status reversing in Dual-tax Area) and/or [TX2/M] (for Tax 2 status reversing in Dual-tax Area)

before or any time during the following operation patterns (but must be depressed before the last key of the sequence):

DEPARTMENT ENTRY (page 19)
PLU ENTRY (page 19)
QUANTITY EXTENSION (page 19)
SINGLE-ITEM DEPARTMENT OR PLU ENTRY (this page)
REPEAT ENTRY (this page)
PERCENT CHARGE (page 21)
PERCENT DISCOUNT (page 21)
DOLLAR DISCOUNT (page 21)

RETURNED MERCHANDISE

Depress [RTN MDSE] before or any time during the following operation patterns (but must be depressed before the last key of the sequence):

DEPARTMENT ENTRY (page 19)
PLU ENTRY (page 19)
QUANTITY EXTENSION (page 19)
SINGLE-ITEM DEPARTMENT OR PLU ENTRY (this page)

MANUAL TAX ENTRY

--- → |TAX AMOUNT TO BE ADDED| [TAX] → ---

NON-TAXABLE ITEM TOTAL READ

--- → [TAX] → --- ... The total amount of the non-taxable item(s) so far entered within the sale is displayed. If is ususally not printed, but programmable to print also.

TAX EXEMPTION

--- → [TX1/M] → [EX] ... to exempt Tax 1 only

--- → [TX2/M] → [EX] ... to exempt Tax 2 only

--- → | [EX]
or
[TX1/M] [TX2/M] [EX] | ... to exempt all the taxes

Displays the post-tax-exempted sale total while prints the sale amount portion subject to the tax exemption. The above operation must always be followed by the sale finalization.

SALE FINALIZATION BY MEDIA KEYS

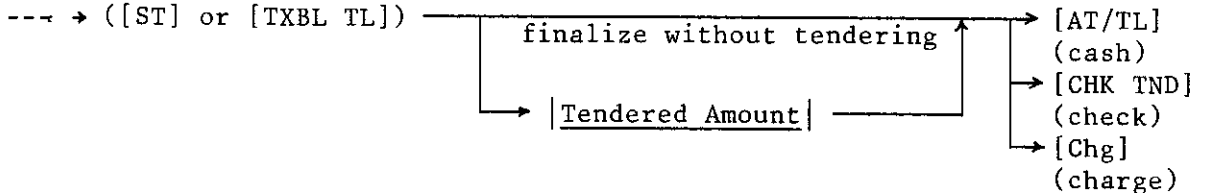

NOTE: Whether each Media Key is depressed with a prior tendered amount entry or not is determined by the option selected for each media key. If the sale total is "0" or negative, any media key must be depressed without a tendered amount entry even if the key is programmed as a "Tender" key. Each of the non-cash media keys may be programmed to prohibit Negative Sale Finalization, Over-tendering, and/or Short-tendering.

MULTI-TENDERING ... Short tendering repeated multiple times by the same media (allowed only when the media key is programmed to allow short-tendering)

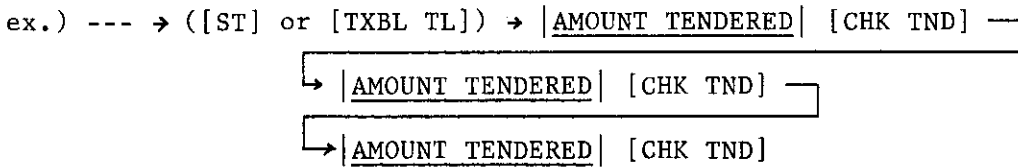

NOTE: The [CHK TND] key may be replaced with [AT/TL] or [Chg] if it is programmed to allow short-tendering.

SPLIT-TENDERING ... Short-tendering repeated multiple times by different media keys (allowed only when the media keys are programmed to allow short-tendering)

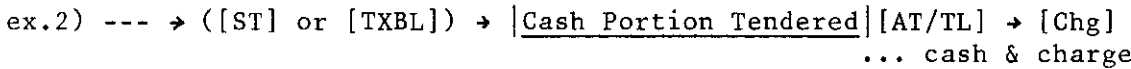
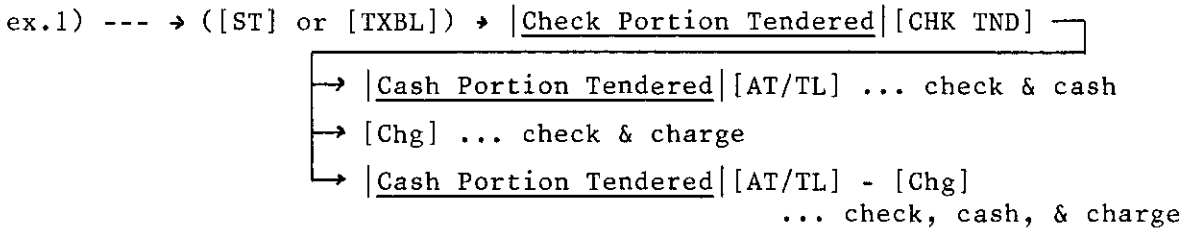

- NOTES: 1. In both MULTI-TENDERING and SPLIT-TENDERING operations, the sale is finalized, a receipt is issued, and the drawer opens on reaching the sale total amount.
 2. If a media key is depressed without an amount tender entry (if the key functions as "Total" key), the sale is then finalized on that stage processing all the balance due into that media.

RECEIVED ON ACCOUNT (Allowed only outside a sale)

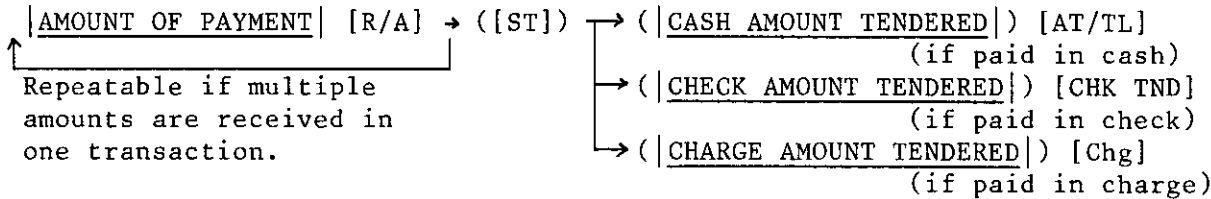

- NOTES: 1. Each of the [CHK TND] and [Chg] keys may not be used for finalizing R/A entries if programmed to be so prohibited.
 2. MULTI-TENDERING and SHORT-TENDERING are applicable to the finalization of received-on-account payments.

PAID OUT (Allowed only outside a sale)

[AMOUNT TO BE PAID OUT] [PO] → ([ST]) → [AT/TL]

Repeatable if multiple amounts to be paid out are recorded in one transaction.

(The [AT/TL] key is the only media key that can finalize paid-out items. That is, only cash may be paid out.)

ENTRY IN THE "[-]" (NEGATIVE) MODE (Mode Lock: [-])

When several items are returned at a time, turn the Mode Lock to the [-] position (using the MA key kept by the store manager). Now enter each item just as in the normal registering operation in the "REG" mode. The [-] position of the Mode Lock processes the entered items exactly in the reverse way, i.e., positive items into negative, and negative into positive.

VALIDATION PRINT

After entering the required item through a transaction key or media key.

→ Insert a validation slip into the validation slot. → [VALIDATION]
Make sure that the "SLP" lamp is steadily lit.

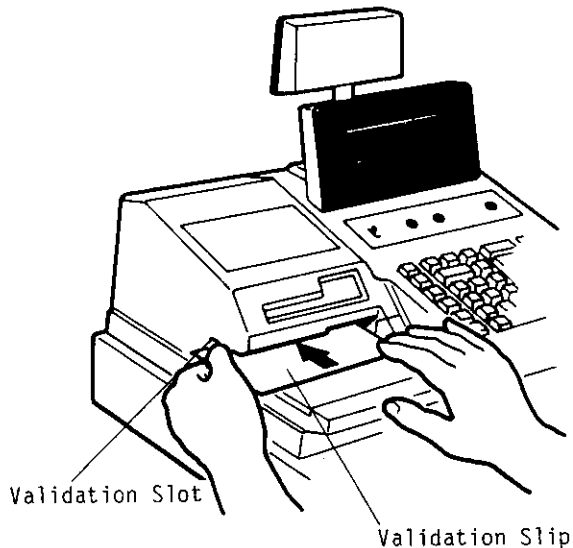

NOTE: 1. No other operations can follow until the validation slip once printed is withdrawn.

2. If the "SLP" lamp flickers during registrations, it indicates that the last item just registered has been programmed to require validation print. In this case, no other operations can follow until the validation print of the item is executed.

3. The following are the programmable selections relating to validation:

- (1) PRINT FORMAT
 - a) Date Print/Non-print
 - b) Consecutive No. Print/Non-print
- (2) MULTI- or SINGLE-VALIDATION (Number of times of validation Print allowed for the same item)
- (3) VALIDATION COMPULSORY status on the following keys:
[AT/TL], [CHK TND], [Chg],
[RTN MDSE], [DOLL DISC], [%-],
[ITEM CORR], [PO], [R/A],
Negative Departments and PLUs

NOTES ON VALIDATION PRINTING: As printing occurs on the bottom side of the paper, please be certain to insert the slip into the validation slot with the printing side downward.

RECEIPT POST-ISSUE (Allowed only outside a sale)

[RECEIPT ISSUE] ... A receipt with the total amount of the last-finalized sale is issued. A program option provides a selection not to issue the post-receipt if the last sale has been finalized with the [RECEIPT ON/OFF] switch positioned to ON.

On a post-issued receipt, the sale total but not detail items of the last sale will be printed.

When another sale is already under way on the register, the [RECEIPT ISSUE] key will not function any more for the last-finalized sale.

REGISTERING RECEIPT SAMPLES

NO-SALE

Thank you
Call again

THANK YOU

12-17-86 #123456

****NOSALE****

JONES 0037 14:08TM

Store Name/Message Stamp

3-line Commercial Message

Date

Store/Reg. No.

No-sale Symbol

Clerk Name

Current Time

Receipt Consecutive No.

CHECK CASHING, NON-ADD NUMBER

Thank you
Call again

THANK YOU

12-17-86 #123456

#12345678
CHECK 5.00

JONES 0051 14:24TM

Non-add Number (e.g. Check No.)

Check Amount Cashed

DEPARTMENT ENTRY, REPEAT, QUANTITY EXTENSION

Thank you
Call again

THANK YOU

12-17-86 #123456

DP01	1.20 T	} Dept.1 Entry Dept.6 Repeat Entries
DP06	2.30	
DP06	2.30	
5X	0.75 @	} Dept.5 Quantity Extension
DP05	3.75	
TAX	0.12	Tax due
CASH	9.67	Sale Total finalized as cash
ITEM	8	} Total Item Count of this sale
JONES	0039 14:10TM	

Taxable Item Symbol

PLU ENTRY, REPEAT, QUANTITY EXTENSION

Thank you
Call again

THANK YOU

12-17-86 #123456

PLU005	1.00 T	} PLU No.5 Entry PLU No.20 Repeat Entries
PLU020	2.00 T	
PLU020	2.00 T	
6X	1.50 @	} PLU No.25 Quantity Extension
PLU025	9.00 T	
TAX	1.40	
CASH	15.40	
ITEM	9	
JONES	0040 14:11TM	

RETURNED MERCHANDISE

Thank you
Call again

THANK YOU

12-17-86 #123456

RETURN
DP06 2.30-
RETURN
PLU020 2.00-T
RETURN
3X 0.50 @
DP02 1.50-T
TAX 0.35-
CASH 6.15-

ITEM -5
JONES 0048 14:21TM

] Dept Item Returned
] PLU Item Returned
] Dept Returned With
Quantity Extension
Negative Cash Sale
Total indicates
the amount to be
refunded to the
customer.

PERCENT CHARGE

Thank you
Call again

THANK YOU

12-17-86 #123456

COFFEE 1.00 T
%-
10% 0.10-
PLU025 1.50 T
SUBTL 2.40
%-
20% 0.48-
TAX 0.19
CASH 2.11

ITEM 2
JONES 0049 14:22TM

] 10% discount from the
above Dept (COFFEE)
item
] 20% discount from the
above subtotal amount

RECEIVED ON ACCOUNT

Thank you
Call again

THANK YOU

12-17-86 #123456

R/A 7.00
R/A 6.50
CASH 13.50

JONES 0059 14:31TM

R/A item
R/A item
R/A Total received
in cash

PAID OUT

Thank you
Call again

THANK YOU

12-17-86 #123456

PO 5.00
PO 6.00
TL 11.00

JONES 0060 14:31TM

paid-out item
paid out item
Paid-out Total

DOLLAR DISCOUNT

Thank you
Call again

THANK YOU

12-17-86 #123456

DP01	3.00 T
DP01	4.50 T
DISC	0.50-T
TAX	0.70
CASH	7.70

ITEM 2
JONES 0042 14:13TM

Discount of \$0.50

TAX EXEMPTION

Thank you
Call again

THANK YOU

12-17-86 #123456

DP01	1.00 T
DP05	1.00
TAX1EX	1.00
CASH	2.00

ITEM 2
JONES 0052 14:26TM

Taxable Item
Non-taxable Item
Sale portion subject to the tax exemption.

ITEM CORRECT

Thank you
Call again

THANK YOU

12-17-86 #123456

BP09	0.50
DP09	5.00
CASH	5.00

ITEM 1
JONES 0050 14:23TM

Dept Item Item-
corrected

VARIOUS SALE-FINALIZING OPERATIONS

Thank you
Call again

THANK YOU

12-17-86 #123456

DP01	5.60 T
PLU005	1.00 T
TAX	0.66
Chg	7.26

ITEM 2
JONES 0056 14:29TM

Charge Total

Finalized as Charge Sale

Thank you
Call again

Cash Tender

THANK YOU

12-17-86 #123456

DP02 5.60 T
PLU005 1.00 T
TAX 0.66
TL 7.26
CATEND 10.00
CHANGE 2.74

Sale Total
Cash Tendered
Change due

ITEM 2
JONES 0054 14:27TM

Thank you
Call again

Check Tender

THANK YOU

12-17-86 #123456

DP01 5.60 T
PLU005 1.00 T
TAX 0.66
TL 7.26
CHECK 10.00
CHANGE 2.74

Sale Total
Check Tendered
Change due

ITEM 2
JONES 0055 14:28TM

Thank you
Call again

Multi-tender

THANK YOU

12-17-86 #123456

DP02 5.60 T
PLU005 1.00 T
TAX 0.66
TL 7.26
CATEND 3.00
CATEND 4.00
CASH 0.26

Sale Total
1st Cash Tendered
2nd Cash Tendered
The rest also finalized
as cash sale

ITEM 2
JONES 0057 14:30TM

Thank you
Call again

Split-tender

THANK YOU

12-17-86 #123456

DP02 5.60 T
PLU005 1.00 T
TAX 0.66
TL 7.26
CHECK 3.00
CATEND 4.00
Chg 0.26

Sale Total
Check Tender Portion
Cash Tender Portion
The rest finalized
as Charge sale

ITEM 2
JONES 0058 14:30TM

NEGATIVE MODE ([-]) ENTRY

ex.) A customer who once purchased items listed in the left receipt comes up to return all the items. The clerk asks the store manager to turn the Mode Lock to the [-] position, and registers all the items, one by one, tracing the customer's receipt or returned items. The contents of the two receipts are same except that the Negative Mode Header is printed on the right one. The total amount in the right-side receipt indicates the amount to be refunded to the customer.

Receipt issued in REG or MGR mode

```

Thank you
Call again

THANK YOU

12-17-86 #123456

COFFEE      1.00 T
  3X      2.00 @
PLU020      6.00 T
DISC        0.30-T
SUBTL       6.70
%-
  10%      0.67-
TAX         0.60
CASH        6.63

ITEM      4
JONES    0063 14:33TM
    
```

Receipt issued in [-] mode

```

Thank you
Call again

THANK YOU

12-17-86 #123456

****REG-      ****
COFFEE      1.00 T
  3X      2.00 @
PLU020      6.00 T
DISC        0.30-T
SUBTL       6.70
%-
  10%      0.67-
TAX         0.60
CASH        6.63

ITEM      4
JONES    0064 14:34TM
    
```

—Negative Mode Header

RECEIPT POST-ISSUE

Ordinary Receipt (to be issued on finalization of a sale)

Thank you
Call again

THANK YOU

12-17-86 #123456

DP05	2.20
PLU025	1.50 T
TAX	0.15
TL	3.85
CHECK	5.00
CHANGE	1.15

ITEM 2
JONES 0067 14:36TM

Post-issued Receipt (for the last-finalized sale,
issued by [RECEIPT
ISSUE] Key)

Thank you
Call again

THANK YOU

12-17-86 #123456

TL 3.85

JONES 0067 14:36TM

Only the Sale Total
line will be printed,
but not detail line
items.

VALIDATION PRINT SAMPLES

RECEIPT PRINT

VALIDATION PRINT

Thank you
Call again

THANK YOU

12-17-86 #123456

DP01 1.00 T

%- 15% 0.15-

PLU020 2.00 T

TAX 0.29

TL 3.14

CHECK 4.00

CHANGE 0.86

ITEM 2

JONES 0068 14:36TM

	Date	Clerk ID	Consecutive No.	Item	Amount
	↓	↓	↓	↓	↓
	12-17-86	1CL0068		DP01	1.00 T

	12-17-86	1CL0068	%-	15%	0.15-
--	----------	---------	----	-----	-------

	12-17-86	1CL0068		PLU020	2.00 T
--	----------	---------	--	--------	--------

	12-17-86	1CL0068		TXBLTL	3.14
--	----------	---------	--	--------	------

	12-17-86	1CL0068		CHECK	4.00
--	----------	---------	--	-------	------

*NOTE: Validation after
[TXBL TL] Key or [ST]
Key (with "Taxable
Total Display" option).

Thank you
Call again

THANK YOU

12-17-86 #123456

#11223344
CHECK 8.00

JONES 0069 14:38TM

12-17-86 1CL0068 #11223344

12-17-86 1CL0069 CHECK 8.00

THANK YOU

12-17-86 #123456

R/A 3.00
R/A 7.50
CASH 10.50

JONES 0070 14:39TM

12-17-86 1CL0070 R/A 3.00

12-17-86 1CL0070 R/A CASH 10.50

THANK YOU

12-17-86 #123456

PO 6.00
PO 4.00
TL 10.00

JONES 0071 14:40TM

12-17-86 1CL0071 PO 6.00

12-17-86 1CL0071 PO TL 10.00

READ (X) AND RESET (Z) REPORTS

The following table shows the key operation to take each report. The "X" and "Z" reports have exactly the same print content if both are available, except that:

1. The "X" report allows to read the totals but not clear memories, while the "Z" report allow to read the totals and at the same time all the resettable memories will be cleared when the report has been issued.
2. The symbol "X" is printed as the header of a "X" report, while "Z" is printed on a "Z" report, to indicate the type of report.
3. A reset count is printed near the bottom of a "Z" report only.

TABLE OF OPERATIONS FOR X AND Z REPORTS

REPORT NAME	KEY OPERATION	SAMPLE PAGE
* AUTO READ * AUTO RESET	Mode Lock: X] [AT/TL] Mode Lock: Z]	36
ZONE PLU READ ZONE PLU RESET	Mode Lock: X] Zone-start PLU Code Mode Lock: Z] ↓ [X] ↓ Zone-end PLU Code ↓ [PLU]	38
ALL PLU READ ALL PLU RESET	Mode Lock: X] [PLU] Mode Lock: Z]	38
* INDIVIDUAL CLERK READ * INDIVIDUAL CLERK RESET	Mode Lock: X] Set the Clerk Key of the Mode Lock: Z] required clerk to ON, 1 [AT/TL]	39
* IN-DRAWER READ	Mode Lock: X [#] (or [# /NS]	40
HOURLY READ HOURLY RESET	Mode Lock: X] 10 [AT/TL] Mode Lock: Z]	40
* GT READ * GT RESET (Accumulated Sales Data to be reset on a weekly or monthly basis but not daily.)	Mode Lock: X] 20 [AT/TL] Mode Lock: Z]	41

- NOTES: 1) The cash drawer will open on the depression of the final key of the KEY OPERATION for the reports marked with "*".
- 2) No clerk key is necessary to issue any of the reports except INDIVIDUAL CLERK READ/RESET reports.
- 3) Refer to the report samples on the following pages. The descriptor of each line may vary according to the programmed data of each store, and some of the counter or total lines may not be printed by print/non-print options.
- 4) As for the PRESET DATA VERIFICATION operations and print samples which are also available in the "X" mode, see the "VERIFICATION OF PROGRAMMED DATA" in the PROGRAMMING MANUAL separately issued.

AUTO READ OR RESET REPORT (Mode Lock: X for Read] depress [AT/TL].)
 (Mode Lock: Z for Reset

Thank you
 Call again

Reset Report Sample

THANK YOU

12-17-86 #123456

Z

Reset Symbol ← → Read Symbol



GT 122.23
 GS 60
 122.23
 DP01 19
 12CU 40.45
 DP02 2
 7CU 24.70
 DP03 12
 8CU 10.75
 COFFEE 2
 2CU 1.80
 DP05 7
 3CU 6.95
 DP06 0
 1CU 0.00
 DP07 0
 0CU 0.00
 DP08 0
 0CU 0.00
 DP09 1
 1CU 5.00
 DP10 0
 0CU 0.00
 NS 43
 89.65
 TAX1 7.48
 NS 43
 97.13
 Z- 2
 1.46
 DISC 1
 0.50

Grand Total (non-resettable)

Gross Sale Item Count
 Amount Total

Department 1 Item Count
 Customer Count / Total

Department 2

⋮

Net Sale (Without Tax) Item Count
 Total

Tax 1 Total (Tax 2 is also printed in dual-tax areas.)

Net Sale (With Tax) Item Count
 Total

← Percent Discount (on Subtotal) Count (Percent Charge, if [%+] Key is installed.)
 Total

Dollar Discount Count
 Total

-- To be continued --

-- Continued --

TOTAL	19CU	All Media Sales Total Customer Count
	95.17	Total Amount
CASH	14CU	Cash Sales Customer Count
	70.40	Amount
CHECK	3CU	Check Sales Customer Count
	17.25	Amount
Chg	2CU	Charge Sales Customer Count
	7.52	Amount
R/A	5	Received on Account Count
	25.00	Total
PO	5	Paid Out Count
	22.00	Total
CAID	55.65	Cash-in-drawer Total
CKID	6	Check-in-drawer Count
	35.00	Total
CORR	1	Item Correction (on positive Departments/PLUs) Count
	0.50	Total
MS VD	0	Item Correction (on other items) Count
	0.00	Total
Z--	4	Percent Discount (on Department/PLU items) Count
	0.85	Total
-DP TL	0	Negative Departments' Item Count
	0.00	Total
RETURN	10	Returned Merchandise Item Count
	11.60	Total
-TAX	0.70	Negative (or Returned) Tax Total
REG--	2	Negative Mode Count
	11.45	Total
TXBL1	74.74	Taxable 1 Total
TAX EX	1CU	Tax-exempted Customer Count
TAX1EX	1.00	Sale Total Portion of Tax 1 Exempted
NOSALE	3	No-sale Counter
VALCTR	11	Validation Counter
JONES		INDIVIDUAL CLERK REPORTS & EACH CLERK RESET COUNT
0001Z		(If the clerk's INDIVIDUAL CLERK RESET report has already been taken before this AUTO RESET report, only the clerk's name and the reset count are printed. Otherwise, each clerk reset report data will be printed here.)
SMITH		
0000Z		
3CL		
0000Z		
4CL		
0000Z		
0001Z		← Auto Reset Report Count (not print in AUTO READ reports)
JONES	0086 15:02TM	

Thank you
Call again

THANK YOU

12-17-86 #123456

X

PLU005	7
PLU005	7.00

JONES 0076 14:52TM

ZONE PLU READ OR RESET REPORT

(Mode Lock: X for Read
Mode Lock: Z for Reset] Enter the Zone-start PLU Code

↓
Depress [X]

↓
Enter the Zone-end PLU Code

↓
Depress [PLU]

Read Report Sample

Sample Operation:
Mode Lock: X, 1 [X] 10 [PLU]

PLU Name / Item Count
PLU Code / Sale Total

(NOTE: In this sample, only one PLU, i.e. PLU No.5 is found in the designated zone No.1 to No.10 with any sales recorded. PLUs in the zone with no sales recorded will not print in PLU reports.)

Thank you
Call again

THANK YOU

12-17-86 #123456

Z

PLU005	7
PLU005	7.00
PLU020	1
PLU020	2.00
PLU025	9
PLU025	13.50

0001Z

JONES 0085 15:02TM

ALL PLU READ OR RESET REPORT

(Mode Lock: X for Read
Mode Lock: Z for Reset] Depress [PLU].)

Reset Report Sample

Reset Symbol ← → Read Symbol

PLU Name / Item Count
PLU Code / Sale Total] one PLU data

] ⋮
]
]

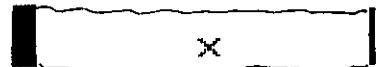

PLU Reset Count (not print in PLU Read Reports)

INDIVIDUAL CLERK READ OR RESET REPORT

(Mode Lock: X for Read] Set the Clerk Key of the required clerk to ON,
 (Mode Lock: Z for Reset] Enter 1, depress [AT/TL].)

```

Thank you
Call again

THANK YOU

12-17-86 #123456

      Z

JONES
GS      60
122.23
NS      43
89.65
NS      43
97.13
TOTAL   19CU
95.17
CAID    55.65
CKID    35.00
NEG1    25.10
NEG2     1.96
PO      22.00
0001Z
JONES  00B3 15:01TM
  
```

Reset Report Sample

Reset Symbol ← → Read Symbol

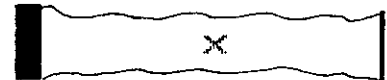

Clerk Name

Gross Sale Item Count
Total

Net Sale (Without Tax) Item Count
Total (Tax Total; optional print)

Net Sale (With Tax) Item Count
Total (alternative option print with NS Without Tax)

Total Customer Count

All Media Sales Total

Cash-in-drawer Total

Check-in-drawer Total

Negative Total 1 (= Negative Depts + Item Corr on DP/PLU + Returned Merchandise + Negative Mode Total + Negative Tax + Percent Discount on DP/PLU)

Paid Out Total

Indiv. Clerk

Reset Report Count
(not print in Clerk Read Reports)

Negative Total 2 (= Percent Discount on Subtotal + Dollar Discount + Item Corr on Other Items)

IN-DRAWER READ REPORT (read only)

(Mode Lock: X, depress [#] or [# / NS].)

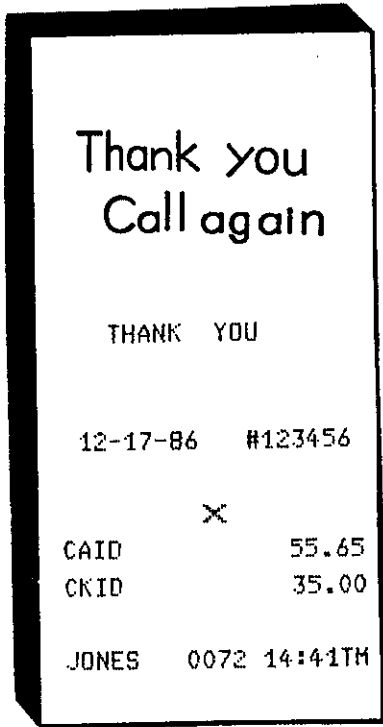

HOURLY READ OR RESET REPORT

(Mode Lock: X for Read] enter 10, depress [AT/TL].)
(Mode Lock: Z for Reset

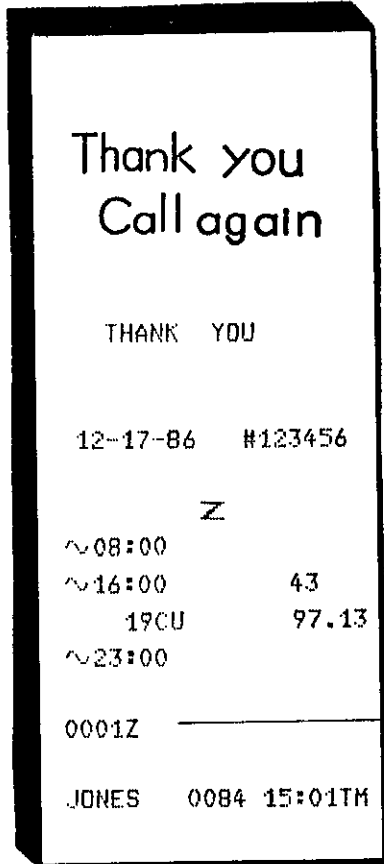

Reset Report Sample

Reset Symbol ← → Read Symbol

Up to 8:00 (No sales data recorded)

8:00 to 16:00 Item Count

Customer Count / Sale Total

16:00 to 23:00 (No sales data recorded)



Hourly Reset Report Count (not print in Hourly Read reports)

GT READ OR RESET REPORT

(Mode Lock: X for Read
Mode Lock: Z for Reset] enter 20, depress [AT/TL])

Thank you
Call again

THANK YOU

12-17-86 #123456

GTZ

GT

122.23

GS

60

DP01

19

DP02

40.45

DP03

2

COFFEE

24.70

DP05

12

DP06

10.75

DP07

2

DP08

1.80

DP09

7

DP10

6.95

0

0.00

0

0.00

0

0.00

1

5.00

0

0.00

GTX

Read Symbol

Reset Symbol

Grand Total
(ever non-resettable)

Gross Sale Item Count
Total

Department
Data

(Refer to
AUTO READ/RESET)

NS

43

TAX1

89.65

NS

7.48

TOTAL

43

CASH

97.13

CHECK

19CU

Chg

95.17

R/A

14CU

PO

70.40

CAID

3CU

TXBL1

17.25

TAX EX

2CU

TAX1EX

7.52

JONES

5

GS

25.00

NS

5

NS

22.00

TOTAL

55.65

TAX

74.74

0001Z

1CU

JONES

1.00

0

60

122.23

43

89.65

43

97.13

19CU

95.17

7.48

7.48

0001Z

JONES

0087

15:03TM

Financial Data

(Refer to
AUTO READ/RESET)

Clerk Data
(Refer to
INDIVIDUAL
CLERK
READ/RESET)

GT Reset Report
Count (not print
in GT Read reports)

JOURNAL AND RECEIPT PAPER-END DETECTOR

- (1) This detects when either the journal or receipt paper is coming near the end. It is provided in order to prompt the operator to replace the old paper roll with a new one.
- (2) When the paper roll comes near the end (or the paper has not been set properly), no key operation (except [RF] and [JF]) will be accepted and the AMOUNT portion of the display will keep flickering.
- (3) When a new paper roll is set, only the [RF] and [JF] keys are allowed to operate. Next, when the [C] key is depressed, the display flickering will be cleared and normal key-in operations will be accepted. If any printing was suspended, it will continue printing.
- (4) If this detector sensed a paper-end condition during printing, the printer will stop after the current line printing is completed.
- (5) The [RF] and [JF] keys are operative regardless of the detector on/off condition.
- (6) If the [C] key is depressed in the paper-end condition, it will be ignored. The [C] key depression will be effective to clear the display flickering only after the new paper roll is set.

PRINTER MOTOR LOCK DETECTOR

- (1) This detects the printer motor lock condition caused by some trouble.
- (2) When such a condition is detected, the front display indicates "Error", and none of the keys (including [RF] and [JF]) will be accepted.
- (3) To regain the normal condition, turn the power of the ECR to OFF, remove the cause of the motor lock, and then turn the power to ON again.

PAPER ROLL REPLACEMENT AND OTHER MAINTENANCE OPERATIONS

INSTALLING THE RECEIPT PAPER

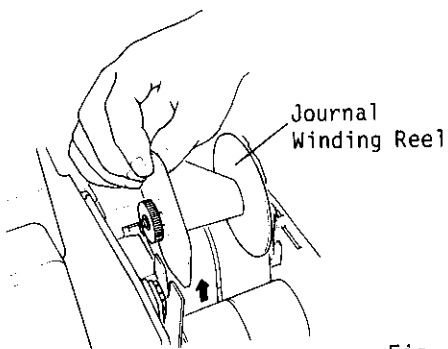

Fig. 1

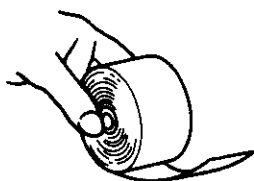

Fig. 2

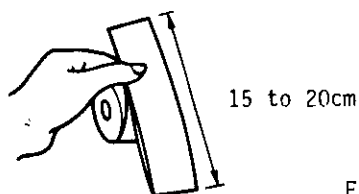

Fig. 3

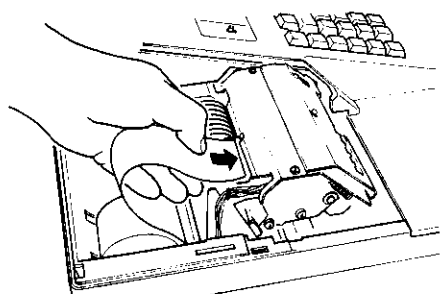

Fig. 4

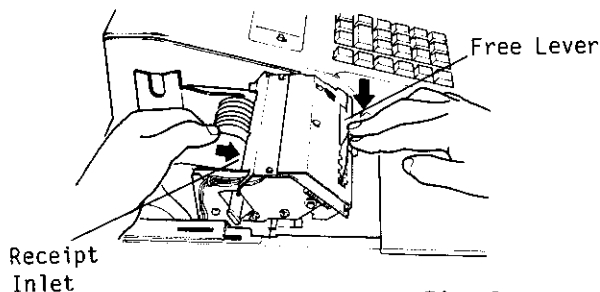

Fig. 5

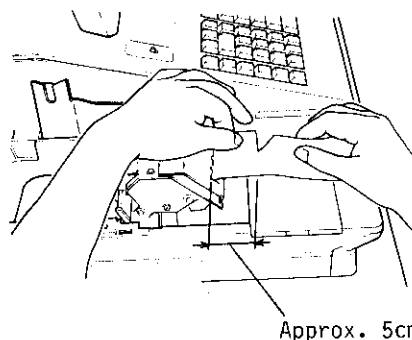

Fig. 6

1. Turn the Mode Lock to the "REG" position with the power on.
2. Remove the Paper Cover, and remove the Journal Winding Reel (Fig. 1).
3. Hold a new paper roll in the direction as shown in Fig. 2 so that the paper end will be fed from the bottom.
4. Fold the paper end firmly as shown in Fig. 3 to ease the insertion.
5. Place the paper roll in the outer-side holder of the two roll holders (Fig. 4).
6. Insert the paper end into the Receipt Inlet, feed the paper in while pressing down the Free Lever (or feed the paper in while pressing the [RF] key). (Fig. 5)
7. When all the folded portion comes out, tear off the unnecessary part with an appropriate end length remaining (approx. 5cm or 2 inches). (Fig. 6)
8. Go on to INSTALLING THE JOURNAL PAPER steps in necessary, or go on to Step 9 below if not.
9. Attach the Paper Cover. Meanwhile, the paper end must be seen outside the cover.
10. Press the [C] key to clear the paper-end condition, and depress the [NS] key to issue a receipt to check if the paper has properly been set.

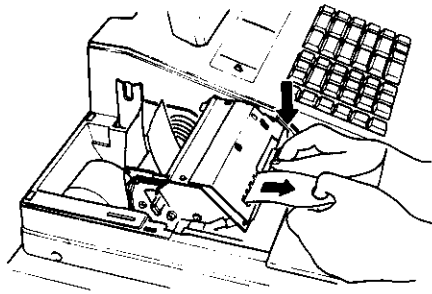

Fig. 7

REMOVING THE RECEIPT PAPER

1. Remove the Paper Cover.
2. Press the Free Lever down and pull the old paper core upward to remove the remaining paper end (Fig. 7).

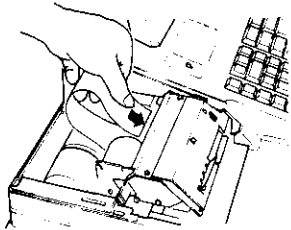

Fig. 8

INSTALLING THE JOURNAL PAPER

1. Turn the Mode Lock to the "REG" position with the power on.
2. Remove the Paper Cover by pulling it upward, and remove the Journal Winding Reel. (Fig. 1)
3. Follow Steps 3 and 4 of INSTALLING THE RECEIPT PAPER on the previous page.
4. Place the paper roll in the inner-side roll holder of the two holders. (Fig. 8)
5. Insert the paper end into the Journal Inlet, feed the paper in while pressing down the Free Lever (or feed the paper in while pressing the [JF] key). (Fig. 9)
6. When the paper comes out for a enough length, wind the paper end on the Journal Winding Reel two or three times, and set the Journal Winding Reel to the Reel Holder. (Fig. 10)
7. Attach the Paper Cover.
8. Press the [C] key before starting operations.

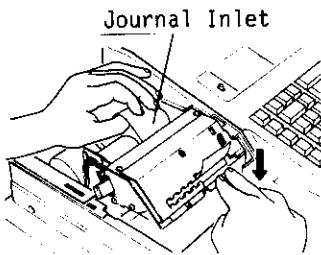

Fig. 9

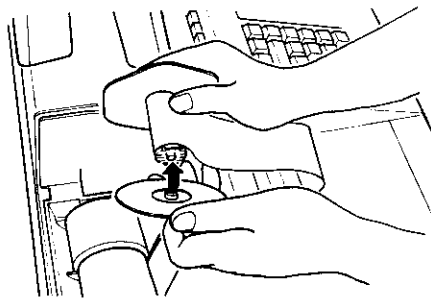

Fig. 10

REMOVING THE JOURNAL PAPER

1. Remove the Receipt Cover.
2. Press the [JF] key to wind up enough portion of the journal paper, and then tear off the paper, holding the Journal Winding Reel.
3. The wound-up portion of the paper can easily be removed from the Reel by pulling it side way (Fig. 11)
4. If enough paper remains on the roll, follow Steps 6 through 8 above; if paper is running out, follow Steps 1 through 8 above.

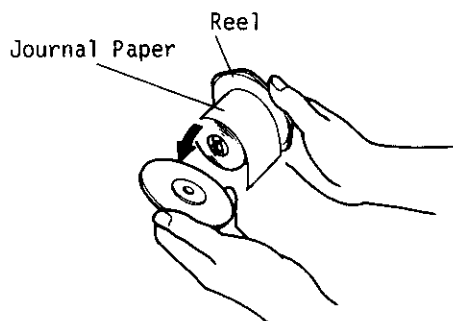
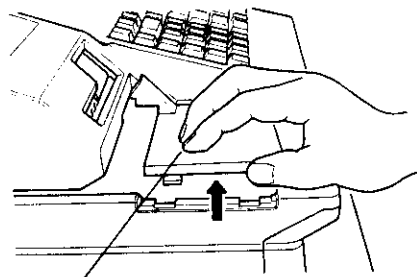
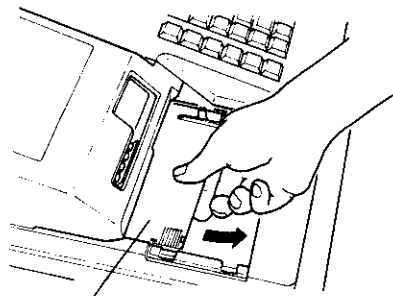

Fig. 11



Ribbon Cover

Fig. 1



Ribbon Cartridge

Fig. 2

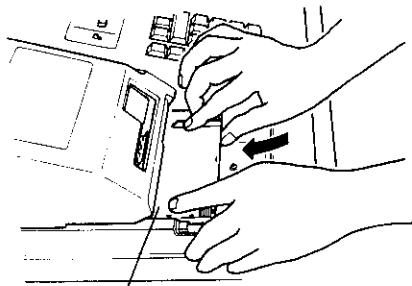

Ribbon Cartridge

Fig. 3

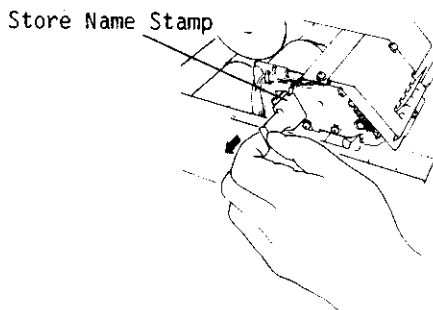

Fig. 4

REPLACING THE RIBBON CARTRIDGE

When the receipt and journal print is too light, replace the ink roll in the following manner:

1. Remove the Ribbon Cover (Fig. 1).
2. Remove the old ribbon cartridge by pulling it toward you (Fig. 2).
3. Install a new ribbon cartridge in the reverse order to Step 2 above (Fig. 3).
4. The ribbon cartridge is a consumable product. Be certain to use genuine ribbon cartridge supplied by your TEC representative

REPLENISHING THE STORE NAME STAMP WITH INK

When the store name stamp is printed too lightly, replenish the ink in the following manner:

1. Turn the Power Switch to OFF. Remove the Paper Cover.
2. Withdraw the store name stamp with the protruding part pinched with your fingers (Fig. 4).
3. Apply ink on the pad on the rear side of the Store Name Stamp. The amount of the refilling should be adjusted according to the density of the printed message, but the limit of 2 cc should not be exceeded. (The ink bottle supplied contains 5 cc of ink) (Fig. 5)
4. Follow the reverse order of Step 2, and then attach the cover.

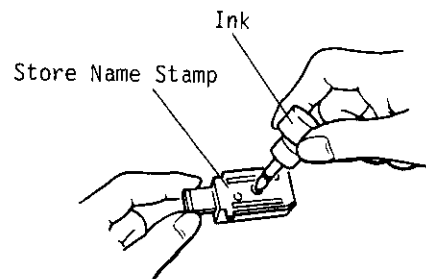

Fig. 5

MANUAL DRAWER RELEASING

The drawer opens automatically when a registration is performed. In the event of a power failure or other troubles, the drawer can be opened manually in the following manner:

1. Insert the Drawer Release Key into the drawer release lock and turn the key clockwise. The drawer will now open. (Fig. 1)
2. The Drawer Release Key can be taken out by returning it to the original position.
3. When the drawer is closed, it is automatically locked and will not open without the Drawer Release Key or normal registering operation.

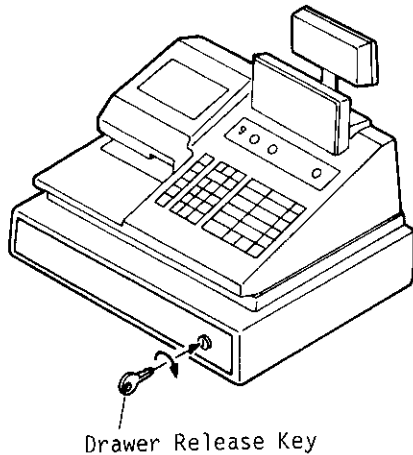

Fig. 1

REMOVING THE DRAWER

1. Pull the drawer out, and when it stops by the stopper, lift the drawer up and pull it again (Fig. 2). When it stops again by the roller fixed in the drawer case, lift it and pull it again (Fig. 3).
2. When returning the drawer, follow the reverse procedure to removing.

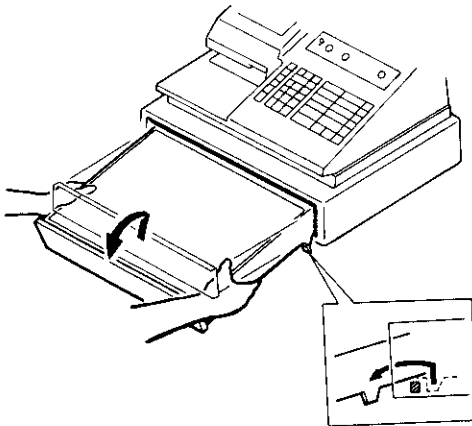

Fig. 2

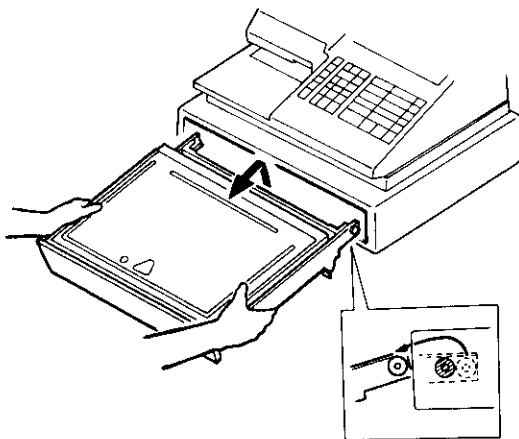

Fig. 3

CDC (Cash Drawer Cover) LOCK

Locking (Fig. 4)

1. Push the Cash Drawer Cover to the drawer-end.
2. Press the cover lightly, insert the key into the key-hole on the cover, and turn it to lock.

Opening

Release the lock by the key, and lift the front end of the cover.

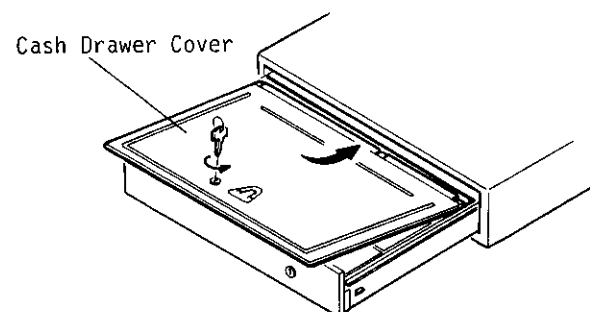

Fig. 4

WHEN A POWER FAILURE OCCURS ...

If a power failure occurs, all sales totals stored in the memories are automatically protected by the battery installed in the ECR. The battery is rechargeable and it is recharged when the AC power returns. As the power returns, the register revives to continue the work and displays the last item entered before the power failure. However, please note the following phenomena to occur on the register when the power is regained:

1. The printer will work to print the entered data without failure after the power recovery, if any data was being printed. However, one extra line may be fed on the power recovery depending on the power recovery timing.
2. The following are the display indications on the power recovery.

ECR CONDITION at the time of POWER FAILURE		DISPLAY INDICATION on the POWER RECOVERY
OUTSIDE A SALE	No key-in has been operated.	"0" display
	Numeric or Declaration keys have been entered but no motorized keys.	Same as above.
DURING A SALE	No Numeric or Declaration keys have been entered.	Regains the display content that was obtained just before the power failure.
	Numeric or Declaration keys have been entered.	Same as above.

In the event of a power failure, it is suggested to check the receipt print content before the receipt is handed to the customer.

SPECIFICATIONS

Size 460mm(width) x 400mm(depth) x 360mm(height)
 Weight 16.5kg
 Power Required AC 100V, 110V, 117V, 220V, 240V 50/60HZ
 (varies depending on the destination.)
 Power Consumed 0.4A at 117V (30W)
 Ambient Temperature 0°C to 40°C, 10% to 90% Relative Humidity
 Size of Receipt and Journal Tape .. 45mm(width) x 80mm(diameter)

VALIDATION SLIP SPECIFICATIONS

- Type of Paper Non-carbon Paper, or Ordinary Paper + Carbon Sheet
- Thickness 0.06mm to 0.2mm (total thickness)
- Max. Number of Duplicates 2 sheets (including the original sheet)
- Size of Slip min. 150mm (width) x min. 70mm (height)

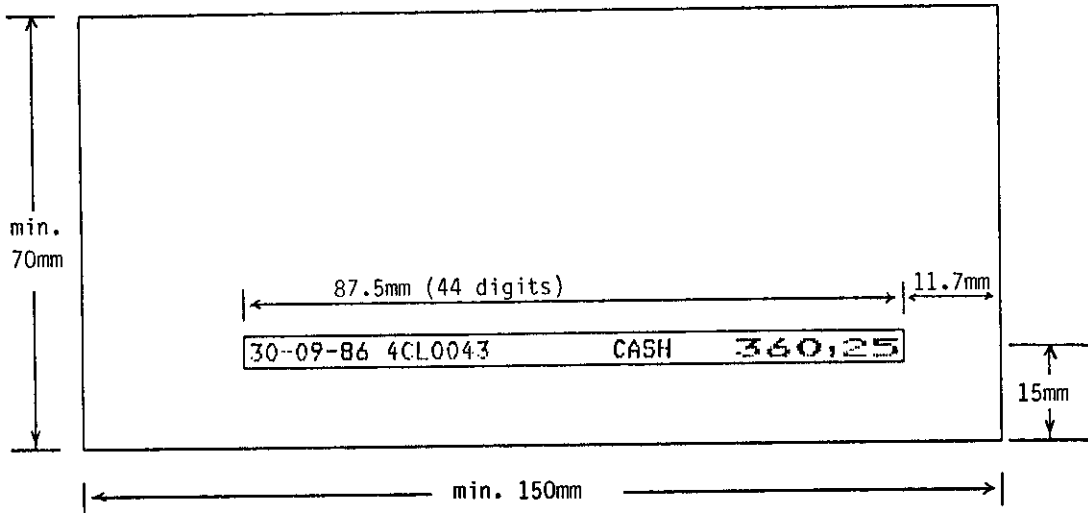

TEC

Free Manuals Download Website

<http://myh66.com>

<http://usermanuals.us>

<http://www.somanuals.com>

<http://www.4manuals.cc>

<http://www.manual-lib.com>

<http://www.404manual.com>

<http://www.luxmanual.com>

<http://aubethermostatmanual.com>

Golf course search by state

<http://golfingnear.com>

Email search by domain

<http://emailbydomain.com>

Auto manuals search

<http://auto.somanuals.com>

TV manuals search

<http://tv.somanuals.com>