

Owners Manual

TEC ELECTRONIC CASH REGISTER

MA-1050-100 SERIES



TEC TOKYO ELECTRIC CO.,LTD.

WARNING

This equipment generates, uses, and can radiate radio frequency energy and if not installed and used in accordance with the instructions manual, may cause interference to radio communications. It has been tested and found to comply with the limits for a Class A computing device pursuant to Subpart J of Part 15 of FCC Rules, which are designed to provide reasonable protection against such interference when operated in a commercial environment. Operation of this equipment in a residential area is likely to cause interference in which case the user at his own expense will be required to take whatever measures may be required to correct the interference.

TABLE OF CONTENTS

	page
TO OUR CUSTOMERS	1
PRECAUTIONS	1
APPEARANCE AND NOMENCLATURE	1
CONTROL LOCKS AND MODE SELECTOR KEYS	2
DISPLAY	4
KEYBOARD LAYOUT	5
FUNCTION OF EACH KEY	6
OTHER OPTIONAL KEYS	15
REGISTERING PROCEDURE FOR SALES	17
READ(X) AND RESET(Z) REPORTS	28
PROGRAMMING OPERATIONS IN "SET" MODE	34
(Refer to the TABLE OF CONTENTS on page 34.)	
PROGRAMMING OPERATIONS IN "MGR" MODE (MANAGER'S PROGRAMMING)	66
CHARACTER CODE TABLE	72
PROGRAMMING OPERATIONS THROUGH THE PROGRAMMING KEYBOARD (optional) ..	73
VERIFICATION OF PROGRAMMED DATA	76
REMOTE SLIP PRINTER OPERATION	79
CUTTER BLOCK OPEN DETECTOR AND PAPER NEAR-END DETECTOR	82
ECR PRINTER MOTOR LOCK AND REMOTE SLIP PRINTER MOTOR LOCK DETECTORS.	83
PAPER ROLL REPLACEMENT AND OTHER MAINTENANCE OPERATIONS	84
POWER FAILURE PROCESS	89
SPECIFICATIONS	89

TO OUR CUSTOMERS

Thank you for choosing a TEC Electronic Cash Register MA-1050-100 series. This instruction manual provides a description of the functions and handling of this register and should be read carefully to obtain maximum performance. Since every consideration has been given to safety, there is no danger of damaging the machine by incorrect operation.

Please refer to this manual whenever you have any doubts concerning the machine. This machine has been manufactured under strict quality control and should give you full satisfaction. However, if the machine is damaged during transit, or there are any unclear points in this manual, please contact your local TEC representative.

- The specifications described in this manual may be modified by TEC, if necessary.
- Be sure to keep this manual for future reference.

PRECAUTIONS

1. The keys on the keyboard work with a light touch. Avoid pressing the keys too hard.
2. Avoid handling the machine with wet hands.
3. Do not apply thinner or other volatile oils to the cabinet or other plastic parts. If the dirt is very bad, wipe off with a piece of cloth soaked in neutral detergent and squeezed tightly.

APPEARANCE AND NOMENCLATURE

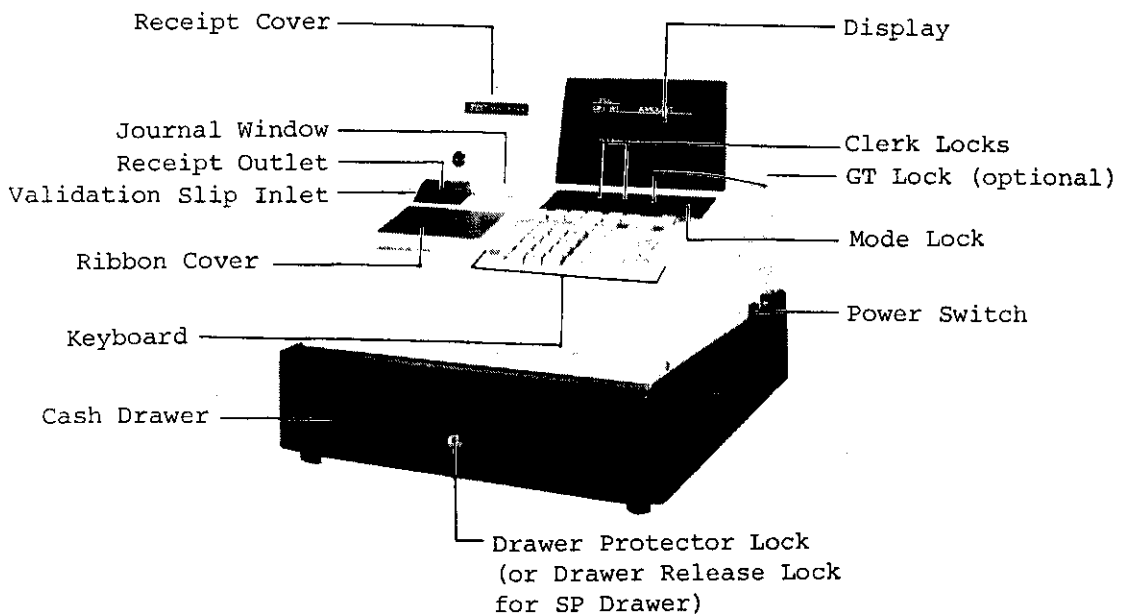

- **Power Switch** ... The power switch is provided at the righthand side of the cabinet. The AC power is turned on when the switch is pushed to ON, and turned off when the switch is pushed to OFF.

CONTROL LOCKS AND MODE SELECTOR KEYS

MODE LOCK

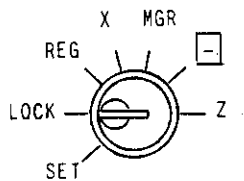

(POSITION)

(FUNCTION)

- LOCK** Displays the current time. The register operations are locked when the Mode Lock is set to this position. Paper feeding (using the **RF** or **JF** key) will not be allowed.
- REG** Normal cash register operations are carried out in this mode, requiring one of the Clerk Keys to be set to ON. The operations programmed to require the "MGR" position cannot be done in this mode.
- X** The sale totals can be read and the programmed data can be verified in this position. Tax calculation test may be operated also in this position.
- MGR** This position allows to register all normal cash register operations to be carried out in the "REG" mode and the operations programmed to require the "MGR" position. A Clerk Key is required.
- ☐** This is the "Negative Mode", which automatically process all the entries in the reverse way, i.e., positive items into negative, and the negative items into positive. A Clerk Key is required.
- Z** All the resettable totals and their respective counters will be read and reset in this position.
- SET** In this position, the register will allow programming operations.

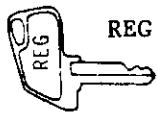

REG Key: The REG Key is used by the cashier who operates the register. This key can access the positions of LOCK and REG.

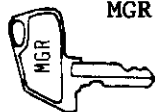

MGR Key: The MGR key is used by the store manager or a person authorized by the manager. This key can access the positions of LOCK, REG, X, and MGR.

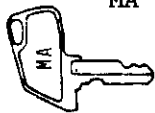

MA Key: The MA Key is used by the store manager who will daily supervise the collection of money and the printout of transactions recorded by the register. This key can access the positions of LOCK, REG, X, MGR, ☐, and Z.

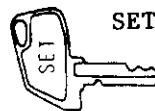

SET Key: The SET Key is used by the programmer. This key can access the positions of LOCK and SET.

CLERK LOCKS

These locks are used to identify which clerk is operating the register.-

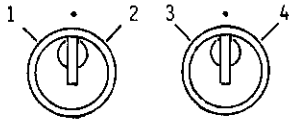

Clerk Keys (CL1, CL2, CL3, CL4)

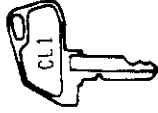

Each clerk should keep his/her clerk key. The register will not operate in the REG, MGR, or mode unless one of these keys is inserted and set to the corresponding position on the Clerk Locks. Each of the keys may be inserted and pulled out in the neutral position marked with "." (point).

GT LOCK

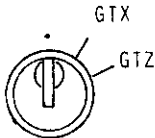

This lock is provided to read or reset the accumulated sales totals not on the daily but on weekly or monthly basis.

GTX Position:

This position allows to read the accumulated totals.

The GTX Key and GTZ Key can access this position.

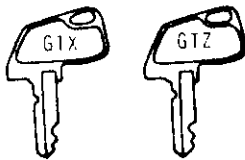

GTZ Position:

This position allows to read and reset the accumulated totals.

The GTZ Key only can access this position.

NOTE: When the GT Lock is turned to either the GTX or GTZ position, the Mode Lock and Clerk Lock positions will be disregarded wherever they may be.

DISPLAY

The front display is located at the top of the register just above the keyboard.

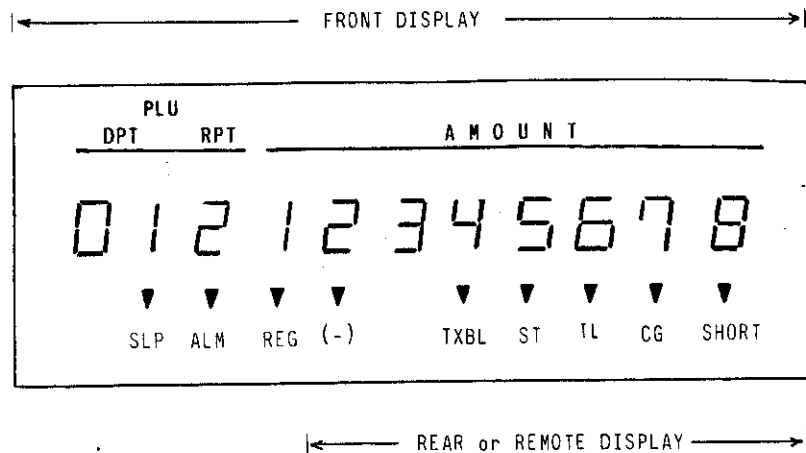

Numeric Display

- AMOUNT (8 digits): Displays the numeric data, such as amount, quantity, etc.
- DPT (2 digits): Displays the code which represents each Department Key. It stays lit when repeating the same department entry.
- RPT (1 digit) Displays the repeat count.
- PLU (2 digits; commonly used with the DPT and RPT digits):
Displays the PLU code when any PLU is entered. It stays lit when repeating the same PLU entry.

Message Descriptors (Tri-mark Lamps)

- ▼
SLP: Lights up when a slip has been properly inserted to allow validation. It flashes to require a slip insertion when validation compulsion is programmed on the transaction key just operated.
- ▼
ALM: Lights up with the alarm buzzer to indicate that the last operation or numeric entry has resulted in an error. To clear the error condition, depress the **C** key.
- ▼
REG: Lights up when sale items have been entered into a department.
- ▼
(-): Lights up when the **RTN MDSE**, **DOLL DISC**, **%-**, or **ITEM CORR** key has been operated.

It also lights up when the **ST**, **TXBL TL**, or one of the total keys has been depressed and the displayed amount is negative. It lights up also when an amount is entered in the "[-]" mode.

- ▼
TXBL: Lights up when a taxable department or PLU is entered. It also lights up with the 'ST' Lamp when the **TXBL TL** key is depressed.
- ▼
ST: Lights up when the sub-total amount is displayed after the **ST** key has been depressed.
- ▼
TL: Lights up on a finalizing operation with the total amount displayed when finalized without any amount tendered.
- ▼
CG: When an amount tendering operation has been performed, this lamp lights up with the change due displayed.
- ▼
SHORT: Lights up when the amount tendered is less than the sale total with the shortage amount displayed.

KEYBOARD LAYOUT

The following is a typical keyboard layout for the MA-1050-100 series. Since this series is designed to be capable of programming most of the keys in the most desired location on the keyboard, this is merely an example. Please contact your TEC representative if any other alternative or additional keys must be installed, referring to the description of the "FUNCTION OF EACH KEY" and "OTHER OPTIONAL KEYS" in this manual.

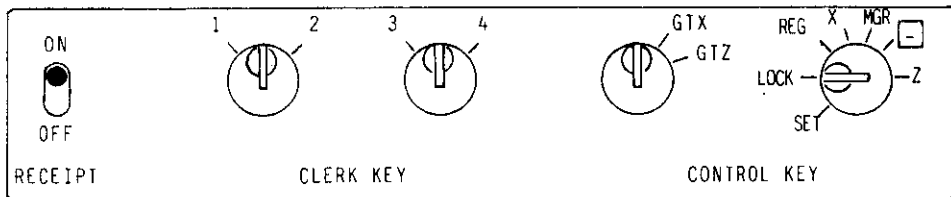

NS	VALI DATE	RF	JF	PR OPEN	LC OPEN	#	R/A	PO
RTN MDSE	C		TX/M	%-	%+		ST	DOLL DISC
X	7	8	9	1	5		TXBL TL	Chg
PLU	4	5	6	2	6			
	1	2	3	3	7		AT/TL	CHK TND
ITEM CORR	0	00	.	4	8			

MA-1050-108-US (Standard Keyboard)

FUNCTION OF EACH KEY



Receipt ON/OFF Switch

This switch has two positions available, 'OFF' and 'ON' position. When in the 'OFF', no receipt is issued from the register and sales are printed on the audit roll only. When the switch is pressed to the 'ON' position, sales are printed on both receipt roll and audit roll, then a receipt is issued which is automatically cut off and then given to the customer.

Alternating the switch position during a registration will not result in an error. In this case, the position when the registration starts will rule whether a receipt is issued or not. When a reset (Z) report is taken, however, the data will be printed also on the receipt roll regardless of the switch position.

NS No-sale Key

This key is used, when the Mode Lock is in the REG position, to open the cash drawer while the machine is outside a sale. To operate, depress the **NS** key once.

Usually, a non-add number may be entered prior to a no-sale operation. However, it can be programmed to prohibit a non-add number entry when a no-sale is operated.

RTN MDSE Returned Merchandise Key

This key is used for refunding money to a customer who has returned goods to the store.

To operate, depress the **RTN MDSE** key either before or after ringing up the amount to be refunded, and then depress the appropriate department key (the department key may be replaced by a PLU code and the **PLU** key combination). The amount is automatically printed and deducted from the bill.

The **RTN MDSE** key may be programmed to require a Manager Intervention.

X Quantity Extension (Multiplication) Key

This key is used to multiply a department or PLU item entry by a quantity.

The basic order of multiplication is:

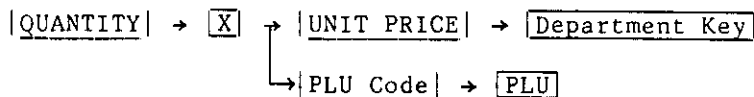

As for details of multiplication for various cases, refer to the "REGISTERING PROCEDURE FOR SALES" in this manual.

The QUANTITY can be a maximum of 3 integral digits and 3 decimal digits, and the price may be a maximum of 6 digits. The product must not exceed 7 digits. When a decimal portion is required for the quantity, use the key.

Usually, the fraction below the least significant digit will be rounded off. However, it may be programmed to be discarded or rounded up by the system option.

PLU (Price-Look-Up) Key

This key is used to enter a PLU that is linked to a department.

To enter the price through a PLU:

| PLU Code | →
 (1 ~ 50)

The preset price will automatically be read and entered.

To repeat the same PLU, depress the key again, after the above operation.

As for quantity extension involving PLUs, refer to the "REGISTERING PROCEDURE FOR SALES".

Each PLU is programmed with a 2-digit PLU code (1~50), a 2-digit linked department code, and a maximum of 6-digit preset price. Each PLU tax status is ruled by the linked department status.

ITEM CORR

Item Correct Key

This key is used to delete the last item within a transaction.

Depressing this key once will remove the last line item from the bill, printing a line through that item on the receipt and journal.

The item correct function is effective even when a numeric entry and a key depression are done between the department entry to be corrected and the key depression. However, if any other key-in operation including an error comes in between, the item correct will not function.

The may function to correct any last item entered through a department, PLU, , , DOLL DISC, TAX (Manual Tax Key), R/A, or PO key. But a department or PLU item entered with the RTN MDSE key cannot be item-corrected. Neither can a negative department item be item-corrected.

VALI
DATE

Validation Key

This key is used to print a validation slip.

To operate, after registering the required item, insert a slip into the validation slot and depress the **VALIDATE** key. The item and the amount will be printed on the slip.

The system option provides program selections as to single- or multi-validation, validation compulsion on certain transaction keys, print/non-print of date and/or consecutive No., etc.

If validation is performed after a single-item department entry, the sale amount with tax is printed on the validation slip. However, if validation is performed after a single-item department entry with a validation compulsory status (e.g., the **RTN** key with validation compulsory status set has been depressed prior to the single-item entry), the total without tax is printed on the validation slip.

RF Receipt Feed Key

This key is used to advance the receipt roll. It is operated by depressing the key and holding it in that position until the paper has advanced to the required position.

The receipt roll can be advanced even when the **RECEIPT ON/OFF** switch is in the OFF position. Receipt feeding during a sale is usually allowed, but it can be programmed to be prohibited.

JF Journal Feed Key

This key is used to advance the audit roll in the same fashion as the RF key. This key is useful if the cashier, due perhaps to an interruption whilst ringing up a sale, is unsure which items have already been entered. By using this key, the cashier can see which figures have actually been printed.

The RF and JF keys can not be operated simultaneously.

C Clear Key

This key is used to correct a numeric entry error if prior to depressing any other key, or to correct any error condition and cancel the alarm buzzer.

If the **C** key is depressed after a sub-total is obtained, the sub-total is then displayed. If depressed after a taxable total is obtained, the taxable total is then displayed.

The **C** key is also effective to clear the tax-modified status on a preset department entry being repeated. For example, to enter two items of the same department with taxable/non-taxable status modified from the original status, and then one item with the original status, Operate: **TX/M** → **DEPT** → **DEPT** → **C** → **DEPT** .

TX/M (or **TX1/M** and **TX2/M**) Tax Modifier Key(s)

These keys are used to reverse the taxable/non-taxable status on departments, PLUs, **DOLL DISC**, **%+**, or **%-** key for one entry only. However, in a repeat entry by depressing the **PLU** or the same department key again, the tax-modified condition will be held for those repeated items.

For dual-tax areas, two keys should be provided — **TX1/M** and **TX2/M** — in place of the **TX/M** key. The two tax modifier keys will function independently each with its own tax table preprogrammed for taxable items.

To operate, depress the **TX/M** key prior to depressing any of the above mentioned keys (i.e., before or after the amount entry).

0 ~ 9, **00** Numeric Keys

These are used to enter numeric values such as amount, quantity, or code number.

Depressing the **00** key once is the same as depressing the **0** key twice consecutively.

The maximum listing capacity is 8 digits for inputting a numeric value only, and 7 digits for registration except that a non-add # may be entered in maximum 8 digits.

. Decimal Point Key

This key is used, as part of the numeric keys, to designate the position of the decimal point when entering a percent rate or a quantity with a decimal portion. For example, to enter 0.5%, index 0→**.**→5, or **.**→5.

When entering a price or amount such as \$0.25, just index 2→5. In this case, depression of the **.** key is not necessary and will cause an error.

PR OPEN Preset Open Key

This key is used to modify the status of preset department keys. When the **PR OPEN** key is depressed prior to depressing a preset department key (either before or after the numeric entry), the preset department key is reversed to non-preset and allows amount entry through the numeric keyboard.

If a preset department is entered with a price through the numeric keyboard using the the **PR OPEN** key in the above mentioned manner, no repeat operation for the same price entry is then possible for that department key.

The **PR OPEN** key can not be used with the **PLU** key.

**LC
OPEN**

Listing Capacity Open Key

This key is used to release the listing capacity on each Department. To operate, depress the **LC OPEN** key before depressing the department key (either before or after the numeric entry).

By depressing the **LC OPEN** key, the HALC (High Amount Listing Capacity) will be released to allow a numeric entry with two further digits.

In order to allow a numeric entry exceeding the values defined above, the Mode Lock must be turned to the 'MGR' position by the store manager.

Repeat operation will be possible on any department key even when the **LC OPEN** key is depressed before the department entry.

#

Non-add Number Key

When the Mode Lock is in the REG or **-** position, this key is used to print a non-adding number (such as Customer No., Check No., Credit Card No., etc.) on the receipt and journal for future reference.

To operate, enter a maximum of 8-digit number and then depress this key. The number is then printed. This operation may be performed any time between items, before or after all the sale items.

Ususally, non-add numbers may be entered as many times as required within a sale. However, it is programmable to prohibit more than one non-add number entry within a sale.

When the Mode Lock is in the X position, this key is used to read the Cash-in-drawer total.

R/A

Received on Account Key

A received-on-account transaction is used to identify money which is in the drawer but not business. The amount entered is thus included in the "Cash-in-drawer" total but not in the sales totals.

To operate, enter an amount of payment and then depress the **R/A** key. Repeat this operation if multiple payments are entered at a time. The payments thus entered may be finalized by the **AT/TL** (for cash payments). The **CHK TND** and/or **Chg** key may also function to finalize payments received on account if not prohibited in the system option. The above operation can only be done when the register is outside a sale.

The **ITEM CORR** key is effective to delete a payment just recorded with a depression of the **R/A** key, if before finalized by a media key.

This key will not function when the Mode Lock is in the **-** position.

PO Paid Out Key

A paid out transaction is used when an amount of money is removed from the cash drawer without relating to a sale. When the **PO** key is used, the amount entered is subtracted from the "Cash-in-drawer" total but does not affect the sale totals.

To operate, enter an amount taken from the cash drawer and depress the **PO** key while the register is in an out-of-sale condition. This operation may be carried out as many times as required if multiple paid out items are registered at a time. The paid out amounts recorded are finalized by the **AT/TL** key only.

The **ITEM CORR** key is effective to delete a payment just recorded with a depression of the **PO** key, if before finalized by the **AT/TL** key.

This key will not function when the Mode Lock is in the **-** position.

%+ Percent Charge Key

This key is used to add a percentage rate to a sale. If the preset percentage rate is to be added, depress the **%+** key without a prior numeric entry. If a rate different from the preset one is required, enter the desired rate on the numeric keyboard and then depress the **%+** key. The manual rate will take priority.

To operate, depress the **%+** key either immediately after a department entry if only that item requires the percent addition, or after the **ST** key has been depressed if required on the total bill. The percentage rate and the amount are printed and added to the sales total.

The percentage rate may be within the range from 0.001 to 99.999%. The fraction resulted from the percentage calculation is usually programmed to be rounded off. However, it can be programmed to be rounded up or discarded.

If the **%+** key is depressed after a second **ST** key depression within a sale, it usually adds the rate to the sale total of the items entered between the first and the second **ST** key depressions. However, it can be programmed to add the rate to the entire sale by the system option.

%- Percent Discount Key

This key operates in the same fashion as the **%+** key except that operation will subtract from instead of adding to a sale.

1

~

8

Department Keys

These are department keys through which sales items are registered. These keys may be programmed as either 'OPEN' keys or 'PRESET' keys.

OPEN DEPARTMENT KEY

A department key which has no preset price programmed is an 'OPEN' key and must have a price entered into it manually each time. The price is rung up on the numeric keyboard and the appropriate department key is depressed. The price is then displayed and printed on the receipt and audit rolls.

When the same department key is depressed more than once after a price entry, the price entry is repeated as many times as the department key is depressed.

To enter a price extended by multiplication, enter the quantity first, depress the **X** key, enter the price, and then depress the appropriate department key. A multiplication entry will not be repeated by depressing the department key again.

PRESET DEPARTMENT KEY

A preset key is a key which has already a price programmed in it. It is therefore unnecessary to enter the price of an item; simply depress the key to register the sale of one item.

To repeat the same preset item, depress the department key as many times as desired.

To multiply a preset department price by a quantity, enter the quantity first, depress the **X** key, and then depress the preset department key.

If a non-preset price must be entered on the keyboard into a preset department, depress the **PR OPEN** key either before or after the price entry, prior to the department key depression.

Each department key can be programmed with a unit price, positive or negative use, a HALC (High Amount Listing Capacity), tax status, and a descriptor (the name of the department or its merchandise) in a maximum of 6 alpha/numeric characters.

When a department is programmed as a negative department, a price entry can not be repeated by depressing the department key again. Neither can a price entry be repeated when the **RTN MDSE** or **PR OPEN** key has been depressed prior to any department key depression.

The department keys may be programmed to be used as single-item entry keys. See the description of "Single-item Department Keys" in the OTHER OPTIONAL KEYS page.

ST Sub-total Key

This key is used to obtain the sub-total amount without tax during a sale. When this key is depressed after all the items have been rung up, the sub-total of the sale is printed and displayed.

If the **ST** key is depressed more than once consecutively, the first depression only will print and display the sub-total; further depressions will only display but not print the sub-total amount.

The system option provides the selection not to print but only display the sub-total even on the first depression of the **ST** key.

**DOLL
DISC**

Dollar Discount Key

This key is used to subtract an amount from the sale total such as a discount during a sale. This key cannot normally be used outside a sale. An amount exceeding the sale total cannot normally be entered. However, when the "Credit Balance" option has been selected, this key can be used inside or outside the sale and over-subtraction of the sale is allowed.

To operate, enter the discount amount on the numeric keyboard, and then depress the **DOLL DISC** key. The **TX/M** (**TX1/M** and/or **TX2/M**) key may be used prior to the **DOLL DISC** key depression if the taxable or non-taxable status of the discount amount is to be reversed.

**TXBL
TL**

Taxable Total Key

This key is used to obtain the contents of the main itemizer plus any taxes due. The amount will display only but not print.

In order to allow add-on operations to follow the use of this key, the taxes are not added into any totals until actual finalization is initiated.

Mandatory depression of this key prior to finalizing is a programmable option.

Chg Charge Total Key (Media 2 Key)

This key is usually programmed as "Charge Total" Key. However, it may be programmed to be key for other media such as payments in credit cards. This key is used as an alternative method of payment for media other than cash and check. To operate, depress the **Chg** key, instead of **AT/TL**, to obtain the total and finalize the sale.

This key has exactly the same function and programmability as the **CHK TND** key except that the **Chg** key is usually programmed as a "Total" key but not as a "Tender" key.

This key may finalize received-on-account payments if not prohibited in the system option.

AT/TL Amount Tendered / Cash Total Key

This key is used to record all cash paid on transactions, and will be able to finalize a sale operation. Usually the key is programmed to function as both amount tendered and cash total key. However, the key may be programmed to operate with enforced tendering only or as a cash total key only.

AMOUNT TENDERED FUNCTION

After the **TXBL TL** key has been depressed, enter the amount tendered by the customer in payment of the sale, and then depress the **AT/TL** key. The change is automatically computed, displayed and printed.

If the amount tendered is smaller than the sale total, it prints the amount tendered on the receipt with the balance still due displayed, but the drawer is not yet opened. In this case, ask the customer for additional payment in cash and repeat the same tendering operation, or use another media key (**CHK TEND** or **Chg**) if the balance due is processed as a sale in that media.

TOTAL KEY FUNCTION

To obtain the total and finalize a cash sale, depress the **AT/TL** key only. The sale is finalized with the total printed and displayed, and the drawer opens.

- NOTE: 1. If the **AT/TL** key has been programmed to function as "Tendered" key only and the sale total is "0" or negative, no amount tendered can be entered. In this case, the **AT/TL** key will function as the "Total" key, so just depress the **AT/TL** key to obtain the total and finalize the sale.
2. If the "**TXBL TL** Compulsory" option has been selected in the system option, the **TXBL TL** key depression for obtaining the sale total is required before finalizing any sale.

The **AT/TL** key is also used to finalize received-on-account payment entries or paid-out amounts.

The sale total will be printed on the receipt in double-sized characters if it is within a 4-digit value.

CHK TND Check Tendered Key (Media 1 Key)

This key is used to cash a check when the register is outside a sale, or to finalize the transaction as a check payment.

CHECK CASHING

When the register is outside a sale, enter the check amount and depress the **CHK TND** key. A receipt is issued and the drawer is opened to enable exchange. However, this cashing function may be prohibited if so programmed in the system option.

FINALIZING AS CHECK PAYMENT

On finalizing a sale, enter the amount of the check given by the customer and depress the **CHK TND** key. If the amount received is greater than the sale total, the receipt is issued with the change due printed and displayed. Then the change is given to the customer in cash. If the amount received is smaller than the sale total, the shortage is displayed, and the customer may pay the additional amount in cash to finalize the sale by depressing the **AT/TL** key.

The **CHK TND** key is also used to finalize received-on-account payment entries if paid by check. However, this function may be prohibited in the system option.

Over-tendering using the **CHK TND** key is usually allowed. However, it may be prohibited by the system option.

Cashing function may also be prohibited if so selected in the system option programming.

OTHER OPTIONAL KEYS

The following keys are not shown in the KEYBOARD LAYOUT on page 5. However, any of them may be installed if the customer requires. But please note that some of the present keys may have to be dispensed with to gain additional functions. Please contact your TEC representative if any of the following keys are necessary.

Additional Department Keys

A maximum of 16 department keys are available.

Single-item Department Keys

A Single-item Department key is used to quicken a single cash sale item entry process instead of depressing a department key and **AT/TL** keys. On depressing this key, the sale is finalized and a receipt is issued. But please note that the selection is either to install all Single-item Department keys or normal (itemized) department keys.

OPEN Listing Capacity / Preset Price Open Key

This is a dual-function key, i.e., both **LC OPEN** and **PR OPEN** functions can operate using this key.

#/NS Non-add Number Print / No-sale Key

This is a dual-function key, i.e., both **#** (or **#/CID**) and **NS** functions can operate using this key.

If this key is depressed with a prior numeric entry, it functions as the **#** key. If depressed without a numeric entry, it functions as the **NS** key.

RECEIPT ISSUE Receipt After-issue Key

This key is used to issue the receipt of a sale when the sale has already been finalized with the **RECEIPT ON/OFF** switch positioned to OFF.

To operate, depress the **RECEIPT ISSUE** key without a numeric entry. The receipt for the last sale is then issued, with the sale total printed. This key will not function if another sale has already been under way.

SET Set Key

This key is used to program some items in the 'MGR' instead of 'SET' position of the Mode Lock. The store manager may like to change the programmed data of these items by himself using the 'SET' key rather than asking a programmer.

PROGRAMMABLE ITEMS USING THE **SET** KEY:

- . Commercial Message Programming or Changing
- . Clerk Name Programming or Changing
- . Department Preset Price Programming or Changing
- . PLU Preset Price Programming or Changing
- . Time Setting

TAX Manual Tax Key

This key is used to enter an irregular tax amount that cannot be calculated on the basis of the programmed tax table, and to add it to the sale total.

To operate, enter the desired amount of tax, and then depress the **TAX** key. The tax amount entered is then printed. This tax amount is processed into the TAX 2 memory. Therefore, the tax amount automatically calculated and printed at finalizing the sale (i.e., TAX 1) does not include a manual-entered tax, while the entire sale total printed on the receipt last line does include the manual-entered tax also.

This key is also used, if depressed without an amount entry within a sale, to display the total of only non-taxable items so far entered. Usually, this non-taxable items total is only displayed; however, it may also be programmed to print.

REGISTERING PROCEDURE FOR SALES

The following are patterns for actual registering operations. In the following examples, " " indicates an input through the numeric keys, "" indicates a depression of the transaction key, and "---" indicates other registering and/or finalizing operations.

NO-SALE (Mode Lock: REG)

(or)

DEPARTMENT ENTRY (Mode Lock: REG; or MGR for negative departments if so programmed)

→ → ---

→ ---

→ → → ---

TAX MODIFICATION:

→ → → ---

 | → ---

 | → → ---

to reverse the tax status (single tax) of the department

Instead of above, use:

to reverse the tax 1 status (in a dual-tax area) of the department

to reverse the tax 2 status (in a dual-tax area) of the department

→ to reverse both the tax 1 and tax 2 status of the department

NOTE: To enter a price to override the listing capacity, the key (if installed on the keyboard) may be depressed either before or after the price entry but before the department key depression. In this case, a price two digit larger than the preset listing capacity may be entered for that entry only.

PLU ENTRY (Mode Lock: REG)

→ → ---
(1 ~ 50)

(or)

→ → → ---

→

REPEAT ENTRY (Mode Lock: REG)

|PRICE| → |OPEN DEPT| → |OPEN DEPT| → |OPEN DEPT| ... → ---

(Repeat depressing the same key as many times as the desired count.)

|PLU CODE| → |PLU| → |PLU| → |PLU| ... → ---

- NOTES: 1. Repeat entry is not possible when the **RTN MDSE** has been depressed prior to the **OPEN DEPT** or the **PLU** key.
2. The **LC OPEN** key may be used for the **DEPT** key to be repeated. The **TX/M** (or **TX1/M** and/or **TX2/M**) key will function to reverse the tax status of the department to be repeated.

QUANTITY EXTENSION (Mode Lock: REG)

|QUANTITY| → |X| → |PRESET DEPT| → ---

|PR OPEN| → |QUANTITY| → |X| → (|LC OPEN|) → |PRICE| → |PRESET DEPT| → ---

|QUANTITY| → |X| → (|LC OPEN|) → |PRICE| → |OPEN DEPT| → ---

|QUANTITY| → |X| → |PLU CODE| → |PLU| → ---

- NOTES: 1. The QUANTITY may be a maximum of 3 integral digits and 3 decimal digits. (Use the **.** key if the quantity contains a decimal portion.) The PRICE may be a maximum of 6 digits. The product must not exceed 7 digits.
2. The tax modifier keys will function to reverse the tax status if used anywhere before the **DEPT** or **PLU** key depression in the above operations.

SINGLE-ITEM DEPARTMENT ENTRY (Mode Lock: REG)

|PRICE| → |SINGLE-ITEM DEPT| ... The sale is finalized as a cash payment, the drawer opens, and a receipt is issued.

RETURNED MERCHANDISE (Mode Lock: REG; or MGR if so programmed)

|RTN MDSE| → |PRESET DEPT| → ---

|RTN MDSE| → |PRICE| → |OPEN DEPT| → ---

|RTN MDSE| → |PR OPEN| → |PRICE| → |PRESET DEPT| → ---

|RTN MDSE| → |PLU CODE| → |PLU| → ---

- NOTE: The **RTN MDSE** key may be depressed any where before the **DEPT** or **PLU** key depression, not necessarily at the starting.

DOLLAR DISCOUNT (Mode Lock: REG; or MGR if so programmed)

|DISCOUNT AMOUNT| → DOLL DISC → ---

- NOTES: 1. The tax modifier key(s) may be used either before or after the DISCOUNT AMOUNT entry if the tax status of the DOLL DISC key is reversed.
2. Unless the "Credit Balance" option has been selected, no discount amount exceeding the sale total will be allowed.
3. Unless the "Credit Balance" option has been selected, no amount discount operation outside a sale will be allowed.

PERCENT DISCOUNT (Mode Lock: REG; or MGR if so programmed)

(1) To discount from the sub-total:

--- → ST → %- → --- ... to discount by the preset %- rate

--- → ST → RATE → %- → --- ... to discount by a manual rate

(2) To discount from an individual department item:

(|PRICE|) → DEPT → %- → --- ... to discount by the preset %- rate

(|PRICE|) → DEPT → RATE → %- → --- ... to discount by a manual rate

- NOTES: 1. The rate may be entered within the range from 0.001 to 99.999%. If the rate contains the decimal point, use the . key.
2. The above DEPT keys may be replaced by a PLU entry.
3. The tax modifier key(s) may be operated prior to depressing the %- key if tax status modification on the %- key is necessary.

PERCENT CHARGE (Mode Lock: REG)

This operates the same as in the PERCENT DISCOUNT operations above, except that the %+ key is used instead of the %- key.

ITEM CORRECT (Mode Lock: REG)

--- → (|PRICE|) → DEPT → ITEM CORR → ---

--- → |PLU CODE| → PLU → ITEM CORR → ---

- NOTES: 1. The ITEM CORR key depression will delete the last line item already printed within a sale.
2. The ITEM CORR key functions to delete the last line item, even if the DEPT keys in the above example are replaced by the %+, %-, R/A, PO, DOLL DISC, or TAX (Manual Tax Key).

NON-ADD NUMBER PRINT (Mode Lock: REG)

|NUMBER, 8 digits maximum| → # (or #/CID or #/NS) → ---

(Check No., Customer No., Credit Card No., etc.)

- NOTES:**
1. If the "Non-add Number Print Allowed Only Once in a Sale" has been selected in the system option, a second non-add number entry will result in an error.
 2. The . key cannot be used to enter a non-add number.

SUB-TOTAL (Mode Lock: REG)

--- → ST → --- ... The sale total (without tax) so far is displayed and printed, but the sale is not finalized.

- NOTES:**
1. If the C key is depressed to clear an error or a numeric entry after once obtaining a sub-total, the sub-total amount will again be displayed.
 2. If the ST key is depressed more than once consecutively, the first depression only will print and display the sub-total; the further depressions will only display but not print the sub-total.

READING THE SALE TOTAL WITH TAX DUE (Mode Lock: REG)

--- → TXBL TL → --- ... The amount of sale total with taxes due so far is displayed only.

NOTE: If the C key is depressed after the TXBL TL has once been depressed, the sale total with taxes is then displayed.

MANUAL TAX (Mode Lock: REG) ... for CANADA versions

--- → |TAX AMOUNT TO BE ADDED| → TAX → ---

READING NON-TAXABLE ITEMS TOTAL (Mode Lock: REG) ... for CANADA versions

--- → TAX → --- ... The non-taxable items total of the entire sale is displayed.

CHECK CASHING (Mode Lock: REG) (Allowed only outside a sale)

|AMOUNT OF CHECK TO BE CASHED| → CHK TND

... The drawer opens and a receipt is issued. Receive the check and pay the amount in cash to the customer.

- NOTES:**
1. Check cashing may be programmed to be prohibited in the system option.
 2. The Chg key may also be operated for cashing if so programmed in the system option.

REGISTERING RECEIPT SAMPLES

**NON-ADD NUMBER,
NO-SALE**

```

    [ ] [ ]
    [ ] [ ]

    THANK YOU

    05-17-83 #123456

    #15
    **NOSALE**

    JONES 0035 14:54
    
```

Store Name/Message Stamp is printed here.

Three-line Commercial Message is programmable.

Date

Register No.

Non-add No.

No-sale Symbol

Current Time

Receipt Consecutive No.

Clerk's Name (If no name is programmed, the Clerk ID No. such as "1CL" is printed.)

CHECK CASHING

```

    [ ] [ ]
    [ ] [ ]

    THANK YOU

    05-17-83 #123456

    CHECK 10.00

    JONES 0041 14:55
    
```

Check Amount Cashed

**DEPARTMENT ENTRIES,
CASH SALES**

```

    [ ] [ ]
    [ ] [ ]

    THANK YOU

    05-17-83 #123456

    DP01 1.20 T
    DP02 3.00 T
    DP06 8.00
    DP05 6.00
    DP07 2.50
    DP08 1.00-
    TAX 0.42
    CASH 20.12

    ITEM 5
    3CL 0075 16:10
    
```

Taxable Item Symbol

Dept.No.1 \$1.20

Negative Dept.

Tax due

Total paid in cash

Item Count purchased

RETURNED MERCHANDISE

```

    [ ] [ ]
    [ ] [ ]

    THANK YOU

    05-17-83 #123456

    RTN
    DP01 1.20-T
    TAX 0.12-
    CASH 1.32-

    ITEM -1
    JONES 0092 16:14
    
```

Return Symbol

Attached tax due to be returned

Total is negative; the amount is to be returned to the customer in cash.

%+ on DP IIEM

ITEM CORRECT, QUANTITY EXTENSION, DOLLAR DISCOUNT,
CASH TENDERING

```

  [ ] [ ]
  [ ] [ ]

  THANK YOU

  05-17-83 #123456

  DP01      1.00 T
  %+        10%
           0.10
  DP01      1.00 T
  %+        10%
           0.10 T
  TAX       0.21
  CASH      2.41

  ITEM      2
  JONES 0064 16:00

```

←10% is added to the above Dept.1 item

←10% is added to the above Dept.1 item

```

  [ ] [ ]
  [ ] [ ]

  THANK YOU

  05-17-83 #123456

  DP01      1.23 T
  DP01-----1.23-T ←Dept.1 $1.23, Item Corrected
  RTN
  DP01      1.23-T
           15X  1.00@
  DP04      15.00 T
  BISE-----1.00-- ←Dollar Disc of $1.00,
                               Item Corrected
  TAX       1.50
  TOTAL     16.50 ←Sale Total
  CATEND    20.00 ←Cash Tendered
  CHANGE    3.50 ←Change Due

  ITEM      15
  JONES 0042 14:54

```

%+ on GROUP SUBTOTAL

PLU ENTRIES

```

  [ ] [ ]
  [ ] [ ]

  THANK YOU

  05-17-83 #123456

  DP03      2.00 T
  DP02      4.00 T
  SUBTL     6.00 ←Subtotal of the sale
  GRP.ST    6.00 ←Group Subtotal (DP3+DP2)
  %+        10% ←%+ on the above Grp.Subtotal
           0.60
  DP06      1.50
  SUBTL     8.10 ←Subtotal of the sale
  GRP.ST    1.50 ←Group Subtotal (DP6)
  %+        10% ←%+ on the above Grp.Subtotal
           0.15
  TAX       0.60
  CASH      8.85

  ITEM      3
  JONES 0054 15:54

```

←Subtotal of the sale

←Group Subtotal (DP3+DP2)

←%+ on the above Grp.Subtotal

Subtotal of the sale

Group Subtotal (DP6)

←%+ on the above Grp.Subtotal

```

  [ ] [ ]
  [ ] [ ]

  THANK YOU

  05-17-83 #123456

  DP01      1.50
  PLU05-----1.00-T ←PLU No.5 $1.00, Item Corrected
           12.5X  2.00@ ←Qty 12.5 x Price $2.00
                               = $25.00 into PLU No.20
  PLU20     25.00 T ←PLU Name "SUGAR" $0.50
  RTN
  SUGAR      0.50-T ←Returned
  SUBTL     26.00
  GRP.ST    26.00
  %+        15.4%
           4.00
  TAX       2.45
  CASH     32.45

  ITEM     12.5
  JONES 0055 15:54

```

←PLU No.5 \$1.00, Item Corrected

←Qty 12.5 x Price \$2.00 = \$25.00 into PLU No.20

←PLU Name "SUGAR" \$0.50 Returned

RECEIVED ON ACCOUNT

```

    [ ] [ ]
    [ ] [ ]

    THANK YOU

    05-17-83 #123456

    R/A      2.00
    R/A      5.00
    TOTAL    7.00
    CHECK    4.00
    CASH     3.00

    JONES 0038 14:54
    
```

← R/A Item of \$2.00
 ← R/A Item of \$5.00
 ← R/A Total Received
 ← Check Paid Portion
 ← Cash Paid Portion

PAID OUT

```

    [ ] [ ]
    [ ] [ ]

    THANK YOU

    05-17-83 #123456

    PO      5.00
    PO      6.00
    TOTAL   11.00

    JONES 0040 14:54
    
```

← Paid Out Item of \$5.00
 ← Paid Out Item of \$6.00
 ← Paid Out Total

ENTRIES IN THE "☐" MODE

```

    [ ] [ ]
    [ ] [ ]

    THANK YOU

    05-17-83 #123456

    DP03     2.00 T
    DP04     4.00 T
    SUE TL   6.00
    GRP.ST   6.00
    %+       10%
             0.60
    DP03     1.50 T
    SUE TL   8.10
    GRP.ST   1.50
    %+       10%
             0.15
    TAX      0.75
    CASH     9.00

    ITEM     3
    JONES 0068 16:04
    
```

ex.) A customer who once purchased items listed in the left receipt comes up to return all the items he purchased. The clerk asks the store manager to turn the Mode Lock to the "☐" position, and registers all the items, one by one, following the customer's receipt. The contents of the two receipts are the same except that the Negative Mode Symbol "***REG- **" is printed on the right one, and the total amount must be returned to the customer.

← Total Paid in Cash

```

    [ ] [ ]
    [ ] [ ]

    THANK YOU

    05-17-83 #123456

    **REG-   **
    DP03     2.00 T
    DP04     4.00 T
    SUE TL   6.00
    GRP.ST   6.00
    %+       10%
             0.60
    DP03     1.50 T
    SUE TL   8.10
    GRP.ST   1.50
    %+       10%
             0.15
    TAX      0.75
    CASH     9.00

    ITEM     3
    JONES 0069 16:09
    
```

← Negative Mode Symbol

← Total to be returned to the customer

VALIDATION PRINT SAMPLES

PAID OUT TOTAL

┌ ┐
└ ┘

05-20-83 #123456

PO 20.00
~~PO~~ ~~10.00~~
TOTAL 20.00

1CL 0067 10:48

05-20-83 1CL0067 PO TOTAL 20.00

RECEIVED ON ACCOUNT TOTAL

┌ ┐
└ ┘

05-20-83 #123456

R/A 20.00
R/A 12.00
CASH 32.00

JONES 0036 11:44

05-20-83 1CL0036 R/A CASH 32.00

NON-ADD #, NO-SALE

┌ ┐
└ ┘

05-20-83 #123456

#10
NOSALE

1CL 0064 10:48

05-20-83 1CL0064 #10

05-20-83 1CL0064 **NOSALE**

READ(X) AND RESET(Z) REPORTS

The following table shows the key operation to take each report. The "X" and "Z" reports have exactly the same content print if both are available, except that:

1. The "X" reports allow to read the totals but not clear memories, while the "Z" reports allow to read the totals and at the same time all the resettable memories will be cleared when the reports have been issued.
2. The symbol "X" is printed on the top line of a "X" report, while "Z" is printed on a "Z" report, to indicate the type of report.
3. A reset count is printed on the bottom of a "Z" report only.

TABLE OF OPERATIONS FOR X AND Z REPORTS

REPORT NAME	KEY OPERATION
AUTO READ REPORT *	Mode Lock: X <input type="checkbox"/> <input type="text" value="AT/TL"/>
AUTO RESET REPORT *	Mode Lock: Z <input type="checkbox"/>
PLU READ REPORT	Mode Lock: X <input type="checkbox"/> <input type="text" value="PLU"/>
PLU RESET REPORT	Mode Lock: Z <input type="checkbox"/>
HOURLY READ REPORT	Mode Lock: X <input type="checkbox"/> 10 → <input type="text" value="AT/TL"/>
HOURLY RESET REPORT	Mode Lock: Z <input type="checkbox"/>
IN-DRAWER READ REPORT	Mode Lock: X <input type="checkbox"/> # or #/CID or #/NS
GT READ REPORT *	Mode Lock: any position
GT RESET REPORT *	GT Lock: GTX <input type="checkbox"/> <input type="text" value="AT/TL"/> GT Lock: GTZ <input type="checkbox"/>
PRESET DATA VERIFICATION	Mode Lock: X
. Department Preset Prices	1 → <input type="text" value="ST"/>
. Department Listing Capacities, Tax Status, Positive/Negative	2 → <input type="text" value="ST"/>
. PLU Codes, Preset Prices, Linked Departments	3 → <input type="text" value="ST"/>
. %+, %- Preset Rates, All Depart- ments' Common Listing Capacity	4 → <input type="text" value="ST"/>
. Customer System Option Selection	5 → <input type="text" value="ST"/>

- NOTES: 1) Usually, the cash drawer will open on the depression of the for the reports marked with "*". However, it will not open if so programmed in the system option.
- 2) No Clerk Key is necessary to inssue any of the reports.
- 3) Refer to the report samples on the following pages. As for the PRESET DATA VERIFICATION print samples, see the "VERIFICATION OF PROGRAMMED DATA" near the end of this manual.

AUTO READ OR RESET REPORT

(Mode Lock: X or Z, depress AT/TL)

AUTO READ

AUTO RESET

┌	┐	
└	┘	
05-17-83	#123456	
GT	X	
	282.29	
GS	134.5	
	282.29	
DP01	11	
BCU	15.62	
DP02	16.5	
3CU	35.46	
DP03	8	
BCU	52.96	
DP04	64	
7CU	64.50	
DP05	0	
OCU	0.00	
DP06	4	
3CU	5.00	
DP07	23	
4CU	57.50	
DP08	0	
OCU	0.00	
%+	14	
	7.67	
TAX1		
	15.48	
NS	126.5	
	254.19	
%-	6	
	12.24	
DISC	0	
	0.00	
TOTAL	22CU	
	254.19	
CASH	22CU	
	254.19	
CHECK	0CU	
	0.00	
Chg	0CU	
	0.00	

A three-line commercial message is printed, if programmed.

—Date, Register No.

—Read Symbol ← → Reset Symbol — Z

—Grand Total (non-resettable)

—Gross Total Item Count

—Gross Total Amount

—Dept.1 Sales Item Count

Customer Count, Sales Total

—Dept.2 Sales Item Count

Customer Count, Sales Total

—Dept.3 Sales Item Count

Customer Count, Sales Total

—Dept.4 (programmed as "COFFEE") Sales Item Count, Sales Total

Customer Count, Sales Total

—Dept.5 Sales Item Count

Customer Count, Sales Total

—Dept.6 Sales Item Count

Customer Count, Sales Total

—Dept.7 Sales Item Count

Customer Count, Sales Total

—Dept.8 Sales Item Count

Customer Count, Sales Total

—% Charge Transaction Count

Total Amount (NS without Tax, optional for CA version)

—Tax 1

Total (Tax 2 Total, if dual-tax)

—Net Sales (with Tax) Item Count

Net Sales Total

—% Discount Transaction Count (on Subtotal)

Total Amount (on Subtotal)

—Dollar Discount Transaction Count

Total Amount

—Media Total (All medias except cash) Customer Count

Total Amount

—Cash Total Customer Count

Total Amount

—Check Total Customer Count

Total Amount

—Charge Total Customer Count

Total Amount

-- To be continued --

AUTO READ OR RESET REPORT

AUTO READ

AUTO RESET

-- Continued --

R/A	6	—	Received on Account Transaction Count
	45.00		Total Amount
PO	2	—	Paid Out Transaction Count (Standard "PO" print in regular-sized characters)
	11.00		Total Amount
CAID	261.19	—	Cash-in-drawer Total
CKID	4	—	Check-in-drawer Count
	27.00		Total Amount (Charge-in-drawer print, optional)
CORR	5	←	Item Correct (on positive Department items) Count
	2.83		Total Amount
MS VD	2	—	Item Correct (on other items) Count
	6.00		Total Amount
%-	0	—	% Discount Transaction Count (on individual line items)
	0.00		Total Amount (Negative Dept. Total print, optional)
RTN	3	←	Returned Merchandise Count
	4.03		Total Amount
-TAX	0.00	—	Negative Tax Total
REG-	1	—	Negative Mode (<input type="checkbox"/> Position of Mode Lock) Count
	9.00		Total Amount
TXBL1	154.82	←	Taxable Total 1
	3		Total Amount (Taxable Total 2 print if dual-tax)
NOSALE	3	←	No-sale Count
VALCTR	0	—	Validation Count
			INDIVIDUAL CLERK'S DATA:
JONES			— Clerk Name (or ID)
GS	134.5		— Gross Sales Item Count
	282.29		Total Amount
NS	126.5		— Net Sales Item Count
	254.19		Total Amount (Standard with Tax, optional without Tax for CA version)
TOTAL	22CU		— Media Total (All medias except cash) Cus. Count
	254.19		Total Amount
CAID	261.19		— Cash-in-drawer Total
CKID	27.00		— Check-in-drawer Total (Charge-in-drawer print, optional)
NEG1	28.10		— Negative 1 Total = (NEG SALE)+(CORR)+(RTN)+(REG-)+(%- on Item)+(-TAX)
NEG2	6.00		— Negative 2 Total = (%- on Subtotal)+(DOLL DISC)+(MS VD)
PO	11.00		— Paid Out Total (Standard "PO" print in regular-sized characters)

JONES 0073 14:54

(More individual clerks' data will be printed if other clerks have been involved as cashiers.)

Reset Count ---

0001Z

Report-issued Time

Receipt Consecutive No.

Clerk's name if that clerk's key has been set to ON in the Clerk Lock; if no clerk key has been set in issuing the report (which is possible), nothing will be printed here.)

PLU READ OR RESET REPORT

(Mode Lock: X or Z, depress PLU)

READ

```
┌      ┐
└      ┘
05-20-83 #123456
      X
PLU20   12.5
PLU20   25.00
PLU25    -1
PLU25   -1.50
SMITH 0028 11:44
```

—Date, Register No.

—Read Symbol

—PLU No. (or PLU Name if programmed), Item Count
Sale Total

RESET

```
┌      ┐
└      ┘
05-20-83 #123456
      Z
PLU20   12.5
PLU20   25.00
PLU25    -1
PLU25   -1.50
0001Z
SMITH 0029 11:44
```

—Reset Symbol

—Reset Count

HOURLY READ OR RESET REPORT

(Mode Lock: X or Z,
enter 10, depress [AT/TL])

READ

```

┌      ┐
└      ┘
05-20-83 #123456

      X
~08:00
~16:00   38.9
   6CU   364.70
~23:00

SMITH 0026 11:44

```

—Read Symbol
 —Up to 8:00, No sales
 —8:00-16:00, Item Count
 Cus.Count, Sales Total
 —16:00-23:00, No sales

IN-DRAWER READ REPORT

(Mode Lock: X, depress [#], [# /CID], or
[# /NS])

READ (No RESET report is provided)

```

┌      ┐
└      ┘
      THANK YOU
05-17-83 #123456

      X
CAID   261.19
CKID    4
      27.00

JONES 0070 14:54

```

—Read Symbol
 —Cash-in-drawer Total
 —Check-in-drawer Count
 Total
 ←(Charge-in-drawer Count
 and Total, optional print)

RESET

```

┌      ┐
└      ┘
05-20-83 #123456

      Z
~08:00
~16:00   38.9
   6CU   364.70
~23:00
0001Z

SMITH 0027 11:44

```

—Reset Symbol
 —Reset Count

GT READ OR RESET REPORT

(Mode Lock: any position, GT Lock: GTX or GTZ, depress AT/TL)

05-20-83 #123456

GTX

GT 383.36

GS 47.9

383.36

DP01 0

0.00

DP02 14.5

275.00

DP03 2

13.50

COFFEE 16

19.00

DP05 0

0.00

DP06 0

0.00

DP07 6.4

21.00

DP08 0

0.00

TAX1 29.40

NS 38.9

364.70

TOTAL 6CU

364.70

CASH 4CU

212.00

CHECK 1CU

142.50

Chg 1CU

10.20

R/A 3

22.50

PO 1

20.00

TXBL1

294.00

SMITH 0032 11:44

← GT Read Symbol ↔ GT Reset Symbol →

Grand Total (non-resettable)

Gross Total Item Count (Accumulation of Daily GS)

Total Amount

Dept.1 Item Count (Accumulation of the Daily Dept. Count and Total)

Sales Total

Dept.2

Dept.3

Dept.4 (programmed as "COFFEE")

Dept.5

Dept.6

Dept.7

Dept.8

--Every item is accumulation of daily data--

(Net Sales without Tax, optional print for CA version)

Tax 1

Total (Tax 2 Total if dual-tax)

Net Sales (with Tax: standard) Item Count

Total

Media Total (All medias except cash) Customer Count

Total

Cash Sales Customer Count

Total

Check Sales Customer Count

Total

Charge Sales Customer Count

Total

Received on Account Transaction Count

Total

Paid Out Transaction Count

Total

Taxable 1

Total (Taxable 2 Total if dual-tax)

Reset Count

GTZ

0001Z

PROGRAMMING OPERATIONS IN "SET" MODE

TABLE OF CONTENTS

(PROGRAM ITEM)	(CONDITION)¶	(PROG. NO.)	(PAGE)
SYSTEM OPTION PROGRAMMING	AZ, GTZ	11	35
COMMERCIAL MESSAGE PROGRAMMING	Anytime	1	46
CLERK NAME PROGRAMMING	Anytime	2	47
DEPARTMENT NAME AND STATUS PROGRAMMING	Anytime/AZ/AZ,GTZ,PLUZ	3	48
PLU TABLE PROGRAMMING OR CHANGING	PLUZ/Anytime	4	51
TIME SETTING	Anytime	5	53
DATE SETTING	Anytime	6	53
HOURLY RANGE SETTING	HZ	7	54
DEPARTMENT LISTING CAPACITY SETTING	AZ	8	55
FINANCIAL TOTAL NAME PROGRAMMING OR CHANGING ..	AZ, GTZ	9	56
PRINT LINE ITEM NAME PROGRAMMING OR CHANGING ..	Anytime	10	58
NON-TAXABLE AMOUNT LIMIT PROGRAMMING	AZ, GTZ	12	60
DEPARTMENT PRESET PRICE SETTING OR CHANGING ...	Anytime	61
PLU PRESET PRICE CHANGING	Anytime	62
%+ AND %- PRESET RATE SETTING	Anytime	63
STORE/REGISTER NO. SETTING	AZ, GTZ	63
TAX TABLE PROGRAMMING	AZ, GTZ	64

NOTE ¶: Anytime = Anytime outside a sale
 AZ = After Auto Reset, GTZ = After GT Reset
 PLUZ = After PLU Reset, HZ = After Hourly Reset

-- OTHER REFERENCES RELATED TO PROGRAMMING OPERATIONS --

CHARACTER CODE TABLE	72
PROGRAMMING OPERATIONS IN "MGR" MODE (MANAGER'S PROGRAMMING)	66
PROGRAMMING OPERATIONS THROUGH THE PROGRAMMING KEYBOARD (optional)	73
VERIFICATION OF PROGRAMMED DATA	76

ADDRESS NO.	CONTENTS
2	OPTIONAL FUNCTION 1

Standard Bit Set

BIT NO.	ITEM	SELECTIVE STATUS		STANDARD STATUS	REMARKS
1	<input checked="" type="checkbox"/> Fraction Rounding: ROUND UP	RESET	Follow Bit No.2 Status	*	—If both "RESET", it will be ROUND OFF. (If both "SET" it will be DISCARD.)
		SET	ROUND UP		
2	<input checked="" type="checkbox"/> Fraction Rounding: DISCARD	RESET	Follow Bit No.1 Status	*	
		SET	DISCARD		
3	--vacant--	RESET			
		SET			
4	--vacant--	RESET			
		SET			
5	--vacant--	RESET			
		SET			
6	--vacant--	RESET			
		SET			
7	--vacant--	RESET			
		SET			
8	--vacant--	RESET			
		SET			

NOTE: The selective status of the fraction rounding here applies to quantity extension and % calculations; but not to tax calculations. The fraction resulted from any tax % calculations will be rounded off (no alternative rounding method is provided for this).

ADDRESS NO.	CONTENTS
3	OPTIONAL FUNCTION II

Standard Bit Set

BIT NO.	ITEM	SELECTIVE STATUS		STANDARD STATUS	REMARKS
		RESET	PROHIBITED		
1	Credit Balance in "REG" mode	RESET	PROHIBITED	*	
		SET	ALLOWED		
2	Drawer Open on X, Z Reports and GTX, GIZ Reports	RESET	OPEN	*	
		SET	NOT OPEN		
3	Time Display when Mode Lock is in the "LOCK" mode	RESET	DISPLAYED	*	on the Front Display only
		SET	NOT DISPLAYED		"0" is displayed instead.
4	--vacant--	RESET			
		SET			
5	--vacant--	RESET			
		SET			
6	--vacant--	RESET			
		SET			
7	--vacant--	RESET			
		SET			
8	--vacant--	RESET			
		SET			

NOTE: ■ "Credit Balance" means that a sale total is negative through entering larger negative amounts (through DOLL DISC key) than positive amounts. If status "SET" is selected, a negative sale total may be finalized. The use of the DOLL DISC key outside a sale is also allowed in this case. The RTN MOSE key is not subject to this option selection. Any sale containing amounts entered through the RTN MOSE key may be finalized even if the sale total is negative.

ADDRESS NO.	CONTENTS
7	MGR REQUIREMENT II

Standard Bit Set
 | | | | | | | | | 0

BIT NO.	ITEM	SELECTIVE STATUS		STANDARD STATUS	REMARKS
		RESET	FREE		
1	DOLL DISC Key	RESET	FREE	*	
		SET	REQUIRED		
2	% Key	RESET	FREE	*	
		SET	REQUIRED		
3	Negative Departments & PLUs	RESET	FREE	*	
		SET	REQUIRED		
4	--vacant--	RESET			
		SET			
5	--vacant--	RESET			
		SET			
6	--vacant--	RESET			
		SET			
7	--vacant--	RESET			
		SET			
8	--vacant--	RESET			
		SET			

NOTE: See the "NOTE" on the previous page.

ADDRESS NO.	CONTENTS
8	TAX 1 STATUS

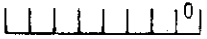
Standard Bit Set

BIT NO.	ITEM	SELECTIVE STATUS		STANDARD STATUS	REMARKS
		RESET	NON-TAXABLE		
1	[%+] Key	RESET	NON-TAXABLE	*	
		SET	TAXABLE		
2	[%-] Key	RESET	NON-TAXABLE	*	
		SET	TAXABLE		
3	DOLL DISC Key	RESET	NON-TAXABLE	*	
		SET	TAXABLE		
4	--vacant--	RESET			
		SET			
5	--vacant--	RESET			
		SET			
6	--vacant--	RESET			
		SET			
7	--vacant--	RESET			
		SET			
8	--vacant--	RESET			
		SET			

ADDRESS NO.	CONTENTS
9	TAX 2 STATUS

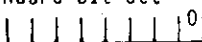
Standard Bit Set

BIT NO.	ITEM	SELECTIVE STATUS		STANDARD STATUS	REMARKS
		RESET	NON-TAXABLE		
1	<input type="checkbox"/> + Key	RESET	NON-TAXABLE	*	
		SET	TAXABLE		
2	<input type="checkbox"/> - Key	RESET	NON-TAXABLE	*	
		SET	TAXABLE		
3	<input type="checkbox"/> OLL DISC Key	RESET	NON-TAXABLE	*	
		SET	TAXABLE		
4	--vacant--	RESET			
		SET			
5	--vacant--	RESET			
		SET			
6	--vacant--	RESET			
		SET			
7	--vacant--	RESET			
		SET			
8	--vacant--	RESET			
		SET			

ADDRESS NO.	CONTENTS
10	REMOTE SLIP CONTROL

Standard Bit Set



BIT NO.	ITEM	SELECTIVE STATUS		STANDARD STATUS	REMARKS
		RESET	SET		
1	Print Form (Left/Right Position)	RESET	ALL ON RIGHT SIDE	*	
		SET	SOME ON LEFT SIDE		
2	--vacant--	RESET			
		SET			
3	--vacant--	RESET			
		SET			
4	--vacant--	RESET			
		SET			
5	--vacant--	RESET			
		SET			
6	--vacant--	RESET			
		SET			
7	--vacant--	RESET			
		SET			
8	--vacant--	RESET			
		SET			

NOTE 1: If status "SET (SOME ON LEFT SIDE)" is selected, items entered through Departments, PLUs, [%+], [%-], and [DOLL DISC] keys will be printed on the left side. All other items will be printed on the right side.

-- Address #11 is vacant. --

COMMERCIAL MESSAGE PROGRAMMING

CONDITION: Any time outside a sale

OPERATION: Mode Lock: SET or MGR

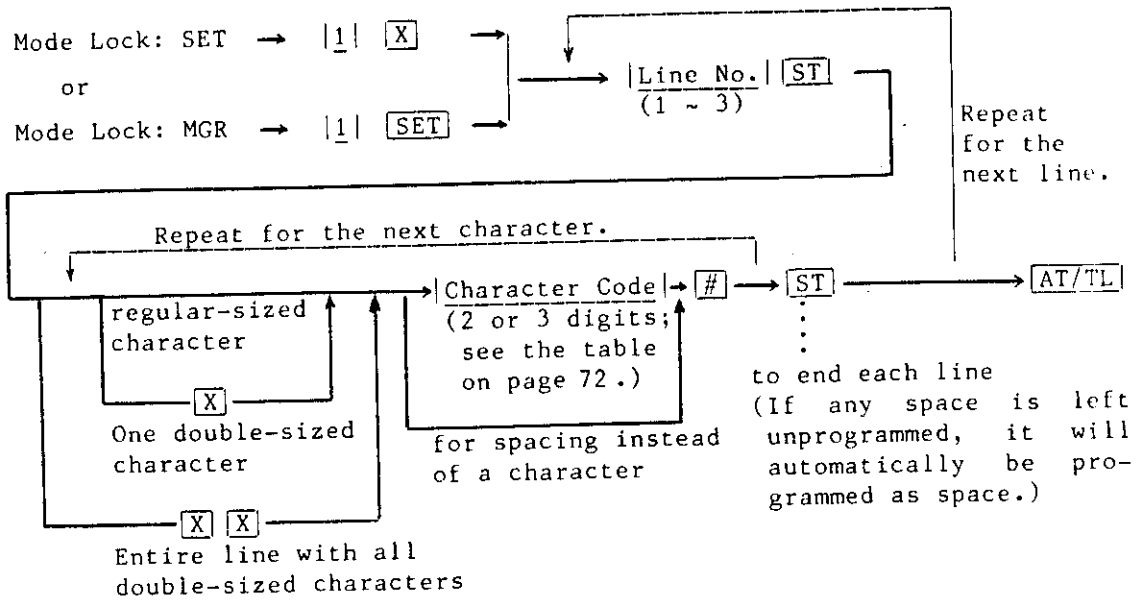

- NOTES: 1. The # key after the Character Code entry may be replaced by the #/CID or #/NS key.
2. For one line, a maximum of 16 regular-sized characters or 8 double-sized characters may be entered. A combination of both types is also available.
3. If no commercial message is required on the receipt, program all space for all the three lines. Then no message will be printed and no extra line space will be fed. If any one of the three lines is ever programmed, the two other lines will remain programmed with space and will turn out to be extra space lines to be fed on the receipt.

ex.) To program "THANK YOU" on the second line. The first and third lines will be space:

Mode Lock to SET, enter 1, depress X.

Enter 2, depress ST (line No.)

Depress # three times (for spacing).

Enter 30, depress # (T).

Enter 18, depress # (H).

Enter 11, depress # (A).

Enter 24, depress # (N).

Enter 21, depress # (K).

Depress #. (space)

Depress #. (space)

Enter 35, depress # (Y).

Enter 25, depress # (O).

Enter 31, depress # (U).

Depress ST (to end the line).

Depress AT/TL (to end this program).

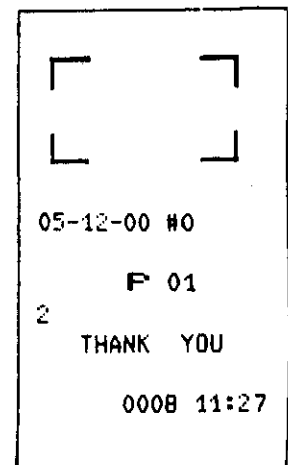

CLERK NAME PROGRAMMING

CONDITION: Any time outside a sale

OPERATION: Mode Lock: SET or MGR

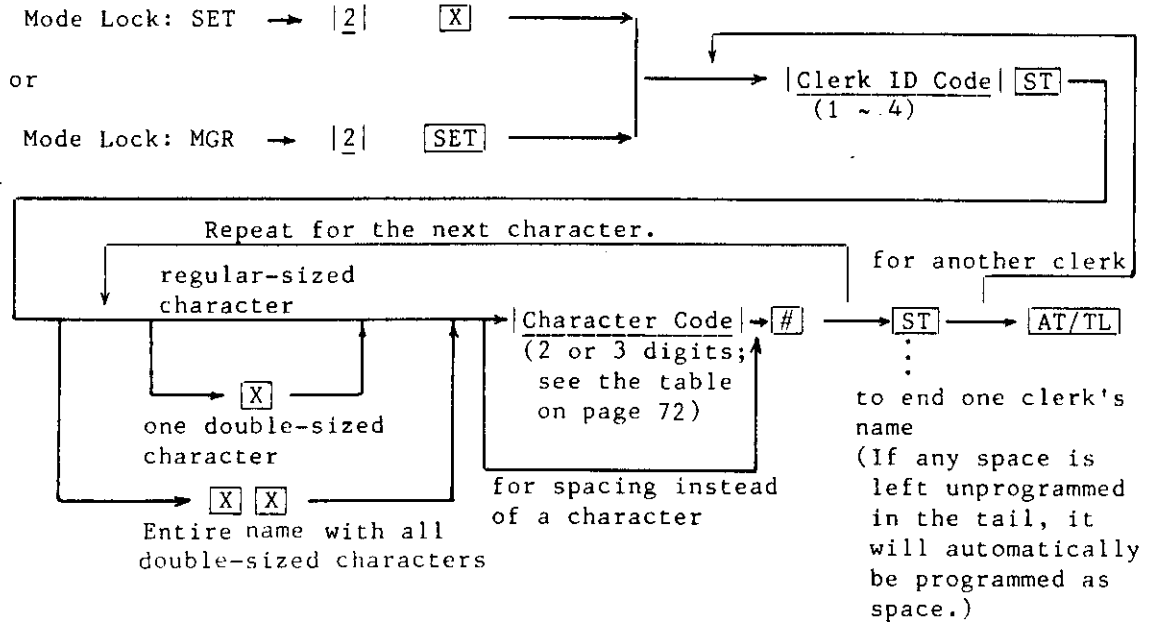

- NOTES:**
1. The **#** key after the Character Code entry may be replaced by the **#/CID** or **#/NS** key.
 2. For the name of one clerk, a maximum of 6 regular-sized characters or 3 double-sized characters may be entered. A combination of both types is also available.
 3. The programmed name will be printed on each receipt issued by the clerk. If no name is programmed for the clerk, the clerk ID code, such as "1CL", "2CL", etc. will be printed instead.

ex.) To program "JONES" for Clerk 1,
 "SMITH" for Clerk 2,
 Nothing for Clerk 3 and Clerk 4:

Mode Lock: SET. Enter 2, depress **X**.
 Enter 1, depress **ST** (Clerk ID Code).
 Enter: 20 → depress: **#** (J)
 25 → **#** (O)
 24 → **#** (N)
 15 → **#** (E)
 29 → **#** (S)
 Depress **ST** (to end Clerk 1).
 Enter 2, depress **ST** (Clerk ID Code).
 Enter: 29 → depress: **#** (S)
 23 → **#** (M)
 19 → **#** (I)
 30 → **#** (T)
 18 → **#** (H)
 Depress **ST** (to end Clerk 2).
 Enter 3, **ST**, depress **#** (space), depress **ST**.
 Enter 4, **ST**, depress **#** (space), depress **ST**. Depress **AT/TL**.

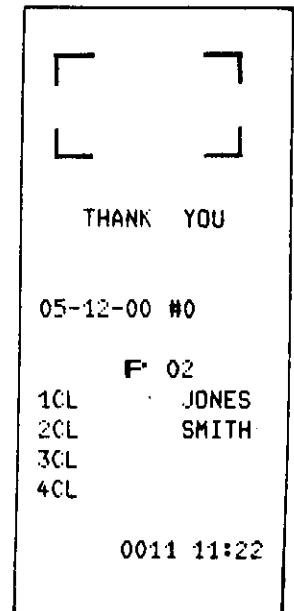

DEPARTMENT NAME AND STATUS PROGRAMMING OR CHANGING

CONDITION: To change the Department Name only: Any time outside a sale
 To change the Department Tax Status: After an Auto Reset
 To change the Department Positive/Negative Status:
 After an Auto Reset, GT Reset, and PLU Reset

OPERATION: Mode Lock: SET

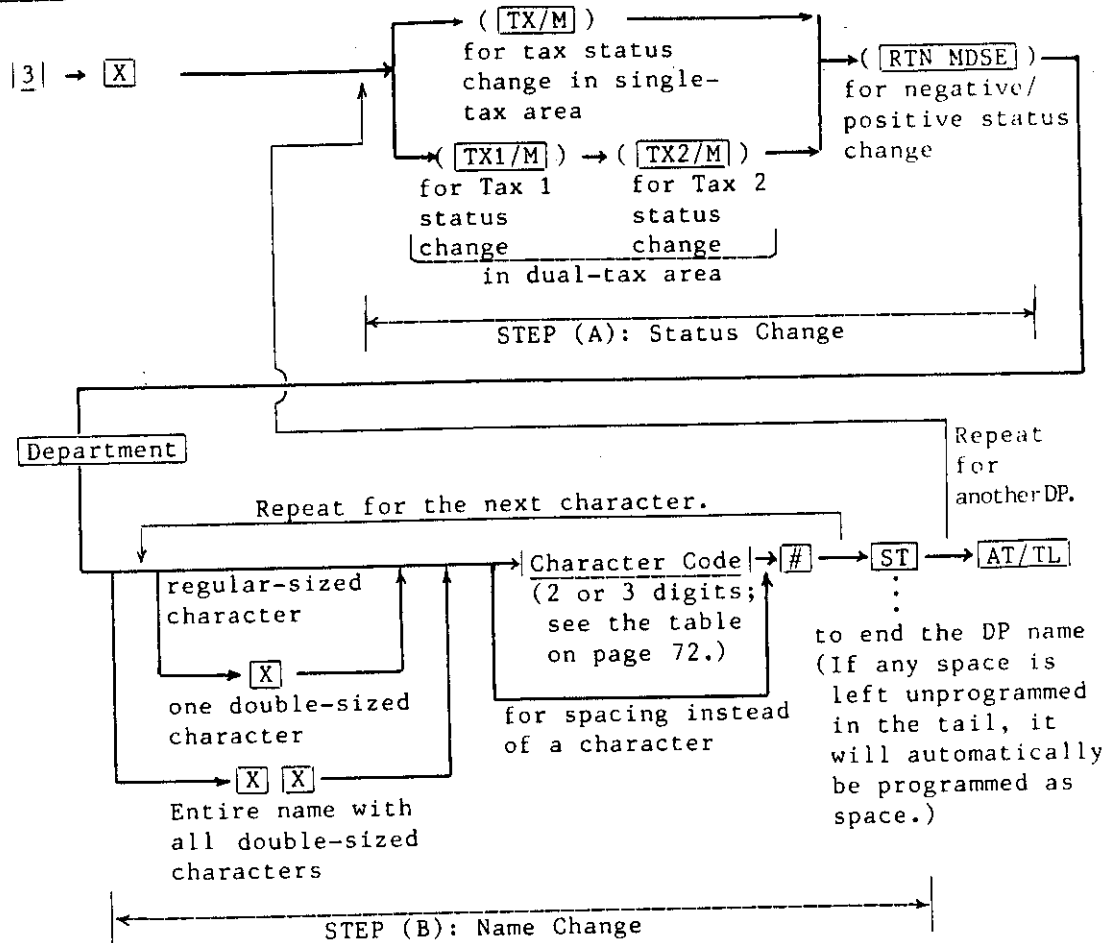

- NOTES:**
1. The "Department" is the Department Key whose status or name should be changed or programmed in this operation.
 2. The # key after the Character Code entry may be replaced by the #/CID or #/NS key.
 3. For the name of a department, a maximum of 6 regular-sized characters or 3 double-sized characters may be entered. A combination of both types is also available.

4. When only the name is programmed or changed but not the status, STEP (A) may be skipped in the above operation. Likewise, when only the status is programmed or changed but not the name, STEP (B) may be skipped.
5. Among **TX1/M** (**TX/M**), and **TX2/M**, depress the key(s) for the required status change(s) for each department. The **RTN MDSE** is depressed to set or reset the negative department status.
6. Depressing any of the three keys above, the related status reverses. For example, depressing the **TX/M** reverses a non-taxable department to a taxable, or taxable to non-taxable. Each department status is read by the number indicated in the AMOUNT portion of the display when each department key is depressed in the above operation. The numbers and their respective statuses are:

0: Non-taxable		"(-)" Lamp lit: negative
1: Tax 1 taxable only		"(-)" Lamp unlit:
2: Tax 2 taxable only		positive
3: Tax 1 and Tax 2 both taxable		(This status is reversed by the RTN MDSE key.)

Watching the number, adjust the status by depressing these keys. See the examples below:

STATUS NUMBER BEFORE CHANGE	→	KEY-IN FOR CHANGE PRIOR TO DEPT KEY	→	NEW NUMBER AND STATUS OBTAINED
0	→	TX1/M	→	1(Tax1 only)
0	→	TX1/M TX2/M	→	3(Tax1 & Tax2)
0	→	TX2/M	→	2(Tax2 only)
		⋮		etc.
1	→	TX1/M	→	0(Non-taxable)
1	→	TX2/M	→	3(Tax1 & Tax2)
1	→	TX1/M TX2/M	→	2(Tax2 only)
		⋮		etc.
2	→	TX2/M	→	0(Non-taxable)
2	→	TX1/M	→	3(Tax1 & Tax2)
3	→	TX1/M	→	2(Tax2 only)
		⋮		etc.

ex.) To set departments to the following status:

Department 1: Taxable (in Single-tax Area), Positive
Department 2: Taxable, Positive
Department 3: Taxable, Positive
Department 4: Taxable, Positive, Name "COFFEE"
Department 5: Non-taxable, Positive
Department 6: Non-taxable, Positive
Department 7: Non-taxable, Positive
Department 8: Non-taxable, Negative

Key Operation:

(Under the condition that all the departments have been preset as non-taxable (Status Number "0") and as positive departments.)

Mode Lock to SET, enter 3, depress X.

Depress TX/M, DEPT 1. ("1" is indicated in the AMOUNT display.)
Depress TX/M, DEPT 2. ("1" is indicated in the AMOUNT display.)
Depress TX/M, DEPT 3. ("1" is indicated in the AMOUNT display.)
Depress TX/M, DEPT 4. ("1" is indicated in the AMOUNT display.)
Enter 13, depress #. (C)
Enter 25, depress #. (O)
Enter 16, depress #. (F)
Enter 16, depress #. (F)
Enter 15, depress #. (E)
Enter 15, depress #. (E)
Depress ST (to end the name).
Depress DEPT 5. ("0" is indicated in the AMOUNT display.)
Depress DEPT 6. ("0" is indicated in the AMOUNT display.)
Depress DEPT 7. ("0" is indicated in the AMOUNT display.)
Depress RTN MDSE, DEPT 8. ("0" is indicated in the amount display, and the "(-)" Lamp is lit.)

Depress AT/TL to end this program.

NOTE: If no name is programmed for a department (as DEPT 1 or DEPT 2 in the above example), the Department No. (ex. "DPO1") will be printed on the receipt and reports as the Department name.

[]	
[]	
THANK YOU	
05-12-00 W0	
P 03	
01	1
02	1
03	1
04	1
04	COFFEE
08	0-
0016 11:23	

PLU TABLE PROGRAMMING OR CHANGING

CONDITION: After a PLU Reset to renew the PLU table,
or any time outside a sale to program additional PLUs or
to change the PLU name only)

OPERATION: Mode Lock: SET for another PLU (max. 50 PLUs)

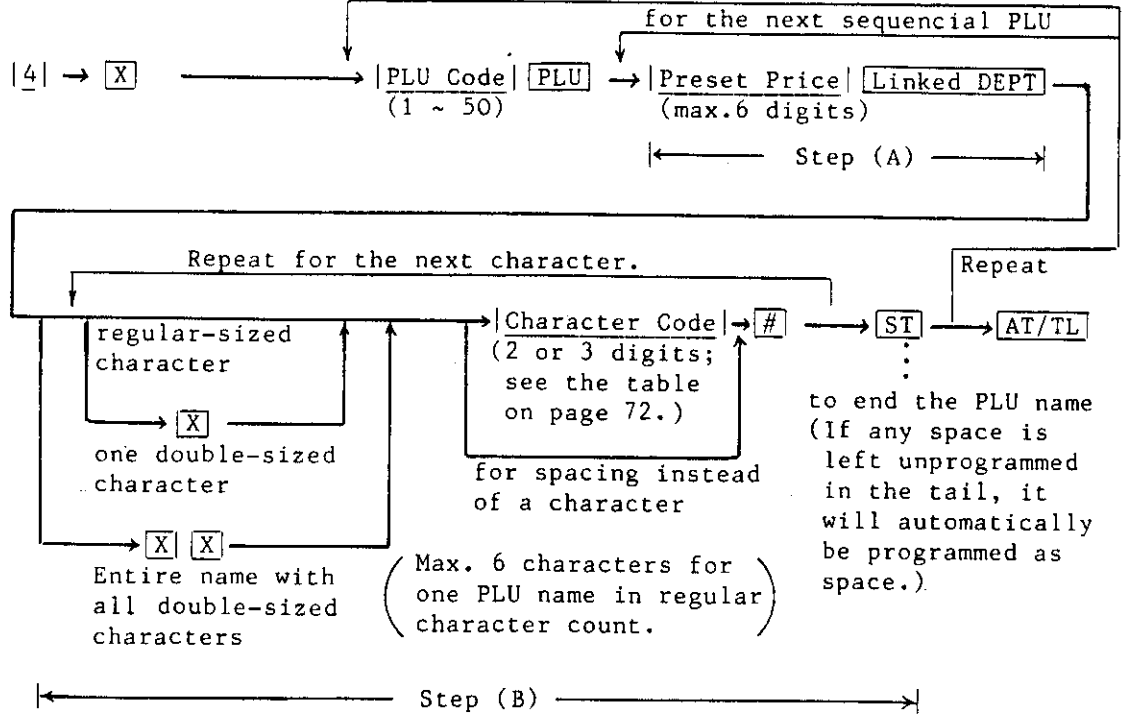

- NOTES:**
1. The "PLU Code | PLU" entry may be skipped if the PLU Code is sequential from the previous PLU's code. If this PLU code entry is skipped at the very first PLU, the PLU code will automatically be programmed as PLU No.1.
 2. The tax status of each PLU will be ruled by the linked Department status.
 3. Step (A) may be skipped if the PLU name only is programmed or changed. Likewise, Step (B) may be skipped if the PLU price and/or linked Department only are changed.
 4. If a PLU is programmed to be linked to a negative department, it will automatically be a negative PLU.

PLU TABLE DELETION

CONDITION: After a PLU Reset

OPERATION: Mode Lock: SET

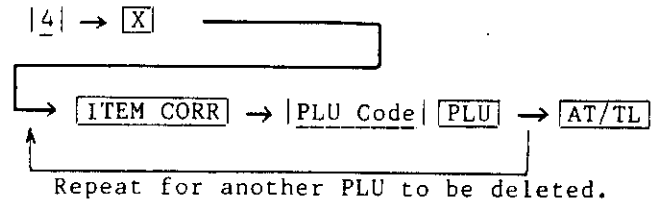

NOTE : Deletion is possible with each PLU code, one by one. Deleting of all the PLUs at once is not possible.

ex.) To program the following PLUs:

<u>PLU NO.</u>	<u>Linked DEPT No.</u>	<u>Preset Price</u>	<u>Name</u>
PLU 05	03	\$1.50	
PLU 20	02	\$2.00	
PLU 25	01	\$1.50	
PLU 30	03	\$0.50	SUGAR

Key Operation

Mode Lock: SET Enter 4, depress .

Enter 5, depress PLU . (PLU No.)

Enter 150, depress DEPT 3 . (Price and Linked Department)

Enter 20, depress PLU . (PLU No.)

Enter 200, depress DEPT 2 . (Price and Linked Department)

Enter 25, depress PLU . (PLU No.)

Enter 150, depress DEPT 1 . (Price and Linked Department)

Enter 30, depress PLU . (PLU NO.)

Enter 50, depress DEPT 3 . (Price and Linked Department)

Enter 29, depress # . (S)

Enter 31, depress # . (U)

Enter 17, depress # . (G)

Enter 11, depress # . (A)

Enter 28, depress # . (R)

Depress ST to end the name setting.

Depress AT/TL to end this program.

ex.) To delete PLU No.30:

Mode Lock: SET Enter 4, depress .

Depress ITEM CORR , enter 30, depress PLU .

Depress AT/TL to end this operation.

```

┌           ┐
└           ┘

THANK YOU

05-12-00 #0

P 04
PLU05 03 1.50
PLU20 02 2.00
PLU25 01 1.50
PLU30 03 0.50
PLU30 SUGAR

0017 11:23

```

```

┌           ┐
└           ┘

THANK YOU

05-12-00 #0

P 04
PLU30
-----

0019 11:23

```

TIME SETTING

CONDITION: Any time outside a sale

OPERATION: Mode Lock: SET or MGR

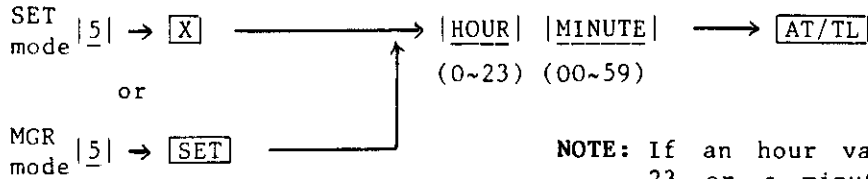

NOTE: If an hour value of more than 23 or a minute value of more than 60 is entered, it will not result in an error. In this case, do the setting operation over again with the correct values.

ex.) To set the time "13:56":

Mode Lock to SET, enter 5, depress .

Enter 1356, depress .

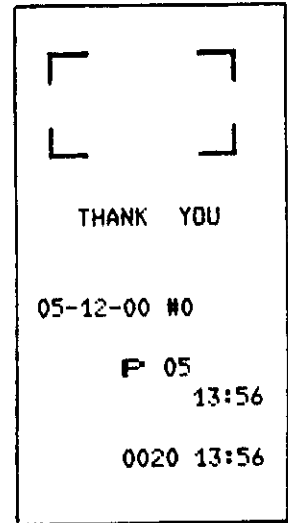

DATE SETTING

CONDITION: Any time outside a sale

OPERATION: Mode Lock: SET

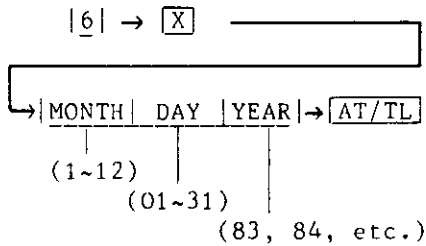

NOTE: The date entry order may be DAY-MONTH-YEAR instead of MONTH-DAY-YEAR, by system option.

ex.) To set the date to May 17, 1983:

Mode Lock to SET, enter 6, depress .

Enter 51783, depress .

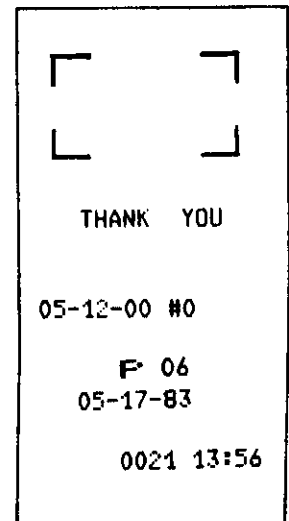

HOURLY RANGE SETTING

CONDITION: After an Hourly Reset

OPERATION: Mode Lock: SET

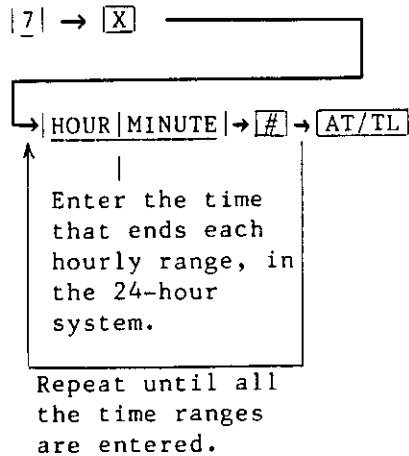

NOTES:

1. A maximum of 16 hourly ranges may be set.
2. To change the table of hourly ranges once set, partially or entirely, do the entire setting operation over again.
3. To reset the hourly range table once set, operate in "SET" mode:
|7| → |X| → |0| → |#| → |AT/TL|
4. Do not set an hourly range across 24:00, such as "from 23:00 to 1:00". If ever set, no data will be processed into that hourly range.
5. If a time value more than 24:00 is set, it will not result in an error but the data will not be processed in that range.

ex.) To reset the hourly range that has been programmed:

Mode Lock to SET, enter 7, depress X .
Enter 0, depress # .
Depress AT/TL .

```

┌       ┐
└       ┘

THANK YOU

05-17-83 #0

F 07
      00:00

0023 13:56
    
```

ex.) To set the following hourly range table:

<u>Table</u>	<u>Key Operation</u>
	Mode Lock to SET
	Enter 7, depress <input type="checkbox"/> X
up to 8:00	Enter 800, depress <input type="checkbox"/> # .
8:00 ~ 16:00	Enter 1600, depress <input type="checkbox"/> # .
16:00 ~ 23:00	Enter 2300, depress <input type="checkbox"/> # .
	Depress <input type="checkbox"/> AT/TL to end this program.

```

┌       ┐
└       ┘

THANK YOU

05-17-83 #0

F 07
      08:00
      16:00
      23:00

0024 13:56
    
```

DEPARTMENT LISTING CAPACITY SETTING

CONDITION: After an Auto Reset

OPERATION: Mode Lock: SET

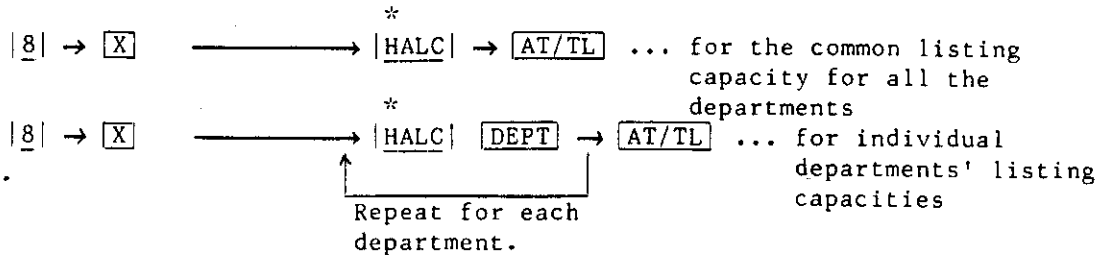

The above two operations may be combined as below:

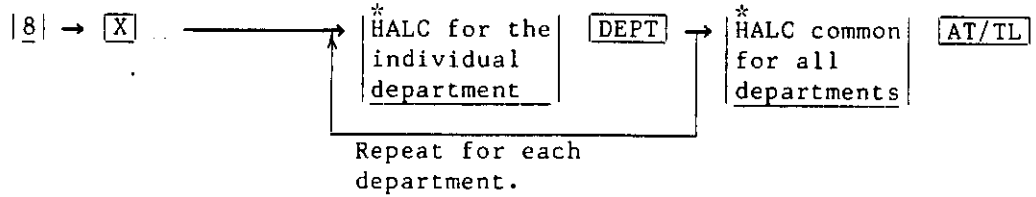

*Note: HALC High Amount Listing Capacity (to be set in a 2-digit code)

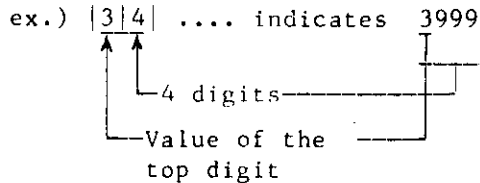
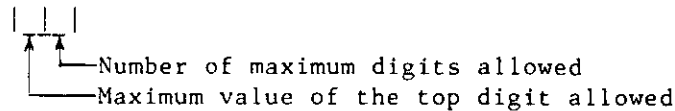

The amount range allowed to enter will be:
Equal to or smaller than the HALC (3999 in this case.)

- NOTES:**
1. If the individual listing capacity of a department has been set, it prevails over the common listing capacity.
 2. To reset an individual department listing capacity, enter "0" before the [DEPT] key in the above operation. Then the common listing capacity of all the departments, if pre-programmed, will prevail. The common listing capacity may also be reset if "0" is entered as the HALC in the above operation.

ex.) To set HALC's: \$9.99 for Dept.1
\$99.99 for Dept.2
\$99,999.99 as common L.C.

OPERATION: (Mode Lock: SET)

8 [X] 93 [DEPT 1] 94 [DEPT 2] 97 [AT/TL]

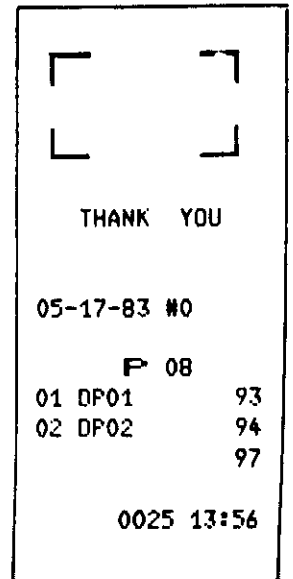

FINANCIAL TOTAL NAME PROGRAMMING OR CHANGING

CONDITION: After an Auto Reset and GT Reset

OPERATION: Mode Lock: SET

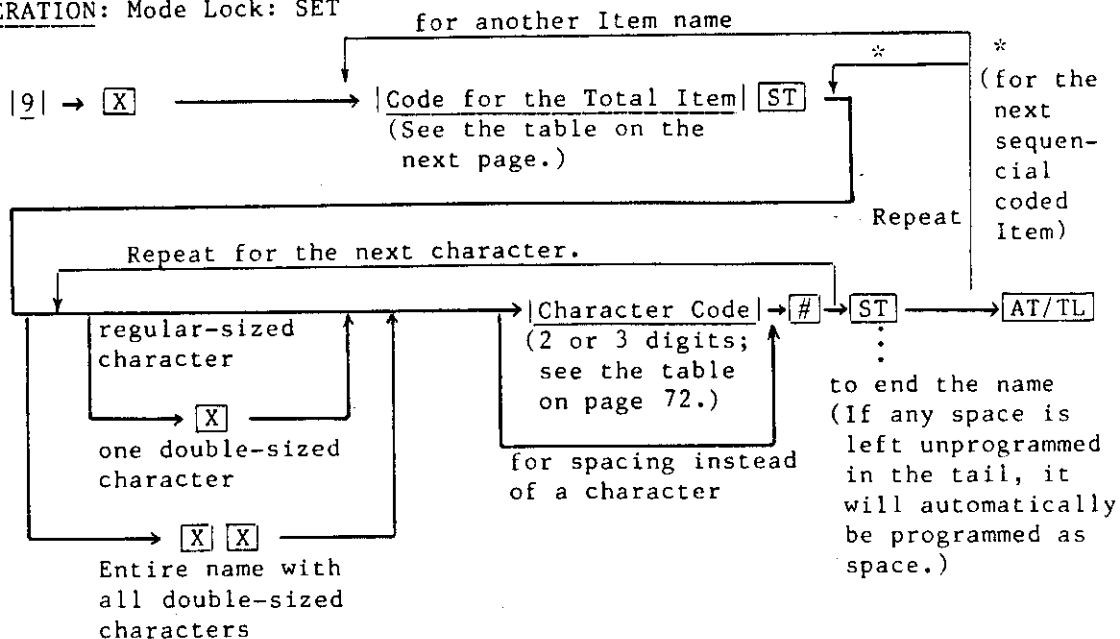

- NOTES:**
1. A maximum of 6 regular-sized characters or 3 double-sized characters may be programmed for one item name, with some exceptions. A combination of two types is also available.
 2. To go on to another Item name programming, the sequence "Code for the Total Item [ST]" may be skipped if the code is sequential.

ex.) To program:

Item Code 15 (Paid Out) to "PO" (both double-sized), and
Item Code 23 (Return Merchandise) to "RTN" (all regular-sized):

Key Operation

Mode Lock to SET, enter 9, depress [X].

Enter 15, depress [ST]. (Item Code)

Depress [X] twice.

Enter 26, depress [#]. (P)

Enter 25, depress [#]. (O)

Depress [ST] (to end the name).

Enter 23, depress [ST] (Item Code).

Enter 28, depress [#]. (R)

Enter 30, depress [#]. (T)

Enter 24, depress [#]. (N)

Depress [ST] (to end the name).

Depress [AT/TL] to end this program.

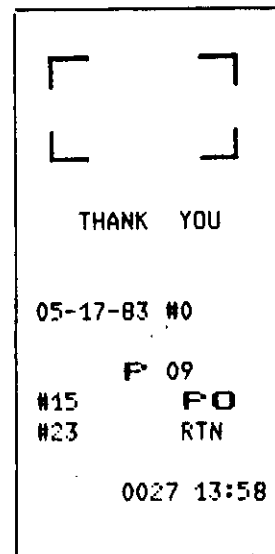

FINANCIAL TOTAL NAME TABLE

Code	Total or Counter	Max.Number of Characters	Name in Standard Program	Your Plan	Remarks
1	GT	6	G T		
2	GS	6	G S		
3	%+	6	% +		
4	Net Sale (without TAX)	6	N S		
5	TAX 1	6	TAX 1		
6	TAX 2	6	TAX 2		
7	Net Sale (with TAX)	6	N S		
8	%- (on ST)	6	% -		
9	DOLL DISC	6	D I S C		
10	MEDIA TL	6	T O T A L		
11	CATL	6	C A S H		Cash Total
12	CKTL	6	C H E C K		Check Total
13	CHTL	6	C h g		Charge Total
14	Received on Account	6	R / A		on R/J and Report
15	Paid Out	6	P O		on R/J and Report
16	Cash-in-drawer	6	C A I D		
17	Check-in-drawer	6	C K I D		
18	Charge-in-drawer	6	C h g I D		
19	VD 1	6	C O R R		Item Corr on DP(+)
20	VD 2	6	M S V D		Item Corr on Others
21	%- (on Item)	6	% -		
22	Negative DP Total	6	- D P T L		
23	Return Merchandise	6	R T N		
24	Negative Tax	6	- T A X		
25	Negative Mode(-)	6	R E G -		
26	Taxable Total 1	6	T X B L 1		
27	Taxable Total 2	6	T X B L 2		
28	No-sale Counter	6	N O S A L E		
29	Validation Counter	6	V A L C T R		
30	Clerk Neg. Total 1	6	N E G 1		
31	Clerk Neg. Total 2	6	N E G 2		
32	Clerk TAX	6	T A X		
33	R/A, PO	3,3	R / A P O		on Validation
34	Item Corr, Return	3,3	V D R T N		on Validation

NOTE: The print data shown in the "Name in Standard Program" column in the above table are automatically set on the ECR MA-1050-100 for the convenience of the customer. Therefore, program only the items that require changes from the standard print data.

PRINT LINE ITEM NAME PROGRAMMING OR CHANGING

CONDITION: Any time outside a sale

OPERATION: Mode Lock: SET

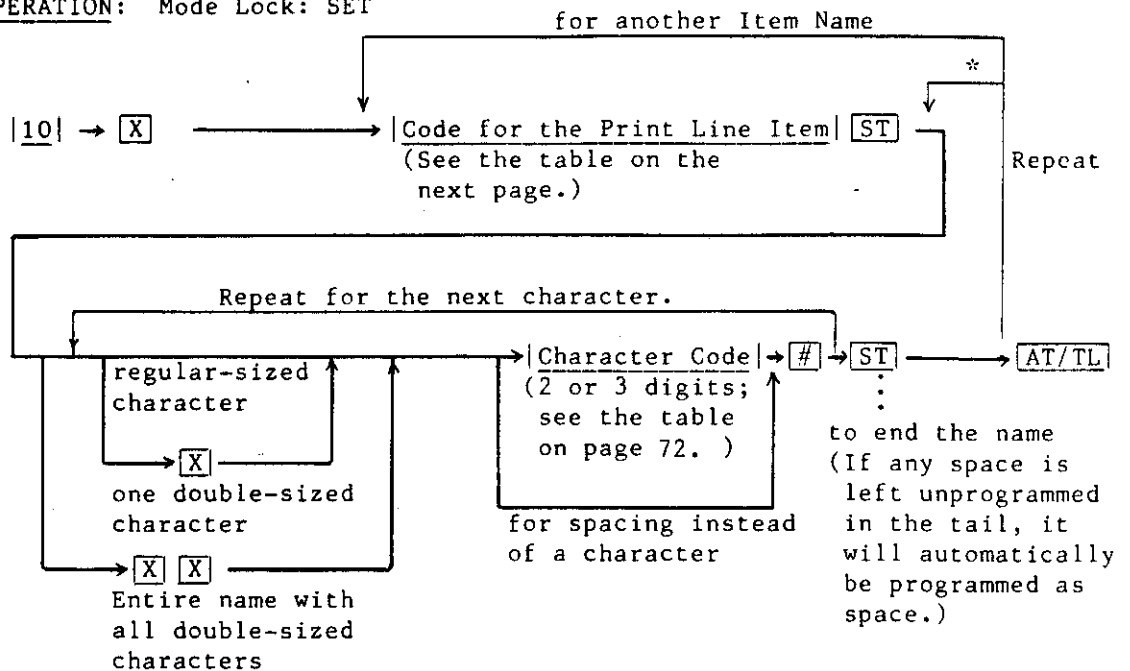

- NOTES:**
1. See the "Max.Number of Characters" column of the table on the next page as to the number of characters programmable for each item name. The number in the column indicates the capacity in regular-sized characters. One double-sized character occupies two regular-sized characters' space.
 2. To go on to another Item name programming, the sequence "|Code for the Print Line Item| ST" may be skipped if the code is sequential. In this case, follow the line marked with "*".

ex.) To program "TL" (both double-sized) for Item Code 3 (Total):

Mode Lock to SET, enter 10, depress X.

Enter 3, depress ST. (Item Code)
 Depress X twice.
 Enter 30, depress #.
 Enter 22, depress #.
 Depress ST.
 Depress AT/TL (to end this program).

NOTE: If Item Code 3 is not programmed with "TL" in the above operation example, the standard print data "TOTAL" (all regular-sized characters) should have been alive.

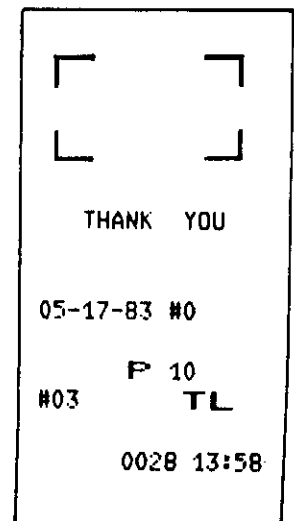

PRINT LINE ITEM NAME TABLE

Code	Print Line Item	Max.Number of Characters	Name in Standard Program	Your Plan	Remarks
1	Sub-total	6	S U B T L		
2	Cash Tendered	6	C A T E N D		
3	Total	6	T O T A L		
4	Change	6	C H A N G E		
5	Refund Money	6	C A S H		for AudactionTotal
6	Group Sub-total	6	G R P . S T		
7	Non-taxable Sub-total	6	N T X . S T		
8	Unit Price	1	@		These three must be set together.
	Amount	1			
	Sales Item Count	4	I T E M		
9	Reg.No. Symbol	2	#		These two must be set together.
	Clerk (for Validation)	2	C L		
10	Customer Count	2	C U		on reports

NOTE: If no programming operation is done for an item, the "Name in Standard Program" will automatically be active. Therefore, program only the items that require changes from the standard print data.

FIXED PRINT LINE ITEM NAMES (NOT PROGRAMMABLE)

Print Line Item	Number of Characters	Fixed Item Name	Remarks
Cons.No. Symbol	0		No symbol printed
Program Symbol	2	P	
Read (X) Symbol	2	X	
Reset (Z) Symbol	2	Z	
GT Read Symbol	6	G T X	
GT Reset Symbol	6	G T Z	
System Option Address	1	#	
% Symbol	1	%	
PLU Name	5	P L U x x	xx is the PLU No. 1
DP Name	4	D P x x	xx is the DP No. 2
Non-add No. Symbol	1	#	
Taxable Symbol	1	T	for Tax1 and/or Tax2
Negative Symbol	1	-	
Q'ty in Multiplication	1	X	

NOTES 1 2 : These print line item names will be printed in case there has been no name programmed for the registered PLU or Department.

NON-TAXABLE AMOUNT LIMIT SETTING

CONDITION: After an Auto Reset and GT Reset; this program is applicable only to restaurants in Province of Quebec, Canada.

If this program has been set, the tax is calculated and added to the sale total which exceeds the limit amount even when the sale is entirely composed of non-taxable items. The tax levied when exceeding this limit amount will be calculated by the TAX 1 table which is to be described and programmed later in this manual.

OPERATION: Mode Lock: SET

|12| → → max. 4 digits
|Non-taxable Limit Amount| → AT/TL

- NOTES:**
1. To reset the limit amount once set, enter "0" in place of the |Non-taxable Limit Amount| in the above operation.
 2. This tax calculation program will be disregarded when the sale total is negative.

Example: Setting limit amount to "\$3.25":

Case 1) Normal Department Entry (Mode Lock: REG)

|326| → non-taxable DEPT → AT/TL

... The amount entered \$3.26 is greater than the limit amount \$3.25. It will therefore be taxed.

Case 2) Returned Merchandise Entry (Mode Lock: REG)

RTN MDSE → |326| → non-taxable DEPT → AT/TL

... The non-taxable total is negative. The tax already levied will therefore not be returned.

ex.) To set the Non-taxable Limit Amount to \$20.00:

Mode Lock: SET

Enter 12, depress .
Enter 2000, depress AT/TL.

┌ ┐ └ ┘
THANK YOU
05-17-83 #0
F 12 20.00
0029 13:58

DEPARTMENT PRESET PRICE SETTING OR CHANGING

CONDITION: Any time outside a sale

OPERATION: Mode Lock: SET or MGR

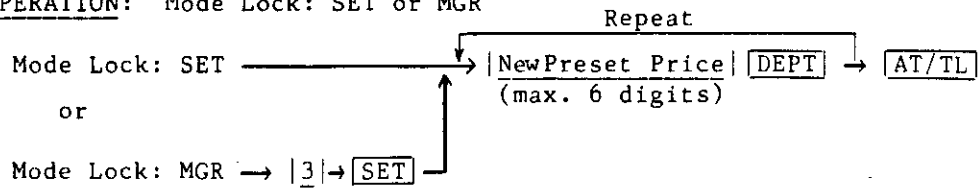

- NOTES:** 1. To preset the price of "0", enter "0" in place of the price entry in the above operation.
2. If no price is entered in the above operation, the department is set as an open department.

ex.) To set \$1.00 to Department 4, and
\$2.50 to Department 7:

Key Operation

Mode Lock to SET.

Enter 100, depress [DEPT 4].
Enter 250, depress [DEPT 7].
Depress [AT/TL] (to end this program).

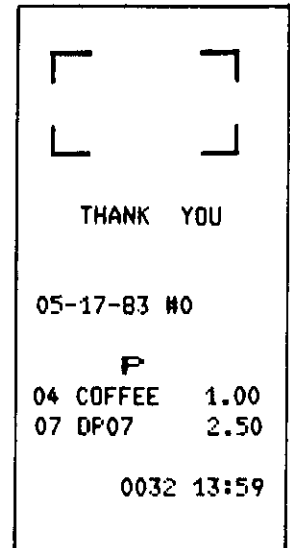

PLU PRESET PRICE CHANGING

CONDITION: Any time outside a sale

OPERATION: Mode Lock: SET or MGR

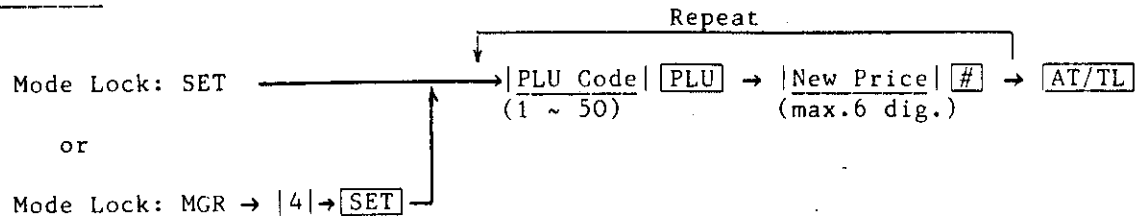

- NOTES:**
1. If "0" is entered as the New Price, the preset price of the PLU will be set to be "0". If the New Price entry is skipped before the [#] key, it will result in an error.
 2. In this operation, changes of link departments, programming additional PLUs, programming or changing the PLU name are not possible.

ex.) To change the preset price of PLU No.5 (previously programmed with \$1.50 as the preset price) to the new price of \$1.00:

Key Operation

Mode Lock to SET.

Enter 50, depress [PLU]. (PLU No.)
Enter 100, depress [#]. (New Price)

Depress [AT/TL] (to end this program).

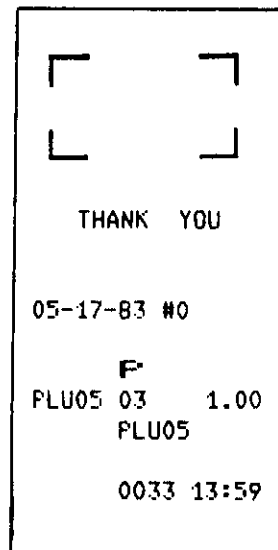

%+ AND %- PRESET RATE SETTING

CONDITION: Any time outside a sale

OPERATION: Mode Lock: SET

|Preset % Rate| → [%+] (or [%-])

(0.001 ~ 99.999; use the [.] key if a decimal portion is contained.)

ex.) To set the %+ preset rate of "10%":

Mode Lock: SET, enter 10, depress [%+].

ex.) To set the %- preset rate of "20%":

Mode Lock: SET, enter 20, depress [%-].

NOTE: To reset the rate once set:

Mode Lock: SET → |0| → [%+] (or [%-])

STORE/REGISTER NO. SETTING

CONDITION: After an Auto Reset and GT Reset

OPERATION: Mode Lock: SET

|Store/Register No.| → [#]
(max. 6 digits;
0 ~ 999999)

NOTE: The [.] key can not be used in setting the Store/Register No.

ex.) To set Store/Register No. "123456":

Mode Lock: SET, enter 123456, depress [#].

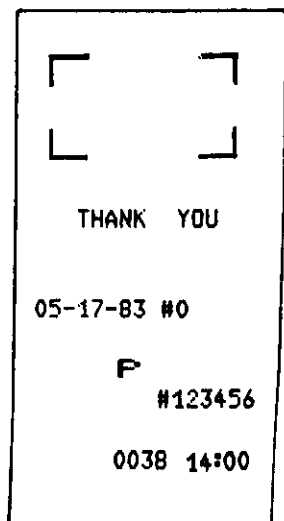
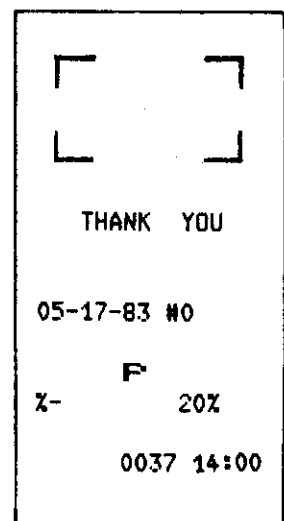
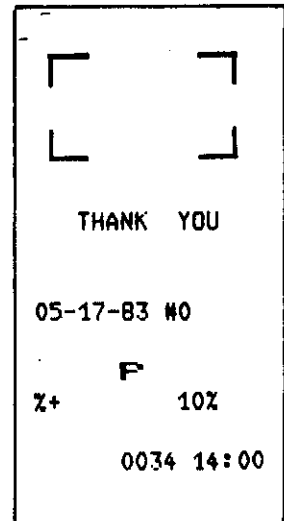

- NOTES: 1. If only one tax modifier key (TX/M) is installed on the keyboard, use the TX/M in place of the TX1/M in the description of 1), 2), or 3) above.
2. For TAX 2 Table programming, follow the same procedure in 1), 2), or 3) above, using the TX2/M instead of the TX1/M.
3. If both TAX 1 and TAX 2 tables are programmed, the TAX 1 must be set first. The TAX 1 table entry will automatically reset both the TAX 1 and TAX 2 tables that have been programmed.
4. No second depression of the ST key is allowed within one tax table programming.

ex.1) Full Breaks (in a single-tax area)

Amount Range	Tax Levied	Key Operation	05-17-83 #123456
		Mode Lock to SET.	
\$0.00~ \$0.10	0¢	Enter 10, depress <u>TX/M</u> .	00 P TAX1 0.10
\$0.11~ \$0.22	1¢	Enter 22, depress <u>TX/M</u> .	01 0.22
\$0.23~ \$0.39	2¢	Enter 39, depress <u>TX/M</u> .	02 0.39
\$0.40~ \$0.56	3¢	Enter 56, depress <u>TX/M</u> .	03 0.56
\$0.57~ \$0.73	4¢	Enter 73, depress <u>TX/M</u> .	04 0.73
\$0.74~ \$0.90	5¢	Enter 90, depress <u>TX/M</u> .	05 0.90
\$0.91~ \$1.08	6¢	Enter 108, depress <u>TX/M</u> .	06 1.08
"A" Break		Depress <u>ST</u> .	*
\$1.09~ \$1.24	7¢	Enter 124, depress <u>TX/M</u> .	07 1.24
\$1.25~ \$1.41	8¢	Enter 141, depress <u>TX/M</u> .	08 1.41
\$1.42~ \$1.58	9¢	Enter 158, depress <u>TX/M</u> .	09 1.58
\$1.59~ \$1.74	10¢	Enter 174, depress <u>TX/M</u> .	10 1.74
\$1.75~ \$1.91	11¢	Enter 191, depress <u>TX/M</u> .	11 1.91
\$2.92~ \$2.08	12¢	Enter 208, depress <u>TX/M</u> .	12 2.08
"B" Break		Depress <u>AT/TL</u> .	**
			0039 14:07

ex.2) "A" Break and % Rate Combination (in a single-tax area)

Amount Range	Tax Levied	Key Operation	05-17-83 #123456
		Mode Lock to SET.	
\$0.00~ \$0.19	0¢	Enter 19, depress <u>TX/M</u> .	00 P TAX1 0.19
\$0.20~ \$0.39	1¢	Enter 39, depress <u>TX/M</u> .	01 0.39
\$0.40~ \$0.59	2¢	Enter 59, depress <u>TX/M</u> .	02 0.59
\$0.60~ \$0.79	3¢	Enter 79, depress <u>TX/M</u> .	03 0.79
\$0.80~ \$0.99	4¢	Enter 99, depress <u>TX/M</u> .	04 0.99
"A" Break		Depress <u>ST</u> .	*
5% is applied above the "A" Break.		Enter 500, depress <u>AT/TL</u> .	5%
			0041 14:07

ex.3) % Rate Only (in a single-tax area)

Amount Range	Tax Levied	Key Operation	05-17-83 #123456
		Mode Lock to SET.	
		Enter 0, depress <u>TX/M</u> .	00 P TAX1 0.00
10% is applied to any amount.		Depress <u>ST</u> .	*
		Enter 1000, depress <u>AT/TL</u> .	10%
			0040 14:07

PROGRAMMING OPERATIONS IN "MGR" MODE (MANAGER'S PROGRAMMING)

In this chapter are described operations to add to or change the data already programmed in the "SET" mode. In order to fulfill each store's requirements for changing the programmed data on the daily, weekly, or monthly basis, these operations are designed to be available in the "MGR" position of the Mode Lock, which can be accessed by the MGR or MA key. These operations are also available in the "SET" mode so that the programmer may cover them along with other major items to be programmed or changed on a longer period basis. To enable the programming operations in the "MGR" mode, the SET key must be installed on the keyboard.

TABLE OF CONTENTS

<u>"MGR" MODE</u> <u>Prog. No.</u>	<u>Program Item</u>	<u>Condition</u>	<u>page</u>
1 ---	COMMERCIAL MESSAGE PROGRAMMING -----	Anytime ¹ -----	67
2 ---	CLERK NAME PROGRAMMING -----	Anytime -----	68
3 ---	DEPARTMENT PRESET PRICE SETTING OR CHANGING ----	Anytime -----	69
4 ---	PLU PRESET PRICE CHANGING -----	Anytime -----	70
5 ---	TIME SETTING -----	Anytime -----	71

NOTE 1: "Anytime" indicates "Anytime outside a sale".

COMMERCIAL MESSAGE PROGRAMMING

CONDITION: Any time outside a sale

OPERATION:

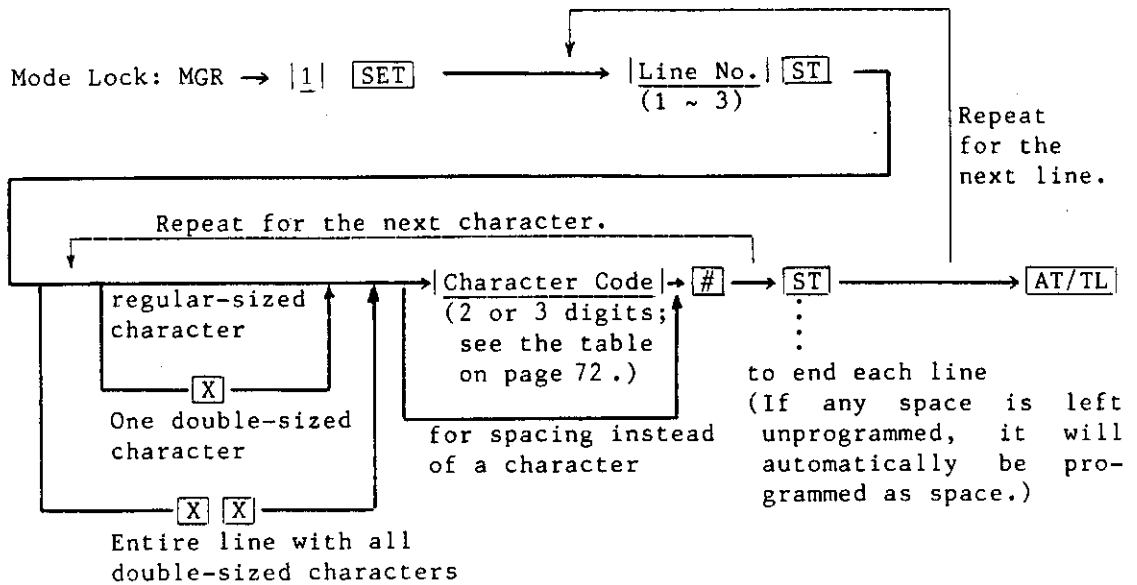

- NOTES:**
1. The **#** key after the Character Code entry may be replaced by the **#/CID** or **#/NS** key.
 2. For one line, a maximum of 16 regular-sized characters or 8 double-sized characters may be entered. A combination of both types is also available.
 3. If no commercial message is required on the receipt, program all space for all the three lines. Then no message will be printed and no extra line space will be fed. If any one of the three lines is ever programmed, the two other lines will remain programmed with space and will turn out to be extra space lines to be fed on the receipt.

ex.) To program "THANK YOU" on the second line. The first and third lines will be space:

Mode Lock to MGR, enter 1, depress **SET**.
 Enter 2, depress **ST** (line No.).
 Depress **#** three times (for spacing).
 Enter 30, depress **#** (T).
 Enter 18, depress **#** (H).
 Enter 11, depress **#** (A).
 Enter 24, depress **#** (N).
 Enter 21, depress **#** (K).
 Depress **#**. (space)
 Depress **#**. (space)
 Enter 35, depress **#** (Y).
 Enter 25, depress **#** (O).
 Enter 31, depress **#** (U).
 Depress **ST** (to end the line).
 Depress **AT/TL** (to end this program).

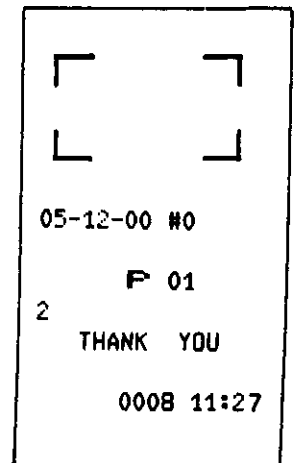

CLERK NAME PROGRAMMING

CONDITION: Any time outside a sale

OPERATION:

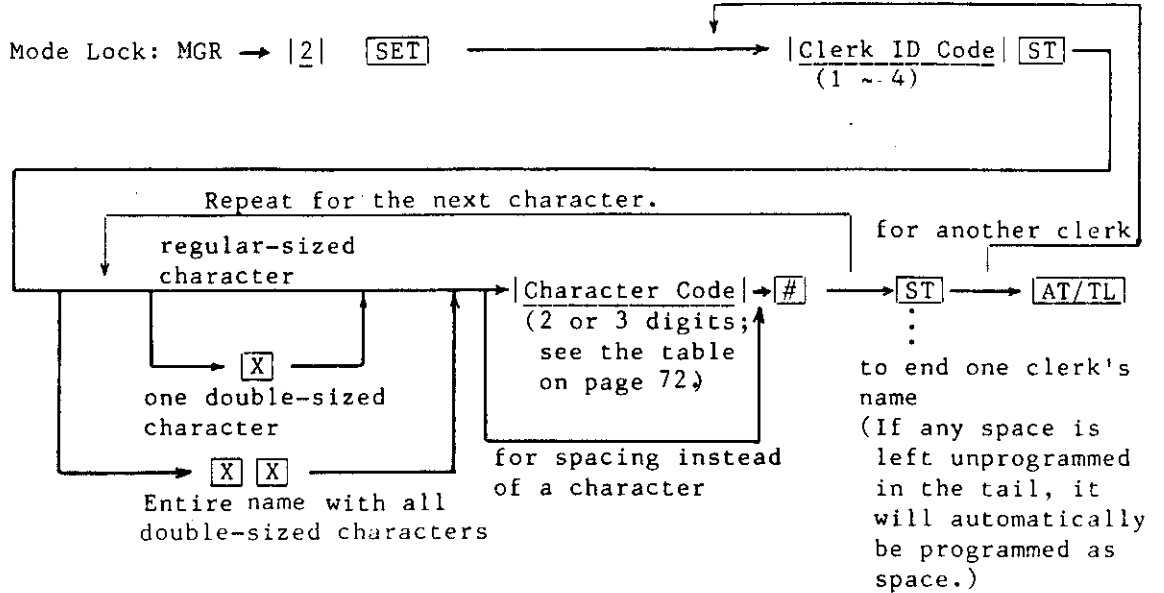

- NOTES:**
1. The **[#]** key after the Character Code entry may be replaced by the **[#/CID]** or **[#/NS]** key.
 2. For the name of one clerk, a maximum of 6 regular-sized characters or 3 double-sized characters may be entered. A combination of both types is also available.
 3. The programmed name will be printed on each receipt issued by the clerk. If no name is programmed for the clerk, the clerk ID code, such as "1CL", "2CL", etc. will be printed instead.

ex.) To program "JONES" for Clerk 1,
 "SMITH" for Clerk 2,
 Nothing for Clerk 3 and Clerk 4:

Mode Lock: MGR. Enter 2, depress **[SET]**.
 Enter 1, depress **[ST]** (Clerk ID Code).
 Enter: 20 → depress: **[#]** (J)
 25 → **[#]** (O)
 24 → **[#]** (N)
 15 → **[#]** (E)
 29 → **[#]** (S)
 Depress **[ST]** (to end Clerk 1).
 Enter 2, depress **[ST]** (Clerk ID Code).
 Enter: 29 → depress: **[#]** (S)
 23 → **[#]** (M)
 19 → **[#]** (I)
 30 → **[#]** (T)
 18 → **[#]** (H)
 Depress **[ST]** (to end Clerk 2).
 Enter 3, **[ST]**, depress **[#]** (space), depress **[ST]**.
 Enter 4, **[ST]**, depress **[#]** (space), depress **[ST]**. Depress **[AT/TL]**.

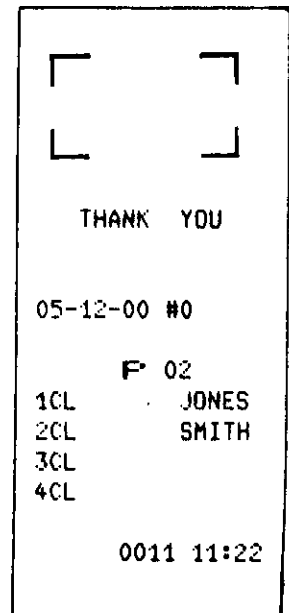

DEPARTMENT PRESET PRICE SETTING OR CHANGING

CONDITION: Any time outside a sale

OPERATION:

Mode Lock: MGR → | 3 | [SET] → NewPreset Price
(max. 6 digits) [DEPT] → [AT/TL]

Repeat

- NOTES:** 1. To preset the price of "0", enter "0" in place of the price entry in the above operation.
2. If no price is entered in the above operation, the department is set as an open department.

ex.) To set \$1.00 to Department 4, and
\$2.50 to Department 7:

Key Operation

Mode Lock to MGR, enter 3, depress [SET].

Enter 100, depress [DEPT 4].

Enter 250, depress [DEPT 7].

Depress [AT/TL] (to end this program).

┌ ┐ └ ┘
THANK YOU
05-17-83 #0
P
04 COFFEE 1.00
07 DP07 2.50
0032 13:59

PLU PRESET PRICE CHANGING

CONDITION: Any time outside a sale

OPERATION:

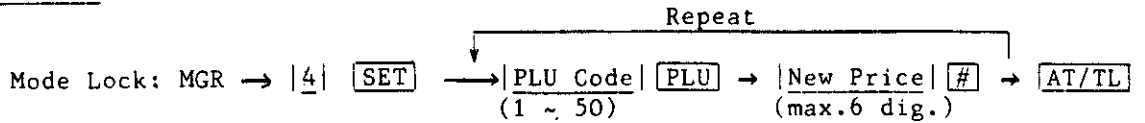

- NOTES:** 1. If "0" is entered as the New Price, the preset price of the PLU will be set to be "0". If the New Price entry is skipped before the [#] key, it will result in an error.
2. In this operation, changes of link departments, programming additional PLUs, programming or changing the PLU name are not possible.

ex.) To change the preset price of PLU No.5 (previously programmed with \$1.50 as the preset price) to the new price of \$1.00:

Key Operation

Mode Lock to MGR, enter 4, depress [SET].

Enter 50, depress [PLU]. (PLU No.)
Enter 100, depress [#]. (New Price)

Depress [AT/TL] (to end this program).

┌	┐
└	┘
THANK YOU	
05-17-83 #0	
P	
PLU05 03	1.00
PLU05	
0033 13:59	

TIME SETTING

CONDITION: Any time outside a sale

OPERATION: Mode Lock:

|5| **SET** → |HOUR| |MINUTE| → **AT/TL**
(0~23) (00~59)

NOTE: If an hour value of more than 23 or a minute value of more than 60 is entered, it will not result in an error. In this case, do the setting operation over again with the correct values.

ex.) To set the time "13:56":

Mode Lock to MGR, enter 5, depress **SET**.

Enter 1356, depress **AT/TL**.

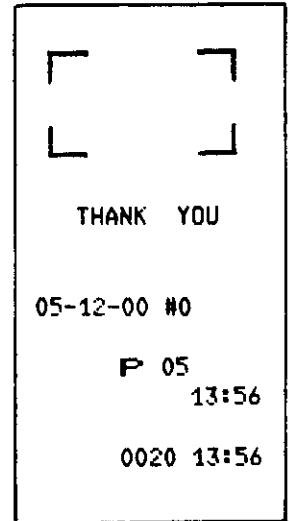

CHARACTER CODE TABLE (Standard Characters)

→ Column Code

	0	1	2	3	4	5	6	7	8	9	10	11	12	13	14	15	16	
↓ Row Code	0	0	@	J	T	ア	サ	ナ	マ	ラ	ア	,	½	j	t	Ä	ä	â
	1	1	A	K	U	イ	シ	ニ	ミ	リ	イ	.	a	k	u	Ö	ö	ê
	2	2	B	L	V	ウ	ス	ヌ	ム	ル	ウ	:	b	l	v	Ü	ü	ç
	3	3	C	M	W	エ	セ	ネ	メ	レ	エ	'	c	m	w	Æ	æ	é
	4	4	D	N	X	オ	ソ	ノ	モ	ロ	オ	/	d	n	x	Œ	œ	è
	5	5	E	O	Y	カ	タ	ハ	ヤ	ワ	ツ	#	e	o	y	Å	å	ú
	6	6	F	P	Z	キ	チ	ビ	ユ	ヲ	ヤ	*	f	p	z	Ñ	ñ	á
	7	7	G	Q	\$	ク	ツ	フ	ヨ	ン	ユ		g	q	+	%	ß	í
	8	8	H	R	£	ケ	テ	ヘ	["	ヨ	&	h	r	ø	///	Đ	ó
	9	9	I	S	¥	コ	ト	ホ]	°	-	!	i	s	=	?	ø	

CHARACTER CODE TABLE (Kanji Characters)

→ Column Code

	20	21	22	23	24	25	
↓ Row Code	0	合	入	取	高	月	特
	1	計	金	消	課	日	奉
	2	現	返	客	税	組	休
	3	小	支	点	万	人	~
	4	預	払	回	買	上	
	5	釣	値	数	責	仕	
	6	掛	引	信	受	名	
	7	売	割	純	免	訂	
	8	戻	個	円	料	定	
	9	替	券	在	年	総	

WAY OF INPUTTING CODES: First enter the Column Code and then the Row Code for the required character. For example, to access "B", enter 12.
Each of the Kanji Characters occupies a double-sized character space.

PROGRAMMING OPERATIONS THROUGH THE PROGRAMMING KEYBOARD (OPTIONAL)

The TEC Programming Keyboard (TKB-1-A) may be connected to the MA-1050-100 ECR as an optional device for programming routines.

With this keyboard, programming operations, particularly those requiring alpha/numeric character setting for descriptors of departments, PLUs, and Clerk Names, etc. will be performed more easily.

CONNECTION TO THE ECR

- (1) Open the Ribbon Cover of the ECR and follow the descriptions referring to the figure below:

OVERVIEW BEHIND RIBBON COVER

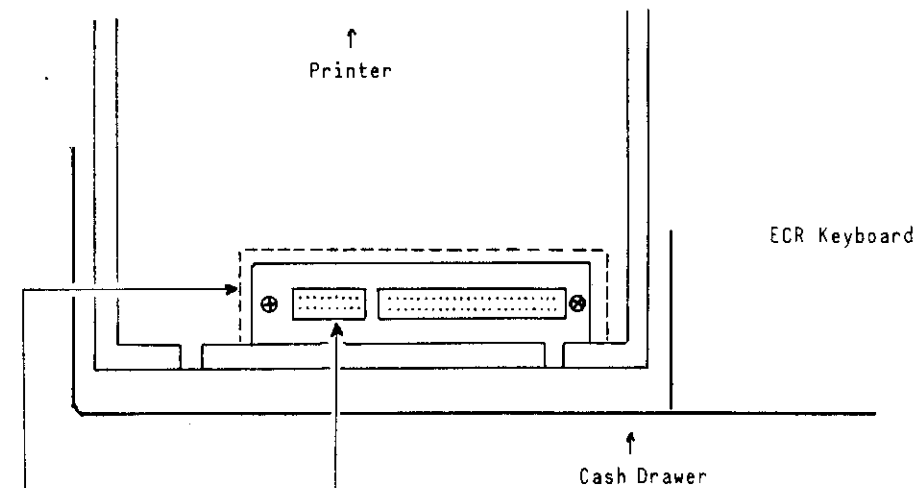

(2) Remove the cover.

(3) Connect the connector cable of the Programming Keyboard.

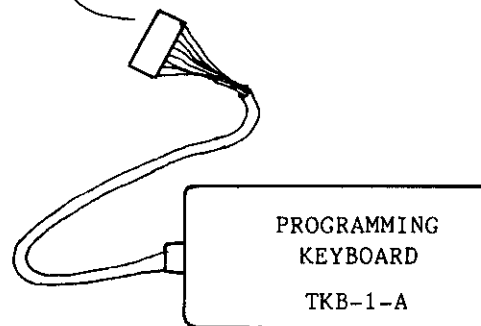

KEYBOARD LAYOUT

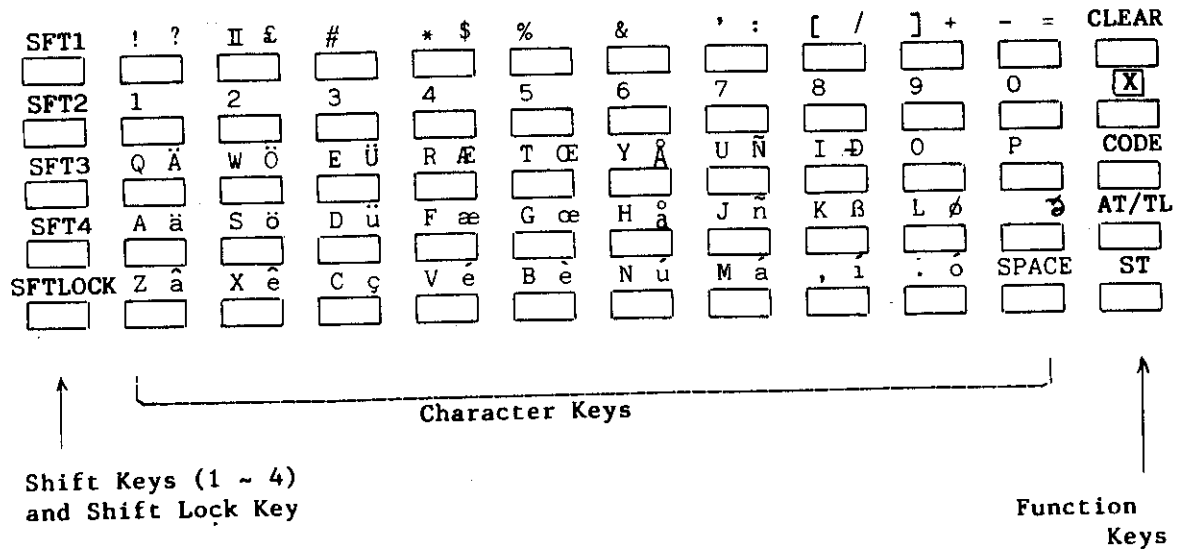

Shift Keys (1 ~ 4), Shift Lock Key

Used to designate the shift of the character keys. Each character has three different characters, each of which is designated by the Shift Key 1 to Shift Key 3. (Shift Key 4 is not used for the MA-1050-100 series.)

Shift Key 2 and Shift Key 3 are effective for one following character only. After that, the Shift 1 mode is automatically regained.

The Shift Lock Key is used to hold the shifted status for a series of characters. To change the shifted status locked by the Shift Lock Key, one of the Shift Keys (1 ~ 3) prior to the character key depression must be pressed.

Character Keys

Used to enter alpha/numeric data. In setting a descriptor of Department or PLU name, a clerk name, simply press the corresponding character key here instead of a character code and the # key combination on the ECR keyboard.

ex.) A ä

"A" is entered in the Shift 1 mode.

Operate: (SFT1) → A ä

"a" is entered in the Shift 2 mode.

Operate: (SFT2) → A ä

"ä" is entered in the Shift 3 mode.

Operate: (SFT3) → A ä

The numeric keys [1] through [0] may be used as characters keys for descriptor setting, and also used for numeric data input such as in designating the Department No. or PLU No. along with the use of the [CODE] key.

Each of the numeric keys is effective only in Shift 1 or Shift 2 mode.

Function Keys

Except the **CODE** key, each of the Function Keys corresponds to the identical key installed on the ECR keyboard as to the function in programming operations.

The **CODE** key is provided for the convenience of entering a Department Code, PLU Code, Line No. for STORE NAME/MESSAGE AND COMMERCIAL MESSAGE PROGRAMMING, Clerk ID Code in CLERK NAME PROGRAMMING, Item Code in FINANCIAL TOTAL NAME PROGRAMMING and PRINT ITEM NAME PROGRAMMING operations.

ex.) Operation on ECR Keyboard Operation on TKB-1-A

DEPT 1

1 **CODE**

25 **PLU** (as PLU Code)

25 **CODE**

1 **ST** (as Clerk ID)

1 **CODE**

↓
(in this case, the **ST** key depression on the TKB-1-A will result in an error.)

OPERATION EXAMPLE

To set the Department Name "COFFEE" for Dept. 1:

ON ECR KEYBOARD ONLY:

3 **X** **DP 1** 13 **#** 25 **#** 16 **#** 16 **#** 15 **#** 15 **#** **ST**
(C) (O) (F) (F) (E) (E) **AT/TL**

ON TKB-1-A KEYBOARD ONLY

3 **X** 1 **CODE** C O F F E E **ST** **AT/TL**

ON ECR KEYBOARD AND ON TKB-1-A KEYBOARD COMBINED:

3 **X** **DP 1** C O F F E E **ST** **AT/TL**

┌──────────┐ ┌──────────┐ ┌──────────┐
on ECR ON TKB-1-A on ECR

VERIFICATION OF PROGRAMMED DATA

DEPARTMENT PRESET PRICE READ (Mode Lock: X, enter 1, depress **[ST]**.)

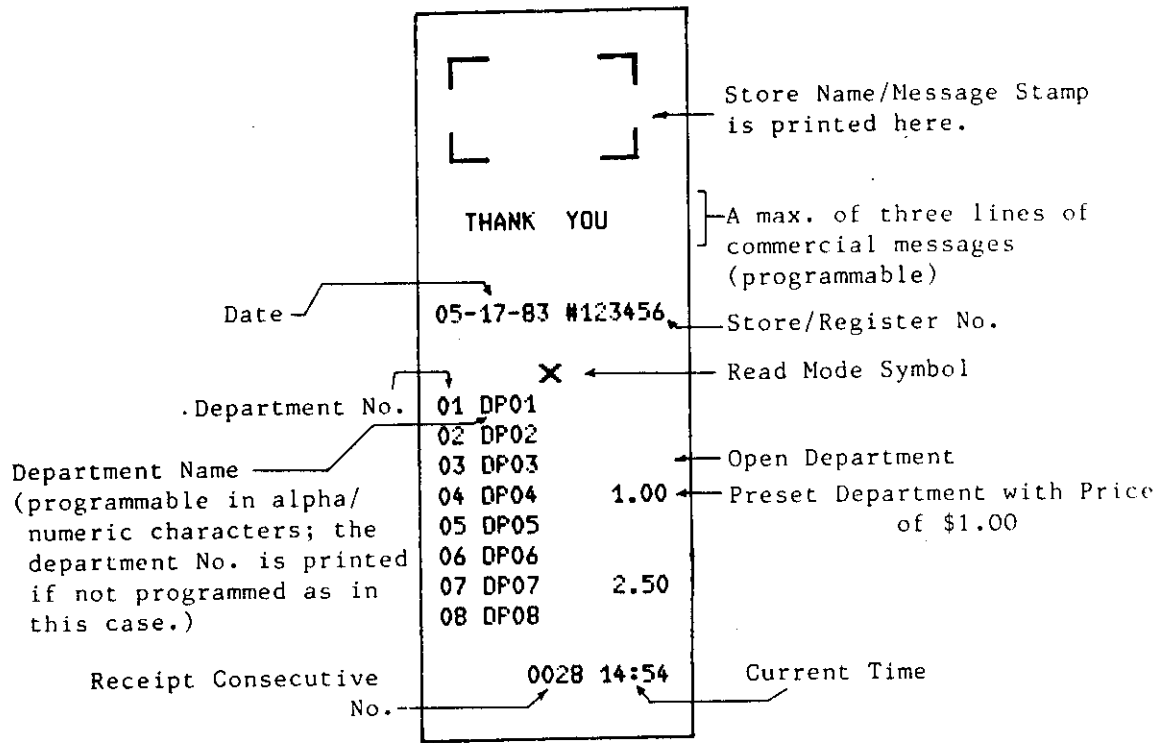

DEPARTMENT STATUS AND LISTING CAPACITY READ (Mode Lock: X, enter 2, depress **[ST]**)

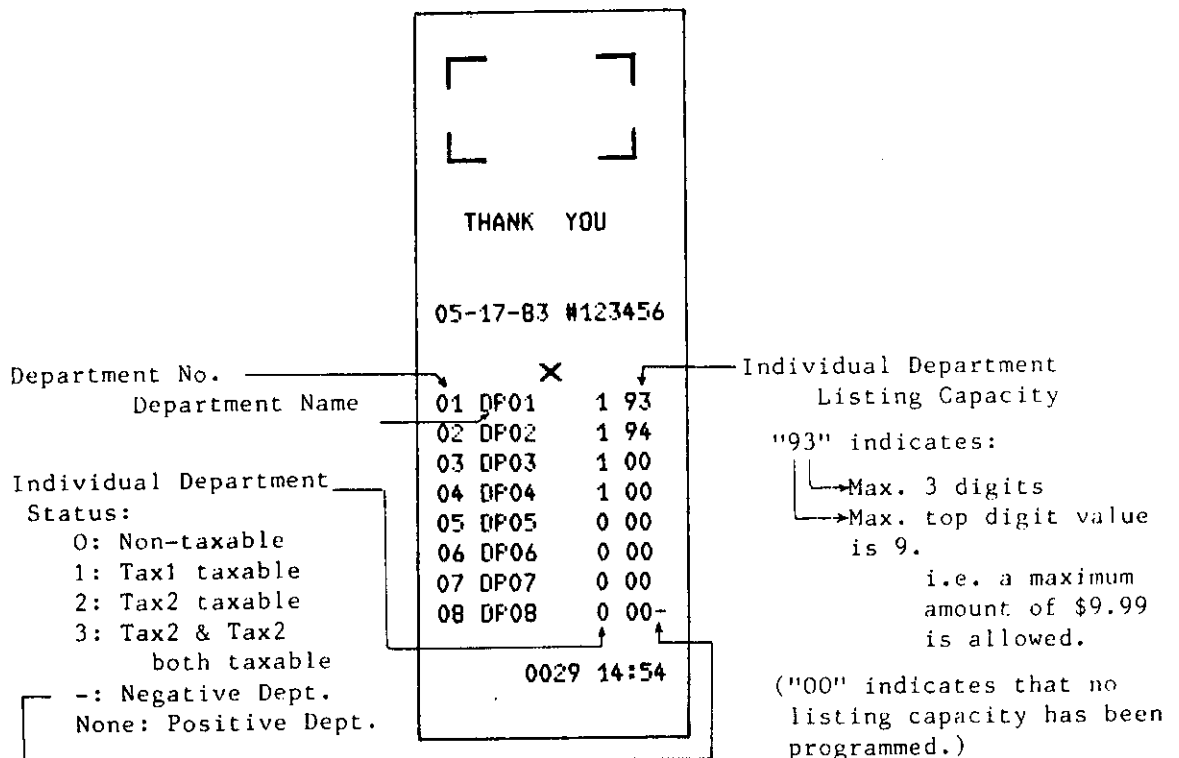

PLU NO., PRESET PRICE, AND STATUS READ (Mode Lock: X, enter 3, depress **[ST]**.)

⌈ ⌋
⌋ ⌈

THANK YOU

05-17-83 #123456

X

	PLU05 01	1.00	
PLU No. →			← Preset Price
	PLU05		
Linked Dept.No. →	PLU20 02	2.00	
	PLU20		← PLU Name (programmable in alpha/numeric characters; the PLU No. is printed if no name has been programmed as in this case.)
	PLU30 04	0.50	
	SUGAR		

0030 14:54

%+ AND %- PRESET RATE AND COMMON LISTING CAPACITY READ
(Mode Lock: X, enter 4, depress **[ST]**.)

⌈ ⌋
⌋ ⌈

THANK YOU

05-17-83 #123456

X

	%+ 10%	10%	
%+			← %+ Preset Rate
%-		20%	← %- Preset Rate
		97	← Common Listing Capacity (Refer to the Listing Capacity description on the previous page.)

0031 14:54

REMOTE SLIP PRINTER OPERATION

The TEC Remote Slip Printer DRS-103 may be connected to the MA-1050-100 series ECR as an optional device. The Remote Slip Printer will operate printing if a slip is properly inserted.

1. The remote slip printer will automatically activate printing when the slip is properly set to the printer table.
2. No selection is provided for remote slip print compulsory status.
3. The following are the optional selections available if the remote slip printer is connected:

1) Printing Position

Address #10 Bit 1:

RESET (standard): Prints every item on the right side of the slip.

SET (option): Prints items of Departments, PLUs, %+, %-, and Dollar Discount on the left side of the slip. Other items will be printed on the right side.

4. The gap of the slip inlet is usually opened, and the slip may be inserted or withdrawn freely.

When a slip is properly set to the remote slip printer and the ECR is operated, the gap will be closed and printing will be performed. When the sale is finalized, the receipt is issued and then the gap of the DRS-103 will be opened to allow the slip withdrawal. (The gap keeps closed during registration.)

5. Printing on the remote slip will be performed alternately with printing on the receipt/journal on the ECR.
6. The EJECT Key on the DRS-103 may be used to open the closed gap in order to withdraw the slip and skip unnecessary item print. The EJECT key will be disregarded if the slip is set and the ECR receipt/journal printer is in a printing action.

7. Printing Position and Slip Size

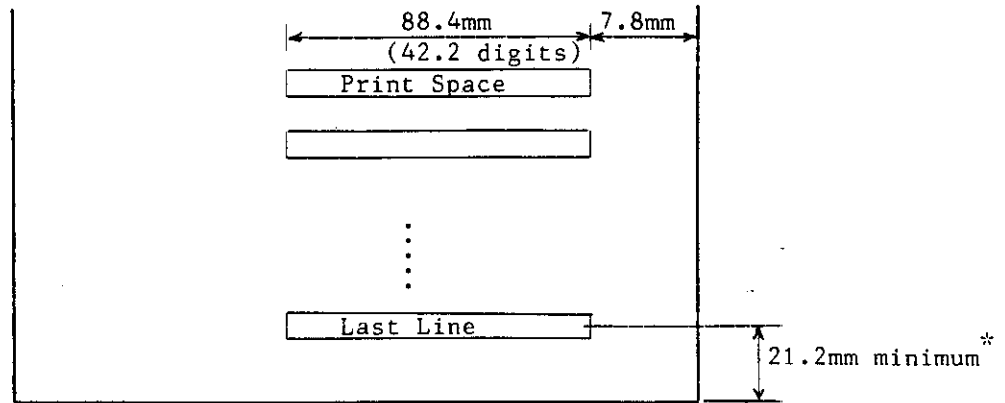

* NOTE: The space below the "Last Line" (i.e., the 21.2mm area at the bottom) cannot be printed.

REMOTE SLIP PRINT SAMPLE IN "REG" MODE

REMOTE SLIP

RECEIPT

```

┌       ┐
└       ┘
05-04-83 #1111
RTN
DP01      1.20-T
  15X     1.30@
DP02      19.50 T
X+         10%
           1.95
DISC       1.00-
SUBTL      19.25
#1234
TAX         0.03
CASH      19.28

ITEM      14
1CL      0015 13:32
    
```

Optional Print Position
(Department, PLU, %+, %-,
and Dollar Discount items
are printed on the left
side. Other items are
printed on the right side.)

System Option
Address #10
Bit No.1 to "SET"

Standard Print Position
(All items are printed
on right side.)

```

RTN
DP01      1.20-T
  15X     1.30@
DP02      19.50 T
X+         10%
           1.95
DISC       1.00-
    
```

```

RTN
DP01      1.20-T
  15X     1.30@
DP02      19.50 T
X+         10%
           1.95
DISC       1.00-
SUBTL      19.25
#1234
TAX         0.03
CASH      19.28

ITEM      14
1CL      0015 13:32
    
```

05-04-83 #1111

REPORT SAMPLE PRINTED ON REMOTE SLIP PRINTER

(Auto Read Report)

Item Name of Total/Counter	Item or Customer Count	Department Customer Count	Total Amount
↓	↓	↓	↓
GT			114.89
GS	72		114.89
DP01	-1	1CU	-1.18
DP02	61	5CU	80.50
DP03	3	2CU	11.00
DP04	4	2CU	10.70
DP05	0	0CU	0.00
DP06	0	0CU	0.00
DP07	0	0CU	0.00
DP08	0	0CU	0.00
Z+	4		7.80
TAX1			0.07
NS	67		108.89
Z-	0		0.00
DISC	4		4.00
TOTAL	7CU		99.89
CASH	6CU		92.39
CHECK	1CU		7.50
Chg	0CU		0.00
R/A	0		0.00
PO	0		0.00
CAID			91.89
CKID	2		8.00
CORR	1		1.20
MS VD	0		0.00
Z-	0		0.00
RTN	4		4.80
-TAX			0.00
REG-	0		0.00
TXBL1			43.22
1CL			
GS	72		114.89
NS	67		108.89
TOTAL	7CU		99.89
CAID			91.89
CKID			8.00
NEG1			6.00
NEG2			4.00
PO			0.00
05-04-83 #1111		1CL 0026	13:45

CUTTER BLOCK OPEN DETECTOR AND PAPER NEAR-END DETECTOR

1. CUTTER BLOCK OPEN DETECTOR

- (1) This detects when the Cutter Block of the Printer is opened. It is provided in order to protect your hands and fingers from injury and also to protect the printer itself.
- (2) While the Block is opened, none of the keys (including **RF** and **JF**) will be accepted and the AMOUNT portion of the display will keep flashing.
- (3) When the Block is closed and the **C** key is depressed, the display flashing will be cleared and key-in operations will be accepted. If the Block was opened during printing, the suspended printing will be started again.
- (4) If the Block is opened during printing, the printing will immediately be stopped.

2. JOURNAL AND RECEIPT PAPER NEAR-END DETECTOR

- (1) This detects when either the journal or receipt paper is coming near the end. It is provided in order to prompt the operator to replace the old paper roll with a new one.
- (2) When the paper roll comes near the end (or the paper has not been set properly), no key operation (except **RF** and **JF**) will be accepted and the AMOUNT portion of the display will keep flashing.
- (3) When a new paper roll is set, only the **RF** and **JF** keys are allowed to operate. Next, when the **C** key is depressed, the display flashing will be cleared and normal key-in operations will be accepted. If any printing was suspended, it will continue printing.
- (4) If this detector sensed a paper near-end condition during printing, printer will stop after the current line printing is completed.
- (5) The **RF** and **JF** keys are operative regardless of the detector ON/OFF condition.
- (6) If the **C** key is depressed in the paper-end condition, it will be ignored. The **C** key depression will be effective to clear the display flashing only after the new paper roll is set.

ECR PRINTER MOTOR LOCK AND REMOTE SLIP PRINTER MOTOR LOCK DETECTORS

1. PRINTER MOTOR LOCK DETECTOR

- (1) This detects the ECR printer motor lock condition caused by some trouble.
- (2) When such a condition is detected, the front display indicates "Error" and none of the keys (including **RF** and **JF**) will be accepted.
- (3) To regain the normal condition, turn the power of the ECR to OFF, remove the cause of the motor lock, and then turn the power to ON again.

2. REMOTE SLIP PRINTER MOTOR LOCK DETECTOR

- (1) This detects the remote slip printer motor lock condition caused by some trouble.
 - (2) When such a condition is detected, the front display indicates "Error" and none of the keys (including **RF** and **JF**) will be accepted.
 - (3) To regain the normal condition, turn the powers of the ECR and the remote slip printer to OFF, remove the cause of the motor lock, and then turn the powers to ON again.
- * If the cause can not be found in the remote slip printer and only the ECR may be required to work without the remote slip printer temporarily, remove the remote slip printer cable from the ECR, and turn the power of the ECR to ON.

PAPER ROLL REPLACEMENT AND OTHER MAINTENANCE OPERATIONS

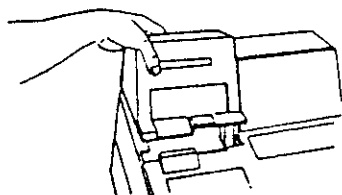

Fig. 1

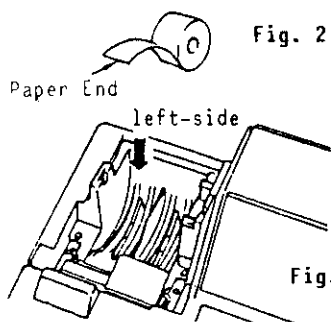

Fig. 2

Fig. 3

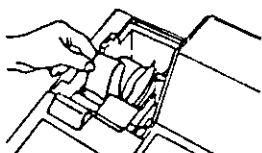

Fig. 4

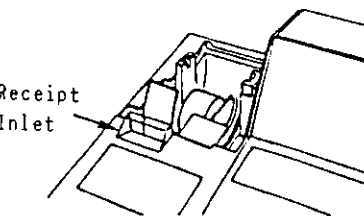

Fig. 5

INSTALLING THE RECEIPT PAPER

1. Turn the Mode Lock to the "REG" position.
2. Remove the Receipt Cover by pulling it upward (Fig. 1).
3. Set the new paper roll in the receipt roll holder with the paper end fed from the bottom as shown in Fig. 2 (Fig. 3).
4. Insert the paper end into receipt inlet as holding the **RF** key pushed down (Fig. 4).
5. When the paper comes out of the receipt outlet for approx. 5cm (or 2 inches), release the **RF** key (Fig. 5).
6. Attach the Receipt Cover. Meanwhile, the paper end must be seen outside the cover.
7. Press the **C** key to clear the paper-end condition, and depress the **NS** key and cut the issued receipt to check if the paper has properly set.

REMOVING THE RECEIPT PAPER

1. Remove the Receipt Cover by pulling it upward (Fig. 1).
2. Pull the Free Lever frontward while pulling the old paper core upward to remove the remaining receipt paper tail (Fig. 6).

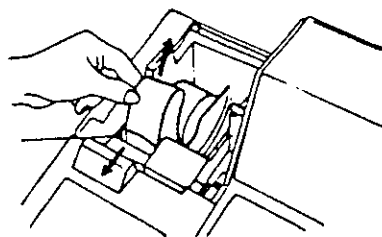

Fig. 6

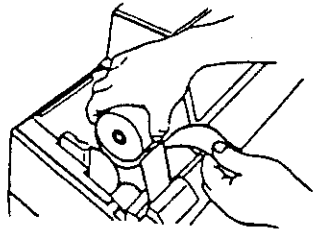

Fig. 7

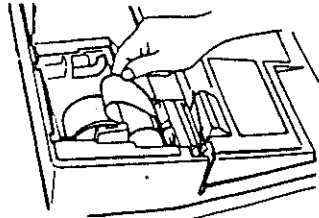

Fig. 8

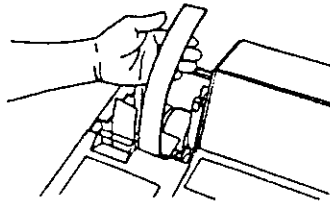

Fig. 9

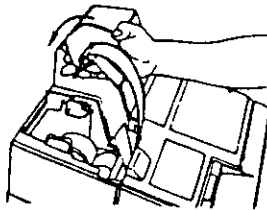

Fig. 10

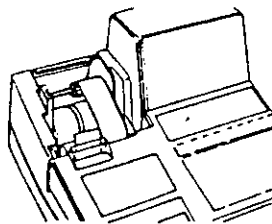

Fig. 11

INSTALLING THE JOURNAL PAPER

1. Turn the Mode Lock to the "REG" position.
2. Remove the Receipt Cover by pulling it upward (Fig. 1 on the previous page).
3. Remove the Journal Winding Reel.
4. Set the new paper roll in the journal roll holder (righthand side) with the paper end from the bottom (Fig. 7).
5. Insert the paper end into the journal inlet while holding the **JF** key pushed down (Fig. 8).
6. When the paper comes out of the journal outlet for approx 20cm (or 8 inches), release the **JF** key (Fig. 9).
7. Wind up the paper end on the Journal Winding Reel two or three times as shown in Fig. 10.
8. Set the Journal Winding Reel to the holder (Fig. 11).
9. Attach the Receipt Cover (Fig. 12).
10. Depress **C** key before starting operations.

REMOVING THE JOURNAL PAPER

1. Remove the Receipt Cover by pulling it upward (Fig. 1 on the previous page).
2. Depress **JF** key to wind up enough portion of the journal paper, and then tear off the paper, holding the Journal Winding Shaft.
3. The wound-up portion of the paper can easily be removed from the Winding Shaft by pulling it side way (Fig. 13).
4. If enough paper remains on the roll, follow Steps 6 through 10; if paper is running out, follow Steps 1 through 10 in "INSTALLING THE JOURNAL PAPER" above.

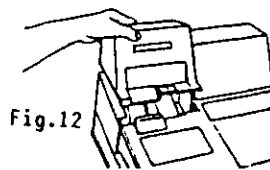

Fig.12



Fig. 13

REPLACING THE INK RIBBON

When the receipt and journal print is too light, replace the ink ribbon in the following manner.

Removing the Ribbon

1. Turn the Power Switch to OFF.
2. Remove the Ribbon Cover. Press the side inward and the hook will unlocked (Fig.14).
3. Open the Cutter Block by pulling it upward while pressing the leftside lever outward. (Fig. 15 and Fig. 16)
4. Remove the Ink Ribbon by lifting up the ribbon spools (Fig. 17).

Installing the Ribbon

1. Set the ribbon spools so that the ribbon will be wound to the directions shown by the arrows respectively. Meanwhile, let the ribbon go through the Ribbon Guides, the Tension, and the Dot Head Ribbon Guide (Fig.18 and Fig.19).
2. After setting, make sure that the ribbon properly goes through each required parts by turning a ribbon spool several turns.
3. Close the Cutter Block. Make sure that the leftside lever has locked the block.
4. Turn the Power Switch to ON.
5. Depress **C** key. The flashing display will stop and be lit steadily.
6. Attach the Ribbon Cover.

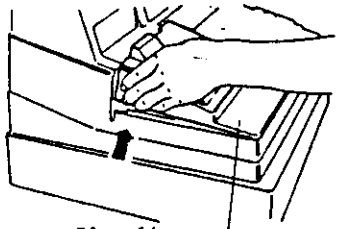

Fig. 14
Ribbon Cover

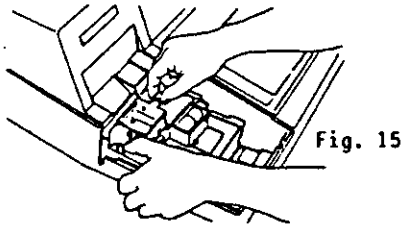

Fig. 15

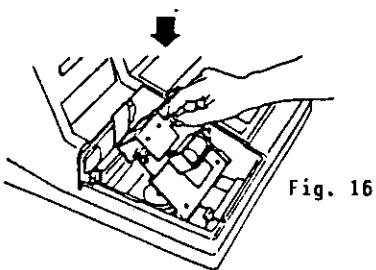

Fig. 16

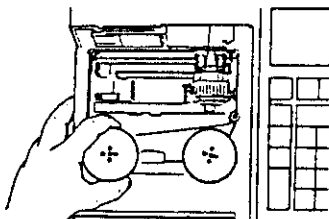

Fig. 17

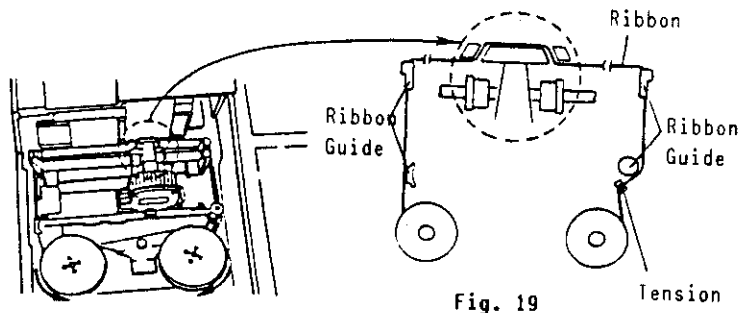

Fig. 19

Fig. 18

REPLENISHING THE STORE NAME STAMP WITH INK

When the store name stamp is printed too lightly, replenish the ink in the following manner.

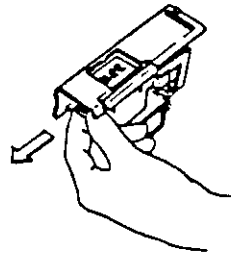

Fig. 20

1. Turn the Power Switch to OFF.
2. Remove the Ribbon Cover (Fig. 14).
3. Open the Cutter Block (Fig.15 and Fig.16).
4. Draw out the store name stamp in the direction shown in Fig.20 with the protruding part pinched with your fingers (Fig. 20).
5. Apply ink on the pad on the rear side of the Store Name Stamp. The amount of the refiling should be adjusted according to the density of the printed message, but the limit of 2 c.c. should not be exceeded. (The ink bottle supplied contains 5 c.c. of ink.) (Fig. 21)

NOTES: 1) Replenish the ink drop by drop several times until the pad will not absorb any more.

2) Use the TEC genuine ink for replenishment.

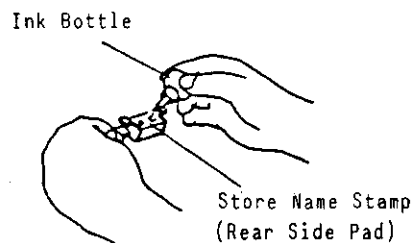

Fig. 21

6. Re-assembly is the reverse procedure. (Fig. 22) Let Point "B" of the Stamp fit to Point "A" of the Stamp Holder, push the stamp all the way in until a "click" is heard.
7. Close the Cutter Block.
8. Turn the Power Switch to ON.
9. Depress the **C** key. The flashing display will stop and be lit steadily.
10. Depress the **NS** key to issue a receipt. Repeat this to check if the printout will turn out all right.
11. Attach the Ribbon Cover.

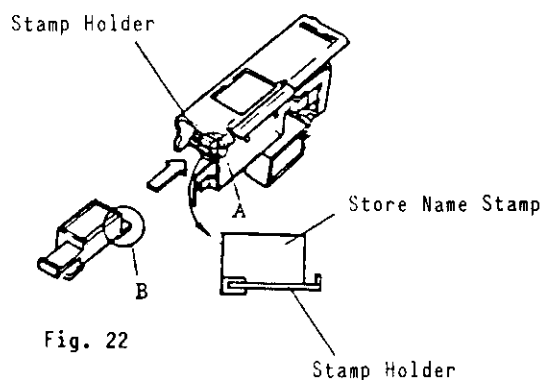

Fig. 22

OPENING THE DRAWER

The drawer opens automatically when a registration is finalized. In the event of a power failure or a trouble, open the drawer in the following manner.

Insert the Drawer Release Key into the Drawer Release Lock and turn the key by 45 degrees clockwise. (Fig. 25)

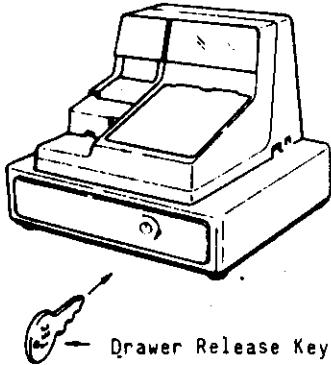

Fig. 25

REMOVING THE DRAWER

1. Lift the drawer up and pull it out.
2. Then let it go down and pull it out again, and it will be removed.
3. When getting back the drawer, fit its rollers on the rails of the register and push it all the way in.

(Fig. 26)

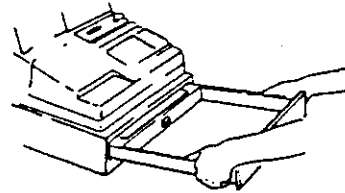

Fig. 26

POWER FAILURE PROCESS

If power failure occurs, all sales totals stored in the memories are automatically protected by the battery installed in the ECR. The battery is rechargeable and it is recharged when AC power returns. As the power returns, the register revives to continue the work. However, please note the following phenomena to occur on the register when the power is regained:

1. The printer will work to print the entered data without failure after the power recovery, if any data was being printed. However, one extra line may be fed on the power recovery depending on the power recovery timing.
2. The display will indicate, on the power recovery, the content that was displayed before the power failure. However, if only any numeric keys or non-motorized keys (such as **RTN**, **X**, **LC OPEN**, **TX/M**, **PR OPEN**) was depressed without any motorized key (such as **DEPT** keys) depressed thereafter at the starting of a sale registration, and then the power failed; the entered numeric value or non-motorized key will have disappeared by the time of power recovery and the display will indicate "0.00". Therefore, after the power recovery, do the registering operation again from the very first key-in operation.

SPECIFICATIONS

Size	460mm(width) x 400mm(depth) x 375mm(height) ---With SP Drawer
Weight	19.0 Kg (With SP Drawer)
Power Required	AC 117V 60Hz
Power Consumed	11W when non-operating 35W (0.4A) when operating
Size of Receipt and Journal Tape	38mm(width) x 70mm(diameter)
Ambient Temperature	0°C ~ 40°C, 10% ~ 90% Relative Humidity

PRINTED IN JAPAN
E1-01234A 83094000 ©

Free Manuals Download Website

<http://myh66.com>

<http://usermanuals.us>

<http://www.somanuals.com>

<http://www.4manuals.cc>

<http://www.manual-lib.com>

<http://www.404manual.com>

<http://www.luxmanual.com>

<http://aubethermostatmanual.com>

Golf course search by state

<http://golfingnear.com>

Email search by domain

<http://emailbydomain.com>

Auto manuals search

<http://auto.somanuals.com>

TV manuals search

<http://tv.somanuals.com>