

Owners Manual

TEC ELECTRONIC CASH REGISTER

MA-1060-100 SERIES

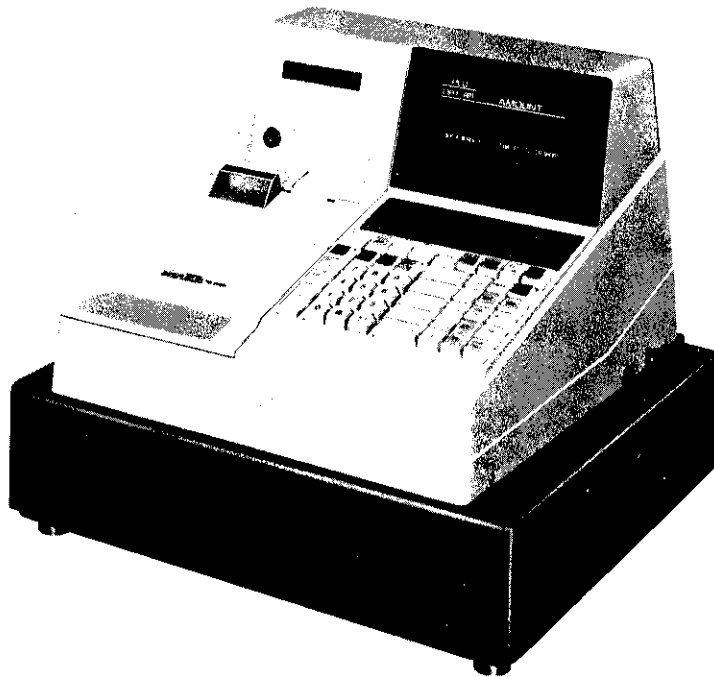

TEC TOKYO ELECTRIC CO.,LTD.

WARNING

This equipment generates, uses, and can radiate radio frequency energy and if not installed and used in accordance with the instructions manual, may cause interference to radio communications. It has been tested and found to comply with the limits for a Class A computing device pursuant to Subpart J of Part 15 of FCC Rules, which are designed to provide reasonable protection against such interference when operated in a commercial environment. Operation of this equipment in a residential area is likely to cause interference in which cause the user at his own expense will required to take whatever measures may be required to correct the interference.

TABLE OF CONTENTS

	<i>page</i>
TO OUR CUSTOMERS	1
PRECAUTIONS	1
APPEARANCE AND NOMENCLATURE	1
CONTROL LOCKS AND MODE SELECTOR KEYS	2
DISPLAY	4
KEYBOARD LAYOUT	5
FUNCTION OF EACH KEY	6
OTHER OPTIONAL KEYS	18
REGISTERING PROCEDURE FOR SALES	22
READ(X) AND RESET(Z) REPORTS	41
PROGRAMMING OPERATIONS IN "SET" MODE	54
PROGRAMMING OPERATIONS IN "MGR" MODE	95
CHARACTER CODE TABLE	96
PROGRAMMING OPERATIONS THROUGH THE PROGRAMMING KEYBOARD (optional)..	97
VERIFICATION OF PROGRAMMED DATA	100
REMOTE SLIP PRINTER OPERATION (optional)	103
CUTTER BLOCK OPEN DETECTOR AND PAPER NEAR-END DETECTOR	106
ECR PRINTER MOTOR LOCK AND REMOTE SLIP PRINTER MOTOR LOCK DETECTORS	107
PAPER ROLL REPLACEMENT AND OTHER MAINTENANCE OPERATIONS	108
WHEN A POWER FAILURE OCCURS	113
SPECIFICATIONS	114

TO OUR CUSTOMERS

Thank you for choosing a TEC electronic cash register MA-1060-100 series. This instruction manual provides a description of the functions and handling of this register and should be read carefully to obtain maximum performance. Since every consideration has been given to safety, there is no danger of damaging the machine by incorrect operation.

Please refer to this manual whenever you have any doubts concerning the machine. This machine has been manufactured under strict quality control and should give you full satisfaction. However, if the machine is damaged during transit, or there are any unclear points in this manual, please contact your local TEC representative.

- The specifications described in this manual may be modified by TEC, if necessary.
- Be sure to keep this manual for future reference.

PRECAUTIONS

1. The keys on the keyboard work with a light touch. Avoid pressing the keys too hard.
2. Avoid handling the machine with wet hands.
3. Do not apply thinner or other volatile oils to the cabinet or other plastic parts. If dirty, wipe off with a piece of cloth soaked in neutral detergent and squeezed tightly.

APPEARANCE AND NOMENCLATURE

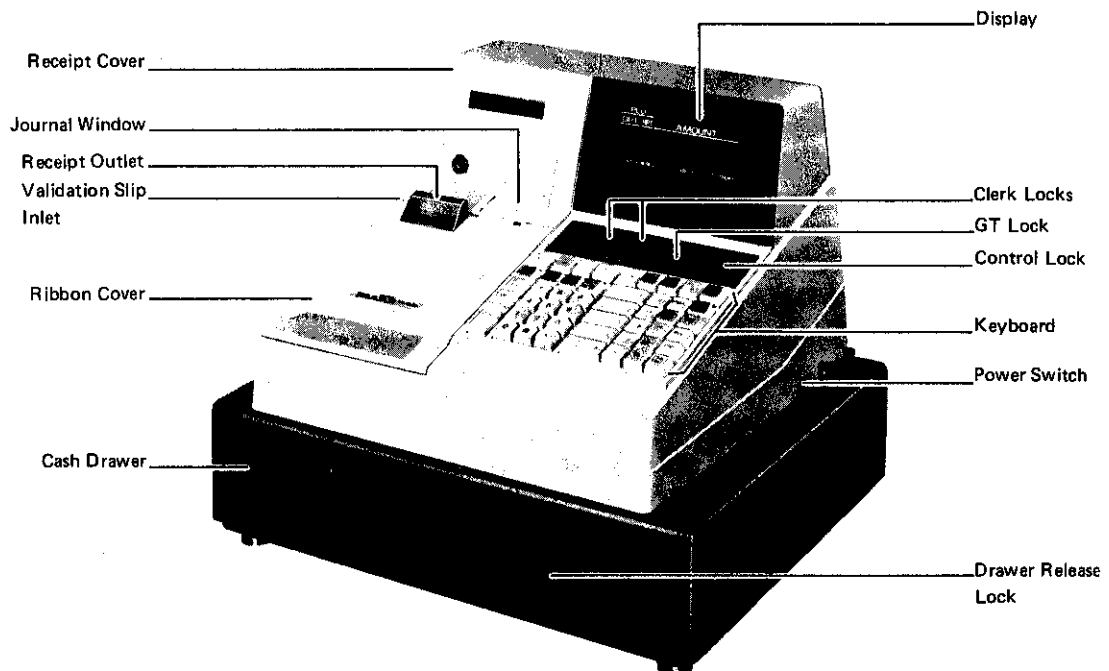

- **Power Switch** ... The power switch is provided at the righthand side of the cabinet. The AC power is turned on when the switch is pushed to ON, and turned off when the switch is pushed to OFF.

CONTROL LOCKS AND MODE SELECTOR KEYS

MODE LOCK

(POSITION)

(FUNCTION)

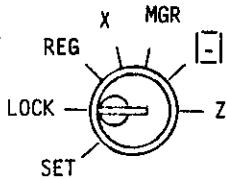

LOCK The register operations are locked when the Mode Lock is set to this position. Displays the current time in the front display as a standard feature.

REG Normal cash register operations are carried out in this mode. However, the operations using the keys that have been programmed to require the "MGR" position cannot be done in this mode.

X The sale totals can be read and the programmed data can be verified in this position.

MGR This position allows to register all normal cash register operations to be carried out in the REG mode and the operations using the keys that have been programmed to require the MGR position.

 This is the "Negative Mode", which automatically processes all the entries in the reverse way, i.e., positive items into negative, and the negative into positive.

Z All the resettable totals and their respective counters will be read and reset in this position.

SET In this position, the register will allow programming operations.

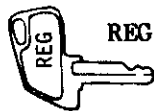

REG Key

The REG Key is used by the cashier who operates the register. This key can access the positions of LOCK and REG.

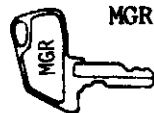

MGR Key

The MGR Key is used by the store manager or a person authorized by the manager. This key can access the positions of LOCK, REG, X, and MGR.

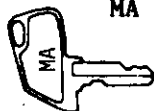

MA Key

The MA Key is used by the store manager who will daily supervise the collection of money and the printout of transactions recorded by the register. This key can access the positions of LOCK, REG, X, MGR, , and Z.

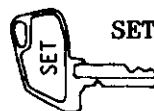

SET Key

The SET Key is used by the programmer. This key can access the positions of LOCK and SET.

CLERK LOCKS

These locks are used to identify which clerk is operating the register.

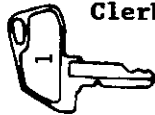
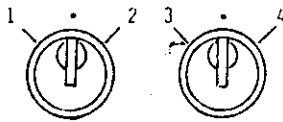

Clerk Keys (1 , 2 , 3 , 4)

Each clerk should keep his/her clerk key. The register will not operate unless one of these keys is inserted and set to the corresponding position on the Clerk Locks. Each of the keys may be inserted and pulled out in the neutral position marked with the "." (point).

GT LOCK

This lock is provided to read or reset the accumulated sales totals not on the daily but on weekly or monthly basis.

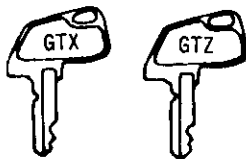
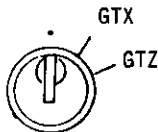

GTX Position:

This position allows to read the accumulated totals.

The GTX key as well as GTZ Key can access this position.

GTZ Position:

This position allows to read and reset the accumulated totals.

The GTZ Key only can access this position.

NOTE: When the GT Lock is turned to either the GTX or GTZ position, the Mode Lock position or any Clerk Key ON/OFF condition will be disregarded.

DISPLAY

The front display is located at the top of the register just above the keyboard. The display has two types of display -- numeric display and message descriptors.

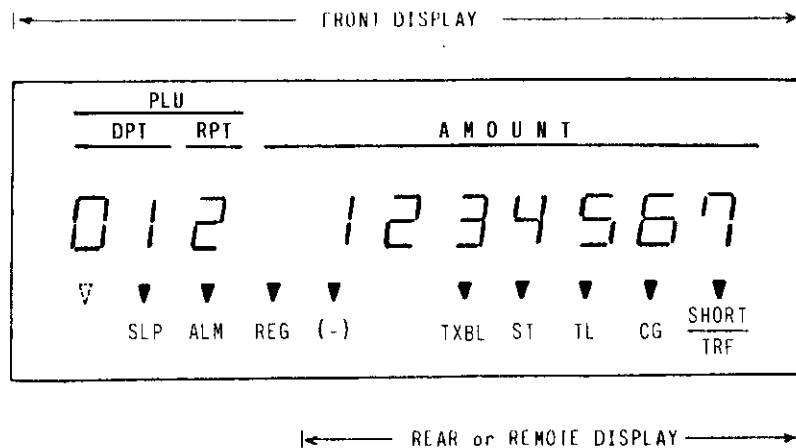

Numeric Display

- AMOUNT (7 digits) Displays the numeric data, such as amount, quantity, etc.
- DPT (2 digits) Displays the code which represents each Department Key. It stays lit when repeating the same department entry.
- RPT (1 digit) Displays the repeat department entry count. The count is indicated from the second entry on, and only the first digit will be displayed even if the count exceeds nine.
- PLU (3 digits, commonly used with the DPT and RPT digits) Displays the PLU code when any PLU is entered. It goes out when repeating the same PLU entry.

Message Descriptors

- SLP Lights up when a slip has been properly inserted and set to allow validation. It flashes to require a slip insertion when validation compulsion has been programmed on the transaction key just operated.
- ALM Lights up with the alarm buzzer to indicate that the last operation or numeric entry has resulted in an error. To clear the error condition, depress the key.
- REG Lights up when sale items have been registered.
- (-) Lights up when the RTN MDSE, DOLL DISC, or any other key that registers a negative amount has been operated. It also lights up when the ST or one of the total keys has been depressed and the displayed amount is negative. It lights up also when an amount is entered in the "

- TXBL** Lights up when a taxable department or PLU is entered. It also lights up with the "ST" Lamp when the **TXBL TL** key is depressed.
- ST** Lights up when the sub-total amount is displayed after the **ST** key has been depressed.
- TL** Lights up on a finalizing operation with the total amount displayed when finalized without any amount tendered.
- CG** When an amount tendering operation has been performed, this lamp lights up with the change due displayed.
- SHORT** Lights up when the amount tendered is less than the sale total
TRF with the shortage amount displayed.
Lights up also when all the sale balance are transferred to the new sale balance for post charging.

NOTE: The leftmost trimark lamp (which is not indicated in the figure on Page 4) flickers when the ECR is connected to an Register-to-Register System loop and the in-line function is activated. (As for the in-line functions and operations, refer to the MA-1060-100 REGISTER-TO-REGISTER OPERATION MANUAL which is separately issued.)

KEYBOARD LAYOUT

The following is a typical keyboard layout for the MA-1060-100 series. Since this series is designed to be capable of programming most of the keys to be placed in the desired place on the keyboard, this is merely an example. Please ask your TEC representative if any other alternative or additional keys must be installed, referring to the description of the "FUNCTION OF EACH KEY" and "OTHER OPTIONAL KEYS" in this manual.

#/NS	VALI DATE	RF	JF	LC OPEN	%-	DOLL DISC	R/A	PO
RTN MDSE	C	IC/VD	TX/M		1	6	PB+	PB-
@/FOR	7	8	9		2	7	ST	TRF
AMT	4	5	6		3	8	TXBL TL	MISC
PLU	1	2	3		4	9	AT/TL	Chg
	0	00	.		5	10		CHK TND

FUNCTION OF EACH KEY

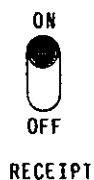

RECEIPT ON/OFF SWITCH

This switch has two positions available -- 'OFF' position and 'ON' position. When in the 'OFF' position, no receipt is issued from the register and sales are printed on the audit roll only. When the switch is turned to the 'ON' position, sales are printed on both the receipt roll and audit roll, then a receipt is issued which is automatically cut off and given to the customer.

RF RECEIPT FEED KEY

This key is used to advance the receipt roll. It is operated by depressing the key and holding it in that position until the paper has advanced to the required position. This key is effective even when the RECEIPT ON/OFF SWITCH is in the 'OFF' position. It can be programmed to prohibit receipt feeding during a sale.

JF JOURNAL FEED KEY

This key is used to advance the audit roll in the same fashion as the RF key. These two keys are useful if the cashier, due perhaps to an interruption whilst ringing up a sale, is unsure which items have already been entered. By using the feed key the cashier can see which figures have actually been printed.

The RF and JF keys can not be operated simultaneously.



VALIDATION KEY

This key is used to over-print a validation slip.

To operate, after registering an item or finalizing a sale, insert a slip into the validation slot and depress the **VALIDATE** key. The item and the amount will be printed on one line on the slip. Print or non-print of the date and/or consecutive No. is a programmable option.

Programmable selections are also provided as to single or multi validation, validation compulsion on certain transaction keys, etc.

If the SLP Lamp flashes, it means that validation compulsion is programmed for the last item entered. In this case, insert a slip into the validation slot and depress the **VALIDATE** key; no other operation is allowed until the compulsory validation has been executed.

When a Media Key is programmed with Validation Compulsory status, the drawer will open after executing a validation print of the media. The **AT/TL** key is also subject to this rule if programmed with Validation Compulsory status.

**RTN
MDSE**

RETURNED MERCHANDISE KEY

This key is the Returned Merchandise Key which is used for refunding money to a customer who has returned goods to the store.

To operate, depress the **RTN MDSE** key either before or after ringing up the amount to be refunded, and then depress the appropriate department key (the department key may be replaced by a PLU code and the **PLU** key combination). The amount is automatically printed and deducted from the bill.

The **RTN MDSE** key can be used outside as well as inside a sale.

#/NS

NON-ADD NUMBER PRINT / NO-SALE KEY

This is a dual-function key that has both **#** and **NS** key functions.

If depressed with a prior number entry, it will function as the Non-add Number Print key. (See "**#** KEY" on page 19.)

If depressed without a prior numeric entry, it will function as No-sale key. (See "**NS** KEY" on page 19.)

It also function as the Cash-in-drawer Read key if depressed in the "X" mode. It functions the same as the **#** key in programming operations.

**LC
OPEN**

LISTING CAPACITY OPEN KEY

This key is used to release the listing capacity on each Department or finalizing (media) key. To operate, depress the **LC OPEN** key before depressing the department or finalizing key (either before or after the numeric entry).

By depressing the **LC OPEN** key, the HALC (High Amount Listing Capacity) will be released to allow a numeric entry with two further digits, and the LALC (Low Amount Listing Capacity) will be one digit less than the programmed value, as to the department keys. As for the finalizing keys, the HALC will be extended to allow one further digit.

In order to allow a numeric entry outside the values defined above, the Mode Lock must be turned to the 'MGR' position using the MA or MGR Key.

Repeat operation will be possible on any department key even when the **LC OPEN** key is depressed before the department key.

AMT

AMOUNT KEY

This key is used to enter an amount or price for an open PLU. Refer to the description for the "**PLU**" key on page 9.

PR
OPEN

PRESET OPEN KEY

This key is used to modify the status of preset department keys. When the **PR OPEN** key is depressed prior to depressing a preset department key (either before or after the numeric entry), the preset department key is reversed to an open department key and allows amount entry through the numeric keyboard.

If a preset department is entered with a price through the numeric keyboard using the **PR OPEN** key, no repeat operation is then possible using that department key; however, the **RPT** (Repeat) key makes it possible if installed on the keyboard.

The **PR OPEN** key cannot be used with the **PLU** key.

@/FOR

QUANTITY EXTENSION / SPLIT-PRICING KEY

This key is used to multiply a department or PLU item entry by a quantity. This key is also used for split pricing of a department or PLU.

The basic order of multiplication is:

|QUANTITY| → **@/FOR** → |PRICE|

As for details of multiplication and split pricing for various cases, refer to the "REGISTERING PROCEDURE FOR SALES".

The quantity can be of maximum of 3 integral digits and 3 decimal digits. The price can be of maximum 6 digits. The product must not exceed 7 digits.

Usually, the fraction below the least effective digit will be rounded off. However, it may be programmed to be discarded or rounded up by the system option.

PB+, **PB-**

PREVIOUS BALANCE KEYS

These keys are used to enter a previous balance in a charge posting operation. If a previous balance is entered, then the operation becomes a charge posting operation, and the **Chg** (Media 2 Key) must be used at the end of the operation. (See the "REGISTERING PROCEDURE FOR SALES" as to detail operations to follow the **Chg** key in charge posting.)

A previous balance may be entered anywhere and any number of times during a sale. The **PB+** key is used to post a debit balance and the **PB-** key is used to post a credit balance. To initiate a charge posting operation where no previous balance exists, then enter "0" (zero) as a past balance, followed by **PB+** or **PB-** key.

If the **TXBL TL** key is depressed during a charge posting, the displayed amount does not include the previous balance. However when the **Chg** key is depressed to end the charge posting, the displayed and printed amount includes the previous balance.

If the **%+** key is used immediately after a previous balance entered through the **PB+** key, the percent rate is added to the previous balance. But the **%-** key cannot be used in this case. Neither may the **%+** or **%-** key be used immediately after a previous balance entered through the **PB-** key.

PLU PLU (Price-Look-Up) KEY

This key is used to enter a PLU that is linked to a department. Each PLU can be programmed to be preset PLU (to allow the preset price entry only) or an open PLU (to allow a price entry through the numeric keys each time).

TO ENTER THROUGH PRESET PLU:

PLU Code → **PLU** The preset price will automatically be read and entered.
1~3 digits
to repeat the same PLU price, depress the **PLU** only, after the above operation.

TO ENTER THROUGH OPEN PLU:

PLU Code → **PLU** → **PRICE** → **AMT**
1~3 digits
..... The price indexed on the numeric keys will be entered.
To repeat the same PLU price, depress the **AMT** key only, after the above operation.

As for quantity extension and split pricing involving PLUs, refer to the "REGISTERING PROCEDURE FOR SALES".

Each PLU is programmed with a 3-digit PLU Code, a 2-digit linked Department Code, and if used as a preset PLU, a maximum of 6-digit preset price.

IC/VD ITEM CORRECT / VOID KEY

This is a dual-function key that has both **ITEM CORR** (Item Correct) and **VOID** (Designated Line Void) key functions. (These two keys can separately be installed as optional keys in place of the **IC/VD** key.)

ITEM CORRECT FUNCTION:

If depressed (without a prior numeric entry) after an item-correctable entry, it functions as Item Correct key, removing the last item from the bill and printing a etched lined through that item on the receipt and journal.

The item-correct function is effective even when a numeric entry and a **C** key depression are done between the department entry to be corrected and the **IC/VD** key depression.

The **IC/VD** key will function to correct any last item entered through a department, **PLU**, **%+**, **%-**, **BTL RTN** (Inside Sale Type), **R/A** (except for Loand), **PO** (except for Charge Posting and Pick Up), **DOLL DISC**, **PB+**, **PB-**, or **TAX** (Manual Tax) key.

DESIGNATED LINE VOID FUNCTION:

If depressed with a prior numeric value (PLU code, price, amount, or quantity), it functions as Designated Line Void key. In this case, it is recommended to always enter a numeric value before depression of this key; otherwise, it will result in a item-correct operation if the last line item is item-correctable.

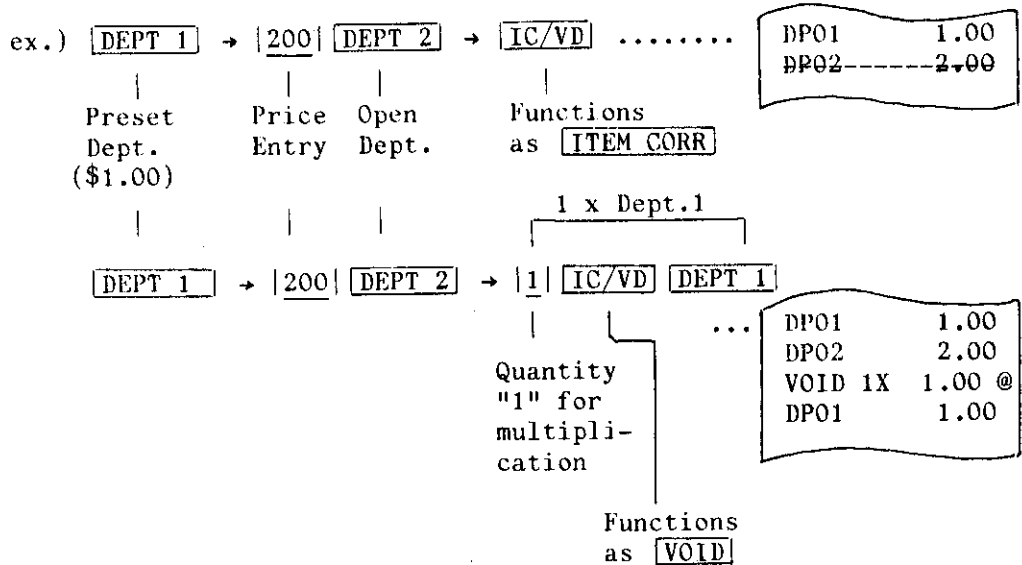

The **IC/VD** key will function to void any previous item through a positive department, **PLU** (positive PLUs only), combination of "positive department plus **%+** or **%-**" or "positive PLU plus **%+** or **%-**".

Unless the "Credit Balance" option has been selected, voiding to result the sale total into negative will go into an error.

DOLL DISC

DOLLAR DISCOUNT KEY

This key is used to subtract an amount from the sale total such as a discount during a sale. An amount exceeding the sale total cannot normally be entered. However, when the "Credit Balance" option has been selected, over-subtraction of the sale total using this key is allowed.

To operate, enter the discount amount on the numeric keyboard, and then depress the **DOLL DISC** key.

%+ PERCENT CHARGE KEY

This key is used to add a percentage rate to a sale. If the pre-programmed percentage rate is to be added, depress the **%+** key without a prior numeric entry. If a rate different from the pre-programmed % rate is to be added, enter the desired rate on the numeric keyboard and then depress the **%+** key. (The manual rate will take priority.)

To operate, depress the **%+** key either immediately after a department entry if only that item requires the percentage addition, or after the **ST** key if required on the total bill. The percentage rate and the amount are printed and will be added to the sale total.

The percentage rate may be within the range from 0.001 to 99.999%. The fraction resulted from the percentage calculation is usually programmed to rounded off. However, it can be programmed to be rounded up or discarded.

Usually, if the **%+** key is depressed after a second **ST** key depression within a sale, it adds the rate to the entire sale total. However, it can be programmed to add the rate to the subtotal of the items entered between the first and the second **ST** key depressions.

%- PERCENT DISCOUNT KEY

This key operates in the same fashion as the **%+** key except that operation will subtract from instead of adding to a sale.

C CLEAR KEY

This key is used to correct a numeric entry error prior to depressing any other key, or to correct any error condition and cancel the alarm buzzer.

If the **C** key is depressed after a sub-total is obtained, the sub-total is again displayed.

TX/M (for Single-tax Area)

TX1/M, **TX2/M** (for Dual-tax Area) TAX MODIFIER KEYS

Each of these keys is used to reverse the taxable/non-taxable status on departments other tax-programmable keys for one entry only. For dual-tax areas, two keys should be provided -- **TX1/M** and **TX2/M** -- in place of the **TX/M** key for the single-tax areas. The two tax modifier keys will function independently each with its own tax table pre-programmed for taxable items.

The tax modifier key(s) will be effective to reverse the tax status programmed on Department keys, **DOLL DISC**, **%+**, **%-**, **BTL RTN**, and PLUs.

To operate, depress the **TX/M** key prior to depressing any of these function keys above listed, i.e., either before or after the amount entry.

0 ~ 9, 00 NUMERIC KEYS

These keys are used to enter numeric values such as amount, quantity, or code number.

Depressing the **00** key once is the same as depressing the **0** key twice consecutively.

. DECIMAL POINT KEY

This key is used, as part of numeric keys, to designate the position of the decimal point when entering a percent rate or a quantity. For example, to enter 0.5%, index 0→**.**→5, or **.**→5. A maximum of three digits may be entered below the decimal point.

When entering a price or amount such as £0.25, just index 2→5. In this case, depression of the **.** key is not necessary and will cause an error.

1 ~ 10 DEPARTMENT KEYS

These are department keys through which sales items are registered. These key may be programmed as either 'PRESET' keys or 'OPEN' keys.

OPEN DEPARTMENT KEY:

A department key which has no preset price programmed is an 'OPEN' key and must have a price entered into it manually each time. The price is rung up on the numeric keyboard and the appropriate department key is depressed. The price is then displayed and printed on the receipt and audit rolls.

When the same department key is depressed more than once after a price entry, the price entry is repeated as many times as the department key is depressed.

To enter a price extended by multiplication, enter the quantity first, depress the **@/FOR** key, enter the price, and then depress the appropriate department key. A multiplication entry may not be repeated by depressing the department key again.

For split pricing, enter the purchased quantity, depress **@/FOR**, enter the whole package quantity next, depress **@/FOR** again, enter the whole package price, and then depress the department key.

PRESET DEPARTMENT KEY:

A preset key is a key which has already a price programmed in it. It is therefore unnecessary to enter the price of an item; simply depress the key to register the sale of one item.

To repeat the same preset item, depress the department key as many times as required.

To multiply a preset department price by a quantity, enter the quantity first, depress the **@/FOR** key (the **@/FOR** key may be omitted if the preceding quantity is a one-digit value), and then depress the preset department key.

For split pricing, enter the purchased quantity first, depress the **@/FOR** key, enter the whole package quantity next, depress the **@/FOR** key again, and then depress the department key.

If a non-preset price must be entered on the keyboard into a preset department, depress the **PR OPEN** key either before or after the price entry on the numeric keyboard.

Each department is also programmed with either positive or negative use, a HALC (High Amount Listing Capacity), LALC (Low Amount Listing Capacity), tax and S.I. (Selective Itemized) status. A maximum of 8 alpha/numeric characters can also be programmed for each department name.

A negative department item or a department item entered with **RTN MDSE**, **PR OPEN**, or **SHIFT** key can not be repeated.

A department key can also be programmed to be used as a "Single-item" Department key. If so programmed, the department entry routine above mentioned will immediately finalize the sale as cash without depressing any of the media key, when operated outside a sale. The Single-item Department key will function, however, just as an ordinary itemized department key if used inside a sale.

SET SET KEY

This key is used by the store manager to set or change programmed data which must change daily or weekly according to the requirements of the store. The items programmable with the **SET** key are included in those programmable in the 'SET' position of the Mode Lock. However, it may be more convenient for the manager to be able to change the program data by himself instead of asking to the programmer.

Detail operations using the **SET** key are described later in the "MANGER'S PROGRAMMING OPERATIONS". The following are the items that can be programmed or changed with the **SET** key:

1. COMMERCIAL MESSAGE
2. CLERKS' NAMES
3. DEPARTMENT PRESET PRICE CHANGE
4. PLU PRESET PRICE CHANGE
5. TIME ADJUSTMENT

EX TAX EXEMPT KEY

This key is used to declare the exemption of the taxes from the sale, displaying the sale total with taxes and printing the tax-exempted portion total. Only a finalizing operation is possible after a **EX** key depression.

The **ITEM CORR** key (or **IC/VD** used as Item Correct Key) can not function to delete a **EX** key entry.

If two tax modifier keys (**TX1/M** and **TX2/M**) are installed, tax-exemption may operate in any of the following three ways:

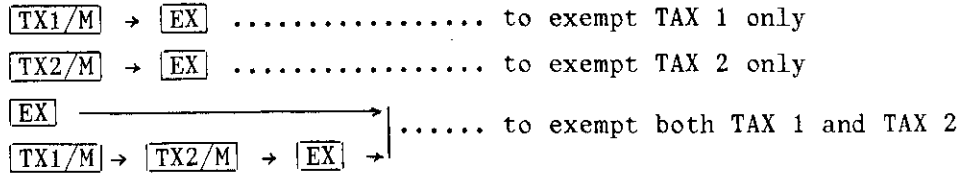

If only one tax modifier key (**TX/M**) is installed, operate the **EX** key alone for the tax exemption.

R/A RECEIVED ON ACCOUNT KEY

A received on account transaction is used to identify money which is in the drawer but not business. The amount entered is thus included in the "Cash-in-drawer" total but not in the sales totals.

To operate, enter an amount of payment and then depress the **R/A** key. Repeat this operation if multiple payments are entered at a time. The payments entered are finalized by the **AT/TL** key (if paid in cash). Other media keys may also finalize payments received on account if so programmed in the system option. The above operation can only be done when the register is outside a sale.

The **R/A** key is also used to declare the payment amount near the end of a charge posting operation. After depressing the **Chg** key to obtain the sale total, enter the amount portion to be paid in this sale and then depress the **R/A** key, followed by the media tendering or totalling operation. Refer to detail description in the "REGISTER PROCEDURE FOR SALES" as to this operation.

The **R/A** key is also used as the Loan Start Declaration key.

PO PAID OUT KEY

A paid out transaction is used when an amount of money is removed from the cash drawer without relating to a sale. When the **PO** key is used, the amount entered is subtracted from the "Cash-in-drawer" total but does not affect the sales totals.

To operate, enter an amount taken from the cash drawer and depress the **PO** key whilst the register is in an out-of-sale condition. This operation may be carried out as many times as required if multiple paid-out items are registered at a time. The paid-out amounts recorded are finalized by the **AT/TL** key only.

In a charge posting operation, this key is depressed to pay back all the balance to the customer, after once finalizing the account with the **Chg** key.

The **PO** key is also used as Pick Up Start Declaration Key when the Mode Lock is set to the 'MGR' position.

MEDIA 1 ~ 5 KEYS (**CHK TND** , **Chg** , **MSC TND** , **CARD** , **MEDIA 5**)

These media-keys are used as alternative methods of payment for non-cash sales. Each of these keys is programmable as to its descriptor, use of tender and/or total key, corresponding media, no-sale cashing allowed/prohibited, over-tendering allowed/prohibited, validation optional/compulsion, etc. The following is the standard use of each key:

MEDIA 1 Key: **CHK TND** CHECK TENDERED KEY

- . Tender Key
- . Validation -- optional
- . Prints the tendered amount (not the sale total) when validated
- . No-sale cashing -- allowed
- . Over-tendering -- allowed
- . Media Total on In-drawer Report -- print
- . Finalization of **R/A** entries -- allowed

MEDIA 2 Key: **Chg** CHARGE TOTAL KEY

- . Total Key
- . Validation -- optional
- . Prints the sale total when validated
- . No-sale cashing -- prohibited
- . Media Total on In-drawer Report -- non-print
- . Finalization of **R/A** entries -- prohibited

MEDIA 2 Key is also used as the finalizing key for charge posting operations.

MEDIA 3 Key: **MSC TND** MISCELLANEOUS TENDERED KEY

- . Tender Key (for medias other than cash, cheque, card, and coupon)
- . Validation -- optional
- . Prints the tendered amount (not the sale total) when validated
- . No-sale cashing -- prohibited
- . Over-tendering -- allowed
- . Media Total on In-drawer Report -- print
- . Finalization of **R/A** entries -- allowed

MEDIA 4 Key: **CARD** CARD TOTAL KEY

- . Total Key
- . Validation -- optional
- . Prints the sale total when validated
- . No-sale cashing -- prohibited
- . Media Total on In-drawer Report -- non-print
- . Finalization of **R/A** entries -- allowed

MEDIA 5 Key: (optional media key)

- . Tender Key
- . Validation -- optional
- . Prints the tendered amount (not the sale total) when validated
- . No-sale cashing -- prohibited
- . Over-tendering -- prohibited
- . Media Total on In-drawer Report -- print
- . Finalization of **R/A** entries -- allowed

As for operations, refer to the description for the AT/TL key. Follow "AMOUNT TENDERED FUNCTION" if the media key is programmed as a "Tender Key", and follow "TOTAL FUNCTION" description if the media key is programmed as a "Total Key".

If the media key is programmed to allow "No-sale cashing": when the register is outside a sale, enter the tendered amount in that media, and depress the Media Key. A receipt is issued and the drawer is opened to enable exchange.

AT/TL CASH AMOUNT TENDERED / TOTAL KEY

This key is used to record all cash paid on transactions, and will be able to finalize a sale operation. Usually the key is programmed to function as both "Tender" and "Total" key. However, the key may be programmed to operate with enforced tendering or as a cash total key.

AMOUNT TENDERED FUNCTION

After the ST key has been depressed, enter the amount tendered by the customer in payment of the sale, and then depress the AT/TL key. The change is automatically computed, displayed, and printed.

If the amount tendered is smaller than the sale total, it prints the amount tendered on the receipt with the balance still due displayed, but the drawer is not yet opened. In this case, ask the customer for additional payment in cash and repeat the same amount tendering operation, or use another media key if the balance due is processed as a sale in that media.

NOTE: If the AT/TL key has been programmed to function as the "AMOUNT TENDERED" key only and the sale total is "0" or negative, no amount tendering can be entered. In this case, the AT/TL key will function as the "TOTAL" key, so just depress the AT/TL to obtain the total and finalize the sale. The balance in negative indicates that the amount must be paid back to the customer in cash. A negative-balanced sale can only be finalized by the AT/TL key, but not by any other media key.

TOTAL FUNCTION

To obtain the total and finalize a cash sale, depress the AT/TL key only. The sale is finalized with the total printed and displayed, and the drawer opens.

NOTE: If the "ST Compulsory" option has been selected in the system option, a ST key depression is always required before finalizing any sale.

If the "Total Validation" option has been selected, validation after the ST key depression will print the sale total (not subtotal) and thereafter only sale finalizing operation will be allowed.

If the "Total Validation Compulsory" option has been selected, the Total Validation operation will always be required before finalizing any sale.

The **AT/PL** key is also used to finalize received-on-account payments or paid-out amounts.

The **AT/TL** key can be programmed with the HALC (High Amount Listing Capacity) of the amount tendered. If the HALC has been set, the amount tendered must not exceed the programmed value; otherwise, it will result in an error. If the **LC OPEN** key is used prior to the **AT/TL** depression, the HALC will be extended by one additional digit. If an amount still larger must be entered, the MA or MGR key is required to turn the Mode Lock to the MGR position.

ST SUB-TOTAL KEY

This key is used to obtain the sub-total amount during a sale. When this key is depressed after all the items have been rung up, the sub-total of the sale is printed and displayed.

If the **ST** key is depressed more than once consecutively, the first depression only will print and display the sub-total; further depressions will only display but not print the sub-total amount.

The system option provides the selection not to print but only display the sub-total even on the first depression of the **ST** key.

Mandatory depression of this key prior to finalizing is a programmable option.

In charge posting, a depression of the **ST** key displays the sub-total amount without previous balance.

TRF TRANSFER KEY

When a charge posting operation is ended with the **Chg** key, this key is used to transfer the entire balance with no payment.

To operate, depress the **TRF** key after the **Chg** key. All the balance is transferred, the transferred amount is printed as the new balance, and a receipt is issued. When the amount is less than 7 digits, the figures are printed in double-sized characters.

TXBL **TL** TAXABLE TOTAL KEY

This key is used to display the contents of the main itemizer (i.e., sale total) plus any taxes due. The amount will display only but not be printed.

In order to allow add-on operation following the use of this key, the taxes are not added into any totals until actual finalization is initiated.

Mandatory depression of this key prior to finalizing is a programmable option.

If the "TOTAL VALIDATION" option is selected, depressing the **VALIDATE** key after a **TXBL TL** key operation prints the sale total on the validation slip, and therefore, only a finalizing operation then is allowed.

In charge posting, depressing the **TXBL TL** key displays the amount including taxes without the previous balance.

OTHER OPTIONAL KEYS

The following keys are not shown in the KEYBOARD LAYOUT on page 5 nor described on the previous pages. However, any of them may be installed if the customer requires. But please note that some of the present keys may have to be dispensed with or additional memories may have to be installed to gain additional functions. Please contact your TEC representative if any of the following keys is necessary.

Additional Department Keys

A maximum of 30 department keys including the present department keys may be installed.

SHIFT DEPARTMENT SHIFT KEY

This key functions similarly to the "Shift Key" on a regular typewriter keyboard. Two departments can be programmed on one department key, and shifting from one to the other is possible. For example, Department 1 Key can be used as Department 16 if the **SHIFT** key is depressed prior to **DEPT 1** key. In this case, the number of all the department keys on the keyboard must be 15 or less. Thus the keyboard can spare space to other function keys despite the number of departments.

The **SHIFT** key is effective to shift a department for only one entry; therefore, the shifted department can only be repeated by the **RPT** key but not by the department key.

RPT REPEAT KEY

This key is used to repeat a department or PLU entry. This key enables repeat entries not only for normal department or PLU items but also items modified with **PR OPEN**, **SHIFT**, etc.

OPEN LC-and-PRESET OPEN KEY

This is a dual-function key that has both **LC OPEN** key and **PR OPEN** key functions.

NON-ADD NUMBER PRINT KEY

This key is used to print a non-adding number (such as Check No., Credit Card No., etc.) on the receipt and journal for future reference. To operate, enter a maximum of 8-digit number and then depress the **#** key. The number is then printed. This operation may be done any time between two sales items, before or after all the sales items if the sale has not been finalized yet. Usually, non-add numbers may be entered any number of times within a sale. However, it is programmable to prohibit more than one non-add number entry within a sale by the system option.

When the Mode Lock is in the "X" position, the **#** key is used to read the Cash-in-drawer Total.

NS NO-SALE KEY

This key is used to open the cash drawer while the machine is outside a sale. To operate, depress this key once. A non-add number may usually be entered prior to a no-sale operation. However, it can be programmed to prohibit it when a no-sale is operated.

BTL RTN BOTTLE RETURN KEY

This is a credit key to enter a bottle return amount. This key can be programmed as either a motorized inside-sale key or non-motorized department-linked key.

WHEN PROGRAMMED AS MOTORIZED INSIDE-SALE KEY:

To operate, enter the bottle return amount and then depress the **BTL RTN** key. The **BTL RTN** key functions like a negative department key.

The amount entered through the **BTL RTN** key must not exceed the sale total unless the "Credit Balance" option is selected.

WHEN PROGRAMMED AS NON-MOTORIZED DEPARTMENT-LINK KEY:

To operate, depress the **BTL RTN** key either before or after the bottle return amount entry, and then depress the appropriate department key. The **BTL RTN** key functions like a **RTN MDSE** key.

The amount entered through the **BTL RTN** key will subtract the department total but not affect the departemnt counter.

The bottle return amount must not exceed the sale total unless the "Credit Balance" option is selected.

The **PLU** key cannot be used with the **BTL RTN** key.

The amount entered through the **BTL RTN** will be limited by the HALC (High Amount Listing Capacity) of the department through which the amount is entered.

Quantity extension using the **BTL RTN** key (either type of the above two) is possible; however, decimal quantity is not allowed. Neither will split-package-pricing entry be allowed with the **BTL RTN** key.

None of the **RTN MDSE**, and **VOID** (or **IC/VD** used as Designated Line Void) keys will function with the **BTL RTN** key.

**RECEIPT
ISSUE**

RECEIPT POST-ISSUE KEY

This key is used to issue the receipt of a sale (prints the sale total only, not detail items) when the sale has already been finalized with the **RECEIPT ON/OFF** switch positioned to OFF. However, if selected in the system option, the post-receipt issuance is possible even when the last sale was finalized with the **RECEIPT ON/OFF** switch positioned to ON.

To operate, depress the **RECEIPT ISSUE** key without numeric entry. The receipt for the last sale is then issued. This key will not function if another sale has already been under way.

Single-item Department Keys

Two ways are available for changing ordinary department keys into Single-item Department keys. One is to change Departments 1 through 15 only into Single-item Keys and to hold other Departments as ordinary department keys. The other is to change all the Departments (maximum 30 departments) into Single-item Keys.

If a department is programmed as a Single-item Key, the department entry routine will immediately finalize the sale as cash without operating any of the media keys when operated outside a sale. The Single-item Key will function, however, just as an ordinary itemized department key if used inside a sale.

TAX **MANUAL TAX KEY**

This key is used to enter an irregular tax amount that cannot be calculated on the basis of the programmed tax table, and to add it to the sale total.

To operate, enter the desired amount of tax, and then depress the **TAX** key. The tax amount entered is then printed. This tax amount is processed into the TAX 2 memory. Therefore, the tax amount automatically calculated and printed at finalizing the sale (TAX 1) does not include a manual-entered tax, while the entire sale total printed on the receipt last line includes the manual-entered tax also.

This key is also used, if depressed without an amount entry within a sale, to display the total of only non-taxable items so far entered. Usually, this non-taxable total is only displayed but not printed. However, it may be programmed to print also.

ITEM CORR **ITEM CORRECT KEY**

This key functions as Item Correct key (but not as Designated Void key), which has already been described for the **IC/VD** key.

VOID **DESIGNATED VOID KEY**

This key is used as Designated Line Void key (but not as Item Correct key), which as already been described for the **IC/VD** key.

REGISTERING PROCEDURE FOR SALES

Here are patterns for actual registering operations. In the following examples, " " indicates an input through numeric keys, "" indicates a depression of the transaction key, and "----" indicates other registering and/or finalizing operations.

NO-SALE (Mode Lock: REG or MGR)

NS (or #/NS)

DEPARTMENT ENTRY (Mode Lock: REG, MGR, or)

PRICE | → OPEN DEPT | → ----

PRESET DEPT | → ----

PR OPEN | → PRICE | → PRESET DEPT | → ----

NOTES: 1. When a price to override the listing capacity is entered, the LC OPEN key may be depressed either before or after the price entry but before the department key depression. In this case, a price two-digit larger than the HALC or 1-digit smaller than the LALC may be entered for one entry only. To allow a price even larger or smaller than this, the MA or MGR key is required and set to the MGR position of the Mode Lock.

2. Tax Modifier Keys may be used to reverse the tax status:

(PRICE |) → TX1/M | → DEPT | ... to reverse Tax1 taxable/non-taxable status of the department.

(PRICE |) → TX2/M | → DEPT | ... to reverse Tax2 taxable/non-taxable status of the department.

(PRICE |) → TX1/M | → TX2/M | → DEPT | ... to reverse both Tax1 and Tax2 taxable/non-taxable status

PLU ENTRY (Mode Lock: REG, MGR, or)

PLU CODE | → PLU | → ---- to enter a preset PLU price

PLU CODE | → PLU | → PRICE | → AMT | → ---- to enter an amount into an open PLU

NOTES: 1. Neither PR OPEN nor LC OPEN key can be used.

2. TX1/M or TX2/M may be used. (See "NOTE 2" above in "DEPARTMENT ENTRY" description.)

SINGLE DEPARTMENT ITEM (Mode Lock: REG, MGR, or)

PRICE | → OPEN DEPT |
PRESET DEPT |] The sale is immediately finalized as cash without operating any media key, if outside a sale.

REPEAT ENTRY (Mode Lock: REG, MGR, or)

PRESET DEPT → PRESET DEPT → PRESET DEPT → ---

(Repeat depressing the same dept key as many times as the desired count.)

PRICE → OPEN DEPT → OPEN DEPT → OPEN DEPT → ---

PRESET PLU CODE → PLU → PLU → PLU → ---

OPEN PLU CODE → PLU → PRICE → AMT → AMT → AMT → ---

- NOTES: 1. Repeat entry is not possible by the above patterns when the PR OPEN, VOID, RTN MDSE, BTL RTN, STR CPN, or SHIFT key has been operated together.
 2. The LC OPEN or TX1/M (or TX2/M) key is effective on repeat operation by the above patterns.

PRESET DEPT → RPT → RPT → ---

PRICE → OPEN DEPT → RPT → RPT → ---

PR OPEN → PRICE → PRESET DEPT → RPT → RPT → ---

SHIFT → PRESET DEPT → RPT → RPT → ---

SHIFT → PRICE → OPEN DEPT → RPT → ---

PRESET PLU CODE → PLU → RPT → RPT → ---

OPEN PLU CODE → PLU → PRICE → AMT → RPT → RPT → ---

QUANTITY EXTENSION (MULTIPLICATION) (Mode Lock: REG, MGR, or)

QUANTITY → X → PRESET DEPT → ---

(May be omitted if the quantity is one-digit.)

PR OPEN → QUANTITY → X → PRICE → PRESET DEPT → ---

QUANTITY → X → PRICE → OPEN DEPT → ---

QUANTITY → X → PRESET PLU CODE → PLU → ---

OPEN PLU CODE → PLU → QUANTITY → X → PRICE → AMT → ---

- NOTE: QUANTITY -- max. 3-digit integral and 3-digit decimal
 (Use . key before entering decimal digits.)
 PRICE -- max. 6 digits
 PRODUCT -- must not exceed 7 digits.

NOTE: The @/FOR key functions the same as the X key in the above operation patterns.

SPLIT PRICING (Mode Lock: REG, MGR, or)

|PURCHASED Q'TY| → /@/FOR → |WHOLE PACKAGE Q'TY| → /@/FOR → |PRESET DEPT| → ---

|PURCHASED Q'TY| → /@/FOR → |WHOLE PACKAGE Q'TY| → /@/FOR →
|WHOLE PACKAGE PRICE| → |OPEN DEPT| → ---

|PURCHASED Q'TY| → /@/FOR → |Split Price Type PLU Code| → |PLU| → ---
(Preset PLU)

|Split Price Type PLU Code| → |PLU| → |PURCHASED Q'TY| → /@/FOR →
(Open PLU)
|WHOLE PACKAGE PRICE| → |AMT| → ---

- NOTES:** 1. The "PURCHASED Q'TY" and "WHOLE PACKAGE Q'TY" must be of integral value; no decimal value is allowed.
2. Usually, the fraction of the result is rounded up in split pricing operation. However, it is programmable to round up the fraction of each item price (item price = WHOLE PACKAGE PRICE ÷ WHOLE PACKAGE Q'TY).
3. Only the "Split Price Type" PLUs allow split pricing operations, but not the other ordinary type of PLUs.

RETURNED MERCHANDISE (Mode Lock: REG, MGR, or)

|RTN MDSE| → |PRESET DEPT| → ---

|RTN MDSE| → |PRICE| → |OPEN DEPT| → ---

|RTN MDSE| → |PR OPEN| → |PRICE| → |PRESET DEPT| → ---

|RTN MDSE| → |PRESET PLU CODE| → |PLU| → ---

|RTN MDSE| → |OPEN PLU CODE| → |PLU| → |PRICE| → |AMT| → ---

AMOUNT DISCOUNT (Mode Lock: REG, MGR, or)

|DISCOUNT AMOUNT| → |DOLL DISC| → ---

- NOTES:** 1. Unless the "Credit Balance" option has been selected, no discount amount exceeding the sale total will be allowed.
2. Unless the "Credit Balance" option has been selected, no amount discount operation outside a sale will be allowed.

PERCENT DISCOUNT (Mode Lock: REG, MGR, or)

(1) To discount from the sub-total:

|ST| → % → --- ... to discount by the preset % rate

|ST| → |RATE| → % → --- ... to discount by a manual rate

(2) To discount from an individual department item:

DEPT → **%-** → --- ... to discount by the preset % rate

DEPT → **RATE** → **%-** → --- ... to discount by a manual rate

- NOTES: 1. The rate may be entered within the range up to 99.999%. If the rate contains the decimal point, use the **.** key.
2. The above **DEPT** keys may be replaced by a PLU entry.

PERCENT CHARGE (Mode Lock: REG, MGR, or **-**)

This operates the same as in the "PERCENT DISCOUNT" operations above, except that the **%+** is used instead of the **%-** key.

In addition:

PB+ → (**RATE**) → **%+** → ---

PICK UP BAL → (**RATE**) → **%+** → ---

BOTTLE RETURN (motorized **BTL RTN** key) (Mode Lock: REG, MGR, or **-**)

Department or PLU entries → **BOTTLE RETURN AMOUNT** → **BTL RTN** → ---

BOTTLE RETURN (non-motorized **BTL RTN** Key) (Mode Lock: REG, MGR, or **-**)

BTL RTN → **PRESET DEPT** → ---

BTL RTN → **BOTTLE RETURN AMOUNT** → **OPEN DEPT** → ---

- NOTES: 1. Quantity extension is possible, but split pricing is not.
2. **RTN MDSE**, **VOID**, key can not be operated.

NON-ADD NUMBER PRINT (Mode Lock: REG, MGR, or **-**)

NUMBER → **#** (or **#/NS**) → ---

└ (Cheque No., Customer No., Credit Card No., etc.; max. 8 digits)

- NOTES: 1. If the "Non-add Number Print Allowed Only Once" option has been selected, a second non-add number entry in a sale will result in an error.
2. The **.** key cannot be used to enter a non-add number.

ITEM CORRECTION (LAST LINE VOIDING) (Mode Lock: REG, MGR, or)

PRESET DEPT → ITEM CORR → ---

PRICE → OPEN DEPT → ITEM CORR → ---

RTN MDSE → PRESET DEPT → ITEM CORR → ---

RTN MDSE → PRICE → OPEN DEPT → ITEM CORR → ---

PRESET PLU CODE → PLU → ITEM CORR → ---

OPEN PLU CODE → PLU → PRICE → AMT → ITEM CORR → ---

* The IC/VD key will function the same as the ITEM CORR key in all of these patterns.

- NOTES: 1. The ITEM CORR key depression will delete the last line item already printed within a sale.
 2. The ITEM CORR key functions to delete the last line item, even if the DEPT keys in the above examples are replaced by the %+, %- , R/A , PO , - , BTL RTN (motorized key), PB+ , or PB- key.

VOID (DESIGNATED LINE VOIDING) (Mode Lock: REG, MGR, or)

VOID → PRESET DEPT → ---

PRICE TO BE VOIDED → VOID → OPEN DEPT → ---

VOID → DEPT PRICE TO BE VOIDED → OPEN DEPT

→ % CHARGE (or DISCOUNT) RATE TO BE VOIDED ALONG WITH THE DEPT PRICE → %+ (or %-) → ---

VOID → PRESET PLU CODE → PLU →

VOID → OPEN PLU CODE → PLU → PRICE TO BE VOIDED → AMT →

→ (A %+ or %- key operation may follow, just as in the above, if necessary.)

1 → IC/VD → PRESET DEPT → ---

└─ Quantity "1"

PRICE TO BE VOIDED → IC/VD → OPEN DEPT → ---

PRESET PLU CODE → IC/VD → PLU → ---

OPEN PLU CODE → IC/VD → PRICE TO BE VOIDED → AMT → ---

- NOTES: 1. Designated voiding cannot be made on a department that has been preset as a negative department.
 2. Unless the "Credit Balance" option has been selected, voiding to result the sale total into negative will go into an error.

3. The **IC/VD** will function the same as the **VOID** key except that:

- 1) **VOID** may be depressed before or after a numeric entry, if before the motorized key (key to cause the line item print).
- 2) **IC/VD** can only be depressed after a numeric entry. If depressed at the top, it will item-correct the last item just entered before the **IC/VD** depression. Therefore, in voiding a preset department entry, the quantity must be entered first (if a normal entry, the quantity will be "1"), next depress **IC/VD**, and then **PRESET DEPT**.

SUB-TOTAL (Mode Lock: REG, MGR, or **-**)

--- → **ST** → --- ... The sale total so far is displayed and printed, but the sale is not finalized.

- NOTE:**
1. If the **C** key is depressed after once obtaining a sub-total, the sub-total amount will be displayed.
 2. If the **ST** key is depressed more than once consecutively, the first depression only will print and display the sub-total; further depressions will only display but not print the sub-total.

TAXABLE TOTAL READ (Mode Lock: REG, MGR, or **-**)

--- → **TXBL TL** → --- ... The sale total with taxes so far is displayed but not printed. The sale is not finalized.

- NOTES:**
1. If the **C** key is depressed after the **TXBL TL** key has once been depressed, the sale total with taxes is then displayed.
 2. If the **TXBL TL** key is depressed during a charge posting operation, the sale total with tax and without the previous balance is displayed.

MANUAL TAX ENTRY (Mode Lock: REG, MGR, or **-**)

| TAX AMOUNT TO BE ADDED | → **TAX** → ---

NON-TAXABLE ITEM TOTAL READ (Mode Lock: REG, MGR, or **-**)

--- → **TAX** → --- ... The total of the non-taxable item(s) so far entered within the sale is displayed. It is usually not printed, but programmable to print if required.

TAX EXEMPTION (Mode Lock: REG, MGR, or **-**)

--- → **EX** → Finalization ... to exempt all the taxes

--- → **TX1/M** → **TX1/M** → **EX** → Finalization ... to exempt all the taxes

--- → **TX1/M** → **EX** → Finalization ... to exempt TAX 1 only

--- → **TX2/M** → **EX** → Finalization ... to exempt TAX 2 only

CASH TOTAL (Mode Lock: REG, MGR, or)

--- → (TXBL TL) → AT/TL ... The drawer opens, the sale total is displayed and printed, and a receipt is issued.

CASH TENDERING (Mode Lock: REG, MGR, or)

--- → (TXBL TL) → CASH AMOUNT TENDERED | → AT/TL
... The drawer opens, the change due is displayed, the amount tendered and the change are printed, and a receipt is issued.

CHECK TENDERING (Mode Lock: REG, MGR, or)

--- → (TXBL TL) → AMOUNT OF CHECK TENDERED | → CHK TND

CHARGE TOTAL (Mode Lock: REG, MGR, or)

--- → (TXBL TL) → Chg

MISCELLANEOUS MEDIA TENDERING (Mode Lock: REG, MGR, or)

--- → (TXBL TL) → AMOUNT OF MISC.MEDIA TENDERED | → MSC TND

CARD TOTAL (Mode Lock: REG, MGR, or)

--- → (TXBL TL) → CARD

MEDIA 5 TENDERING (Mode Lock: REG, MGR, or)

--- → (TXBL TL) → AMOUNT OF MEDIA 5 TENDERED | → MEDIA 5

NOTE: The above operations of CHECK, CHARGE, MISC., CARD, and MEDIA 5 keys are based on the standard programming. If any of those keys is programmed to be used the other way (i.e., "Total Key" instead of "Tender Key" or vice versa), do the operation as shown in "CASH TOTAL" and "CASH TENDERING". Also, the actual media corresponding to each media key may be differed according to the customer's requirement.

NOTE ON NEGATIVE SALE FINALIZATION BY MEDIA KEYS:

When a media key is programmed to allow "Total Function" (i.e., "TOTAL FUNCTION only" or "TENDER and TOTAL FUNCTION"), a negative sale may be finalized by that media. Whether it requires the MGR position of the Mode Lock or not is determined by the system option. The AT/TL key can always finalize a negative sale regardless of this option status.

MULTI-TENDERING, SPLIT TENDERING (Mode Lock, REG, MGR, or)

MULTI-TENDERING (Short tendering repeated multiple times by the same media)

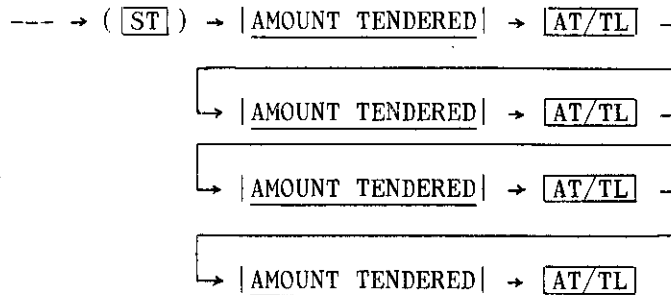

The key may be replaced by any other media key if it is programmed to allow tendering.

SPLIT-TENDERING (Short tendering repeated by different media keys)

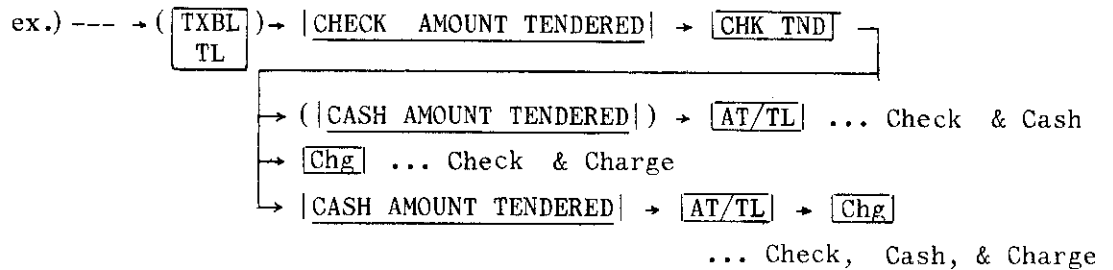

Other media keys may also be used.

- NOTES:**
1. In both MULTI-TENDERING and SPLIT-TENDERING operations, the sale is finalized, a receipt is issued, and the drawer opens on reaching the sale total amount.
 2. If a media key is depressed without an amount tendering entry (if that key can function as a "Total Key"), the sale is then finalized on that stage, processing all the balance due into that media.

CHECK CASHING (Mode Lock: REG or MGR)

| AMOUNT OF CHECK TO BE CASHED | → [CHK TND] ... The drawer opens and a receipt is issued. Receive the check and pay the amount in cash to the customer.

- NOTES:**
1. Check cashing is allowed only outside a sale.
 2. The system option provides a selection to prohibit check cashing operations, if necessary.
 3. Other media keys may be programmed to allow cashing, if necessary.

RECEIVED ON ACCOUNT (Mode Lock: REG or MGR.)

|AMOUNT OF PAYMENT| → [R/A] → (|AMOUNT RECEIVED|) → [AT/TL] (if paid in cash)
|
Repeat if multiple payments are entered. or any other media keys if programmed to allow R/A entries.

NOTE: Any other media key may finalize payments received on account if so programmed in the system option. In this case, the entry of "|AMOUNT RECEIVED|" is compulsory if the key is programmed to be a "Tender Key". Skip the amount entry if the key is programmed to be a "Total Key".

MULTI-TENDERING and SPLIT-TENDERING are also applied in finalizing R/A entries.

PAID OUT (Mode Lock: REG or MGR.)

|AMOUNT TO BE PAID OUT| → [PO] → [AT/TL]
|
Repeat if multiple amounts are paid out at a time.

PREVIOUS BALANCE, CHARGE POSTING (Mode Lock: REG, MGR, or [-])

1. TO INITIATE CHARGE POSTING FOR A NEW CUSTOMER

[0] → [PB+] (or [PB-]) → To be continued to the line marked with "*" on the next page.

2. CHARGE POSTING WITH A PREVIOUS BALANCE FIRST ENTERED (PRE-SELECT)

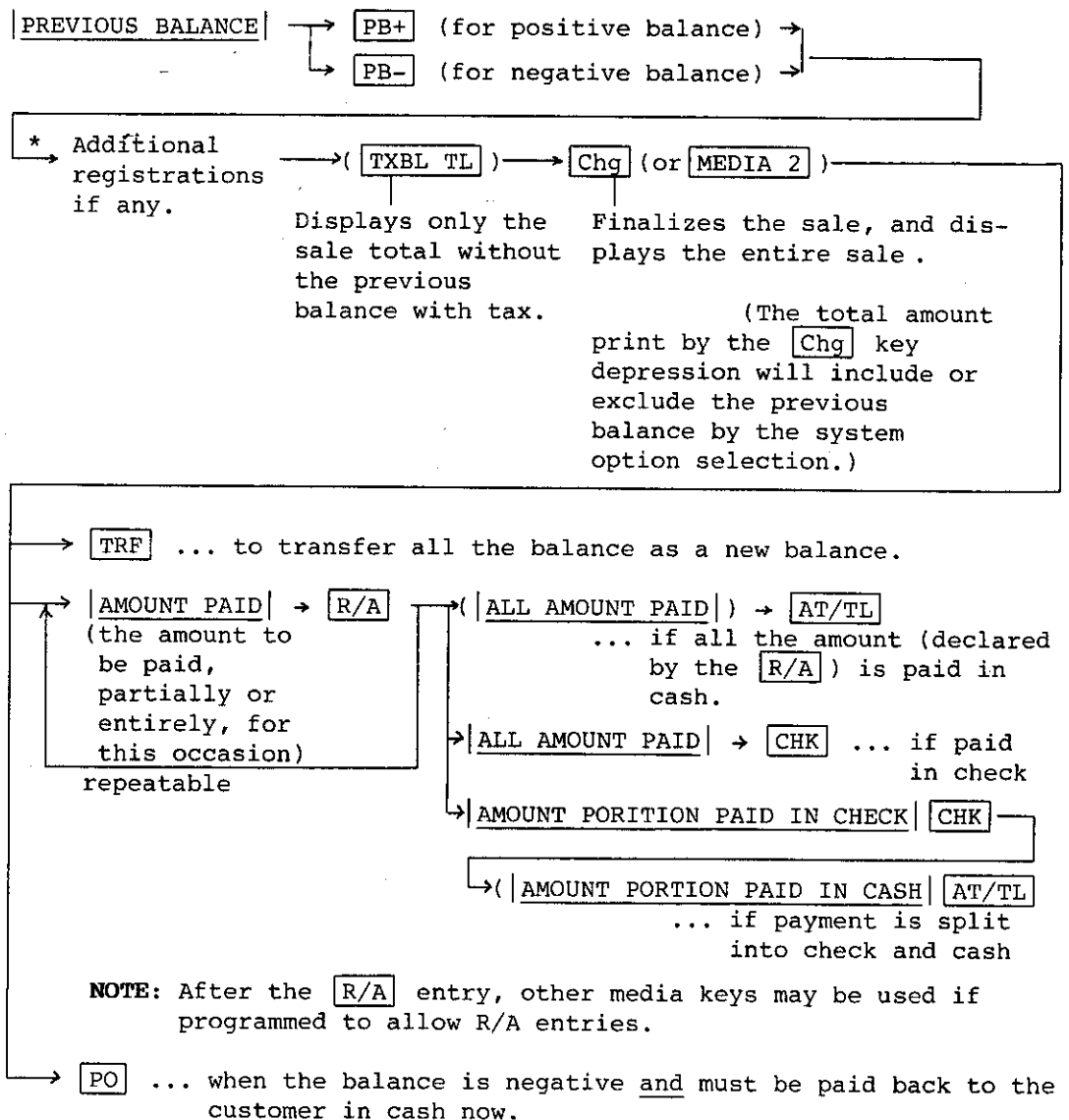

3. CHARGE POSTING WITH A PREVIOUS BALANCE ENTERED DURING SALE (POST-SELECT)

A previous balance may be entered not only before other sales items but also after or between them if the **Chg** key has not been depressed. Multiple previous balance entries are also possible within a sale.

4. PERCENT CHARGE ADDITION TO A PREVIOUS BALANCE

PREVIOUS BALANCE → **PB+** → (**MANUAL RATE**) → **%+** → ---

NOTE: The **%-** operation will not be allowed after any previous balance entry.

LOAN (FLOAT IN DRAWER) (Mode Lock: REG or MGR)

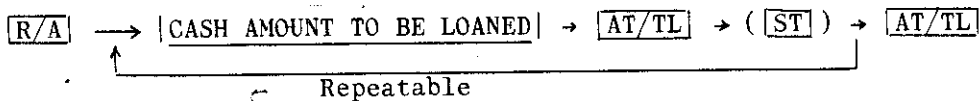

- NOTES:
1. Neither the **ITEM CORR** nor **VOID** key can void any items in a loan operation.
 2. Quantity extension is not possible for loan entries.
 3. Cash is the only media allowed for loan.

PICK UP (Mode Lock: MGR only)

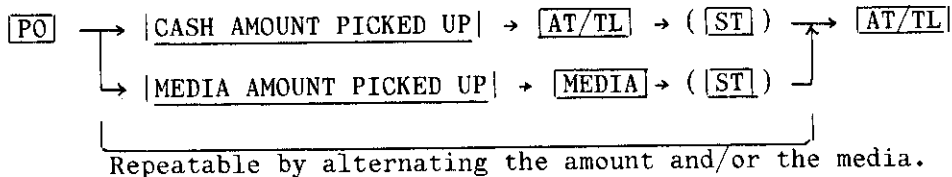

- NOTES:
1. Pick up amounts may be recorded through the **AT/TL** (cash amount), **VND CPN** (vendor coupon amount), and other media keys whose Media-in-drawer Totals are programmed to be printed on In-drawer Report.
 2. An amount must be entered before each media key.
 3. Neither the **ITEM CORR** nor **VOID** key can void any items in a pick up operation.
 4. The register with four Clerk Keys allows this pick up operation and each clerk may pick up individually to affect his/her own clerk In-drawer memory. Meanwhile, each memory turning into negative will not be an error.
 5. On the depression of the **PO** key, the drawer opens. Pick up operations may be carried out with the drawer kept open, even if the "Drawer-close Compulsory" option is selected.

OPERATIONS IN "[-]" MODE (Mode Lock: [-])

Operations with the condition of "Mode Lock: REG, MGR, or [-]" can be operated in the [-] position of the Mode Lock, which will be useful in deleting all the items once recorded in the "REG" or "MGR" mode by following the sales receipt. Instead of using the **RTN MDSE** or **VOID** key in the "REG" or "MGR" mode for deleting individual items, the "[-]" mode automatically processes positive items into negative and negative into positive. To operate, turn the Mode Lock to the "[-]" position, and enter the items, one by one, just as in the "REG" mode, following the sales receipt. The balance resulted in the "[-]" mode indicates the amount to be paid back to the customer.

VALIDATION PRINT (Mode Lock: REG or MGR)

After entering an item through a transaction key or a media key → Insert a validation slip into the validation slot. Make sure that the "SLP" Lamp becomes lit. →

VALI
DATE

(If the key has been programmed with the "Validation Compulsory", the "SLP" Lamp will flash on depression the key. If not so programmed, the lamp will remain unlit at this time.)

- NOTES:**
1. No other operations can follow until the validation slip once printed is withdrawn.
 2. Validation printing can be done even after a non-add number or a no-sale entry.
 3. The following are selections that can be programmed in the system option related to validation:

- (1) PRINT FORMAT
 - a) DATE print/non-print
 - b) CONSECUTIVE NO. print/non-print
- (2) MULTI-VALIDATION (allows any number of validation for the same item) or SINGLE-VALIDATION
- (3) VALIDATION compulsory/optional on the following keys:

All media keys (including

AT/TL

),

RTN MDSE

,

PO

,

R/A

,

ITEM CORR

,

VOID

, New Balance,

DOLL DISC

,

%-

, Negative Depts. and PLUS,

BTL RTN

).

When a Media Key is programmed with Validation Compulsory status, the drawer will open after executing a validation print of the media. The

AT/TL

 key is also subject to this rule if programmed with Validation Compulsory status.

REGISTERING RECEIPT SAMPLES

NO-SALE

```

TEC STORE
1343 PEACH DRIVE
PHONE: 877-6437

Thank you
  Call again

10-01-85 #123456

**NOSALE**

JONES 0075 12:51
    
```

A max. of 4 lines
of Store Name/Message
Programmable

A max. of 3 lines
of Commercial Message
Programmable

Date

Register No.

No-sale Symbol

Current Time

Consecutive No.

Clerk Name (If no name has been programmed
for the clerk, the Clerk ID
Code such as "ICL" will be
printed instead.)

RECEIVED ON ACCOUNT, NON-ADD # PRINT

```

TEC STORE
1343 PEACH DRIVE
PHONE: 877-6437

Thank you
  Call again

10-01-85 #123456

#15
R/A-----$5.00--
R/A    $10.00
CASH  10.00

JONES 0079 12:56
    
```

Non-add #15

\$5.00 received, item-corrected

\$10.00 received

Received Total

CHECK CASHING

```

TEC STORE
1343 PEACH DRIVE
PHONE: 877-6437

Thank you
  Call again

10-01-85 #123456

CHECK 10.00

JONES 0078 12:56
    
```

\$10.00 check cashed

PAID OUT

```

TEC STORE
1343 PEACH DRIVE
PHONE: 877-6437

Thank you
  Call again

10-01-85 #123456

PO    $20.00
PB-----$10.00--
TOTAL 20.00

JONES 0080 12:56
    
```

\$2.00 paid out

\$10.00 paid out, item-corrected

Paid Out Total

DEPARTMENT, SUBTOTAL, %

TEC STORE
1343 PEACH DRIVE
PHONE: 877-6437

Thank you
Call again

10-01-85 #123456

VEGTBL \$1.20
FRUIT \$2.00
SUBTL \$3.20
GRP.ST \$3.20
%- 10%
\$0.32-

MEAT \$2.50
FISH \$3.00
SUBTL \$8.38
GRP.ST \$5.50
%- 10%
\$0.55-

CASH \$7.83

ITEM 4
JONES 0081 12:57

Dept.Name
Amount entered

Subtotal (Entire Sale so far made)
Group Subtotal (Ve+Fr)
10% disc.from GRP.ST

Subtotal (Entire Sale so far made)
Group Subtotal (Me+Fi)
10% disc.from GRP.ST

Sale Total including tax to be paid in cash

Item Count purchased

DEPARTMENT (RETURN, ITEM CORRECT,

TEC STORE
1343 PEACH DRIVE
PHONE: 877-6437

Thank you
Call again

10-01-85 #123456

VEGTBL ~~---\$1.23---~~
RTN
FRUIT \$2.30-
15X 1.20@
MEAT \$18.00
DISC \$1.00-
TOTAL 14.70
CATEND \$10.00
CHECK \$4.70
CHANGE \$0.00

ITEM 14
JONES 0082 12:59

QUANTITY EXTENSION),
DOLLAR DISCOUNT,
CASH TENDERING,
CHECK TENDERING,
CHANGE COMPUTAION

Item-Corrected
Returned Item
Quantity Extension
Dollar Discount
Sale Total
Cash Tended
Check Tended
Change due

DEPT. SPLIT PRICING, PLU

TEC STORE
1343 PEACH DRIVE
PHONE: 877-6437

Thank you
Call again

10-01-85 #123456

Pork \$5.00
2X 1.50/ 5
BOYLED \$0.60 T
TAX \$0.06
CASH \$5.66

ITEM 3
JONES 0083 13:01

PLU Item
Split Package Pricing (Taxable Symbol)
Tax due

PLU SPLIT PRICING

TEC STORE
1343 PEACH DRIVE
PHONE: 877-6437

Thank you
Call again

10-01-85 #123456

6X 1.00/ 6
Tomato \$1.00
1X 1.00/ 6
Tomato \$0.17
CASH \$1.17

ITEM 7
JONES 0085 13:06

Whole Package (6 Tomatoes) \$1.00
1/6 Package \$0.17

CHARGE POSTING

TEC STORE
1343 PEACH DRIVE
PHONE: 877-6437

Thank you
Call again

10-01-85 #123456

PB+ \$0.00
VEGTBL \$1.20
MEAT \$2.00
1X 1.00/ 6
Tomato \$0.17
Potato \$1.40
Cheese \$2.00
Chg \$6.77

N-BAL \$6.77

ITEM 5
JONES 0086 13:08

Opening for a new customer,
All balance transfer

Previous Balance "0"
for opening

Purchased items

Must be finalized by Chg.

New Balance Tranferred
(by TRF Key)

TEC STORE
1343 PEACH DRIVE
PHONE: 877-6437

Thank you
Call again

10-01-85 #123456

PB+ \$6.77
BAKERY \$6.00 T
TAX \$0.60
Chg ~~13.37~~

R/A \$10.00
CHECK \$10.00
CHANGE \$0.00

N-BAL \$3.37

ITEM 1
JONES 0087 13:10

Previous Balance,
Partial Payment

Previous Balance \$6.77
Item newly purchased

Must be finalized by Chg.

Payment Declaration
Paid in Check
Change due

New Balance Tranferred

TEC STORE
1343 PEACH DRIVE
PHONE: 877-6437

Thank you
Call again

10-01-85 #123456

PB+ \$3.37
WhiBrd \$1.30 T
RyeBrd \$1.10 T
TAX \$0.24
Chg \$6.01

R/A \$6.01
CASH \$6.01

N-BAL \$0.00

ITEM 2
JONES 0088 13:11

Previous Balance All Paid

Previous Balance \$3.37

Items newly purchased.

Must be finalized by Chg.

Payment Declaration
Paid in Cash

No new balance remaining

% ON LINE ITEM, SPLIT-TENDERING

MISC. TENDERING

TEC STORE
 1343 PEACH DRIVE
 PHONE: 877-6437

Thank you
 Call again

10-01-85 #123456

MEAT \$12.00
 %- 10%
 \$1.20-
 BOTLED \$6.00 T
 %- 5%
 \$0.30-
 TAX \$0.60
TOTAL 17.10
 CATEND \$10.00
 CHECK \$5.00
 Chg \$2.10

ITEM 2
 JONES 0089 13:12

10% discount from
 the above item

5% discount from
 the above item

— Sale Total
 — Cash Portion Tendered
 — check Portion Tendered
 — The Balance as Charge

TEC STORE
 1343 PEACH DRIVE
 PHONE: 877-6437

Thank you
 Call again

10-01-85 #123456

VESTBL \$13.00
 BAKERY \$6.00 T
 SUBTL \$19.00
 TAX \$0.60
TOTAL 19.60
 MISC \$20.00
 CHANGE \$0.40

ITEM 2
 JONES 0090 13:13

— Sale Total
 — Misc. Tendered
 — Change due

LOAN

PICK UP

TEC STORE
 1343 PEACH DRIVE
 PHONE: 877-6437

Thank you
 Call again

10-01-85 #123456

****LOAN ****
 \$10.00
 \$15.00
TOTAL 25.00

JONES 0076 12:54

Loan Symbol
 \$10.00 loaned
 \$15.00 loaned
 Total Amount Loaned

TEC STORE
 1343 PEACH DRIVE
 PHONE: 877-6437

Thank you
 Call again

10-01-85 #123456

****P UP ****
 CASH \$2.00
 CHECK \$3.00
 MISC \$5.00
 SUBTL \$10.00
TOTAL 10.00

JONES 0077 12:55

Pick-up Symbol
 \$2.00 Cash Picked Up
 \$3.00 Check Picked Up
 \$5.00 Misc. Picked Up
 Subtotalling
 Total Amount Picked Up

ENTRIES IN THE "[-]" MODE (NEGATIVE MODE ENTRIES)

Example: A customer who once purchased items listed on the left receipt comes up to return all the items he purchased.

The clerk asks the store manger to turn the Mode Lock to the "[-]" position, and registers all the items, one by one, following the customer's receipt.

The contents of the two receipts are the same except that the Negative Mode Symbol is printed on the right one, and the total amount must be returned to the customer as a result of the Negative Mode Entries.

SALES RECEIPT
(registered in "REG" mode)

```

TEC STORE
1343 PEACH DRIVE
PHONE: 877-6437

Thank you
    Call again

10-01-85 #123456

VEGTBL  $1.00
FRUIT   $2.00
  1X  1.00/ 6
Tomato  $0.17
Potato  $1.40
SUBTL   $4.57
GRP.ST  $4.57
%-      10%
        $0.46-
CASH    $4.11

ITEM    4
JONES 0091 13:16
    
```

NEGATIVE MODE RECEIPT (All Items Returned)
(registered in "[-]" mode)

```

TEC STORE
1343 PEACH DRIVE
PHONE: 877-6437

Thank you
    Call again

10-01-85 #123456

**REG-  ** Negative Mode Symbol
VEGTBL  $1.00
FRUIT   $2.00
  1X  1.00/ 6
Tomato  $0.17
Potato  $1.40
SUBTL   $4.57
GRP.ST  $4.57
%-      10%
        $0.46-
CASH    $4.11 Total Amount to be
                                         returned to the customer

ITEM    4
JONES 0092 13:17
    
```

VALIDATION PRINT SAMPLES

(RECEIPT)

(VALIDATION
TIMING)

(VALIDATION SLIP PRINT)

RECEIVED ON ACCOUNT

TEC STORE
1343 PEACH DRIVE
PHONE: 877-6437

Thank you
Call again

10-01-85 #123456

R/A \$5.00
R/A \$10.00
CASH **15.00**

JONES 0093 13:18

10-01-85 1CL0093 R/A \$5.00

10-01-85 1CL0093R/A CASH **15.00**

Date Receipt
 Consecutive
 No.

Item Name Amount

Clerk
ID (Always prints in Clerk ID Code, not
in name.)

PAID OUT

TEC STORE
1343 PEACH DRIVE
PHONE: 877-6437

Thank you
Call again

10-01-85 #123456

PO \$6.00
PO \$10.00
TOTAL **16.00**

JONES 0094 13:20

10-01-85 1CL0094 PO \$6.00

10-01-85 1CL0094 PO TOTAL **16.00**

CHECK CASHING

TEC STORE
1343 PEACH DRIVE
PHONE: 877-6437

Thank you
Call again

10-01-85 #123456

CHECK **15.00**

JONES 0095 13:21

10-01-85 1CL0095 CHECK **15.00**

VARIOUS ITEMS

TEC STORE
1343 PEACH DRIVE
PHONE: 877-6437

Thank you
Call again

10-01-85 #123456

VEGTBL \$1.00
Potato \$1.40
SUBTL \$2.40
GRP.ST \$2.40
%- 10%
\$0.24-

TOTAL **\$2.16**
CATEND \$2.00
Chg \$0.16

ITEM 2
JONES 0096 13:22

10-01-85 1CL0096 VEGTBL \$1.00

10-01-85 1CL0096 Potato \$1.40

10-01-85 1CL0096%- \$0.24-

10-01-85 1CL0096 CASH \$2.00

10-01-85 1CL0096 Chg \$0.16

READ(X) AND RESET(Z) REPORTS

The following table shows the key operation to take each report. The "X" and "Z" reports have exactly the same content print if both are available, except that:

1. The "X" reports allow to read the totals but not clear memories, while the "Z" reports allow to read the totals and at the same time all the resettable memories will be cleared when the reports have been issued.
2. The symbol "X" is printed on the top line of an "X" report, while "Z" is printed on a "Z" report, to indicate the type of report.
3. A reset count is printed on the bottom of a "Z" report only.

TABLE OF OPERATIONS FOR X AND Z REPORTS

REPORT NAME	KEY OPERATION
<u>INDIVIDUAL MEDIA-IN-READ</u> (If a media key is programmed not to issue its in-drawer report, that media report is not available.)	Mode Lock: X, Depress each Media Key. (Except: depress <input type="checkbox"/> # or <input type="checkbox"/> #/NS for the Cash-in-drawer Report.)
<u>INDIVIDUAL TRANSACTION READ</u>	Mode Lock: X
%+ READ	<input type="checkbox"/> +
%- READ	<input type="checkbox"/> -
DOLLAR DISCOUNT READ	<input type="checkbox"/> DOLL DISC
BOTTLE RETURN READ	<input type="checkbox"/> BTL RTN
RECEIVED-ON-ACCOUNT READ	<input type="checkbox"/> R/A
PAID-OUT READ	<input type="checkbox"/> PO
ITEM CORRECT AND VOID READ	<input type="checkbox"/> ITEM CORR or <input type="checkbox"/> VOID or <input type="checkbox"/> IC/VD
RETURNED MERCHANDISE READ	<input type="checkbox"/> RTN MDSE
TRANSFER AND PB READ	<input type="checkbox"/> TRF
TAXABLE TOTAL AND TAX RREAD	<input type="checkbox"/> TXBL TL
TAX EXEMPTION READ	<input type="checkbox"/> EX

-- To be continued --

TABLE OF OPERATIONS FOR X AND Z REPORTS -- Continued --

REPORT NAME	KEY OPERATION
<u>PLU READ AND RESET</u> ZONE PLU READ * ZONE PLU RESET ALL PLU READ ALL PLU RESET INDIV. PLU READ	Mode Lock: X → Start PLU Code → [@/FOR] Mode Lock: Z → End PLU Code → [PLU] Mode Lock: X → [PLU] Mode Lock: Z → [PLU] Mode Lock: X only, enter the required PLU Code followed by [PLU]. This may be repeated by alternating the code. [ST] may be used to obtain sub-total. [AT/TL] to end.
<u>DEPARTMENT READ AND RESET</u> INDIVIDUAL DEPARTMENT READ ALL DEPARTMENT READ ALL DEPARTMENT RESET } (available only when the "Auto Read/Reset Report Separated" option is selected)	Mode Lock: X, Depress the required Dept Keys, one by one, [ST] may be used to obtain sutotal, [AT/TL] to end. Mode Lock: X → 11 → [AT/TL] Mode Lock: Z → (If the "Auto Read/Reset Report Separated" option is not selected, the Department data are printed on Auto Read/Reset Report listed below)
<u>HOURLY READ AND RESET</u> HOURLY READ HOURLY RESET	Mode Lock: X → 10 → [AT/TL] Mode Lock: Z →
<u>CLERK READ AND RESET</u> INDIVIDUAL CLERK READ INDIVIDUAL CLERK RESET	Mode Lock: X → Set the required Clerk Mode Lock: Z → Key to ON, enter 1, depress [AT/TL].
<u>AUTO READ AND RESET</u> (DEPARTMENT + FINAICIAL + CLERK) AUTO READ AUTO RESET	Mode Lock: X → [AT/TL] Mode Lock: Z →
<u>GT READ AND RESET</u> GT READ GT RESET	Mode Lock: any position GT Lock: GTX → [AT/TL] GT Lock: GTZ →

- NOTES: 1. The drawer will open on the depression of the final key of the KEY OPERATION for the reports marked with "*" in the above table.
2. The drawer will open also for the reports marked with "***" on the depression of the final [AT/TL] key. However, it will not open if so programmed in the system option.
3. No Clerk Key is necessary to issue reports except CLERK READ AND RESET.
4. Refer to the report samples on the following pages. as for the PRESET DATA VERIFICATION, which is available in the "X" mode, see the "VERIFICATION OF PROGRAMMED DATA" near the end of this manual.

REPORT SAMPLES

INDIVIDUAL IN-DRAWER READ

CASH-IN-DRAWER READ

TEC STORE
1343 PEACH DRIVE
PHONE: 877-6437

Thank you
Call again

10-01-85 #123456

X
TOTAL 11CU
CAID \$6.27

0097 13:26

Mode Lock: X
Depress #.

Total Customer Count
Cash-in-drawer Total

CHECK-IN-DRAWER READ

TEC STORE
1343 PEACH DRIVE
PHONE: 877-6437

Thank you
Call again

10-01-85 #123456

X
CHKID 5
\$44.70

0098 13:26

Mode Lock: X
Depress CHK TND

Check-in-drawer Count
Check-in-drawer Total

MISC-IN-DRAWER READ

TEC STORE
1343 PEACH DRIVE
PHONE: 877-6437

Thank you
Call again

10-01-85 #123456

X
MISCID 1
\$20.00

0099 13:26

Mode Lock: X
Depress MISC

Misc-in-drawer Count
Misc-in-drawer Total

INDIVIDUAL TRANSACTION READ

DOLLAR DISCOUNT READ

TEC STORE
1343 PEACH DRIVE
PHONE: 877-6437

Thank you
Call again

10-01-85 #123456

X

DISC 1
\$1.00

0100 13:27

Mode Lock: X
Depress DOLL DISC

Dollar Disc. Count
Dollar Disc. Total

RECEIVED ON ACCOUNT READ

TEC STORE
1343 PEACH DRIVE
PHONE: 877-6437

Thank you
Call again

10-01-85 #123456

X

R/A 3
\$25.00

0101 13:27

Mode Lock: X
Depress R/A

R/A Count
R/A Total

PAID OUT READ

TEC STORE
1343 PEACH DRIVE
PHONE: 877-6437

Thank you
Call again

10-01-85 #123456

X

PO 3
\$36.00

0102 13:27

Mode Lock: X
Depress PO

Paid Out Count
Paid Out Total

ITEM CORRECT AND VOID READ

TEC STORE
 1343 PEACH DRIVE
 PHONE: 877-6437

Thank you
 Call again

10-01-85 #123456

X

CDRR	1
	\$1.23
VOID	0
	\$0.00
MS VD	2
	\$15.00

0104 13:28

Mode Lock: X
 Depress IC/VD
 (or ITEM CORR
 or VOID)

Count-Item Corr on
 Total-Dept(+) items
 Count-Void on
 Total-Dept(+) items
 Count-
 Total-on other items

TRANSFER AND PB READ

TEC STORE
 1343 PEACH DRIVE
 PHONE: 877-6437

Thank you
 Call again

10-01-85 #123456

X

TF TL	\$0.00
TF+GT	\$0.00
TF-GT	\$0.00
TF+	\$0.00
TF-	\$0.00
PBTL	3CU
	\$16.01
PBR/A	\$16.01
PBCA	\$6.01
PBCK	\$10.00
PBMS	\$0.00
PBPD	\$0.00

0103 13:28

Mode Lock: X
 Depress TRF.

Transfer Total
 Transfer GT+
 Transfer GT-
 Transfer+ (Daily)
 Transfer- (Daily)
 PB Customer Total Count
 PB Total Amount
 PB R/A Total
 PB Cash Total
 PB Check Total
 PB Misc Total
 PB Paid Out Total

RETURNED MERCHANDISE AND NEGATIVE MODE READ

TEC STORE
 1343 PEACH DRIVE
 PHONE: 877-6437

Thank you
 Call again

10-01-85 #123456

X

RTN	1
	\$2.30
REG-	1
	\$4.57

0105 13:28

Mode Lock: X
 Depress RTN MDSE.

Item Count of Returned Merchandise in "REG" or "MGR" mode
 Total
 Negative Mode Count
 Negative Mode Total

PLU READ

ALL PLU READ

TEC STORE
1343 PEACH DRIVE
PHONE: 877-6437

Thank you
Call again

10-01-85 #123456

X

Tomato	8	
101*	\$1.34	
Potato	2	
102*	\$2.80	
Apple	1	
201*	\$0.32	
Pork	2	
302*	\$10.00	
Cheese	1	
501*	\$2.00	
WhiBrd	1	
601*	\$1.30	
RyeBrd	1	
602*	\$1.10	
TOTAL	16	
	\$18.86	

0106 13:28

Mode Lock: X
Depress **[PLU]**.

PLU Name/Item Count
PLU Code/Total

All PLUs' Item Count
Total

INDIVIDUAL PLU READ

TEC STORE
1343 PEACH DRIVE
PHONE: 877-6437

Thank you
Call again

10-01-85 #123456

X

Tomato	8	
101*	\$1.34	
Potato	2	
102*	\$2.80	
TOTAL	10	
	\$4.14	

0107 13:29

Mode Lock: X
Enter the required PLU No.,
followed by **[PLU]**.
(This may be repeated for
other required PLUs.)
Depress **[ST]** to obtain
Subtotal.
Depress **[AT/TL]** to end.

ex.)

101 **[PLU]**

102 **[PLU]**

[AT/TL]

ZONE PLU READ

TEC STORE
1343 PEACH DRIVE
PHONE: 877-6437

Thank you
Call again

10-01-85 #123456

X

Tomato	8	
101*	\$1.34	
Potato	2	
102*	\$2.80	
Apple	1	
201*	\$0.32	
TOTAL	11	
	\$4.46	

0108 13:29

Mode Lock: X

[Start PLU Code] **[@/FOR]**

[End PLU Code] **[PLU]**

ex.) in this case:

101 **[@/FOR]** 201 **[PLU]**

INDIVIDUAL DEPARTMENT READ

```

TEC STORE
1343 PEACH DRIVE
PHONE: 877-6437

Thank you
Call again

10-01-85 #123456

      X
VEGTBL  14
          5CU
          $20.54
FRUIT    3
          2CU
          $0.82
MEAT     20
          6CU
          $43.30
SUBTL    37
          $64.66
FISH     1
          1CU
          $3.00
DAIRY    1
          1CU
          $2.00
BAKERY   4
          3CU
          $14.40
SUBTL    6
          $19.40
BAKERY   4
          3CU
          $14.40
CANNED   0
          0CU
          $0.00
BOTLED   3
          2CU
          $6.30
SUBTL    7
          $20.70
TOTAL    50
          $104.76

0109 13:30
    
```

Mode Lock: X
 Depress the required
 Dept. Key. **ST** key
 may be depressed to
 obtain the subtotal.
AT/TL to end.

Dept.1 (VEGTBL) Item Count
 Customer Count / Total

Subtotal (= VEG + FRU + MEA)

Subtotal (= FIS + DAI + BAK)

Subtotal (= BAK + CAN + BOT)

Total Cus. Count and Amount of
 all Depts. read out on this
 report.

KEY OPERATION EXAMPLE
 (in this case)

DEPT 1 VEGETABLE

DEPT 2 FRUIT

DEPT 3 MEAT

ST

DEPT 4 FISH

DEPT 5 DAIRY

DEPT 6 BAKERY

ST

DEPT 6 BAKERY

DEPT 7 CANNED

DEPT 8 BOTTLED

ST

AT/TL

HOURLY READ

TEC STORE
 1343 PEACH DRIVE
 PHONE: 877-6437

Thank you
 Call again

10-01-85 #123456

X

-00:08	
-16:00	46
	11CU
	\$92.46
-23:00	

0110 13:30

Mode Lock: X
 Enter 10, depress **[AT/TL]**.

Up to 8:00 (No sales data recorded)
 8:00 to 16:00 / Item Count
 Customer Count
 Sales Total
 16:00 to 23:00 (No sales data recorded)

INDIVIDUAL CLERK READ

TEC STORE
 1343 PEACH DRIVE
 PHONE: 877-6437

Thank you
 Call again

10-01-85 #123456

X

JONES	
GS	52
	\$102.06
NS	46
	\$92.46
TOTAL	11CU
	\$90.35
CAID	\$29.27
CKID	\$41.70
MISCID	\$15.00
NEG1	\$9.60
NEG2	\$17.11
R/A	\$25.00
PO	\$36.00
LOAN	\$25.00
P.UP	\$10.00
IT/CUS	4.18
NS/CUS	\$8.21
NDSALE	3

JONES 0111 13:31

Mode Lock: X
 Set the required Clerk Key to its ON position (Clerk 1 "JONES" in this case)
 Enter 1, depress **[AT/TL]**. (The "1" here is the fixed number for reading any clerk, but not the Clerk ID Code.)

Clerk Name (or Clerk ID Code if no name has been programmed)
 Gross Sale Item Count
 Total
 Net Sale Item Count
 Total
 Total (= Cash Sales Total + All Other Medias Totals + PB Sales Total)
 Customer count / Total Amount

Cash-in-drawer
 Check-in-drawer
 Misc-in-drawer
 NEG 1 (NOTE 1)
 NEG 2 (NOTE 2)
 Received on Account Total
 Paid Out total
 Loan Total
 Pick-Up Total
 Sales Items per Customer
 Net Sales per customer
 No-sale Count

NOTE 1: NEG 1 = (Audaction)+(Item Corr on DP+)
 +(BTR DP-net)+(RTN)+(Neg.Mode)
 +(%- on Items)+(Returned Tax)

NOTE 2: NEG 2 = (%- on Sub-totals)+(Do11 Disc.)
 +(BTR Inside-sale)+(Item Corr &
 Void on Others)

AUTO READ OR RESET (Mode Lock: X for READ, or Z for RESET, depress AT/TL.)

AUTO READ

AUTO RESET

```

TEC STORE
1343 PEACH DRIVE
PHONE: 877-6437

Thank you
  Call again

10-01-85 #123456

  X
GT      $102.06
GS      52
        $102.06

VEGTBL  14
         5CU
         $20.54
FRUIT   3
         2CU
         $0.82
GF01    17
24%     $21.36

MEAT    20
         6CU
         $43.30
FISH    1
         1CU
         $3.00
DAIRY   1
         1CU
         $2.00
BAKERY  4
         3CU
         $14.40
GF02    26
69%     $62.70

CANNED  0
         0CU
         $0.00
BOTTLED 0
         0CU
         $0.00
DP24    0
         0CU
         $0.00
DP25    0
         0CU
         $0.00
    
```

← Read Symbol

Reset Symbol →

Z

Grand Total (non-resettable)

Gross Sale Item Count

Total

DEPARTMENT REPORT

Dept.1 Item Count (Dept.1 is named "VEGTBL" in this example.)

Customer Count

Sales Total

Dept.2

Group 1 (Dept.VEGTBL through Dept.FRUIT) Item Count

Sales Portion (%) to all Groups / Group Sales Total

Group 2 (Dept.MEAT through Dept.BAKERY)

Dept.24 (If a department has not been programmed with its alpha name, the Dept. Code is printed instead.)

-- To be continued --

-- Continued --

		FINANCIAL REPORT	
TAX1	\$2.10	Tax 1 Total	
NS	46	Net Sale Item Count	
	\$92.46	Total	
Z-	3	%- on Subtotal (or Group Subtotal depending on the option) Count	
	\$1.11	Total	
DISC	1	Dollar discount Count	
	\$1.00	total	
TOTAL	110U	Total (= Cash Sales + All Other Medias Sales + PB Sales) Customer Count	
	\$90.35	Total Amount	
CASH	30U	Cash Sales Customer Count	
	\$36.66	Total	
CHECK	10U	Check Sales Customer Count	
	\$9.70	Total	
Chg	30U	Charge Sales Customer Count	
	\$8.38	Total	
MISC	10U	Misc Sales Customer Count	
	\$19.60	Total	
R/A	3	Received-on-Account Count	
	\$25.00	Total	
PO	3	Paid-Out Count	
	\$36.00	Total	
CAID	\$6.27	Cash-in-drawer	
CKID	5	Check-in-drawer Count	
	\$44.70	Total	
MISCID	1	Misc-in-drawer Count	
	\$20.00	Total	
CORR	1	Item Correct (on DP+) Count	
	\$1.23	Total	
VOID	0	Void (on DP+) Count	
	\$0.00	Total	
MS VD	2	Item Corr and Void (on Other Items) Count	
	\$15.00	Total	
Z-	2	%- (on line items) Count	
	\$1.50	Total	
RTN	1	Returned Merchandise Item Count	
	\$2.30	Total	
-TAX	\$0.00	Returned Tax Total	
REG-	1	Negative Mode Count	
	\$4.57	Total	
TF TL	\$0.00	Transfer Total	
TF+GT	\$0.00	Transfer+ GT	
TF-GT	\$0.00	Transfer- GT	
TF+	\$0.00	Transfer+ Daily	
TF-	\$0.00	Transfer- Daily	
PBTL	30U	PB (Previous Balance) Customer Count	
	\$16.01	Sales total	
PBR/A	\$16.01	PB Received-on-Account Total	
PBCA	\$6.01	PB Cash Total	
PBCK	\$10.00	PB Check Total	
PBMS	\$0.00	PB Misc total	
PBPO	\$0.00	PB Paid-Out Total	
TXBL1	\$21.00	Taxable Total 1	
IT/CUS	4.18	Sales Item Count per Customer	
NS/CUS	\$8.21	Net Sales per Customer	
NOSALE	3	No-sale Count	
VALCTR	10	Validation Count	

-- To be continued --

-- Continued --

CLERK REPORT

JONES	
GS	52
	\$102.06
NS	46
	\$92.46
TOTAL	1100
	\$90.35
CAID	\$29.27
CKID	\$41.70
MISCID	\$15.00
NEG1	\$9.60
NEG2	\$17.11
R/A	\$25.00
PO	\$36.00
LOAN	\$25.00
P.UP	\$10.00
IT/CUS	4.18
NS/CUS	\$8.21
NOSALE	3
JONES 0112 13:33	

(Refer to the
INDIVIDUAL CLERK
READ sample
description.)

AUTO RESET only

JONES	
GS	52
	\$102.06
NS	46
	\$92.46
TOTAL	1100
	\$90.35
CAID	\$29.27
CKID	\$41.70
MISCID	\$15.00
NEG1	\$9.60
NEG2	\$17.11
R/A	\$25.00
PO	\$36.00
LOAN	\$25.00
P.UP	\$10.00
IT/CUS	4.18
NS/CUS	\$8.21
NOSALE	3
0000Z	
SMITH	
0000Z	
3CL	
0000Z	
4CL	
0000Z	
0001Z	
JONES 0113 13:34	

Auto Reset
Count

Other Clerks' Reset Counts

GT READ OR RESET REPORT (Mode Lock: any position. GT Lock: GTX for READ, or GTZ for RESET, depress AT/TL.)

GT READ

TEC STORE
 1343 PEACH DRIVE
 PHONE: 877-6437

 Thank you
 Call again

 10-01-85 #123456

GTX
GT \$102.06
GS 52
 \$102.06

VEGTBL 14
 5CU
 \$20.54
FRUIT 3
 2CU
 \$0.82
GP01 17
 24% \$21.36

MEAT 20
 6CU
 \$43.30
FISH 1
 1CU
 \$3.00
DAIRY 1
 1CU
 \$2.00
BAKERY 4
 3CU
 \$14.40
GP02 26
 69% \$62.70

CANNED 0
 0CU
 \$0.00
BOTTLES 0
 0CU
 \$0.00
DP24 0
 0CU
 \$0.00
DP25 0
 0CU
 \$0.00



NOTE: All the items here are found in "AUTO READ OR RESET" report sample description. Only the difference is that the totals and counters here printed out are the accumulated data for a certain period until a GT Reset Report is taken.

-- To be continued --

-- Continued --

TAX1	
	\$2.10
NS	46
	\$92.46
TOTAL	11CU
	\$90.35
CASH	3CU
	\$36.66
CHECK	1CU
	\$9.70
Ch9	3CU
	\$8.38
MISC	1CU
	\$19.60
R/A	3
	\$25.00
PO	3
	\$36.00
CAIO	
	\$6.27
TF TL	\$0.00
TF+BT	\$0.00
TF-BT	\$0.00
PBTL	
	\$16.01
PBR/A	
	\$16.01
PBPO	
	\$0.00
TXBL1	
	\$21.00
IT/CUS	4.18
NS/CUS	
	\$8.21
JONES	
GS	52
	\$102.06
NS	46
	\$92.46
TOTAL	11CU
	\$90.35
R/A	
	\$25.00
PO	
	\$36.00
IT/CUS	4.18
NS/CUS	
	\$8.21
JONES 0114 13:37	

GT RESET only

0001Z
JONES 0115 13:38

GT Reset Count

PROGRAMMING OPERATIONS IN "SET" MODE

TABLE OF CONTENTS

(PROGRAM ITEM)	(CONDITION) []	(PROG NO.)	(PAGE)
SYSTEM OPTION PROGRAMMING	AZ, GTZ	11	55
STORE NAME/MESSAGE AND COMMERCIAL MESSAGE PROGRAMMING			
.....	Anytime	1	66
CLERK NAME PROGRAMMING	Anytime	1	68
DEPARTMENT NAME AND STATUS PROGRAMMING	Anytime/AZ/AZ, GTZ, PLUZ	3	69
PLU TABLE PROGRAMMING OR CHANGING	PLUZ/Anytime	4	72
PLU TABLE DELETION	PLUZ	4	73
TIME SETTING	Anytime	5	75
DATE SETTING	Anytime	6	75
HOURLY RANGE SETTING	HZ	7	76
DEPARTMENT LISTING CAPACITY SETTING	AZ	8	77
FINANCIAL TOTAL NAME PROGRAMMING OR CHANGING ..	AZ, GTZ	9	79
PRINT ITEM NAME PROGRAMMING OR CHANGING	Anytime	10	82
NON-TAXABLE AMOUNT LIMIT SETTING	AZ, GTZ	12	84
SPECIAL CHARACTER GENERATION TABLE PROGRAMMING.	Anytime	13	85
DEPARTMENT GROUP PROGRAMMING OR CHANGING	Anytime	14	87
DEPARTMENT PRESET PRICE SETTING OR CHANING	Anytime	88
PLU PRESET PRICE CHANGING	Anytime	89
TENDER LISTING CAPACITY SETTING	AZ	90
[%+] AND [%-] PRESET RATE SETTING	Anytime	91
STORE REGISTER NO. SETTING	AZ, GTZ	91
TAX TABLE RPROGRAMMING	AZ, GTZ	92

NOTE []: Anytime = Anytime outside a sale PLUZ = After PLU Reset
 AZ = After Auto Reset HZ = After Hourly Reset
 GTZ = After GT Reset

OTHER REFERENCES RELATED TO PROGRAMMING OPERATIONS

CHARACTER CODE TABLE	96
PROGRAMMING OPERATIONS IN "MGR" MODE (MANAGER'S PROGRAMMING)	95
PROGRAMMING OPERATIONS THROUGH THE PROGRAMMING KEYBOARD (optional)	97
VERIFICATION OF PROGRAMMED DATA	100

SYSTEM OPTION PROGRAMMING

CONDITION: After Auto Reset and GT Reset

OPERATION: Mode Lock: BLIND or SET

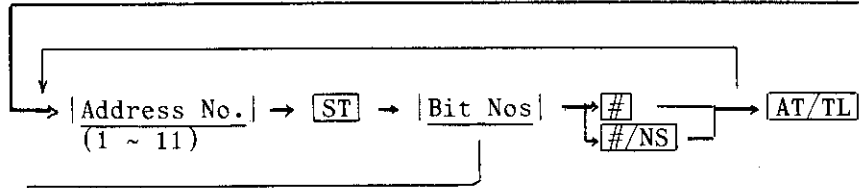
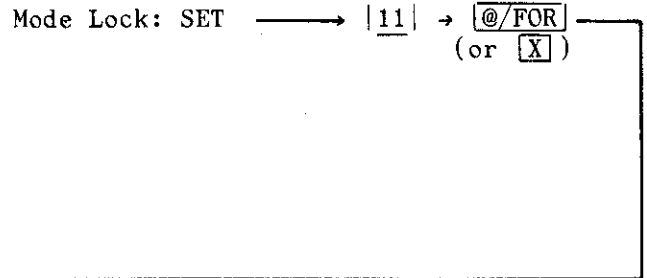

Enter a maximum of eight-digit number composed of Bit Nos whose status must be set to the "SET" status. If there is no Bit No. to be set to the "SET" status in an Address No., enter "0".

- ex.) To set Bit No.2 only Enter 2.
- To set Bits No.2 and No.3 Enter 23.
- To set all the Bit Nos Enter 12345678.
- To reset all the Bit Nos Enter 0.

- NOTES:**
1. Any Bit No. with the "--vacant--" item will be disregarded even if it is set. (However, if ever set, it will not result in an error.)
 2. When the product is delivered to the customer, each Address # has already been set with proper Options Nos according to the customer's requirements. Therefore, it is recommended to read out the programmed data of the SYSTEM OPTION first (refer to page 117) and next do this programming operation only for the Addresses that require option change.

ex.) To set the following options:

Address #1 Table (refer to the next page.)
 Bit No.1 Time NON-PRINT (SET status)
 No.3 Sub-total NON-PRINT (SET status)
 Other Bit Nos will be selected to "RESET" status:

Mode Lock to SET, enter 11, depress [@/FOR] .

Enter 1 (Address No.), depress [ST] .
 Enter 13 (Option Nos for SET), depress [#] .

Depress [AT/TL] to end.

02-11-00 #0		
#01	F 11	13
	0005	

SYSTEM OPTION TABLES

ADDRESS NO.	CONTENTS		Standard Bit Set		
1	NON-PRINT OPTION		<div style="border: 1px solid black; padding: 2px;"> 6 </div>		
BIT NO.	ITEM	SELECTIVE STATUS		STANDARD STATUS	REMARKS
1	Time Print (on Sales Receipt, Report, Prog.Receipt)	RESET	PRINT	*	
		SET	NON-PRINT		
2	Item Count Print (on Sales Receipt)	RESET	PRINT	*	
		SET	NON-PRINT		
3	Sub-total Print (on Receipt & Journal)	RESET	PRINT	*	Will print Sub-total Amount on a depression of <u>[ST]</u> key.
		SET	NON-PRINT		
4	PLU Total Amounts on PLU Reports	RESET	PRINT	*	Will print Item Counts only.
		SET	NON-PRINT		
5	Customer Counts of Departments on Reports	RESET	PRINT	*	
		SET	NON-PRINT		
6	Department Sales Ratio Print on Reports	RESET	PRINT	*	Instead, Department Customer Counts will not be printed.
		SET	NON-PRINT		
7	--vacant--	RESET			
		SET			
8	--vacant--	RESET			
		SET			

ADDRESS NO.	CONTENTS
2	OPTIONAL FUNCTION 1

Standard Bit Set



BIT NO.	ITEM	SELECTIVE STATUS		STANDARD STATUS	REMARKS
1	1 Fraction Rounding: ROUND UP	RESET	Follow Bit No.2 Status	*	-If both "RESET", it will be ROUND OFF. (If both "SET", it will be DISCARD.)
		SET	ROUND UP		
2	2 Fraction Rounding: DISCARD	RESET	Follow Bit No.1 status	*	
		SET	DISCARD		
3	--vacant--	RESET			
		SET			
4	Split Package Pricing Fraction Rounding	RESET	Round Up Product	*	
		SET	Round Up Unit Price		
5	--vacant--	RESET			
		SET			
6	--vacant--	RESET			
		SET			
7	--vacant--	RESET			
		SET			
8	--vacant--	RESET			
		SET			

NOTE 1 2: The selective status of the fraction rounding here applies to quantity extension and % calculations, but not to tax calculations. The fraction resulted from any tax % calculations will be rounded off (no alternative rounding method is provided for this).

ADDRESS NO.	CONTENTS
3	OPTIONAL FUNCTION II

Standard Bit Set

BIT NO.	ITEM	SELECTIVE STATUS		STANDARD STATUS	REMARKS
		RESET	PROHIBITED		
1	Credit Balance in "REG" mode	RESET	PROHIBITED	*	
		SET	ALLOWED		
2	Drawer Open on X, Z Reports and GTX, GTZ Reports	RESET	OPEN	*	
		SET	NOT OPEN		
3	Time Display when Mode Lock is in the "LOCK" mode.	RESET	DISPLAYED	*	on the Front Display only
		SET	NOT DISPLAYED		
4	--vacant--	RESET			
		SET			
5	--vacant--	RESET			
		SET			
6	--vacant--	RESET			
		SET			
7	--vacant--	RESET			
		SET			
8	--vacant--	RESET			
		SET			

NOTE I: "Credit Balance" means that a sale total is negative through entering larger negative amounts (through DOLL DISC key) than positive amounts. If status "SET" is selected, a negative sale total may be finalized. The use of the DOLL DISC key outside a sale is also allowed in this case. The RTN MDSE is not subject to this option selection. Any sale containing amounts entered through the RTN MDSE key may be finalized even if the sale total is negative.

ADDRESS NO.	CONTENTS
4	VALIDATION COMPULSORY I

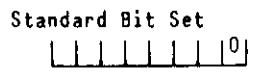

BIT NO.	ITEM	SELECTIVE STATUS		STANDARD STATUS	REMARKS
		RESET	FREE		
1	[RTN MDSE] Key	RESET	FREE	*	
		SET	COMPULSORY		
2	[PO] Key	RESET	FREE	*	
		SET	COMPULSORY		
3	[R/A] Key	RESET	FREE	*	
		SET	COMPULSORY		
4	¹ [ITEM CORR] Key	RESET	FREE	*	
		SET	COMPULSORY		
5	² [VOID] Key	RESET	FREE	*	
		SET	COMPULSORY		
6	New Balance in Post Charging	RESET	FREE	*	
		SET	COMPULSORY		
7	--vacant--	RESET			
		SET			
8	--vacant--	RESET			
		SET			

NOTE: If status "COMPULSORY" is selected, the "SLIP" lamp will flash after operating the key, and thereafter no other operation except validation printing will be allowed. This status will be effective in the "REG" and "MGR" modes only. In the "[]" mode, validation printing may be performed freely (not compulsory) after any function key regardless of the FEE/COMPULSORY status selected for each key in the above table.

¹: The selection of Bit No.4 will also be applied to the [IC/VD] key when it is used as the ITEM CORRECT key.

²: The selection of Bit No.5 will also be applied to the [IC/VD] key when it is used as the VOID key.

ADDRESS NO.	- CONTENTS
5	VALIDATION COMPULSORY II

Standard Bit Set



BIT NO.	ITEM	SELECTIVE STATUS		STANDARD STATUS	REMARKS
		RESET	FREE		
1	DOLL DISC	RESET	FREE	*	
		SET	COMPULSORY		
2	%-	RESET	FREE	*	
		SET	COMPULSORY		
3	Negative Departments and PLUs	RESET	FREE	*	
		SET	COMPULSORY		
4	BTL RTN	RESET	FREE	*	
		SET	COMPULSORY		
5	--vacant--	RESET			
		SET			
6	--vacant--	RESET			
		SET			
7	--vacant--	RESET			
		SET			
8	--vacant--	RESET			
		SET			

NOTE: See the "NOTE" on the previous page.

ADDRESS NO.	CONTENTS
6	MGR-REQUIREMENT I

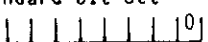
Standard Bit Set

BIT NO.	ITEM	SELECTIVE STATUS		STANDARD STATUS	REMARKS
		RESET	FREE		
1	[RTN MDSE]	RESET	FREE	*	
		SET	REQUIRED		
2	[PO]	RESET	FREE	*	
		SET	REQUIRED		
3	[VOID]	RESET	FREE	*	
		SET	REQUIRED		
4	--vacant--	RESET			
		SET			
5	[EX]	RESET	FREE	*	
		SET	REQUIRED		
6	Negative Sale Finalization by Media 1 - Media 5 Keys	RESET	FREE	*	[AT/TL] Key can always finalize a negative sale regardless of this option status.
		SET	REQUIRED		
7	--vacant--	RESET			
		SET			
8	--vacant--	RESET			
		SET			

NOTE: If the status "REQUIRED" is selected, the key can not be used in the "REG" mode. It may only be used in the "MGR" or "[]" position of the Mode Lock.

Ⓜ: The status selection of Bit No.3 will also be applied to the [IC/VD] key when it is used as the VOID key.

ADDRESS NO.	CONTENTS
7	MGR REQUIREMENT II

Standard Bit Set



BIT NO.	ITEM	SELECTIVE STATUS		STANDARD STATUS	REMARKS
		RESET	FREE		
1	DOLL DISC	RESET	FREE	*	
		SET	REQUIRED		
2	%-	RESET	FREE	*	
		SET	REQUIRED		
3	Negative Departments and PLUs	RESET	FREE	*	
		SET	REQUIRED		
4	BTL RTN	RESET	FREE	*	
		SET	REQUIRED		
5	--vacant--	RESET			
		SET			
6	--vacant--	RESET			
		SET			
7	--vacant--	RESET			
		SET			
8	--vacant--	RESET			
		SET			

ADDRESS NO.	CONTENTS
8	TAX STATUS

Standard Bit Set



BIT NO.	ITEM	SELECTIVE STATUS		STANDARD STATUS	REMARKS
		RESET	NON-TAXABLE		
1	%+	RESET	NON-TAXABLE	*	
		SET	TAXABLE		
2	% -	RESET	NON-TAXABLE	*	
		SET	TAXABLE		
3	DOLL DISC	RESET	NON-TAXABLE	*	
		SET	TAXABLE		
4	BTL RTN (Inside Sale or Department-linked Key)	RESET	NON-TAXABLE	*	
		SET	TAXABLE		
5	--vacant--	RESET			
		SET			
6	--vacant--	RESET			
		SET			
7	--vacant--	RESET			
		SET			
8	--vacant--	RESET			
		SET			

NOTE: BTL RTN (when used as Department-linked Key) and %+ on line items:

RESET (NON-TAXABLE) : Non-taxable regardless of the Department Tax status

SET (TAXABLE) : Taxable or Non-taxable depending on the Department Tax status.

ADDRESS NO.	CONTENTS
9	TAX 2 STATUS

Standard Bit Set
 0

BIT NO.	ITEM	SELECTIVE STATUS		STANDARD STATUS	REMARKS
		RESET	NON-TAXABLE		
1	%+	RESET	NON-TAXABLE	*	
		SET	TAXABLE		
2	%−	RESET	NON-TAXABLE	*	
		SET	TAXABLE		
3	DOLL DISC	RESET	NON-TAXABLE	*	
		SET	TAXABLE		
4	BTL RTN (Inside Sale or Department-linked Key)	RESET	NON-TAXABLE	*	
		SET	TAXABLE		
5	--vacant--	RESET			
		SET			
6	--vacant--	RESET			
		SET			
7	--vacant--	RESET			
		SET			
8	--vacant--	RESET			
		SET			

NOTE: See the "NOTE" on the previous page. The same content is applied except that "Taxable or Non-taxable" is subject to the TAX 2 STATUS on this page.

ADDRESS NO.	CONTENTS
10	REMOTE SLIP CONTROL

Standard Bit Set
 [] [] [] [] [] [] [] [] [] []

BIT NO.	ITEM	SELECTIVE STATUS		STANDARD STATUS	REMARKS
1	Print Form (Left/Right Position)	RESET	ALL ON RIGHT SIDE	*	
		SET	1 SOME ON LEFT SIDE		
2	Print All Items or New Balance	RESET	ALL ITEMS	*	
		SET	NEW BALANCE ONLY 4		
3	Single or Double Slip Print for Total Amount	RESET	SINGLE SLIP	*	Prints Total only once(normal).
		SET	DOUBLE SLIP 3		Prints Total twice with line space inbetween.
4	2 Other Items Double Print in Double Slip Spec.	RESET	NON PRINT	*	This Bit status selection is effective only when Bit No.3 is selected to "SET" status.
		SET	PRINT		
5	--vacant--	RESET			
		SET			
6	--vacant--	RESET			
		SET			
7	--vacant--	RESET			
		SET			
8	--vacant--	RESET			
		SET			

NOTES 1: If status "SET" (SOME ON LEFT SIDE) is selected, items entered through Departments, PLUs, [%+], [%-], and [DOLL DISC] keys will be printed on the left side. All other items will be printed on the right side.

2: "Other Items" indicate Date, Register No., Clerk ID, Consecutive No., and Time. If status "SET" is selected, all these items will also be printed twice along with the total amount.

3: For a PB (previous balance) entry, the total will only be printed once as in the normal specification even if status "SET (DOUBLE SLIP)" has been selected for this bit.

4: If status "SET" (NEW BALANCE ONLY) is selected, the new balance in charge posting operation will be printed on the remote slip. No other items will be printed even in a normal sale without a previous balance.

-- Address No.11 is vacant. --

STORE NAME/MESSAGE AND COMMERCIAL MESSAGE PROGRAMMING

CONDITION: Any time outside a sale

OPERATION: Mode-Lock: SET or MGR

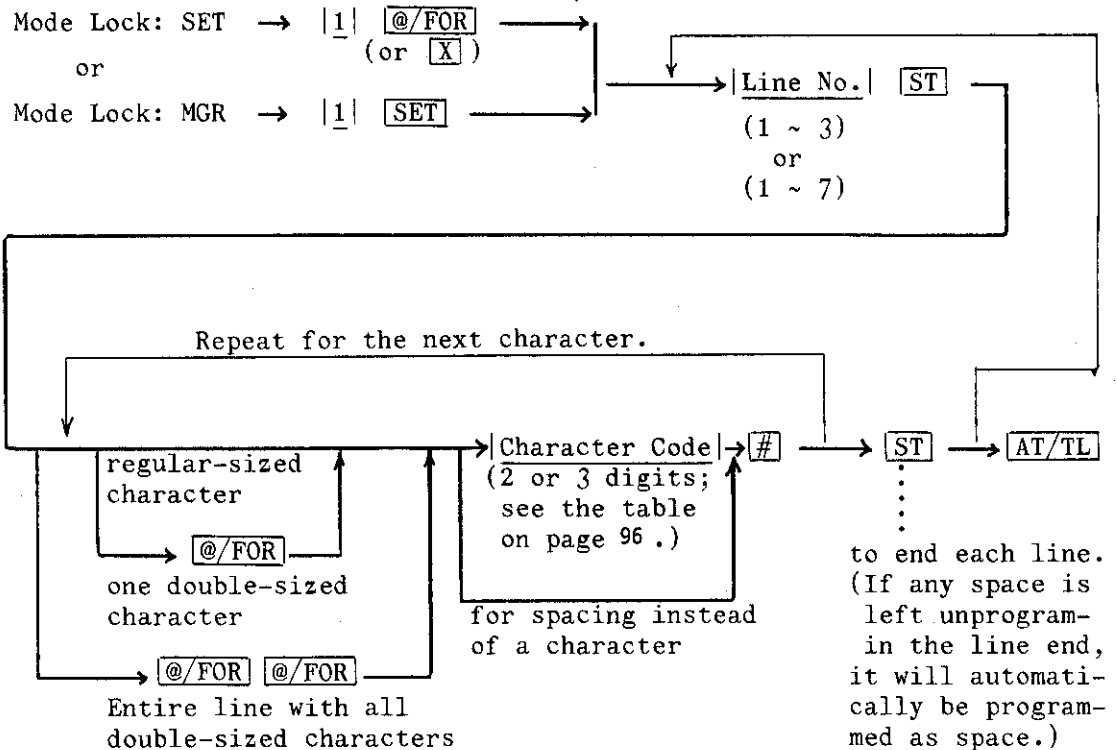

- NOTES:**
1. The # key after the Character Code entry may be replaced by the #/CID or #/NS key.
 2. For one line, a maximum of 16 regular-sized characters or 8 double-sized characters may be entered. A combination of both types is also available.
 3. If "Store Name/Message FIXED" is selected in the system option, no data can be programmed for the store name/message (and the store name stamp will be printed instead); therefore, enter 1 through 3 for each line of commercial message. If "Store Name/Message PROGRAMMABLE" is selected in the system option, enter 1 through 4 for the store name/message and 5 through 7 for the commercial message.
 4. If no commercial message is required on the receipt, program all space for all the three lines. Then no message will be printed and no extra line space will be fed. If any one of the three lines is ever programmed, the two other lines will remain programmed with space and will turn out to be extra space lines to be fed on the receipt.
 5. The 4-line space assigned for the store name/message will be either printed (if programmed) or fed (if all space is programmed), but will never be shortened when a receipt is issued, as long as "Store Name/Message PROGRAMMABLE" status is selected in the system option.

ex.) To program the following draft as the Store Name/Message and Commercial Message: (under the "STORE NAME/MESSAGE PROGRAMMABLE" option)

	T E C S T O R E		(T, E, C, and S
DRAFT:	1 3 4 3 P E A C H D R I V E	Line No.1	are double-sized)
	PH O N E : 8 7 7 - 6 4 3 7	Line No.2	
		Line No.3	
		Line No.4	
	T h a n k y o u	Line No.5	
	C a l l a g a i n	Line No.6	
		Line No.7	

OPERATION: Mode Lock to SET, enter 1, depress . (= @/FOR)
(sp = space)

1 ST (Line No.1)
30# 15# 13# # #
 (sp) (T) (E) (C) (sp)(sp)
29# 30# 25# 28# 15# ST
 (S) (T) (O) (R) (E)

2 ST (Line No.2)
 1# 3# 4# 3# # 26# 15# 11#
 (1) (3) (4) (3) (sp) (P) (E) (A)
 13# 18# # 14# 28# 19# 32#
 (C) (H) (sp) (D) (R) (I) (V)
 15# ST
 (E)

3 ST (Line No.3)
 # 26# 18# 25# 24# 15# 102#
 (sp) (P) (H) (O) (N) (E) (:)
 # 8# 7# 7# 99# 6# 4# 3#
 (sp) (8) (7) (7) (-) (6) (4) (3)
 7# ST
 (7)

5 ST (Line No.5)
 30# 118# 111# 124# 121# #
 (T) (h) (a) (n) (k) (sp)
 135# 125# 131# ST
 (y) (o) (u)

6 ST (Line No.6)
 # # # # # 13# 111# 122#
 ← sp → (C) (a) (l)
 122# # 111# 117# 111# 119#
 (l) (sp) (a) (g) (a) (i)
 124# ST
 (n)

AT/TL to end

02-11-00 #0

P 01

1
TEC STORE

2
1343 PEACH DRIVE

3
PHONE: 877-6437

5
Thank you

6
Call again

0013 22:40

NOTE:

If any data have already been programmed on any line but all space should be programmed on it, the data must be cleared by inputting space. (In this example, it is presumed that Lines No.4 and No.5 have no data pre-programmed.)

CLERK NAME PROGRAMMING

CONDITION: Any time outside a sale

OPERATION: Mode Lock: SET or MGR

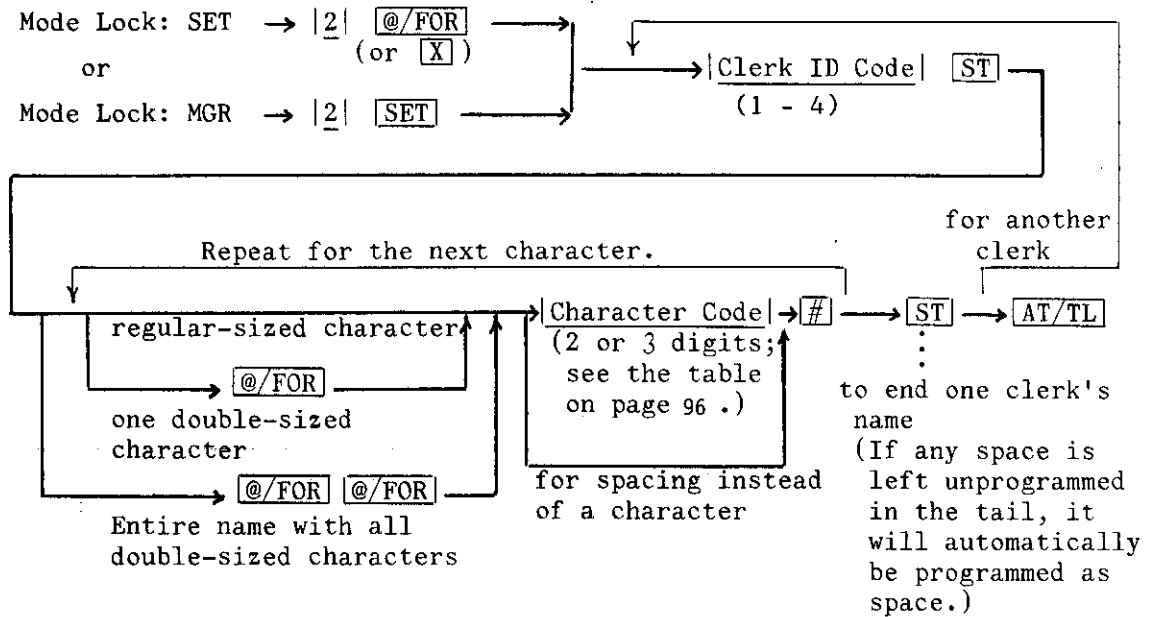

- NOTES:**
1. The # key after the Character Code entry may be replaced by the #/CID or #/NS key.
 2. For the name of one clerk, a maximum of 6 regular-sized characters or 3 double-sized characters may be entered. A combination of both types is also available.

ex.) To program "JONES" for Clerk 1,
"SMITH" for Clerk 2:

Mode Lock: SET, enter 2, depress /@/FOR.

Enter 1, depress ST (Clerk ID Code).

Enter 20, depress # (J).

" 25, " " (O).

" 24, " " (N).

" 15, " " (E).

" 29, " " (S).

Depress ST (to end Clerk 1).

Enter 2, depress ST (Clerk ID Code).

Enter 29, depress # (S).

" 23, " " (M).

" 19, " " (I).

" 30, " " (T).

" 18, " " (H).

Depress ST (to end Clerk 2).

Depress AT/TL to end this program.

TEC STORE	
1343 PEACH DRIVE	
PHONE: 877-6437	
Thank you	
Call again	
02-11-00 #0	
P 02	
1CL	JONES
2CL	SMITH
0014 22:49	

DEPARTMENT NAME AND STATUS PROGRAMMING OR CHANGING

CONDITION: To change the Department Name only: Any time outside a sale
 To change the Department Tax Status: After Auto Reset
 To change the Department Positive/Negative Status:
 After an Auto Reset,
 GT Reset, and PLU Reset

OPERATION: Mode Lock: SET

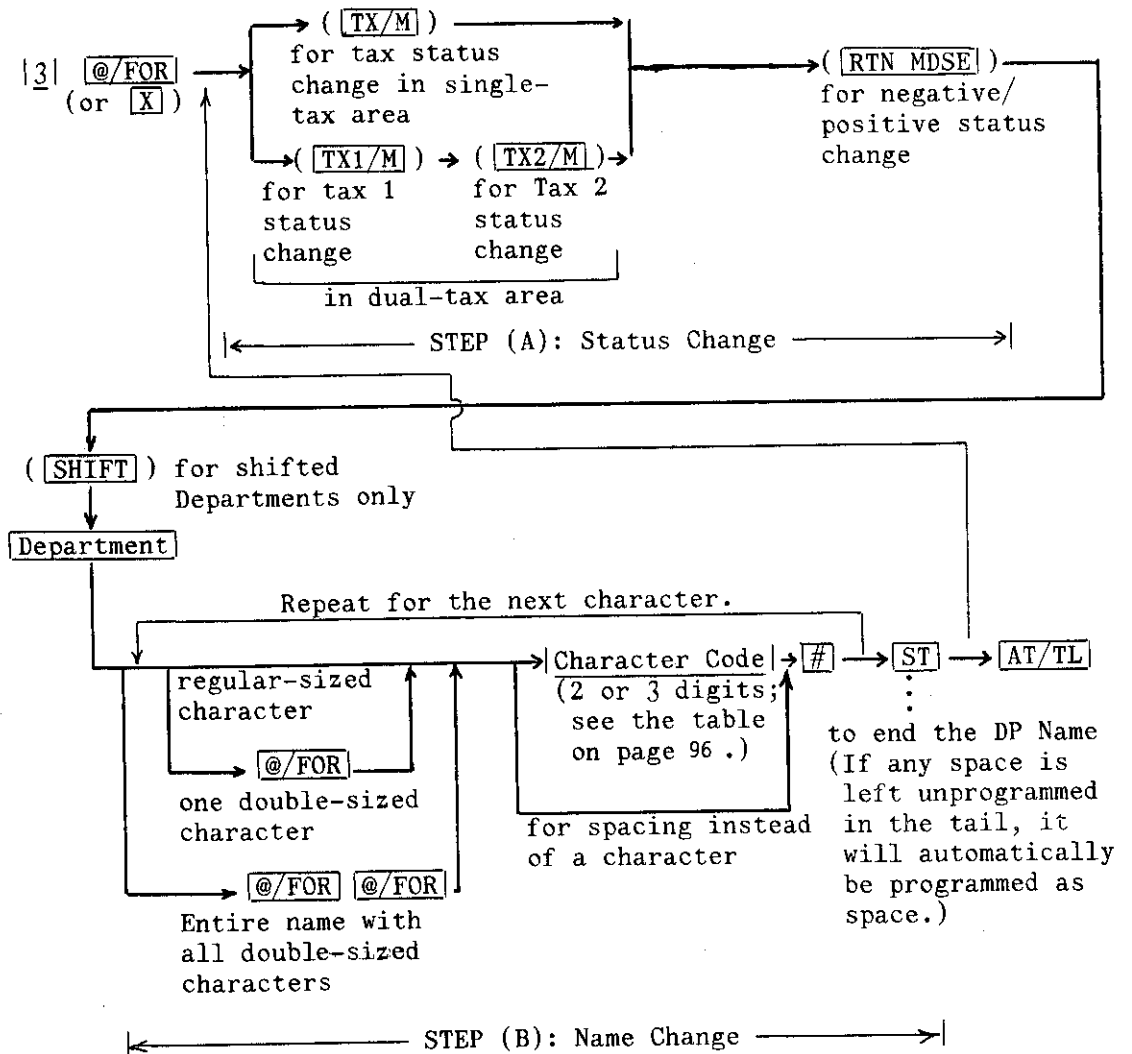

- NOTES:**
- The "**Department**" is the Department Key whose status or name should be changed or programmed in this operation. The **(SHIFT)** and **Department** depressions will result in operating the shifted department. For example, **(SHIFT)** and **Dept. 1** will be **Dept.31**.
 - The **#** key after the Character Code entry may be replaced by the **#/CID** or **#/NS** key.
 - For the name of a department, a maximum of 6 regular-sized characters or 3 double-sized characters may be entered. A combination of both types is also available.

4. When only the name is programmed or changed but not the status, STEP (A) may be skipped in the above operation. Likewise, when only the status is programmed or changed but not the name, STEP (B) may be skipped.
5. Among TX1/M (TX/M), TX2/M, depress the key(s) for the required status change(s) for each department. The RTN MDSE is depressed to set or reset the negative department status.
6. Depressing any of the three keys above, the related status reverses. For example, depressing the TX/M reverses a non-taxable department to a taxable, or taxable to non-taxable. Each department status is read by the number indicated in the AMOUNT portion of the display when each department key is depressed in the above operation. The numbers and their respective statuses are:

0: Non-taxable
 1: Tax 1 taxable only
 2: Tax 2 taxable only
 3: Tax 1 and Tax 2
 both taxable

"(-)" Lamp lit: negative
 "(-)" Lamp unlit:
 positive
 (This status is reversed
 by the RTN MDSE key.)

Watching the number, adjust the status by depressing these keys. See the examples below:

<u>STATUS NUMBER BEFORE CHANGE</u>	<u>KEY-IN FOR CHANGE PRIOR TO Dept KEY</u>	<u>NEW NUMBER AND STATUS OBTAINED</u>
0	→ <u>TX/M</u>	→ 1(Tax1 only)
0	→ <u>TX1/M</u> <u>TX2/M</u>	→ 3(Tax1 and Tax2)
0	→ <u>TX1/M</u> <u>SI/M</u>	→ 5(Tax1 and S.I.)
	⋮	
	etc.	
1	→ <u>TX1/M</u>	→ 0(Non-txbl)
1	→ <u>TX2/M</u>	→ 3(Tax1 and Tax2)
1	→ <u>TX1/M</u> <u>TX2/M</u>	→ 2(Tax2 only)
	⋮	
	etc.	
2	→ <u>TX2/M</u>	→ 0(Non-txbl)
3	→ <u>TX1/M</u> <u>TX2/M</u>	→ 0(Non-txbl)
	⋮	
	etc.	

In order to simplify the status setting operation, each department status may be reset to "0" by entering "0" and depressing the department key. (This can only be done after Auto Reset, GT Reset, and PLU Reset.) Then the required status is set simply by depressing the keys TX1/M (TX/M), and/or TX2/M only once.

ex.) To program the following status and name for each department:

<u>DEPT CODE</u>	<u>TAX STATUS</u> (Single-tax area)	<u>POSI/NEGA STATUS</u>	<u>NAME</u>
Dept. 1	Non-taxable	Positive	VEGTBL (for Vegetables)
Dept. 2	Non-taxable	Positive	FURIT
Dept. 3	Non-taxable	Positive	MEAT
Dept. 4	Non-taxable	Positive	FISH
Dept. 5	Non-taxable	Positive	DAIRY
Dept. 6	Taxable	Positive	BAKERY
Dept. 7	Taxable	Positive	CANNED (for Bottled Foods)
Dept. 8	Taxable	Positive	BOTLED (for Canned Foods)
Dept. 9	Taxable	Positive	DRINK
Dept.10	Taxable	Positive	OTHERS

KEY OPERATION (Presumed that the status has been reset to "0" and no name has been pre-programmed for each Dept.)

Mode Lock to SET, enter 3, depress /FOR (or).

Depress DEPT 1.

Enter 32, depress . (V)

" 15, " " . (E)

" 17, " " . (G)

" 30, " " . (T)

" 12, " " . (B)

" 22, " " . (L)

Depress ST to end the name.

⋮

Depress TX/M and then depress DEPT 6.

Enter the character codes as shown in the DEPT 1 case.

⋮

Depress AT/TL to end this program.

TEC STORE
1343 PEACH DRIVE
PHONE: 877-6437

Thank you
Call again

02-11-00 #0

P 03

01	VEGTBL	
02	FRUIT	
03	MEAT	
04	FISH	
05	DAIRY	
06	BAKERY	1
07	CANNED	1
08	BOTLED	1
09	DRINK	1
10	OTHERS	1

0016 22:54

PLU TABLE PROGRAMMING OR CHANGING

CONDITION: After a PLU Reset to renew the PLU table, or any time outside a sale to program additional PLUs or to change the PLU name only.

OPERATION: Mode Lock: SET

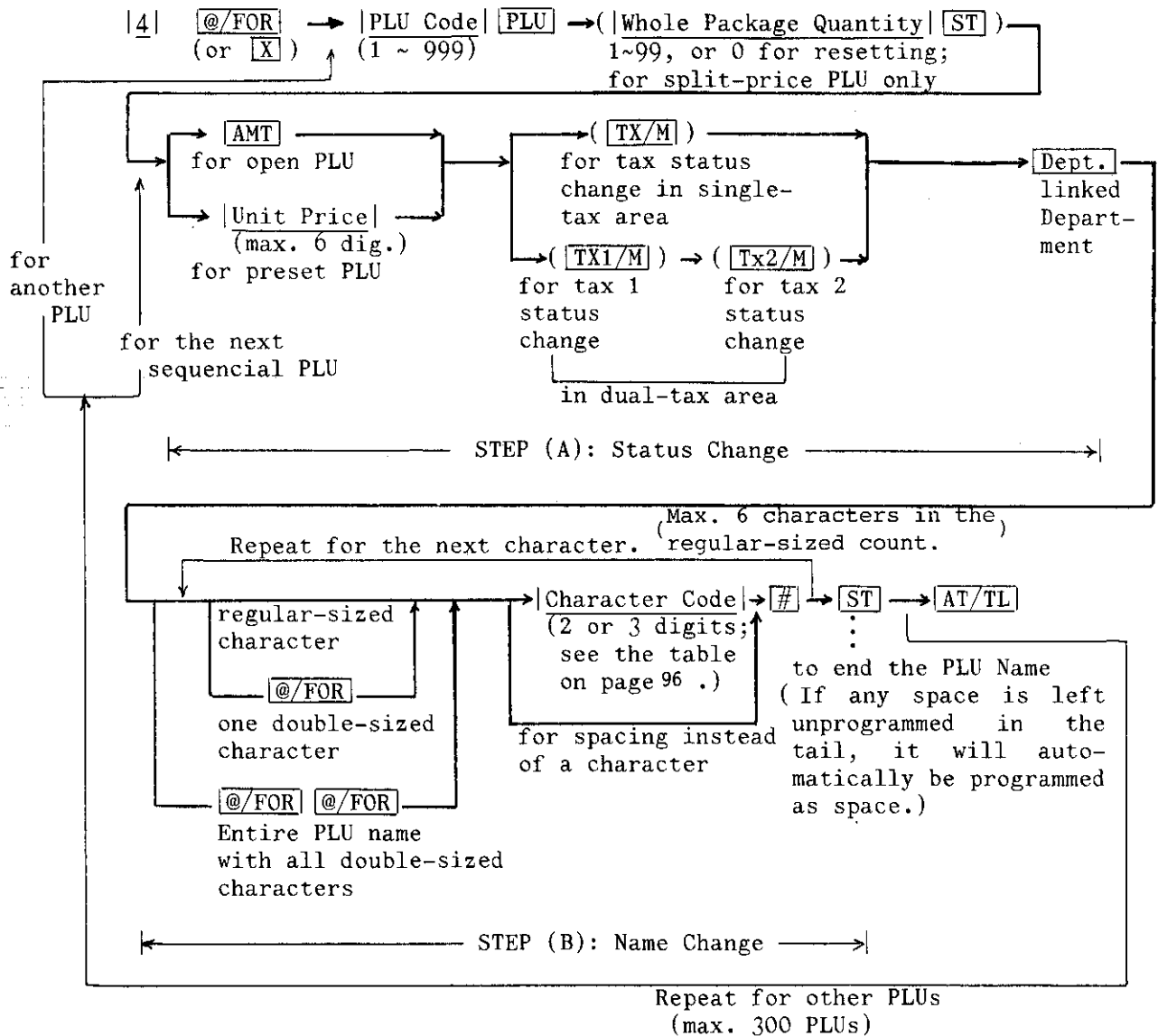

- NOTES:**
- The "`|PLU Code| PLU`" entry may be skipped if the PLU Code is sequential from the previous PLU's code. If this PLU code entry is skipped at the very first PLU, the PLU code will automatically be programmed as PLU No.1.
 - As for the tax status change refer to the description in NOTE 6 (page 70) which is attached to the "DEPARTMENT NAME AND STATUS PROGRAMMING OR CHANGING" operation. Each PLU's tax status is programmed independently from that of the linked department. However, the positive/negative status of a PLU is ruled by that of its linked department.

3. STEP (A) may be skipped if the PLU name only is programmed or changed. Likewise, STEP (B) may be skipped if the PLU price, the tax status, and/or linked department only are changed.
4. Depress the **SHIFT** key prior to the department key only when the linked department is a shifted department (i.e. Dept. 16 through Dept. 30 that will be shifted from Dept. 1 through Dept. 15 by the **SHIFT** key depression).

PLU TABLE DELETION

CONDITION: After a PLU Reset

OPERATION: Mode Lock: SET

|4| → **@/FOR** (or **X**)

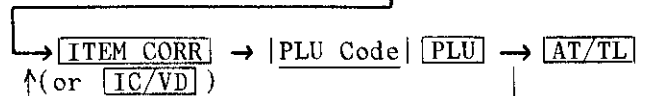

Repeat for another PLU to be deleted.

- NOTES:**
1. Deletion is possible with each PLU code, one by one. Deleting of all the PLUs at once is not possible.
 2. There is one way to delete all the PLUs at once. That is, to close to **PLU** key in the SFKC programming operation.

ex.) To delete PLU No.101, No.102, and No.202 that have once been programmed:

Mode Lock to SET, enter 4, depress **@/FOR**.

Depress **ITEM CORR**, enter 101, depress **PLU**.

Depress **ITEM CORR**, enter 102, depress **PLU**.

Depress **ITEM CORR**, enter 202, depress **PLU**.

Depress **AT/TL** to end.

TEC STORE
 1343 PEACH DRIVE
 PHONE: 877-6437

Thank you
 Call again

02-11-00 #0

P 04

PLU101

 PLU102

 PLU202

000

0020 23:07

ex.) To program the following PLUs:

PLU CODE	WHOLE PACKAGE QUANTITY	UNIT PRICE or WHOLE PACKAGE PRICE	TAX STATUS	LINKED NAME DEPT.
101	6	\$1.00	Non-taxable	01 Tomato
102		\$1.20	Non-taxable	01 Potato
201	5	\$1.50	Non-taxable	02 Apple
202	6	\$1.49	Non-taxable	02 Orange
301		open	Non-taxable	03 Beef
302		open	Non-taxable	03 Pork
501		\$2.00	Non-taxable	05 Cheese
502		\$2.20	Non-taxable	05 Butter
601		\$1.30	Taxable	06 WhiBrd (White Bread)
602		\$1.10	Taxable	06 RyeBrd (Rye Bread)
603		\$0.50	Taxable	06 HaRoll (Hard Roll)
604		\$0.40	Taxable	06 SoRoll (Soft Roll)
901		\$0.25	Taxable	09 7-up
902		\$0.25	Taxable	09 Coke

KEY OPERATION (presumed that no program data have been set to any PLUs before.) (Single-tax Area)

Mode Lock to SET, enter 4, depress **[@/FOR]**.

Enter 101 (PLU Code), depress **[PLU]**.

Enter 6 (Whole Package Q'ty), depress **[ST]**.

Enter 100 (price), depress **[DEPT 1]**.

Enter 30, depress **[#]**. (T)

" 125, " " . (o)

" 123, " " . (m)

" 111, " " . (a)

" 130, " " . (t)

" 125, " " . (o)

Depress **[ST]** to end the name.

⋮

Enter 301 (PLU Code), depress **[PLU]**.

Depress **[AMT]** (for open price), depress **[DEPT 3]**.

Enter the character codes for "Beef" as shown for "Tomato" in PLU 101 above.

⋮

Enter 601 (PLU Code), depress **[PLU]**.

Enter 130 (price), depress **[TX/M]**, depress **[DEPT 6]**.

Enter the character codes for "WhiBrd" as shown for "Tomato" in PLU 101 above.

⋮

Depress **[AT/TL]** to end.

TEC STORE
1343 PEACH DRIVE
PHONE: 877-6437

Thank you
(Call again)

02-11-00 #0

P 04

PLU101 01 00
1.00 / 6

PLU101 Tomato
PLU102 01 00
1.20

PLU102 Potato
PLU201 02 00
1.59 / 5

PLU201 APPLE
PLU202 02 00
1.49 / 6

PLU202 Orange
PLU301 03 00

PLU301 Beef
PLU302 03 00

PLU302 Pork
PLU501 05 00
2.00

PLU501 Cheese
PLU502 05 00
2.20

PLU502 Butter
PLU601 06 01
1.30

PLU601 WhiBrd
PLU602 06 01
1.10

PLU602 RyeBrd
PLU603 06 01
0.50

PLU603 HAROLL
PLU604 06 01
0.40

PLU604 SoROLL
PLU901 09 01
0.25

PLU901 7-up
PLU902 09 01
0.25

PLU902 COKE

014

0021 23:10

TIME SETTING

CONDITION: Any time outside a sale

OPERATION: Mode Lock: SET or MGR

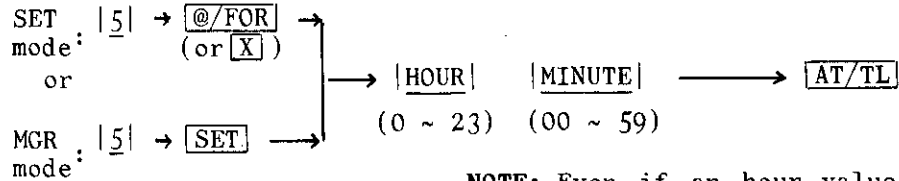

NOTE: Even if an hour value of more than 23 or a minute value of more than 59 is entered, it will not result in an error. In this case, do the setting operation over again with the correct values.

ex.) To set the time "11:04":

Mode Lock to SET, enter 5, depress @/FOR

Enter 1104, depress AT/TL.

TEC STORE
1343 PEACH DRIVE
PHONE: 877-6437

Thank you
Call again

03-16-85 #0

P 05
11:04

0030 11:04

DATE SETTING

CONDITION: Any time outside a sale

OPERATION: Mode Lock: SET

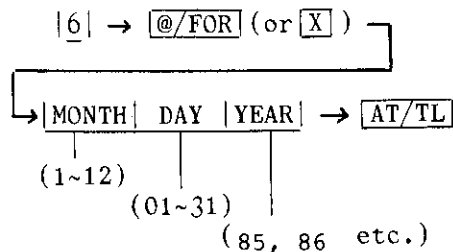

NOTE: The date entry order may be DAY-MONTH-YEAR instead of MONTH-DAY-YEAR, by system option, Address No.28.

ex.) To set the date "Oct. 1st, 1985":

Mode Lock to SET, enter 6, depress @/FOR.

Enter 1 0 0 1 8 5 depress AT/TL.

TEC STORE
1343 PEACH DRIVE
PHONE: 877-6437

Thank you
Call again

03-16-85 #0

P 06
10-01-85

0031 11:04

HOURLY RANGE SETTING

CONDITION: After Hourly Reset

OPERATION: Mode Lock: SET

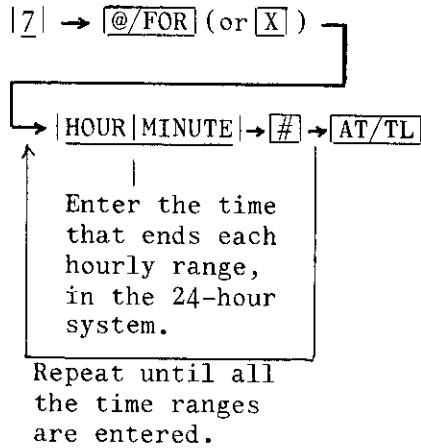

NOTES:

1. A maximum of 24 hourly ranges may be set.
2. To change the table of hourly ranges once set, partially or entirely, do the entire setting operation over again.
3. To reset the hourly range table once set, operate in "SET" mode: |7| → [@/FOR] → |0| → [#] → [AT/TL]
4. Do not set a range across 24:00, such as "from 23:00 to 1:00". If ever set, no data will be processed into that hourly range.
5. Even if a time value more than 24:00 is set, it will not result in an error but the data will not be processed in that range.

ex.) To reset the hourly range table once set:

Mode Lock to SET, enter 7, depress [@/FOR] .

Enter 0, depress [#] , depress [AT/TL]

```

TEC STORE
1343 PEACH DRIVE
PHONE: 877-6437

Thank you
Call again

10-01-85 #0

P 07
00:00

0034 11:06
    
```

ex.) To set the following hourly range table:

up to 8:00
 from 8:00 to 16:00
 from 16:00 to 23:00

Mode Lock to SET, enter 7, depress [@/FOR] .

Enter 800, depress [#] .
 Enter 1600, depress [#] .
 Enter 2300, depress [#] .

Depress [AT/TL] to end.

```

TEC STORE
1343 PEACH DRIVE
PHONE: 877-6437

Thank you
Call again

10-01-85 #0

P 07
00:08
16:00
23:00

0035 11:06
    
```



DEPARTMENT LISTING CAPACITY SETTING

CONDITION: After Auto-Reset

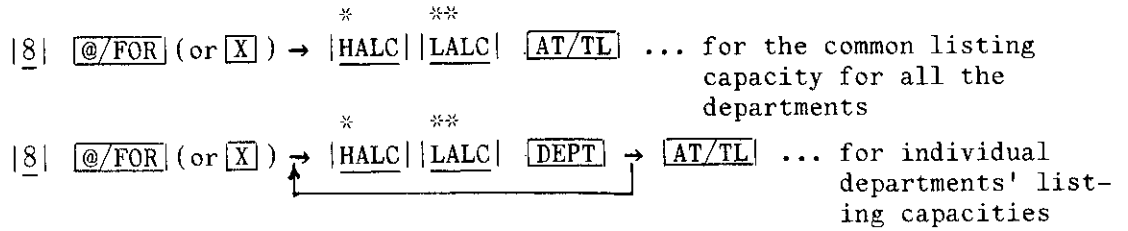
OPERATION: Mode Lock: SET

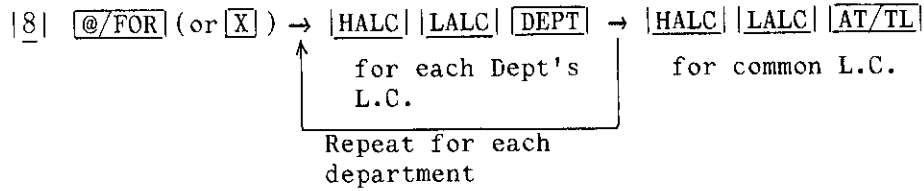

The above two operations may be combined as below:



***Note:** HALC High Amount Listing Capacity (to be set in a 2-digit code)

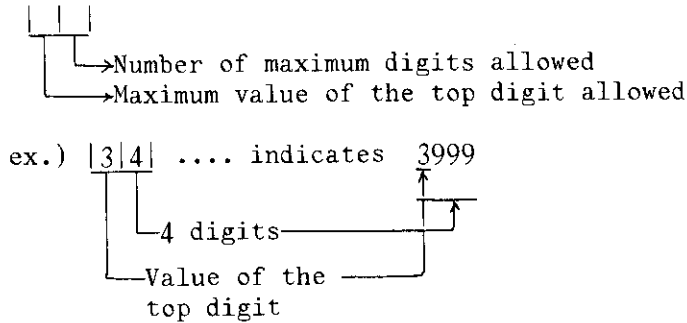

****Note:** LALC Low Amount Listing Capacity (to be set in a 2-digit code)

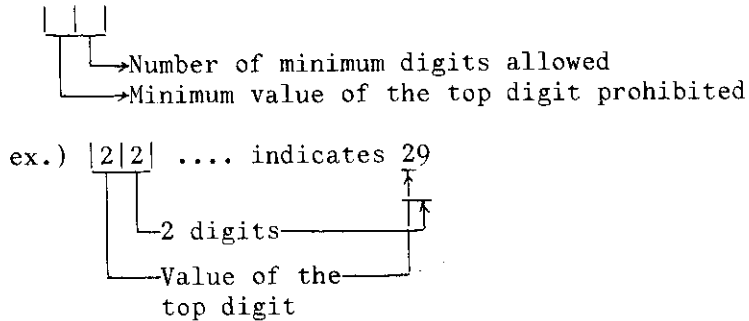

The amount range allowed to be entered in registraion:

Equal to or smaller than the HALC, and Larger than the LALC

ex.) 3999(HALC) ≥ Amount > 29(LALC)

- NOTES:**
1. If the individual listing capacity of a department has been set, it prevails over the common listing capacity.
 2. To reset an individual listing capacity, enter "0" before the **DEPT** key in the above operation. Then the common listing capacity for all the departments, if programmed, will prevail. The common listing capacity also may be reset if "0" is entered as the HALC in the above operation.
 3. The **SHIFT** key is operated prior to the **DEPT** key for a shifted department LC setting.
 4. If no listing capacity is required for HALC or LALC, enter 00 in place of a value:

ex.) |3|4| |0|0| **DEPT 1** ... No LALC is set for Dept. 1
 |0|0| |2|2| **DEPT 2** ... No HALC is set for Dept. 2
 |9|4| |0|0| **AT/TL** No LALC is set for Common LC.
 |0|0| |0|0| **DEPT 3** .. HALC and LALC once set is reset
 for Dept.3.

The top 0's may be omitted.

ex.) To set Listing Capacities as in the following:

	HALC	LALC
DEPT 1 (VEGETABLE)	\$99.99 ~ \$0.10 (\$0.09)	
	9 4	9 1
DEPT 2 (FRUIT)	\$99.99 ~ \$0.20 (\$0.19)	
	9 4	1 2
COMMON LC	\$99,999.99 ~ No low limit	
	9 7	0 0

Mode Lock to SET, enter 8, depress **@/FOR** .

Enter 9491, depress **DEPT 1** .
 Enter 9412, depress **DEPT 2** .
 Enter 9700, depress **AT/TL** .

TEC STORE
 1343 PEACH DRIVE
 PHONE: 877-6437

Thank you
 (Call again)

10-01-85 #0

F 08

01VEGTBL	9491
02FRUIT	9412
	9700

0037 11:09

FINANCIAL TOTAL NAME PROGRAMMING OR CHANGING

CONDITION: After Auto Reset and GT Reset

OPERATION: Mode Lock: SET

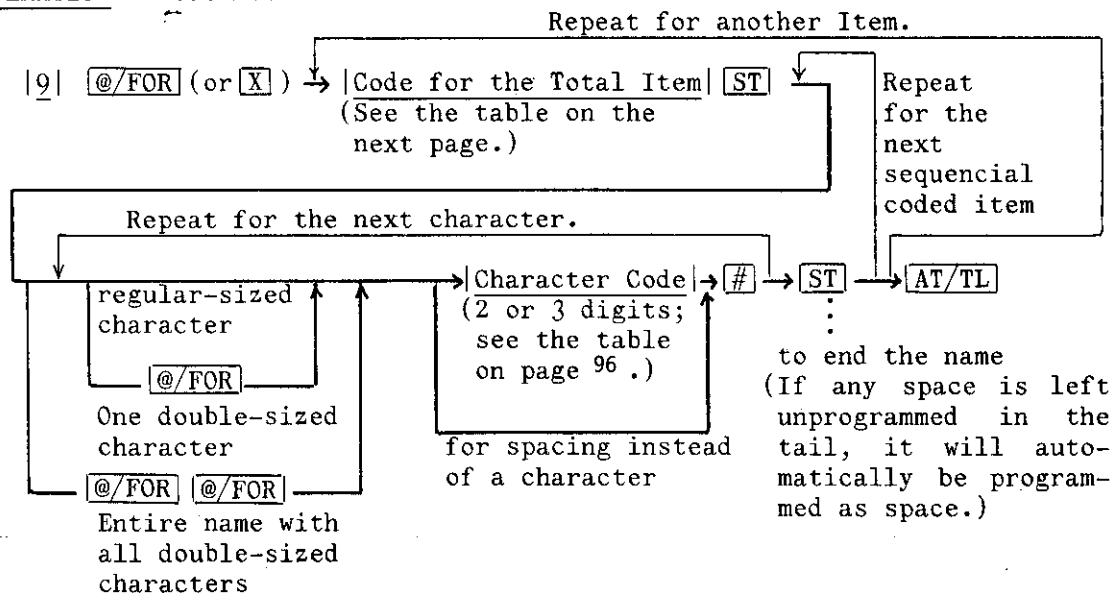

- NOTES:**
1. A maximum of 6 regular-sized characters or 3 double-sized characters may be programmed for one item name, with some exceptions. A combination of two types is also available.
 2. To go on to another Item name programming, the sequence "Code for the Total Item [ST]" may be skipped if the code is sequential.

ex.) To program "PO" in double-sized characters instead of "PO" in regular-sized characters (Standard Program Data) for Item No.21 (Paid Out):

Mode Lock to SET, enter 9, depress @/FOR .

Enter 21, depress ST (Item Code for Paid Out).
Depress

@/FOR twice (for declaration of entire name with double-sized characters)

Enter 26, depress # . (P)

Enter 25, depress # . (0)

Depress ST to end this name.

Depress AT/TL to end this program.

TEC STORE
1343 PEACH DRIVE
PHONE: 877-6437

Thank you
Call again

10-01-85 #0

#21 P 09
FO

0039 11:13

FINANCIAL TOTAL NAME TABLE

Code	Total or Counter	Max.Number of Characters	Name in Standard Program	Your Plan	Remarks
1	GT.	6	G T		
2	NET GT	6	N E T G T		
3	GS	6	G S		
4	%+	4	% +		
5	Net Sale (without TAX)	6	N S		
6	TAX 1(separate print)	6	T A X 1		
7	TAX 2(separate print)	6	T A X 2		for Manual TAX also
8	Net Sale (with TAX)	6	N S		
9	%- (on ST)	4	% -		%- on Sub-total
10	--vacant--				
11	Dollar Discount	6	D I S C		
12	BTL RTN (Inside)	6	B T R		Inside-Sale BTR
13	Media Total	6	T O T A L		
14	Cash Total	6	C A S H		
15	Media 1	6	C H E C K		Also used for each media cashing print.
16	Media 2	6	C h g		
17	Media 3	6	M I S C		
18	Media 4	6	C A R D		
19	Media 5	6	C P N		
20	Received on Account	4	R / A		
21	Paid Out	4	P O		
22	Loan	4	L O A N		
23	Pick Up	4	P . U P		
24	Cash-in-drawer	6	C A I D		
25	Medial-in-drawer	6	C K I D		
26	Media2-in-drawer	6	C h g I D		
27	Media3-in-drawer	6	M I S C I D		
28	Media4-in-drawer	6	C A R D I D		
29	Media5-in-drawer	6	C P N I D		
30	Item Corr on DP(+)	4	C O R R		
31	Void on DP(+)	4	V O I D		
32	IC/Void on Others	6	M S V D		IC=Item Correct
33	%- (on Item)	4	% -		%- on DP items
34	--vacant--				
35	BTL RTN (DP-linked)	4	B T R		
36	Negative DP Total	6	- D P		
37	Returned Merchandise	4	R T N		
38	Returned TAX	6	- T A X		
39	Audaction	6	- S A L E		
40	Negative Mode (<input type="checkbox"/>)	6	R E G -		
41	Transfer Total	6	T F T L		
42	Transfer GT (+)	6	T F + G T		non-resettable
43	Transfer GT (-)	6	T F - G T		non-resettable
44	Transfer Daily (+)	6	T F +		
45	Transfer Daily (-)	6	T F -		

-- To be continued on the next page. --

FINANCIAL TOTAL NAME TABLE -- Continued --

Code	Total or Counter	Max. Number of Characters	Name in Standard Program	Your Plan	Remarks
46	PB Sale	6	P B T L		
47	PB R/A	6	P B R / A		
48	PB Cash Total	6	P B C A		
49	PB Media 1	6	P B C K		
50	PB Media 2	6	P B C H		
51	PB Media 3	6	P B M S		
52	PB Media 4	6	P B C A R D		
53	PB Media 5	6	P B C P N		
54	PB PO	6	P B P O		
55	Taxable Total 1	6	T X B L 1		
56	Taxable Total 2	6	T X B L 2		
57	--vacant--				
58	Tax Exemption	6	T A X E X		
59	Tax 1 Exemption	6	T A X 1 E X		
60	Tax 2 Exemption	6	T A X 2 E X		
61	Sales Item Count per Cus	6	I T / C U S		
62	Sales Amount per Cus.	6	N S / C U S		
63	No-sale Counter	6	N O S A L E		
64	Validation Counter	6	V A L C T R		
65	Clerk Neg.Total 1	6	N E G 1		
66	Clerk Neg.Total 2	6	N E G 2		
67	TAX	6	T A X		
68	Total-in-drawer	6	T L I D		

NOTES: 1. The print data shown in the "Name in Standard Program" column in the above table have automatically been set on the MA-1060-100 series for the convenience of the customer. Therefore, program only the items that require changes from the standard print data.

2. The Total or Counter items designated with the Max. Number of Characters "4" are also used for validation printing for the item. Therefore, do not exceed 4 characters for the name programming.

PRINT LINE ITEM NAME PROGRAMMING OR CHANGING

CONDITION: Any time outside a sale

OPERATION: Mode Lock: SET

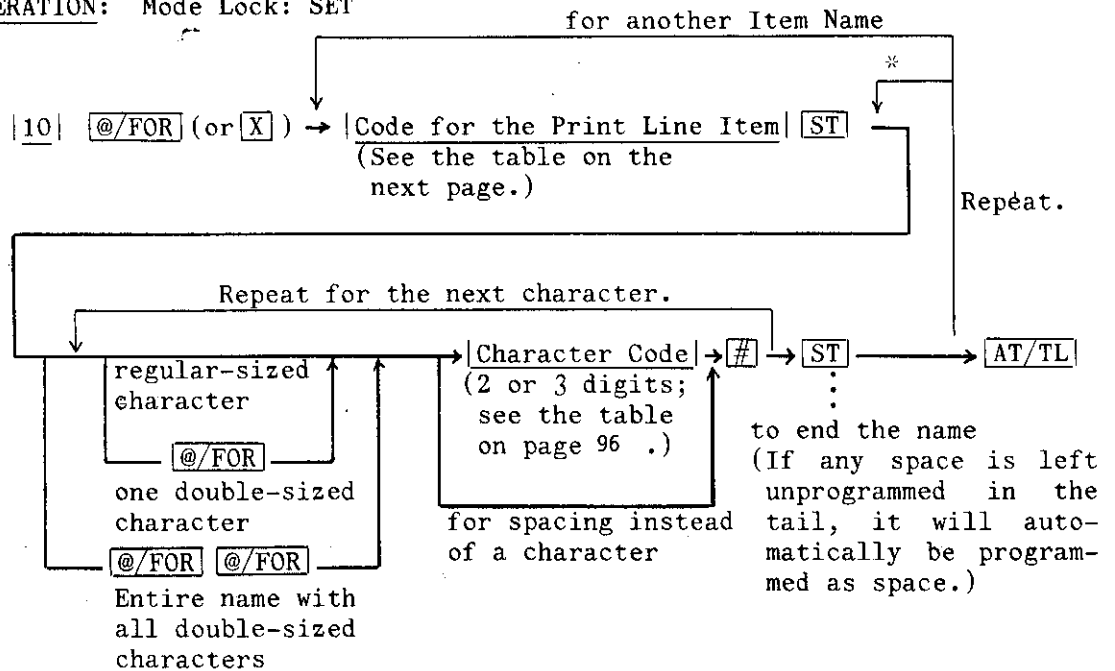

- NOTES:** 1. See the "Max. Number of Characters" column of the table on the next page as to the number of characters programmable for each item name. The number in the column indicates the capacity in regular-sized characters. One double-sized character occupies two regular-sized characters' space.
2. To go on to another Item name programming, the sequence "Code for the Print Line Item | ST |" may be skipped if the code is sequential. In this case, follow the line marked with "*".

ex.) To program the amount mark of "\$" in Item Code 8.
(The amount mark has not been programmed as the Standard Program Data.)

Meanwhile, other names for two other items in the same Item Code 8 should remain the same as the Standard Program Data (i.e., "@" for the Unit Price and "ITEM" for the Sales Item Count):

Mode Lock to SET, enter 10, depress @/FOR .

Enter 8, depress ST (Item Code).
 Enter 10, depress # . (@)
 Enter 37, depress # . (\$)
 Enter 19, depress # . (I)
 Enter 30, depress # . (T)
 Enter 15, depress # . (E)
 Enter 23, depress # . (M)
 Depress ST to end character setting.
 Depress AT/TL to end this program.

TEC STORE
 1343 PEACH DRIVE
 PHONE: 877-6437

Thank you
 Call again

10-01-85 #0

F 10
 #08 @*ITEM

0041 11:16

PRINT LINE ITEM NAME TABLE

Code	Print Line Item	Max.Number of Characters	Name in Standard Program	Your Plan	Remarks
1.	Sub-total	6	S U B T L		
2	Cash Tendered	6	C A T E N D		
3	Sale Total	6	T O T A L		
4	Change	6	C H A N G E		
5	Cash Refunded	6	C A S H		for Audaction Total
6	Group Sub-total	6	G R P . S T		ST line for %
7	Nontaxable Subtotal	6	N T X . S T		
8	Unit Price	1	@		These three must be set together.
	Amount Mark	1			
	Sales Item Count	4	I T E M		
9	Time (NOTE below)	2	T M		Theset three must be set together.
	Register No.Symbol	2	#		
	Clerk Symbol	2	C L		
10	Customer Count Symb.	2	C U		on reports
11	Department Group	4	G P		on reports
12	Previous Balance +	6	P B		
13	Previous Balance -	6	P B		
14	Transferred Amount	6	N - B A L		

NOTE: The Name for Time (in Code 6) will be used for an in-line command receiving only.

NOTE: If no programming operation is done for an item, the "Name in Standard Program" will automatically be active. Therefore, program only the items that require changes from the standard print data.

FIXED PRINT LINE ITEM NAMES (NOT PROGRAMMABLE)

Print Line Item	Number of Characters	Fixed Item Name	Remarks
Cons. No. Symbol	0		No symbol is printed.
Program Symbol	2	P	
Read (X) Symbol	2	X	
Reset (Z) Symbol	2	Z	
GT Read Symbol	6	G T X	
GT Reset Symbol	6	G T Z	
System Option Address	1	#	
% Symbol	1	%	
PLU Name	6	P L U x x x	xxx is the PLU No. 1
Department Name	4	D P x x	xx is the Dept. No. 2
Non-add Number Symbol	1	#	
Taxable Status Symbol	1	T	for Tax1 and/or Tax2 item
PLU Code Symbol	1	*	ex.) *001 (inidates PLU 001)
Negative Symbol	1	-	
Q'ty in Multiplication	1	X	

NOTES **1** **2**: These print line item names will be printed in case there has been no name programmed for the registered PLU or Department.

NON-TAXABLE AMOUNT LIMIT SETTING

CONDITION: After Auto Reset and GT Reset; this program is applicable only to restaurants in Province of Quebec, Canada.

If this program has been set, any sale exceeding the limit amount excluding the manual-tax amount will be taxed by the TAX 1 table (which will be described and programmed later in this manual), regardless of the sale composed of taxable and/or non-taxable items.

ex.) In case the following sale is recorded:

Taxable Items:	\$6.00		Sale Total:	\$11.00
Non-taxable Items:	\$5.00		TAX1 Added:	\$1.10
Sale Total:	\$11.00	(If non-taxbl limit is \$10.00, and if TAX1 Table is set with 10%)	Payment TL:	\$12.10

OPERATION: Mode Lock: SET

| 12 | @/FOR (or X) → | Non-taxable Limit Amount | → | AT/TL |

- NOTES:**
1. To reset the limit amount once set, enter "0" in place of the | Non-taxable Limit Amount | in the above operation.
 2. Do not set TAX2 Table when the Non-taxable Amount Limit is set.
 3. This tax calculation program will be disregarded when the sale total is negative.

ex.) Setting limit amount to "\$3.25":

Case 1) Normal Department Entry (Mode Lock: REG)

| 326 | → | non-taxable DEPT | → | AT/TL |

... The amount entered \$3.60 is larger than the limit amount \$3.25. It will therefore be taxed.

Case 2) Returned Merchandise Entry (Mode Lock: REG)

| RTN MDSE | → | 326 | → | non-taxable DEPT | → | AT/TL |

... The non-taxable total is negative. The tax already levied will therefore not be returned.

ex.) To set the Non-taxable Limit Amount to "\$2.00":

Mode Lock: SET

Enter 12, depress | @/FOR | (or | X |).
Enter 200, depress | AT/TL | .

TEC STORE
1343 PEACH DRIVE
PHONE: 877-6437

Thank you
Call again

10-01-85 #0

P 12
\$2.00

0042 11:18

SPECIAL CHARACTER GENERATION TABLE PROGRAMMING

This program is provided to prepare special characters to be used for printing messages, etc. by each customer, adding them to the CHARACTER CODE TABLE which is shown on page 96 as those already available on this ECR.

- . Type of Characters Programmable: Regular-sized Characters or Double-sized Characters
- . Maximum Number of Characters: 30 (Regular-sized) or 10 (Double-sized)
- . Character Codes Assigned for These Special Characters: 170 through 199 (Regular-sized) 254 through 263 (Double-sized)

After programming special characters, fill in the blank table attached to the CHARACTER CODE TABLE on page 96 .

CONDITION: Any time outside a sale

OPERATION: Mode Lock: SET

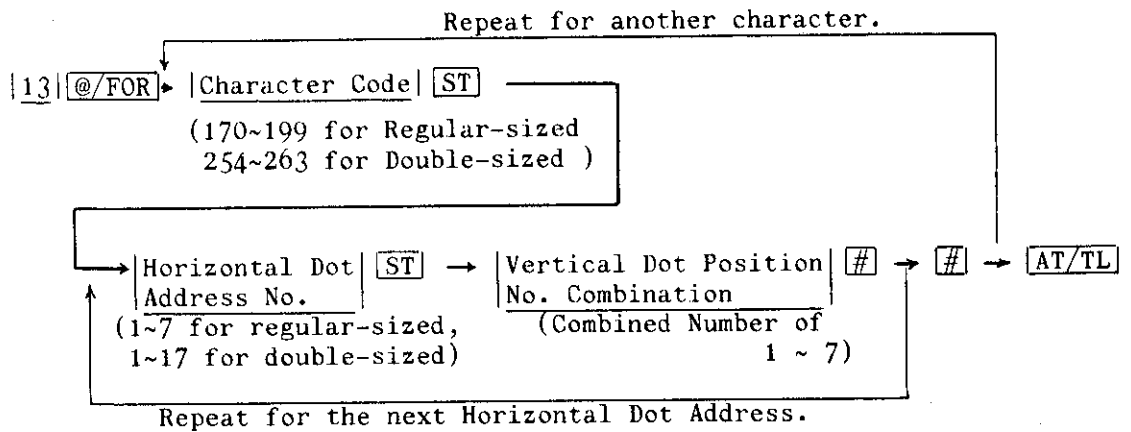

ENLARGED FIGURE OF DOT MATRIX COMPOSITION

Regular-sized Character

Double-sized Character

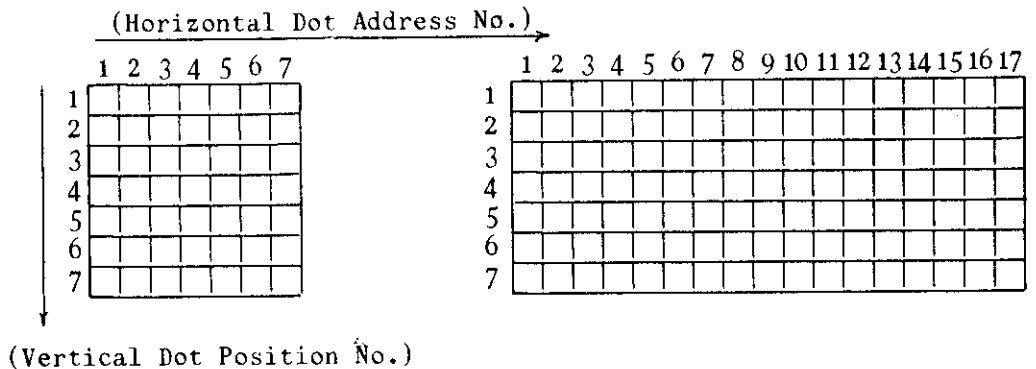

NOTES: 1. Programming a dot-print right or left way next to a pre-programmed dot-print position will result in an error.

ex.)

A	B	C	
D	●	E	
F	G	H	

If a dot-print has already programmed in the position shown as "●", no dot-print can be programmed in the position of D or E. It will be all right to program dot-printing in the position of A, B, C, F, G, or H.

2. To read what has already been programmed with a specific Character Code, operate:

Mode Lock to SET, 13 | @/FOR → | Character Code | ST → # → AT/TL .

Then the character that has programmed with the Character Code will be printed.

Programming Example

To program the character as in the figure below with Character Code 170 assigned:

	1	2	3	4	5	6	7
1				●			
2			●		●		
3		●				●	
4	●						●
5		●				●	
6			●		●		
7				●			

Key Operation

Mode Lock: SET

13 | @/FOR

170 | ST | (Assigned Character Code)

1 | ST | 4 | #

2 | ST | 35 | #

3 | ST | 26 | #

4 | ST | 17 | #

5 | ST | 26 | #

6 | ST | 35 | #

7 | ST | 4 | #

| (to end this character)

AT/TL | (to end this program)

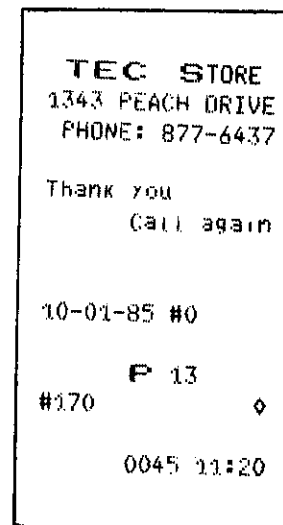

DEPARTMENT GROUP PROGRAMMING OR CHANGING

CONDITION: After Auto Reset and GT Reset

OPERATION: Mode Lock: SET

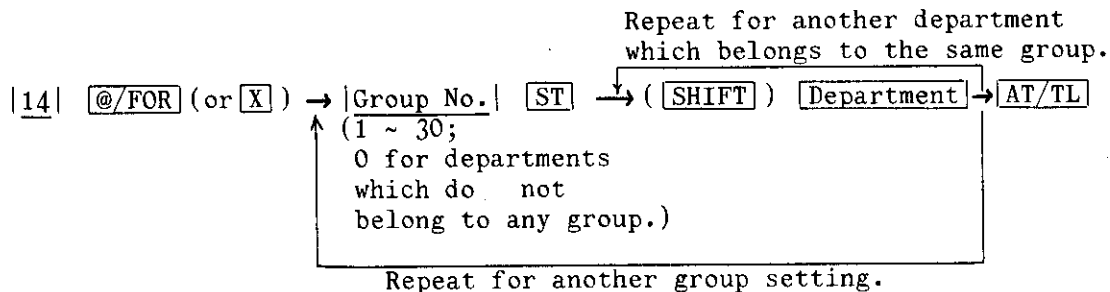

- NOTES:**
1. If "0" is entered at the "Group No.", the following department will be reset from grouping program (i.e., the department will not belong to any group).
 2. Depress the **SHIFT** key prior to the Department Key if it is a shifted department.
 3. If no number is entered as the "Group No.", it will be regarded the same as "0" is entered.
 4. Do not program any negative departments to a group. It will not result in an error if such an attempt is made, but such grouping data will be disregarded anyway.
 5. To reset all grouping program data once set, operate:
Mode Lock: SET, |14| @/FOR → |0| → AT/TL.

ex.) GROUP TABLE

Group 1:
Dept. 1
Dept. 2

Group 2:
Dept. 3
Dept. 4
Dept. 5
Dept. 6

Group 3:
Dept. 7
Dept. 8
Dept. 9
Dept.10

KEY OPERATION

Mode Lock to SET.

Enter 14, depress @/FOR.

Enter 1, depress ST.

Depress DEPT 1,
DEPT 2,

Enter 2, depress ST.

Depress DEPT 3,
DEPT 4,
DEPT 5,
DEPT 6,

Enter 3, depress ST.

Depress DEPT 7,
DEPT 8,
DEPT 9,
DEPT 10,

Depress AT/TL to end.

TEC STORE
1343 PEACH DRIVE
PHONE: 877-6437

Thank you
Call again

10-01-85 #0

F 14
GF01 01 VEGTEL
02 FRUIT
GF02 03 MEAT
04 FISH
05 DAIRY
06 BAKERY
GF03 07 CANNED
08 BOTLED
09 DRINK
10 OTHERS

0047 11:28

DEPARTMENT PRESET PRICE SETTING OR CHANGING

CONDITION: Any time outside a sale

OPERATION: Mode Lock: SET or MGR

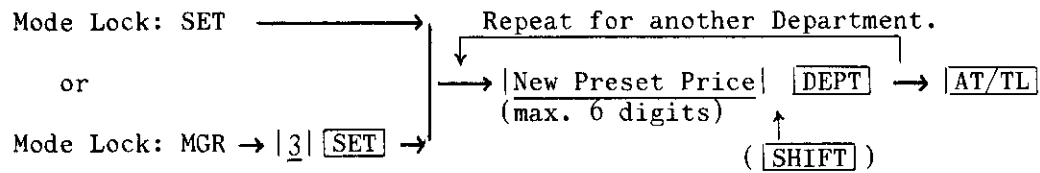

- NOTES:**
1. To preset the price of "0", enter "0" in place of the price entry in the above operation.
 2. If no price is entered in the above operation, the department is set as an open department.
 3. Depress [SHIFT] prior to the department key if the price is preset on a shifted department.

ex.) To set the following preset prices on the respective Departments:

\$1.20 for Dept. 16
\$1.30 for Dept. 17
\$1.40 for Dept. 18
\$1.50 for Dept. 19
\$1.60 for Dept. 20

Mode Lock to SET.

Enter 120, depress [DEPT 16] .
Enter 130, depress [DEPT 17] .
Enter 140, depress [DEPT 18] .
Enter 150, depress [DEPT 19] .
Enter 160, depress [DEPT 20] .

Depress [AT/TL] to end.

TEC STORE
1343 PEACH DRIVE
PHONE: 877-6437

Thank you
Call again

10-01-85 #0

P

160P16	\$1.20
170P17	\$1.30
180P18	\$1.40
190P19	\$1.50
200P20	\$1.60

0050 11:32

- NOTES: 1. If only one tax modifier key (TX/M) is installed on the keyboard, use the TX/M in place of the TX1/M in the description of 1), 2), or 3) above.
2. For TAX 2 Table programming, follow the same procedure in 1), 2), or 3) above, using the TX2/M instead of the TX1/M.
3. If both TAX 1 and TAX 2 tables are programmed, the TAX 1 must be set first. The TAX 1 table entry will automatically reset both the TAX 1 and TAX 2 tables that have been programmed.
4. No second depression of the ST key is allowed within one tax table programming.

ex. 1) Full Break (in a single-tax area)

<u>Tax Table</u>		<u>Key Operation</u>	
<u>Amount Range</u>	<u>Tax Levied</u>		
		Mode Lock to SET.	
\$0.00~\$0.10	0¢	Enter 10, depress <u>TX/M</u> .	00 \$0.10
\$0.11~\$0.22	1¢	Enter 22, depress <u>TX/M</u> .	01 \$0.22
\$0.23~\$0.39	2¢	Enter 39, depress <u>TX/M</u> .	02 \$0.39
\$0.40~\$0.56	3¢	Enter 56, depress <u>TX/M</u> .	03 \$0.56
\$0.57~\$0.73	4¢	Enter 73, depress <u>TX/M</u> .	04 \$0.73
\$0.74~\$0.90	5¢	Enter 90, depress <u>TX/M</u> .	05 \$0.90
\$0.91~\$1.08	6¢	Enter 108, depress <u>TX/M</u> .	06 \$1.08
	"A" Break	Depress <u>ST</u>	*
\$1.09~\$1.24	7¢	Enter 124, depress <u>TX/M</u> .	07 \$1.24
\$1.25~\$1.41	8¢	Enter 141, depress <u>TX/M</u> .	08 \$1.41
\$1.42~\$1.58	9¢	Enter 158, depress <u>TX/M</u> .	09 \$1.58
\$1.59~\$1.74	10¢	Enter 174, depress <u>TX/M</u> .	10 \$1.74
\$1.75~\$1.91	11¢	Enter 191, depress <u>TX/M</u> .	11 \$1.91
\$1.92~\$2.08	12¢	Enter 208, depress <u>TX/M</u> .	12 \$2.08
	"B" Break	Depress <u>AT/TL</u> .	**

TEC STORE
1343 PEACH DRIVE
PHONE: 877-6437

Thank you
Call again

10-01-85 #123456

P TAX1

00 \$0.10
01 \$0.22
02 \$0.39
03 \$0.56
04 \$0.73
05 \$0.90
06 \$1.08
*
07 \$1.24
08 \$1.41
09 \$1.58
10 \$1.74
11 \$1.91
12 \$2.08
**

0061 11:44

ex. 2) "A" Break and % Rate Combination (in a single-tax area)

<u>Amount Range</u>	<u>Tax Levied</u>
\$0.00~\$0.09	0¢
\$0.10~\$0.29	1¢
\$0.30~\$0.59	2¢
\$0.60~\$0.84	3¢
\$0.85~\$1.12	4¢

"A" Brreak
5% is applied above the
"A" Break

Key Operation

Mode Lock to SET.

Enter 9, depress .

Enter 29, depress .

Enter 59, depress .

Enter 84, depress .

Enter 112, depress .

Depress .

Enter 5, depress .

TEC STORE
1343 PEACH DRIVE
PHONE: 877-6437

Thank you
Call again

10-01-85 #123456

F TAX1

00	\$0.09
01	\$0.29
02	\$0.59
03	\$0.84
04	\$1.12
*	5%

0063 11:48

ex. 3) % Rate only (in a single-tax area)

Tax Table

10% is applied to
any amount.

Key Operation

Mode Lock to SET.

Enter 0, depress .

Depress .

Enter 10, depress .

TEC STORE
1343 PEACH DRIVE
PHONE: 877-6437

Thank you
Call again

10-01-85 #123456

F TAX1

00	\$0.00
*	10%

0065 11:49

%+ AND %- PRESET RATE SETTING

CONDITION: Any time outside a sale

OPERATION: Mode Lock: SET

|Preset % Rate| → %+ (or %-)

↓

(0.001 ~ 99.999; use the . key
if a decimal portion is contained.)

ex.) To set the %- preset rate of 10%:

Mode Lock: SET → |10| → %-

NOTE: To reset the rate once set:

Mode Lock: SET → |0| → %+ (or %-)

TEC STORE
1343 PEACH DRIVE
PHONE: 877-6437

Thank you
Call again

10-01-85 #0

F- 10%

0056 11:40

STORE/REGISTER NO. SETTING

CONDITION: After Auto Reset and GT Reset

OPERATION: Mode Lock: SET

|Store/Register No.| → # (or #/NS
(max. 6 digits;
0 ~ 999999)

NOTE: The . key can not be used in setting
the Store/Register No.

ex.) To set Store/Register No. 123456

Mode Lock to SET, enter 123456, depress #.

TEC STORE
1343 PEACH DRIVE
PHONE: 877-6437

Thank you
Call again

10-01-85 #0

F- #123456

0059 11:41

TAX TABLE PROGRAMMING

CONDITION: After Auto Reset and GT Reset

OPERATION: Mode Lock: SET

1) Tax 1 Full Breaks

|max. amount non-taxable| → **TX1/M**

|max. amount for 1¢ tax levied| → **TX1/M**

|max. amount for 2¢ tax levied| → **TX1/M**

⋮

Repeat until the "A" Break is entered.

⋮

|max. amount for N¢ tax levied| → **TX1/M** ... "A" Break

ST (to indicate the "A" Break entry)

|max. amount for N+1¢ tax levied| → **TX1/M**

|max. amount for N+2¢ tax levied| → **TX1/M**

⋮

Repeat until the "B" Break is entered.

AT/TL (to end)

NOTE: The amount entry may be a maximum of 4-digit value (9999¢).

2) Tax 1 "A" Break and % Rate Combination

First set the "A" Break following the same operation up to the "A" Break entry and the **ST** depression in the above "1) Tax 1 Full Breaks".

↓

|TAX RATE applied when exceeding the "A" Break amount|

(Maximum 5 digits, up to 99.999%. Use the **.** key to enter decimal portion, if any. Example: To set 5%, enter 5. To set 5.003%, enter 5→**.**→0→0→3. The fraction of the amount resulting from this % rate calculation will be rounded off.)

↓

AT/TL (to end)

3) Tax 1 % Rate Only

|0| → **TX/M** → **ST** → |TAX RATE| → **AT/TL**

(The conditions of the rate are the same as the above TAX RATE.)

PLU PRESET PRICE CHANGING

CONDITION: Any time outside a sale

OPERATION: Mode Lock: SET or MGR

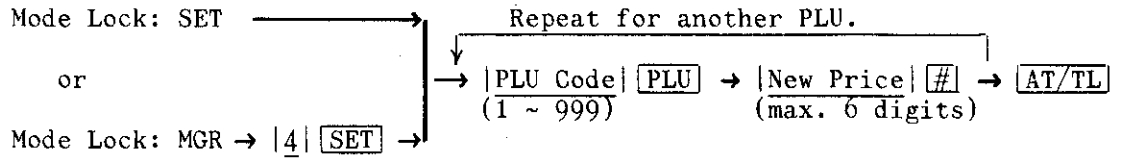

- NOTES:**
1. The PLU Codes to be entered in this operation must be the PLU Codes that were programmed in the "PLU TABLE PROGRAMMING OR CHANGING" operation already described on page Otherwise, it will result in an error.
 2. If "0" is entered as the New Price, the preset price of the PLU will be set to be "0". If the New Price entry is skipped before the [#] key, it will result in an error.
 3. If an attempt to preset a price to an open PLU, it will result in an error.
 4. In this operation, changes of link departments, programming additional PLUs, programming or changing the PLU name are not possible.

ex.) To change the preset price of
 PLU No.102 (Potato) from
 \$1.20 to \$1.40 :

Mode Lock to SET.

Enter 102, depress [PLU] (PLU Code).

Enter 140, depress [#] (New Price).

Depress [AT/TL] to end.

TEC STORE
 1343 PEACH DRIVE
 PHONE: 877-6437

Thank you
 Call again

10-01-85 #0

F
 PLU102 01 00
 \$1.40
 Potato

0052 11:35

TENDER LISTING CAPACITY SETTING

CONDITION: After Auto Reset

OPERATION: Mode Lock: SET

|HALC| → |AT/TL| (Cash Tender L. C.)

|HALC| → |CHK TND| (Check Tender L. C.)
(or |MEDIA 1|)

|HALC| → |Chg| (Charge Tender L. C.)
(or |MEDIA 2|)

|HALC| → |MSC TND| (Misc. Tender L. C.)
(or |MEDIA 3|)

|HALC| → |CARD| (Media 4 Tender L. C.)
(or |MEDIA 4|)

|HALC| → |MEDIA 5| (Media 5 Tender L. C.)

*HALC ... Refer to the HALC description in the
"DEPARTMENT LISTING CAPACITY SETTING"
operation on page .

NOTE: To reset the L. C. once set:

Mode Lock: SET → |0| → |Media Key|

ex.) To set the Check Tender L.C. to 45
(= Tender Amount Limit \$499.99)

Mode Lock to set, enter 45, depress |CHK TND|.

TEC STORE
1343 PEACH DRIVE
PHONE: 877-6437

Thank you
Call again

10-01-85 #0

F
CHECK 45

0054 11:37

PROGRAMMING OPERATIONS IN "MGR" MODE (MANAGER'S PROGRAMMING)

The following is the list of programming operations available in the "MGR" mode. This function is provided for the store manager to change some program data on the daily, weekly, or monthly basis. These operations are also available in the "SET" mode so that the programmer may cover them along with other major items to be programmed or changed on a longer period basis. To enable the programming operations in the "MGR" mode, the SET key must be installed on the keyboard. During these operations, any one of the Clerk Keys must be inserted and set to its own position.

The detail operations in the "MGR" mode are exactly the same as those in the "SET" mode already described except the first Program No. entry sequence for each program item, which is stated in each program item description in the "SET" mode.

TABLE OF MANAGER'S PROGRAMMING OPERATIONS

<u>"MGR" MODE</u>			
<u>Prog. No.</u>	<u>Program Item</u>	<u>Condition</u>	<u>page</u>
1 ...	STORE NAME/MESSAGE AND COMMERCIAL MESSAGE PROGRAMMING	Anytime [1]	66
2 ...	CLERK NAME PROGRAMMING	Anytime	68
3 ...	DEPARTMENT PRESET PRICE SETTING OR CHANGING	Anytime	88
4 ...	PLU PRESET PRICE CHANGING	Anytime	89
5 ...	TIME SETTING	Anytime	75

NOTE [1]: "Anytime" indicates "Any time outside a sale".

CHARACTER CODE TABLE (Standard Characters)

		→ Column Code																
		0	1	2	3	4	5	6	7	8	9	10	11	12	13	14	15	16
↓ Row Code	0	0	@	J	T	ア	サ	ナ	マ	ラ	ア	,	½	j	t	Ä	ä	â
	1	1	A	K	U	イ	シ	ニ	ミ	リ	イ	.	a	k	u	Ö	ö	ê
	2	2	B	L	V	ウ	ス	ヌ	ム	ル	ウ	:	b	l	v	Ü	ü	ç
	3	3	C	M	W	エ	セ	ネ	メ	レ	エ	'	c	m	w	Æ	æ	é
	4	4	D	N	X	オ	ソ	ノ	モ	ロ	オ	/	d	n	x	Œ	œ	è
	5	5	E	O	Y	カ	タ	ハ	ヤ	ワ	ツ	#	e	o	y	À	à	ú
	6	6	F	P	Z	キ	チ	ヒ	ユ	ヲ	ヤ	*	f	p	z	Ñ	ñ	á
	7	7	G	Q	\$	ク	ツ	フ	ヨ	ン	ユ		g	q	+	%	ß	í
	8	8	H	R	£	ケ	テ	ヘ	["	ヨ	&	h	r	ø	///	Đ	ó
	9	9	I	S	¥	コ	ト	ホ]	°	-	!	i	s	=	?	õ	

CHARACTER CODE TABLE

(Kanji Characters)

		→ Column Code					
		20	21	22	23	24	25
↓ Row Code	0	合	入	取	高	月	特
	1	計	金	消	課	日	奉
	2	現	返	客	税	組	休
	3	小	支	点	万	人	~
	4	預	払	回	買	上	
	5	釣	値	数	責	仕	
	6	掛	引	信	受	名	
	7	売	割	純	免	訂	
	8	戻	個	円	料	定	
	9	替	券	在	年	総	

SPECIAL CHARACTER CODE TABLE

(Fill in the blanks the characters or symbols programmed in the "SPECIAL CHARACTER GENERATION TABLE PROGRAMMING".)

		→ Column Code		
		17	18	19
↓ Row Code	0			
	1			
	2			
	3			
	4			
	5			
	6			
	7			
	8			
	9			

		→ Column Code	
		25	26
↓ Row Code	0		
	1		
	2		
	3		
	4		
	5		
	6		
	7		
	8		
	9		

WAY OF INPUTTING CODES: First enter the Column Code and then the Row Code for the required character. For example, to access "B", enter 12. Each of the Kanji Characters occupies a double-sized character space, despite each character is input in the "Regular-sized Character" method. The same is applied to the Codes from 254 through 263.

PROGRAMMING OPERATIONS THROUGH THE PROGRAMMING KEYBOARD (OPTIONAL)

The TEC Programming Keyboard (TKB-1-A) may be connected to the MA-1060-100 ECR as an optional device for programming routines.

With this keyboard, programming operations, particularly those requiring alpha/numeric character setting for descriptors of departments, PLUs, and Clerk Names, etc. will be performed more easily.

CONNECTION TO THE ECR

- (1) Open the Ribbon Cover of the ECR and follow the descriptions referring to the figure below:

OVERVIEW BEHIND RIBBON COVER

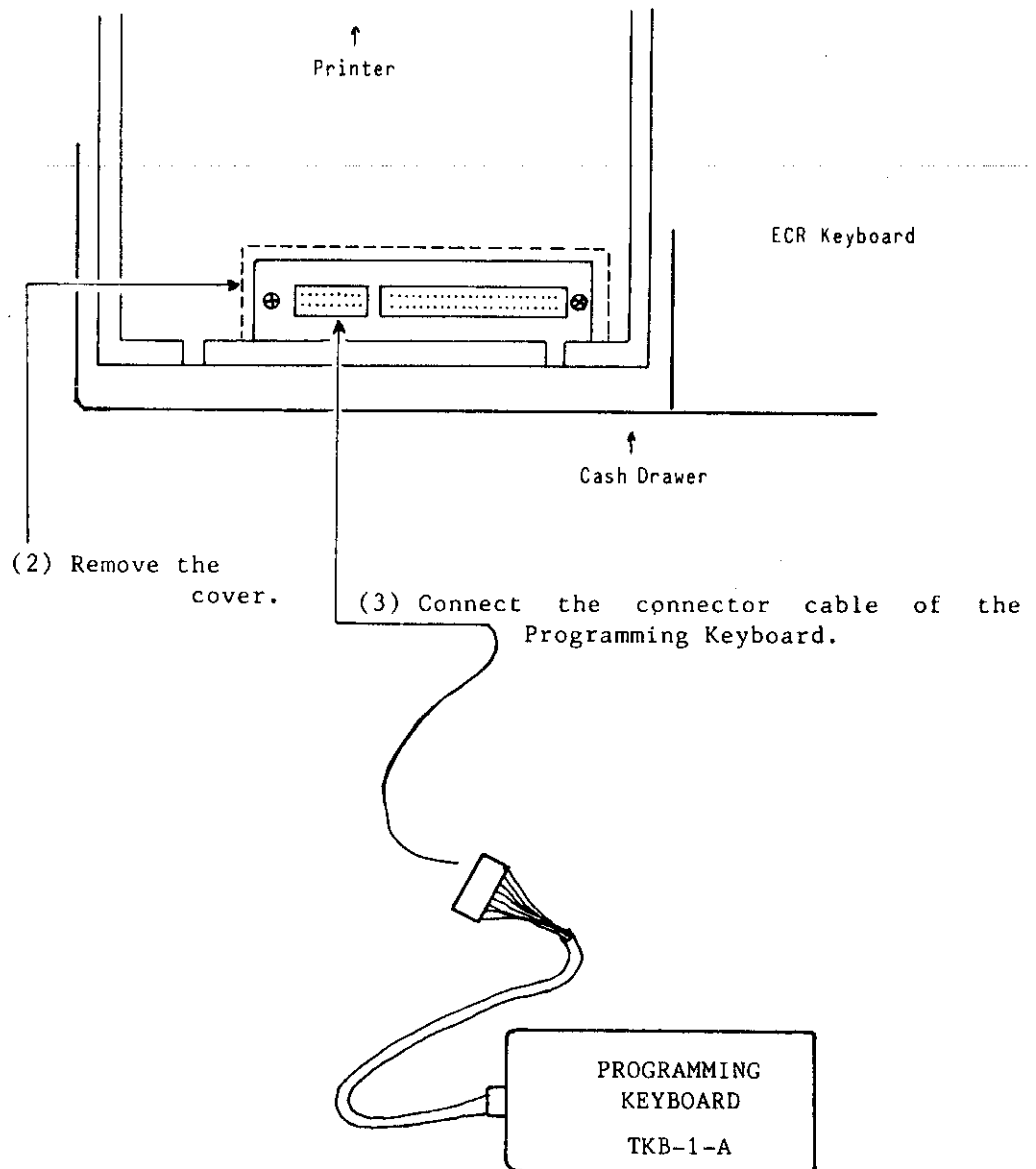

KEYBOARD LAYOUT

SFT1	! ?	II £	#	* \$	%	&	' :	[/] +	- =	CLEAR
	170	171	172	173	174	175	176	177	178	179	
SFT2	1	2	3	4	5	6	7	8	9	0	X
	180	181	182	183	184	185	186	187	188	189	
SFT3	Q Ä	W Ö	E Ü	R Æ	T Ç	Y Å	U Ñ	I Ð	O	P	CODE
	190	191	192	193	194	195	196	197	198	199	
SFT4	A ä	S ö	D ü	F æ	G œ	H å	J ñ	K ß	L ø		AT/TL
	254	255	256	257	258	259	260	261	262	263	
SFTLOCK	Z á	X é	C ç	V e	B e	N u	M a	, ı	. o	SPACE	ST

Character Keys

Shift Keys (1 ~ 4)
and Shift Lock Key

(The 3-digit numbers written in the Character keys in the above figure are not actually painted on the key tops of the keyboard. These indicate the Special Characters that can be accessed with the SFT4 key.)

Function
Keys

Shift Keys (1 ~ 4), Shift Lock Key

Used to designate the shift of the character keys. Each character key has four different characters, each of which is designated by the Shift Key 1 to Shift Key 4. Shift Key 4 is used to access the Special Characters programmed in the "SPECIAL CHARACTER GENERATION TABLE PROGRAMMING" operation. (Refer to the "CHARACTER CODE TABLE" on page 96.)

Shift Keys 2 through 4 are effective for one following character only. After that, the Shift 1 mode is automatically regained.

The shift Lock is used to hold the shifted status for a series of characters. To changed the shifted status locked by the Shift Lock Key, one of the Shift Keys (1 ~ 4) must be depressed prior to the next character key depression.

Character Keys

Used to enter alpha/numeric data indicated above each character key and the special character corresponding to the 3-digit code written in each key frame in the above figure. In setting a descriptor of Department or PLU name, a clerk name, etc., simply press the corresponding character key here instead of a character code and the # key combination on the ECR keyboard.

ex.) A ä

"A" is entered in the Shift 1 mode.

Operate: (SFT1) → A ä

"a" is entered in the Shift 2 mode.

Operate: SFT2 → A ä

"ä" is entered in the Shift 3 mode.

Operate: SFT3 → A ä

The Special Character assigned with Character Code 254 is entered in the Shift 4 mode.

Operate: SFT4 → A ä

The numeric keys **1** through **0** may be used as character keys for descriptor setting, and also used for numeric data input such as in designating the Department No. or PLU No. along with the use of the **CODE** key.

Each of the numeric key is effective only in Shift 1 or Shift 2 mode.

The **SPACE** key is effective to enter space in any of the four shift modes.

Function Keys

Except the **CODE** key, each of the Function Keys corresponds to the identical key installed on the ECR keyboard as to the function in programming operations. (**@/FOR** = **X**)

The **CODE** key is provided for the convenience of entering a Department No., PLU No., Line No. for STORE NAME/MESSAGE AND COMMERCIAL MESSAGE PROGRAMMING, Clerk ID Code in CLERK NAME PROGRAMMING, Item Code in FIANANCIAL TOTAL NAME PROGRAMMING and PRINT ITEM NAME PROGRAMMING operations.

ex.)	<u>Operation on ECR Keyboard</u>	<u>Operation on TKB-1-A</u>
	DEPT 1	1 CODE
	25 PLU (as PLU No.)	25 CODE
	1 ST (as Clerk ID)	1 CODE

|
(If the **ST** key on the TKB-1-A keyboard is used in this case, it will result in an error.)

OPERATION EXAMLE

To set the Department Name "COFFEE" for Dept.1:

ON ECR KEYBOARD ONLY:

3 **@/FOR** **DEPT 1** 13 **#** 25 **#** 16 **#** 16 **#** 15 **#** 15 **#** **ST**
(C) (O) (F) (F) (E) (E) **AT/TL**

ON TKB-1-A KEYBOARD ONLY:

3 **X** 1 **CODE** C O F F E E **ST** **AT/TL**

ON ECR KEYBOARD AND ON TKB-1-A KEYBOARD COMBINED:

3 **@/FOR** **DEPT 1** C O F F E E **ST** **AT/TL**
 _____ | _____ | _____
 on ECR ON TKB-1-A on ECR

VERIFICATION OF PROGRAMMED DATA

DEPARTMENT PRESET PRICE READ

(Mode Lock: X, enter 1, depress **[ST]**.)

DEPARTMENT STATUS AND LISTING CAPACITY READ

(Mode Lock: X, enter 2, depress **[ST]**.)

```

TEC STORE
1343 PEACH DRIVE
PHONE: 877-6437

Thank you
Call again

10-01-85 #123456
X
01VEGTBL
02FRUIT
03MEAT
04FISH
05DAIRY
06BAKERY
07CANNED
08BOTTLED
09DRINK
10OTHERS
16DP16 $1.20
17DP17 $1.30
18DP18 $1.40
19DP19 $1.50
20DP20 $1.60
21DP21
22DP22
23DP23
24DP24
25DP25

0066 11:51
    
```

Dept. Code
 Dept. Name
 (If no name has been programmed, the Dept. cod such as "DP01" will be printed instead.)

Preset Price
 (If no price is printed, it is an open dept.)

```

TEC STORE
1343 PEACH DRIVE
PHONE: 877-6437

Thank you
Call again

10-01-85 #123456
X
01VEGTBL 0 9491
02FRUIT 0 9412
03MEAT 0 0000
04FISH 0 0000
05DAIRY 0 0000
06BAKERY 1 0000
07CANNED 1 0000
08BOTTLED 1 0000
09DRINK 1 0000
10OTHERS 1 0000
16DP16 0 0000
17DP17 0 0000
18DP18 0 0000
19DP19 0 0000
20DP20 0 0000
21DP21 0 0000
22DP22 0 0000
23DP23 0 0000
24DP24 0 0000
25DP25 0 0000

0068 11:52
    
```

HALC 94, LALC 91
 (If 00, no LC has been set.)

Status Code:
 0: Non-taxable
 1: Tax1 Taxable
 2: Tax2 Taxable
 3: Tax1 & Tax2 Taxable

PLU PROGRAM DATA READ

(Mode Lock: X, enter 3, depress **ST** .)

```

TEC STORE
1343 PEACH DRIVE
PHONE: 877-6437

Thank you
Call again

10-01-85 #123456
X
PLU101 01 00
  $1.00 / 6
  Tomato
PLU102 01 00
  $1.40
  Potato
PLU201 02 00
  $1.59 / 5
  Apple
PLU202 02 00
  $1.49 / 6
  Orange
PLU301 03 00
  Beef
PLU302 03 00
  Pork
PLU501 05 00
  $2.00
  Cheese
PLU502 05 00
  $2.20
  Butter
PLU601 06 01
  $1.30
  WhiBrd
PLU602 06 01
  $1.10
  RyeBrd
PLU603 06 01
  $0.50
  HaRoll
PLU604 06 01
  $0.40
  SoRoll
PLU901 09 01
  $0.25
  7-up
PLU902 09 01
  $0.25
  Coke

0069 11:53
    
```

PLU Code
 Linked Dept.No.
 Status Code
 0: Non-taxable
 1: Tax1 Taxable
 2: Tax2 Taxable
 3: Tax1 & Tax2 Taxable
 Preset Price
 Whole Package Qty
 (if any programmed)
 PLU Name
 (If no name programmed,
 the PLU Code such as
 "PLU101" will be
 Printed.)

OTHER PROGRAM DATA READ

(Mode Lock: X, enter 4, depress **ST** .)

```

TEC STORE
1343 PEACH DRIVE
PHONE: 877-6437

Thank you
Call again

10-01-85 #123456
X
%-      10%
          9700
CATEND  00
CHECK   45
Chg     00
MISC    00

0070 11:54
    
```

%- Preset Rate
 Common HALC/LALC
 Cash Tender HALC
 Check Tender HALC
 Charge Tender HALC
 Misc Tender HALC

SYSTEM OPTION READ

(Mode Lock: X, enter 5, depress **ST** .)

```

TEC STORE
1343 PEACH DRIVE
PHONE: 877-6437

Thank you
Call again

10-01-85 #123456
X
#01      6
#02      0
#03      0
#04      0
#05      0
#06      0
#07      0
#08      0
#09      0
#10     0
#11     0

0071 11:54
    
```

Address No.
 Bit Nos of "SET" status

TAX TABLE READ (Mode Lock: X, depress TX/M in a single-tax area)
 depress TX1/M for TAX1 Table- | in a dual-tax
TX2/M for TAX2 Table- | area)

TEC STORE
 1343 PEACH DRIVE
 PHONE: 877-6437

Thank you
 Call again

10-01-85 #123456

* TAX1

00 \$0.00

*

10%

0074 11:57

— Tax Table 1 or 2

— ("A: Breaks will be printed if any)

— % Rate ("B" Breaks will be printed if programmed instead of the % rate.)
 (Non-taxable Amount Limit will be printed if programmed.)

TESTING TAX CALCULATION (Mode Lock: X)

AMOUNT TO TEST	-	TXBLE TL	... A receipt is issued on the TXBLE TL key depression, printing the entered amount and the taxes due. (The data entered in the operation will not affect any sale totals.)
Amount entered		Tax due (TAX1 and TAX2 consolidated)	
displayed			

REMOTE SLIP PRINTER OPERATION (OPTIONAL)

The TEC Remote Slip printer DRS-105 may be connected to the MA-1060-100 series ECR as an optional device. The Remote Slip Printer will operate printing if a slip is properly inserted, regardless of the Mode Lock position of the ECR.

1. The remote slip printer will automatically activate printing when the slip is properly set to the printer table.
2. No selection is provided for remote slip printer compulsory status.
3. The following are the optional selections available if the remote slip printer is connected:

1) PRINTING POSITION

Address #10 Bit 1:

RESET (standard): Prints every item on the right side of the slip.

SET (option): Prints items of Departments, PLUs, %+, %-, and Discount on the left side of the slip. Other items will be printed on the right side.

2) PRINT ITEM SELECTION

Address #10 Bit 2:

RESET (standard): Prints every item as printed on the receipt as long as the slip is set. (If only a certain item is printed and other items must be skipped, insert the slip just before the required item and withdraw the slip before operating other items.)

SET (option): Prints the new balance item of every charge posting operation. No other items (disregarding whether a charge posting operation or other registrations without previous balance) will be printed on the remote slip even if a slip is inserted.

3) TOTAL PRINT SINGLE OR DOUBLE SLIP

Address #10 Bit 3:

RESET (standard): Prints the sale total line only once just as on the receipt. (Single Slip)

SET (option): Prints every sale total line twice with unprinted lines fed inbetween. (Double Slip)

4) TOTAL PRINT DOUBLE SLIP WITH OR WITHOUT TRAILER LINE

Address #10 Bit 4: (This Bit is effective only when Bit 3 is selected to the "SET" status.)

RESET (standard):

The second total line is printed WITHOUT THE TRAILER LINE, in the Double Slip form.

SET (option): The second total line is printed WITH THE TRAILER LINE as well as the first total line, in the Double Slip form.

* "TRAILER LINE" means the print line routine of Date, Register No., Clerk ID, Receipt Consecutive No., and Time.

4. The gap of the slip inlet is usually opened, and the slip may be inserted or withdrawn freely.

When a slip is properly set to the remote slip printer and the ECR is operated, the gap will be closed and printing will be performed. When the sale is finalized, the receipt is issued and then the gap of the DRS-105 will be opened to allow the slip withdrawal. (The gap keeps closed during registration.)

5. Printing on the remote slip will be performed alternately with printing on the receipt/journal of the ECR.
6. The EJECT Key on the DRS-105 may be used to open the closed gap in order to withdraw the slip and skip unnecessary item print. The EJECT key will be disregarded if the slip is set and the ECR receipt/journal printer is in a printing action.

7. Printing Position and Slip Size

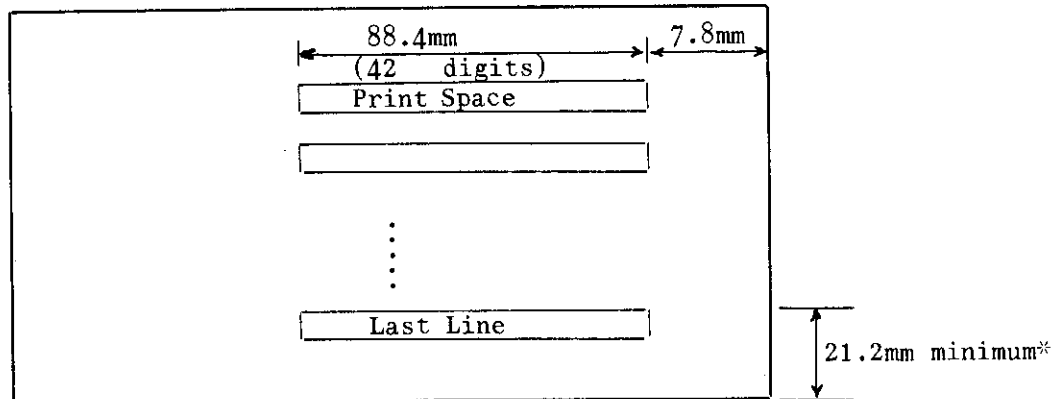

*NOTE: The space below the "Last Line" (i.e. the 21.2mm area at the bottom) cannot be printed.

REMOTE SLIP

RECEIPT

```

┌       ┐
└       ┘
05-04-83 #1111
RTN
DP01      1.20-T
      15X  1.30@
DP02      19.50 T
Z+         10%
           1.95
DISC       1.00-
SUBTL     19.25
#1234
TAX        0.03
CASH     19.28
ITEM      14
1CL      0015 13:32
    
```

Optional Print Position
 (Department, PLU, %+, %-,
 and Dollar Discount items
 are printed on the left
 side. Other items are
 printed on the right side.)

Standard Print Position
 (All items are printed
 on right side.)

System Option
 Address #10
 Bit No.1 to "SET"

```

┌──────────┐
RTN
DP01      1.20-T
      15X  1.30@
DP02      19.50 T
Z+         10%
           1.95
DISC       1.00-
└──────────┘
    
```

```

RTN
DP01      1.20-T
      15X  1.30@
DP02      19.50 T
Z+         10%
           1.95
DISC       1.00-
SUBTL     19.25
#1234
TAX        0.03
CASH     19.28
ITEM      14
1CL      0015 13:32
    
```

05-04-83 #1111

CUTTER BLOCK OPEN DETECTOR AND PAPER NEAR-END DETECTOR

1. CUTTER BLOCK OPEN DETECTOR

- (1) This detects when the Cutter Block of the Printer is opened. It is provided in order to protect your hands and fingers from injury and also to protect the printer itself.
- (2) While the Block is opened, none of the keys (including **[RF]** and **[JF]**) will be accepted and the AMOUNT portion of the display will keep flashing.
- (3) When the Block is closed and the **[C]** key is depressed, the display flashing will be cleared and key-in operations will be accepted. If the Block was opened during printing, the suspended printing will be started again.
- (4) If the Block is opened during printing, the printing will immediately be stopped.

2. JOURNAL AND RECEIPT PAPER NEAR-END DETECTOR

- (1) This detects when either the journal or receipt paper is coming near the end. It is provided in order to prompt the operator to replace the old paper roll with a new one.
- (2) When the paper roll comes near the end (or the paper has not been set properly), no key operation (except **[RF]** and **[JF]**) will be accepted and the AMOUNT portion of the display will keep flashing.
- (3) When a new paper roll is set, only the **[RF]** and **[JF]** keys are allowed to operate. Next, when the **[C]** key is depressed, the display flashing will be cleared and normal key-in operations will be accepted. If any printing was suspended, it will continue printing.
- (4) If this detector sensed a paper near-end condition during printing, printer will stop after the current line printing is completed.
- (5) The **[RF]** and **[JF]** keys are operative regardless of the detector ON/OFF condition.
- (6) If the **[C]** key is depressed in the the paper-end condition, it will be ignored. The **[C]** key depression will be effective to clear the display flashing only after the new paper roll is set.

ECR PRINTER MOTOR LOCK AND REMOTE SLIP PRINTER MOTOR LOCK DETECTORS

1. PRINTER MOTOR LOCK DETECTOR

- (1) This detects the ECR printer motor lock condition caused by some trouble.
- (2) When such a condition is detected, the front display indicates "Error" and none of the keys (including **RF** and **JF**) will be accepted.
- (3) To regain the normal condition, turn the power of the ECR to OFF, remove the cause of the motor lock, and then turn the power to ON again.

2. REMOTE SLIP PRINTER MOTOR LOCK DETECTOR

- (1) This detects the remote slip printer motor lock condition caused by some trouble.
 - (2) When such a condition is detected, the front display indicates "Error" and none of the keys (including **RF** and **JF**) will be accepted.
 - (3) To regain the normal condition, turn the powers of the ECR and the remote slip printer to OFF, remove the cause of the motor lock, and then turn the powers to ON again.
- * If the cause can not be found in the remote slip printer and only the ECR may be required to work without the remote slip printer temporarily, remove the remote slip printer cable from the ECR, and turn the power of the ECR to ON.

PAPER ROLL REPLACEMENT AND OTHER MAINTENANCE OPERATIONS

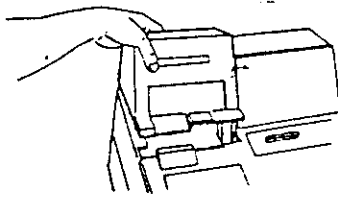

Fig. 1

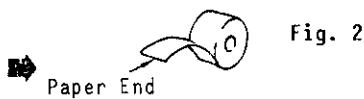

Fig. 2

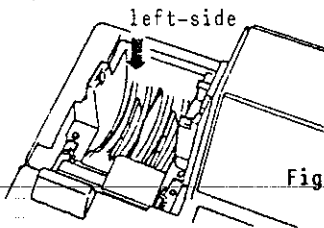

Fig. 3

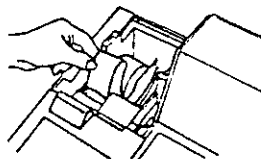

Fig. 4

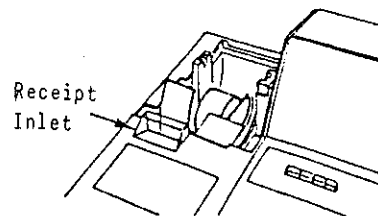

Fig. 5

INSTALLING THE RECEIPT PAPER

1. Turn the Mode Lock to the "REG" position.
2. Remove the Receipt Cover by pulling it upward (Fig. 1).
3. Set the new paper roll in the receipt roll holder with the paper end fed from the bottom as shown in Fig. 2 (Fig. 3).
4. Insert the paper end into receipt inlet as holding the **RF** key pushed down (Fig. 4).
5. When the paper comes out of the receipt outlet for approx. 5cm (or 2 inches), release the **RF** key (Fig. 5).
6. Attach the Receipt Cover. Meanwhile, the paper end must be seen outside the cover.
7. Press the **C** key to clear the paper-end condition, and depress the **NS** key and cut the issued receipt to check if the paper has properly set.

REMOVING THE RECEIPT PAPER

1. Remove the Receipt Cover by pulling it upward (Fig. 1).
2. Pull the Free Lever frontward while pulling the old paper core upward to remove the remaining receipt paper tail (Fig. 6).

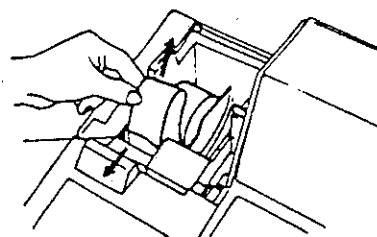

Fig. 6

INSTALLING THE JOURNAL PAPER

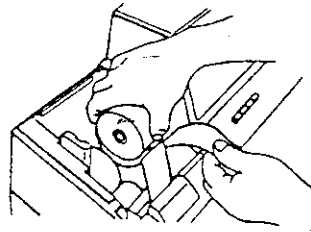

Fig. 7

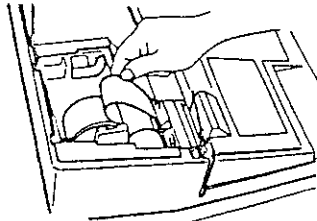

Fig. 8

1. Turn the Mode Lock to the "REG" position.
2. Remove the Receipt Cover by pulling it upward (Fig. 1 on the previous page).
3. Remove the Journal Winding Reel.
4. Set the new paper roll in the journal roll holder (righthand side) with the paper end from the bottom (Fig. 7).
5. Insert the paper end into the journal inlet while holding the **JF** key pushed down (Fig. 8).
6. When the paper comes out of the journal outlet for approx 20cm (or 8 inches), release the **JF** key (Fig. 9).
7. Wind up the paper end on the Journal Winding Reel two or three times as shown in Fig. 10.
8. Set the Journal Winding Reel to the holder (Fig. 11).
9. Attach the Receipt Cover (Fig. 12).
10. Depress **C** key before starting operations.

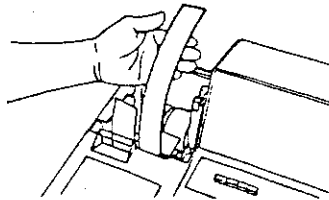

Fig. 9

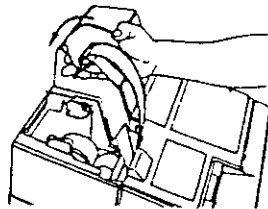

Fig. 10

REMOVING THE JOURNAL PAPER

1. Remove the Receipt Cover by pulling it upward (Fig. 1 on the previous page).
2. Depress **JF** key to wind up enough portion of the journal paper, and then tear off the paper, holding the Journal Winding Shaft.
3. The wound-up portion of the paper can easily be removed from the Winding Shaft by pulling it side way (Fig. 13).
4. If enough paper remains on the roll, follow Steps 6 through 10; if paper is running out, follow Steps 1 through 10 in "INSTALLING THE JOURNAL PAPER" above.

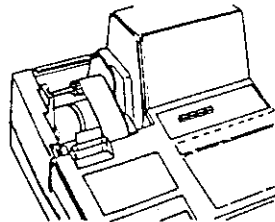

Fig. 11

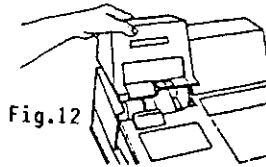

Fig. 12

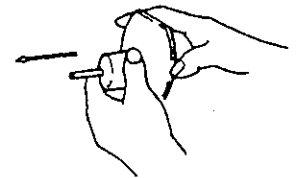

Fig. 13

REPLACING THE INK RIBBON

When the receipt and journal print is too light, replace the ink ribbon in the following manner.

Removing the Ribbon

1. Turn the Power Switch to OFF.
2. Remove the Ribbon Cover. Press the side inward and the hook will unlocked (Fig.14).
3. Open the Cutter Block by pulling it upward while pressing the leftside lever outward. (Fig. 15 and Fig. 16)
4. Remove the Ink Ribbon by lifting up the ribbon spools (Fig. 17).

Installing the Ribbon

1. Set the ribbon spools so that the ribbon will be wound to the directions shown by the arrows respectively. Meanwhile, let the ribbon go through the Ribbon Guides, the Tension, and the Dot Head Ribbon Guide (Fig.18 and Fig.19).
2. After setting, make sure that the ribbon properly goes through each required parts by turning a ribbon spool several turns.
3. Close the Cutter Block. Make sure that the leftside lever has locked the block.
4. Turn the Power Switch to ON.
5. Depress **C** key. The flashing display will stop and be lit steadily.
6. Attach the Ribbon Cover.

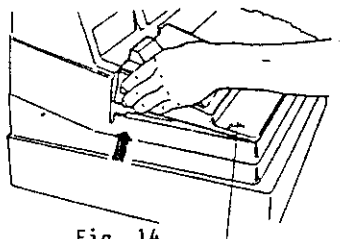

Fig. 14

Ribbon Cover

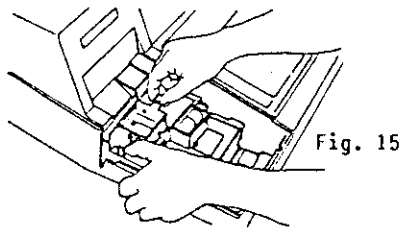

Fig. 15

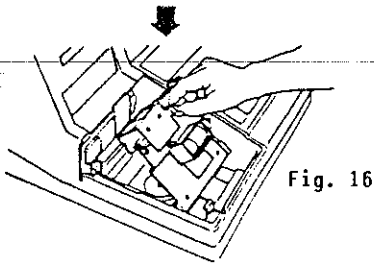

Fig. 16

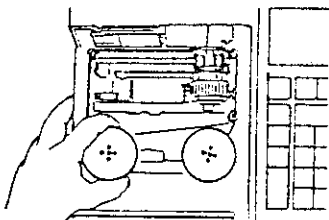

Fig. 17

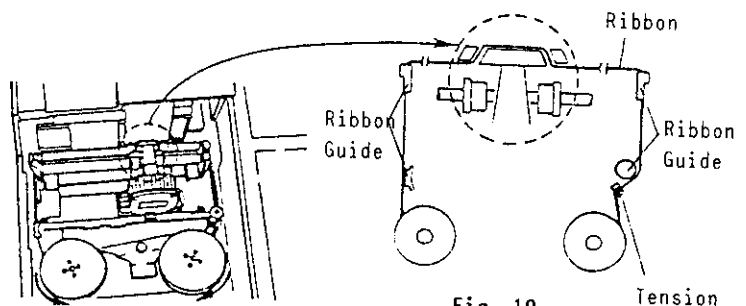

Fig. 19

Fig. 18

REPLENISHING THE STORE NAME STAMP WITH INK

When the store name stamp is printed too lightly, replenish the ink in the following manner.

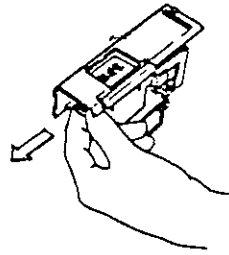

Fig. 20

1. Turn the Power Switch to OFF.
2. Remove the Ribbon Cover (Fig. 14).
3. Open the Cutter Block (Fig.15 and Fig.16).
4. Draw out the store name stamp in the direction shown in Fig.20 with the protruding part pinched with your fingers (Fig. 20).
5. Apply ink on the pad on the rear side of the Store Name Stamp. The amount of the refilling should be adjusted according to the density of the printed message, but the limit of 2 c.c. should not be exceeded. (The ink bottle supplied contains 5 c.c. of ink.) (Fig. 21)

NOTES: 1) Replenish the ink drop by drop several times until the pad will not absorb any more.

2) Use the TEC genuine ink for replenishment.

Ink Bottle

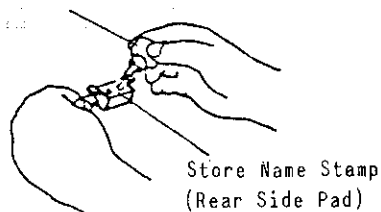

Fig. 21

6. Re-assembly is the reverse procedure. (Fig. 22) Let Point "B" of the Stamp fit to Point "A" of the Stamp Holder, push the stamp all the way in until a "click" is heard.
7. Close the Cutter Block.
8. Turn the Power Switch to ON.
9. Depress the **[C]** key. The flashing display will stop and be lit steadily.
10. Depress the **[NS]** key to issue a receipt. Repeat this to check if the printout will turn out all right.
11. Attach the Ribbon Cover.

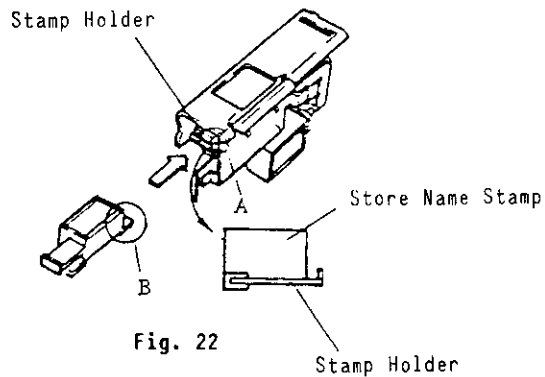

Fig. 22

CLEANING THE SLIP DETECTOR

Clean the slip detector when replacing the receipt roll, journal roll, or ink ribbon.

If the slip detector has not been cleaned for a long period of time, the cash register may fail to be registered on. In such a case, the "SLP" lamp will keep lit on. This is the same state as a validation slip is inserted because of paper dust deposited on the slip detector.

How to Clean the Slip Detector

1. Turn off the power switch.
(The power switch is located on the right side of the register.)

Power Switch

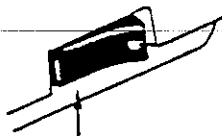

Push

2. Remove the ribbon cover.

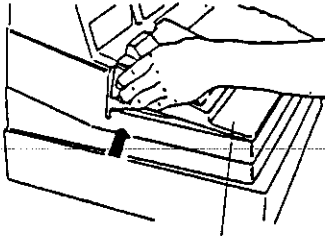

Ribbon Cover

The cover is unhooked when slightly pushed in the direction of the arrow.

3. Open the cutter cover.

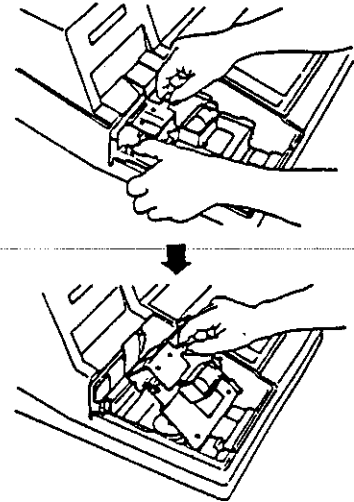

4. The slip detector is indicated by the arrow.

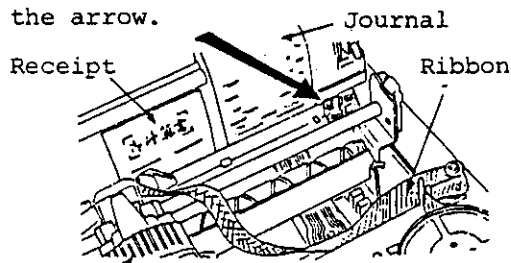

Dot Head

If the dot head is located on the right side of the machine, close the cutter cover and turn the power ON, and the dot head will move and stop on the left side.

5. Clean the slip detector with a brush.

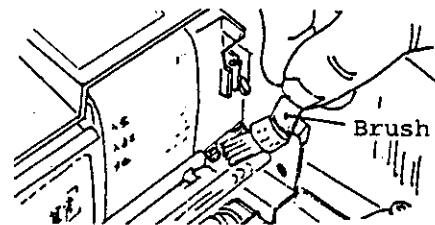

Brush

After cleaning, make sure that the ink ribbon is properly mounted on the ribbon guide.

6. Close the cutter cover.
(Securely hook the cover on the left side.)

7. Turn on the power switch.

NOTES:

1. If the display is blinking it indicates that the cutter cover is not properly closed. Securely close the cover.
2. Depress the **C** key. The display should turn lit.

8. Depress the **NS** key to issue a receipt. Check that the receipt is printed normally.

9. Install the ribbon cover.

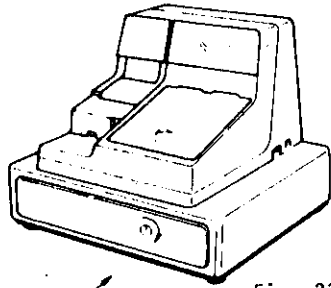

Fig. 23



Drawer Release Key

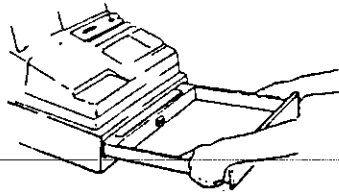

Fig. 24

OPENING THE DRAWER

The drawer opens automatically when a registration is finalized. In the event of a power failure or a trouble, however, open the drawer in the following manner.

Insert the Drawer Release Key into the Drawer Release Lock and turn the key by 45 degrees clockwise. (Fig. 23)

REMOVING THE DRAWER

1. Lift the drawer up and pull it out.
2. Then let it go down and pull it out again, and it will be removed.
3. When getting back the drawer, fit its rollers on the rails of the register and push it all the way in. (Fig.24)

WHEN A POWER FAILURE OCCURS ...

If a power failure occurs, all sales data stored in the memories are automatically protected by the battery installed in the ECR. The battery is rechargeable and it is recharged when the AC power returns. As the power returns, the register revives to continue the work. However, please note the following phenomena to occur on the register when the power is regained:

1. The printer will work to print the entered data without failure after the power recovery, if any data was being printed. However, one extra line may be fed on the power recovery depending on the power failure timing.
2. When the power is restored, the register will display the last item entered before the power failure if the item was entered through a motorized key (such as **DEPT**, media keys, etc.). In this case,, continue the registering operation. However, if the register displays "FAIL" when the power is restored, it indicates that the last item entry was not completed (i.e., only numeric keys or a declaration key such as **RTN MDSE** were operated but not any motorized key). In this case, first depress the **C** key to clear the "FAIL" condition, and then do the registering operation again from the numeric or declaration key entry. In the event of a power failure and its recovery, be sure to check the receipt before it is handed to the customer.

SPECIFICATIONS

Size	460mm(width) x 400mm(depth) x 375mm(height) with a SP Drawer
	397mm(width) x 423mm(depth) x 362mm(height) with a Midi Drawer
Weight	19kg with a SP Drawer
	19.5kg with a SP Drawer and Remote Display
	17.5kg with a Midi Drawer
	18kg with a Midi Drawer and Remote Display
Power Required	AC100V 50/60Hz
	AC110V (Varies depending on the destination.)
	AC117V
	AC220V
	AC240
Power Consumed	Max. 35W (0.4A at 117V)
Ambient Temperature	0°C to 40°C, 10% to 90% Relative Humidity
Size of Receipt and Journal Tape	
.....	38mm(width) x 80mm(diater) x 0.07-0.09mm (thickness)

Free Manuals Download Website

<http://myh66.com>

<http://usermanuals.us>

<http://www.somanuals.com>

<http://www.4manuals.cc>

<http://www.manual-lib.com>

<http://www.404manual.com>

<http://www.luxmanual.com>

<http://aubethermostatmanual.com>

Golf course search by state

<http://golfingnear.com>

Email search by domain

<http://emailbydomain.com>

Auto manuals search

<http://auto.somanuals.com>

TV manuals search

<http://tv.somanuals.com>