

Owners Manual

TEC ELECTRONIC CASH REGISTER

MA-1100-100 SERIES

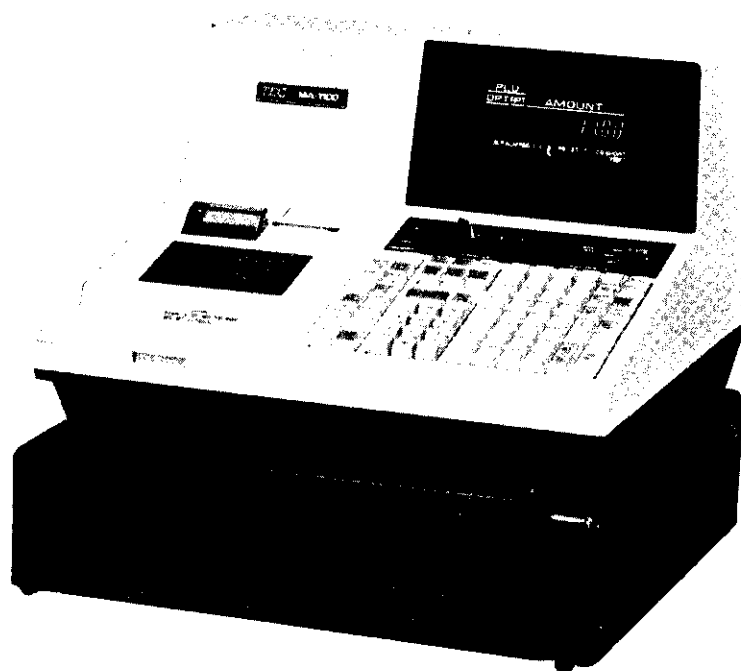

TEC TOKYO ELECTRIC CO.,LTD.

Download from www.somanuals.com. All Manuals Search And Download.

TABLE OF CONTENTS

	page
TO OUR CUSTOMERS	1
PRECAUTIONS	1
APPEARANCE AND NOMENCLATURE	1
CONTROL LOCKS AND MODE SELECTOR KEYS	2
DISPLAY	4
KEYBOARD LAYOUT	5
FUNCTION OF EACH KEY	6
OTHER OPTIONAL KEYS	21
REGISTERING PROCEDURE FOR SALES	24
READ(X) AND RESET(Z) REPORTS	45
PROGRAMMING OPERATIONS IN "SET" MODE	61
PROGRAMMING OPERATIONS IN "MGR" MODE (MANAGER'S PROGRAMMING)	106
CHARACTER CODE TABLE	113
PROGRAMMING OPERATIONS THROUGH THE PROGRAMMING KEYBOARD (optional)...	114
VERIFICATION OF PROGRAMMED DATA	117
REMOTE SLIP PRINTER OPERATION (optional)	121
CUTTER BLOCK OPEN DETECTOR AND PAPER NEAR-END DETECTOR	124
ECR PRINTER MOTOR LOCK AND REMOTE SLIP PRINTER MOTOR LOCK DETECTORS..	125
PAPER ROLL REPLACEMENT AND OTHER MAINTENANCE OPERATIONS	126
WHEN A POWER FAILURE OCCURS	130
SPECIFICATIONS	131

TO OUR CUSTOMERS

Thank you for choosing a TEC electronic cash register MA-1100-100 series. This instruction manual provides a description of the functions and handling of this register and should be read carefully to obtain maximum performance. Since every consideration has been given to safety, there is no danger of damaging the machine by incorrect operation.

Please refer to this manual whenever you have any doubts concerning the machine. This machine has been manufactured under strict quality control and should give you full satisfaction. However, if the machine is damaged during transit, or there are any unclear points in this manual, please contact your local TEC representative.

- The specifications described in this manual may be modified by TEC, if necessary.
- Be sure to keep this manual for future reference.

PRECAUTIONS

1. The keys on the keyboard work with a light touch. Avoid pressing the keys too hard.
2. Avoid handling the machine with wet hands.
3. Do not apply thinner or other volatile oils to the cabinet or other plastic parts. If dirty, wipe off with a piece of cloth soaked in neutral detergent and squeezed tightly.

APPEARANCE AND NOMENCLATURE



- **Power Switch** ... The power switch is provided at the righthand side of the cabinet. The AC power is turned on when the switch is pushed to ON, and turned off when the switch is pushed to OFF.

CONTROL LOCKS AND MODE SELECTOR KEYS

MODE LOCK

(POSITION)

(FUNCTION)

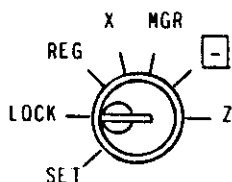

LOCK The register operations are locked when the Mode Lock is set to this position. Displays the current time in the front display as a standard feature.

REG Normal cash register operations are carried out in this mode. However, the operations using the keys that have been programmed to require the "MGR" position cannot be done in this mode.

X The sale totals can be read and the programmed data can be verified in this position.

MGR This position allows to register all normal cash register operations to be carried out in the REG mode and the operations using the keys that have been programmed to require the MGR position.

 This is the "Negative Mode", which automatically processes all the entries in the reverse way, i.e., positive items into negative, and the negative into positive.

Z All the resettable totals and their respective counters will be read and reset in this position.

SET In this position, the register will allow programming operations.



REG Key

The REG Key is used by the cashier who operates the register. This key can access the positions of LOCK and REG.

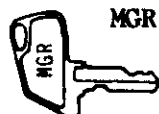

MGR Key

The MGR Key is used by the store manager or a person authorized by the manager. This key can access the positions of LOCK, REG, X, and MGR.



MA Key

The MA Key is used by the store manager who will daily supervise the collection of money and the printout of transactions recorded by the register. This key can access the positions of LOCK, REG, X, MGR, , and Z.

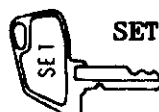

SET Key

The SET Key is used by the programmer. This key can access the positions of LOCK and SET.

CLERK LOCKS

Lock-and-Key Type (Standard)

These locks are used to identify which clerk is operating the register.

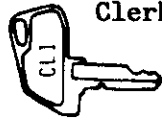
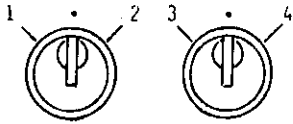

Clerk Keys (CL1, CL2, CL3, CL4)

Each clerk should keep his/her clerk key. The register will not operate unless one of these keys is inserted and set to the corresponding position on the Clerk Locks. Each of the keys may be inserted and pulled out in the neutral position marked with the "." (point).

Push-key Type (Alternative Option, for ten clerks)

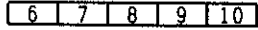
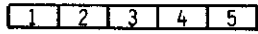

This type may be installed in place of the Clerk Locks above, as an alternative option. In that case, ten clerk keys will be installed. Each clerk is assigned to his/her own clerk key (1 through 10). The register will not operate unless one of these keys is pushed to stay down.

GT LOCK

This lock is provided to read or reset the accumulated sales totals not on the daily but on weekly or monthly basis.

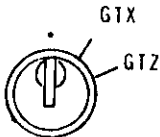

GTX Position:

This position allows to read the accumulated totals.

The GTX key as well as GTZ Key can access this position.

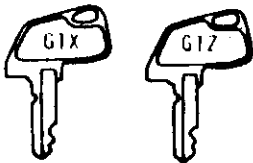

GTZ Position:

This position allows to read and reset the accumulated totals.

The GTZ Key only can access this position.

NOTE: When the GT Lock is turned to either the GTX or GTZ position, the Mode Lock position or any Clerk Key ON/OFF condition will be disregarded.

DISPLAY

The front display is located at the top of the register just above the keyboard. The display has two types of display -- numeric display and message descriptors.

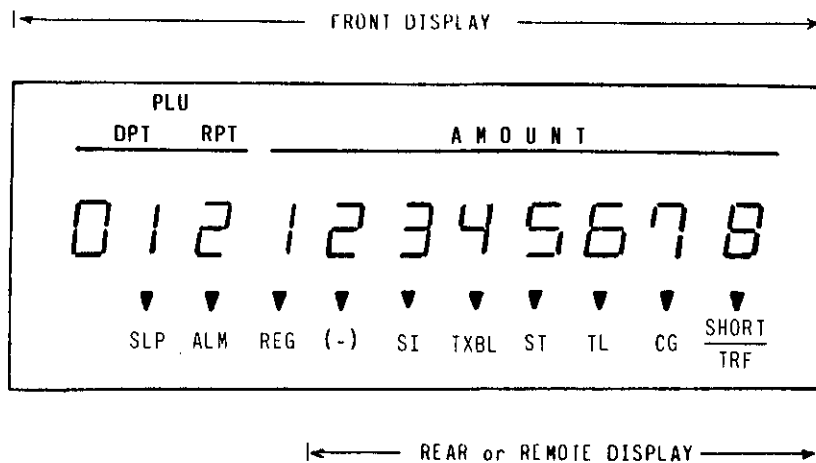

Numeric Display

- AMOUNT (8 digits) Displays the numeric data, such as amount, quantity, etc.
- DPT (2 digits) Displays the code which represents each Department Key. It stays lit when repeating the same department entry.
- RPT (1 digit) Displays the repeat department entry count. The count is indicated from the second entry on, and only the first digit will be displayed even if the count exceeds nine.
- PLU (3 digits, commonly used with the DPT and RPT digits) Displays the PLU code when any PLU is entered. It goes out when repeating the same PLU entry.

Message Descriptors

- SLP Lights up when a slip has been properly inserted and set to allow validation. It flashes to require a slip insertion when validation compulsion has been programmed on the transaction key just operated.
- ALM Lights up with the alarm buzzer to indicate that the last operation or numeric entry has resulted in an error. To clear the error condition, depress the **[C]** key.
- REG Lights up when sale items have been registered.
- (-) Lights up when the **[RTN MDSE]**, **[DOLL DISC]**, or any other key that registers a negative amount has been operated. It also lights up when the **[ST]** or one of the total keys has been depressed and the displayed amount is negative. It lights up also when an amount is entered in the "**[=]**" mode.

- SI Lights up when a department or PLU item that has been netted to the S.I. (Selective Itemizer) is entered, or when the SI/TL key is operated.
- TXBL Lights up when a taxable department or PLU is entered. It also lights up with the "ST" Lamp when the TXBL TL key is depressed.
- ST Lights up when the sub-total amount is displayed after the ST key has been depressed.
- TL Lights up on a finalizing operation with the total amount displayed when finalized without any amount tendered.
- CG When an amount tendering operation has been performed, this lamp lights up with the change due displayed.
- SHORT Lights up when the amount tendered is less than the sale total with the shortage amount displayed.
- TRF Lights up also when all the sale balance are transferred to the new sale balance for post charging.

KEYBOARD LAYOUT

The following is a typical keyboard layout for the MA-1100-100 series. Since this series is designed to be capable of programming most of the keys to be placed in the desired place on the keyboard, this is merely an example. Please ask your TEC representative if any other alternative or additional keys must be installed, referring to the description of the "FUNCTION OF EACH KEY" and "OTHER OPTIONAL KEYS" in this manual.

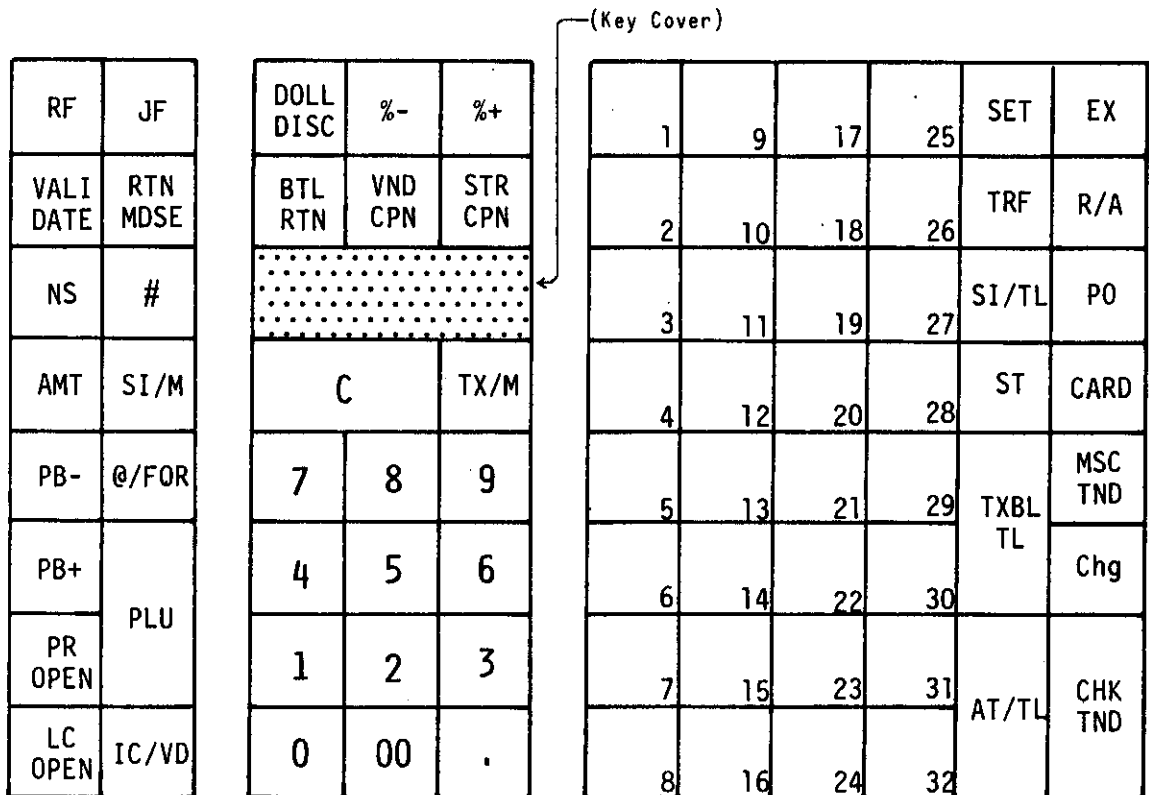

FUNCTION OF EACH KEY



RECEIPT

RECEIPT ON/OFF SWITCH

This switch has two positions available -- 'OFF' position and 'ON' position. When in the 'OFF' position, no receipt is issued from the register and sales are printed on the audit roll only. When the switch is turned to the 'ON' position, sales are printed on both the receipt roll and audit roll, then a receipt is issued which is automatically cut off and given to the customer.

RF

RECEIPT FEED KEY

This key is used to advance the receipt roll. It is operated by depressing the key and holding it in that position until the paper has advanced to the required position. This key is effective even when the RECEIPT ON/OFF SWITCH is in the 'OFF' position. It can be programmed to prohibit receipt feeding during a sale.

JF

JOURNAL FEED KEY

This key is used to advance the audit roll in the same fashion as the RF key. These two keys are useful if the cashier, due perhaps to an interruption whilst ringing up a sale, is unsure which items have already been entered. By using the feed key the cashier can see which figures have actually been printed.

The RF and JF keys can not be operated simultaneously.

VALIDATE

VALIDATION KEY

This key is used to over-print a validation slip.

To operate, after registering an item or finalizing a sale, insert a slip into the validation slot and depress the **VALIDATE** key. The item and the amount will be printed on one line on the slip. Print or non-print of the date and/or consecutive No. is a programmable option.

Programmable selections are also provided as to single or multi validation, validation compulsion on certain transaction keys, etc.

If the SLP Lamp flashes, it means that validation compulsion is programmed for the last item entered. In this case, insert a slip into the validation slot and depress the **VALIDATE** key; no other operation is allowed until the compulsory validation has been executed.

**RTN
MDSE**

RETURNED MERCHANDISE KEY

This key is the Returned Merchandise Key which is used for refunding money to a customer who has returned goods to the store.

To operate, depress the **RTN MDSE** key either before or after ringing up the amount to be refunded, and then depress the appropriate department key (the department key may be replaced by a PLU code and the **PLU** key combination). The amount is automatically printed and deducted from the bill.

The **RTN MDSE** key can be used outside as well as inside a sale.

NS

NO-SALE KEY

This key is used to open the cash drawer while the machine is outside a sale. To operate, depress this key once. A non-add number may usually be entered prior to a no-sale operation. However, it can be programmed to prohibit it when a no-sale is operated.

SI/M

SELECTIVE ITEMIZATION MODIFIER KEY

This key is used to reverse the S.I. (selective itemization) status programmed on each Department or PLU.

To operate, depress the **SI/M** key prior to entering a department or PLU item. The item is then reversed from S.I. to non-S.I., or from non-S.I. to S.I.

**LC
OPEN**

LISTING CAPACITY OPEN KEY

This key is used to release the listing capacity on each Department or finalizing (media) key. To operate, depress the **LC OPEN** key before depressing the department or finalizing key (either before or after the numeric entry).

By depressing the **LC OPEN** key, the HALC (High Amount Listing Capacity) will be released to allow a numeric entry with two further digits, and the LALC (Low Amount Listing Capacity) will be one digit less than the programmed value, as to the department keys. As for the finalizing keys, the HALC will be extended to allow one further digit.

In order to allow a numeric entry outside the values defined above, the Mode Lock must be turned to the 'MGR' position using the MA or MGR Key.

Repeat operation will be possible on any department key even when the **LC OPEN** key is depressed before the department key.

AMT

AMOUNT KEY

This key is used to enter an amount or price for an open PLU. Refer to the description for the "**PLU**" key on page 9.

PR
OPEN

PRESET OPEN KEY

This key is used to modify the status of preset department keys. When the **PR OPEN** key is depressed prior to depressing a preset department key (either before or after the numeric entry), the preset department key is reversed to an open department key and allows amount entry through the numeric keyboard.

If a preset department is entered with a price through the numeric keyboard using the **PR OPEN** key, no repeat operation is then possible using that department key; however, the **RPT** (Repeat) key makes it possible if installed on the keyboard.

The **PR OPEN** key cannot be used with the **PLU** key.

@/FOR QUANTITY EXTENSION / SPLIT-PRICING KEY

This key is used to multiply a department or PLU item entry by a quantity. This key is also used for split pricing of a department or PLU.

The basic order of multiplication is:

|QUANTITY| → **@/FOR** → |PRICE|

As for details of multiplication and split pricing for various cases, refer to the "REGISTERING PROCEDURE FOR SALES".

The quantity can be of maximum of 3 integral digits and 3 decimal digits. The price can be of maximum 6 digits. The product must not exceed 8 digits.

Usually, the fraction below the least effective digit will be rounded off. However, it may be programmed to be discarded or rounded up by the system option.

PB+, **PB-** PREVIOUS BALANCE KEYS

These keys are used to enter a previous balance in a charge posting operation. If a previous balance is entered, then the operation becomes a charge posting operation, and the **Chg** (Media 2 Key) must be used at the end of the operation. (See the "REGISTERING PROCEDURE FOR SALES" as to detail operations to follow the **Chg** key in charge posting.)

A previous balance may be entered anywhere and any number of times during a sale. The **PB+** key is used to post a debit balance and the **PB-** key is used to post a credit balance. To initiate a charge posting operation where no previous balance exists, then enter "0" (zero) as a past balance, followed by **PB+** or **PB-** key.

If the **TXBL TL** key is depressed during a charge posting, the displayed amount does not include the previous balance. However when the **Chg** key is depressed to end the charge posting, the displayed and printed amount includes the previous balance.

If the $\boxed{\%+}$ key is used immediately after a previous balance entered through the $\boxed{PB+}$ key, the percent rate is added to the previous balance. But the $\boxed{\%-}$ key cannot be used in this case. Neither may the $\boxed{\%+}$ or $\boxed{\%-}$ key be used immediately after a previous balance entered through the $\boxed{PB-}$ key.

\boxed{PLU} PLU (Price-Look-Up) KEY

This key is used to enter a PLU that is linked to a department. Each PLU can be programmed to be preset PLU (to allow the preset price entry only) or an open PLU (to allow a price entry through the numeric keys each time).

TO ENTER THROUGH PRESET PLU:

$\boxed{PLU\ Code}$ → \boxed{PLU} The preset price will automatically be read and entered.
1~3 digits
to repeat the same PLU price, depress the \boxed{PLU} only, after the above operation.

TO ENTER THROUGH OPEN PLU:

$\boxed{PLU\ Code}$ → \boxed{PLU} → \boxed{PRICE} → \boxed{AMT}
1~3 digits
..... The price indexed on the numeric keys will be entered.
To repeat the same PLU price, depress the \boxed{AMT} key only, after the above operation.

As for quantity extension and split pricing involving PLUs, refer to the "REGISTERING PROCEDURE FOR SALES".

Each PLU is programmed with a 3-digit PLU Code, a 2-digit linked Department Code, and if used as a preset PLU, a maximum of 6-digit preset price (5-digit for UK and BE versions). Each PLU is also programmed with the S.I. or non-S.I. status.

$\boxed{IC/VD}$ ITEM CORRECT / VOID KEY

This is a dual-function key that has both $\boxed{ITEM\ CORR}$ (Item Correct) and \boxed{VOID} (Designated Line Void) key functions. (These two keys can separately be installed as optional keys in place of the $\boxed{IC/VD}$ key.)

ITEM CORRECT FUNCTION:

If depressed (without a prior numeric entry) after an item-correctable entry, it functions as Item Correct key, removing the last item from the bill and printing a etched lined through that item on the receipt and journal.

The item-correct function is effective even when a numeric entry and a \boxed{C} key depression are done between the department entry to be corrected and the $\boxed{IC/VD}$ key depression.

**DOLL
DISC**

DOLLAR DISCOUNT KEY

This key is used to subtract an amount from the sale total such as a discount during a sale. An amount exceeding the sale total cannot normally be entered. However, when the "Credit Balance" option has been selected, over-subtraction of the sale total using this key is allowed.

To operate, enter the discount amount on the numeric keyboard, and then depress the **DOLL DISC** key.

%+

PERCENT CHARGE KEY

This key is used to add a percentage rate to a sale. If the pre-programmed percentage rate is to be added, depress the **%+** key without a prior numeric entry. If a rate different from the pre-programmed % rate is to be added, enter the desired rate on the numeric keyboard and then depress the **%+** key. (The manual rate will take priority.)

To operate, depress the **%+** key either immediately after a department entry if only that item requires the percentage addition, or after the **ST** key if required on the total bill. The percentage rate and the amount are printed and will be added to the sale total.

The percentage rate may be within the range from 0.001 to 99.999%. The fraction resulted from the percentage calculation is usually programmed to rounded off. However, it can be programmed to be rounded up or discarded.

Usually, if the **%+** key is depressed after a second **ST** key depression within a sale, it adds the rate to the entire sale total. However, it can be programmed to add the rate to the subtotal of the items entered between the first and the second **ST** key depressions.

%-

PERCENT DISCOUNT KEY

This key operates in the same fashion as the **%+** key except that operation will subtract from instead of adding to a sale.

C

CLEAR KEY

This key is used to correct a numeric entry error prior to depressing any other key, or to correct any error condition and cancel the alarm buzzer.

If the **C** key is depressed after a sub-total is obtained, the sub-total is again displayed.

**BTL
RTN**

BOTTLE RETURN KEY

This is a credit key to enter a bottle return amount. This key can be programmed as either a motorized inside-sale key or non-motorized department-linked key.

WHEN PROGRAMMED AS MOTORIZED INSIDE-SALE KEY:

To operate, enter the bottle return amount and then depress the **BTL RTN** key. The **BTL RTN** key functions like a negative department key.

The amount entered through the **BTL RTN** key must not exceed the sale total unless the "Credit Balance" option is selected.

The amount entered through the **BTL RTN** key will be limited by its own listing capacity. To release the limit, the Mode Lock must be turned to the 'MGR' position. The **LC OPEN** key will not be effective in this case.

WHEN PROGRAMMED AS NON-MOTORIZED DEPARTMENT-LINKED KEY:

To operate, depress the **BTL RTN** key either before or after the bottle return amount entry, and then depress the appropriate department key. The **BTL RTN** key functions like a **RTN MDSE** key.

The amount entered through the **BTL RTN** key will subtract the department total but not affect the department counter.

The bottle return amount must not exceed the sale total unless the "Credit Balance" option is selected.

The **PLU** key cannot be used with the **BTL RTN** key.

The amount entered through the **BTL RTN** will be limited by the HALC (High Amount Listing Capacity) of the department through which the amount is entered.

Quantity extension using the **BTL RTN** key (either type of the above two) is possible; however, decimal quantity is not allowed. Neither will split-price entry be allowed with the **BTL RTN** key.

None of the **RTN MDSE**, **VOID** (or **IC/VD** as Designated Line Void), and **STR CPN** keys will function with the **BTL RTN** key.

**VND
CPN**

VENDOR COUPON KEY

This is a motorized credit key to subtract vendor coupon amount from the sale.

To operate, enter the coupon amount and depress the **VND CPN** key. This operation can only be done inside a sale. The coupon amount to be entered must not exceed the sale total unless the "Credit Balance" option is selected.

The **VND CPN** key can be programmed with a listing capacity (a max. 4-digit amount), VAT status, validation compulsion, and manager intervention.

The **LC OPEN** key will not function to release the listing capacity above mentioned. The 'MGR' position of the Mode Lock will be required in this case.

Quantity extension is not possible using the **VND CPN** key.

**STR
CPN**

STORE COUPON KEY

This is a non-motorized credit key to subtract a store coupon amount redeemed through a department. Store coupon operations will net the department through which they are redeemed.

To operate, depress the **STR CPN** key either before or after the coupon amount entry, then depress the department key.

The **STR CPN** key does not have its own listing capacity programmed, and thus it follows each department listing capacity. The VAT status of the store coupon amount is also ruled by the department status.

The store coupon amount must be entered inside a sale and must not exceed the sale total unless the "Credit Balance" option is selected.

The amount entered with the **STR CPN** will subtract the Department Total memory, but does not affect the Department Item Counter memory.

Quantity extension will be permitted with this key, but no decimal quantity will be accepted. No PLU, Void, or Returned Merchandise, or Department-linked Bottle Return entries are possible with the **STR CPN** key.

Validation Compulsion and/or Manager Intervention may be programmed on the **STR CPN** key.

TX/M (for Single-tax Area)

TX1/M, **TX2/M** (for Dual-tax Area) TAX MODIFIER KEYS

Each of these keys is used to reverse the taxable/non-taxable status on departments other tax-programmable keys for one entry only. For dual-tax areas, two keys should be provided -- **TX1/M** and **TX2/M** -- in place of the **TX/M** key for the single-tax areas. The two tax modifier keys will function independently each with its own tax table pre-programmed for taxable items.

The tax modifier key(s) will be effective to reverse the tax status programmed on Department keys, **DOLL DISC**, **%+**, **%-**, **VND CPN**, **BTL RTN**, **STR CPN**, and PLUs.

To operate, depress the **TX/M** key prior to depressing any of these function keys above listed, i.e., either before or after the amount entry.

0 ~ 9, 00 NUMERIC KEYS

These keys are used to enter numeric values such as amount, quantity, or code number.

Depressing the **00** key once is the same as depressing the **0** key twice consecutively.

. DECIMAL POINT KEY

This key is used, as part of numeric keys, to designate the position of the decimal point when entering a percent rate or a quantity. For example, to enter 0.5%, index 0→**.**→5, or **.**→5. A maximum of three digits may be entered below the decimal point.

When entering a price or amount such as £0.25, just index 2→5. In this case, depression of the **.** key is not necessary and will cause an error.

1 ~ 32 DEPARTMENT KEYS

These are department keys through which sales items are registered. These key may be programmed as either 'PRESET' keys or 'OPEN' keys.

OPEN DEPARTMENT KEY:

A department key which has no preset price programmed is an 'OPEN' key and must have a price entered into it manually each time. The price is rung up on the numeric keyboard and the appropriate department key is depressed. The price is then displayed and printed on the receipt and audit rolls.

When the same department key is depressed more than once after a price entry, the price entry is repeated as many times as the department key is depressed.

To enter a price extended by multiplication, enter the quantity first, depress the **@/FOR** key, enter the price, and then depress the appropriate department key. A multiplication entry may not be repeated by depressing the department key again.

For split pricing, enter the purchased quantity, depress **@/FOR**, enter the whole package quantity next, depress **@/FOR** again, enter the whole package price, and then depress the department key.

PRESET DEPARTMENT KEY:

A preset key is a key which has already a price programmed in it. It is therefore unnecessary to enter the price of an item; simply depress the key to register the sale of one item.

To repeat the same preset item, depress the department key as many times as required.

To multiply a preset department price by a quantity, enter the quantity first, depress the **@/FOR** key (the **@/FOR** key may be omitted if the preceding quantity is a one-digit value), and then depress the preset department key.

For split pricing, enter the purchased quantity first, depress the **@/FOR** key, enter the whole package quantity next, depress the **@/FOR** key again, and then depress the department key.

If a non-preset price must be entered on the keyboard into a preset department, depress the **PR OPEN** key either before or after the price entry on the numeric keyboard.

Each department is also programmed with either positive or negative use, a HALC (High Amount Listing Capacity), LALC (Low Amount Listing Capacity), tax and S.I. (Selective Itemized) status. A maximum of 8 alpha/numeric characters can also be programmed for each department name.

A negative department item or a department item entered with **RTN MDSE**, **PR OPEN**, or **SHIFT** key can not be repeated.

A department key can also be programmed to be used as a "Single-item" Department key. If so programmed, the department entry routine above mentioned will immediately finalize the sale as cash without depressing any of the media key, when operated outside a sale. The Single-item Department key will function, however, just as an ordinary itemized department key if used inside a sale.

SET SET KEY

This key is used by the store manager to set or change programmed data which must change daily or weekly according to the requirements of the store. The items programmable with the **SET** key are included in those programmable in the 'SET' position of the Mode Lock. However, it may be more convenient for the manager to be able to change the program data by himself instead of asking to the programmer.

Detail operations using the **SET** key are described later in the "MANGER'S PROGRAMMING OPERATIONS". The following are the items that can be programmed or changed with the **SET** key:

1. COMMERCIAL MESSAGE
2. CLERKS' NAMES
3. DEPARTMENT PRESET PRICE CHANGE
4. PLU PRESET PRICE CHANGE
5. TIME ADJUSTMENT

EX TAX EXEMPT KEY

This key is used to declare the exemption of the taxes from the sale, displaying the sale total with taxes and printing the tax-exempted portion total. Only a finalizing operation is possible after a **EX** key depression.

The **ITEM CORR** key (or **IC/VD** used as Item Correct Key) can not function to delete a **EX** key entry.

If two tax modifier keys (**TX1/M** and **TX2/M**) are installed, tax-exemption may operate in any of the following three ways:

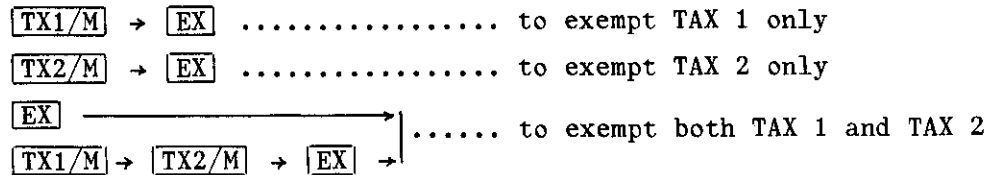

If only one tax modifier key (**TX/M**) is installed, operate the **EX** key alone for the tax exemption.

R/A RECEIVED ON ACCOUNT KEY

A received on account transaction is used to identify money which is in the drawer but not business. The amount entered is thus included in the "Cash-in-drawer" total but not in the sales totals.

To operate, enter an amount of payment and then depress the **R/A** key. Repeat this operation if multiple payments are entered at a time. The payments entered are finalized by the **AT/TL** key (if paid in cash). Other media keys may also finalize payments received on account if so programmed in the system option. The above operation can only be done when the register is outside a sale.

The **R/A** key is also used to declare the payment amount near the end of a charge posting operation. After depressing the **Chg** key to obtain the sale total, enter the amount portion to be paid in this sale and then depress the **R/A** key, followed by the media tendering or totalling operation. Refer to detail description in the "REGISTER PROCEDURE FOR SALES" as to this operation.

The **R/A** key is also used as the Loan Start Declaration key.

PO PAID OUT KEY

A paid out transaction is used when an amount of money is removed from the cash drawer without relating to a sale. When the **PO** key is used, the amount entered is subtracted from the "Cash-in-drawer" total but does not affect the sales totals.

To operate, enter an amount taken from the cash drawer and depress the **PO** key whilst the register is in an out-of-sale condition. This operation may be carried out as many times as required if multiple paid-out items are registered at a time. The paid-out amounts recorded are finalized by the **AT/TL** key only.

In a charge posting operation, this key is depressed to pay back all the balance to the customer, after once finalizing the account with the **Chg** key.

The **PO** key is also used as Pick Up Start Declaration Key when the Mode Lock is set to the 'MGR' position.

MEDIA 1 ~ 5 KEYS (**CHK TND** , **Chg** , **MSC TND** , **CARD** , **MEDIA 5**)

These media keys are used as alternative methods of payment for non-cash sales. Each of these keys is programmable as to its descriptor, use of tender and/or total key, corresponding media, no-sale cashing allowed/prohibited, over-tendering allowed/prohibited, validation optional/compulsion, etc. The following is the standard use of each key:

MEDIA 1 Key: **CHK TND** CHECK TENDERED KEY

- . Tender Key
- . Validation -- optional
- . Prints the tendered amount (not the sale total) when validated
- . No-sale cashing -- allowed
- . Over-tendering -- allowed
- . Media Total on In-drawer Report -- print
- . Finalization of **R/A** entries -- allowed

MEDIA 2 Key: **Chg** CHARGE TOTAL KEY

- . Total Key
- . Validation -- optional
- . Prints the sale total when validated
- . No-sale cashing -- prohibited
- . Media Total on In-drawer Report -- non-print
- . Finalization of **R/A** entries -- prohibited

MEDIA 2 Key is also used as the finalizing key for charge posting operations.

MEDIA 3 Key: **MSC TND** MISCELLANEOUS TENDERED KEY

- . Tender Key (for medias other than cash, cheque, card, and coupon)
- . Validation -- optional
- . Prints the tendered amount (not the sale total) when validated
- . No-sale cashing -- prohibited
- . Over-tendering -- allowed
- . Media Total on In-drawer Report -- print
- . Finalization of **R/A** entries -- allowed

MEDIA 4 Key: **CARD** CARD TOTAL KEY

- . Total Key
- . Validation -- optional
- . Prints the sale total when validated
- . No-sale cashing -- prohibited
- . Media Total on In-drawer Report -- non-print
- . Finalization of **R/A** entries -- allowed

MEDIA 5 Key: (optional media key)

- . Tender Key
- . Validation -- optional
- . Prints the tendered amount (not the sale total) when validated
- . No-sale cashing -- prohibited
- . Over-tendering -- prohibited
- . Media Total on In-drawer Report -- print
- . Finalization of **R/A** entries -- allowed

As for operations, refer to the description for the AT/TL key. Follow "AMOUNT TENDERED FUNCTION" if the media key is programmed as a "Tender Key", and follow "TOTAL FUNCTION" description if the media key is programmed as a "Total Key".

If the media key is programmed to allow "No-sale cashing": when the register is outside a sale, enter the tendered amount in that media, and depress the Media Key. A receipt is issued and the drawer is opened to enable exchange.

AT/TL CASH AMOUNT TENDERED / TOTAL KEY

This key is used to record all cash paid on transactions, and will be able to finalize a sale operation. Usually the key is programmed to function as both "Tender" and "Total" key. However, the key may be programmed to operate with enforced tendering or as a cash total key.

AMOUNT TENDERED FUNCTION

After the ST key has been depressed, enter the amount tendered by the customer in payment of the sale, and then depress the AT/TL key. The change is automatically computed, displayed, and printed.

If the amount tendered is smaller than the sale total, it prints the amount tendered on the receipt with the balance still due displayed, but the drawer is not yet opened. In this case, ask the customer for additional payment in cash and repeat the same amount tendering operation, or use another media key if the balance due is processed as a sale in that media.

NOTE: If the AT/TL key has been programmed to function as the "AMOUNT TENDERED" key only and the sale total is "0" or negative, no amount tendering can be entered. In this case, the AT/TL key will function as the "TOTAL" key, so just depress the AT/TL to obtain the total and finalize the sale. The balance in negative indicates that the amount must be paid back to the customer in cash. A negative-balanced sale can only be finalized by the AT/TL key, but not by any other media key.

TOTAL FUNCTION

To obtain the total and finalize a cash sale, depress the AT/TL key only. The sale is finalized with the total printed and displayed, and the drawer opens.

NOTE: If the "ST Compulsory" option has been selected in the system option, a ST key depression is always required before finalizing any sale.

If the "Total Validation" option has been selected, validation after the ST key depression will print the sale total (not subtotal) and thereafter only sale finalizing operation will be allowed.

If the "Total Validation Compulsory" option has been selected, the Total Validation operation will always be required before finalizing any sale.

The **AT/TL** key is also used to finalize received on account payments or paid out amounts.

The **AT/TL** key can be programmed with the HALC (High Amount Listing Capacity) of the amount tendered. If the HALC has been set, the amount tendered must not exceed the programmed value; otherwise, it will result in an error. If the **LC OPEN** key is used prior to the **AT/TL** depression, the HALC will be extended by one additional digit. If an amount still larger must be entered, the MA or MGR key is required to turn the Mode Lock to the MGR position.

ST SUB-TOTAL KEY

This key is used to obtain the sub-total amount during a sale. When this key is depressed after all the items have been rung up, the sub-total of the sale is printed and displayed.

If the **ST** key is depressed more than once consecutively, the first depression only will print and display the sub-total; further depressions will only display but not print the sub-total amount.

The system option provides the selection not to print but only display the sub-total even on the first depression of the **ST** key.

Mandatory depression of this key prior to finalizing is a programmable option.

In charge posting, a depression of the **ST** key displays the sub-total amount without previous balance.

TRF TRANSFER KEY

When a charge posting operation is ended with the **CRT** key, this key is used to transfer the entire balance with no payment.

To operate, depress the **TRF** key after the **CRT** key. All the balance is transferred, the transferred amount is printed as the new balance, and a receipt is issued. When the amount is less than 7 digits, the figures are printed in double-sized characters.

SI/TL SELECTIVE ITEMIZER TOTAL KEY

This key is used to display and print the selective itemizer content.

To operate, depress the **SI/TL** key without a numeric entry during a sale. At this time the content of the selective itemizer is cleared.

The **ITEM CORR** key does not function to delete the **SI/TL** key entry.

if the "SI/TL Composory" option is selected, no finalizing operation will be allowed until the **SI/TL** key is depressed to clear the S.I. content.

If the "SI/TL Non-print" option is selected, the content of the S.I. is displayed and printed only on the journal but not on the receipt.

If a preset % rate has been programmed on this key, the depression of the **SI/TL** key also calculates the amount automatically based on the preset rate will be printed. Also whether this calculated amount affects (add to or subtract from) the sale total or not is a programmable option. If no preset % rate has been programmed, the calculation will be based on the rate of 100%.

TXBL
TL

TAXABLE TOTAL KEY

This key is used to display the contents of the main itemizer (i.e., sale total) plus any taxes due. The amount will display only but not be printed.

In order to allow add-on operation following the use of this key, the taxes are not added into any totals until acutal finalization is initiated.

Mandatory depression of this key prior to finalizing is a programmable option.

If the "TOTAL VALIDATION" option is selected, depressing the **VALIDATE** key after a **TXBL TL** key operation prints the sale total on the validation slip, and therefore, only a finalizing operation then is allowed.

In charge posting, depressing the **TXBL TL** key displays the amount including taxes without the previous balance.

OTHER OPTIONAL KEYS

The following keys are not shown in the KEYBOARD LAYOUT on page 5. However, any of them may be installed if the customer requires. But please note that some of the present keys may have to be dispensed with or additional memories may have to be installed to gain additional functions. Please contact your TEC representative if any of the following keys is necessary.

Additional Department Keys

A maximum of 60 department keys including the present department keys may be installed.

SHIFT DEPARTMENT SHIFT KEY

This key functions similarly to the "Shift Key" on a regular typewriter keyboard, and shifts of two departments to the other programmed on one Department Key. For example, Department 1 Key can be used as Department 31 if the **SHIFT** key is depressed prior to **DEPT 1** key. In this case, the number of all the department keys on the keyboard must be 30 or less. Thus the keyboard can spare space to other function keys despite the number of departments.

The **SHIFT** key is effective to shift a department for only one entry; therefore, the shifted department can only be repeated by the **RPT** key but not by the department key.

RPT REPEAT KEY

This key is used to repeat a department or PLU entry. This key enables repeat entries not only for normal department or PLU items but also items modified with **PR OPEN**, **SHIFT**, etc.

OPEN LC-AND-PRESET OPEN KEY

This is a dual-function key that has both **LC OPEN** key and **PR OPEN** key functions.

#/NS NON-ADD NUMBER PRINT / NO-SALE KEY

This is a dual-function key that has both **#/CID** and **NS** key functions.

If depressed with a prior number entry, it will function as the Non-add Number Print key.

If depressed without a prior numeric entry, it will function as No-sale key.

It also functions as the Cash-in-drawer Read key if depressed in the "X" mode. It functions the same as the **#/CID** key in programming operations.

**RECEIPT
ISSUE****RECEIPT POST-ISSUE KEY**

This key is used to issue the receipt of a sale (prints the sale total only, not detail items) when the sale has already been finalized with the **RECEIPT ON/OFF** switch positioned to OFF.

To operate, depress the **RECEIPT ISSUE** key without numeric entry. The receipt for the last sale is then issued. This key will not function if another sale has already been under way.

Single-item Department Keys

Two ways are available for changing ordinary department keys into Single-item Department keys. One is to change Departments 1 through 30 only into Single-item Keys and to hold other Departments as as ordinary department keys. The other is to change all the Departments (maximum 60 departments) into Single-item Keys.

If a department is programmed as a Single-item Key, the department entry routine will immediately finalize the sale as cash without operating any of the media keys when operated outside a sale. The Single-item Key will function, however, just as an ordinary itemized department key if used inside a sale.

TAX**MANUAL TAX KEY**

This key is used to enter an irregular tax amount that cannot be calculated on the basis of the programmed tax table, and to add it to the sale total.

To operate, enter the desired amount of tax, and then depress the **TAX** key. The tax amount entered is then printed. This tax amount is processed into the TAX 2 memory. Therefore, the tax amount automatically calculated and printed at finalizing the sale (TAX 1) does not include a manual-entered tax, while the entire sale total printed on the receipt last line includes the manual-entered tax also.

This key is also used, if depressed without an amount entry within a sale, to display the total of only non-taxable items so far entered. Usually, this non-taxable total is only displayed but not printed. However, it may be programmed to print also.

ITEM CORR**ITEM CORRECT KEY**

This key functions as Item Correct key (but not as Designated Void key), which has already been described for the **IC/VD** key.

VOID**DESIGNATED VOID KEY**

This key is used as Designated Line Void key (but not as Item Correct key), which has already been described for the **IC/VD** key.

PICK UP BAL **PICK UP BALANCE KEY**

This key should be installed in place of the **PB+** key if the "Customer File" option is selected. By entering the Customer File Code before depressing the **PICK UP BAL** key, the previous balance will automatically be recalled and printed from the Customer File memory and the operation will go into a charge posting mode.

The **%+** may be operated to add a percent rate to the previous balance registered through the **PICK UP BAL** key. The **ITEM CORR** key can delete the previous balance just entered through the **PICK UP BAL** key.

The **PICK UP BAL** key may operate at the top of the sale or any time during the sale; however, unlike the **PB+** and **PB-** keys, it can only operate only once in the sale.

CODE OPEN **CUSTOMER FILE CODE OPEN KEY**

This key should also be installed in place of the **PB-** key if the "Customer Track" option is selected. By entering a new code (Customer File No.) before depressing this key, the new Customer File No. will be opened and assigned to the new customer for the following charge posting operation. If the **ITEM CORR** is operated immediately after opening a new File No. through the **CODE OPEN** key, the File No. will be closed.

If certain Customer File Codes have been opened in the "CUSTOMER FILE CODE OPENING" operation in the "SET" mode, entering one of those codes and depressing the **CODE OPEN** key (for the purpose of opening a new customer account and assigning the code) will result in an error. In that case, enter the code and depress the **PICK UP BAL** key. The new customer account is then started with the balance "0".

This key may operate at the top of the sale or any time during the sale; however, it can operate only once in the sale.

REGISTERING PROCEDURE FOR SALES

Here are patterns for actual registering operations. In the following examples, "|___|" indicates an input through numeric keys, "□" indicates a depression of the transaction key, and "---" indicates other registering and/or finalizing operations.

NO-SALE (Mode Lock: REG or MGR)

□NS (or #/NS)

DEPARTMENT ENTRY (Mode Lock: REG, MGR, or □)

|PRICE| → OPEN DEPT → ---

PRESET DEPT → ---

PR OPEN → |PRICE| → PRESET DEPT → ---

NOTES: 1. When a price to override the listing capacity is entered, the □LC OPEN key may be depressed either before or after the price entry but before the department key depression. In this case, a price two-digit larger than the HALC or 1-digit smaller than the LALC may be entered for one entry only. To allow a price even larger or smaller than this, the MA or MGR key is required and set to the MGR position of the Mode Lock.

2. Tax Modifier Keys may be used to reverse the tax status:

(|PRICE|) → TX1/M → DEPT ... to reverse Tax1 taxable/non-taxable status of the department.

(|PRICE|) → TX2/M → DEPT ... to reverse Tax2 taxable/non-taxable status of the department.

(|PRICE|) → TX1/M → TX2/M → DEPT ... to reverse both Tax1 and Tax2 taxable/non-taxable status

PLU ENTRY (Mode Lock: REG, MGR, or □)

|PLU CODE| → PLU → --- to enter a preset PLU price

|PLU CODE| → PLU → |PRICE| → AMT → --- to enter an amount into an open PLU

NOTES: 1. Neither □PR OPEN nor □LC OPEN key can be used.

2. □TX1/M or □TX2/M may be used. (See "NOTE 2" above in "DEPARTMENT ENTRY" description.)

SINGLE DEPARTMENT ITEM (Mode Lock: REG, MGR, or □)

|PRICE| → OPEN DEPT

PRESET DEPT

} The sale is immediately finalized as cash without operating any media key, if outside a sale.

REPEAT ENTRY (Mode Lock: REG, MGR, or)

PRESET DEPT → PRESET DEPT → PRESET DEPT → ---

(Repeat depressing the same dept key as many times as the desired count.)

PRICE → OPEN DEPT → OPEN DEPT → OPEN DEPT → ---

PRESET PLU CODE → PLU → PLU → PLU → ---

OPEN PLU CODE → PLU → PRICE → AMT → AMT → AMT → ---

- NOTES: 1. Repeat entry is not possible by the above patterns when the PR OPEN, VOID, RTN MDSE, BTL RTN, STR CPN, or SHIFT key has been operated together.
 2. The LC OPEN or TX1/M (or TX2/M) key is effective on repeat operation by the above patterns.

PRESET DEPT → RPT → RPT → ---

PRICE → OPEN DEPT → RPT → RPT → ---

PR OPEN → PRICE → PRESET DEPT → RPT → RPT → ---

SHIFT → PRESET DEPT → RPT → RPT → ---

SHIFT → PRICE → OPEN DEPT → RPT → ---

PRESET PLU CODE → PLU → RPT → RPT → ---

OPEN PLU CODE → PLU → PRICE → AMT → RPT → RPT → ---

QUANTITY EXTENSION (MULTIPLICATION) (Mode Lock: REG, MGR, or)

QUANTITY → X → PRESET DEPT → ---

(May be omitted if the quantity is one-digit.)

PR OPEN → QUANTITY → X → PRICE → PRESET DEPT → ---

QUANTITY → X → PRICE → OPEN DEPT → ---

QUANTITY → X → PRESET PLU CODE → PLU → ---

OPEN PLU CODE → PLU → QUANTITY → X → PRICE → AMT → ---

- NOTE: QUANTITY -- max. 3-digit integral and 3-digit decimal
 (Use . key before entering decimal digits.)
 PRICE -- max. 6 digits (5 digits for UK and BE versions)
 PRODUCT -- must not exceed 8 digits.

NOTE: The @/FOR key functions the same as the X key in the above operation patterns.

SPLIT PRICING (Mode Lock: REG, MGR, or)

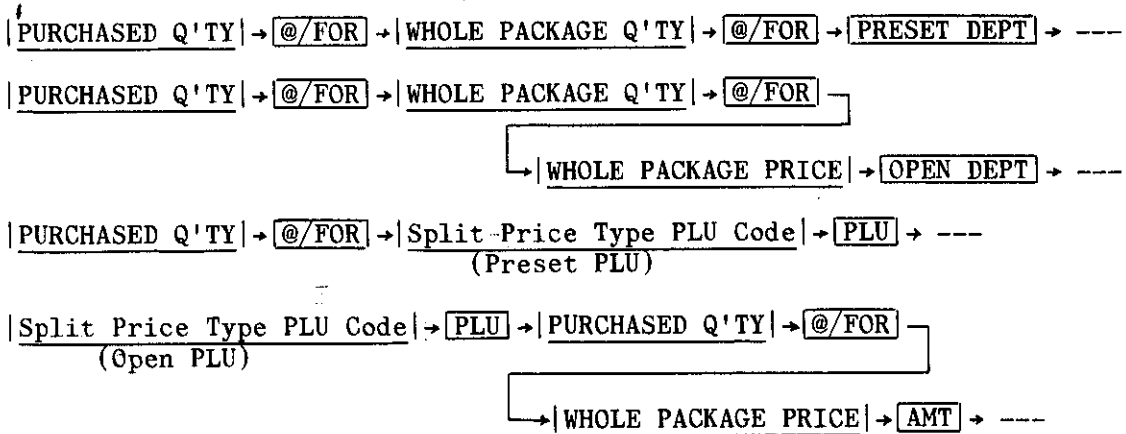

- NOTES: 1. The "PURCHASED Q'TY" and "WHOLE PACKAGE Q'TY" must be of integral value; no decimal value is allowed.
 2. Usually, the fraction of the result is rounded up in split pricing operation. However, it is programmable to round up the fraction of each item price (item price = $\text{WHOLE PACKAGE PRICE} \div \text{WHOLE PACKAGE Q'TY}$).
 3. Only the "Split Price Type" PLUs allow split pricing operations, but not the other ordinary type of PLUs.

RETURNED MERCHANDISE (Mode Lock: REG, MGR, or)

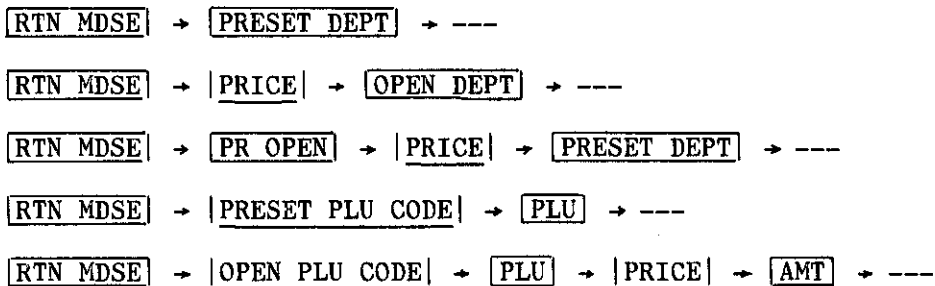

AMOUNT DISCOUNT (Mode Lock: REG, MGR, or)



- NOTES: 1. Unless the "Credit Balance" option has been selected, no discount amount exceeding the sale total will be allowed.
 2. Unless the "Credit Balance" option has been selected, no amount discount operation outside a sale will be allowed.

PERCENT DISCOUNT (Mode Lock: REG, MGR, or)

(1) To discount from the sub-total:

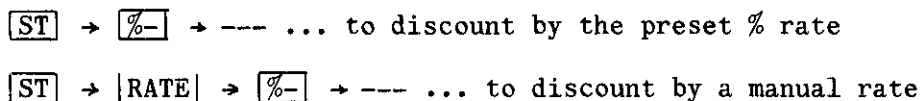

(2) To discount from an individual department item:

DEPT → **%-** → --- ... to discount by the preset % rate

DEPT → **RATE** → **%-** → --- ... to discount by a manual rate

- NOTES: 1. The rate may be entered within the range up to 99.999%. If the rate contains the decimal point, use the **.** key.
2. The above **DEPT** keys may be replaced by a PLU entry.

PERCENT CHARGE (Mode Lock: REG, MGR, or **-**)

This operates the same as in the "PERCENT DISCOUNT" operations above, except that the **%+** is used instead of the **%-** key.

In addition:

PB+ → (**RATE**) → **%+** → ---

PICK UP BAL → (**RATE**) → **%+** → ---

STORE COUPON (Mode Lock: REG, MGR, or **-**)

STR CPN → **PRESET DEPT** → ---

STR CPN → **COUPON AMOUNT** → **OPEN DEPT** → ---

STR CPN → **QUANTITY OF COUPON** → **X** → **COUPON UNIT AMOUNT** → **OPEN DEPT** → ---

- NOTES: 1. **ITEM CORR** is effective.
2. **LC OPEN** and/or **PR OPEN** may be operated.

VENDOR COUPON (Mode Lock: REG, MGR, or **-**)

Department or PLU entries → **COUPON AMOUNT** → **VND CPN** → ---

NOTE: Quantity extension is not possible.

BOTTLE RETURN (motorized **BTL RTN** key) (Mode Lock: REG, MGR, or **-**)

Department or PLU entries → **BOTTLE RETURN AMOUNT** → **BTL RTN** → ---

BOTTLE RETURN (non-motorized [BTL RTN] Key) (Mode Lock: REG, MGR, or [])

[BTL RTN] → [PRESET DEPT] → ---

[BTL RTN] → [BOTTLE RETURN AMOUNT] → [OPEN DEPT] → ---

- NOTES:** 1. Quantity extension is possible, but split pricing is not.
 2. [RTN MDSE], [VOID], or [STR CPN] key can not be operated.

ITEM CORRECTION (LAST LINE VOIDING) (Mode Lock: REG, MGR, or [])

[PRESET DEPT] → [ITEM CORR] → ---

[PRICE] → [OPEN DEPT] → [ITEM CORR] → ---

[RTN MDSE] → [PRESET DEPT] → [ITEM CORR] → ---

[RTN MDSE] → [PRICE] → [OPEN DEPT] → [ITEM CORR] → ---

[PRESET PLU CODE] → [PLU] → [ITEM CORR] → ---

[OPEN PLU CODE] → [PLU] → [PRICE] → [AMT] → [ITEM CORR] → ---

* The [IC/VD] key will function the same as the [ITEM CORR] key in all of these patterns.

- NOTES:** 1. The [ITEM CORR] key depression will delete the last line item already printed within a sale.
 2. The [ITEM CORR] key functions to delete the last line item, even if the [DEPT] keys in the above examples are replaced by the [%+], [%-], [R/A], [PO], [], [BTL RTN] (motorized key), [VND CPN], [PB+], or [PB-] key.

VOID (DESIGNATED LINE VOIDING) (Mode Lock: REG, MGR, or [])

[VOID] → [PRESET DEPT] → ---

[PRICE TO BE VOIDED] → [VOID] → [OPEN DEPT] → ---

[VOID] → [DEPT PRICE TO BE VOIDED] → [OPEN DEPT]

→ [% CHARGE (or DISCOUNT) RATE TO BE VOIDED ALONG WITH THE DEPT PRICE] → [%+] (or [%-]) → ---

[VOID] → [PRESET PLU CODE] → [PLU] →

[VOID] → [OPEN PLU CODE] → [PLU] → [PRICE TO BE VOIDED] → [AMT] →

→ (A [%+] or [%-] key operation may follow, just as in the above, if necessary.)

[1] → [IC/VD] → [PRESET DEPT] → ---

└ Quantity "1"

[PRICE TO BE VOIDED] → [IC/VD] → [OPEN DEPT] → ---

|PRESET PLU CODE| → **IC/VD** → **PLU** → ---

|OPEN PLU CODE| → **IC/VD** → |PRICE TO BE VOIDED| → **AMT** → ---

- NOTES:
1. Designated voiding cannot be made on a department that has been preset as a negative department.
 2. Unless the "Credit Balance" option has been selected, voiding to result the sale total into negative will go into an error.
 3. The **IC/VD** will function the same as the **VOID** key except that:
 - 1) **VOID** may be depressed before or after a numeric entry, if before the motorized key (key to cause the line item print).
 - 2) **IC/VD** can only be depressed after a numeric entry. If depressed at the top, it will item-correct the last item just entered before the **IC/VD** depression. Therefore, in voiding a preset department entry, the quantity must be entered first (if a normal entry, the quantity will be "1"), next depress **IC/VD**, and then **PRESET DEPT**.

NON-ADD NUMBER PRINT (Mode Lock: REG, MGR, or **[-]**)

|NUMBER| → **#** (or **#/NS**) → ---

└(Cheque No., Customer No., Credit Card No., etc.; max. 8 digits)

- NOTES:
1. If the "Non-add Number Print Allowed Only Once" option has been selected, a second non-add number entry in a sale will result in an error.
 2. The **[.]** key cannot be used to enter a non-add number.

SELECTIVE ITEMIZED (S.I.) STATUS MODIFICATION (Mode Lock: REG, MGR, or **[-]**)

SI/M → **PRESET DEPT** → ---

SI/M → |PRICE| → **OPEN DEPT** → ---

SI/M → |PRESET PLU CODE| → **PLU** → ---

SI/M → |OPEN PLU CODE| → **PLU** → |PRICE| → **AMT** → ---

NOTE: If the department or PLU has been programmed with the S.I. status, it will be reversed to non-S.I. status. If it has been programmed with non-S.I. status, it will be reversed to the S.I. status by the depression of the **SI/M** key.

SELECTIVE ITEMIZER (S.I.) READ (Mode Lock: REG, MGR, or **[-]**)

Dept. or PLU entries ... → **SI/TL** → --- The selective itemizer total is displayed and printed on the receipt.

- NOTES:**
1. It may be programmed not to print the selective itemizer total on the receipt.
 2. The content of the selective itemizer is cleared on the depression of the **[SI/TL]** key.
 3. If a preset % rate is programmed on the **[SI/TL]** key, the amount calculated on the rate is automatically printed. Whether the calculated amount is added to/subtracted from or not is also a programmable selection.
 4. If the "SI/TL Compulsory" option is selected, only a finalizing operation is allowed after the **[SI/TL]** key depression.

SUB-TOTAL (Mode Lock: REG, MGR, or **[]**)

--- → **[ST]** → --- ... The sale total so far is displayed and printed, but the sale is not finalized.

- NOTE:**
1. If the **[C]** key is depressed after once obtaining a sub-total, the sub-total amount will be displayed.
 2. If the **[ST]** key is depressed more than once consecutively, the first depression only will print and display the sub-total; further depressions will only display but not print the sub-total.

TAXABLE TOTAL READ (Mode Lock: REG, MGR, or **[]**)

--- → **[TXBL TL]** → --- ... The sale total with taxes so far is displayed but not printed. The sale is not finalized.

- NOTES:**
1. If the **[C]** key is depressed after the **[TXBL TL]** key has once been depressed, the sale total with taxes is then displayed.
 2. If the **[TXBL TL]** key is depressed during a charge posting operation, the sale total with tax and without the previous balance is displayed.

MANUAL TAX ENTRY (Mode Lock: REG, MGR, or **[]**)

[TAX AMOUNT TO BE ADDED] → **[TAX]** → ---

NON-TAXABLE ITEM TOTAL READ (Mode Lock: REG, MGR, or **[]**)

--- → **[TAX]** → --- ... The total of the non-taxable item(s) so far entered within the sale is displayed. It is usually not printed, but programmable to print if required.

TAX EXEMPTION (Mode Lock: REG, MGR, or **[]**)

--- → **[EX]** → Finalization ... to exempt all the taxes

--- → **[TX1/M]** → **[TX1/M]** → **[EX]** → Finalization ... to exempt all the taxes

--- → **[TX1/M]** → **[EX]** → Finalization ... to exempt TAX 1 only

--- → **[TX2/M]** → **[EX]** → Finalization ... to exempt TAX 2 only

CASH TOTAL (Mode Lock: REG, MGR, or)

--- → (TXBL TL) → AT/TL ... The drawer opens, the sale total is displayed and printed, and a receipt is issued.

CASH TENDERING (Mode Lock: REG, MGR, or)

--- → (TXBL TL) → | CASH AMOUNT TENDERED | → AT/TL
... The drawer opens, the change due is displayed, the amount tendered and the change are printed, and a receipt is issued.

CHECK TENDERING (Mode Lock: REG, MGR,)

--- → (TXBL TL) → | AMOUNT OF CHECK TENDERED | → CHK TND

CHARGE TOTAL (Mode Lock: REG, MGR, or)

--- → (TXBL TL) → Chg

MISCELLANEOUS MEDIA TENDERING (Mode Lock: REG, MGR, or)

--- → (TXBL TL) → | AMOUNT OF MISC.MEDIA TENDERED | → MSC TND

CARD TOTAL (Mode Lock: REG, MGR, or)

--- → (TXBL TL) → CARD

MEDIA 5 TENDERING (Mode Lock: REG, MGR, or)

--- → (TXBL TL) → | AMOUNT OF MEDIA 5 TENDERED | → MEDIA 5

NOTE: The above operations of CHECK, CHARGE, MISC., CARD, and MEDIA 5 keys are based on the standard programming. If any of those keys is programmed to be used the other way (i.e., "Total Key" instead of "Tender Key" or vice versa), do the operation as shown in "CASH TOTAL" and "CASH TENDERING". Also, the actual media corresponding to each media key may be differed according to the customer's requirement.

MULTI-TENDERING, SPLIT TENDERING (Mode Lock, REG, MGR, or)

MULTI-TENDERING (Short tendering repeated multiple times by the same media)

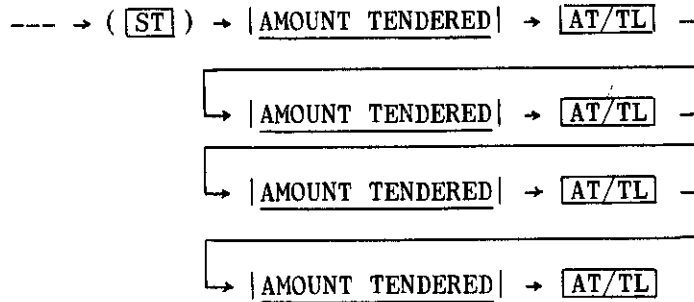

The AT/TL key may be replaced by any other media key if it is programmed to allow tendering.

SPLIT-TENDERING (Short tendering repeated by different media keys)

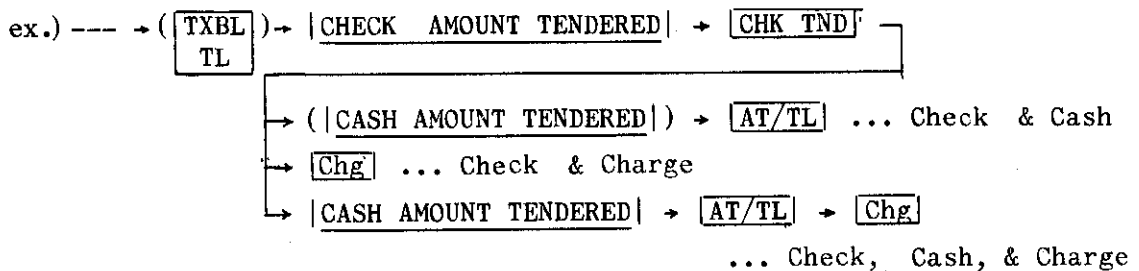

Other media keys may also be used.

- NOTES:**
1. In both MULTI-TENDERING and SPLIT-TENDERING operations, the sale is finalized, a receipt is issued, and the drawer opens on reaching the sale total amount.
 2. If a media key is depressed without an amount tendering entry (if that key can function as a "Total Key"), the sale is then finalized on that stage, processing all the balance due into that media.

CHECK CASHING (Mode Lock: REG or MGR)

| AMOUNT OF CHECK TO BE CASHED | → CHK TND ... The drawer opens and a receipt is issued. Receive the check and pay the amount in cash to the customer.

- NOTES:**
1. Check cashing is allowed only outside a sale.
 2. The system option provides a selection to prohibit check cashing operations, if necessary.
 3. Other media keys may be programmed to allow cashing, if necessary.

RECEIVED ON ACCOUNT (Mode Lock: REG or MGR.)

AMOUNT OF PAYMENT | → R/A → (AMOUNT RECEIVED |) → AT/TL (if paid in cash)
|
Repeat if multiple payments are entered. | or any other media keys if programmed to allow R/A entries.

NOTE: Any other media key may finalize payments received on account if so programmed in the system option. In this case, the entry of "AMOUNT RECEIVED" is compulsory if the key is programmed to be a "Tender Key". Skip the amount entry if the key is programmed to be a "Total Key".

MULTI-TENDERING and SPLIT-TENDERING are also applied in finalizing R/A entries.

PAID OUT (Mode Lock: REG or MGR.)

AMOUNT TO BE PAID OUT | → PO → AT/TL
|
Repeat if multiple amounts are paid out at a time.

PREVIOUS BALANCE, CHARGE POSTING (Mode Lock: REG, MGR, or)

There are two types of charge posting operations: One is the PREVIOUS BALANCE MANUAL ENTRY type, in which each previous balance is entered through the numeric keyboard followed by the PB+ or PB- key. The other is the CUSTOMER FILE type, in which a new account No. is recorded and opened by the CODE OPEN key or by a "SET" mode programming operation, and the previous balance is automatically be recalled by the PICK UP BAL key from the Customer File memory.

For the convenience of explanation, "TYPE 1" is marked for PREVIOUS BALANCE MANUAL ENTRY type, and "TYPE 2" for CUSTOMER FILE type, in the operation procedure patterns on the following page.

3. CHARGE POSTING WITH A PREVIOUS BALANCE ENTERED DURING SALE (POST-SELECT)

A previous balance may be entered not only before other sales items but also after or between them if the **Chg** key has not been depressed (applicable to both TYPE 1 and TYPE 2). Multiple previous balance entries are possible within a sale (applicable to TYPE 1 only).

4. PERCENT CHARGE ADDITION TO A PREVIOUS BALANCE

TYPE 1: |PREVIOUS BALANCE| → **PB+** → (|MANUAL RATE|) → **%+** → ---

TYPE 2: |Cus. File No.| → **PICK UP BAL** →
→ (|MANUAL RATE|) → **%+** → ---

- NOTES: 1. The **%-** operation will not be allowed after any previous balance entry.
2. The previous balance picked up by the "|Cus. File No.|" → **PICK UP BAL** " must be a positive amount in the above TYPE 2 pattern. Otherwise, it will result in an error.

LOAN (FLOAT IN DRAWER) (Mode Lock: REG or MGR)

R/A → |CASH AMOUNT TO BE LOANED| → **AT/TL** → (**ST**) → **AT/TL**
↑
Repeatable

- NOTES: 1. Neither the **ITEM CORR** nor **VOID** key can void any items in a loan operation.
2. Quantity extension is not possible for loan entries.
3. Cash is the only media allowed for loan.

PICK UP (Mode Lock: MGR only)

PO → |CASH AMOUNT PICKED UP| → **AT/TL** → (**ST**) → **AT/TL**
→ |MEDIA AMOUNT PICKED UP| → **MEDIA** → (**ST**) → **AT/TL**
Repeatable by alternating the amount and/or the media.

- NOTES: 1. Pick up amounts may be recorded through the **AT/TL** (cash amount), **VND CPN** (vendor coupon amount), and other media keys whose Media-in-drawer Totals are programmed to be printed on In-drawer Report.
2. An amount must be entered before each media key.
3. Neither the **ITEM CORR** nor **VOID** key can void any items in a pick up operation.
4. The register with four Clerk Keys allows this pick up operation and each clerk may pick up individually to affect his/her own clerk In-drawer memory. Meanwhile, each memory turning into negative will not be an error.
5. On the depression of the **PO** key, the drawer opens. Pick up operations may be carried out with the drawer kept open, even if the "Drawer-close Compulsory" option is selected.

VALIDATION PRINT (Mode Lock: REG or MGR)

After entering an item through a transaction key or a media key → Insert a validation slip into the validation slot. Make sure that the "SLP" Lamp becomes lit. → VALID
DATE

(If the key has been programmed with the "Validation Compulsory", the "SLP" Lamp will flash on depression the key. If not so programmed, the lamp will remain unlit at this time.)

- NOTES: 1. No other operations can follow until the validation slip once printed is withdrawn.
2. Validation printing can be done even after a non-add number or a no-sale entry.
3. The following are selections that can be programmed in the system option related to validation:

- (1) PRINT FORMAT
 - a) DATE print/non-print
 - b) CONSECUTIVE NO. print/non-print
- (2) MULTI-VALIDATION (allows any number of validation for the same item) or SINGLE-VALIDATION
- (3) VALIDATION compulsory/optional on the following keys:

All media keys (including AT/TL), RTN MDSE, PO, R/A, ITEM CORR, VOID, New Balance, DOLL DISC, %-, Negative Depts. and PLUs, BTL RTN, VND CPN, STR CPN.

OPERATIONS IN "[-]" MODE (Mode Lock: [-])

Operations with the condition of "Mode Lock: REG, MGR, or [-]" can be operated in the [-] position of the Mode Lock, which will be useful in deleting all the items once recorded in the "REG" or "MGR" mode by following the sales receipt. Instead of using the RTN MDSE or VOID key in the "REG" or "MGR" mode for deleting individual items, the "[-]" mode automatically processes positive items into negative and negative into positive. To operate, turn the Mode Lock to the "[-]" position, and enter the items, one by one, just as in the "REG" mode, following the sales receipt. The balance resulted in the "[-]" mode indicates the amount to be paid back to the customer.

If the "CUSTOMER FILE" type is selected for post charging operation, the following operations should specially be noted, because exceptional procedures are required in the "[-]" mode:

1. PREVIOUS BALANCE WITH %+ ITEM

REG or MGR mode: |Customer File No.| PICK UP BAL → (|RATE|) %+ →---

[-] mode: |Customer File No.| PICK UP BAL → |RATE| X |%+ AMOUNT| %+ →---
1 (|@/FOR|) 2

NOTES 1 2: The RATE and %+ AMOUNT must be entered in the "[-]" mode. The RATE here must be identical to that recorded in the "REG" or "MGR" mode receipt whether it was a preset or manual rate. The %+ AMOUNT must be identical to that also recorded in the same receipt.

2. NEGATIVE BALANCE PAID BACK TO THE CUSTOMER BY [PO] KEY

REG or MGR mode: --- → [Chg] → [PO]

[] mode: --- → [Chg] → |Balance to be paid back to customer| [PO]

This amount entry is compulsory in the "[]" mode.

Refer to the receipt print samples and operations described below:

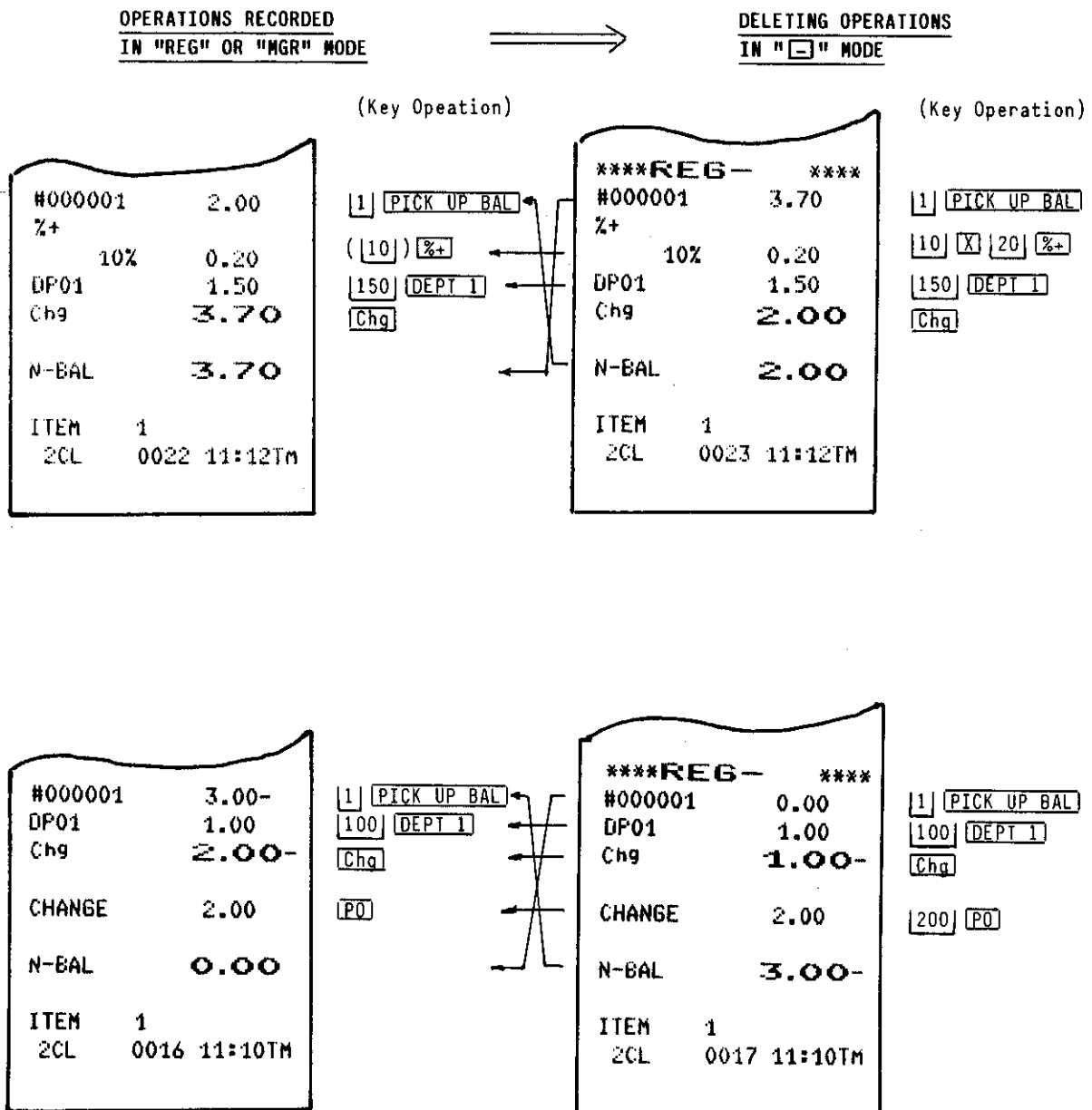

REGISTERING RECEIPT SAMPLES

NO-SALE

```

TEC STORE
1343 PEACH DRIVE
PHONE: 877-6437

Thank you
      Call again

09-16-83  #123456

****NOSALE****

JONES 0041 11:52TM
    
```

A max. of 4 lines
of Store Name/Message
Programmable.

A max. of 3 lines
of Commercial Message
Programmable

Date

Register No.

No-sale Symbol

Current Time

Consecutive No.

Clerk Name (If no name has been programmed
for the clerk, the Clerk ID Code
such as "ICL" will be printed instead.)

RECEIVED ON ACCOUNT

```

TEC STORE
1343 PEACH DRIVE
PHONE: 877-6437

Thank you
      Call again

09-16-83  #123456

#15
R/A-----$5.00-----
R/A          $10.00
CASH        $10.00

JONES 0057 14:26TM
    
```

Non-add #

\$5.00 received, item-corrected

\$10.00 received

Received Total

PAID OUT

CHECK CASHING

```

TEC STORE
1343 PEACH DRIVE
PHONE: 877-6437

Thank you
      Call again

09-16-83  #123456

CHECK $10.00
JONES 0059 14:26TM
    
```

\$10.00 check cashed

```

TEC STORE
1343 PEACH DRIVE
PHONE: 877-6437

Thank you
      Call again

09-16-83  #123456

PO $20.00
PO-----$10.00-----
TOTAL $20.00

JONES 0058 14:26TM
    
```

\$20.00 paid out

\$10.00 paid out,
item-corrected

Paid Out Total

DEPARTMENT, SUBTOTAL, %

DEPARTMENT:(RETURN, ITEM CORRECT,

QUANTITY EXTENSION),
DOLLAR DISCOUNT,
CASH TENDERING

TEC STORE
1343 PEACH DRIVE
PHONE: 877-6437

Thank you
Call again

09-16-83 #123456

VEGETABL	\$1.20 T	← Amount entered
FRUIT	\$2.00 T	← Taxable Symbol
SUBTL	\$3.20	← Subtotal (Entire Sale so far)
GRP.ST	\$3.20	← Group Subtotal (V+F)
Z+		
10%	\$0.32	← 10% on GRP.ST
MEAT	\$2.50 T	
DAIRY	\$3.00 TS	
SUBTL	\$9.02	← Subtotal (Entire Sale so far)
GRP.ST	\$5.50	← Group Subtotal (M+D)
Z+		
10%	\$0.55	← 10% on GRP.ST
TAX	\$0.87	← Tax due
CASH	\$10.44	← Sale Total including Tax to be paid in cash.

ITEM 4
JONES 0071 14:38TH

← Item Count purchased

TEC STORE
1343 PEACH DRIVE
PHONE: 877-6437

Thank you
Call again

09-16-83 #123456

VEGETABL	\$1.23 T	
VEGETABL	\$1.23 T	← Item-Corrected
RTN		← Returned Item
VEGETABL	\$1.23-T	
15X	1.20 @	← Quantity Extension
FISH	\$18.00 T	
DISC	\$1.00-	← Dollar Discount
TAX	\$1.80	
TOTAL	\$18.80	← Sale Total including Tax
CATEND	\$20.00	← Cash Tendered
CHANGE	\$1.20	← Change due

ITEM 15
JONES 0060 14:27TH

PLU, SPLIT PRICING, CHARGE SALES

DEPARTMENT WITHOUT NAME PROGRAMMED

TEC STORE
1343 PEACH DRIVE
PHONE: 877-6437

Thank you
Call again

09-16-83 #123456

Pork	\$5.00 T	← PLU Item
BOTTLED	\$2.00 T	
2X	1.50/ 5	← Split Pricing:
Apple	\$0.60 T	← 2x $\frac{\$1.50 \text{ (Package Price)}}{5 \text{ (Whole Package Qty)}}$
TAX	\$0.76	← = \$0.60
Chg	\$8.36	← Finalized as Charge

ITEM 4
JONES 0075 14:42TH

TEC STORE
1343 PEACH DRIVE
PHONE: 877-6437

Thank you
Call again

09-16-83 #123456

VEGETABL	\$1.00 T	
FRUIT	\$1.20 T	
DAIRY	\$5.00 TS	
5X	0.50 @	
DRINK	\$2.50 TS	
DP12	\$1.20 T	← Dept.No.12
DP14	\$1.40 T	(If no name has been programmed, the Dept. Code such as "DP12" is printed instead.)
TAX	\$1.23	
CASH	\$13.53	

ITEM 10
JONES 0062 14:29TH

PREVIOUS BALANCE (MANUAL ENTRY TYPE),

PREVIOUS BALANCE (CUSTOMER FILE TYPE)

PARTIAL PAYMENT

(Continued from the previous page.)

TEC STORE
1343 PEACH DRIVE
PHONE: 877-6437

Thank you
Call again

09-16-83 #123456

PB+ \$7.67
BAKERY \$6.00 T
TAX \$0.60
Chg \$14.27

R/A \$10.00
CHECK \$10.00
CHANGE \$0.00

N-BAL \$4.27

ITEM 1
JONES 0077 14:47TM

Transferred Balance entered as Previous Balance

Finalized by [Chg]

Payment Declaration Paid in Check

New Balance

TEC STORE
1343 PEACH DRIVE
PHONE: 877-6437

Thank you
Call again

09-16-83 #123456

#001111 \$23.80
FRUIT \$1.20 T
FISH \$3.00 T
TAX \$0.42
Chg \$28.42

N-BAL \$28.42

ITEM 2
JONES 0014 15:49TM

Previous Balance recalled by Customer File No.

New Balance stored in the Customer File No.001111

ALL PAID

TEC STORE
1343 PEACH DRIVE
PHONE: 877-6437

Thank you
Call again

09-16-83 #123456

PB+ \$4.27
WhiBread \$1.30 T
RyeBread \$1.10 T
TAX \$0.24
Chg \$6.91

R/A \$6.91
CHECK \$6.91
CHANGE \$0.00

N-BAL \$0.00

ITEM 2
JONES 0078 14:47TM

Finalized by [Chg]

Payment Declaration Paid in Check

New Balance (All paid)

TEC STORE
1343 PEACH DRIVE
PHONE: 877-6437

Thank you
Call again

09-16-83 #123456

#001111 \$28.42
FRUIT \$2.00 T
TAX \$0.20
Chg \$30.62

N-BAL \$30.62

ITEM 1
JONES 0015 15:50TM

Previous Balance recalled

New Balance stored in the Customer File No.001111 again.

TEC STORE
 1343 PEACH DRIVE
 PHONE: 877-6437

Thank you
 Call again

09-16-83 #123456

MEAT \$12.00 T
 X-
 20X \$2.40-
 24X 0.25 @
 BOTTLED \$6.00 TS
 X+
 20X \$1.20
 TAX \$1.80
 TOTAL \$18.60
 CATEND \$10.00
 CATEND \$5.00
 Chg \$3.60

ITEM 25
 JONES 0073 14:40TH

20% discount from the above item

20% charge on the above item

Sale Total
 First Cash Tended
 Second Cash Tended
 The Balance as Charge

TEC STORE
 1343 PEACH DRIVE
 PHONE: 877-6437

Thank you
 Call again

09-16-83 #123456

6X 1.00/ 6
 Tomato \$1.00 T
 1X 1.00/ 6
 Tomato \$0.17 T
 TAX \$0.12
 CASH \$1.29

ITEM 7
 JONES 0070 14:37TH

Whole Package (6 Tomatoes) \$1.00
 1/6 Package \$0.17

PREVIOUS BALANCE (MANUAL ENTRY TYPE),
 ALL BALANCE TRANSFER

STORE COUPON, VENDOR COUPON, TAX EXEMPTION,
 MISC.TENDERING

TEC STORE
 1343 PEACH DRIVE
 PHONE: 877-6437

Thank you
 Call again

09-16-83 #123456

VEGETABL \$13.00 T
 BAKERY \$6.00 T
 S.CPN
 BAKERY \$2.00-T
 SUBTL \$17.00
 V.CPN \$5.00-
 TAX1EX \$17.00
 TOTAL \$12.00
 MISC \$15.00
 CHANGE \$3.00

ITEM 2
 JONES 0074 14:41TH

Store Coupon \$2.00 redeemed through "BAKERY" DEPT.
 Vendor Coupon \$5.00
 Tax-exempted Total Portion
 Sale Total
 Misc.Tendered
 Change due

TEC STORE
 1343 PEACH DRIVE
 PHONE: 877-6437

Thank you
 Call again

09-16-83 #123456

PB+ \$0.00
 VEGETABL \$1.20 T
 MEAT \$2.00 T
 1X 1.00/ 6
 Tomato \$0.17 T
 Potato \$1.40 T
 Cheese% \$2.20 TS
 TAX \$0.70
 Chg \$7.67

N-BAL \$7.67

ITEM 5
 JONES 0076 14:45TH

Opening for a new customer

Finalized by [Chg]

All balance transferred by [TRF] Key.

(to be continued to the next page)

LOAN

TEC STORE
 1343 PEACH DRIVE
 PHONE: 877-6437

Thank you
 Call again

09-16-83 #123456

****LOAN****

\$10.00
 \$15.00

TOTAL \$25.00

JONES 0056 14:25TH

← Loan Symbol
 ← \$10.00 loaned
 ← \$15.00 loaned
 ← Total Amount Loaned

PICK UP

TEC STORE
 1343 PEACH DRIVE
 PHONE: 877-6437

Thank you
 Call again

09-16-83 #123456

****PICKUP****

CASH \$2.00
 CHECK \$3.00
 V.CPN \$4.00
 MISC \$5.00
 SUBTL \$14.00
 TOTAL \$14.00

JONES 0085 14:54TH

← Pick Up Symbol
 ← \$2.00 cash picked up
 ← \$3.00 check picked up
 ← \$4.00 vendor cpn picked up
 ← \$5.00 Misc. Media picked up
 ← Total Amount Picked Up

ENTRIES IN THE "☐" MODE

(Special attention should be paid to charge posting in the "☐" mode when Customer File Type is selected. Refer to page 36.)

ex.) A customer who once purchased items listed on the left receipt comes up to return all the items he purchased. The clerk asks the store manager to turn the Mode Lock to the "☐" position, and registers all the items, one by one, following the customer's receipt. The contents of the two receipts are the same except that the Negative Mode Symbol is printed on the right one, and the total amount must be returned to the customer.

TEC STORE
 1343 PEACH DRIVE
 PHONE: 877-6437

Thank you
 Call again

09-16-83 #123456

VEGETABL \$1.00 T
 FRUIT \$2.00 T
 1X 1.00/ 6
 Tomato \$0.17 T
 Potato \$1.40 T
 SUBTL \$4.57
 GRP.ST \$4.57
 %+
 10X \$0.46
 TAX \$0.46
 CASH \$5.49

ITEM 4
 JONES 0081 14:51TH

← Total Paid

TEC STORE
 1343 PEACH DRIVE
 PHONE: 877-6437

Thank you
 Call again

09-16-83 #123456

****REG--****

VEGETABL \$1.00 T
 FRUIT \$2.00 T
 1X 1.00/ 6
 Tomato \$0.17 T
 Potato \$1.40 T
 SUBTL \$4.57
 GRP.ST \$4.57
 %+
 10X \$0.46
 TAX \$0.46
 CASH \$5.49

ITEM 4
 JONES 0082 14:51TH

← Negative Mode Symbol

← Total to be returned to the customer

VALIDATION PRINT SAMPLES

(RECEIPT)

(VALIDATION
TIMING)

(VALIDATION)

RECEIVED ON ACCOUNT

TEC STORE
1343 PEACH DRIVE
PHONE: 877-6437

Thank you
Call again

09-16-83 #123456

R/A \$5.00
R/A \$10.00
CASH \$15.00

JONES 0030 16:50TH

09-16-83	1CL0030	R/A	\$5.00	
<hr/>				
09-16-83	1CL0030	R/A	CASH	\$15.00

Date Cons.No. Item Name Amount

Clerk ID
(Always prints in
Clerk ID Code, not
in name.)

PAID OUT

TEC STORE
1343 PEACH DRIVE
PHONE: 877-6437

Thank you
Call again

09-16-83 #123456

PO \$6.00
PO \$10.00
TOTAL \$16.00

JONES 0031 16:51TH

09-16-83	1CL0031	PO	\$6.00	
<hr/>				
09-16-83	1CL0031	PO	TOTAL	\$16.00

CHECK CASHING

TEC STORE
 1343 PEACH DRIVE
 PHONE: 877-6437

Thank you
 Call again

09-16-83 #123456

CHECK **\$15.00**

JONES 0032 16:51TM

09-16-83 1CL0032 CHECK **\$15.00**

VARIOUS ITEMS

TEC STORE
 1343 PEACH DRIVE
 PHONE: 877-6437

Thank you
 Call again

09-16-83 #123456

VEGETABL \$1.00 T
 Potato \$1.40 T
 BAKERY \$5.00 T
 CANNED \$6.00 TS
 V.CPN \$5.00-
 SUBTL \$8.40
 GRP.ST \$8.40
 Z+
 10Z \$0.84
 TAX \$1.34
 TOTAL **\$10.58**
 CATEND \$10.00
 Chg \$0.58

ITEM 4
 JONES 0029 16:45TM

09-16-83 1CL0029 VEETABL \$1.00 T

09-16-83 1CL0029 Potato \$1.40 T

09-16-83 1CL0029 V.CPN \$5.00-

09-16-83 1CL0029 Z+ 10Z \$0.84

09-16-83 1CL0029 CATEND \$10.00

09-16-83 1CL0029 Chg \$0.58

READ(X) AND RESET(Z) REPORTS

The following table shows the key operation to take each report. The "X" and "Z" reports have exactly the same content print if both are available, except that:

1. The "X" reports allow to read the totals but not clear memories, while the "Z" reports allow to read the totals and at the same time all the resettable memories will be cleared when the reports have been issued.
2. The symbol "X" is printed on the top line of an "X" report, while "Z" is printed on a "Z" report, to indicate the type of report.
3. A reset count is printed on the bottom of a "Z" report only.

TABLE OF OPERATIONS FOR X AND Z REPORTS

REPORT NAME	KEY OPERATION
<u>INDIVIDUAL MEDIA-IN-DRAWER READ</u> (If a media key is programmed not to issue its in-drawer report, that media report is not available.)	Mode Lock: X, Depress each Media Key. (Except: depress <input type="checkbox"/> # or <input type="checkbox"/> #/NS for the Cash-in-drawer Report.)
<u>INDIVIDUAL TRANSACTION READ</u> %+ READ %- READ VENDOR COUPON READ STORE COUPON READ DOLLAR DISCOUNT READ BOTTLE RETURN READ RECEIVED ON ACCOUNT READ PAID OUT READ ITEM CORRECT AND VOID READ SELECTIVE ITEMIZER READ RETURNED MERCHANDISE READ TRANSFER AND PB READ TAXABLE TOTAL AND TAX READ TAX EXEMPTION READ	Mode Lock: X <input type="checkbox"/> %+ <input type="checkbox"/> % - <input type="checkbox"/> VND CPN <input type="checkbox"/> STR CPN <input type="checkbox"/> DOLL DISC <input type="checkbox"/> BTL RTN <input type="checkbox"/> R/A <input type="checkbox"/> PO <input type="checkbox"/> ITEM CORR or <input type="checkbox"/> VOID or <input type="checkbox"/> IC/VD <input type="checkbox"/> SI/TL <input type="checkbox"/> RTN MDSE <input type="checkbox"/> TRF <input type="checkbox"/> TXBL TL <input type="checkbox"/> EX
<u>CUSTOMER FILE READ (available only for CUSTOMER FILE TYPE)</u> ALL FILE NOS AND BALANCES READ ZERO-BALANCE FILE NOS READ POSITIVE-BALANCE FILE NOS READ NEGATIVE-BALANCE FILE NOS READ INDIVIDUAL FILE NO. READ	Mode Lock: X <input type="checkbox"/> PICK UP BAL 0 → <input type="checkbox"/> CODE OPEN 1 → <input type="checkbox"/> CODE OPEN 2 → <input type="checkbox"/> CODE OPEN File No. → <input type="checkbox"/> PICK UP BAL

-- To be continued --

TABLE OF OPERATIONS FOR X AND Z REPORTS -- Continued --

REPORT NAME	KEY OPERATION
<u>PLU READ AND RESET</u> ZONE PLU READ ZONE PLU RESET ALL PLU READ ALL PLU RESET INDIV. PLU READ	Mode Lock: X → Start PLU Code → @/FOR Mode Lock: Z → End PLU Code → PLU Mode Lock: X → PLU Mode Lock: Z → PLU Mode Lock: X only, enter the required PLU Code followed by PLU. This may be repeated by alternating the code. ST may be used to obtain sub-total. AT/TL to end.
<u>DEPARTMENT READ AND RESET</u> INDIVIDUAL DEPARTMENT READ	Mode Lock: X, Depress the required Dept Keys, one by one, ST may be used to obtain sutotal, AT/TL to end.
ALL DEPARTMENT READ ALL DEPARTMENT RESET	Mode Lock: X → 11 → AT/TL Mode Lock: Z → (If the "Auto Read/Reset Report Separated" option is not selected, the Department data are printed on Auto Read/Reset Report listed below)
<u>HOURLY READ AND RESET</u> HOURLY READ HOURLY RESET	Mode Lock: X → 10 → AT/TL Mode Lock: Z →
<u>CLERK READ AND RESET</u> INDIVIDUAL CLERK READ INDIVIDUAL CLERK RESET	Mode Lock: X → Set the required Clerk Mode Lock: Z → Key to ON, enter 1, depress AT/TL.
<u>AUTO READ AND RESET</u> (DEPARTMENT + FINAICIAL + CLERK) AUTO READ AUTO RESET	Mode Lock: X → AT/TL Mode Lock: Z →
<u>GT READ AND RESET</u> GT READ GT RESET	Mode Lock: any position GT Lock: GTX → AT/TL GT Lock: GTZ →

- NOTES: 1. The drawer will open on the depression of the final key of the KEY OPERATION for the reports marked with "*" in the above table.
2. The drawer will open also for the reports marked with "***" on the depression of the final AT/TL key. However, it will not open if so programmed in the system option.
3. No Clerk Key is necessary to issue reports except CLERK READ AND RESET.
4. Refer to the report samples on the following pages. as for the PRESET DATA VERIFICATION, which is available in the "X" mode, see the "VERIFICATION OF PROGRAMMED DATA" near the end of this manual.

REPORT SAMPLES

INDIVIDUAL IN-DRAWER READ

CASH-IN-DRAWER READ

TEC STORE
1343 PEACH DRIVE
PHONE: 877-6437

Thank you
Call again

09-16-83 #123456

X

TOTAL 13CU
CAID -37.20

JONES 0042 17:04TM

Mode Lock: X
Depress #.

Total-Customer Count
Cash-in-drawer Total

CHECK-IN-DRAWER READ

TEC STORE
1343 PEACH DRIVE
PHONE: 877-6437

Thank you
Call again

09-16-83 #123456

X

CKID 5
\$75.00

JONES 0044 17:05TM

Mode Lock: X
Depress [CHK TND].

Check-in-drawer Count
Check-in-drawer Total

TEC STORE
1343 PEACH DRIVE
PHONE: 877-6437

Thank you
Call again

09-16-83 #123456

X

MISCID 1
\$3.52

JONES 0043 17:05TM

Misc.-in-drawer Count
Misc.-in-drawer Total

INDIVIDUAL TRANSACTION READ

DOLLAR DISCOUNT READ

TEC STORE
1343 PEACH DRIVE
PHONE: 877-6437

Thank you
Call again

09-16-83 #123456

DISC X 1
\$0.50

JONES 0047 17:06TM

Mode Lock: X
Depress **[DOLL DISC]**.

Doll Disc Count
Doll Disc Total

BOTTLE RETURN READ

TEC STORE
1343 PEACH DRIVE
PHONE: 877-6437

Thank you
Call again

09-16-83 #123456

BTR X 1
\$0.20

JONES 0048 17:06TM

Mode Lock: X
Depress **[BTL RTN]**.

Bottle Return Count
Bottle Return Total

RECEIVED ON ACCOUNT READ

TEC STORE
1343 PEACH DRIVE
PHONE: 877-6437

Thank you
Call again

09-16-83 #123456

R/A X 4
\$46.50

JONES 0049 17:06TM

Mode Lock: X
Depress **[R/A]**.

R/A Count
R/A Total

PAID OUT READ

TEC STORE
1343 PEACH DRIVE
PHONE: 877-6437

Thank you
Call again

09-16-83 #123456

PO X 4
\$24.00

JONES 0050 17:07TM

Mode Lock: X
Depress **[PO]**.

Paid Out Count
Paid Out Total

TAX EXEMPTION READ

TEC STORE
 1343 PEACH DRIVE
 PHONE: 877-6437

 Thank you
 Call again

 09-16-83 #123456

 X
 TAX EX OCU
 TAX1EX \$0.00

 JONES 0055 17:07TM

Mode Lock: X
Depress [EX].

— Tax Exempted Customer Count
— Tax-exempted Sale Portion Total
(for TAX 1 in this case)

VENDOR COUPON READ

TEC STORE
 1343 PEACH DRIVE
 PHONE: 877-6437

 Thank you
 Call again

 09-16-83 #123456

 X
 V.CPN 2
 \$10.00

 JONES 0045 17:06TM

Mode Lock: X
Depress [VND CPN].

— Vendor Coupon Count
— Vendor Coupon Total

STORE COUPON READ

TEC STORE
 1343 PEACH DRIVE
 PHONE: 877-6437

 Thank you
 Call again

 09-16-83 #123456

 X
 S.CPN 1
 \$5.00

 JONES 0046 17:06TM

Mode Lock: X
Depress [STR CPN].

— Store Coupon Count
— Store Coupon Total

ITEM CORRECT AND VOID READ

TEC STORE
1343 PEACH DRIVE
PHONE: 877-6437

Thank you
Call again

09-16-83 #123456

X

CORR	0	
	\$0.00	
VOID	0	
	\$0.00	
MS VD	0	
	\$0.00	

JONES 0051 17:07TH

Mode Lock: X
Depress IC/VD
(or ITEM CORR
or VOID.)

Item Corr Count on
Item Corr Total } DPs
Void Count on
Void Total } DPs
Item Corr/Void Count
Item Corr/Void Count

SELECTIVE ITIMIZER READ

TEC STORE
1343 PEACH DRIVE
PHONE: 877-6437

Thank you
Call again

09-16-83 #123456

X

SITL	0	
	\$0.00	

JONES 0054 17:07TH

Mode Lock: X
Depress SI/TL.

SI/TL operated Count
SI/TL processed Amount
Total

on other items

TRANSFER AND PB READ

TEC STORE
1343 PEACH DRIVE
PHONE: 877-6437

Thank you
Call again

09-16-83 #123456

X

TF TL	\$74.60	
TF+GT	\$74.60	
TF-GT	\$0.00	
TF+	\$74.60	
TF-	\$0.00	
PBTL	8CU	
	\$32.85	
PBR/A	-39.57	
PBCA	-47.57	
PBCK	\$8.00	
PBMS	\$0.00	
PBCARD	\$0.00	
PBPD	\$0.00	

JONES 0053 17:07TH

Mode Lock: X
Depress TRF.

Transfer Total
Transfer GT+
Transfer GT-
Transfer+ (Daily)
Transfer- (Daily)
PB Customer Total
PB Total
PB R/A Total
PB Cash Total
PB Check Total
PB Misc. Total
PB Card Total
PB Paid Out Total

RETURNED MERCHANDISE READ

TEC STORE
1343 PEACH DRIVE
PHONE: 877-6437

Thank you
Call again

09-16-83 #123456

X

RTN	2	
	\$2.00	
REG-	2	
	\$1.09	

JONES 0052 17:07TH

Mode Lock: X
Depress RTN MDSE.

RTN MDSE Item Count
 RTN MDSE Total
" " Mode Count
" " Mode Total

ALL CUSTOMER FILE
NOS AND BALANCES
READ

TEC STORE
1343 PEACH DRIVE
PHONE: 877-6437

Thank you
Call again

09-16-83 #123456

X

#000001	0,00
#001111	5,00

0110 13:45TM

Mode Lock: X
Depress PICK UP
 BAL .
(All opened Customer
File Nos and their
balances are read.)

Cus. File No.
Balance Remained

ZERO-BALANCE
CUSTOMER FILE NOS
READ

TEC STORE
1343 PEACH DRIVE
PHONE: 877-6437

Thank you
Call again

09-16-83 #123456

X

#000001	0,00
---------	------

0111 13:45TM

Mode Lock:
Enter 0, depress CODE
 OPEN .
(Cus. File Nos with no
balance remained are
read.)

POSITIVE-BALANCE
CUSTOMER FILE NOS
READ

TEC STORE
1343 PEACH DRIVE
PHONE: 877-6437

Thank you
Call again

09-16-83 #123456

X

#001111	5,00
---------	------

0112 13:45TM

Mode Lock: X
Enter 1,
depress CODE
 OPEN .
(Cus. File Nos with
positive balance are
read.)

NEGATIVE-BALANCE
CUSTOMER FILE NOS
READ

TEC STORE
1343 PEACH DRIVE
PHONE: 877-6437

Thank you
Call again

09-16-83 #123456

X

0113 13:46TM

Mode Lock: X
Enter 2,
depress CODE
 OPEN .
(Cus. File Nos with
negative balance are
read.)

Cus. File No. and its
negative balance will be
printed with the "-"
symbol, if any.

(In this case, no Cus. File
No. with negative balance is
found.)

INDIVIDUAL
CUSTOMER FILE NO. BALANCE
READ (ex. 1)

TEC STORE
1343 PEACH DRIVE
PHONE: 877-6437

Thank you
Call again

09-16-83 #123456

X
#000001 0.00

0114 13:46TH

Mode Lock: X
Enter the Cus.
File No., and
depress

PICK UP
BAL

ex.)

1

PICK UP
BAL

(ex. 2)

TEC STORE
1343 PEACH DRIVE
PHONE: 877-6437

Thank you
Call again

09-16-83 #123456

X
#001111 5.00

0115 13:46TH

ex.)

1111

PICK UP
BAL

PLU READ

ALL PLU READ

TEC STORE
 1343 PEACH DRIVE
 PHONE: 877-6437

 Thank you
 Call again

 09-16-83 #123456

 X
 Tomato 14
 PLU101 \$2.34
 Potato 19
 PLU102 \$26.60
 Apple 5
 PLU201 \$1.50
 Orange 7
 PLU202 \$1.64
 Beef 1
 PLU301 \$4.00
 Pork 1
 PLU302 \$6.00
 Butter $\frac{1}{2}$ 1
 PLU501 \$2.00
 Cheese $\frac{1}{2}$ 1
 PLU502 \$2.20
 WhiBread 1
 PLU601 \$1.30
 RyeBread 1
 PLU602 \$1.10
 7-up 1
 PLU901 \$0.25
 Coke 1
 PLU902 \$0.25

 TOTAL 53
 \$49.18

 0036 17:00TM

Mode Lock: X
Depress [PLU].

PLU Name/Item Count
PLU Code/Total

All PLUs Item Count
Total

INDIVIDUAL PLU READ

TEC STORE
 1343 PEACH DRIVE
 PHONE: 877-6437

 Thank you
 Call again

 09-16-83 #123456

 X
 Tomato 14
 PLU101 \$2.34
 Potato 19
 PLU102 \$26.60
 SUBTL 33
 \$28.94

 TOTAL 33
 \$28.94

 0038 17:02TM

ex.)
Mode Lock: X

101 [PLU]
102 [PLU]
[ST]
[AT/TL].

ZONE PLU READ

TEC STORE
 1343 PEACH DRIVE
 PHONE: 877-6437

 Thank you
 Call again

 09-16-83 #123456

 X
 Tomato 14
 PLU101 \$2.34
 Potato 19
 PLU102 \$26.60
 Apple 5
 PLU201 \$1.50
 Orange 7
 PLU202 \$1.64

 TOTAL 45
 \$32.08

 0039 17:02TM

Mode Lock: X
[Start PLU Code]
[C/FOR]
[End PLU Code]
[PLU]

ex.) in this case:
101 [C/FOR]
202 [PLU]

INDIVIDUAL DEPARTMENT READ

TEC STORE
1343 PEACH DRIVE
PHONE: 877-6437

Thank you
 Call again

09-16-83 #123456

X

VEGETABL	42	
12CU	\$38.74	
FRUIT	21	
11CU	\$20.34	
MEAT	4	
2CU	\$16.00	
SUBTL	67	
	\$75.08	
FISH	3	
3CU	\$9.00	
DAIRY	3	
3CU	\$12.20	
BAKERY	3	
2CU	\$7.40	
SUBTL	9	
	\$28.60	
BAKERY	3	
2CU	\$7.40	
CANNED	1	
1CU	\$1.00	
BOTTLED	0	
0CU	\$0.00	
SUBTL	4	
	\$8.40	
TOTAL	80	
	\$112.08	

0037 17:01TM

Mode Lock: X
 Depress the required
 Dept. Key. **[ST]** key
 may be depressed to
 obtain the subtotal.
[AT/TL] to end.

KEY OPERATION EXAMPLE
 (in this case)

Dept.1 (VEGETABLE) Item Count
 Customer Count/Total

Subtotal (= VEG + FRU + MEA)

Sub-total (= FIS + DAI + BAK)

Sub-total (= BAK + CAN + BOT)

Total of all Depts. read out
 on this report.

[DEPT 1 VEGETABLE]

[DEPT 2 FRUIT]

[DEPT 3 MEAT]

[ST]

[DEPT 4 FISH]

[DEPT 5 DAIRY]

[DEPT 6 BAKERY]

[ST]

[DEPT 6 BAKERY]

[DEPT 7 CANNED]

[DEPT 8 BOTTLED]

[ST]

[AT/TL]

TEC STORE
 1343 PEACH DRIVE
 PHONE: 877-6437

Thank you
 Call again

09-16-83 #123456

X

~08:00
 ~16:00 12
 6CU \$24.23
 ~23:00 67
 7CU \$94.98

0040 17:03TM

Mode Lock: X

Enter 10, depress AT/TL .

Up to 8:00 (No sales recorded)
 8:00 to 16:00 Item Count
 — Customer Count / Total
 16:00 to 23:00 Item Count
 — Customer Count / Total

INDIVIDUAL CLERK READ

TEC STORE
 1343 PEACH DRIVE
 PHONE: 877-6437

Thank you
 Call again

09-16-83 #123456

X

JONES
 GS 81
 \$127.30
 NS 79
 \$119.21
 TOTAL 13CU
 \$108.51
 CAID -12.20
 CKID \$70.00
 MISCID \$3.52
 V.CPN \$5.00
 NEG1 \$8.09
 NEG2 \$0.70
 R/A \$46.50
 PO \$24.00
 LOAN \$35.00
 PICKUP \$20.00
 IT/CUS 6.08
 NS/CUS \$8.36
 NDSALE 1

JONES 0041 17:04TM

Mode Lock: X

Set the required Clerk Key to its ON position (Clerk 1 "JONES" in this case)

Enter 1, depress AT/TL . (The "1" here is the fixed number for reading any clerk.)

Clerk Name (or Clerk ID Code if no name has been programmed)
 Gross Sale Item Count
 _____ Total
 Net Sale Item Count
 _____ Total
 All Media Customer Count
 _____ Total
 Cash-in-drawer Total
 Check-in-drawer Total
 Misc.-in-drawer Total
 Vendor Coupon Total
 NEG1 = (Sum of Neg.Depts)+(Item Corr on DPs)+(Void on DPs)+(Bottle RTN DP-linked)+(Return)
 NEG1 = (% on ST)+(DOLL DISC)+(Bottle RTN Inside-sale)
 Received on Account Total + (Mode)+(% on DPs)
 Paid Out Total + (Item Corr/Void on others)
 Loaned Total + (Store CPN)+(- TAX)
 Pick Up Total
 Sales Items per Customer
 Net Sales per Customer
 No-sale Counter

AUTO READ

AUTO RESET

TEC STORE
 1343 PEACH DRIVE
 PHONE: 877-6437

Thank you
 Call again

09-16-83 #123456

GT X
 \$127.30
GS
 81
 \$127.30
 VEGETABL 42
 12CU \$38.74
 FRUIT 21
 11CU \$20.34
 MEAT 4
 2CU \$16.00
 FISH 3
 3CU \$9.00
GROUP01 70
 79.94% \$84.08
 DAIRY 3
 3CU \$12.20
 BAKERY 3
 2CU \$7.40
 CANNED 1
 1CU \$1.00
 BOTTLED 0
 0CU \$0.00
 DRINK 2
 1CU \$0.50
 SNACK 0
 0CU \$0.00
 SPICE 0
 0CU \$0.00
GROUP02 9
 20.06% \$21.10
 DP12 0
 0CU \$0.00
 DP13 0
 0CU \$0.00
 DP14 0
 0CU \$0.00
 DP31 0
 0CU \$0.00
 DP32 0
 0CU \$0.00

Read Symbol ← Reset Symbol

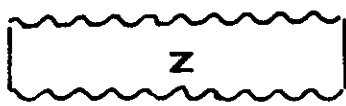

Grand Total (non-resettable)
 Gross Sale Item Count
 Total

DEPARTMENT REPORT

Dept.1 Item Count (Dept.1 is named "VEGETABL" in this example)
 Customer Count/Total
 Dept.2
 :
 :
 Group 1 (Dept "VEGETABL" through Dept "FISH") Item Count
 Sales Portion (%) to all Groups / Sales Total

Group 2 (Dept "DAIRY" through Dept "SPICE")

-- To be continued --

-- Continued --

FINANCIAL REPORT

Z+	2	%+ Count
	\$3.51	Total
TAX1	\$10.52	TAX 1 Total(TAX 2 Total also printed on dual-tax machine)
NS	79	Net Sales Item Count
	\$119.21	Total
Z-	0	%- on Subtotal (or Group Subtotal depending on the option) Count
	\$0.00	Total
V.CPN	2	Vendor Coupon Count
	\$10.00	Total
DISC	1	Dollar Discount Count
	\$0.50	Total
BTR	1	Bottle Return Count
	\$0.20	Total
TOTAL	13CU	All Media Customer Count (including Cash)
	\$108.51	Total
CASH	0CU	Cash Customer Count
	\$10.00	Total
CHECK	2CU	Check Customer Count
	\$44.87	Total
Ch9	1CU	Charge Customer Count
	\$0.58	Total
MISC	1CU	Misc. Media Customer Count
	\$3.52	Total
CARD	1CU	Card Customer Count
	\$16.69	Total
R/A	4	Received on Account Count
	\$46.50	Total
PO	4	Paid Out Count (Regular-sized "PO" is printed with the Standard Program
	\$24.00	Total Total Name0
CAID	-37.20	Cash-in-drawer Total
CKID	5	Check-in-drawer Count
	\$75.00	Total
MISCID	1	Misc.-in-drawer Count
	\$3.52	Total
CORR	0	Item Correct Count (on Department Items)
	\$0.00	Total
VOID	0	Void Count (on Department Items)
	\$0.00	Total
MS VD	0	Item Correct and Void Count (on other items)
	\$0.00	Total
Z-	0	%-(on line items) Count
	\$0.00	Total
S.CPN	1	Store Coupon Count
	\$5.00	Total
RTN	2	Returned Merchandise Item Count
	\$2.00	Total
-TAX	\$0.00	Negative Tax Total
REG-	2	"☐" Mode Count
	\$1.09	Total

-- To be continued --

TF TL	\$74.60	Transfer Total
TF+GT	\$74.60	Transfer+GT
TF-GT	\$0.00	Transfer-GT
TF+	\$74.60	Transfer+ (Daily)
TF-	\$0.00	Transfer- (Daily)
PBTL	8CU	PB Customer Count
	\$32.85	— Total
PBR/A	-39.57	PB R/A Total
PBCA	-47.57	PB Cash Total
PBCK	\$8.00	PB Check Total
PBMS	\$0.00	PB Misc. Total
PBCARD	\$0.00	PB Card Total
PBPO	\$0.00	PB Paid Out Total
TXBL1	\$105.18	Taxable Total 1 (Taxable Total 2 also on dual-tax machine)
SITL	0	SI/TL Processed Count
	\$0.00	— Total
TAX EX	0CU	Tax-exempted Customer Count (TAX1; also TAX2 on dual-tax machine)
TAX1EX	\$0.00	Tax-exempted Sale Portion Total
IT/CUS	6.08	Item Count per Customer
NS/CUS	\$8.36	Net Sale per Customer
NOSALE	1	No-sale Count
VALCTR	11	Validation Count

CLERK REPORT

(Refer to the "INDIVIDUAL CLERK READ" sample description.)

JONES	81
GS	\$127.30
NS	79
	\$119.21
TOTAL	13CU
	\$108.51
CAID	-12.20
CKID	\$70.00
MISCID	\$3.52
V.CPN	\$5.00
NEG1	\$8.09
NEG2	\$0.70
R/A	\$46.50
PO	\$24.00
LOAN	\$35.00
PICKUP	\$20.00
IT/CUS	6.08
NS/CUS	\$8.36
NOSALE	1

0034 16:56TM

AUTO RESET only

Clerk
Reset Count →

JONES
0001Z

SMITH
0001Z

3CL
0000Z

4CL
0000Z

Auto
Reset Count →

0001Z

GT READ

TEC STORE
 1343 PEACH DRIVE
 PHONE: 877-6437

Thank you
 Call again

09-16-83 #123456

GTX

GT		\$127.30
GS	81	\$127.30
VEGETABL	42	
12CU		\$38.74
FRUIT	21	
11CU		\$20.34
MEAT	4	
2CU		\$16.00
FISH	3	
3CU		\$9.00
GROUP01	70	
79.94%		\$84.08
DAIRY	3	
3CU		\$12.20
BAKERY	3	
2CU		\$7.40
CANNED	1	
1CU		\$1.00
BOTTLED	0	
0CU		\$0.00
DRINK	2	
1CU		\$0.50
SNACK	0	
0CU		\$0.00
SPICE	0	
0CU		\$0.00
GROUP02	9	
20.06%		\$21.10
DP12	0	
0CU		\$0.00
DP13	0	
0CU		\$0.00
DP14	0	
0CU		\$0.00
DP31	0	
0CU		\$0.00
DP32	0	
0CU		\$0.00

GT RESET

GTZ

← GT Read Symbol → GT Reset Symbol →

Grand Total (non-resettable)

↓ All the items here are found in "AUTO READ OR RESET" reports. Only the difference is that the totals and counters are the accumulated data for a certain period of days or weeks, etc. until a GT Reset report is taken.

-- Continued --

TAX1	\$10.52
NS	79
	\$119.21
TOTAL	13CU
	\$108.51
CASH	0CU
	\$10.00
CHECK	2CU
	\$44.87
Chg	1CU
	\$0.58
MISC	1CU
	\$3.52
CARD	1CU
	\$16.69
R/A	4
	\$46.50
PO	4
	\$24.00
TF TL	\$74.60
TF+GT	\$74.60
TF-GT	\$0.00
PBTL	\$32.85
PBR/A	-39.57
PBPO	\$0.00
TXBL1	\$105.18
SITL	\$0.00
TAX EX	0CU
TAX1EX	\$0.00
IT/CUS	6.08
NS/CUS	\$8.36
JONES	
GS	81
	\$127.30
NS	79
	\$119.21
TOTAL	13CU
	\$108.51
R/A	\$46.50
PO	\$24.00
IT/CUS	6.08
NS/CUS	\$8.36
0035 16:57TM	

GT RESET only
GT Reset Count - 0001Z

PROGRAMMING OPERATIONS IN "SET" MODE

TABLE OF CONTENTS

(PROGRAM ITEM)	(CONDITION)¶	(PROG NO.)	(PAGE)
SYSTEM OPTION PROGRAMMING	AZ, GTZ	11	62
STORE NAME/MESSAGE AND COMMERCIAL MESSAGE PROGRAMMING			
..... Anytime		1	74
CLERK NAME PROGRAMMING	Anytime	2	76
DEPARTMENT NAME AND STATUS PROGRAMMING			
..... Anytime/AZ/AZ, GTZ, PLUZ		3	77
PLU TABLE PROGRAMMING OR CHANGING	PLUZ/Anytime	4	80
PLU TABLE DELETION	PLUZ	4	81
TIME SETTING	Anytime	5	83
DATE SETTING	Anytime	6	83
HOURLY RANGE SETTING	HZ	7	84
DEPARTMENT LISTING CAPACITY SETTING	AZ	8	85
FINANCIAL TOTAL NAME PROGRAMMING OR CHANGING ...	AZ, GTZ	9	87
PRINT ITEM NAME PROGRAMMING OR CHANGING	Anytime	10	90
NON-TAXABLE AMOUNT LIMIT SETTING	AZ, GTZ	12	92
SPECIAL CHARACTER GENERATION TABLE PROGRAMMING..	Anytime	13	93
DEPARTMENT GROUP PROGRAMMING OR CHANGING	AZ, GTZ	14	95
CUSTOMER FILE CODE OPENING AND CLOSING	Anytime	15	96
DEPARTMENT PRESET PRICE SETTING OR CHANGING	Anytime		98
PLU PRESET PRICE CHANGING	Anytime		99
[%+] AND [%-] PRESET RATE SETTING	Anytime		100
PRESET RATE SETTING ON <u>SI/TL</u> KEY	AZ		100
TENDER LISTING CAPACITY SETTING	AZ		101
DOLLAR DISCOUNT LIMIT AMOUNT SETTING	AZ		101
BOTTLE RETURN LIMIT AMOUNT SETTING.....	AZ		102
VENDOR COUPON LIMIT AMOUNT SETTING	AZ		102
STORE/REGISTER NO. SETTING	AZ, GTZ		102
TAX TABLE PROGRAMMING	AZ, GTZ		103

NOTE ¶: Anytime = Anytime outside a sale PLUZ = After PLU Reset
 AZ = After Auto Reset HZ = After Hourly Reset
 GTZ = After GT Reset

----- OTHER REFERENCES RELATED TO PROGRAMMING OPERATIONS

CHARACTER CODE TABLE	113
PROGRAMMING OPERATIONS IN "MGR" MODE (MANAGER'S PROGRAMMING)	106
PROGRAMMING OPERATIONS THROUGH THE PROGRAMMING KEYBOARD (optional)	114
VERIFICATION OF PROGRAMMED DATA	117

SYSTEM OPTION PROGRAMMING

CONDITION: After Auto Reset and GT Reset

OPERATION: Mode Lock: BLIND or SET

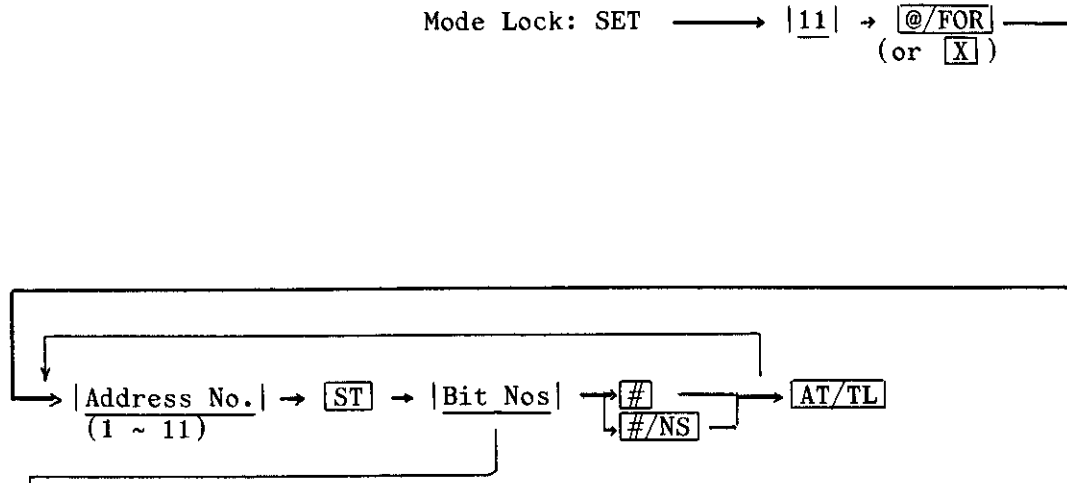

Enter a maximum of eight-digit number composed of Bit Nos whose status must be set to the "SET" status. If there is no Bit No. to be set to the "SET" status in an Address No., enter "0".

- ex.) To set Bit No.2 only Enter 2.
- To set Bits No.2 and No.3 Enter 23.
- To set all the Bit Nos Enter 12345678.
- To reset all the Bit Nos Enter 0.

- NOTES:**
1. Any Bit No. with the "--vacant--" item will be disregarded even if it is set. (However, if ever set, it will not result in an error.)
 2. When the product is delivered to the customer, each Address # has already been set with proper Options Nos according to the customer's requirements. Therefore, it is recommended to read out the programmed data of the SYSTEM OPTION first (refer to page 117) and next do this programming operation only for the Addresses that require option change.

ex.) To set the following options:

Address #1 Table (refer to the next page.)

- Bit No.1 Time NON-PRINT (SET status)
- No.3 Sub-total NON-PRINT (SET status)
- Other Bit Nos will be selected to "RESET" status:

Mode Lock to SET, enter 11, depress **@/FOR** .

Enter 1 (Address No.), depress **ST** .

Enter 13 (Option Nos for SET), depress **#** .

Depress **AT/TL** to end.

09-07-00		#0
P 11		
#01		13
0010		

SYSTEM OPTION TABLES

ADDRESS NO.	CONTENTS
1	NON-PRINT OPTION

Standard Bit Set



BIT NO.	ITEM	SELECTIVE STATUS		STANDARD STATUS	REMARKS
		RESET	PRINT		
1	Time Print (on Sales Receipt, Report, Prog. Receipt)	RESET	PRINT	*	
		SET	NON-PRINT		
2	Item Count Print (on Sales Receipt)	RESET	PRINT	*	
		SET	NON-PRINT		
3	Sub-total Print (on Receipt & Journal)	RESET	PRINT	*	Will print Sub-total Amount on a depression of [ST] key.
		SET	NON-PRINT		
4	PLU Total Amounts on PLU Reports	RESET	PRINT	*	Will print Item Counts only.
		SET	NON-PRINT		
5	Customer Counts of Departments on Reports	RESET	PRINT	*	
		SET	NON-PRINT		
6	Department Sales Ratio Print on Reports	RESET	PRINT		Instead, Department Customer Counts will not be printed.
		SET	NON-PRINT	*	
7	--vacant--	RESET			
		SET			
8	--vacant--	RESET			
		SET			

ADDRESS NO.	CONTENTS
2	OPTIONAL FUNCTION I

Standard Bit Set

1	1	1	1	1	1	1	1	0
---	---	---	---	---	---	---	---	---

BIT NO.	ITEM	SELECTIVE STATUS		STANDARD STATUS	REMARKS
		RESET	Follow Bit No.		
1	1 Fraction Rounding: ROUND UP	RESET	Follow Bit No.2 Status	*	—If both "RESET", it will be ROUND OFF. (If both "SET", it will be DISCARD.)
		SET	ROUND UP		
2	2 Fraction Rounding: DISCARD	RESET	Follow Bit No.1 status	*	
		SET	DISCARD		
3	--vacant--	RESET			
		SET			
4	Split Package Pricing Fraction Rounding	RESET	Round Up Product	*	
		SET	Round Up Unit Price		
5	--vacant--	RESET			
		SET			
6	--vacant--	RESET			
		SET			
7	--vacant--	RESET			
		SET			
8	--vacant--	RESET			
		SET			

NOTE 1 2: The selective status of the fraction rounding here applies to quantity extension and % calculations, but not to tax calculations. The fraction resulted from any tax % calculations will be rounded off (no alternative rounding method is provided for this).

ADDRESS NO.	CONTENTS
3	OPTIONAL FUNCTION II

Standard Bit Set



BIT NO.	ITEM	SELECTIVE STATUS		STANDARD STATUS	REMARKS
		RESET	PROHIBITED		
1	Credit Balance in "REG" mode	RESET	PROHIBITED	*	
		SET	ALLOWED		
2	Drawer Open on X, Z Reports and GTX, GTZ Reports	RESET	OPEN	*	
		SET	NOT OPEN		
3	Time Display when Mode Lock is in the "LOCK" mode.	RESET	DISPLAYED	*	—on the Front Display only —"0" is displayed instead.
		SET	NOT DISPLAYED		
4	--vacant--	RESET			
		SET			
5	--vacant--	RESET			
		SET			
6	--vacant--	RESET			
		SET			
7	--vacant--	RESET			
		SET			
8	--vacant--	RESET			
		SET			

NOTE 1: "Credit Balance" means that a sale total is negative through entering larger negative amounts (through **DOLL DISC** key) than positive amounts. If status "SET" is selected, a negative sale total may be finalized. The use of the **DOLL DISC** key outside a sale is also allowed in this case. The **RTN MDSE** is not subject to this option selection. Any sale containing amounts entered through the **RTN MDSE** key may be finalized even if the sale total is negative.

ADDRESS NO.	CONTENTS
5	VALIDATION COMPULSORY II

Standard Bit Set

BIT NO.	ITEM	SELECTIVE STATUS		STANDARD STATUS	REMARKS
		RESET	FREE		
1	DOLL DISC	RESET	FREE	*	
		SET	COMPULSORY		
2	%-	RESET	FREE	*	
		SET	COMPULSORY		
3	Negative Departments and PLUs	RESET	FREE	*	
		SET	COMPULSORY		
4	BTL RTN	RESET	FREE	*	
		SET	COMPULSORY		
5	VND CPN	RESET	FREE	*	
		SET	COMPULSORY		
6	STR CPN	RESET	FREE	*	
		SET	COMPULSORY		
7	--vacant--	RESET			
		SET			
8	--vacant--	RESET			
		SET			

NOTE: See the "NOTE" on the previous page.

ADDRESS NO.	CONTENTS
6	MGR REQUIREMENT I

Standard Bit Set



BIT NO.	ITEM	SELECTIVE STATUS		STANDARD STATUS	REMARKS
		RESET	FREE		
1	[RTN MDSE]	RESET	FREE	*	
		SET	REQUIRED		
2	[PO]	RESET	FREE	*	
		SET	REQUIRED		
3	I [VOID]	RESET	FREE	*	
		SET	REQUIRED		
4	[CODE OPEN]	RESET	FREE	*	
		SET	REQUIRED		
5	[EX]	RESET	FREE	*	
		SET	REQUIRED		
6	--vacant--	RESET			
		SET			
7	--vacant--	RESET			
		SET			
8	--vacant--	RESET			
		SET			

NOTE: If the status "REQUIRED" is selected, the key can not be used in the "REG" mode. It may only be used in the "MGR" or "[]" position of the Mode Lock.

I: The status selection of Bit No.3 will also be applied to the [IC/VD] key when it is used as the VOID key.

ADDRESS NO.	CONTENTS
7	MGR REQUIREMENT II

Standard Bit Set



BIT NO.	ITEM	SELECTIVE STATUS		STANDARD STATUS	REMARKS
		RESET	FREE		
1	DOLL DISC	RESET	FREE	*	
		SET	REQUIRED		
2	%-	RESET	FREE	*	
		SET	REQUIRED		
3	Negative Departments and PLUs	RESET	FREE	*	
		SET	REQUIRED		
4	BTL RTN	RESET	FREE	*	
		SET	REQUIRED		
5	VND CPN	RESET	FREE	*	
		SET	REQUIRED		
6	STR CPN	RESET	FREE	*	
		SET	REQUIRED		
7	--vacant--	RESET			
		SET			
8	--vacant--	RESET			
		SET			

ADDRESS NO.	CONTENTS
9	TAX 2 STATUS

Standard Bit Set



BIT NO.	ITEM	SELECTIVE STATUS		STANDARD STATUS	REMARKS
		RESET	NON-TAXABLE		
1	[%+]	RESET	NON-TAXABLE	*	
		SET	TAXABLE		
2	[%-]	RESET	NON-TAXABLE	*	
		SET	TAXABLE		
3	[DOLL DISC]	RESET	NON-TAXABLE	*	
		SET	TAXABLE		
4	[BTL RTN] (Inside Sale or Department-linked Key)	RESET	NON-TAXABLE	*	
		SET	TAXABLE		
5	[VND CPN]	RESET	NON-TAXABLE	*	
		SET	TAXABLE		
6	[STR CPN]	RESET	NON-TAXABLE		
		SET	TAXABLE	*	
7	--vacant--	RESET			
		SET			
8	--vacant--	RESET			
		SET			

NOTE: See the "NOTE" on the previous page. The same content is applied except that "Taxable or Non-taxable" is subject to the TAX 2 STATUS on this page.

ADDRESS NO.	CONTENTS
11	SELECTIVE ITEMIZER CONTROL

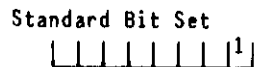

BIT NO.	ITEM	SELECTIVE STATUS		STANDARD STATUS	REMARKS
		RESET	PRINT		
1	SI/TL Print	RESET	PRINT		on Receipt and Remote Slip
		SET	NON-PRINT	*	(but prints on Journal only)
2	SI/TL Compulsory Before Finalizing each Sale	RESET	FREE	*	
		SET	COMPULSORY		
3	SI/TL %- Affect Main Itemizer	RESET	IGNORE	*	
		SET	AFFECT		
4	SI/TL %+ Affect Main Itemizer	RESET	IGNORE	*	
		SET	AFFECT		
5	--vacant--	RESET			
		SET			
6	--vacant--	RESET			
		SET			
7	--vacant--	RESET			
		SET			
8	--vacant--	RESET			
		SET			

NOTES 1: When either Bit No.3 or No.4 is selected to the "SET" status, the S.I. total amount will be printed on receipt regardless of the Bit No.1 status selection.

2: If status "SET" (COMPULSORY) is selected, depression of the SI/TL key is compulsory before finalizing a sale that contains any item with the S.I. status. Otherwise, it will result in an error.

3 & 4: If, for example, 5% has been preset for the SI/TL % and the "SET" (AFFECT) is selected for Bit No.3, the amount calculated out as 5% of the S.I. total amount will automatically be printed and subtracted from the main itemizer.

* Status Selection Combinations:

Bit No.3 ... RESET } SI/TL operation will not affect the main itemizer
 Bit No.4 ... RESET } at all.

Bit No.3 ... SET } Will result in the same condition as only the "SET"
 Bit No.4 ... SET } status of Bit No.4 is selected (i.e., AFFECT by preset %+ rate.)

* If no preset % rate is programmed but either of Bit No.3 or No.4 is set to "SET" (AFFECT) status, the calculation will result on the basis of the rate of 100%.

STORE NAME/MESSAGE AND COMMERCIAL MESSAGE PROGRAMMING

CONDITION: Any time outside a sale

OPERATION: Mode Lock: SET or MGR

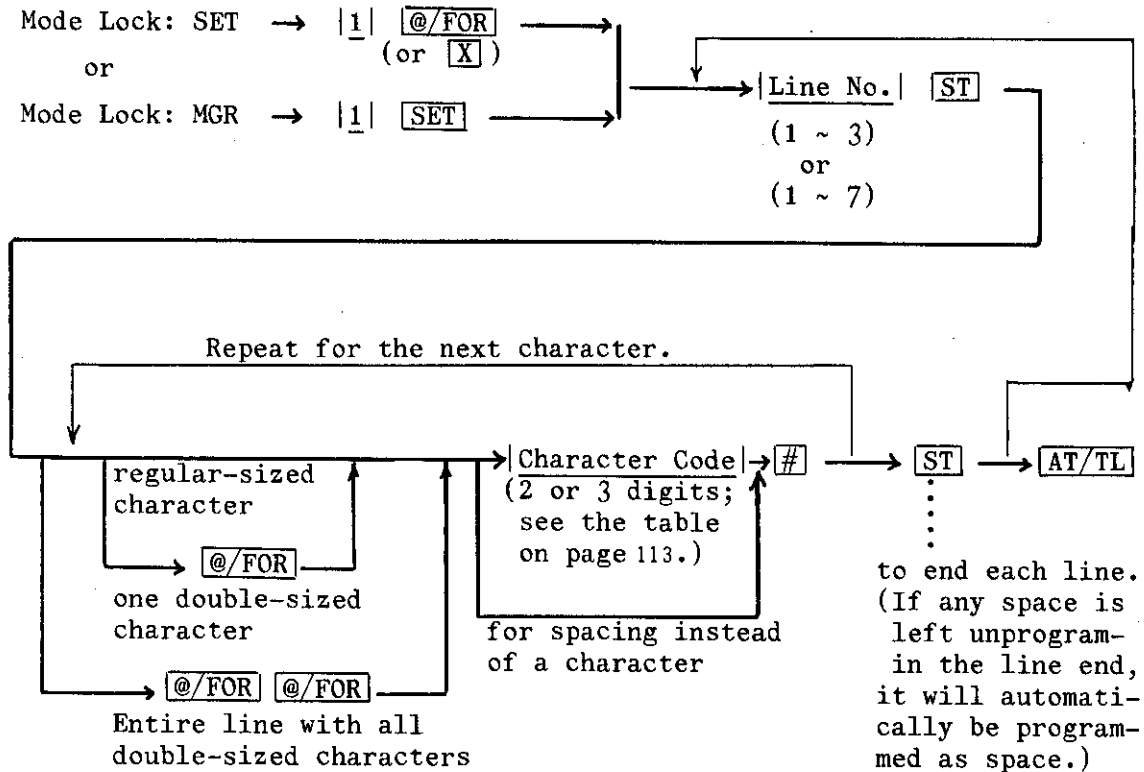

- NOTES:**
1. The # key after the Character Code entry may be replaced by the #/CID or #/NS key.
 2. For one line, a maximum of 20 regular-sized characters or 10 double-sized characters may be entered. A combination of both types is also available.
 3. If "Store Name/Message FIXED" is selected in the system option, no data can be programmed for the store name/message (and the store name stamp will be printed instead); therefore, enter 1 through 3 for each line of commercial message.
If "Store Name/Message PROGRAMMABLE" is selected in the system option, enter 1 through 4 for the store name/message and 5 through 7 for the commercial message.
 4. If no commercial message is required on the receipt, program all space for all the three lines. Then no message will be printed and no extra line space will be fed. If any one of the three lines is ever programmed, the two other lines will remain programmed with space and will turn out to be extra space lines to be fed on the receipt.
 5. The 4-line space assigned for the store name/message will be either printed (if programmed) or fed (if all space is programmed), but will never be shortened when a receipt is issued, as long as "Store Name/Message PROGRAMMABLE" status is selected in the system option.

CLERK NAME PROGRAMMING

CONDITION: Any time outside a sale

OPERATION: Mode Lock: SET or MGR

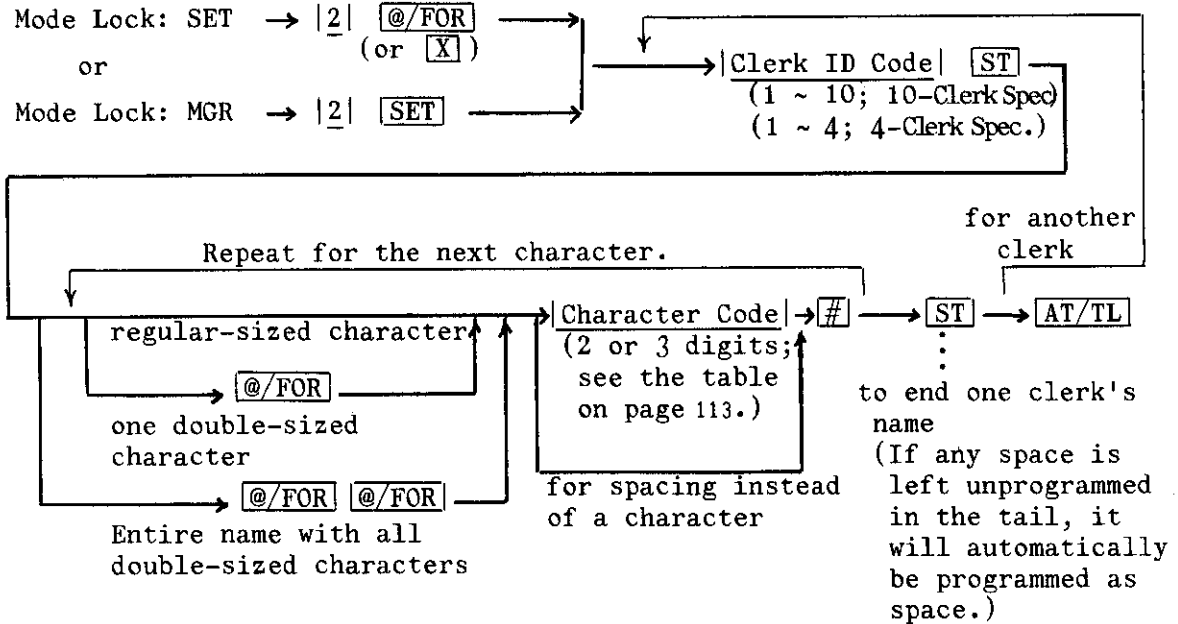

- NOTES:**
1. The [#] key after the Character Code entry may be replaced by the [# /CID] or [# /NS] key.
 2. For the name of one clerk, a maximum of 8 regular-sized characters or 4 double-sized characters may be entered. A combination of both types is also available.

ex.) To program "JONES" for Clerk 1,
"SMITH" for Clerk 2:

Mode Lock: SET, enter 2, depress [@/FOR].

Enter 1, depress [ST] (Clerk ID Code).
 Enter 20, depress [#] (J).
 " 25, " " (O).
 " 24, " " (N).
 " 15, " " (E).
 " 29, " " (S).
 Depress [ST] (to end Clerk 1).
 Enter 2, depress [ST] (Clerk ID Code).
 Enter 29, depress [#] (S).
 " 23, " " (M).
 " 19, " " (I).
 " 30, " " (T).
 " 18, " " (H).
 Depress [ST] (to end Clerk 2).

Depress [AT/TL] to end this program.

TEC STORE
 1343 PEACH DRIVE
 PHONE: 877-6437

Thank you
 Call again

09-07-00 #0

P 02

1CL JONES
 2CL SMITH

0021 11:13TM

DEPARTMENT NAME AND STATUS PROGRAMMING OR CHANGING

CONDITION: To change the Department Name only: Any time outside a sale
 To change the Department Tax Status: After Auto Reset
 To change the Department Positive/Negative Status:
 After an Auto Reset,
 GT Reset, and PLU Reset

OPERATION: Mode Lock: SET

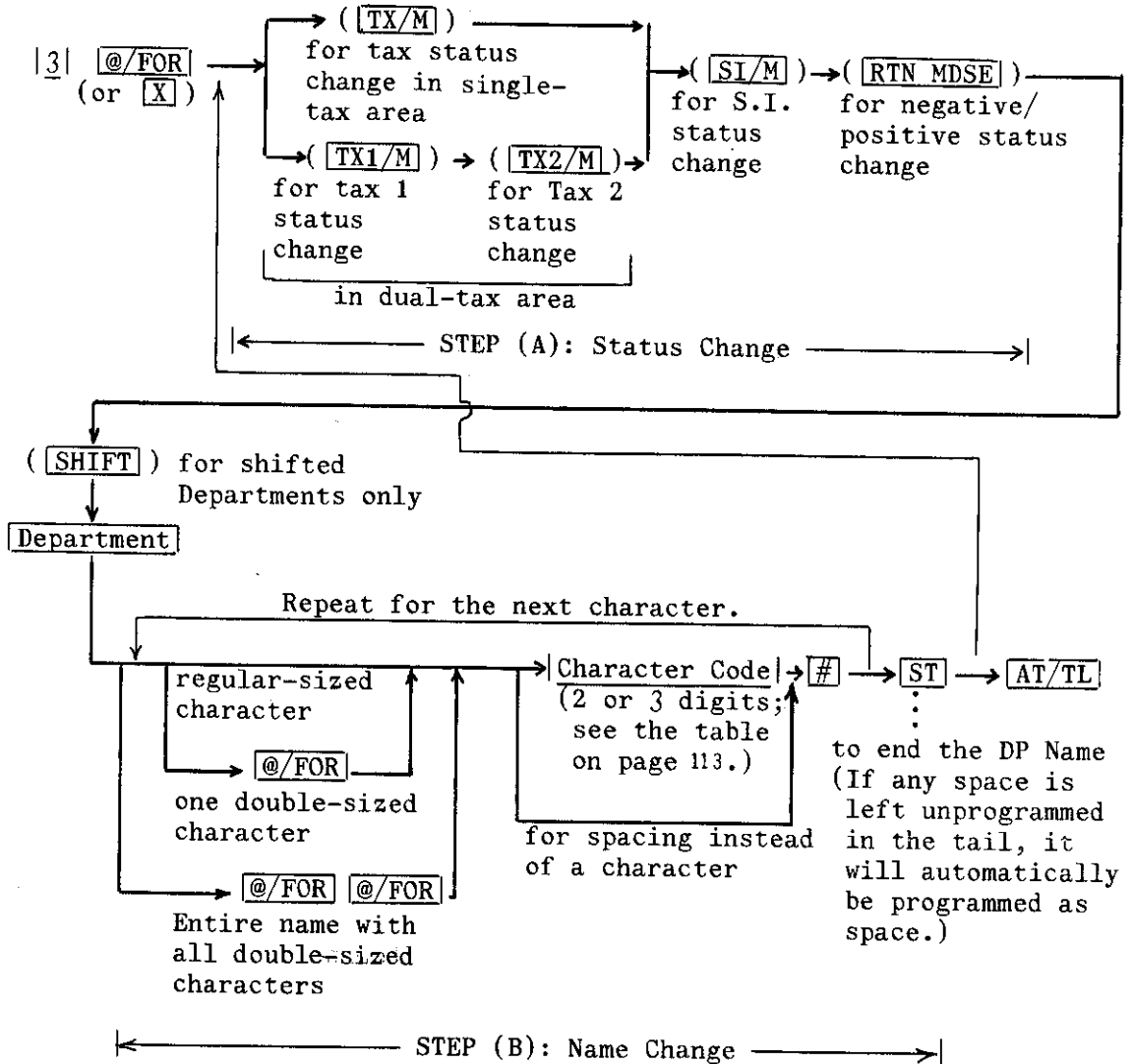

- NOTES:**
1. The "Department" is the Department Key whose status or name should be changed or programmed in this operation. The SHIFT and Department depressions will result in operating the shifted department. For example, SHIFT and Dept. 1 will be Dept.31.
 2. The # key after the Character Code entry may be replaced by the #/CID or #/NS key.
 3. For the name of a department, a maximum of 8 regular-sized characters or 4 double-sized characters may be entered. A combination of both types is also available.

4. When only the name is programmed or changed but not the status, STEP (A) may be skipped in the above operation. Likewise, when only the status is programmed or changed but not the name, STEP (B) may be skipped.
5. Among TX1/M (TX/M), TX2/M, and SI/M, depress the key(s) for the required status change(s) for each department. The RTN MDSE is depressed to set or reset the negative department status.
6. Depressing any of the three keys above, the related status reverses. For example, depressing the TX/M reverses a non-taxable department to a taxable, or taxable to non-taxable. Each department status is read by the number indicated in the AMOUNT portion of the display when each department key is depressed in the above operation. The numbers and their respective statuses are:

0: Non-taxable	"(-)" Lamp lit: negative
1: Tax 1 taxable only	"(-)" Lamp unlit:
2: Tax 2 taxable only	positive
3: Tax 1 and Tax 2 both taxable	(This status is reversed by the <u>RTN MDSE</u> key.)
4: S.I. only	
5: Tax 1 and S.I.	
6: Tax 2 and S.I.	
7: Tax 1 and Tax 2 and S.I.	

Watching the number, adjust the status by depressing these keys. See the examples below:

STATUS NUMBER BEFORE CHANGE	→	KEY-IN FOR CHANGE PRIOR TO <u>Dept</u> KEY	→	NEW NUMBER AND STATUS OBTAINED
0	→	<u>TX/M</u>	→	1(Tax1 only)
0	→	<u>TX1/M</u> <u>TX2/M</u>	→	3(Tax1 and Tax2)
0	→	<u>TX1/M</u> <u>SI/M</u>	→	5(Tax1 and S.I.)
		⋮		
		etc.		
1	→	<u>TX1/M</u>	→	0(Non-txbl, no S.I.)
1	→	<u>TX2/M</u>	→	3(Tax1 and Tax2)
1	→	<u>TX1/M</u> <u>TX2/M</u>	→	2(Tax2 only)
		⋮		
		etc.		
7	→	<u>TX2/M</u>	→	6(Tax2 and S.I.)
7	→	<u>SI/M</u>	→	3(Tax1 and Tax2)
		⋮		
		etc.		

In order to simplify the status setting operation, each department status may be reset to "0" by entering "0" and depressing the department key. (This can only be done after Auto Reset, GT Reset, and PLU Reset.) Then the required status is set simply by depressing the keys TX1/M (TX/M), TX2/M, and/or SI/M, only once.

ex.) To program the following status and name for each department:

<u>DEPT CODE</u>	<u>TAX STATUS</u> (Single-tax area)	<u>S.I. STATUS</u>	<u>NAME</u>
Dept. 1	Taxable	Non-S.I.	VEGETABL
Dept. 2	Taxable	Non-S.I.	FRUIT
Dept. 3	Taxable	Non-S.I.	MEAT
Dept. 4	Taxable	Non-S.I.	FISH
Dept. 5	Taxable	S.I.	DAIRY
Dept. 6	Taxable	Non-S.I.	BAKERY
Dept. 7	Taxable	S.I.	CANNED
Dept. 8	Taxable	S.I.	BOTTLED
Dept. 9	Taxable	S.I.	DRINK
Dept. 10	Taxable	S.I.	SNACK
Dept. 11	Taxable	S.I.	SPICE
Dept. 12			
	Taxable	Non-S.I.	
Dept. 16			
Dept. 17			
	Non-taxable	Non-S.I.	
Dept. 31			
Dept. 32	Non-taxable	Non-S.I.	Negative Dept.

KEY OPERATION (Presumed that the status has been reset to "0" and no name has been pre-programmed.)

Mode Lock to SET, enter 3, depress **@/FOR**.

Depress **TX/M** and then depress **DEPT 1**.

Enter 32, depress **#**. (V)

" 15, " " . (E)

" 17, " " . (G)

" 15, " " . (E)

" 30, " " . (T)

" 11, " " . (A)

" 12, " " . (B)

" 22, " " . (L)

Depress **ST** to end the name.

⋮

Depress **TX/M** and then **SI/M**, depress **DEPT 5**.

(Follow the character setting for "DAIRY" as shown for "VEGETABL" above.)

⋮

Depress **TX/M** and then depress **DEPT 12**.

(If no name is programmed, the code "DP12" is automatically set.)

⋮

Depress **RTN MDSE**, depress **DEPT 32**.

Depress **AT/TL** to end this program.

TEC STORE
1343 PEACH DRIVE
PHONE: 877-6437

Thank you
Call again

09-07-00 NO
P 03

01		1
01	VEGETABL	
02		1
02	FRUIT	
03		1
03	MEAT	
04		1
04	FISH	
05		5
05	DAIRY	
06		1
06	BAKERY	
07		5
07	CANNED	
08		5
08	BOTTLED	
09		5
09	DRINK	
10		5
10	SNACK	
11		5
11	SPICE	
12		1
13		1
14		1
15		1
16		1
32		0-

0026 11:24TM

PLU TABLE PROGRAMMING OR CHANGING

CONDITION: After a PLU Reset to renew the PLU table, or any time outside a sale to program additional PLUs or to change the PLU name only.

OPERATION: Mode Lock: SET

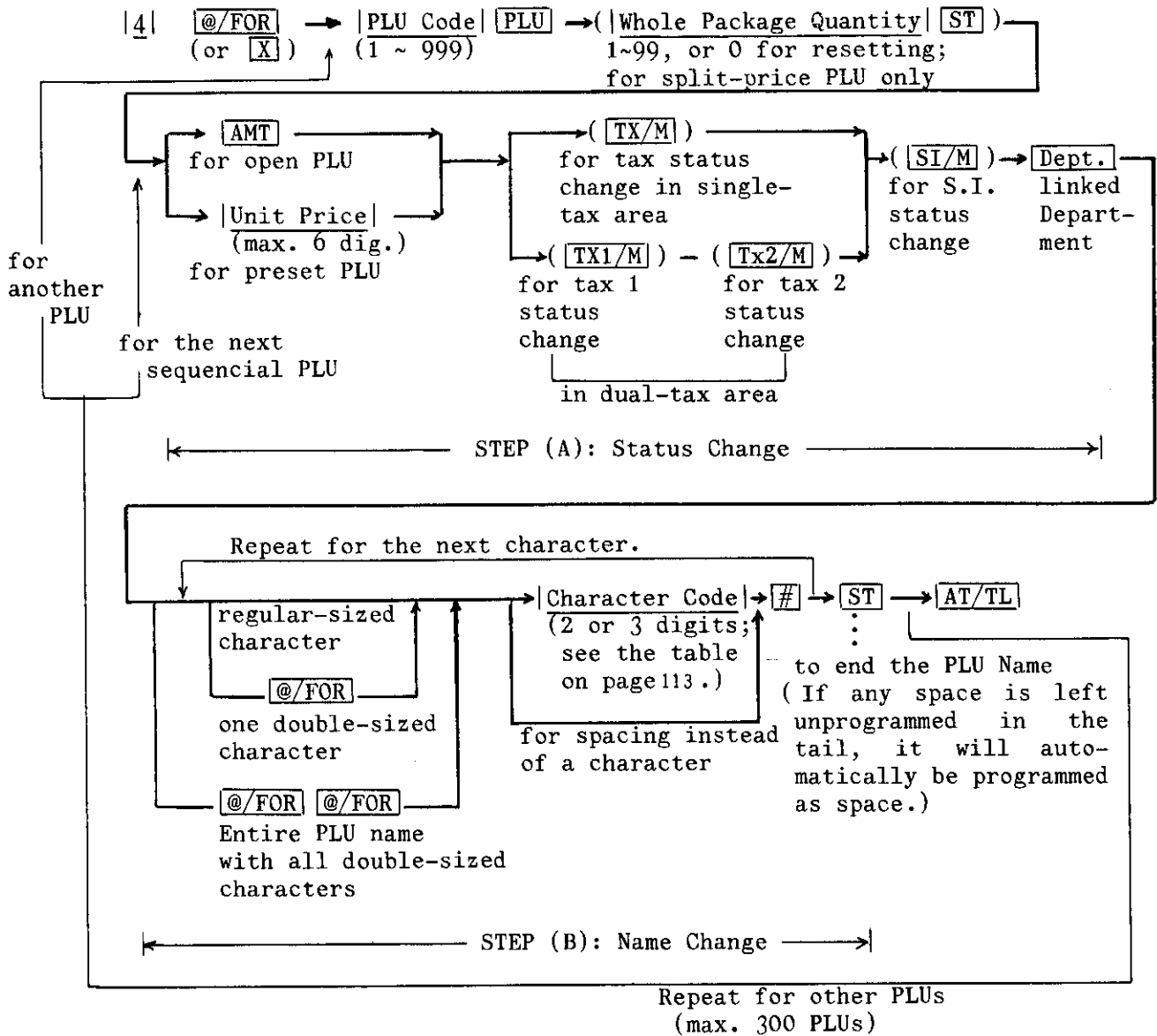

- NOTES:**
1. The "`|PLU Code| |PLU|`" entry may be skipped if the PLU Code is sequential from the previous PLU's code. If this PLU code entry is skipped at the very first PLU, the PLU code will automatically be programmed as PLU No.1.
 2. As for the tax status change and S.I. status change, refer to the description in NOTE 6 (page 78) which is attached to the "DEPARTMENT NAME AND STATUS PROGRAMMING OR CHANGING" operation. Each PLU's tax and S.I. status is programmed independently from that of the linked department. However, the positive/negative status of a PLU is ruled by that of its linked department.

3. STEP (A) may be skipped if the PLU name only is programmed or changed. Likewise, STEP (B) may be skipped if the PLU price, the tax and/or S.I. status, and/or linked department only are changed.
4. Depress the **SHIFT** key prior to the department key only when the linked department is a shifted department (i.e. Dept. 31 through Dept. 60 that will be shifted from Dept. 1 through Dept. 30 by the **SHIFT** key depression).

PLU TABLE DELETION

CONDITION: After a PLU Reset

OPERATION: Mode Lock: SET

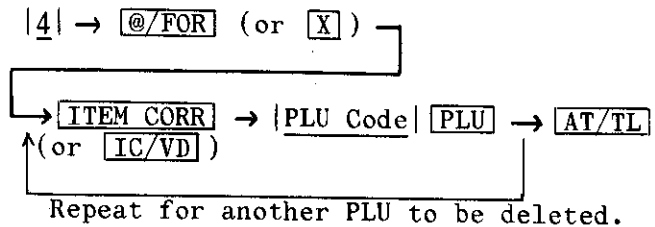

- NOTES:**
1. Deletion is possible with each PLU code, one by one. Deleting of all the PLUs at once is not possible.
 2. There is one way to delete all the PLUs at once. That is, to close to **PLU** key in the SFKC programming operation.

ex.) To delete PLU No.101, No.102, and No.202 that have once been programmed:

Mode Lock to SET, enter 4, depress **@/FOR** .

Depress **ITEM CORR** , enter 101, depress **PLU** .

Depress **ITEM CORR** , enter 102, depress **PLU** .

Depress **ITEM CORR** , enter 202, depress **PLU** .

Depress **AT/TL** to end.

TEC STORE	
1343 PEACH DRIVE	
PHONE: 877-6437	
Thank you	Call again
09-07-00	#0
	P 04
PLU101	-----
PLU102	-----
PLU202	-----
000	
JONES	0006 12:02TM

ex.) To program the following PLUs:

PLU CODE	WHOLE PACKAGE QUANTITY	UNIT PRICE or WHOLE PACKAGE PRICE	TAX STATUS S.I. STATUS	LINKED DEPT.	NAME
101	6	\$1.00	Taxable	01	Tomato
102		\$1.20	Taxable	01	Potato
201	5	\$1.50	Taxable	02	Apple
202	6	\$1.40	Taxable	02	Orange
301		open	Taxable	03	Beef
302		open	Taxable	03	Pork
501		\$2.00	Taxable,SI	05	Cheese 1/2
502		\$2.20	Taxable,SI	05	Butter 1/2
601		\$1.30	Taxable	06	WhiBread
602		\$1.10	Taxable	06	RyeBread
603		\$0.50	Taxable	06	HardRoll
604		\$0.40	Taxable	06	SoftRoll
901		\$0.25	Taxable,SI	09	7-up
902		\$0.25	Taxable,SI	09	Coke

KEY OPERATION (Presumed that no programmed data have been set to any PLUs before.) (Single-tax Area)

Mode Lock to SET, enter 4, depress **@/FOR**.

Enter 101 (PLU Code), depress **PLU**.

Enter 6 (Whole Package Q'ty), depress **ST**.

Depress **TX/M**, enter 100 (price), depress **DEPT 1**.

Enter 30, depress **#**. (T)

" 125, " " " (o)

" 123, " " " (m)

" 111, " " " (a)

" 130, " " " (t)

" 125, " " " (o) Depress **ST** to end the name.

Enter 102 (PLU Code), depress **PLU**.

Depress **TX/M**, enter 120 (price), depress **DEPT 1**.

(Follow the character setting for "Potato" as shown for "Tomato" above.)

⋮

Enter 501 (PLU Code), depress **PLU**.

Depress **TX/M** and then **SI/M**, enter 200 (price), depress **DEPT 5**.

(Follow the character setting for "Cheese¹/₂".)

⋮

⋮

⋮

Depress **AT/TL** to end.

TEC STORE
1343 PEACH DRIVE
PHONE: 877-6437

Thank you
Call again

09-07-00 #0

F 04

PLU101 01 01 1.00 / 6
Tomato

PLU102 01 01 1.20
Potato

PLU202 02 00 1.40 / 6
Orange

PLU301 03 01
Beef

PLU302 03 01
Pork

PLU501 05 05 2.00
Butter¹/₂

PLU502 05 05 2.20
Cheese¹/₂

PLU601 06 01 1.30
WhiBread

PLU602 06 01 1.10
RyeBread

PLU603 06 01 0.50
HardRoll

PLU604 06 01 0.40
SoftRoll

PLU901 09 05 0.25
7-up

PLU902 09 05 0.25
Coke

0008 12:21TH

TIME SETTING

CONDITION: Any time outside a sale

OPERATION: Mode Lock: SET or MGR

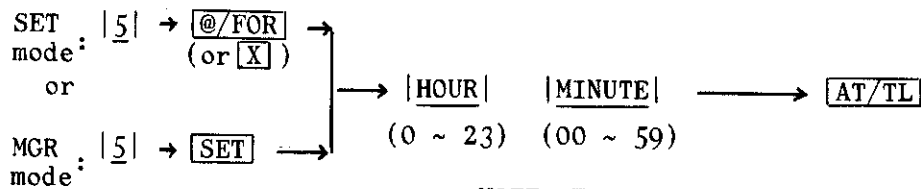

NOTE: Even if an hour value of more than 23 or a minute value of more than 59 is entered, it will not result in an error. In this case, do the setting operation over again with the correct values.

ex.) To set the time "13:40":

Mode Lock to SET, enter 5, depress

Enter 1340, depress .

DATE SETTING

CONDITION: Any time outside a sale

OPERATION: Mode Lock: SET

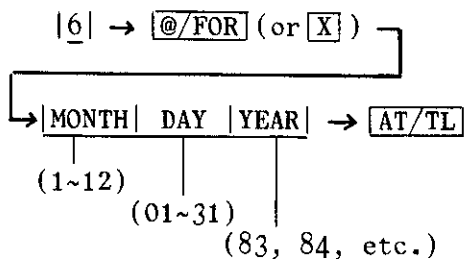

NOTE: The date entry order may be DAY-MONTH-YEAR instead of MONTH-DAY-YEAR, by system option, Address No.28.

ex.) To set the date "September 16, 1983":

Mode Lock to SET, enter 6, depress .

Enter (0) 9 1 6 8 3, depress .

↑ The top 0 may be omitted.

TEC STORE
 1343 PEACH DRIVE
 PHONE: 877-6437

Thank you
 Call again

09-07-00 #0

P 05
 13:40TH

0013 13:40TH

TEC STORE
 1343 PEACH DRIVE
 PHONE: 877-6437

Thank you
 Call again

09-07-00 #0

P 06
 09-16-83

0014 13:40TH

HOURLY RANGE SETTING

CONDITION: After Hourly Reset

OPERATION: Mode Lock: SET

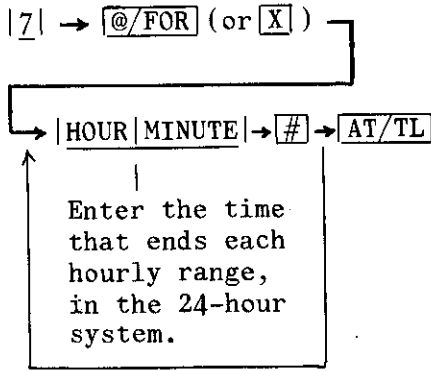

Repeat until all the time ranges are entered.

NOTES:

1. A maximum of 24 hourly ranges may be set.
2. To change the table of hourly ranges once set, partially or entirely, do the entire setting operation over again.
3. To reset the hourly range table once set, operate in "SET" mode:
|7| -> [@/FOR] -> |0| -> [#] -> [AT/TL]
4. Do not set a range across 24:00, such as "from 23:00 to 1:00". If ever set, no data will be processed into that hourly range.
5. Even if a time value more than 24:00 is set, it will not result in an error but the data will not be processed in that range.

ex.) To reset the hourly range table once set:

Mode Lock to SET, enter 7, depress [@/FOR] .

Enter 0, depress [#] , depress [AT/TL] .

TEC STORE
 1343 PEACH DRIVE
 PHONE: 877-6437

Thank you
 Call again

09-16-83 NO

P 07
 00:00TH

0016 13:41TH

ex.) To set the following hourly range table:

up to 8:00
 from 8:00 to 16:00
 from 16:00 to 23:00

Mode Lock to SET, enter 7, depress [@/FOR] .

Enter 800, depress [#] .
 Enter 1600, depress [#] .
 Enter 2300, depress [#] .

Depress [AT/TL] to end.

TEC STORE
 1343 PEACH DRIVE
 PHONE: 877-6437

Thank you
 Call again

09-16-83 NO

P 07
 08:00TH
 16:00TH
 23:00TH

0017 13:42TH

DEPARTMENT LISTING CAPACITY SETTING

CONDITION: After Auto Reset

OPERATION: Mode Lock: SET

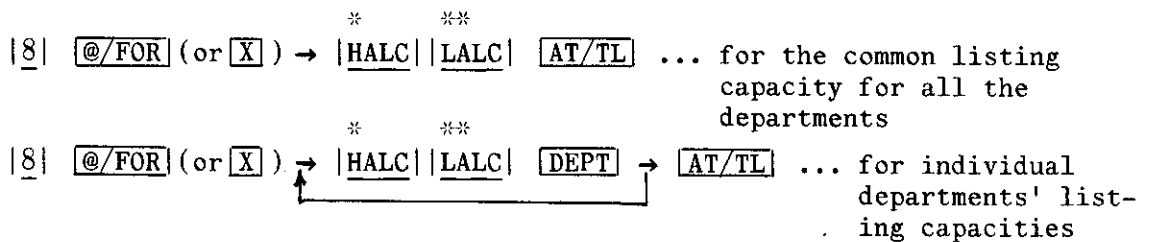

The above two operations may be combined as below:

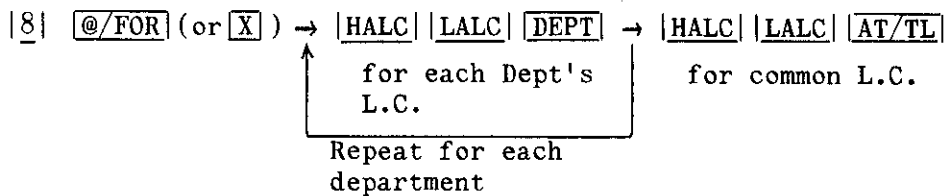

***Note:** HALC High Amount Listing Capacity (to be set in a 2-digit code)

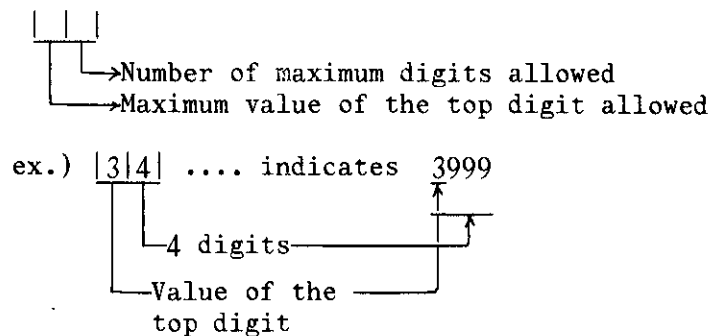

****Note:** LALC Low Amount Listing Capacity (to be set in a 2-digit code)

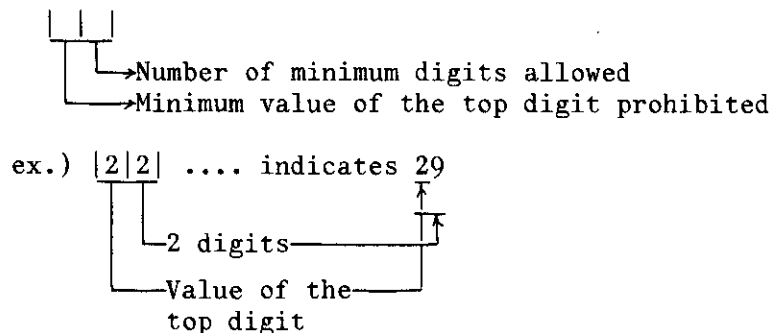

The amount range allowed to be entered in registraion:

Equal to or smaller than the HALC, ex.)
and Larger than the LALC 3999(HALC) ≥ Amount > 29(LALC)

- NOTES:**
1. If the individual listing capacity of a department has been set, it prevails over the common listing capacity.
 2. To reset an individual listing capacity, enter "0" before the **DEPT** key in the above operation. Then the common listing capacity for all the departments, if programmed, will prevail. The common listing capacity also may be reset if "0" is entered as the HALC in the above operation.
 3. The **SHIFT** key is operated prior to the **DEPT** key for a shifted department LC setting.
 4. If no listing capacity is required for HALC or LALC, enter 00 in place of a value:

ex.) |3|4| |0|0| **DEPT 1** ... No LALC is set for Dept. 1
 |0|0| |2|2| **DEPT 2** ... No HALC is set for Dept. 2
 |9|4| |0|0| **AT/TL** No LALC is set for Common LC.
 |0|0| |0|0| **DEPT 3** .. HALC and LALC once set is reset
 for Dept.3.

|
 The top 0's may be omitted.

ex.) To set Listing Capacities as in the following:

	HALC	LALC
DEPT 1 (VEGETABLE)	\$99.99 ~ \$0.10 (\$0.09)	
	9 4	9 1
DEPT 2 (FRUIT)	\$99.99 ~ \$0.20 (\$0.19)	
	9 4	1 2
COMMON LC	\$99,999.99 ~ No low limit	
	9 7	0 0

Mode Lock to SET, enter 8, depress **@/FOR** .

Enter 9491, depress **DEPT 1** .
 Enter 9412, depress **DEPT 2** .
 Enter 9700, depress **AT/TL** .

TEC STORE	
1343 PEACH DRIVE	
PHONE: 877-6437	
Thank you	Call again
09-16-83	#0
P 08	
01 VEGETABL	9491
02 FRUIT	9412
	9700
0019 13:47TM	

FINANCIAL TOTAL NAME PROGRAMMING OR CHANGING

CONDITION: After Auto Reset and GT Reset

OPERATION: Mode Lock: SET

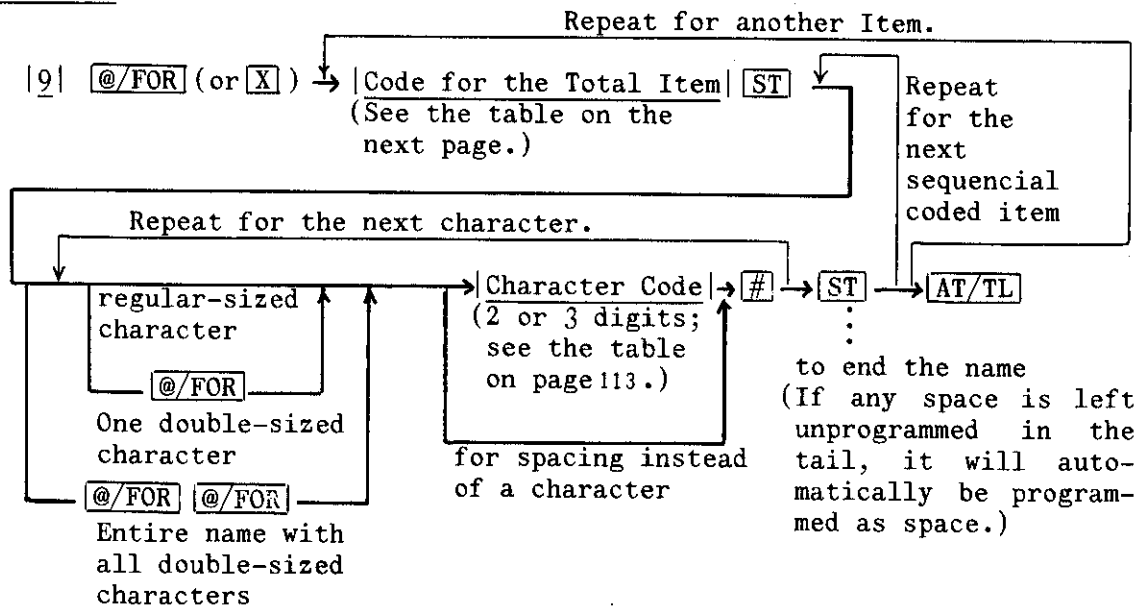

- NOTES:**
1. A maximum of 6 regular-sized characters or 3 double-sized characters may be programmed for one item name, with some exceptions. A combination of two types is also available.
 2. To go on to another Item name programming, the sequence "|Code for the Total Item| ST" may be skipped if the code is sequential.

ex.) To program "PO" in double-sized characters instead of "PO" in regular-sized characters (Standard Program Data) for Item No.21 (Paid Out):

Mode Lock to SET, enter 9, depress @/FOR .

Enter 21, depress ST (Item Code for Paid Out).
Depress

@/FOR twice (for declaration of entire name with double-sized characters)

Enter 26, depress # . (P)

Enter 25, depress # . (O)

Depress ST to end this name.

Depress AT/TL to end this program.

TEC STORE
1343 PEACH DRIVE
PHONE: 877-6437

Thank you
Call again

09-16-83 NO

#21 P 09
PO

0020 13:48TM

FINANCIAL TOTAL NAME TABLE

Code	Total or Counter Item	Max.Number of Characters	Name in Standard Program	Your Plan	Remarks
1	GT	6	G T		
2	NET GT	6	N E T G T		
3	GS	6	G S		
4	%+	6	% +		
5	Net Sale(without TAX)	6	N S		
6	TAX 1(SeparateTax1)	6	T A X 1		
7	TAX 2(SeparateTax2)	6	T A X 2		
8	Net Sale(with TAX)	6	N S		for ManualTAX also
9	%- (on ST)	6	% -		%- on Sub-total
10	Vendor Coupon	6	V . C P N		
11	Dollar Discount	6	D I S C		
12	BTL RTN (Inside)	6	B T R		Inside Sale BTR
13	Media Total	6	T O T A L		
14	Cash Total	6	C A S H		
15	Media 1	6	C H E C K		Media 1 & Cashing
16	Media 2	6	C h g		Media 2 & Cashing
17	Media 3	6	M I S C		Media 3 & Cashing
18	Media 4	6	C A R D		Media 4 & Cashing
19	Media 5	6	C P N		Media 5 & Cashing
20	Received on Account	6	R / A		
21	Paid Out	6	P O		
22	Loan	6	L O A N		
23	Pick Up	6	P I C K U P		
24	Cash-in-drawer	6	C A I D		
25	Media1-in-drawer	6	C K I D		
26	Media2-in-drawer	6	C h g I D		
27	Media3-in-drawer	6	M I S C I D		
28	Media4-in-drawer	6	C A R D I D		
29	Media5-in-drawer	6	C P N I D		
30	Item Correct on DP(+)	6	C O R R		
31	Void on DP(+)	6	V O I D		
32	IC/Void on Others	6	M S V D		IC=Item Correct
33	%- (on Item)	6	% -		%- on DP items
34	Store Coupn	6	S . C P N		
35	BTL RTN (DP-linked)	6	B T R		DP-linked BTR
36	Negative DP Total	6	- D P T L		
37	Return Merchandise	6	R T N		
38	Negative TAX	6	- T A X		
39	Audaction	6	- S A L E		
40	Negative Mode ([-])	6	R E G -		
41	Transfer Total	6	T F T L		
42	Transfer GT (+)	6	T F + G T		non-resettable
43	Transfer GT (-)	6	T F - G T		non-resettable
44	Transfer Daily (+)	6	T F +		
45	Transfer Daily (-)	6	T F -		
46	PB Sale	6	P B T L		
47	PB R/A	6	P B R / A		
48	PB Cash Total	6	P B C A		

-- To be continued on the next page. --

FINANCIAL TOTAL NAME TABLE -- Continued --

Code	Total or Counter Item	Max.Number of Characters	Name in Standard Program	Your Plan	Remarks
49	PB Media 1	6	P B C K		
50	PB Media 2	6	P B C H		
51	PB Media 3	6	P B M S		
52	PB Media 4	6	P B C A R D		
53	PB Media 5	6	P B C P N		
54	PB PO	6	P B P O		
55	Taxable Total 1	6	T X B L 1		
56	Taxable Total 2	6	T X B L 2		
57	Selective Itemizer	6	S I T L		
58	Tax Exemption	6	T A X E X		
59	Tax Exemption 1	6	T A X 1 E X		
60	Tax Exemption 2	6	T A X 2 E X		
61	Sales Item Count per Cus	6	I T / C U S		
62	Sales Amount per Cus	6	N S / C U S		
63	No-sale Counter	6	N O S A L E		
64	Validation Counter	6	V A L C T R		
65	Clerk Neg.Total 1	6	N E G 1		
66	Clerk Neg.Total 2	6	N E G 2		
67	TAX	6	T A X		
68	Total-in-drawer	6	T L I D		

NOTE: The print data shown in the "Name in Standard Program" column in the above table have automatically been set on the MA-1100-100 series for the convenience of the customer. Therefore, program only the items that require changes from the standard print data.

PRINT LINE ITEM NAME PROGRAMMING OR CHANGING

CONDITION: Any time outside a sale

OPERATION: Mode Lock: SET

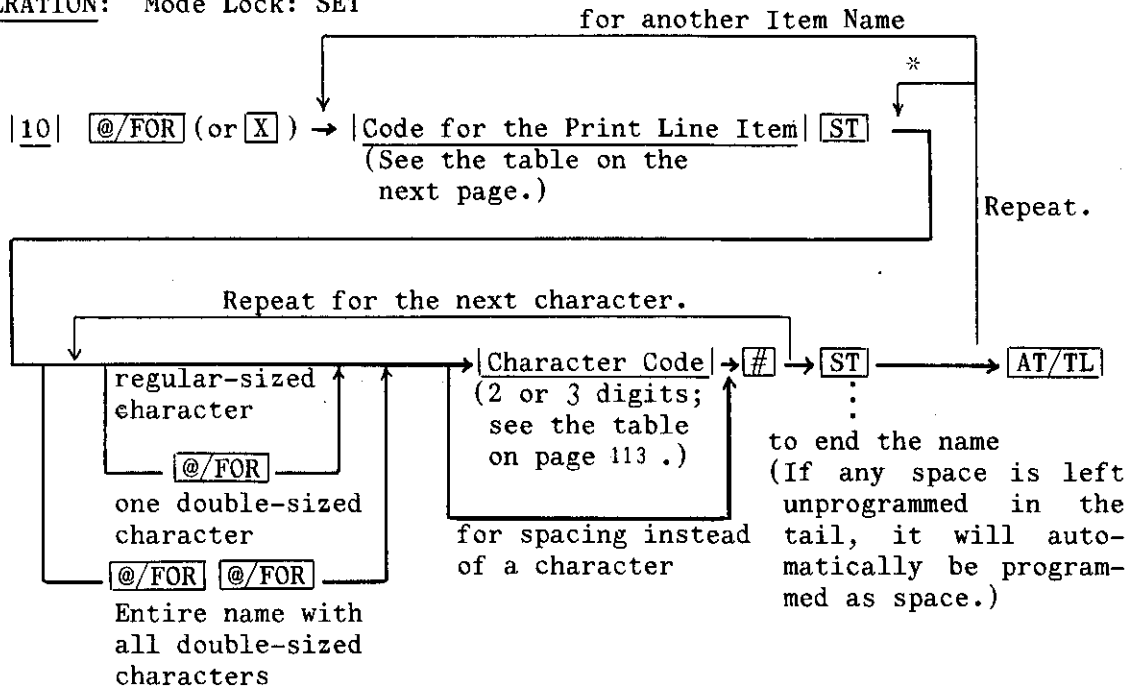

- NOTES:** 1. See the "Max. Number of Characters" column of the table on the next page as to the number of characters programmable for each item name. The number in the column indicates the capacity in regular-sized characters. One double-sized character occupies two regular-sized characters' space.
2. To go on to another Item name programming, the sequence "|Code for the Print Line Item| ST" may be skipped if the code is sequential. In this case, follow the line marked with "*".

ex.) To program the amount mark of "\$" in Item Code 8.
(The amount mark has not been programmed as the Standard Program Data.)
Meanwhile, other names for two other items in the same Item Code 8 should remain the same as the Standard Program Data (i.e., "@" for the Unit Price and "ITEM" for the Sales Item Count):

Mode Lock to SET, enter 10, depress @/FOR .

- Enter 8, depress ST (Item Code).
- Enter 10, depress # . (@)
- Enter 37, depress # . (\$)
- Enter 19, depress # . (I)
- Enter 30, depress # . (T)
- Enter 15, depress # . (E)
- Enter 23, depress # . (M)
- Depress ST to end character setting.
- Depress AT/TL to end this program.

TEC STORE
1343 PEACH DRIVE
PHONE: 877-6437

Thank you Call again

09-16-83 #0

#08 P 10

@ITEM

0021 13:51TM

PRINT LINE ITEM NAME TABLE

Code	Print Line Item	Max.Number of Characters	Name in Standard Program	Your Plan	Remarks
1	Sub-total	6	S U B T L		
2	Cash Tendered	6	C A T E N D		
3	Sale Total	6	T O T A L		
4	Change	6	C H A N G E		
5	Cash Refunded	6	C A S H		for Auction Total
6	Group Sub-total	6	G R P . S T		ST line for %
7	Nontaxable Subtotal	6	N T X . S T		
8	Unit Price	1	@		These three must be set together.
	Amount Mark	1			
	Sales Item Count	4	I T E M		
9	Time	2	T M		Theset three must be set together.
	Register No.Symbol	2	#		
	Clerk Symbol	2	C L		
10	Customer Count Symb.	2	C U		on reports
11	Department Group	6	G R O U P		on reports
12	Previous Balance +	6	P B +		
13	Previous Balance -	6	P B -		
14	Transferred Amount	6	N - B A L		

NOTE: If no programming operation is done for an item, the "Name in Standard Program" will automatically be active. Therefore, program only the items that require changes from the standard print data.

FIXED PRINT LINE ITEM NAMES (NOT PROGRAMMABLE)

Print Line Item	Number of Characters	Fixed Item Name	Remarks
Cons. No. Symbol	0		No symbol is printed.
Program Symbol	2	P	
Read (X) Symbol	2	X	
Reset (Z) Symbol	2	Z	
GT Read Symbol	6	G T X	
GT Reset Symbol	6	G T Z	
System Option Address	1	#	
% Symbol	1	%	
PLU Name	6	P L U x x x	xxx is the PLU No. 1
Department Name	4	D P x x	xx is the Dept. No. 2
Non-add Number Symbol	1	#	
Taxable Status Symbol	1	T	for Tax1 and/or Tax2 item
S.I. Status Symbol	1	S	
Negative Symbol	1	-	
Q'ty in Multiplication	1	X	

NOTES 1 2: These print line item names will be printed in case there has been no name programmed for the registered PLU or Department.

NON-TAXABLE AMOUNT LIMIT SETTING

CONDITION: After Auto Reset and GT Reset; This program is applicable only to restaurants in Province of Quebec, Canada.

If this program has been set, the tax is calculated and added to the sale total which exceeds the limit amount even when the sale is entirely composed of non-taxable items. The tax levied when exceeding this limit amount will be calculated by the TAX 1 table which is to be described and programmed later in this manual.

OPERATION: Mode Lock: SET

|12| @/FOR (or X) → |Non-taxable Limit Amount| → AT/TL

- NOTES:**
1. To reset the limit amount once set, enter "0" in place of the |Non-taxable Limit Amount| in the above operation.
 2. This tax calculation program will be disregarded when the sale total is negative.

Example: Setting limit amount to "\$3.25":

Case 1) Normal Department Entry (Mode Lock: REG)

|326| → non-taxable DEPT → AT/TL

... The amount entered \$3.26 is greater than the limit amount \$3.25. It will therefore be taxed.

Case 2) Returned Merchandise Entry (Mode Lock: REG)

RTN MDSE → |326| → non-taxable DEPT → AT/TL

... The non-taxable total is negative. The tax already levied will therefore not be returned.

ex.) To set the Non-taxable Limit Amount to "\$2.00":

Mode Lock: SET

Enter 12, depress @/FOR (or X).
Enter 200, depress AT/TL.

TEC STORE
1343 PEACH DRIVE
PHONE: 877-6437
Thank you
Call again
09-16-83 #0
P 12
\$2.00
0024 13:54TM

SPECIAL CHARACTER GENERATION TABLE PROGRAMMING

This program is provided to prepare special characters to be used for printing messages, etc. by each customer, adding them to the CHARACTER CODE TABLE which is shown on page 113 as those already available on this ECR.

- . Type of Characters Programmable: Regular-sized Characters or Double-sized Characters
- . Maximum Number of Characters: 30 (Regular-sized) or 10 (Double-sized)
- . Character Codes Assigned for These Special Characters: 170 through 199 (Regular-sized) 254 through 263 (Double-sized)

After programming special characters, fill in the blank table attached to the CHARACTER CODE TABLE on page 113.

CONDITION: Any time outside a sale

OPERATION: Mode Lock: SET

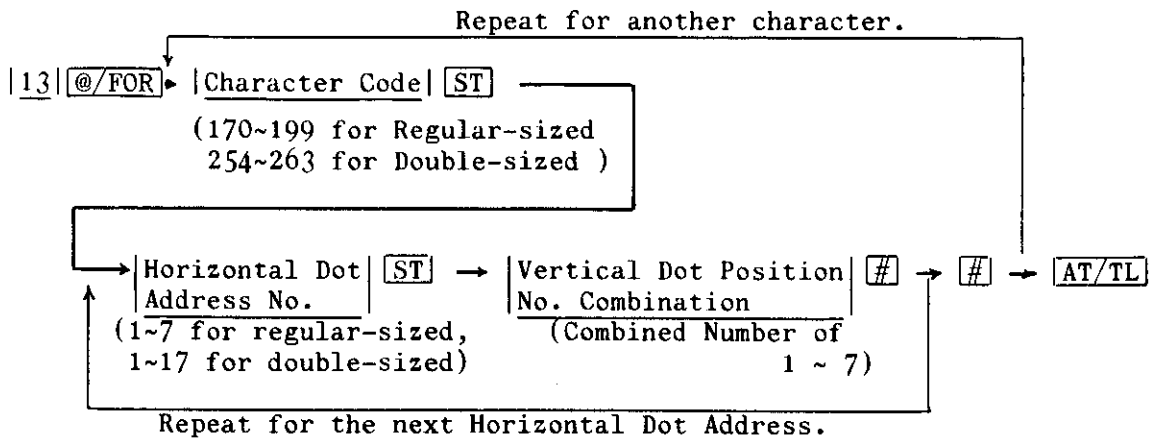

ENLARGED FIGURE OF DOT MATRIX COMPOSITION

Regular-sized Character

Double-sized Character

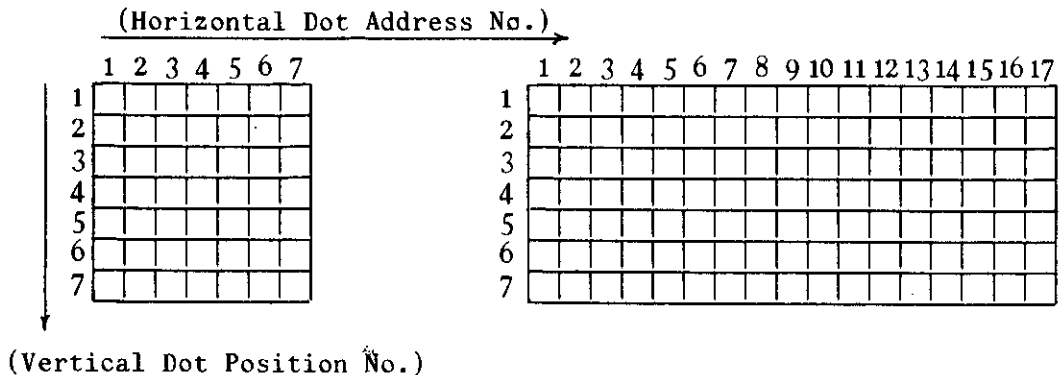

NOTES: 1. Programming a dot-print right or left way next to a pre-programmed dot-print position will result in an error.

ex.)

A	B	C	
D	•	E	
F	G	H	

If a dot-print has already programmed in the position shown as "•", no dot-print can be programmed in the position of D or E. It will be all right to program dot-printing in the position of A, B, C, F, G, or H.

2. To read what has already been programmed with a specific Character Code, operate:

Mode Lock to SET, |13| @/FOR → |Character Code| ST → # → AT/TL .

Then the character that has programmed with the Character Code will be printed.

Programming Example

To program the character as in the figure below with Character Code 170 assigned:

	1	2	3	4	5	6	7
1				•			
2			•		•		
3		•				•	
4	•						•
5		•				•	
6			•		•		
7				•			

Key Operation

Mode Lock: SET

13 @/FOR

170 ST (Assigned Character Code)

1 ST 4 #

2 ST 35 #

3 ST 26 #

4 ST 17 #

5 ST 26 #

6 ST 35 #

7 ST 4 #

(to end this character)

AT/TL (to end this program)

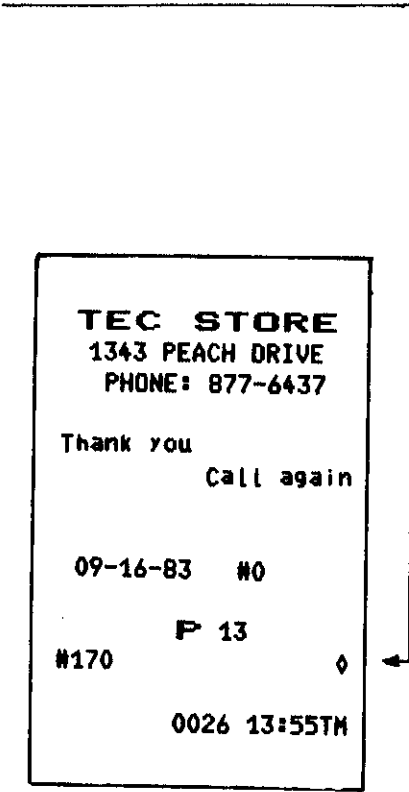

DEPARTMENT GROUP PROGRAMMING OR CHANGING

CONDITION: After Auto Reset and GT Reset

OPERATION: Mode Lock: SET

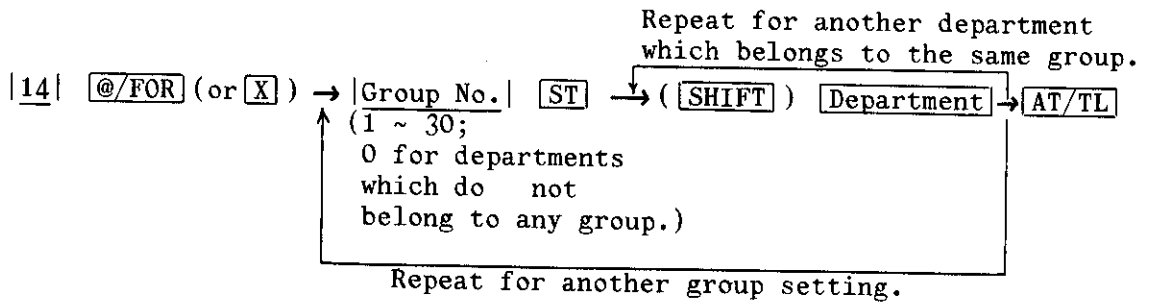

- NOTES:**
1. If "0" is entered at the "|Group No.|" , the following department will be reset from grouping program (i.e., the department will not belong to any group).
 2. Depress the **SHIFT** key prior to the Department Key if it is a shifted department.
 3. If no number is entered as the "|Group No.|" , it will be regarded the same as "0" is entered.
 4. Do not program any negative departments to a group. It will not result in an error if such an attempt is made, but such grouping data will be disregarded anyway.
 5. To reset all grouping program data once set, operate:
Mode Lock: SET, |14| @/FOR → |0| → AT/TL .

ex.) GROUP TABLE

KEY OPERATION

Group 1:
 Dept. 1
 Dept. 2
 Dept. 3
 Dept. 4

Group 2:
 Dept. 5
 Dept. 6
 Dept. 7
 Dept. 8
 Dept. 9
 Dept. 10
 Dept. 11

Group 3:
 Dept. 12
 Dept. 13
 Dept. 14
 Dept. 15
 Dept. 16

Mode Lock to SET.
 Enter 14, depress @/FOR .

Enter 1, depress ST .
 Depress DEPT 1 ,
 DEPT 2 ,
 DEPT 3 ,
 DEPT 4 .

Enter 2, depress ST
 Depress DEPT 5 ,
 DEPT 6 ,
 DEPT 7 ,
 DEPT 8 ,
 DEPT 9 ,
 DEPT 10 ,
 DEPT 11 .

Enter 3, depress ST .
 Depress DEPT 12 ,
 DEPT 13 ,
 DEPT 14 ,
 DEPT 15 ,
 DEPT 16 .

Depress AT/TL to end.

TEC STORE
 1343 PEACH DRIVE
 PHONE: 877-6437

Thank you
 Call again

09-16-83 #0

P 14

GROUP01 01 VEGETABL
 02 FRUIT
 03 MEAT
 04 FISH

GROUP02 05 DAIRY
 06 BAKERY
 07 CANNED
 08 BOTTLED
 09 DRINK
 10 SNACK
 11 SPICE

GROUP03 12 DP12
 13 DP13
 14 DP14
 15 DP15
 16 DP16

0031 14:04TM

CUSTOMER FILE CODE OPENING AND CLOSING

CONDITION: This program is available only when the "Check Track Memory Provided" option is selected. Any time outside a sale.

OPERATION: Mode Lock: SET

OPENING

Repeat for another code.

|15| @/FOR → |Customer File Code| [#] → |AT/TL|
 (max. 6 digits;
 1 ~ 999999)

- NOTES:**
1. The Customer File Codes that have been opened in this program will be accessed by entering the code and depressing the **PICK UP BAL** key for a new customer registration in charge posting operation. At this time, the balance of the new customer assigned with the code will show "0", which will be printed as the first line item. On finalizing the sale, the new balance will be printed at the bottom of the receipt, which will be stored in the same Customer File Code. Thus the operator always uses the **PICK UP BAL** key for both starting a new customer's account and recalling the customer's balance.
 2. If all the opened Customer File Nos are used up and a new customer file No. is required to be opened during the business hours, the **CODE OPEN** key is used. When a new code (or No.) is entered and then the **CODE OPEN** key is depressed, the No. is printed as the first line item with the balance "0" on the receipt, and at the same time, the No. is added to the table of the Customer File Codes opened in the above operation. However, the use of the **CODE OPEN** key can be programmed to require Manager Intervention, which can control the operator's opening of a new customer file code outside the table of customer file codes programmed in the "SET" mode.
 3. The maximum memory capacity for the Customer File Code opening is for 840 Customer File Codes. However, the memory is shared with the PLU table; therefore, the maximum number of codes will be determined according to the memory portion shared to the PLU table. Choose the best combination that suits the customer requirement among the listed below:

Number of PLUs	Number of Customer File Codes
300	0
200	280
100	560
0	840

CLOSING |15| @/FOR → |ITEM CORR| → |Customer File Code| [#] → |AT/TL|
 Repeat for another Track Code to be closed

NOTE: If the balance of the closed code has not been "0", the TRF memory will be adjusted to "0". In this case, the previous balance that has just been reset will be printed at the same time.

ex.) To close the following Customer File Codes that have been used during the business hours:

#1
#1111

Mode Lock to SET, enter 15, depress **@/FOR** .

Depress **ITEM CORR**,
enter 1, depress **#** .

Depress **ITEM CORR**,
enter 1111, depress **#** .

Depress **AT/TL** to end.

TEC STORE
1343 PEACH DRIVE
PHONE: 877-6437

Thank you
Call again

Previous Balance (now reset) 09-16-83 #0
Closed Code P 15

#000001	0,00

#001111	5,00

000	

Total Number of Codes that remain opened

0126 14:04TM

ex.) To open Customer File Codes from #1 to #20:

Mode Lock to SET, enter 15, depress **@/FOR** .

Enter 1, depress **#** .

" 2, " "

" 3, " "

" 4, " "

" 5, " "

" 6, " "

" 7, " "

" 8, " "

" 9, " "

" 10, " "

" 11, " "

" 12, " "

" 13, " "

" 14, " "

" 15, " "

" 16, " "

" 17, " "

" 18, " "

" 19, " "

" 20, " "

Depress **AT/TL** to end.

TEC STORE
1343 PEACH DRIVE
PHONE: 877-6437

Thank you
Call again

09-16-83 #0

Opened Code P 15

#000001
#000002
#000003
#000004
#000005
#000006
#000007
#000008
#000009
#000010
#000011
#000012
#000013
#000014
#000015
#000016
#000017
#000018
#000019
#000020

Total Number of Opened Codes

020

0128 14:05TM

DEPARTMENT PRESET PRICE SETTING OR CHANGING

CONDITION: Any time outside a sale

OPERATION: Mode Lock: SET or MGR

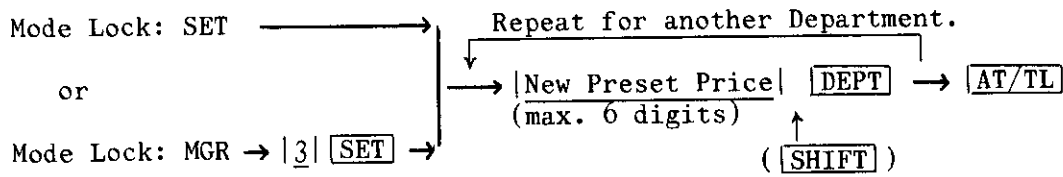

- NOTES:**
1. To preset the price of "0", enter "0" in place of the price entry in the above operation.
 2. If no price is entered in the above operation, the department is set as an open department.
 3. Depress **SHIFT** prior to the department key if the price is preset on a shifted department.

ex.) To set the following preset prices on the respective Departments:

\$1.20 for Dept. 12
 \$1.30 for Dept. 13
 \$1.40 for Dept. 14
 \$1.50 for Dept. 15
 \$1.60 for Dept. 16

Mode Lock to SET.

Enter 120, depress **DEPT 12** .
 Enter 130, depress **DEPT 13** .
 Enter 140, depress **DEPT 14** .
 Enter 150, depress **DEPT 15** .
 Enter 160, depress **DEPT 16** .

Depress **AT/TL** to end.

TEC STORE
 1343 PEACH DRIVE
 PHONE: 877-6437

Thank you
 Call again

09-16-83 #0

P

12 DP12	\$1.20
13 DP13	\$1.30
14 DP14	\$1.40
15 DP15	\$1.50
16 DP16	\$1.60

0035 14:08TM

PLU PRESET PRICE CHANGING

CONDITION: Any time outside a sale

OPERATION: Mode Lock: SET or MGR

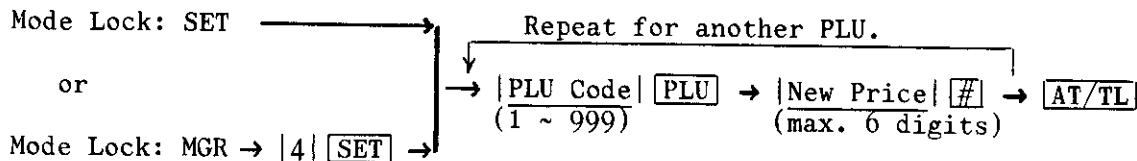

- NOTES:**
1. The PLU Codes to be entered in this operation must be the PLU Codes that were programmed in the "PLU TABLE PROGRAMMING OR CHANGING" operation already described on page . Otherwise, it will result in an error.
 2. If "0" is entered as the New Price, the preset price of the PLU will be set to be "0". If the New Price entry is skipped before the [#] key, it will result in an error.
 3. If an attempt to preset a price to an open PLU, it will result in an error.
 4. In this operation, changes of link departments, programming additional PLUs, programming or changing the PLU name are not possible.

ex.) To change the preset price of
PLU No.102 (Potato) from
\$1.20 to \$1.40 :

Mode Lock to SET.

Enter 102, depress [PLU] (PLU Code).

Enter 140, depress [#] (New Price).

Depress [AT/TL] to end.

<p>TEC STORE 1343 PEACH DRIVE PHONE: 877-6437</p> <p>Thank you Call again</p> <p>09-16-83 #0</p> <p>P PLU102 01 01 \$1.40 Potato</p> <p>0036 14:09TH</p>

%+ AND **%-** PRESET RATE SETTING

CONDITION: Any time outside a sale

OPERATION: Mode Lock: SET

|Preset % Rate| → **%+** (or **%-**)



(0.001 ~ 99.999; use the **.** key
if a decimal portion is contained.)

ex.) To set the **%+** preset rate of 10%:

Mode Lock: SET → |10| → **%+**

ex.) To set the **%-** preset rate of 20%:

Mode Lock: SET → |20| → **%-**

NOTE: To reset the rate once set:

Mode Lock: SET → |0| → **%+** (or **%-**)

PRESET RATE SETTING ON **SI/TL** KEY

CONDITION: After Auto Reset

OPERATION: Mode Lock: SET

|Preset % Rate| → **SI/TL**

(0.01 ~ 99.99; use the **.** key
if a decimal portion is contained.)

ex.) To set the preset rate of 10%
on the **SI TL** key:

Mode Lock: SET → |10| → **SI/TL**

NOTES: 1. To reset the rate once set:

Mode Lock: SET → |0| → **SI/TL**

2. Whether the calculated amount by
the preset % rate affects (i.e.
add to or subtract from) the main
itemizer is determined by System
Option Address 11 - Bit Nos 3 and
4.

TEC STORE	
1343 PEACH DRIVE	
PHONE: 877-6437	
Thank you	Call again
09-16-83	#0
X+	P 10%
0037 14:10TH	

TEC STORE	
1343 PEACH DRIVE	
PHONE: 877-6437	
Thank you	Call again
09-16-83	#0
X-	P 20%
0038 14:10TH	

TEC STORE	
1343 PEACH DRIVE	
PHONE: 877-6437	
Thank you	Call again
09-16-83	#0
SITL	P 10%
0039 14:10TH	

TENDER LISTING CAPACITY SETTING

CONDITION: After Auto Reset

OPERATION: Mode Lock: SET

|HALC| → AT/TL (Cash Tender L. C.)

|HALC| → CHK TND (Check Tender L. C.)
(or MEDIA 1)

|HALC| → Chg (Charge Tender L. C.)
(or MEDIA 2)

|HALC| → MSC TND (Misc. Tender L. C.)
(or MEDIA 3)

|HALC| → CARD (Media 4 Tender L. C.)
(or MEDIA 4)

|HALC| → MEDIA 5 (Media 5 Tender L. C.)

*HALC ... Refer to the HALC description in the
"DEPARTMENT LISTING CAPACITY SETTING"
operation on page .

NOTE: To reset the L. C. once set:

Mode Lock: SET → |0| → Media Key

ex.) To set the Check Tender L.C. to 45
(= Tender Amount Limit \$499.99)

Mode Lock to set, enter 45, depress CHK TND.

TEC STORE	
1343 PEACH DRIVE	
PHONE: 877-6437	
Thank you	
Call again	
09-16-83	#0
	P
CHECK	45
	0040 14:11TM

DOLLAR DISCOUNT LIMIT AMOUNT SETTING

CONDITION: After Auto Reset

OPERATION: Mode Lock: SET

|Dollar Discount Limit Amount| → DOLL DISC
(max. 4 digits; up to 9999¢)

NOTE: To reset the Limit Amount once set:

Mode Lock: SET → |0| → DOLL DISC

ex.) To set Dollar Disc. Limit Amount to \$5.00:

Mode Lock to SET, enter 500, depress DOLL DISC.

TEC STORE	
1343 PEACH DRIVE	
PHONE: 877-6437	
Thank you	
Call again	
09-16-83	#0
	P
DISC	\$5.00
	0041 14:12TM

BOTTLE RETURN LIMIT AMOUNT SETTING

CONDITION: After Auto Reset

OPERATION: Mode Lock: SET

|Bottle Return Limit Amount| → **BTL RTN**
(max. 4 digits, up to 9999¢)

- NOTES:**
1. To reset the Limit Amount once set:
Mode Lock: SET → |0| → **BTL RTN**
 2. For quantity extension, the price is subject to this limit amount not the product.
 3. This limit amount is not applied to the DP-linked **BTL RTN** key, which will be ruled by the department listing capacity.

ex.) To set the Limit Amount of \$0.50:

Mode Lock to SET, enter 50, depress **BTL RTN**.

TEC STORE	
1343 PEACH DRIVE	
PHONE: 877-6437	
Thank you	Call again
09-16-83	#0
BTR	P \$0.50
0042 14:12TM	

VENDOR COUPON LIMIT AMOUNT SETTING

CONDITION: After Auto Reset

OPERATION: Mode Lock: SET

|Vendor Coupon Limit Amount| → **VND CPN**
(max. 4 digits, up to 9999¢)

- NOTE:** To reset the Limit Amount once set:
Mode Lock: SET → |0| → **VND CPN**

ex.) To set the Limit Amount of \$30.00:

Mode Lock to SET, enter 3000, depress **VND CPN**.

TEC STORE	
1343 PEACH DRIVE	
PHONE: 877-6437	
Thank you	Call again
09-16-83	#0
V.CPN	P \$30.00
0043 14:13TM	

STORE/REGISTER NO. SETTING

CONDITION: After Auto Reset and GT Reset

OPERATION: Mode Lock: SET

|Store/Register No.| → **#** (or **#/NS**)
(max. 6 digits;
0 ~ 999999)

- NOTE:** The **.** key can not be used in setting the Store/Register No.

ex.) To set Store/Register No. 123456

Mode Lock to SET, enter 123456, depress **#**.

TEC STORE	
1343 PEACH DRIVE	
PHONE: 877-6437	
Thank you	Call again
09-16-83	#0
	P #123456
0044 14:13TM	

TAX TABLE PROGRAMMING

CONDITION: After Auto Reset and GT Reset

OPERATION: Mode Lock: SET

1) Tax 1 Full Breaks

|max. amount non-taxable| → TX1/M

|max. amount for 1¢ tax levied| → TX1/M

|max. amount for 2¢ tax levied| → TX1/M

⋮

Repeat until the "A" Break is entered.

⋮

|max. amount for N¢ tax levied| → TX1/M ... "A" Break

ST (to indicate the "A" Break entry)

|max. amount for N+1¢ tax levied| → TX1/M

|max. amount for N+2¢ tax levied| → TX1/M

⋮

Repeat until the "B" Break is entered.

AT/TL (to end)

NOTE: The amount entry may be a maximum of 4-digit value (9999¢).

2) Tax 1 "A" Break and % Rate Combination

First set the "A" Break following the same operation up to the "A" Break entry and the ST depression in the above "1) Tax 1 Full Breaks".

↓

|TAX RATE applied when exceeding the "A" Break amount|

(Maximum 4 digits, up to 99.99%. Do not use the . key. Example: To set 5%, enter 500. The fraction of the amount resulting from this % rate calculation will be rounded off.)

↓

AT/TL (to end)

3) Tax 1 % Rate Only

|0| → TX/M → ST → |TAX RATE| → AT/TL

(The conditions of the rate are the same as the above TAX RATE.)

- NOTES: 1. If only one tax modifier key (TX/M) is installed on the keyboard, use the TX/M in place of the TX1/M in the description of 1), 2), or 3) above.
2. For TAX 2 Table programming, follow the same procedure in 1), 2), or 3) above, using the TX2/M instead of the TX1/M.
3. If both TAX 1 and TAX 2 tables are programmed, the TAX 1 must be set first. The TAX 1 table entry will automatically reset both the TAX 1 and TAX 2 tables that have been programmed.
4. No second depression of the ST key is allowed within one tax table programming.

ex. 1) Full Break (in a single-tax area)

<u>Tax Table</u>		<u>Key Operation</u>	
<u>Amount Range</u>	<u>Tax Levied</u>		
		Mode Lock to SET.	
\$0.00~\$0.10	0¢	Enter 10, depress <u>TX/M</u> .	00
\$0.11~\$0.22	1¢	Enter 22, depress <u>TX/M</u> .	01
\$0.23~\$0.39	2¢	Enter 39, depress <u>TX/M</u> .	02
\$0.40~\$0.56	3¢	Enter 56, depress <u>TX/M</u> .	03
\$0.57~\$0.73	4¢	Enter 73, depress <u>TX/M</u> .	04
\$0.74~\$0.90	5¢	Enter 90, depress <u>TX/M</u> .	05
\$0.91~\$1.08	6¢	Enter 108, depress <u>TX/M</u> .	06
"A" Break		Depress <u>ST</u>	*
\$1.09~\$1.24	7¢	Enter 124, depress <u>TX/M</u> .	07
\$1.25~\$1.41	8¢	Enter 141, depress <u>TX/M</u> .	08
\$1.42~\$1.58	9¢	Enter 158, depress <u>TX/M</u> .	09
\$1.59~\$1.74	10¢	Enter 174, depress <u>TX/M</u> .	10
\$1.75~\$1.91	11¢	Enter 191, depress <u>TX/M</u> .	11
\$1.92~\$2.08	12¢	Enter 208, depress <u>TX/M</u> .	12
"B" Break		Depress <u>AT/TL</u> .	**

TEC STORE
1343 PEACH DRIVE
PHONE: 877-6437

Thank you
Call again

09-16-83 #123456

P TAX1

	\$0.10
	\$0.22
	\$0.39
	\$0.56
	\$0.73
	\$0.90
	\$1.08
	\$1.24
	\$1.41
	\$1.58
	\$1.74
	\$1.91
	\$2.08

0045 14:15TM

ex. 2) "A" Break and % Rate Combination (in a single-tax area)

<u>Tax Table</u>		<u>Key Operation</u>
<u>Amount Range</u>	<u>Tax Levied</u>	
\$0.00~\$0.09	0¢	Mode Lock to SET. Enter 9, depress <input type="checkbox"/> TX/M .
\$0.10~\$0.29	1¢	Enter 29, depress <input type="checkbox"/> TX/M .
\$0.30~\$0.59	2¢	Enter 59, depress <input type="checkbox"/> TX/M .
\$0.60~\$0.84	3¢	Enter 84, depress <input type="checkbox"/> TX/M .
\$0.85~\$1.12	4¢	Enter 112, depress <input type="checkbox"/> TX/M .
"A" Brreak		Depress <input type="checkbox"/> ST .
5% is applied above the "A" Break		Enter 500, depress <input type="checkbox"/> AT/TL .

TEC STORE
1343 PEACH DRIVE
PHONE: 877-6437

Thank you
Call again

09-16-83 #123456

P TAX1

00	\$0.09
01	\$0.29
02	\$0.59
03	\$0.84
04	\$1.12
*	
	5%

0046 14:16TH

ex. 3) % Rate only (in a single-tax area)

<u>Tax Table</u>	<u>Key Operation</u>
10% is applied to any amount.	Mode Lock to SET. Enter 0, depress <input type="checkbox"/> TX/M Depress <input type="checkbox"/> ST . Enter 1000, depress <input type="checkbox"/> AT/TL .

TEC STORE
1343 PEACH DRIVE
PHONE: 877-6437

Thank you
Call again

09-16-83 #123456

P TAX1

00	\$0.00
*	
	10%

0047 14:16TH

PROGRAMMING OPERATIONS IN "MGR" MODE (MANAGER'S PROGRAMMING)

In this chapter are described operations to change the data already programmed in the "SET" mode. In order to fulfill each store's requirements for changing the programmed data on the daily, weekly, or monthly basis, these operations are designed to be available in the "MGR" position of the Mode Lock, which is accessed by the MGR or MA key. These operations are also available in the "SET" mode so that the programmer may cover them along with other major items to be programmed or changed on a longer period basis. To enable the programming operations in the "MGR" mode, the **SET** key must be installed on the keyboard. During these operations, any one of the Clerk Keys must be inserted and set to its own position.

TABLE OF CONTENTS

<u>"MGR" MODE</u>			
<u>Prog. No.</u>	<u>Program Item</u>	<u>Condition</u>	<u>page</u>
1 ---	STORE NAME/MESSAGE AND COMMERCIAL MESSAGE PROGRAMMING	----- Anytime ¹	----- 107
2 ---	CLERK NAME PROGRAMMING	----- Anytime	----- 109
3 ---	DEPARTMENT PRESET PRICE SETTING OR CHANGING	----- Anytime	----- 110
4 ---	PLU PRESET PRICE CHANGING	----- Anytime	----- 111
5 ---	TIME SETTING	----- Anytime	----- 112

NOTE 1: "Anytime" indicates "Any time outside a sale".

STORE NAME/MESSAGE AND COMMERCIAL MESSAGE PROGRAMMING

CONDITION: Any time outside a sale

OPERATION:

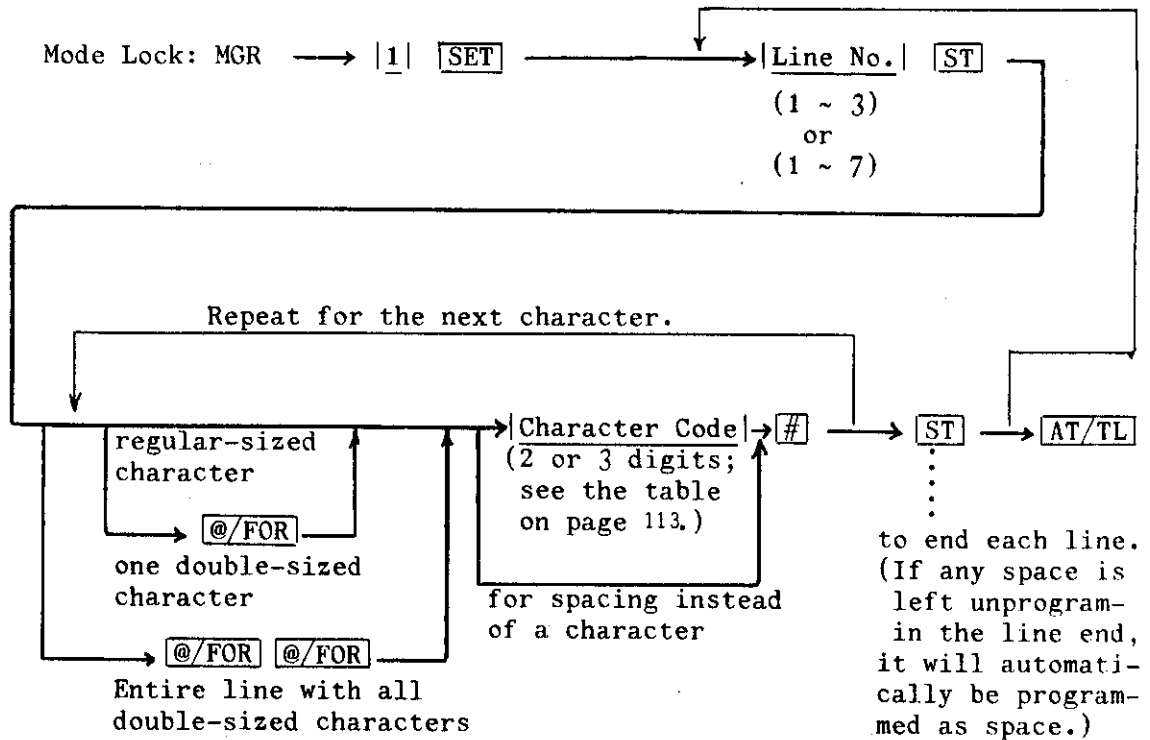

- NOTES:**
1. The # key after the Character Code entry may be replaced by the #/CID or #/NS key.
 2. For one line, a maximum of 20 regular-sized characters or 10 double-sized characters may be entered. A combination of both types is also available.
 3. If "Store Name/Message FIXED" is selected in the system option, no data can be programmed for the store name/message (and the store name stamp will be printed instead); therefore, enter 1 through 3 for each line of commercial message. If "Store Name/Message PROGRAMMABLE" is selected in the system option, enter 1 through 4 for the store name/message and 5 through 7 for the commercial message.
 4. If no commercial message is required on the receipt, program all space for all the three lines. Then no message will be printed and no extra line space will be fed. If any one of the three lines is ever programmed, the two other lines will remain programmed with space and will turn out to be extra space lines to be fed on the receipt.
 5. The 4-line space assigned for the store name/message will be either printed (if programmed) or fed (if all space is programmed), but will never be shortened when a receipt is issued, as long as "Store Name/Message PROGRAMMABLE" status is selected in the system option.

CLERK NAME PROGRAMMING

CONDITION: Any time outside a sale

OPERATION:

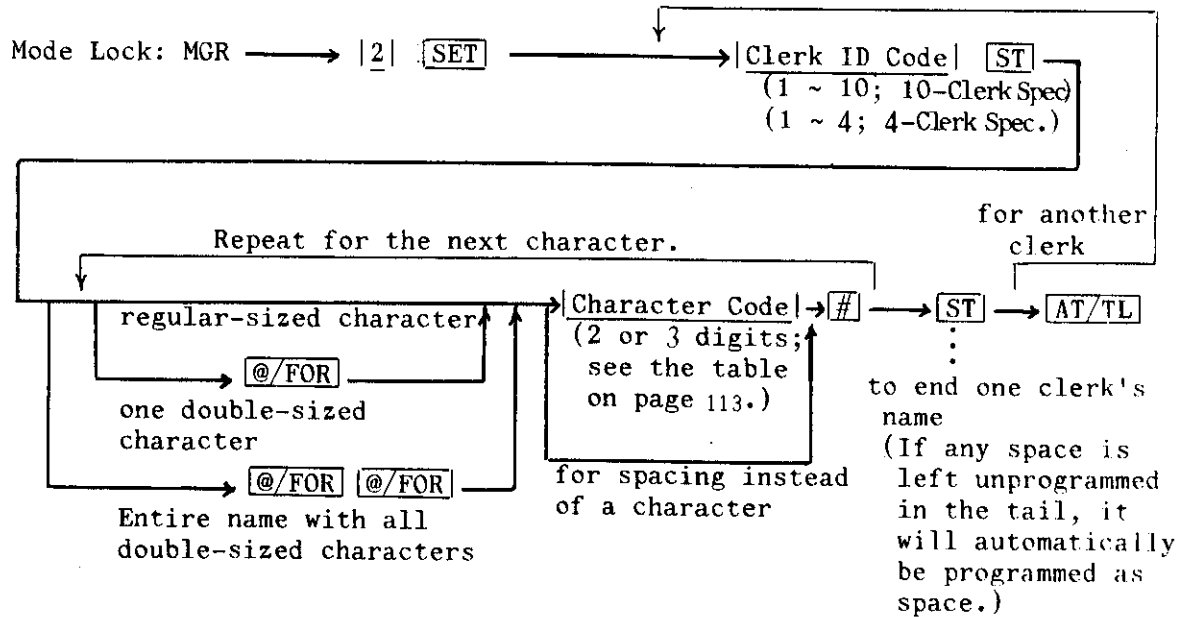

- NOTES: 1. The [#] key after the Character Code entry may be replaced by the [# /CID] or [# /NS] key.
2. For the name of one clerk, a maximum of 8 regular-sized characters or 4 double-sized characters may be entered. A combination of both types is also available.

ex.) To program "JONES" for Clerk 1,
"SMITH" for Clerk 2:

Mode Lock: MGR, enter 2, depress [SET] . .

Enter 1, depress [ST] (Clerk ID Code).

Enter 20, depress [#] (J).

" 25, " " (O).

" 24, " " (N).

" 15, " " (E).

" 29, " " (S).

Depress [ST] (to end Clerk 1).

Enter 2, depress [ST] (Clerk ID Code).

Enter 29, depress [#] (S).

" 23, " " (M).

" 19, " " (I).

" 30, " " (T).

" 18, " " (H).

Depress [ST] (to end Clerk 2).

Depress [AT/TL] to end this program.

TEC STORE	
1343 PEACH DRIVE	
PHONE: 877-6437	
Thank you	
Call again	
09-07-00	#0
	P 02
1CL	JONES
2CL	SMITH
0021 11:13TH	

DEPARTMENT PRESET PRICE SETTING OR CHANGING

CONDITION: Any time outside a sale

OPERATION:

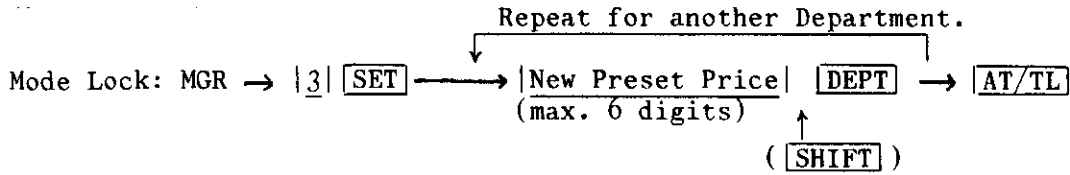

- NOTES:**
1. To preset the price of "0", enter "0" in place of the price entry in the above operation.
 2. If no price is entered in the above operation, the department is set as an open department.
 3. Depress **SHIFT** prior to the department key if the price is preset on a shifted department.

ex.) To set the following preset prices on the respective Departments:

\$1.20 for Dept. 12
\$1.30 for Dept. 13
\$1.40 for Dept. 14
\$1.50 for Dept. 15
\$1.60 for Dept. 16

Mode Lock to MGR, enter 3, depress **SET** .

Enter 120, depress **DEPT 12** .
Enter 130, depress **DEPT 13** .
Enter 140, depress **DEPT 14** .
Enter 150, depress **DEPT 15** .
Enter 160, depress **DEPT 16** .

Depress **AT/TL** to end.

TEC STORE	
1343 PEACH DRIVE	
PHONE: 877-6437	
Thank you	
Call again	
09-16-83 #0	
P	
12 DP12	\$1.20
13 DP13	\$1.30
14 DP14	\$1.40
15 DP15	\$1.50
16 DP16	\$1.60
0035 14:08TM	

PLU PRESET PRICE CHANGING

CONDITION: Any time outside a sale

OPERATION:

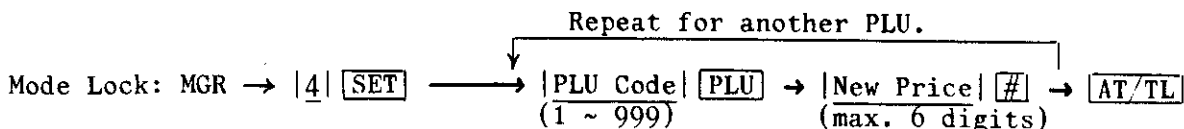

- NOTES:**
1. The PLU Codes to be entered in this operation must be the PLU Codes that were programmed in the "PLU TABLE PROGRAMMING OR CHANGING" operation already described on page . Otherwise, it will result in an error.
 2. If "0" is entered as the New Price, the preset price of the PLU will be set to be "0". If the New Price entry is skipped before the [#] key, it will result in an error.
 3. If an attempt to preset a price to an open PLU, it will result in an error.
 4. In this operation, changes of link departments, programming additional PLUs, programming or changing the PLU name are not possible.

ex.) To change the preset price of
PLU No.102 (Potato) from
\$1.20 to \$1.40 :

Mode Lock to MGR, enter 4, depress [SET]

Enter 102, depress [PLU] (PLU Code).

Enter 140, depress [#] (New Price).

Depress [AT/TL] to end.

<p>TEC STORE 1343 PEACH DRIVE PHONE: 877-6437</p> <p>Thank you Call again</p> <p>09-16-83 #0</p> <p>P PLU102 01 01 \$1.40 Potato</p> <p>0036 14:09TM</p>

TIME SETTING

CONDITION: Any time outside a sale

OPERATION: Mode Lock: MGR

|5| → **SET** → |HOUR| |MINUTE| → **AT/TL**
(0 ~ 23) (00 ~ 59)

NOTE: Even if an hour value of more than 23 or a minute value of more than 59 is entered, it will not result in an error. In this case, do the setting operation over again with the correct values.

ex.) To set the time "13:40":

Mode Lock to MGR, enter 5, depress **SET**.

Enter 1340, depress **AT/TL**.

TEC STORE
1343 PEACH DRIVE
PHONE: 877-6437

Thank you
Call again

09-07-00 #0

F 05
13:40TH

0013 13:40TH

CHARACTER CODE TABLE (Standard Characters)

→ Column Code

	0	1	2	3	4	5	6	7	8	9	10	11	12	13	14	15	16	
↓ Row Code	0	0	@	J	T	ア	サ	ナ	マ	ラ	ア	,	½	j	t	Ä	ä	â
1	1	A	K	U	イ	シ	ニ	ミ	リ	イ	.	a	k	u	Ö	ö	ê	
2	2	B	L	V	ウ	ス	ヌ	ム	ル	ウ	:	b	l	v	Ü	ü	ç	
3	3	C	M	W	エ	セ	ネ	メ	レ	エ	'	c	m	w	Æ	æ	é	
4	4	D	N	X	オ	ソ	ノ	モ	ロ	オ	/	d	n	x	Œ	œ	è	
5	5	E	O	Y	カ	タ	ハ	ヤ	ワ	ツ	#	e	o	y	Å	å	ú	
6	6	F	P	Z	キ	チ	ヒ	ユ	ヲ	ヤ	*	f	p	z	Ñ	ñ	á	
7	7	G	Q	\$	ク	ツ	フ	ヨ	ン	ユ		g	q	+	%	ß	í	
8	8	H	R	£	ケ	テ	ヘ	["	ヨ	&	h	r	ó	///	Đ	ó	
9	9	I	S	¥	コ	ト	ホ]	°	-	!	i	s	=	?	ø		

CHARACTER CODE TABLE
(Kanji Characters)

→ Column Code

	20	21	22	23	24	25	
↓ Row Code	0	合	入	取	高	月	特
1	計	金	消	課	日	奉	
2	現	返	客	税	組	休	
3	小	支	点	万	人	~	
4	預	払	回	買	上		
5	釣	値	数	責	任		
6	掛	引	信	受	名		
7	売	割	純	免	訂		
8	戻	個	円	料	定		
9	替	券	在	年	総		

SPECIAL CHARACTER CODE TABLE

(Fill in the blanks the characters or symbols programmed in the "SPECIAL CHARACTER GENERATION TABLE PROGRAMMING".)

	17	18	19
0			
1			
2			
3			
4			
5			
6			
7			
8			
9			

	25	26
0		
1		
2		
3		
4		
5		
6		
7		
8		
9		

WAY OF INPUTTING CODES: First enter the Column Code and then the Row Code for the required character. For example, to access "B", enter 12.
Each of the Kanji Characters occupies a double-sized character space, despite each character is input in the "Regular-sized Character" method. The same is applied to the Codes from 254 through 263.

PROGRAMMING OPERATIONS THROUGH THE PROGRAMMING KEYBOARD (OPTIONAL)

The TEC Programming Keyboard (TKB-1-A) may be connected to the MA-1100-200 ECR as an optional device for programming routines.

With this keyboard, programming operations, particularly those requiring alpha/numeric character setting for descriptors of departments, PLUs, and Clerk Names, etc. will be performed more easily.

CONNECTION TO THE ECR

- (1) Open the Ribbon Cover of the ECR and follow the descriptions referring to the figure below:

OVERVIEW BEHIND RIBBON COVER

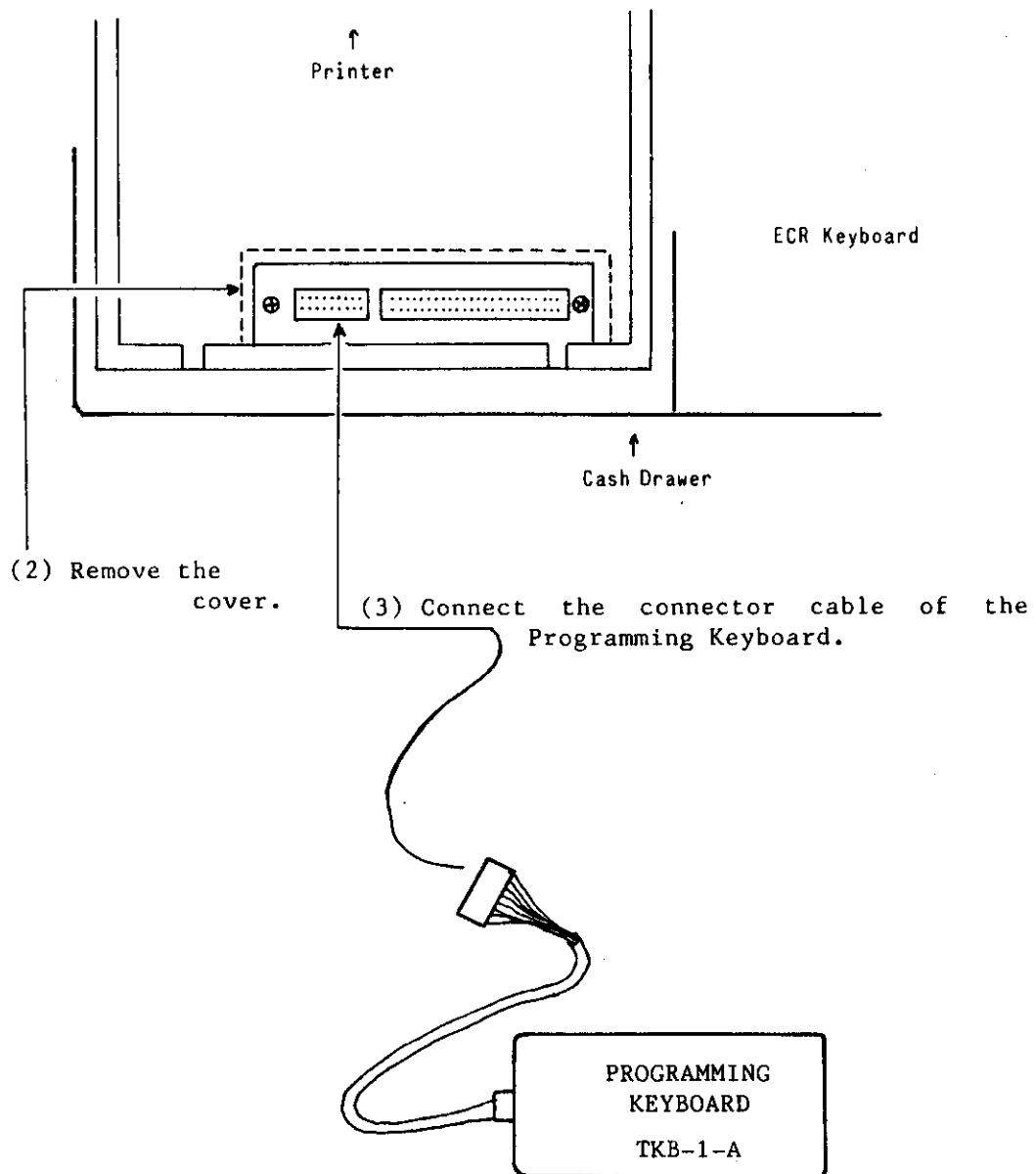

KEYBOARD LAYOUT

SFT1	! ?	II £	#	* \$	%	&	' :	[/] +	- =	CLEAR
	170	171	172	173	174	175	176	177	178	179	
SFT2	1	2	3	4	5	6	7	8	9	0	X
	180	181	182	183	184	185	186	187	188	189	
SFT3	Q Ä	W Ö	E Ü	R Æ	T Œ	Y Å	U Ñ	I Ð	O	P	CODE
	190	191	192	193	194	195	196	197	198	199	
SFT4	A ä	S ö	D ü	F æ	G œ	H å	J ñ	K ß	L ø	☺	AT/TL
	254	255	256	257	258	259	260	261	262	263	
SFTLOCK	Z á	X é	C ç	V é	B è	N ú	M á	, í	. ó	SPACE	ST

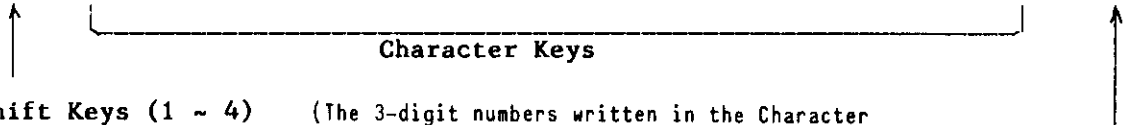

Shift Keys (1 ~ 4)
and Shift Lock Key

(The 3-digit numbers written in the Character keys in the above figure are not actually painted on the key tops of the keyboard. These indicate the Special Characters that can be accessed with the **SFT4** key.)

Function Keys

Shift Keys (1 ~ 4), Shift Lock Key

Used to designate the shift of the character keys. Each character key has four different characters, each of which is designated by the Shift Key 1 to Shift Key 4. Shift Key 4 is used to access the Special Characters programmed in the "SPECIAL CHARACTER GENERATION TABLE PROGRAMMING" operation. (Refer to the "CHARACTER CODE TABLE" on page 113.)

Shift Keys 2 through 4 are effective for one following character only. After that, the Shift 1 mode is automatically regained.

The shift Lock is used to hold the shifted status for a series of characters. To changed the shifted status locked by the Shift Lock Key, one of the Shift Keys (1 ~ 4) must be depressed prior to the next character key depression.

Character Keys

Used to enter alpha/numeric data indicated above each character key and the special character corresponding to the 3-digit code written in each key frame in the above figure. In setting a descriptor of Department or PLU name, a clerk name, etc., simply press the corresponding character key here instead of a character code and the **#** key combination on the ECR keyboard.

ex.) A ä

"A" is entered in the Shift-1 mode.

Operate: (**SFT1**) → A ä

"a" is entered in the Shift 2 mode.

Operate: **SFT2** → A ä

"ä" is entered in the Shift 3 mode.

Operate: **SFT3** → A ä

The Special Character assigned with Character Code 254 is entered in the Shift 4 mode.

Operate: **SFT4** → A ä

The numeric keys through may be used as character keys for descriptor setting, and also used for numeric data input such as in designating the Department No. or PLU No. along with the use of the key.

Each of the numeric key is effective only in Shift 1 or Shift 2 mode.

The key is effective to enter space in any of the four shift modes.

Function Keys

Except the key, each of the Function Keys corresponds to the identical key installed on the ECR keyboard as to the function in programming operations. (=)

The key is provided for the convenience of entering a Department No., PLU No., Line No. for STORE NAME/MESSAGE AND COMMERCIAL MESSAGE PROGRAMMING, Clerk ID Code in CLERK NAME PROGRAMMING, Item Code in FIANANCIAL TOTAL NAME PROGRAMMING and PRINT ITEM NAME PROGRAMMING operations.

ex.) Operation on ECR Keyboard Operation on TKB-1-A

<input type="text" value="DEPT 1"/>		1 <input type="text" value="CODE"/>
25 <input type="text" value="PLU"/> (as PLU No.)		25 <input type="text" value="CODE"/>
1 <input type="text" value="ST"/> (as Clerk ID)		1 <input type="text" value="CODE"/>

|
(If the key on the TKB-1-A keyboard is used in this case, it will result in an error.)

OPERATION EXAMLE

To set the Department Name "COFFEE" for Dept.1:

ON ECR KEYBOARD ONLY:

3 13 25 16 16 15 15
(C) (O) (F) (F) (E) (E)

ON TKB-1-A KEYBOARD ONLY:

3 1 C O F F E E

ON ECR KEYBOARD AND ON TKB-1-A KEYBOARD COMBINED:

3 C O F F E E

on ECR ON TKB-1-A on ECR

VERIFICATION OF PROGRAMMED DATA

DEPARTMENT PRESET PRICE READ

(Mode Lock: X, enter 1, depress **[ST]**.)

TEC STORE
1343 PEACH DRIVE
PHONE: 877-6437

Thank you
Call again

09-16-83 #123456

01 VEETABL	X
02 FRUIT	
03 MEAT	
04 FISH	
05 DAIRY	
06 BAKERY	
07 CANNED	
08 BOTTLED	
09 DRINK	
10 SNACK	
11 SPICE	
12 DP12	\$1.20
13 DP13	\$1.30
14 DP14	\$1.40
15 DP15	\$1.50
16 DP16	\$1.60
17 DP17	
18 DP18	
19 DP19	
20 DP20	
21 DP21	
22 DP22	
23 DP23	
24 DP24	
25 DP25	
26 DP26	
27 DP27	
28 DP28	
29 DP29	
30 DP30	
31 DP31	
32 DP32	

0048 14:17TM

Dept. Code
Dept. Name
(If no name has been programmed, the Dept. code such as "DP01" will be printed.)

Preset Price
(If no price is printed, it is an open department.)

DEPARTMENT STATUS AND LISTING CAPACITY READ

(Mode Lock: X, enter 2, depress **[ST]**.)

TEC STORE
1343 PEACH DRIVE
PHONE: 877-6437

Thank you
Call again

09-16-83 #123456

01 VEETABL	1 9491	X
02 FRUIT	1 9412	
03 MEAT	1 0000	
04 FISH	1 0000	
05 DAIRY	5 0000	
06 BAKERY	1 0000	
07 CANNED	5 0000	
08 BOTTLED	5 0000	
09 DRINK	5 0000	
10 SNACK	5 0000	
11 SPICE	5 0000	
12 DP12	1 0000	
13 DP13	1 0000	
14 DP14	1 0000	
15 DP15	1 0000	
16 DP16	1 0000	
17 DP17	0 0000	
18 DP18	0 0000	
19 DP19	0 0000	
20 DP20	0 0000	
21 DP21	0 0000	
22 DP22	0 0000	
23 DP23	0 0000	
24 DP24	0 0000	
25 DP25	0 0000	
26 DP26	0 0000	
27 DP27	0 0000	
28 DP28	0 0000	
29 DP29	0 0000	
30 DP30	0 0000	
31 DP31	0 0000	
32 DP32	0 0000-	

0049 14:17TM

HALC 94, LALC 91
(If 00, no LC has been set.)

Status Code:
0: Non-tax, Non-SI
1: Tax1 only
2: Tax2 only
3: Tax1 & Tax2
4: SI only
5: Tax1 & SI
6: Tax2 & SI
7: Tax1 & Tax2 & SI

PLU PROGRAMMED DATA READ

(Mode Lock: X, enter 3, depress **[ST]**.)

OTHER PROGRAMMED DATA READ

(Mode Lock: X, enter 4, depress **[ST]**.)

TEC STORE
 1343 PEACH DRIVE
 PHONE: 877-6437

Thank you
 Call again

09-16-83 #123456

PLU101	01 01	\$1.00	/ 6
	Tomato		
PLU102	01 01	\$1.40	
	Potato		
PLU201	02 01	\$1.50	/ 5
	APPLE		
PLU202	02 01	\$1.40	/ 6
	Orange		
PLU301	03 01		
	Beef		
PLU302	03 01		
	Pork		
PLU501	05 05	\$2.00	
	Butter%		
PLU502	05 05	\$2.20	
	Cheese%		
PLU601	06 01	\$1.30	
	WhiBread		
PLU602	06 01	\$1.10	
	RyeBread		
PLU603	06 01	\$0.50	
	HardRoll		
PLU604	06 01	\$0.40	
	SoftRoll		
PLU901	09 05	\$0.25	
	7-up		
PLU902	09 05	\$0.25	
	Coke		

0050 14:20TM

PLU Code
 Linked Dept.No.
 Status Code
 0:Non-tax, Non-SI
 1:Tax1
 2:Tax2
 3:Tax1 & Tax2
 4:SI, Non-tax
 5:Tax1 & SI
 6:Tax2 & SI
 7:Tax1 & Tax2 & SI
 Preset Price
 Whole Package Q'ty
 (if any programmed)
 PLU Name
 (If no name programmed, the PLU Code such as "PLU101" will be printed.)

TEC STORE
 1343 PEACH DRIVE
 PHONE: 877-6437

Thank you
 Call again

09-16-83 #123456

X

Z+	10%
Z-	20%
	9700
CATEND	00
CHECK	45
Chg	00
MISC	00
CARD	00
BTR	\$0.50
V.CPN	\$30.00
DISC	\$5.00
SITL	10%

0052 14:22TM

[%+] Preset Rate
[-%] Preset Rate
 Common LC
 Cash Tender LC
 Check Tender LC
 Charge Tender LC
 Misc.Tender LC
 Card Tender LC
 Bottle Return Limit
 Vendor Coupon Limit
 Dollar Disc. Limit
 SI/TL Preset %

SYSTEM OPTION READ

User System Option Read (Mode Lock: X,
enter 5,
depress **ST**.)

TEC STORE
1343 PEACH DRIVE
PHONE: 877-6437

Thank you
Call again

09-16-83 #123456

↓ **X**

#01	6
#02	0
#03	0
#04	0
#05	0
#06	0
#07	0
#08	6
#09	6
#10	0
#11	1

0053 14:23TH

Address No.

Bit Nos with
"SET" status

TAX TABLE READ (Mode Lock: X)

depress **TX/M** ... in a single-tax area

depress **TX1/M** for TAX 1 Table

TX2/M for TAX 2 Table

... in a dual-tax area)

```
TEC STORE
1343 PEACH DRIVE
PHONE: 877-6437

Thank you
      Call again

09-16-83  #123456

  X TAX1
00          $0.00
*
          10%
JONES 0056 17:08TM
```

Tax Table 1 or 2 ("A" Breaks will be printed if any)

% Rate ("B" Breaks will be printed if programmed instead of the % rate.)

(Non-taxable Amount Limit will be printed if programmed)

TESTING TAX CALCULATION (Mode Lock: X)

AMOUNT TO TEST → **TXBL TL** ... A receipt is issued on the **TXBL TL** key depression, printing the entered amount and the taxes due. (The data entered in the operation will not affect any sale totals.)

Amount entered Tax due (Tax1 and Tax2 consolidated)

displayed

REMOTE SLIP PRINTER OPERATION (OPTIONAL)

The TEC Remote Slip printer DRS-105 may be connected to the MA-1100-200 series ECR as an optional device. The Remote Slip Printer will operate printing if a slip is properly inserted, regardless of the Mode Lock position of the ECR.

1. The remote slip printer will automatically activate printing when the slip is properly set to the printer table.
2. No selection is provided for remote slip printer compulsory status.
3. The following are the optional selections available if the remote slip printer is connected:

1) PRINTING POSITION

Address #10 Bit 1:

RESET (standard): Prints every item on the right side of the slip.

SET (option): Prints items of Departments, PLUs, %+, %-, and Discount on the left side of the slip. Other items will be printed on the right side.

2) PRINT ITEM SELECTION

Address #10 Bit 2:

RESET (standard): Prints every item as printed on the receipt as long as the slip is set. (If only a certain item is printed and other items must be skipped, insert the slip just before the required item and withdraw the slip before operating other items.)

SET (option): Prints the new balance item of every charge posting operation. No other items (disregarding whether a charge posting operation or other registrations without previous balance) will be printed on the remote slip even if a slip is inserted.

3) TOTAL PRINT SINGLE OR DOUBLE SLIP

Address #10 Bit 3:

RESET (standard): Prints the sale total line only once just as on the receipt. (Single Slip)

SET (option): Prints every sale total line twice with unprinted lines fed inbetween. (Double Slip)

4) TOTAL PRINT DOUBLE SLIP WITH OR WITHOUT TRAILER LINE

Address #10 Bit 4: (This Bit is effective only when Bit 3 is selected to the "SET" status.)

RESET (standard):

The second total line is printed WITHOUT THE TRAILER LINE, in the Double Slip form.

SET (option): The second total line is printed WITH THE TRAILER LINE as well as the first total line, in the Double Slip form.

* "TRAILER LINE" means the print line routine of Date, Register No., Clerk ID, Receipt Consecutive No., and Time.

4. The gap of the slip inlet is usually opened, and the slip may be inserted or withdrawn freely.

When a slip is properly set to the remote slip printer and the ECR is operated, the gap will be closed and printing will be performed. When the sale is finalized, the receipt is issued and then the gap of the DRS-105 will be opened to allow the slip withdrawal. (The gap keeps closed during registration.)

5. Printing on the remote slip will be performed alternately with printing on the receipt/journal of the ECR.
6. The EJECT Key on the DRS-105 may be used to open the closed gap in order to withdraw the slip and skip unnecessary item print. The EJECT key will be disregarded if the slip is set and the ECR receipt/journal printer is in a printing action.

7. Printing Position and Slip Size

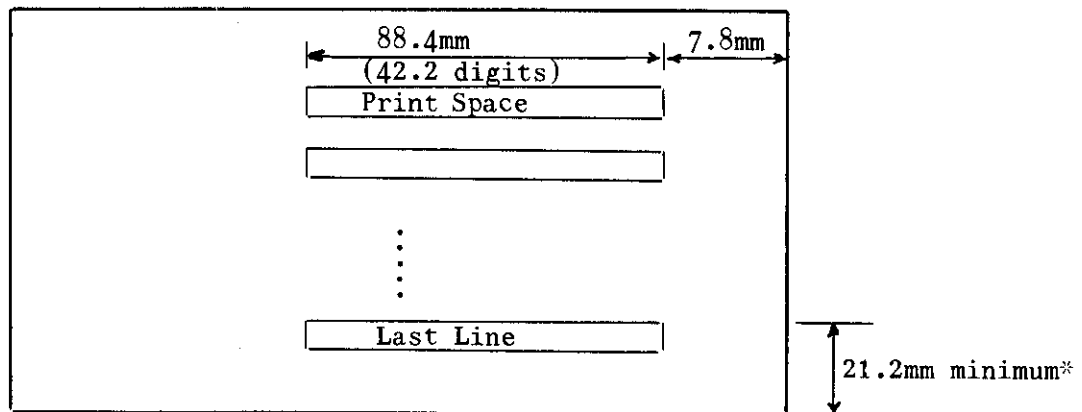

*NOTE: The space below the "Last Line" (i.e. the 21.2mm area at the bottom) cannot be printed.

REMOTE SLIP

RECEIPT

TEC STORE
 1343 PEACH DRIVE
 PHONE: 877-6437

Thank you
 Call again

09-16-83 #123456

VEGETABL	\$1.00 T
FRUIT	\$2.00 T
DISC	\$0.50-
RTN	
DAIRY	\$1.00-TS
TAX	\$0.20
TOTAL	\$1.70
CHECK	\$2.00
CHANGE	\$0.30

ITEM 1
 JONES 0019 16:37TM

Optional Print Position
 (Department, PLU, %+, %-,
 and Amount Discount items
 are printed on the left
 side. Other items are
 printed on the right side.)

Standard Print Position
 (All items are printed
 on the right side.)

System option
 Address #10
 Bit No.1 to "SET"

	VEGETABL	\$1.00 T
	FRUIT	\$2.00 T
	DISC	\$0.50-
	RTN	
	DAIRY	\$1.00-TS
	TAX	\$0.20
	TOTAL	\$1.70
	CHECK	\$2.00
	CHANGE	\$0.30

ITEM 1
 JONES 0019 16:37TM

09-16-83 #123456

CUTTER BLOCK OPEN DETECTOR AND PAPER NEAR-END DETECTOR

1. CUTTER BLOCK OPEN DETECTOR

- (1) This detects when the Cutter Block of the Printer is opened. It is provided in order to protect your hands and fingers from injury and also to protect the printer itself.
- (2) While the Block is opened, none of the keys (including **RF** and **JF**) will be accepted and the AMOUNT portion of the display will keep flashing.
- (3) When the Block is closed and the **C** key is depressed, the display flashing will be cleared and key-in operations will be accepted. If the Block was opened during printing, the suspended printing will be started again.
- (4) If the Block is opened during printing, the printing will immediately be stopped.

2. JOURNAL AND RECEIPT PAPER NEAR-END DETECTOR

- (1) This detects when either the journal or receipt paper is coming near the end. It is provided in order to prompt the operator to replace the old paper roll with a new one.
- (2) When the paper roll comes near the end (or the paper has not been set properly), no key operation (except **RF** and **JF**) will be accepted and the AMOUNT portion of the display will keep flashing.
- (3) When a new paper roll is set, only the **RF** and **JF** keys are allowed to operate. Next, when the **C** key is depressed, the display flashing will be cleared and normal key-in operations will be accepted. If any printing was suspended, it will continue printing.
- (4) If this detector sensed a paper near-end condition during printing, printer will stop after the current line printing is completed.
- (5) The **RF** and **JF** keys are operative regardless of the detector ON/OFF condition.
- (6) If the **C** key is depressed in the the paper-end condition, it will be ignored. The **C** key depression will be effective to clear the display flashing only after the new paper roll is set.

ECR PRINTER MOTOR LOCK AND REMOTE SLIP PRINTER MOTOR LOCK DETECTORS

1. PRINTER MOTOR LOCK DETECTOR

- (1) This detects the ECR printer motor lock condition caused by some trouble.
- (2) When such a condition is detected, the front display indicates "Error" and none of the keys (including **RF** and **JF**) will be accepted.
- (3) To regain the normal condition, turn the power of the ECR to OFF, remove the cause of the motor lock, and then turn the power to ON again.

2. REMOTE SLIP PRINTER MOTOR LOCK DETECTOR

- (1) This detects the remote slip printer motor lock condition caused by some trouble.
 - (2) When such a condition is detected, the front display indicates "Error" and none of the keys (including **RF** and **JF**) will be accepted.
 - (3) To regain the normal condition, turn the powers of the ECR and the remote slip printer to OFF, remove the cause of the motor lock, and then turn the powers to ON again.
- * If the cause can not be found in the remote slip printer and only the ECR may be required to work without the remote slip printer temporarily, remove the remote slip printer cable from the ECR, and turn the power of the ECR to ON.

PAPER ROLL REPLACEMENT AND OTHER MAINTENANCE OPERATIONS

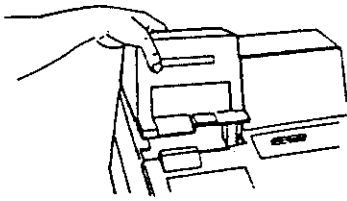

Fig. 1

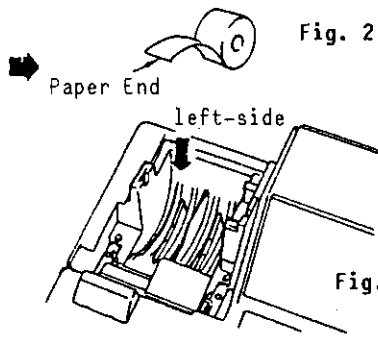

Fig. 2

Fig. 3

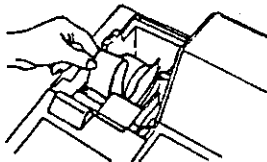

Fig. 4

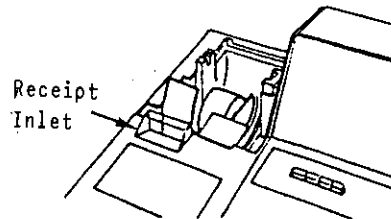

Fig. 5

INSTALLING THE RECEIPT PAPER

1. Turn the Mode Lock to the "REG" position.
2. Remove the Receipt Cover by pulling it upward (Fig. 1).
3. Set the new paper roll in the receipt roll holder with the paper end fed from the bottom as shown in Fig. 2 (Fig. 3).
4. Insert the paper end into receipt inlet as holding the **RF** key pushed down (Fig. 4).
5. When the paper comes out of the receipt outlet for approx. 5cm (or 2 inches), release the **RF** key (Fig. 5).
6. Attach the Receipt Cover. Meanwhile, the paper end must be seen outside the cover.
7. Press the **C** key to clear the paper-end condition, and depress the **NS** key and cut the issued receipt to check if the paper has properly set.

REMOVING THE RECEIPT PAPER

1. Remove the Receipt Cover by pulling it upward (Fig. 1).
2. Pull the Free Lever frontward while pulling the old paper core upward to remove the remaining receipt paper tail (Fig. 6).

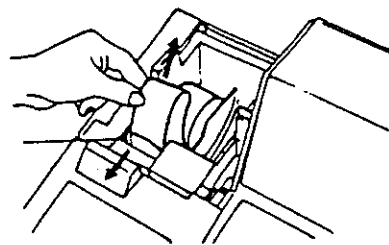

Fig. 6

INSTALLING THE JOURNAL PAPER

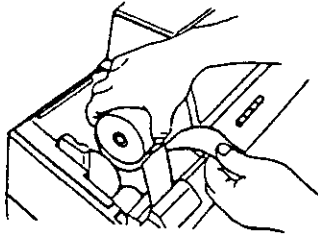

Fig. 7

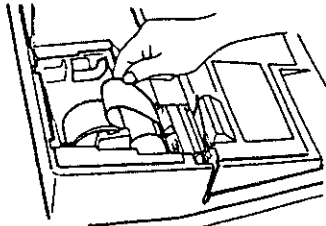

Fig. 8

1. Turn the Mode Lock to the "REG" position.
2. Remove the Receipt Cover by pulling it upward (Fig. 1 on the previous page).
3. Remove the Journal Winding Reel.
4. Set the new paper roll in the journal roll holder (righthand side) with the paper end from the bottom (Fig. 7).
5. Insert the paper end into the journal inlet while holding the **JF** key pushed down (Fig. 8).
6. When the paper comes out of the journal outlet for approx 20cm (or 8 inches), release the **JF** key (Fig. 9).
7. Wind up the paper end on the Journal Winding Reel two or three times as shown in Fig. 10.
8. Set the Journal Winding Reel to the holder (Fig. 11).
9. Attach the Receipt Cover (Fig. 12).
10. Depress **C** key before starting operations.

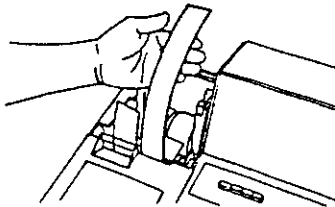

Fig. 9

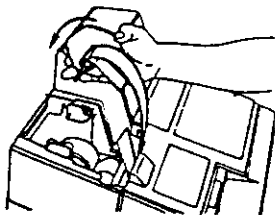

Fig. 10

REMOVING THE JOURNAL PAPER

1. Remove the Receipt Cover by pulling it upward (Fig. 1 on the previous page).
2. Depress **JF** key to wind up enough portion of the journal paper, and then tear off the paper, holding the Journal Winding Shaft.
3. The wound-up portion of the paper can easily be removed from the Winding Shaft by pulling it side way (Fig. 13).
4. If enough paper remains on the roll, follow Steps 6 through 10; if paper is running out, follow Steps 1 through 10 in "INSTALLING THE JOURNAL PAPER" above.

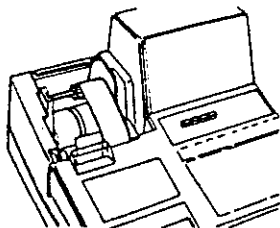

Fig. 11

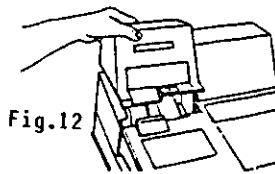

Fig.12



Fig. 13

REPLACING THE INK RIBBON

When the receipt and journal print is too light, replace the ink ribbon in the following manner.

Removing the Ribbon

1. Turn the Power Switch to OFF.
2. Remove the Ribbon Cover. Press the side inward and the hook will unlocked (Fig.14).
3. Open the Cutter Block by pulling it upward while pressing the leftside lever outward. (Fig. 15 and Fig. 16)
4. Remove the Ink Ribbon by lifting up the ribbon spools (Fig. 17).

Installing the Ribbon

1. Set the ribbon spools so that the ribbon will be wound to the directions shown by the arrows respectively. Meanwhile, let the ribbon go through the Ribbon Guides, the Tension, and the Dot Head Ribbon Guide (Fig.18 and Fig.19).
2. After setting, make sure that the ribbon properly goes through each required parts by turning a ribbon spool several turns.
3. Close the Cutter Block. Make sure that the leftside lever has locked the block.
4. Turn the Power Switch to ON.
5. Depress **[C]** key. The flashing display will stop and be lit steadily.
6. Attach the Ribbon Cover.

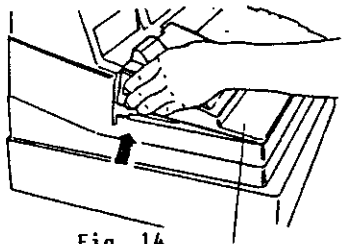

Fig. 14
Ribbon Cover

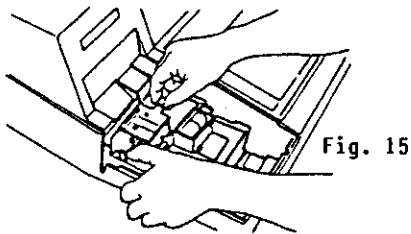

Fig. 15

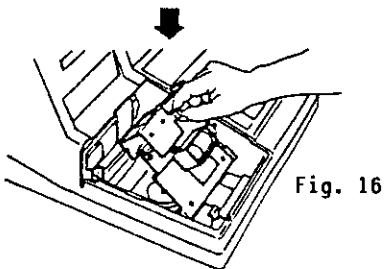

Fig. 16

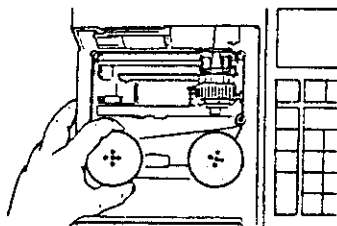

Fig. 17

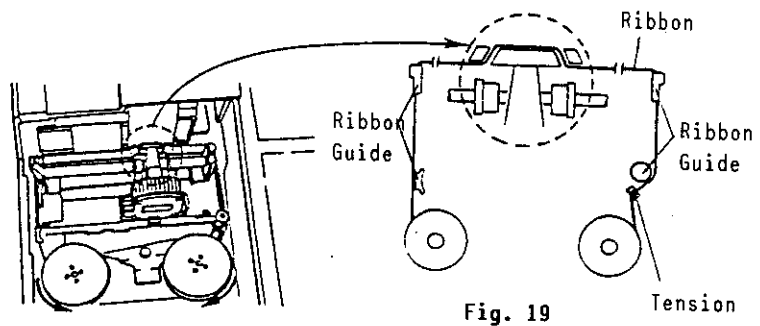

Fig. 19

Fig. 18

REPLENISHING THE STORE NAME STAMP WITH INK

When the store name stamp is printed too lightly, replenish the ink in the following manner.

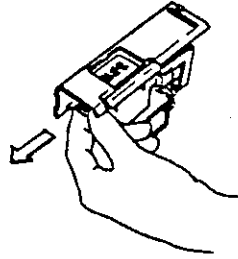

Fig. 20

Ink Bottle

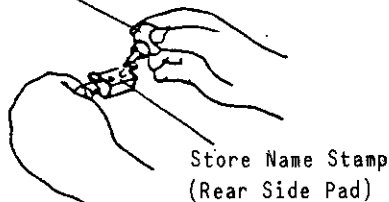

Fig. 21

1. Turn the Power Switch to OFF.
 2. Remove the Ribbon Cover (Fig. 14).
 3. Open the Cutter Block (Fig.15 and Fig.16).
 4. Draw out the store name stamp in the direction shown in Fig.20 with the protruding part pinched with your fingers (Fig. 20).
 5. Apply ink on the pad on the rear side of the Store Name Stamp. The amount of the refiling should be adjusted according to the density of the printed message, but the limit of 2 c.c. should not be exceeded. (The ink bottle supplied contains 5 c.c. of ink.) (Fig. 21)
- NOTES:** 1) Replenish the ink drop by drop several times until the pad will not absorb any more.
2) Use the TEC genuine ink for replenishment.
6. Re-assembly is the reverse procedure. (Fig. 22) Let Point "B" of the Stamp fit to Point "A" of the Stamp Holder, push the stamp all the way in until a "click" is heard.
 7. Close the Cutter Block.
 8. Turn the Power Switch to ON.
 9. Depress the **[C]** key. The flashing display will stop and be lit steadily.
 10. Depress the **[NS]** key to issue a receipt. Repeat this to check if the printout will turn out all right.
 11. Attach the Ribbon Cover.

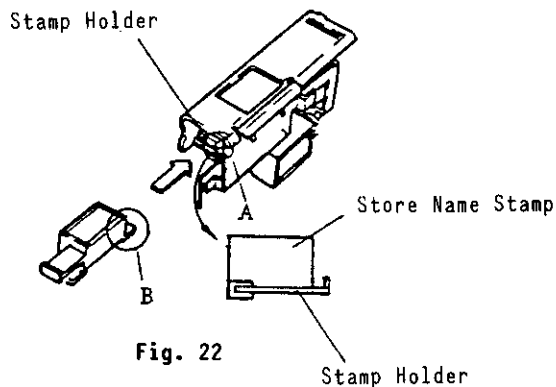

Fig. 22

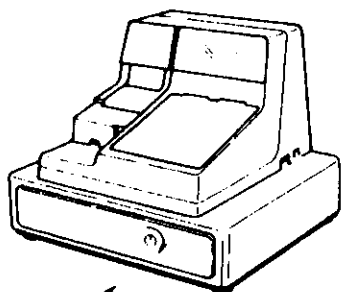

Fig. 23



Drawer Release Key

OPENING THE DRAWER

The drawer opens automatically when a registration is finalized. In the event of a power failure or a trouble, however, open the drawer in the following manner.

Insert the Drawer Release Key into the Drawer Release Lock and turn the key by 45 degrees clockwise. (Fig. 23)

REMOVING THE DRAWER

1. Lift the drawer up and pull it out.
2. Then let it go down and pull it out again, and it will be removed.
3. When getting back the drawer, fit its rollers on the rails of the register and push it all the way in. (Fig.24)

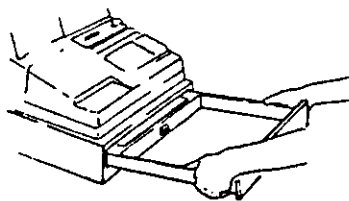

Fig. 24

WHEN A POWER FAILURE OCCURS ...

If a power failure occurs, all sales data stored in the memories are automatically protected by the battery installed in the ECR. The battery is rechargeable and it is recharged when the AC power returns. As the power returns, the register revives to continue the work. However, please note the following phenomena to occur on the register when the power is regained:

1. The printer will work to print the entered data without failure after the power recovery, if any data was being printed. However, one extra line may be fed on the power recovery depending on the power failure timing.
2. When the power is restored, the register will display the last item entered before the power failure if the item was entered through a motorized key (such as **DEPT**, media keys, etc.). In this case,, continue the registering operation. However, if the register displays "FAIL" when the power is restored, it indicates that the last item entry was not completed (i.e., only numeric keys or a declaration key such as **RTN MDSE** were operated but not any motorized key). In this case, first depress the **C** key to clear the "FAIL" condition, and then do the registering operation again from the numeric or declaration key entry. In the event of a power failure and its recovery, be sure to check the receipt before it is handed to the customer.

SPECIFICATIONS

Size 460mm(width) x 445mm(depth) x 405mm(height)
(including the rubber feet)

Weight 22kg without Remote Display
22.5kg with Remote Display

Power Required AC 117V 60Hz

Power Consumed 35W + 20% when operating
11W ± 20% when not operating

Ambient Temperature 0°C ~ 40°C, 10% ~ 90% Relative Humidity

Size of Receipt and Journal Tape
..... 45mm(width) x 100mm(diameter)

Free Manuals Download Website

<http://myh66.com>

<http://usermanuals.us>

<http://www.somanuals.com>

<http://www.4manuals.cc>

<http://www.manual-lib.com>

<http://www.404manual.com>

<http://www.luxmanual.com>

<http://aubethermostatmanual.com>

Golf course search by state

<http://golfingnear.com>

Email search by domain

<http://emailbydomain.com>

Auto manuals search

<http://auto.somanuals.com>

TV manuals search

<http://tv.somanuals.com>