

TEC

TEC Electronic Cash Register

MA-1400-100

Owner's Manual



TOKYO ELECTRIC CO., LTD.

WARNING

This equipment generates, uses, and can radiate radio frequency energy and if not installed and used in accordance with the instruction manual, may cause interference to radio communications. It has been tested and found to comply with the limits for a Class A computing device pursuant to Subpart J of Part 15 of FCC Rules, which are designed to provide reasonable protection against such interference when operated in a commercial environment. Operation of this equipment in a residential area is likely to cause interference in which case the user at his own expense will be required to take whatever measures may be required to correct the interference.

WARNING

"THIS DIGITAL APPARATUS DOES NOT EXCEED THE CLASS A LIMITS FOR RADIO NOISE EMISSIONS FROM DIGITAL APPARATUS SET OUT IN THE RADIO INTERFERENCE REGULATIONS OF THE CANADIAN DEPARTMENT OF COMMUNICATIONS."

"LE PRÉSENT APPAREIL NUMÉRIQUE N'EMET PAS DE BRUITS RADIOÉLECTRIQUES DÉPASSANT LES LIMITES APPLICABLES AUX APPAREILS NUMÉRIQUES DE LA CLASSE A PRESCRITES DANS LE RÉGLEMENT SUR LE BROUILLAGE RADIOÉLECTRIQUE ÉDICTÉ PAR LE MINISTÈRE DES COMMUNICATIONS DU CANADA."

OPERATOR'S GUIDE

TABLE OF CONTENTS

	Page
1. TO OUR CUSTOMERS	1
2. PRECAUTIONS	1
3. APPEARANCE AND NOMENCLATURE	2
4. CONTROL LOCKS AND MODE SELECTOR KEYS	3
5. DISPLAY	5
6. KEYBOARD LAYOUT	7
7. FUNCTION OF EACH KEY	8
8. REGISTERING OPERATIONS	12
9. POWER FAILURE PROCESS	36
10. JOURNAL AND RECEIPT PAPER-END DETECTOR	36
11. ECR PRINTER MOTOR LOCK DETECTOR	37
12. REMOTE SLIP PRINTER MOTOR LOCK DETECTOR	37
13. PAPER ROLL REPLACEMENT AND OTHER MAINTENANCE OPERATIONS	38
14. SPECIFICATIONS	42

1. TO OUR CUSTOMERS

Thank you for choosing the TEC electronic cash register MA-1400-100 series. This instruction manual provides a description of the functions and handling of this register and should be read carefully to ensure optimum performance. Since every consideration has been given to safety and reliability, there is no danger of damaging the machine by incorrect operation.

Please refer to this manual whenever you have any questions concerning the machine. This machine has been manufactured under strict quality control and should give you full satisfaction. However, if the machine is damaged during transit, or there are any unclear points in this manual, please contact your local TEC representative.

- The specifications described in this manual may be modified by TEC, if necessary.
- Be sure to keep this manual for future reference.

2. PRECAUTIONS

The ECR is a precision machine. Please handle it carefully considering the following guidelines.

REMARKS ON THE LOCATION

- Place it where no unusual temperature changes are expected.
- Place it on a flat and level surface with little dust, humidity, vibration, etc.
- Keep it away from water sources.
- Do not use it in direct sunlight for a long time.
- Ensure proper ventilation so that the machine is not exposed to excessive heat.
- Be certain to connect a grounding wire to prevent the generation of static electricity and noise troubles. Never share the same power outlet with many other electric appliances.

REMARKS ON OPERATING THE ECR

- The keys on the keyboard function with a light touch. Avoid pressing the keys too hard.
- Do not handle the machine with wet hands, since this may cause electrical malfunctions and corrosion of parts.
- Do not apply thinner, benzine, or other volatile materials to the cabinet or other plastic parts. Such liquids will cause discoloration or deterioration of the cover. If dirty, wipe off with a piece of cloth soaked in a neutral detergent and wrung out thoroughly.
- Turn off the power switch when the operations are over for the day.
- Ask your TEC representative to provide periodical maintenance to ensure the optimum performance of the machine.
- As for other operations, follow the instructions in this manual.

3. APPEARANCE AND NOMENCLATURE

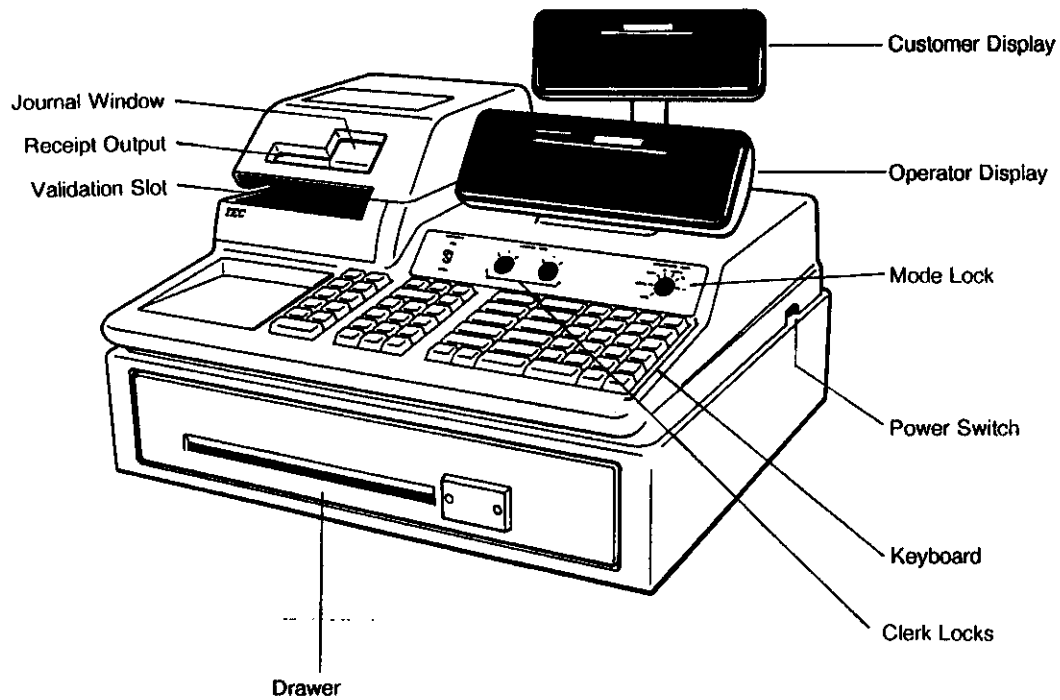

- Power Switch** The power switch is provided at the right-hand side of the cabinet. The AC power is turned on when the switch is pushed to ON, and turned off when the switch is pushed to OFF.

4. CONTROL LOCKS AND MODE SELECTOR KEYS

4.1 MODE LOCK

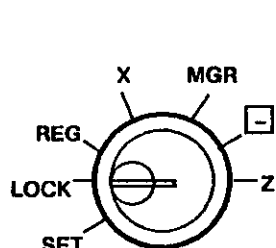

(POSITION)	(FUNCTION)
	SET ... In this position, the register will allow programming operations.
	LOCK .. The register operations are locked when the Mode Lock is in this position. Meanwhile, the current time is displayed.
	REG ... Normal cash register operations are carried out in this mode. However, the operations requiring a Manager Intervention cannot be performed in this mode.
	X The sale totals in memory can be read and the programmed data can be verified in this position.
	MGR ... This position allows to register all normal cash register operations to be carried out in the "REG" mode and the operations requiring a Manager Intervention.
	☐ This is the "Negative Mode", which automatically processes all the entries in the reverse way, i.e. positive items into negative, and the negative into positive. It is usually used to return or cancel all the items once purchased in a sale in the "REG" or "MGR" mode.
	Z All the resetable totals and their respective counters in memory will be read <u>and</u> reset in this position.

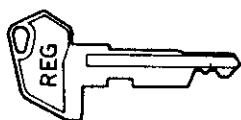

REG Key: The REG Key is used by the cashier or clerk who operates the register. This key can access the positions of **LOCK** and **REG**.

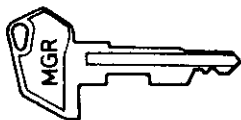

MGR Key: The MGR Key is used by the store manager or a person authorized by the manager. This key can access the positions of **LOCK**, **REG**, **X**, and **MGR**.

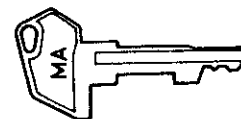

MA Key: The MA Key is used by the store manager who will daily supervise the collection of money and the printout of transactions recorded by the register. This key can access the positions of **LOCK**, **REG**, **X**, **MGR**, **☐**, and **Z**.

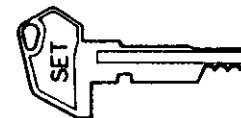

SET Key: The SET Key is used by the programmer. This key can access the positions of **LOCK** and **SET**.

The keys may be inserted or pulled out at the "LOCK" or "REG" position.

4.2 CLERK LOCKS

Key-lock Type (Standard)

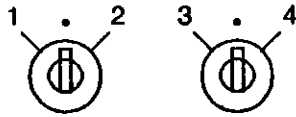

These locks are used to identify which clerk is operating the register.

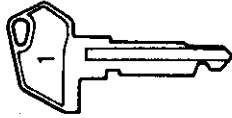

Clerk Keys (1, 2, 3, 4)

Each clerk should keep his/her clerk key. The register will not operate unless one of these keys is inserted and set to the correct position in the Clerk Locks. Each of the keys may be inserted and pulled out in the neutral position marked with the dot.

Push-key Type (Alternative Option)



This type may be installed in place of the standard key-lock type mentioned above, as an alternative option. Each clerk is assigned his/her own clerk key (1 to 4). The register will not operate unless one of these keys is pushed down.

4.3 RECEIPT ON/OFF SWITCH

RECEIPT



OFF

This switch has two positions available -- 'OFF' position and 'ON' position. When in the 'OFF' position, no receipt is issued from the register and sales are printed on the journal roll only. When the switch is set to the 'ON' position, sales are printed on both receipt roll and journal roll, then a receipt is issued which is automatically cut off and given to the customer.

5. DISPLAY

A tilt type is adopted for the operator display, which is adjustable in the up and down direction. The entered amounts and the obtained total are easy to see.

OPERATOR DISPLAY (Front Display)

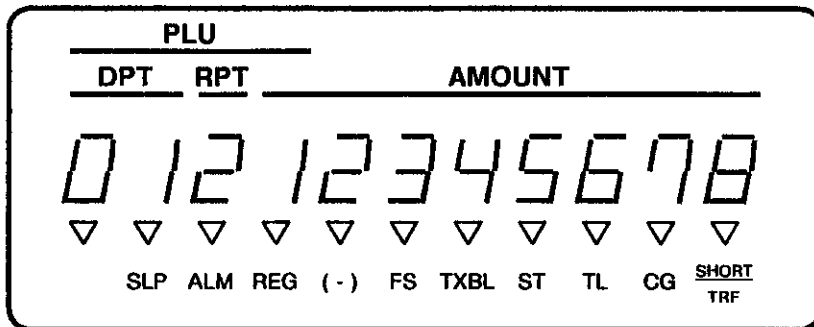

The customer display can be fixed as a rear display or moved to form a remote display. It can be moved up, down, to the right, and to the left, and thus is fully adjustable according to the position of the customer.

CUSTOMER DISPLAY (Rear or Remote Display)

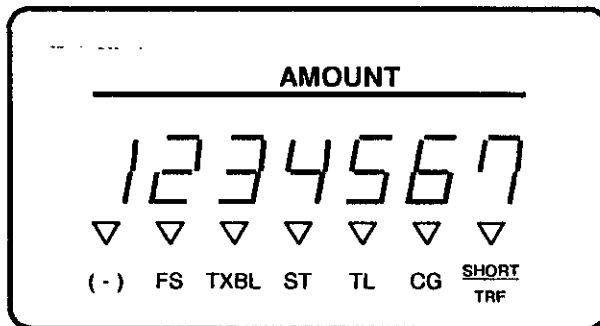

NUMERIC DISPLAY

- AMOUNT (8 digits) :** Displays the numeric data, such as amount, quantity, etc.
- DPT (2 digits) :** Displays the code which represents each Department key. It stays lit when repeating the same department entry.
- RPT (1 digit) :** Displays the repeat count of the same item. The count is indicated from the second entry on, and only the last digit will be displayed even if the count exceeds nine.
- PLU (4 digits; the DPT, RPT and AMOUNT digits are commonly used for this purpose.):**
Displays the PLU code when any PLU is entered. It goes out when repeating the same PLU entry.

MESSAGE DESCRIPTORS (TRIANGULAR INDICATORS)

- SLP :** Lights up when a slip has been properly inserted to allow validation. It flickers to require a validation when validation compulsory status has been programmed on the last operation.
- ALM :** Lights up with the alarm buzzer to indicate that the last operation or numeric entry was an error. To clear the error condition, depress the [C] key.
- REG :** Lights up when a sale item has been entered.
- (-) :** Lights up when a negative amount such as [RTN MDSE] or [-] key has been operated. It also lights up when the [ST] or one of the total keys has been depressed and the displayed amount is negative.
It lights up also when an amount is entered in the "☐" mode.
- FS :** Light up when a department or PLU item with a food stampable status is entered.
- TXBL :** Lights up when a taxable item has been entered.
- ST :** Lights up when the subtotal amount is displayed after the [ST] key has been depressed.
- TL :** Lights up on a finalizing operation with the total amount displayed when a sale is finalized without any amount tendered.
- CG :** When an amount tendering operation has been performed, this lamp lights up with the change due displayed.
- SHORT :** Lights up when the amount tendered is less than the sale total with the shortage amount displayed.
TRF Lights up also when all the sale balance are transferred to the new sale balance for post charging.

6. KEYBOARD LAYOUT

The following are typical keyboard layout for the MA-1400 series. Since this series is designed to be capable of programming most of the keys to be placed in the desired place on the keyboard, this is merely an example. The keyboard of your register should have its own layout according to the store's requirements.

--- Standard Keyboard Layout ---

NS	RTN MDSE	VALI DATE	RF	JF	1	6	11	16	R/A	ALL VOID
#	VOID	C		TX/M	2	7	12	17	PO	<input type="checkbox"/>
FS/M	ITEM CORR	7	8	9	3	8	13	18	VND CPN	%-
PR OPEN	@/FOR	4	5	6	4	9	14	19	STR CPN	EX
LC OPEN	AMT	1	2	3	5	10	15	20	FSTL TEND	CPN
PLU		0	00	•	ST	TXBL TL	AT/TL	CHECK TEND	Chg	MISC

Other keys not placed in the keyboard above :

Additional Department Keys (21 to 40)









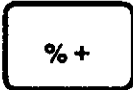
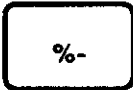

[#/NS]	[PB +], [PB-]
[TX2/M], [TX3/M]	[TRF]
[TAX]	[000]
[OPEN]	[% +]
[CUR1] to [CUR4]	[RECEIPT ISSUE]

7. FUNCTIONS OF EACH KEY

This section briefly describes functions of each key for your quick reference purposes. See the reference pages in Section 8 : REGISTERING PROCEDURE for detail operation sequences.

TABLE OF KEY FUNCTIONS

KEY	FUNCTIONS	REFERENCE PAGE												
<table border="1"> <tr><td>7</td><td>8</td><td>9</td></tr> <tr><td>4</td><td>5</td><td>6</td></tr> <tr><td>1</td><td>2</td><td>3</td></tr> <tr><td>0</td><td>00</td><td>.</td></tr> </table>	7	8	9	4	5	6	1	2	3	0	00	.	<p>Numeric keys . Used to enter numeric values. Depressing the [00] key once is the same as depressing the [0] key twice consecutively. Depressing the [000] key once is the same as depressing the [0] key three times consecutively. [.] key is used to designate the decimal point of a percentage rate or a quantity.</p>	—
7	8	9												
4	5	6												
1	2	3												
0	00	.												
<table border="1"> <tr><td>RF</td></tr> </table>	RF	<p>Receipt Feed Key. Used to advance the receipt roll and operated by holding it down until the paper has advanced to the required position.</p>	—											
RF														
<table border="1"> <tr><td>JF</td></tr> </table>	JF	<p>Journal Feed Key. Used to advance the journal roll in the same fashion as the [RF] key is used to receipt roll.</p>	—											
JF														
<table border="1"> <tr><td>RECEIPT ISSUE</td></tr> </table>	RECEIPT ISSUE	<p>Receipt Post-Issue key. Used to issue the receipt of a sale when the sale has already finalized with the [RECEIPT ON/OFF] Switch positioned to OFF.</p>	32											
RECEIPT ISSUE														
<table border="1"> <tr><td>1</td><td>to</td><td>40</td></tr> </table>	1	to	40	<p>Department keys. Used to enter each item, serving for classifying merchandise by department.</p>	14, 17, 35									
1	to	40												
<table border="1"> <tr><td>PLU</td></tr> </table>	PLU	<p>PLU (Price-Look-Up) key. Used to enter a PLU that is linked to a department.</p>	14, 17											
PLU														
<table border="1"> <tr><td>AMT</td></tr> </table>	AMT	<p>Amount key. Used to enter a manual amount of PLU item.</p>	14											
AMT														
<table border="1"> <tr><td>NS</td></tr> </table>	NS	<p>No-sale key. Used to open the cash drawer without relating to a sale.</p>	13											
NS														
<table border="1"> <tr><td>#</td><td>#/CID</td></tr> </table>	#	#/CID	<p>Non-add Number Print key. Used to print a non-add numbers for future references.</p>	22										
#	#/CID													
<table border="1"> <tr><td>#/NS</td></tr> </table>	#/NS	<p>Non-add Number Print/No-sale key. This is a dual-function key that has both [#] and [NS] functions.</p>	13, 22											
#/NS														

KEY	FUNCTIONS	REFERENCE PAGE
	Percent Charge key. Used to add a percent rate to a sale.	18
	Percent Discount key. Used to subtract a percent rate from a sale.	18
	Amount Discount key. Used to subtract an amount from the sale.	20
	At/For key. Used to multiply a department or a PLU item entry by a quantity. Also used to auto-calculate and enter a split package price.	15, 16
	Clear key. Used to clear numeric entries or a declaration key entry.	—
	Preset Open key. Used to release a preset-price department or PLU items for a manual price entry.	14, 15
	Listing Capacity Open key. Used to release the listing capacity preprogrammed on each department or PLU.	22
	Preset and Listing Capacity Open key. This is a dual-function key that has both [PR OPEN] and [LC OPEN] functions.	14, 15, 22
	Vendor Coupon key. Used to enter the amount of vendor coupons received from the customer.	19
	Store Coupon key. Used to subtract a store coupon amount redeemed through a department.	19
	Returned Merchandise key. Used to refund money to a customer who has returned items already purchased.	18
	Item Correct key. Used to delete the last item entered within the current transaction.	20

KEY	FUNCTIONS	REFERENCE PAGE
VOID	Void key. Used to delete an item entered previously (before the last item) in the current transaction.	21
ALL VOID	All Void key. Used to delete all items entered in the current transaction.	21
R/A	Received-on-Account key. Used to enter payments received on account, i.e. not relating to a sale.	30
PO	Paid-Out key. Used to record amounts paid out of the cash drawer not relating to a sale.	30
ST	Subtotal key. Used to obtain subtotal of the current transaction.	23
TXBL TL	Taxable Total key. Used to obtain taxable total (subtotal + taxes) of the current transaction.	23
AT/TL	Cash Amount Tendered/Cash Total key. Used to record all cash paid transactions, and will be able to finalize a sale operation.	26, 27
CHECK TEND	Check Tendered key. Used to cash a check or to finalize the transaction as a check payment.	26~28
Chg	Charge Total key. Used to finalize the transaction for charge sale.	26, 27
CPN	Media-Coupon key. Used to finalize the transaction for media coupons.	26, 27
MISC	Miscellaneous Media key. Used to finalize the transaction for other media.	26, 27
FSTL TEND	Food Stamp Total Read/Tender key. Used to display the food-stampable total (maximum amount the customer may pay). Also used to enter the food stamp amount tendered by the customer.	24

KEY	FUNCTIONS	REFERENCE PAGE
<div style="border: 1px solid black; padding: 5px; width: fit-content; margin: auto;">VALI DATE</div>	Validation key. Used to print a required item or finalizing a required sale on a validation slip.	31
<div style="display: flex; justify-content: space-around; align-items: center;"> <div style="border: 1px solid black; padding: 5px; margin: 2px;">PB +</div> <div style="border: 1px solid black; padding: 5px; margin: 2px;">PB-</div> </div>	Previous Balance keys. Used to enter a previous balance in a charge posting operation.	33, 34
<div style="border: 1px solid black; padding: 5px; width: fit-content; margin: auto;">TRF</div>	Transfer key. Used to transfer the entire balance in a charge posting operation with no payment.	33
<div style="display: flex; flex-wrap: wrap; justify-content: center; gap: 10px;"> <div style="border: 1px solid black; padding: 5px; margin: 2px;">TX/M</div> <div style="border: 1px solid black; padding: 5px; margin: 2px;">TX1/M</div> <div style="border: 1px solid black; padding: 5px; margin: 2px;">TX2/M</div> <div style="border: 1px solid black; padding: 5px; margin: 2px;">TX3/M</div> </div>	Tax Modifier key(s). Used to reverse the taxable/non-taxable status on departments, PLUs, or other tax-status programmable keys.	22
<div style="border: 1px solid black; padding: 5px; width: fit-content; margin: auto;">FS/M</div>	Food Stamp Modifier key. Used to reverse the food stampable/non-stampable status of a department, PLU, or other food stamp status programmable keys.	22
<div style="border: 1px solid black; padding: 5px; width: fit-content; margin: auto;">EX</div>	Tax Exempt key. Used to declare the exemption of the taxes from the sale.	25
<div style="display: flex; align-items: center; justify-content: center; gap: 10px;"> <div style="border: 1px solid black; padding: 5px; margin: 2px;">CUR 1</div> to <div style="border: 1px solid black; padding: 5px; margin: 2px;">CUR 4</div> </div>	Foreign Currency keys. Used in tendering or exchange with foreign currencies.	28, 29
<div style="border: 1px solid black; padding: 5px; width: fit-content; margin: auto;">TAX</div>	Manual Tax key. Used to enter an irregular tax amount that cannot be calculated on the basis of the programmed tax table, and to add it to the sale total.	23

8. REGISTERING OPERATIONS

The following pages are registering operation patterns and actual operation samples. In the patterns, " | _____ | " indicates an input through the numeric keys, "[]" indicates a depression of the transaction key. In referring to the sample operations, please note that the programmed data on some keys or items (such as Department keys) may be different from those programmed for your store.

CONDITION SETTING TO START REGISTERING

Mode Lock : Insert the "REG" key and set it to the "REG" position.

Clerk Lock : You must set your clerk key to the ON status.

TABLE OF CONTENTS

<u>OPERATION</u>	<u>PAGE</u>
No-sale	13
Department Entry	14
PLU Entry	14
Repeat Entry	15
Quantity Extension (Multiplication)	15
Split Package Pricing	16
Single-Item Department or Single-Item PLU	17
Returned Merchandise	18
Percent Discount, Percent Charge	18
Vendor Coupon	19
Store Coupon	19
Amount Discount	20
Item Correct	20
Void	21
All Void (Cancel)	21
Non-add Number Print	22
Listing Capacity Open	22
Tax Status Modification, Food Stamp Status Modification	22
Manual Tax Entry	23
Subtotal	23
Taxable Total Read	23
Food Stampable Total Read, Food Stamp Tendering	24
Tax Exempt	25
Sale Finalization by Media keys	26
Multi-tendering	27
Split-tendering	27
Check Cashing	28
Sale Paid in Foreign Currencies	28
No-sale Exchange from a Foreign Currency to the Domestic Currency	29
Received-on-Account	30
Paid-Out	30
Validation Print	31
Receipt Post-Issue	32
Previous Balance, Charge Posting	33
Other Income Entry	35
Remote Slip Printer Operation	35

No-sale

The no-sale transaction is used to open the cash drawer without relating to any sales, such as for giving change, testing the receipt/journal print condition, etc.

OPERATION

(must be operated outside a sale)

[NS] The drawer opens and a No-sale receipt is issued.

(or **[#/NS]**)

-- Receipt Print Sample --

```
TEC STORE
1343 PEACH DRIVE
PHONE: 87-6437

Thank you
          Call again

11-20-89  #3001

*NO SALE *

JONES 0059 13:46TM
```

Department Entry

Each department key is preprogrammed as the "PRESET" type (with a price programmed on the key) or "OPEN" type (with no price programmed on the key). Perform operation depending on the type selected.

OPERATION

Open Department Type

- | Price | [Open DEPT]

Preset Department Type

- [Preset DEPT]
- [PR OPEN] | Price | [Preset DEPT]
(or [OPEN])

-- Receipt Print Sample --

BOOK	\$7.50
CAKE	\$2.50 T

PLU Entry

Each PLU key is preprogrammed as the "PRESET" type (with a price programmed on the key) or "OPEN" type (with no price programmed on the key). Perform operation depending on the type selected.

OPERATION

Open PLU Type

- | PLU Code | [PLU] | Price | [AMT]
- | Price | [PLU Preset-code Key]

Preset PLU Type

- | PLU Code | [PLU]
- [PLU Preset-code Key]
- [PR OPEN] | PLU Code | [PLU] | Price | [AMT]
(or [OPEN])
- [PR OPEN] | Price | [PLU Preset-code Key]
(or [OPEN])

-- Receipt Print Sample --

1X	1.50/	3
TOMATO	\$0.50	T
1X	2.00/	7
ORANGE	\$0.29	T

- * [PLU Preset-code Key] may be provided on the ECR keyboard or on the PK-2 (hardware option ; PLU keyboard)

Repeat Entry

To repeat the same item as the last entry, simply depress the last key of the department and PLU entry sequence.

NOTE : If the first item of those repeated is modified with [LC OPEN], [TXIM] or [FSIM], the modified status will be effective through the last item of the repeated.

-- Receipt Print Sample --

MILK	\$1.50	T
MILK	\$1.50	T

Quantity Extension (Multiplication)

OPERATION

(1) Department

- | Quantity | [@/FOR] [Preset DEPT]
- | Quantity | [@/FOR] | Price | [Open DEPT]
- | Quantity | [@/FOR] [PR OPEN] | Price | [Preset DEPT]
(or [OPEN])

(2) PLU

- | Quantity | [@/FOR] [PLU Preset-code Key]
- | Quantity | [@/FOR] | PLU Code | [PLU]
- | PLU Code | [PLU] | Quantity | [@/FOR] | Price | [AMT]
- | Quantity | [@/FOR] [PR OPEN] | Price | [PLU Preset-code Key]
(or [OPEN])
- [PR OPEN] | PLU Code | [PLU] | Quantity | [@/FOR] | Price | [AMT]
(or [OPEN])

NOTE : Quantity Max. 3 integral + 3 decimal digits
 Price (Unit Price) Max. 6 digits
 Product Must not exceed 7 digits.

-- Receipt Print Sample --

4X	2.50	@
COFFEE	\$10.00	

Split Package Pricing

OPERATION

(1) Department

- Preset Dept

| Purchased Q'ty | [@/FOR] | Whole Package Q'ty | [@/FOR] → [Preset DEPT]

- Open Dept

| Purchased Q'ty | [@/FOR] | Whole Package Q'ty | [@/FOR] _____
 _____ → | Whole Package Price | [Open DEPT]

(2) PLU

- Preset PLU

| Purchased Q'ty | [@/FOR] → | Split-Price Type PLU Code | [PLU]

| Purchased Q'ty | [@/FOR] | Whole Package Q'ty | [@/FOR] _____
 _____ → [PLU Preset-code Key]

- Open PLU

| Purchased Q'ty | [@/FOR] _____
 _____ → | Split-Price Type PLU Code | [PLU] | Whole Package Price | [AMT]

- NOTES :**
1. *Purchased Q'ty* max. 3 digits integral only.
Whole Package Q'ty max. 3 digits integral only.
Whole Package Price max. 6 digits
 2. *Usually the fraction of the result is rounded up in split package pricing. However, it is programmable to rounded up the fraction of each item price.*
 3. *Only the Split-Price Type PLUs (i.e. with Whole Package Quantity programmed) allow split package pricing operations using PLUs.*

-- Receipt Print Sample --

2X	1.50/	3
TOMATO	\$1.00	T

BASIC KEY FUNCTIONS AND KEYBOARD VARIATIONS IN PROGRAMMING OPERATIONS

Basic Key Functions

1. The following are main keys and their functions to be used in programming operations:
 - [@/FOR] Used to enter the program Submode No.
 - [ST] Used to enter the Address No. or Item Code. Also used to end the item data entries.
 - [#] (or [#NS]) Used to enter data for the address or item. Each character code is also entered through this key.
 - [AT/TL] Used to end the entire program Submode sequence.
2. Functions of the [C] key:
 - When an entered program data is already printed, the [C] key cannot clear it any longer. To correct the data, re-enter it.
 - Before the entered data is printed, the data may be cleared by the [C] key.

Keyboard Variations in Programming operations

The MA-1400 provides several keyboards for programming operations. Depending on which keyboard is used, the key layout and the character entry method will vary.

Case 1:When the ECR Keyboard alone is used for programming:

Follow the instructions as they are described in this manual. For character settings, use the CHARACTER CODE TABLES (later stated). None of the DIRECT CHARACTER ENTRY methods are possible.

Case 2:When the Programming Keyboard TKB-1 (hardware option) is connected:

- 1) Character Keys provided on the TKB-1 keyboard may be used to directly enter the characters. (DIRECT CHARACTER ENTRY method). Any characters not provided on the TKB-1 keyboard (and those provided as well) may be entered through the Numeric Keys and the [#] key on the ECR keyboard, referring to the CHARACTER CODE TABLES.
- 2) Basic Function Keys ([C], [@/FOR] (= [X]), [ST], [AT/TL]) may be depressed either on the TKB-1 or the ECR keyboard. If any other keys not provided on the TKB-1 are required in programming operates, operate them on the ECR keyboard (such as Department Keys, [PLU], etc.).

Case 3: When the PLU Keyboard PK-2 (hardware option) is connected:

- 1) Character Keys provided on the PK-2 Character Setting Sheet may be used to directly enter the characters (DIRECT CHARACTER ENTRY method). Any characters not provided there (and those provided as well) may be entered, in the CHARACTER CODE ENTRY method, through the Numeric Keys and the [#] key on the ECR keyboard.
- 2) All Function keys ([C], [@/FOR], [ST], [AT/TL], [DP#], etc.) must be operated on the ECR keyboard.
- 3) In the following operations, however, the Character Setting Sheet should be removed and the keys on the PK-2 are used as PLU Preset-code Keys:
 - PLU PRESET-CODE KEY SETTING (Submode 27)
 - PLU PRESET PRICE SETTING OR CHANGING (no submode) --(This may be operated on the ECR Keyboard as well.)

CHARACTER ENTRIES

As already stated, there are two methods of operations for character settings for names or messages: CHARACTER CODE ENTRY Method and DIRECT CHARACTER ENTRY Method.

CHARACTER CODE ENTRY Method

This method is to set a character by entering a Character Code and depressing the [#] key.

DIRECT CHARACTER ENTRY Method

This method is to set a character by directly depressing the Character Key on any of the following keyboard:

- TKB-1 Keyboard (Programming Keyboard; hardware option)
- PK-2 Keyboard (PLU Keyboard; hardware option)

By using those character keys, the characters are directly entered. In this manual, sample operations are attached to most of the programming operations. And at name or message programming portions, characters are entered by the CHARACTER CODE ENTRY method. Instead of this, you may depress the Character Keys. For example, instead of entering 11 [#] (to enter character "A"), you may simply depress Character Key "A" on either of the above keyboards.

On the following pages, Character Code Tables under the CHARACTER CODE ENTRY Method and two different keyboards under the DIRECT CHARACTER ENTRY Method are shown. These pages are to be referred to, every time the "Character Entries" sequence is contained in various programming operations in this manual.

Read through these pages at least once first, so that you may know the appropriate method of character entries using the ECR keyboard and/or option keyboards.

Character Code Entry Method

Character Code Table 1: Standard Characters

Col Row	0	1	2	3	4	5	6	7	8	9	10	11	12	13	14	15	16	17	18
0	0	@	J	T	ア	サ	ナ	マ	ラ	ア	,	½	j	t	Ä	ä	â	(
1	1	A	K	U	イ	シ	ニ	ミ	リ	イ	.	a	k	u	Ö	ö	ê)	
2	2	B	L	V	ウ	ス	ヌ	ム	ル	ウ	:	b	l	v	Ü	ü	ç		
3	3	C	M	W	エ	セ	ネ	メ	レ	エ	'	c	m	w	Æ	æ	é		
4	4	D	N	X	オ	ソ	ノ	モ	ロ	オ	/	d	n	x	Œ	œ	è		
5	5	E	O	Y	カ	タ	ハ	ヤ	ワ	ツ	#	e	o	y	Å	å	ú		
6	6	F	P	Z	キ	チ	ヒ	ユ	ヨ	ヤ	✕	f	p	z	Ñ	ñ	á		
7	7	G	Q	\$	ク	ツ	フ	ヨ	ン	ユ	∏	g	q	+	%	ß	í		
8	8	H	R	£	ケ	テ	ヘ	丨	"	ヨ	&	h	r	φ	///	Ð	ó		
9	9	I	S	¥	コ	ト	ホ	丨	°	一	丨	i	s	=	?	ö	↑		

Space

Character Setting Operations :

- To set a regular-sized character, enter the COL (column) code and then the ROW code, followed by the [#] (or [#NS]) key.
ex.) To set "M"; enter 23, and depress [#].
To set "%", enter 147 and depress [#].
- To set a blank instead of a character, simply depress [#] without a prior code entry, or enter 169 and depress [#].
- Depress the [@/FOR] key once prior to a regular-sized character entry, and it will be a double-sized character (a blank will also be double-sized).
ex.) To set "GROUP", "G" in double-sized, and "ROUP" in regular-sized:

[@/FOR] 17 [#] 28 [#] 25 [#] 31 [#] 26 [#]
 G R O U P

- Depress the [@/FOR] key twice prior to the first character code entry to set the entire message line or enter name with all double-sized characters.
ex.) To set "GROUP" all in double-sized:

[@/FOR] [@/FOR] 17 [#] 28 [#] 25 [#] 31 [#] 26 [#]
 | G R O U P
 All Double-sized Declaration

Character Code Table 2 : Kanji Characters

The character setting operations are the same as described for Character Code Table 1, except that:

Each of these characters enters in the regular-sized character sequence, but the character will automatically be printed in double-sized.

NOTES : 1) *These characters may only be accessed by the CHARACTER CODE ENTRY method, but not by the DIRECT CHARACTER CODE ENTRY method.*

2) *Note that character codes 257, 258, 260 and 261 cannot be printed on the DRS-107 (hardware option).*

Col Row	20	21	22	23	24	25	26	27
0	合	入	取	高	月	特	的	単
1	計	金	消	課	日	奉	費	価
2	現	返	客	税	組	休		商
3	小	支	点	万	人	~		品
4	預	払	回	買	上	内		部
5	釣	値	数	責	仕	非		門
6	掛	引	信	受	名	外		
7	売	割	純	免	訂	福		
8	戻	個	円	料	定	社		
9	替	券	在	年	総	目	正	

Direct Character Entry Method

Using TKB-1 (Programming Keyboard; hardware option)

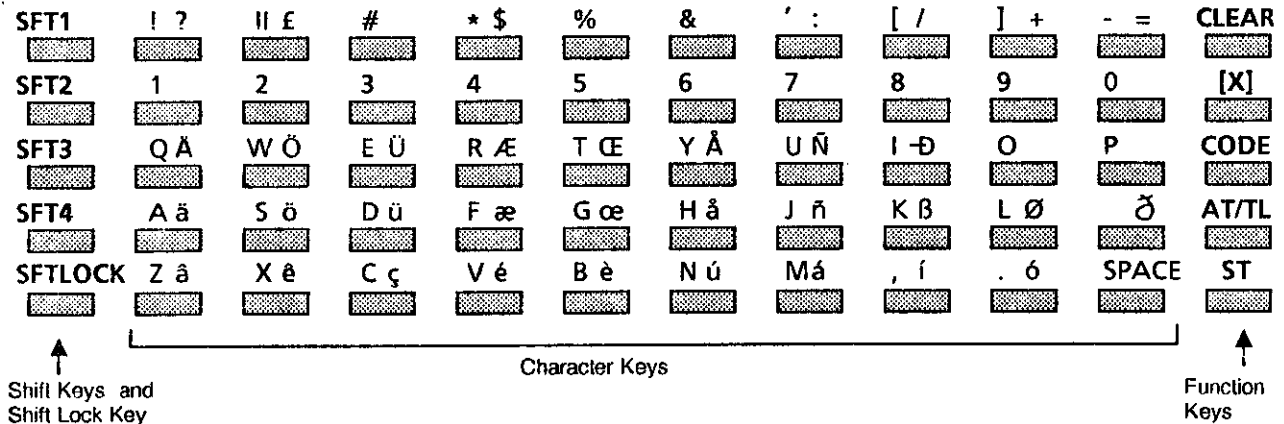

Shift Keys (1 to 4), Shift Lock Key

Used to designate the shift of the character keys. Each character has three different characters, each of which is designated by the Shift Key 1 to Shift Key 3. (The Shift Key 4 is not used for the MA-1400 series models.)

Shift Key 2 and Shift Key 3 are effective for one following character only. After that, the Shift 1 mode is automatically regained.

Character Keys

Used to enter alpha/numerics as characters. In setting a name or message, simply depress the corresponding character key here, instead of a character code and the [#] key combination on the ECR keyboard.

ex.)

A ä

"A" is entered in the Shift 1 mode.

Operate: ([SFT1]) → [A ä]

"a" is entered in the Shift 2 mode.

Operate: [SFT2] → [A ä]

"ä" is entered in the Shift 3 mode.

Operate: [SFT3] → [A ä]

The numeric keys [1] through [0] (on the second row from the top) are used as character keys (i.e. the entered number will be part of the name or message to be printed), but not used for code entry purpose such as for Department Codes, PLU Codes, etc.

Also note that those numeric keys may be entered in the Shift 1, 2, or 3 mode.

Function Keys

Except for the [CODE] key, each of the function keys corresponds to the identical key installed on the ECR keyboard as to the function in programming operations. ([CLEAR] = [C])

The [CODE] key cannot be used for the MA-1400 series ECRs.

Operation Examples

To set the Menu Item name "COFFEE" for Dept. 2:

ON ECR KEYBOARD ONLY

3 [@/FOR] [DEPT 2]	<u>13 [#]</u> C	<u>25 [#]</u> O	<u>16 [#]</u> F	<u>16 [#]</u> F	<u>15 [#]</u> E	<u>15 [#]</u> E
	[ST] [AT/TL]					

USING TKB-1 KEYBOARD

3 [@/FOR] [DEPT 2]	C O F F E E [ST] [AT/TL]
on ECR	on TKB-1

([@/FOR], [ST], and [AT/TL] may be operated on ECR or on TKB-1. Code entries such as "3" in the above example must be entered on ECR.)

The "One Double-size Declaration" (by depression [@/FOR] once prior to the required character) and the "All Double-size Declaration" (by depressing [@/FOR] twice before the entire descriptor) are the same as in setting characters on the ECR keyboard.

Any characters not listed on the TKB-1 keyboard may be entered by the code entry method on the ECR keyboard. (the characters even listed on the TKB-1 keyboard may be entered as well by that method).

Manual Tax Entry

OPERATION

| Irregular Tax Amount to be Added | [TAX]

-- Receipt Print Sample --

TAX4	\$0.50
------	--------

Subtotal

OPERATION

[ST]

NOTE : A program option provides the selection not to print but only display the subtotal even on the first depression of the [ST] key.

-- Receipt Print Sample --

SUBTL	\$17.50
-------	---------

Taxable Total Read

The sale total including tax due of the items so far entered is displayed, but not printed.

OPERATION

[TXBL TL]

Food Stampable Total Read, Food Stamp Tendering

OPERATION

[FSTL TEND] → | Food Stamp Tendered Amount | [FSTL TEND]

Display the Food Stampable Total

Tendering in Food Stamp
(This must be operated first of all the payments in finalizing the sale if food stamps are part of the payment.)

NOTE : When the Food stamp tendered amount is less than the sale total, the sale is not finalized with the balance still due is displayed. Then it will be finalized with cash or other media total or tendering operations.

SAMPLE OPERATION CONTENTS	KEY OPERATION	DISPLAY																			
		PLU		AMOUNT									SH								
		DPT	RPT	SL	AL	RE	(-)	FS	TK	ST	TL	CG	TR								
Sale items have been entered. Food Stampable total is read. Tenders \$10.00 in food stamps. The sale is finalized, change is displayed.	[FSTL TEND] 1000 [FSTL TEND]																				

-- Receipt Print Sample --

```

TOTAL          $7.50
FS/TL          $7.50
F-STMP        $10.00
CHANGE         $0.50
FS CHG         $2.00

JONES    0084 14:39TM
    
```

Change in Food Stamps (unit dollar)

Change in cash.

Tax Exempt

OPERATION

Selective Tax Exemption

[TX1/M] [EX] → Sale Finalization --- to exempt Tax 1 only
 [TX2/M] [EX] → Sale Finalization --- to exempt Tax 2 only
 [TX3/M] [EX] → Sale Finalization --- to exempt Tax 3 only

All Tax Exemption

[EX] → Sale Finalization
 [TX1/M] [TX2/M] [TX3/M] [EX] → Sale Finalization] to exempt all taxes.

NOTE : On depressing [EX], the sale total excluding the exempted-tax(es) is displayed and pre-taxed amount of the sale portion subject to the tax exemption is printed.

-- Receipt Print Sample --

TAX1EX	\$4.00
TAX2EX	\$6.50

Sale Finalization by Media Keys

OPERATION

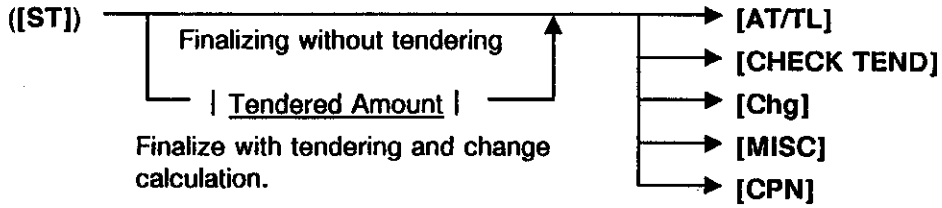

- NOTES :**
- Whether each Media Key is depressed with a prior Tendered Amount entry or not is determined by the key status selections programmed for each media key.
 - If the sale total is "0" or negative, [AT/TL] key must be depressed without a tendered amount entry even if it is programmed as a "Tender" Key.

-- Cash Tender Sample --

TAX	\$0.23
TOTAL	\$6.73
CATEND	\$10.00
CHANGE	\$3.27
JONES	0093-14:52TM

-- Charge Total Sample --

TAX	\$2.34
Chg	\$20.63
JONES	0095 14:54TM

Multi-Tendering

Short-tendering repeated multiple times by the same media (allowed only when the media key is programmed to allow short-tendering).

OPERATION

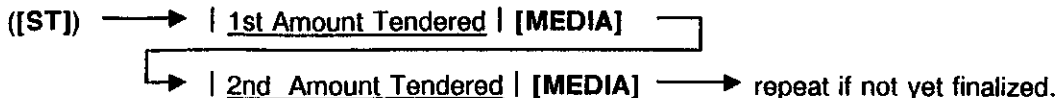

-- Receipt Print Sample --

TAX	\$0.73
TOTAL	\$18.53
CATEND	\$10.00
CATEND	\$10.00
CHANGE	\$1.47
JONES 0096 14:57TM	

Split-Tendering

Short-tendering repeated multiple times by the different media keys (allowed only when the media keys are programmed to allow short-tendering).

OPERATION

Example 1)

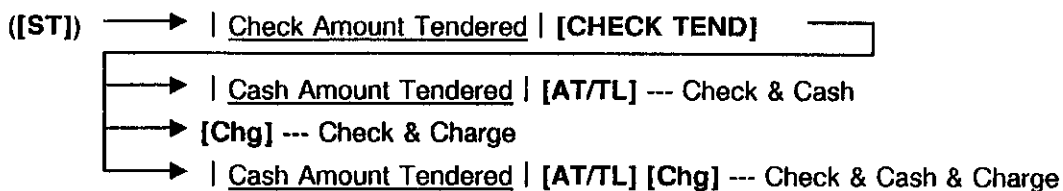

Example 2)



-- Receipt Print Sample --

TAX	\$0.73
TOTAL	\$18.53
CHECK	\$10.00
CATEND	\$10.00
CHANGE	\$1.47
JONES 0097 14:59TM	

Check Cashing (No-sale cashing of a non-cash media)

OPERATION

(must be operated outside a sale)

| Check Amount to be Cashed | [CHECK TEND] --- The drawer opens to enable the exchange.

NOTE : Other non-cash media keys may be used for this purpose if programmed to allow no-purchase cashing.

-- Receipt Print Sample --

```

TEC STORE
1343 PEACH DRIVE
PHONE: 87-6437

Thank you
                Call again

11-20-89   #3001

CHECK      $10.00

JONES     0098 15:01TM
  
```

Sale Paid In Foreign Currencies

OPERATION

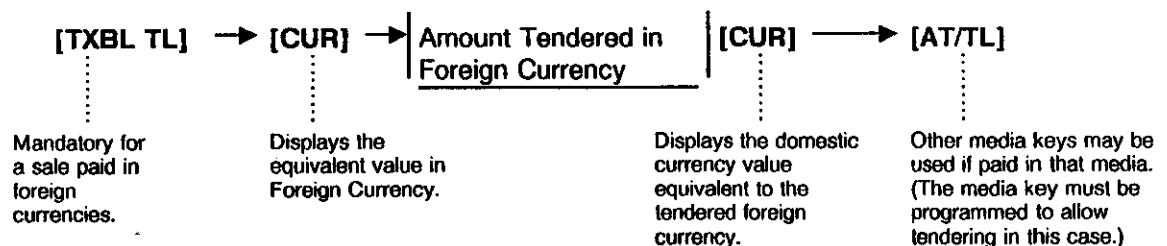

- NOTES**
1. When a tendering by a foreign currency occurs during a short tendered condition, the [TXBL TL] key will not be mandatory.
 2. The sale is finalized if over-tendered, with change due displayed in the domestic currency.
If short-tendered, the balance due is displayed in the domestic currency value.
 3. A sale of negative balance cannot be finalized using any of the foreign currency keys.
 4. The foreign currency keys cannot be used to finalize Received-on-Account payments or charge posting.

SAMPLE OPERATION CONTENTS	KEY OPERATION	DISPLAY																			
		PLU		AMOUNT									SR								
		DPT	RPT										TR								
		SL	AL	RE	LI	FS	TX	ST	TL	CG	TR										
Sale items have been entered.																					
Obtain subtotal.	[TXBL TL]																				
The customer wants to pay in Foreign Currency. (Reading the displayed amount in CUR, you tell the amount to the customer.)	[CUR1] (The CUR value equivalent to the above subtotal amount is displayed.)																				
The customer tenders an amount of F50.00 in CUR.	5000 [CUR1] (The amount tendered is displayed in the domestic currency.)																				
Since paid in cash, use [AT/TL].	[AT/TL]																				
The sale is over-tendered and finalized. Give the change (displayed in the domestic currency value) to the customer in the domestic currency.	<div style="border: 1px solid black; padding: 5px;"> TAX \$0.38 TOTAL \$7.88 CATEND \$9.31 CHANGE \$1.43 JONES 0101 15:03TM </div>																				

No-sale Exchange from a Foreign Currency to the Domestic Currency

OPERATION (must be operated outside a sale)

[CUR] → | Amount of Foreign Currency to be exchanged | [NS]

The drawer opens to enable exchange. Displays the domestic currency amount equivalent to the entered foreign currency amount.

-- Receipt Print Sample --

CUR1	100.00
CHANGE	\$18.61
JONES	0103 15:11TM

Received-on-Account

A received-on-account transaction is used to identify money which is in the drawer but not from the daily business.

OPERATION (must be operated outside a sale)

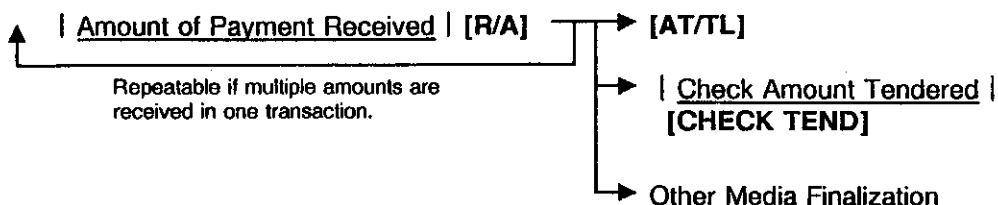

NOTE : Media Keys to finalize R/A entries must be programmed with the status "R/A operation allowed".

Paid-Out

A paid-out transaction is used when money is removed from the drawer without totaling to a sale.

OPERATION (must be operated outside a sale)

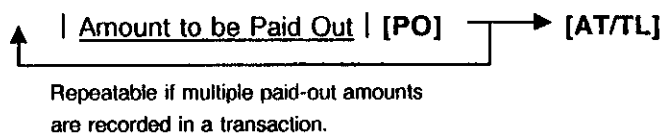

NOTE : Only [AT/TL] key can finalize paid-out transactions.

-- Receipt Print Sample --

```

TEC STORE
1343 PEACH DRIVE
PHONE: 87-6437

Thank you
          Call again

T
1
11-20-89 #3001

Tha R/A      $5.00
     R/A      $3.00
     CASH     $8.00

11 JONES 0104 15:13TM

PO      $4.50
TOTAL   $4.50

JONES 0105 15:14TM
  
```

Validation Print

OPERATION

After entering the required item through a transaction key or media key **(NOTE 3)**

→ Insert a validation slip into the validation slot. Make sure that the "SLP" lamp is steadily lit. → **[VALIDATE]**

- NOTES :**
1. No other operations can follow until the validation slip once printed is withdrawn.
 2. Because printing occurs on the bottom side of the paper, please be certain to insert the slip into the validation slot with the printing side downward.
 3. If the "SLP" lamp flickers during registrations, it indicates that the last item just registered has been programmed to require validation print. In this case, no other operations can follow until the validation print of the item is executed.
 4. The following are the programmable selections relating to validation:
 - (1) PRINT FORMAT
 - a) Clerk ID Print/Non-print
 - b) Consecutive No. Print/Non-print
 - (2) MULTI- or SINGLE-VALIDATION
(Number of times of validation print allowed for the same item)
 - (3) VALIDATION COMPULSORY status on the following keys :
 [AT/TL], [CHECK TND], [Chg], [MISC], [CPN], [TRF], [RTN MDSE], [PO], [R/A], [VOID], [ITEM CORR], [-] (Amount Disc.), [VND CPN], [STR CPN], [FSTL TEND], [%-], Negative Departments and PLUs.

RECEIPT PRINT

VALIDATION PRINT

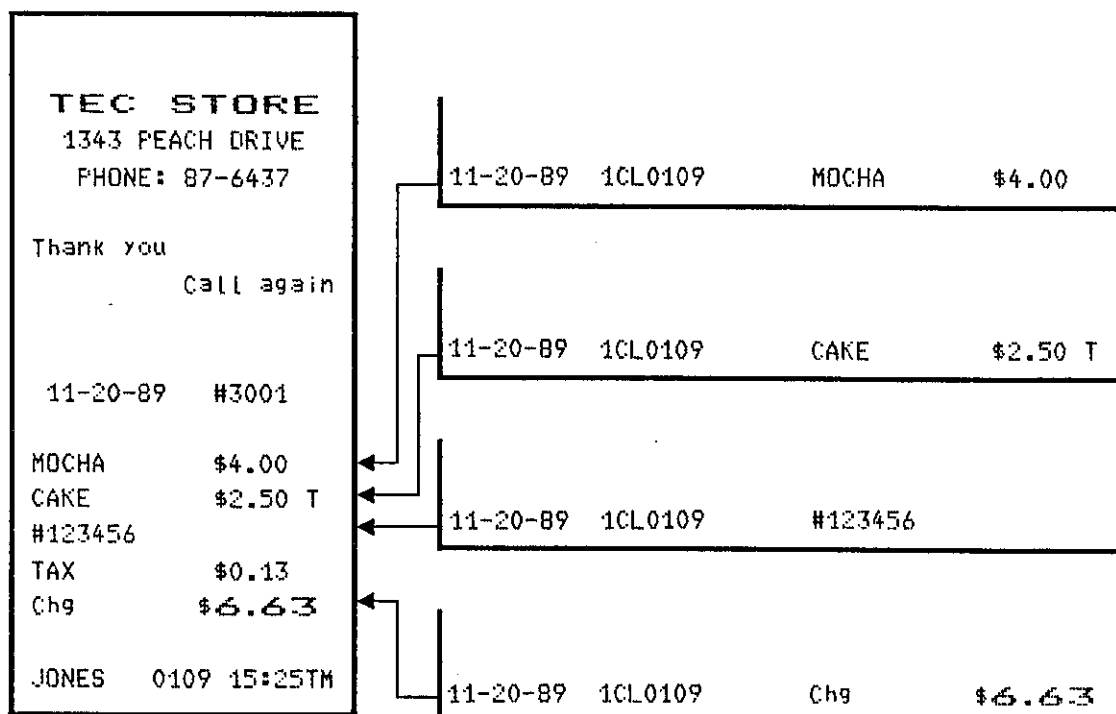

Receipt Post-Issue

OPERATION

(must be operated outside a sale)

(A sale is finalized) → **[RECEIPT ISSUE]**

Programmable options :

- Post-issue receipt is available only when the sale has been finalized with the sale has been finalized with **[RECEIPT ON/OFF]** switch positioned to "OFF".
- Available regardless of the switch position (in this case two receipts may be obtained for one sale.)
- Post-issue receipt is itemized receipt for a sale of maximum 30 lines. Exceeding 30 lines, the post-issue receipt is total-only receipt.
- Post-issue receipt is always total-only receipt regardless of the number of lines of a sale.

- NOTES :**
1. The post-issue receipt operation is not effective for a charge posting.
 2. The post-issue receipt content will not be printed on the Remote Slip Printer.
 3. The post-issue receipt is not available for Received-on-Account or Paid-Out transactions.

Ordinary Receipt

```

TEC STORE
1343 PEACH DRIVE
PHONE: 87-6437

Thank you
          Call again

11-20-89  #3001

FISH      $6.00 T
MILK      $1.50 T
FRUIT     $3.00 T
SUBTL     $10.50
TAX       $1.89
CASH      $12.39

JONES    0110 15:29TM
  
```

Post-issue Receipt

Itemize Type

```

TEC STORE
1343 PEACH DRIVE
PHONE: 87-6437

Thank you
          Call again

11-20-89  #3001

FISH      $6.00 T
MILK      $1.50 T
FRUIT     $3.00 T
SUBTL     $10.50
TAX       $1.89
CASH      $12.39

JONES    0110 15:29TM
  
```

Total-only Type

```

TEC STORE
1343 PEACH DRIVE
PHONE: 87-6437

Thank you
          Call again

11-20-89  #3001

TOTAL     $12.39

JONES    0110 15:29TM
  
```

Previous Balance, Charge Posting

OPERATION

(1) To initiate charge posting for a new customer

| Q | [PB +] (or [PB-]) → Follow the line marked with "★" in operation (2) below.

(2) Charge posting with a previous balance first entered (pre-select) with or without PAYMENT

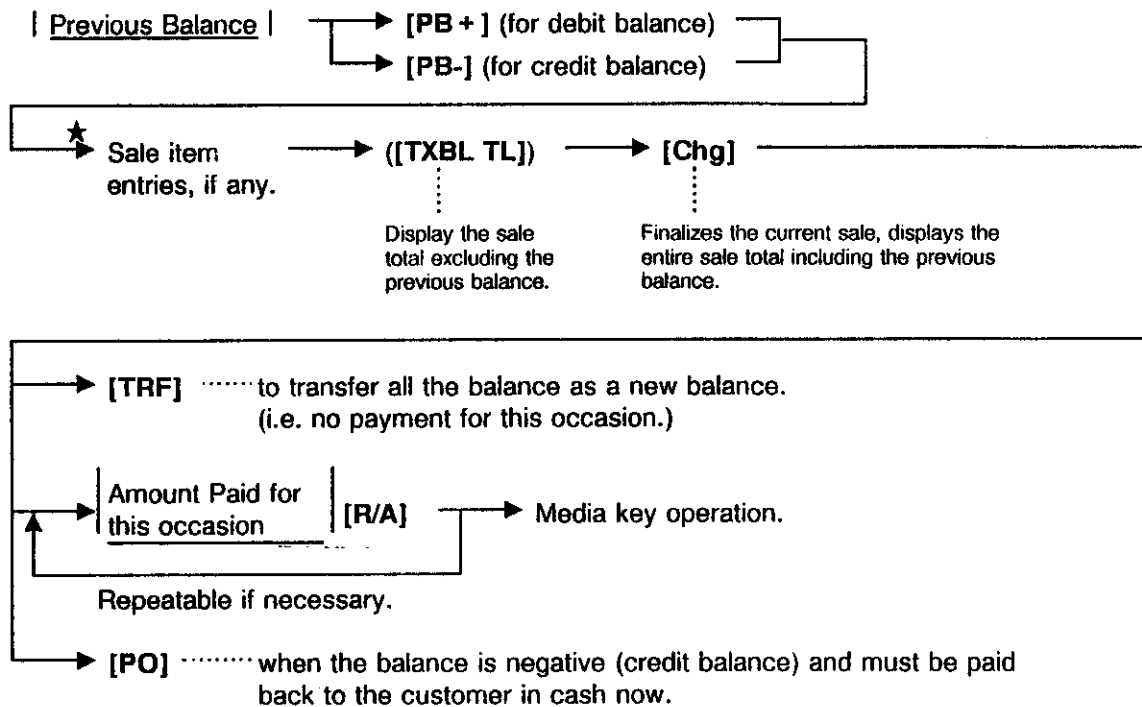

(3) Charge posting with a previous balance entered during a sale (post-select)

A previous balance may be entered not only before sale items but also after or between them if the [Chg] key has not been depressed. Multiple previous balance entries are possible within a sale (for the purpose to sum up multiple accounts into one, etc.)

(4) Percent charge/discount on a previous balance

| Previous Balance | [PB +] → (| Rate |) [% +]

NOTES : 1. The [%-] key operates the same for percent discounting.

2. The previous balance entered through [PB-] (credit balance) will not allow % + or %- operation.

SAMPLE OPERATION CONTENTS	KEY OPERATION	DISPLAY												
		PLU		AMOUNT										
		DPT	RPT	SL	AL	RE	(-)	FS	TX	ST	TL	CG	TR	
<p>A customer has come. This customer has a previous balance of \$4.00.</p> <p>Ten items of PLU No. 30</p> <p>All his balance is read.</p> <p>He will pay \$5.00 in cash. Then the balance was carried forward to the next time.</p>	400 [PB +]										4	0	0	
	10 [@/FOR] 30 [PLU]	0	3	0								5	0	0
	[Chg]											9	5	0
	500 [R/A]											5	0	0
	[AT/TL]											5	0	0
<p>The customer comes again. Then he said he would pay all the previous balance.</p> <p>He pays the exact amount in cash.</p> <p>The balance of the customer is zero.</p>	450 [PB +]										4	5	0	
	[Chg]											4	5	0
	450 [R/A]											4	5	0
	[AT/TL]											4	5	0

```

11-20-89 #3001

PB+      $4.00
  10X    0.50 @
SUGAR    $5.00 T
TAX      $0.50
Chg      $9.50
R/A      $5.00
CASH     $5.00

NEW BAL  $4.50

JONES   0119 15:47TM
    
```

```

11-20-89 #3001

PB+      $4.50
Chg      $4.50
R/A      $4.50
CASH     $4.50

NEW BAL  $0.00

JONES   0120 15:49TM
    
```

Other Income Entry

Used to enter items which do not directly become sales for the store, such as lottery, postage, gift wrapping fee, size adjustment fee, utility (payment of electricity and gas), and donation.

OPERATION

- | Price | [Other Income Dept] → Sale Finalization
- | Price | [Other Income Dept] [Same Dept] → Sale Finalization
- | Quantity | [X] | Price | [Other Income Dept] → Sale Finalization

-- Receipt Print Sample --

DP10	\$5.00
CASH	\$5.00
JONES	0123 15:54TM

Remote Slip Printer (hardware option) Operation

The TEC Remote Slip Printer DRS-107 may be connected to the MA-1400 series ECR as an optional device.

1. The remote slip printer will automatically activate printing when the slip has properly been set to the printer table.
2. The gap of the slip inlet is usually opened, and the slip may be inserted or withdrawn freely outside a receipt/journal print sequence.
3. The EJECT key on the DRS-107 may be used to open the closed gap in order to withdraw the slip and skip unnecessary item print. The EJECT key will be disregarded if the slip is set and the ECR receipt/journal printer is in a printing action.
4. Printing on the remote slip printer will be performed alternately with printing on the receipt/journal printer is in a printing action.

RECEIPT PRINT

11-20-89	#3001
MILK	\$5.00 T
MILK	\$5.00 T
5X	3.00 @
MOCHA	\$15.00
SUBTL	\$25.00
TAX	\$1.00
Chg	\$26.00
JONES	0264 21:40TM

REMOTE SLIP PRINT

MILK	\$5.00 T
MILK	\$5.00 T
5X	3.00 @
MOCHA	\$15.00
SUBTL	\$25.00
TAX	\$1.00
Chg	\$26.00
11-20-89	#3001
JONES	0264 21:40TM

9. POWER FAILURE PROCESS

If a power failure occurs, the sales memory is protected by the back-up battery; registration and printing will normally be performed on regaining the power. However, please note the following cases:

- (1) The printer will work to print the entered data without failure after the power recovery if any data was being printed. However, one extra line may be fed on the power recovery depending on the power failure timing.
- (2) The following are displayed indications on the power recovery :

ECR CONDITION at the time of Power Failure		DISPLAY INDICATION on the Power Recovery
OUTSIDE A SALE.	No Key-in has been operated.	Displays zero Operations may go on.
	Numeric or Declaration Keys (such as [RTN MDSE], [PR OPEN], etc) have been entered but not motorized keys.	
DURING A SALE.	No Numeric or Declaration keys have been entered.	Regain the display content that was obtained just before the power failure. The operations may be continue.
	Numeric or Declaration keys have been entered.	

If a power failure occurs, it is recommended to check the receipt print content before the receipt is handed to the customer.

10. JOURNAL AND RECEIPT PAPER-END DETECTOR

- (1) This detects when either the journal or receipt paper is running out. It is provided to prompt the operator to replace the old paper roll with a new one.
- (2) When the paper roll is running out (or the paper has not been set properly), no key operation is accepted and the AMOUNT portion of the display keeps flickering.
- (3) When a new paper roll is set, only the [RF] and [JF] keys are allowed to operate. Next, when the [C] key is depressed, the display flickering will be cleared and normal key-in operations will be accepted. When any printing has been suspended, it will continue printing.
- (4) If this detector senses a paper-end condition during printing, the printing stops after the current line printing is completed.
- (5) If the [C] key is depressed in the paper-end condition, it is ignored. The [C] key depression will clear the display flickering only after the new paper roll is set.

11. ECR PRINTER MOTOR LOCK DETECTOR

- (1) This detects the printer motor lock condition caused by some trouble, such as paper jamming.
- (2) When such a condition is detected, the front display indicates "Error" and none of the keys (including [RF] and [JF]) will be accepted.
- (3) To regain the normal condition, turn the power of the ECR to OFF, remove the cause of the motor lock, and then turn the power to ON again.

12. REMOTE SLIP PRINTER MOTOR LOCK DETECTOR

- (1) This detects the remote slip printer motor lock condition caused by some trouble, such as paper jamming.
 - (2) When such a condition is detected, the front display indicates "Error" and none of the keys (including [RF] and [JF]) will be accepted.
 - (3) To regain the normal condition, turn the powers of the ECR and the remote slip printer to OFF, remove the cause of the motor lock, and then turn the powers to ON again.
- * If the cause cannot be found in the remote slip printer and only the ECR may be required to work temporarily without the remote slip printer, remove the remote printer cable from the ECR, and turn the power of the ECR to ON.

13. PAPER ROLL REPLACEMENT AND OTHER MAINTENANCE OPERATIONS

13.1 INSTALLING THE RECEIPT PAPER

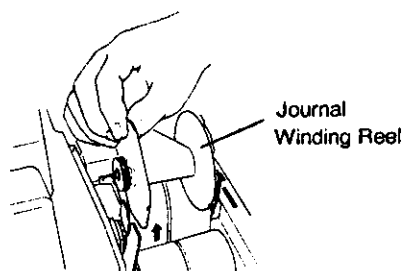

Fig. 1

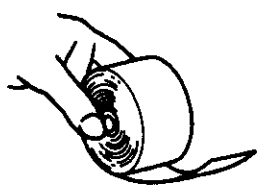

Fig. 2

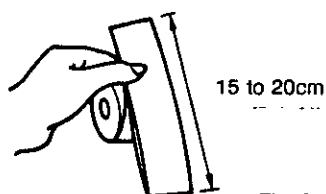

Fig. 3

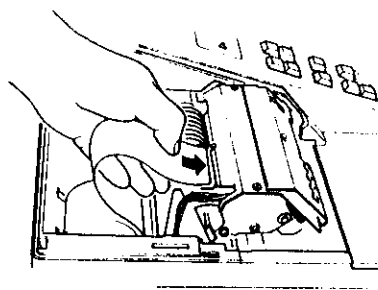

Fig. 4

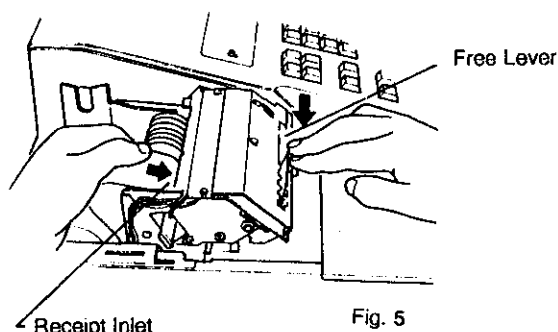

Fig. 5

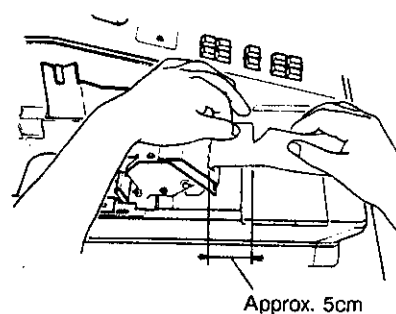

Fig. 6

1. Turn the Mode Lock to the "REG" position with the power ON.
2. Remove the Paper Cover, and remove the Journal Winding Reel (Fig. 1).
3. Hold a new paper roll in the direction shown in Fig. 2 so that the paper end will be fed from the bottom.
4. Fold the paper end as shown in Fig. 3 to ease the insertion.
5. Place the paper roll in the outer holder of the two roll holders (Fig. 4).
6. Insert the paper end into the Receipt Inlet, feed the paper in while pressing down the Free Lever (or feed the paper in while pressing the [RF] key). (Fig. 5)
7. When the whole folded portion has come out, tear off the unnecessary part with an appropriate end length remaining (approx. 5 cm or 2 inches). (Fig. 6)
8. Go on to INSTALLING THE JOURNAL PAPER steps if necessary, or go on to Step 9 below if not.
9. Attach the Paper Cover. Please note the paper end must be seen outside the cover.
10. Press the [C] key to clear the paper-end condition, and depress the [NS] key to issue a receipt to check if the paper has been properly set.

NOTE: The [RF] or [JF] keys function only when both receipt and journal paper rolls have been placed in their respective holders.

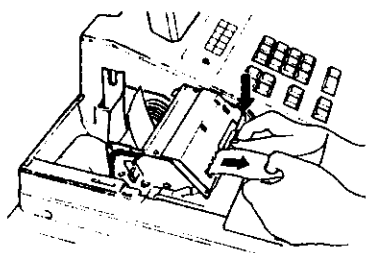

Fig. 7

13.2 REMOVING THE RECEIPT PAPER

1. Remove the Paper Cover.
2. Tear the paper end off the paper core, pull the paper end out while depressing the Free Lever. (Fig. 7)
3. Remove the paper core.

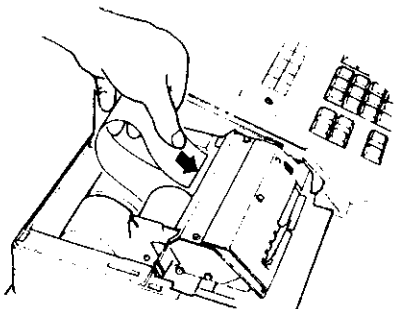

Fig. 8

13.3 INSTALLING THE JOURNAL PAPER

1. Turn the Mode Lock to the "REG" position with the power on.
2. Remove the Paper Cover by pulling it upward, and remove the Journal Winding Reel. (Fig. 1)
3. Follow Steps 3 and 4 of INSTALLING THE RECEIPT PAPER procedure on the previous page.
4. Place the paper roll in the inner roll holder of the two holders. (Fig. 8)
5. Insert the paper end into the Journal Inlet, feed the paper in while pressing down the Free Lever (or feed the paper in while pressing the [JF] key). (Fig. 9)
6. When a sufficient amount of paper comes out, wind the paper around the Journal Winding Reel two or three times, and set the Journal Winding Reel into the Reel Holder. (Fig. 10)
7. Attach the Paper Cover.
8. Press the [C] key before starting operation.

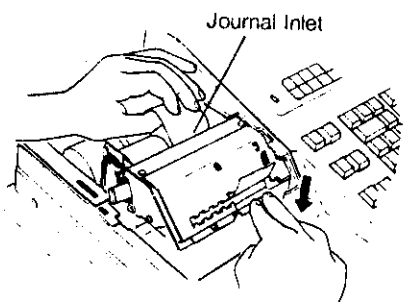

Fig. 9

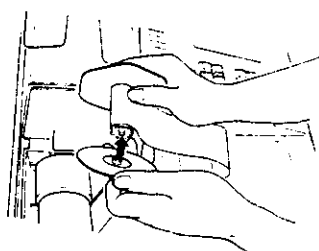

Fig. 10

13.4 REMOVING THE JOURNAL PAPER

1. Remove the Receipt Cover.
2. Press the [JF] key to wind up enough of the journal paper, and then tear off the paper, holding the Journal Winding Reel.
3. The wound-up portion of the paper can easily be removed from the Reel by pulling it sideways. (Fig. 11)
4. If enough paper remains on the roll, follow Steps 6 through 8 above; if the paper is running out, follow Steps 1 through 8 above.

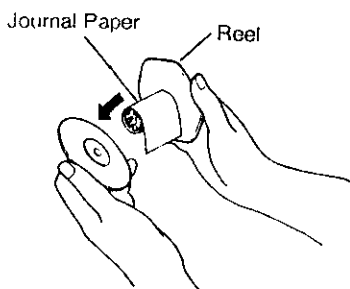

Fig. 11

NOTE: The [JF] or [RF] keys function only when both journal and receipt rolls have been placed in their respective holders.

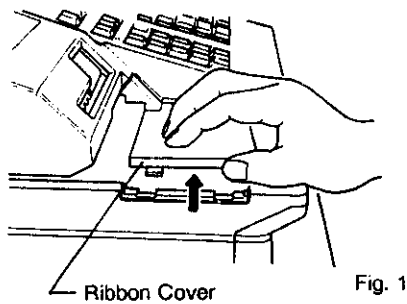

Fig. 1

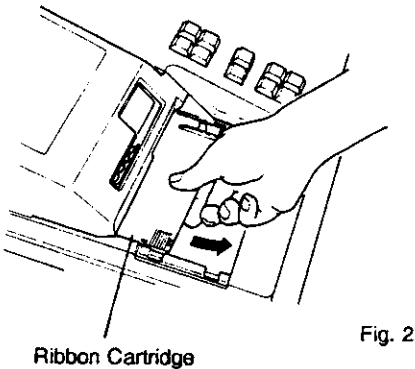

Fig. 2

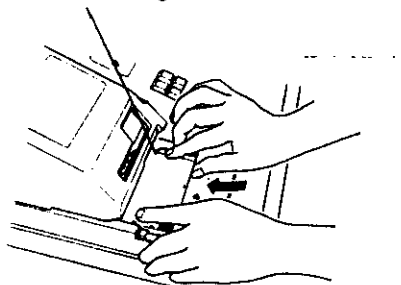

Fig. 3

13.5 REPLACING THE RIBBON CARTRIDGE

When the receipt and journal print is too light, replace the Ribbon Cartridge in the following manner:

1. Remove the Ribbon Cover (Fig. 1).
2. Remove the old Ribbon Cartridge by pulling it toward you (Fig. 2).
3. Install a new Ribbon Cartridge in the reverse order to Step 2 above (Fig. 3).
4. The Ribbon Cartridge is a consumable product. Be certain to use a genuine Ribbon Cartridge supplied by your TEC representative.

13.6 REPLENISHING THE STORE NAME STAMP WITH INK

When the store name stamp is printed too lightly, replenish the ink in the following manner:

1. Turn the Power Switch to OFF. Remove the Paper Cover.
2. Withdraw the store name stamp with the protruding part pinched between your fingers (Fig. 4).
3. Apply ink to the pad on the rear side of the Store Name Stamp. The amount applied should be adjusted according to the desired darkness of the printed message, but the limit of 2 cc should not be exceeded. (The ink bottle supplied contains 5 cc of ink.) (Fig. 5)
4. Follow the reverse order of the instructions in Step 2, and then attach the cover.

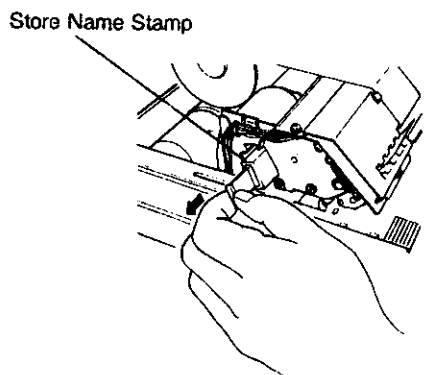

Fig. 4

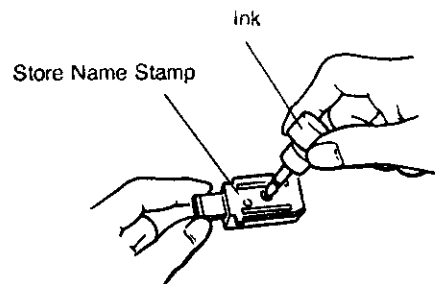

Fig. 5

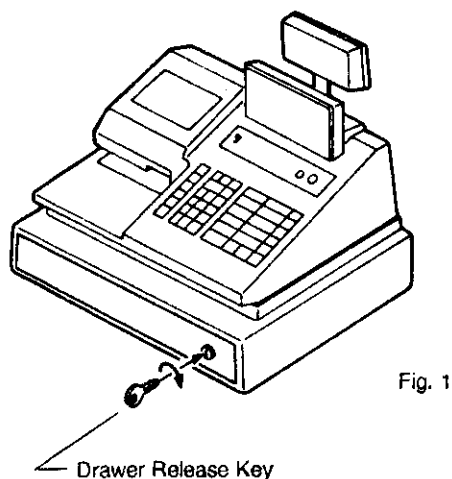

Fig. 1

13.7 MANUAL DRAWER RELEASING

The drawer opens automatically when a registration is performed. In the event of a power failure or other trouble, the drawer can be opened manually in the following manner:

1. Insert the Drawer Release Key into the drawer release lock and turn the key clockwise. The drawer will then open. (Fig. 1)
2. The Drawer Release Key can be taken out by returning it to the original position.
3. When the drawer is closed, it is automatically locked and will not open without the Drawer Release Key or a normal registering operation.

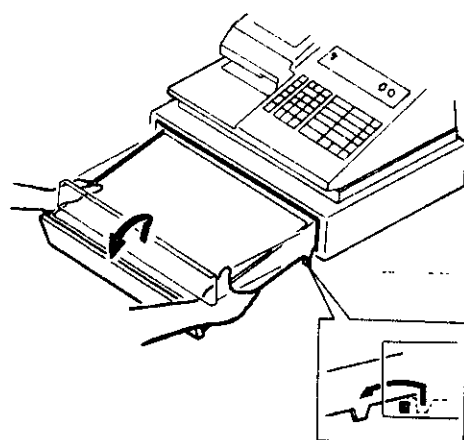

Fig. 2

13.8 REMOVING THE DRAWER

1. Pull the drawer out, and when it stops at the stopper, lift the drawer up and pull it further out (Fig. 2). When it stops again at the roller fixed in the drawer housing, lift it and pull it out (Fig. 3).
2. To return the drawer, follow the reverse procedure for removing.

13.9 CDC (Cash Drawer Cover) LOCK

Locking (Fig. 4)

1. Push the Cash Drawer Cover to the back of the drawer.
2. Press the cover lightly, insert the key into the key-hole on the cover, and turn it to lock.

Unlocking

1. Unlock the cover using the key, and lift the front end.

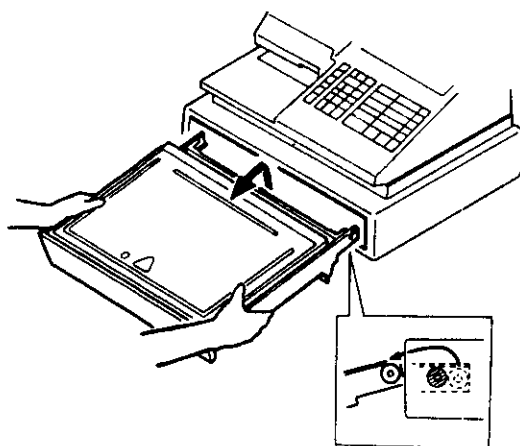

Fig. 3

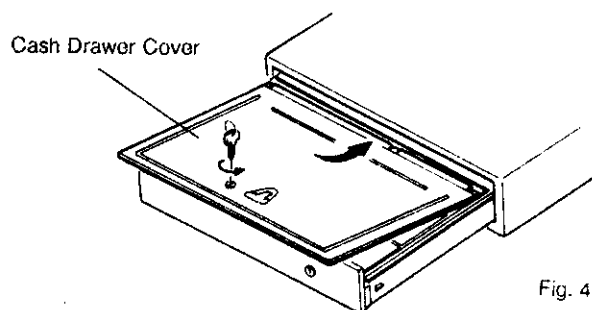

Fig. 4

14. SPECIFICATIONS

Size	460mm (width) x 419mm (depth) x 281mm (height) (height including rubber feet) (or 305mm-height when Customer Display is popped up.)
Weight	17.5kg
Power Required	AC100V, 110V, 117V, 220V, 240V; 50/60Hz (varies depending on the destination)
Power Consumed	0.7A (117V)
Ambient Temperature	0°C to 40°C
Relative Humidity	10% to 90%
Size of Receipt and Journal Tape ..	45mm (width) x 80mm (diameter)

VALIDATION SLIP SPECIFICATIONS

Type of Paper	Non-carbon Paper, or Ordinary Paper + Carbon Sheet
Thickness	0.06mm to 0.2mm (total thickness)
Max. Number of Duplicates	2 sheets (including the original sheet)
Size of Slip	Min. 150mm (width) x min. 70mm (height)

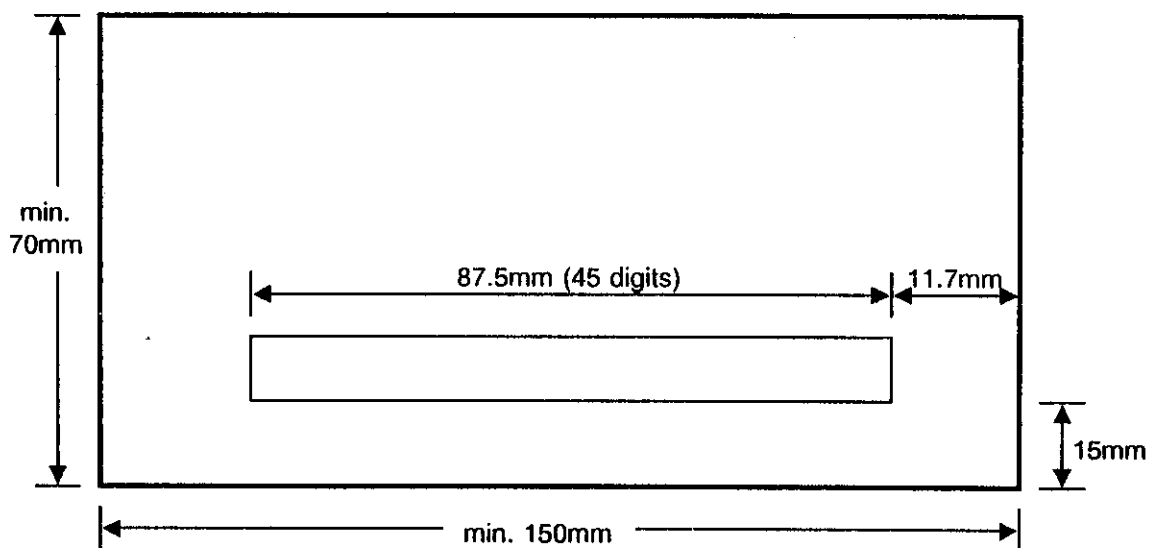

MANAGER'S GUIDE

TABLE OF CONTENTS

	Page
1. MANAGER INTERVENTION	1
1.1 ITEMS PROGRAMMED TO REQUIRE MANAGER INTERVENTION	1
1.2 LISTING CAPACITY RELEASE BY MANAGER INTERVENTION	2
2. OPERATION IN " <input type="checkbox"/> " MODE	3
3. READ (X) AND RESET (Z) REPORTS	4
Daily Reports	4
GT Reports	5
Report Print Sample	6
4. PROGRAMMING OPERATIONS	16
5. VERIFICATION OF PROGRAMMED DATA	39

1. MANAGER INTERVENTION

1.1 ITEM PROGRAMMED TO REQUIRE MANAGER INTERVENTIONS

During daily sale entry operations, the clerk may call for Manager Interventions. The following is the operation flow of a Manager Intervention.

- (1) During operations, the clerk comes across an item that requires a Manager Intervention. The clerk, already informed of it, may immediately call for a Manager Intervention. Or the clerk, without knowing of it, attempts the operation and error results, clears the error by the [C] key, and then calls for a Manger Intervention.



- (2) You go to the cashier counter with the **MGR** or **MA** key.



- (3) The clerk explains what kind of operation is attempted, and removes the **REG** key from the Mode Lock at the "REG" position.



- (4) You insert the **MGR** or **MA** key and turns it to the "MGR" position.



- (5) The clerk operates the required item.



- (6) The manager returns the **MGR** or **MA** key to the "REG" position and pulls it out.



- (7) The clerk sets the **REG** key to the "REG" position again and continues registering operations.

The following are the tables of the keys and operations that are programmable with Manager Intervention. Fill in the table by marking in the "Not Required" or "Required" column of each item, referring to the documents, etc. listed in the table.

Table 1 : KEYS AND MANAGER INTERVENTION STATUS

Key	Manager Intervention		Reference
	Not Required	Required	
[RTN MDSE]			Ask your TEC representative as to information or changes of KEY STATUSES.
[PO]			
[-]			
[%-] (or % I , % II)			
[EX]			
[ALL VOID]			
[VND CPN]			
[STR CPN]			

Table 2 : OPERATIONS AND MANAGER INTERVENTION STATUS

Key	Manager Intervention		Reference
	Not Required	Required	
Negative Balance Sales finalization by Media Keys (except [AT/TL])			Ask your TEC representative as to information or changes of PROGRAM OPTIONS.
Negative Department or negative PLU entries.			

1.2 LISTING CAPACITY RELEASE BY MANAGER INTERVENTION

Listing Capacities (LC) may be programmed on Departments/PLUs, Tender Medias. These LC's are programmed to check an excessively high amount entry by operator's mistake at the earliest stage. The procedure of operators and Manager Intervention for LC release is same as described in 1.1.

2. OPERATIONS IN "☐" MODE

Instead of using the [RTN MDSE] or [VOID] keys in the "REG" or "MGR" mode for deleting individual items, the "☐" mode automatically processes positive items into negative and negative into positive. To operate, turn the Mode Lock to the "☐" position using the MA key, and enter the items, one by one, just as in the "REG" mode, as reading the sale receipt (issued at the time of the purchase) or tracing the returned items as if in the "REG" mode. A positive balance resulted in the "☐" mode indicates the amount to be paid back to the customer.

The "☐" mode operation may occur from time to time during day, on the clerk's request, just as in the case of ordinary Manager Interventions, when a customer comes to the cashier counter to return or cancel all the items that he once purchased.

OPERATION AND RECEIPT SAMPLE

RECEIPT ISSUED IN "REG" or "MGR" MODE

```

TEC STORE
1343 PEACH DRIVE
PHONE: 87-6437

Thank you
          Call again

11-20-89   #3001

COFFEE     $2.50
CAKE       $2.50 T
MILK       $1.50 T
TAX        $0.28
CASH       $6.78

JONES      0124 15:57TM

```

These two receipts contain the same sale items and media finalization. The operations are also the same except the Mode Lock position.

The clerk merely follows the purchase receipt (on the left) and enters the same items in the ☐ position, finalizing with the same media, in case a customer has returned or canceled the entire sale after the clerk had finalized that sale.

The ☐ mode header ("REG-" in this example) is printed at the top and bottom of the sale contents in the ☐ mode receipt.

RECEIPT ISSUED IN "☐" MODE

```

TEC STORE
1343 PEACH DRIVE
PHONE: 87-6437

Thank you
          Call again

11-20-89   #3001

*REG-
COFFEE     $2.50
CAKE       $2.50 T
MILK       $1.50 T
TAX        $0.28
CASH       $6.78

*REG-
JONES      0125 15:57TM

```

3. READ (X) AND RESET (Z) REPORTS

The following table shows the key operation to take each report. The "X" and "Z" reports have exactly the same print content if both are available, except that:

1. The "X" reports allow to read the sales data but not clear memories, while the "Z" reports allow to read the sales data and at the same time all the resettable memories will be cleared when the reports have been issued.
2. The symbol "Xnn" is printed on the top line of an "X" report, while "Znn" is printed on a "Z" report. ("nn" is the Report No.)
3. A reset count is printed on the bottom of a "Z" report only.

TABLE OF OPERATIONS FOR X AND Z REPORTS

Daily Reports

REPORT NAME	MODE LOCK	KEY OPERATION	SAMPLE PAGE
* FINANCIAL READ AND RESET <ul style="list-style-type: none"> • Financial Read • Financial Reset 	X Z	[AT/TL]	6
PLU READ AND RESET <ul style="list-style-type: none"> • All PLU Read • All PLU Reset • Zone PLU Read • Zone PLU Reset 	X Z X Z	[PLU] Zone-start PLU Code [@/FOR] Zone-end PLU Code [PLU]	9
HOURLY RANGE READ AND RESET <ul style="list-style-type: none"> • Hourly Read • Hourly Reset 	X Z	10 [AT/TL]	10
DEPARTMENT READ AND RESET <ul style="list-style-type: none"> • All Department Read • All Department Reset 	X Z	11 [AT/TL]	11
DEPARTMENT GROSS PROFIT READ	X	12 [AT/TL]	12
* CLERK READ AND RESET <ul style="list-style-type: none"> • Individual Clerk Read • Individual Clerk Reset 	X Z	Set the required clerk key to ON. → 1 [AT/TL]	13
* MEDIA-IN-DRAWER READ	X	[#] (or [#NS])	14

GT Reports --to be taken on weekly or monthly basis --

REPORT NAME	MODE LOCK	KEY OPERATION	SAMPLE PAGE
* FINANCIAL GT READ AND RESET <ul style="list-style-type: none"> • Financial GT Read • Financial GT Reset 	X Z	20 [AT/TL]	15
DEPARTMENT GT READ AND RESET <ul style="list-style-type: none"> • All Department GT Read • All Department GT Reset 	X Z	21 [AT/TL]	---
DEPARTMENT GT GROSS PROFIT READ	X	22 [AT/TL]	---

- NOTES :**
1. The drawer will open on the depression of the final key of the KEY OPERATION for the reports marked with " * " in the table.
 2. No clerk key is necessary to issue reports except CLERK READ AND RESET.
 3. Refer to the report samples on the following pages. As for the program data reading which is also available in the "X" mode, see the "VERIFICATION OF PROGRAMMED DATA".

FINANCIAL READ or RESET REPORT

Mode Lock : X for read
Z for reset,
[AT/TL].

TEC STORE	
1343 PEACH DRIVE	
PHONE: 87-6437	
Thank you Call again	
11-20-89 #3001	
X	
Grand Total	GT \$662.59
	GS 215 \$662.59
Department Name, Item Count	COFFEE 43
	30CU \$136.20
	22.62%
	CAKE 34
	26CU \$94.87
	15.76%
~~~~~	
	<b>CA &amp; DR</b> 125
	58.29%            \$298.47
	<b>VE &amp; FR</b> 41
	14.56%            \$74.55
~~~~~	
	%+ 3
	\$0.52
	TAX1 \$7.86
	TAX2 \$8.07
	TAX3 \$15.56
	TAX4 \$0.80
	NS2 207
	\$634.83
	%- 0
	\$0.00
	V.CPN 2
	\$7.00
	DISC 2
	\$1.00
~~~~~	

Gross Sale Item Count  
Amount

Customer Count, Amount  
Sales Ratio

Group Name, Item Count  
Sales Ratio, Amount

Percent Charge Count  
Amount

Tax Amount 1

⋮

Net Sale with Tax Item Count  
Amount

Percent Discount on Subtotal Count  
Amount

Vendor Coupon Count  
Amount

Dollar Discount Count  
Amount

TOTAL		All-media Sales
74CU	\$643.63	Customer Count, Amount
CASH		Cash Sales
59CU	\$493.02	Customer Count, Amount
CHECK		Check Sales
3CU	\$37.26	Customer Count, Amount
Chg		Charge Sales
4CU	\$48.34	Customer Count, Amount
MISC		Misc. Sales
1CU	\$4.73	Customer Count, Amount
CPN		Coupon Sales
0CU	\$25.00	Customer Count, Amount
FS TL		Food Stamp Sales
3CU	\$22.63	Customer Count, Amount
R/A	2	Received-on-Account Count
	\$8.00	Amount
PO	1	Paid-Out Count
	\$4.50	Amount
CASH ID	\$477.53	Cash-in-drawer Amount
CHECK ID	7	Check-in-drawer Count
	\$47.70	Amount
MISC ID	2	Misc.-in-drawer Count
	\$5.00	Amount
CPN ID	2	Coupon-in-drawer Count
	\$25.00	Amount
FSID	4	Food Stamp-in-drawer Count
	\$23.63	Amount
FS CG	\$1.00	Food Stamp Change Amount
CORR	1	Item Correct Count
	\$1.50	Amount
VOID	1	Void Count
	\$2.50	Amount
MISC VD	0	Misc. Void Count
	\$0.00	Amount
ALL VD	1	AI Void Count
	\$5.00	Amount
%-	3	Percent Discount on Line Items Count
	\$0.48	Amount
S.CPN	2	Store Coupon Item Count
	\$8.00	Amount
RTN	1	Returned Merchandise Item Count
	\$0.50	Amount
-TAX	\$0.00	Negative Tax Amount
REG-	1	Negative Mode (E) Count
	\$6.78	Total Amount
TRF TL	-9.85	Transfer GT Balance

TRF+ GT	-9.85	Transfer +GT
TRF- GT	\$0.00	Transfer -GT
TRF+	-9.85	Transfer +Daily
TRF-	\$0.00	Transfer -Daily
PB TL		Previous Balance Sales
4CU	\$12.65	Customer Count, Amount
PB R/A	\$22.50	Previous Balance Payments Amount Received
PB PD	\$0.00	Previous Balance Paid Back to Customers
TXBL1	\$126.70	Taxable Total 1 (Sale Amount Portion subject to Tax 1 taxation)
TXBL2	\$180.50	
TXBL3	\$180.90	
TAX EX		Tax Exempted
6CU		Customer Count
TAX1EX	\$39.00	Sale Portion subject to Tax 1 Exemption
TAX2EX	\$51.50	
TAX3EX	\$3.20	
CUR1	3	Foreign Currency 1-in-drawer Count
	\$160.00	Amount
⋮		
JONES		Individual Clerk Reports
GS	188	Gross Sale Item Count
	\$583.20	Amount
NS2	180	Net Sale with Tax Item Count
	\$558.59	Amount
TOTAL		All-media Sales
68CU	\$567.39	Customer Count, Amount
CASH ID	\$411.99	Cash-in-drawer Amount
CHECK ID	6	Check-in-drawer Count
	\$42.00	Amount
MISC ID	2	Misc-in-drawer Count
	\$5.00	Amount
CPN ID	1	Coupon-in-drawer Count
	\$20.00	Amount
FSID	4	Food Stamp-in-drawer Count
	\$23.63	Amount
NEG1	\$24.61	Negative Data 1
NEG2	\$8.00	Negative Data 2
PD	\$4.50	Paid Out Amount
⋮		
COFFEE		Department Name
10.00%	\$13.62	Gross Profit Rate, Amount
CAKE		
20.00%	\$18.97	
TOTAL		Average Grosses Profit Rate,
5.41%	\$32.59	Total Gross Profit Amount
0177 19:30TM		

**ALL PLU READ or RESET REPORT**

**ZONE PLU READ or RESET REPORT**

TEC STORE  
 1343 PEACH DRIVE  
 PHONE: 87-6437

Thank you  
 Call again

11-20-89 #3001

X

0005	TDMATO	
14		\$7.00
0020	ORANGE	
8		\$2.30
0025	MOCHA	
13		\$43.00
0030	SUGAR	
28		\$14.00
TOTAL		
63		\$66.30

0181 19:34TM

Mode Lock :  
 X for read,  
 Z for reset, [PLU]

PLU Code, Name  
 Item Count, Amount

Total Count, Amount

TEC STORE  
 1343 PEACH DRIVE  
 PHONE: 87-6437

Thank you  
 Call again

11-20-89 #3001

X

0005~0020

0005	TDMATO	
14		\$7.00
0020	ORANGE	
8		\$2.30
TOTAL		
22		\$9.30

0182 19:34TM

Mode Lock :  
 X for read,  
 Z for reset,

Zone-start PLU	[@/FOR]	Zone-end PLU
-------------------	---------	-----------------

[PLU]

Zone-start PLU Code  
 ~ Zone-end PLU Code

## HOURLY READ or RESET REPORT

Mode Lock : X for read  
Z for reset,  
10 [AT/TL].

	<b>TEC STORE</b>		
	1343 PEACH DRIVE		
	PHONE: 87-6437		
	Thank you		
	Call again		
	11-20-89 #3001		
	<b>X10</b>		
Up to 8:00 No sales data is recorded.	08:00TM		8:00 to 12:00
	1CU	\$12.50	Customer Count , Sales Amount
12:00 to 15:00 Customer Count,Sales Amount	12:00TM		
	31CU	\$216.44	
	15:00TM		15:00 to 19:00
	38CU	\$361.21	Customer Count, Sales Amount
19:00 to 24:00 Customer Count, Sales Amount	19:00TM		
	4CU	\$44.68	
	0183 19:35TM		

ALL DEPARTMENT READ AND RESET (When selected by the program option)

Mode Lock : X for read  
 Z for reset,  
 11 [AT/TL].

```

TEC STORE
1343 PEACH DRIVE
PHONE: 87-6437

Thank you
          Call again

11-20-89  #3001

          X-11
COFFEE          47
  34CU          $145.70
  21.75%
CAKE            41
  31CU          $112.37
  16.77%
MILK            50
  25CU          $70.00
  10.45%
VEGT.           26
  18CU          $49.35
  7.37%
FRUIT           17
    
```

Department Name, Item Count  
 Customer Count, Amount  
 Sales Ratio

```

CA & DR          138
  56.57%        $328.07
VE & FR           43
  12.99%        $75.34
ME & FI           21
  22.62%        $131.20
OTHERS           12
  7.81%         $45.30
    
```

Group Name, Item Count  
 Sales Ratio, Amount

```

COFFEE
  10.00%        $14.57
CAKE
  20.00%        $22.47
TOTAL
  5.53%         $37.04
    
```

Department Name  
 Gross Profit Rate Amount

Average Gross Profit Rate, Total Gross Profit

0240 19:38TM

## DEPARTMENT GROSS PROFIT READ

Mode Lock : X,  
12 [AT/TL].

```

TEC STORE
1343 PEACH DRIVE
PHONE: 87-6437

Thank you
          Call again

11-20-89  #3001

          X12

COFFEE
  10.00%   $13.62
CAKE
  20.00%   $18.97

TOTAL
   5.41%   $32.59

          0184 19:36TM

```

Department Name

Gross Profit Rate, Amount

Average Gross Profit Rate, Total Gross Profit



## INDIVIDUAL CLERK READ or RESET REPORT

Mode Lock : X for read,  
Z for reset

Set the required clerk Key to  
ON.  
1 [AT/TL]

<b>TEC STORE</b>		
1343 PEACH DRIVE		
PHONE: 87-6437		
Thank you		
Call again		
11-20-89 #3001		
X		
JONES		Clerk Name (or ID)
GS	210	Gross Sale Item Count
	\$652.34	Amount
NS2	202	Net Sale with Tax Item Count
	\$627.73	Amount
TOTAL		All-media Sales
78CU	\$636.53	Customer Count, Amount
CASH ID	\$439.13	Cash-in-drawer Amount
CHECK ID	7	Check-in-drawer Count
	\$44.00	Amount
MISC ID	2	Misc-in-drawer Count
	\$5.00	Amount
CPN ID	2	Coupon-in-drawer Count
	\$28.00	Amount
FSID	8	Food Stamp-in-drawer Count
	\$55.63	Amount
NEG1	\$24.61	Negative Data 1
NEG2	\$8.00	Negative Data 2
PO	\$4.50	Paid Out Amount
JONES	0241 19:39TH	

MEDIA-IN-DRAWER READ REPORT

Mode Lock :X  
[#] (or[#/CID], [#NS])

TEC STORE  
 1343 PEACH DRIVE  
 PHONE: 87-6437

Thank you  
 Call again

11-20-89 #3001

X

TOTAL			All-media Sales
74CU	\$643.63		Customer Count, Amount
CASH ID	\$477.53		Cash-in-drawer Amount
CHECK ID	7		Check-in-drawer Count
	\$47.70		Amount
MISC ID	2		Misc.-in-drawer Count
	\$5.00		Amount
CPN ID	2		Coupon-in-drawer Count
	\$25.00		Amount
FSID	4		Food Stamp-in-drawer Count
	\$23.63		Amount
CUR1	3		Foreign Currency 1-in-drawer Count
	\$160.00		Amount
CUR2	0		
	\$0.00		
CUR3	0		
	\$0.00		

0187 19:46TM

All-media Sales  
 Customer Count, Amount  
 Cash-in-drawer Amount  
 Check-in-drawer Count  
 Amount  
 Misc.-in-drawer Count  
 Amount  
 Coupon-in-drawer Count  
 Amount  
 Food Stamp-in-drawer Count  
 Amount  
 Foreign Currency 1-in-drawer Count  
 Amount

**FINANCIAL GT READ or RESET REPORT**

Mode Lock : X for read,  
Z for reset,  
20 [AT/TL]

```

TEC STORE
1343 PEACH DRIVE
PHONE: 87-6437

Thank you
      Call again

11-20-89  #3001

      GTX

GT
      $662.59
GS
      215
      $662.59
COFFEE
      43
      30CU
      $136.20
      22.62%
CAKE
      34
      26CU
      $94.87
      15.76%
-----
SMITH
GS
      27
      $79.39
NS2
      27
      $76.24
TOTAL
      6CU
      $76.24
NEB1
      $3.15
NEB2
      $0.00
PD
      $0.00

COFFEE
      10.00%
      $13.62
CAKE
      20.00%
      $18.97

TOTAL
      5.41%
      $32.59

0185 19:37TM
    
```

As for other GT reports, refer to the TABLE OF X AND Z REPORTS.  
In GT reports, the contents and print formats are the same as their corresponding daily reports, except that report header is changing.

← GT Reset Report Count (Print on RESET report)

## 4.PROGRAMMING OPERATIONS

This chapter is provided for the store programmer or the store manager who may have to change the programmed data of the MA-1400 series ECR on a daily, weekly, or monthly basis. Usually, all the basic program data required for your store should be set before delivering the product by your local TEC representative. However, to change or add program data, please refer to this chapter.

### TABLE OF PROGRAMMING CONTENTS

	(Page)
-- BASIC KEY FUNCTIONS AND KEYBOARD VARIATIONS IN PROGRAMMING OPERATIONS-- .....	17
-- CHARACTER ENTRIES -- .....	18
STORE NAME/MESSAGE AND COMMERCIAL MESSAGE PROGRAMMING .....	24
CLERK NAME PROGRAMMING .....	27
PLU TABLE PROGRAMMING OR CHANGING .....	28
TIME SETTING OR ADJUSTMENT .....	30
DATE SETTING OR ADJUSTMENT .....	30
PLU PRESET-CODE KEY SETTING .....	31
DEPARTMENT PRESET PRICE SETTING OR CHANGING .....	33
PLU PRESET PRICE CHANGING .....	34
% + AND %- PRESET RATE SETTING .....	35
LISTING CAPACITY SETTING FOR TENDER MEDIAS .....	36
FOREIGN CURRENCY EXCHANGE RATE SETTING .....	37

## Single-Item Department or Single-Item PLU

If a department (or PLU) is programmed as Single-item, the department (or PLU) entry sequence will immediately finalized the sale as cash sale when outside a sale.

### OPERATION

Same as	Department Entry PLU Entry Quantity Extension Split Package Pricing
---------	------------------------------------------------------------------------------

-- Receipt Print Sample --

**TEC STORE**  
 1343 PEACH DRIVE  
 PHONE: 87-6437

Thank you  
                     Call again

11-20-89    #3001

DP*08       \$3.00  
 CASH       \$3.00

JONES    0070 13:59TM

### Returned Merchandise

**OPERATION**

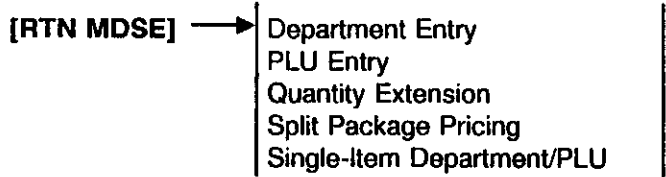

**NOTE :** The [RTN MDSE] key can be used outside as well as inside a sale.

-- Receipt Print Sample --

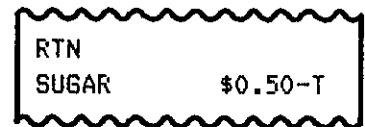

### Percent Discount, Percent Charge

**OPERATION**

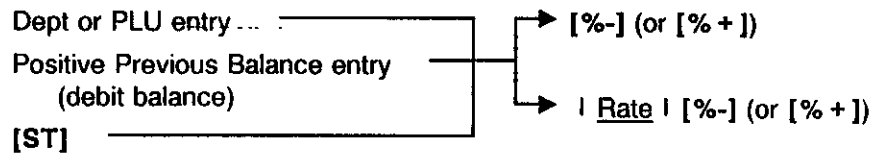

- NOTES :**
1. Rate ..... 0.001 to 99.999 (%).
  2. When the Dept or PLU item entry is modified with [RTN MDSE] or [VOID], the following % entry will also be modified with [RTN MDSE] or [VOID].
  3. Usually a % key operation after [ST] is once obtained is allowed only once. However, it may be programmed to allow more than once.

-- Receipt Print Sample --

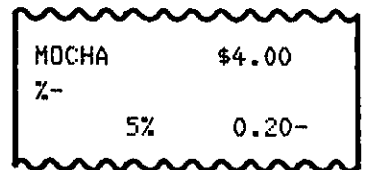

## Vendor Coupon

OPERATION

| Coupon Amount | [VND CPN]

**NOTE :** *The coupon amount to be entered must not exceed the sale total unless the "Credit Balance" option is selected.*

-- Receipt Print Sample --

V. CPN	4.00-
--------	-------

## Store Coupon

OPERATION

[STR CPN] → Follow | Department Entry  
| Quantity Extension for Depts |

**NOTE :** *The store coupon amount to be entered must not exceed the sale total unless the "Credit Balance" option is selected.*

-- Receipt Print Sample --

S. CPN	
BOOK	\$5.00-

### Amount Discount

**OPERATION**

! Amount to be discounted ! [ - ]

**NOTE :** An amount exceeding the sale total cannot be entered unless the "Credit Balance" option is selected.

-- Receipt Print Sample --



### Item Correct

**OPERATION**

- Department Entry
  - PLU Entry
  - Repeat Entry
  - Quantity Extension
  - Split Package Pricing
  - Percent Discount/Charge
  - Store Coupon
  - Vendor Coupon
  - Previous Balance
  - Received-on-Account
  - Paid-Out
  - Manual Tax Entry
- [ITEM CORR]

- NOTES :**
1. When [ITEM CORR] is depressed after a Repeat Entry, only the last item of those repeated will be deleted.
  2. When [ITEM CORR] is depressed after a Quantity Extension, the entire product (result of multiplication) will be deleted. The same is applied to the Split Package Pricing sequence.

-- Receipt Print Sample --

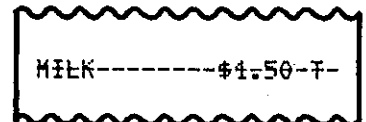



**Void**

OPERATION

[VOID] → Department Entry  
 PLU Entry  
 Quantity Extension  
 Split Package Pricing

**NOTE :** *An amount exceeding the sale total cannot be entered unless the "Credit Balance" option is selected.*

-- Receipt Print Sample --

COFFEE	\$2.50
CAKE	\$2.50 T
VOID	
COFFEE	\$2.50-

**All Void (Cancel)**

OPERATION

[ALL VOID] → [ITEM CORR]

-- Receipt Print Sample --

<b>TEC STORE</b>	
1343 PEACH DRIVE	
PHONE: 87-6437	
Thank you	
Call again	
11-20-89	#3001
COFFEE	\$2.50
CAKE	\$2.50 T
SUBTL	\$5.00
*ALL VD *	
JONES	0078 14:29TH

- NOTES :**
1. Pressing the [ALL VOID] key, followed by the [C] key will result in all void cancellation.
  2. It is inoperable if 21 items or more are entered.

## Non-add Number Print

Non-add numbers can be entered and printed for future references, to indicate codes or numbers of customers, media checks, credit cards, etc. The entered numbers do not affect any sale total data.



| **Number** | **[#]**  
 Max. 8 digits. (or **[#/NS]**)

- NOTES :**
1. *It is programmable whether a No-sale operation is allowed after a Non-add Number entry.*
  2. *It is also programmable whether Non-add Number can only be entered once or any number of times within a transaction.*

-- Receipt Print Sample --

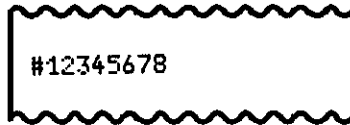

## Listing Capacity Open

Depress **[LC OPEN]** (or **[OPEN]**) prior to or any time during an entry of a department or PLU sequence (including Repeat and Quantity Extension entries). Please note that the **[LC OPEN]** (or **[OPEN]**) key must be pressed, at latest, before the final key of the entry sequence. The HALC (High Amount Listing Capacity) for the department or PLU will be extended with two higher digits.

## Tax Status Modification, Food Stamp Status Modification

Depress **[TX/M]** (**[TX1/M]**, **[TX2/M]** or **[TX3/M]**) in the same way as **[LC OPEN]** is operated, prior to or any time during the entry sequence of the required Department, PLU, or any tax-status-programmable item. The taxable status is reversed to non-taxable, and vice versa. The **[FS/M]** key operates the same to reverse from the food stampable status to non-stampable, and vice versa, of the required item.

### Using PK-2 (PLU Keyboard; hardware option)

The PK-2 (hardware option PLU Keyboard) is used to enter the required PLU Code by simply depress the PLU Preset-code Key on the PK-2 keyboard in the "REG", "MGR", or "☐" mode. In addition, the PK-2 can be used to enter characters directly during the programming operations that require character settings, such as STORE NAME/MESSAGE AND COMMERCIAL MESSAGE PROGRAMMING, DEPARTMENT TABLE PROGRAMMING OR CHANGING, etc.

The figure below shows the key indications of the PK-2 keyboard. (A sheet of these character indications is attached to the PK-2 unit. Insert it between the film layers that cover the PK-2 keyboard for using the keyboard for this purpose.)

Instead of entering a 2- or 3 digit character code and depressing the [#] key on the ECR keyboard, a simple depression of the appropriate key on the PK-2 keyboard will be the character entry.

Unlike the TKB-1, all the function keys, such as [ @/FOR ], [ ST ], [ # ], [ AT/TL ], etc. must be operated on the ECR side. Any characters not listed on the template may be entered by the CHARACTER CODE ENTRY method on the ECR keyboard (the characters even listed on the template may be entered as well by that method).

Please note also that the keys "0" to "9" in the figure below function as character keys but do not function for code entries. Any code entries, for Item Codes, Address Nos, etc. must be entered through the Numeric Keys on the ECR keyboard.

The One Double-size Declaration (by depressing the [ @/FOR ] key once prior to the required character) and the All Double-sized Declaration (by depressing [ @/FOR ] twice before all the characters) are the same as in the CHARACTER CODE ENTRY method.

1	11	21	31	41	51	61	71	81	91	7 101	8 111	9 121
2	12	22	32	42	52	62	72	82	92	4 102	5 112	6 122
3	13	23	33	43	53	63	73	83	93	1 103	2 113	3 123
!	@	#	\$	%		&	×	(	)		0 114	
4	14	24	34	44	54	64	74	84	94	104	114	124
q	w	e	r	t	y	u	i	o	p	~		
5	15	25	35	45	55	65	75	85	95	105	115	125
a	s	d	f	g	h	j	k	l	"		+	
6	16	26	36	46	56	66	76	86	96	106	116	126
z	x	c	v	b	n	m			'	-	=	
7	17	27	37	47	57	67	77	87	97	107	117	127
Q	W	E	R	T	Y	U	I	O	P	[	]	
8	18	28	38	48	58	68	78	88	98	108	118	128
A	S	D	F	G	H	J	K	L	;	:	'	
9	19	29	39	49	59	69	79	89	99	109	119	129
Z	X	C	V	B	N	M	SPACE	.	/	?		
10	20	30	40	50	60	70	80	90	100	110	120	130

## STORE NAME /MESSAGE AND COMMERCIAL MESSAGE PROGRAMMING OR CHANGING (Submode No. 1)

**CONDITION** Any time outside a sale

**OPERATION** Mode Lock: SET

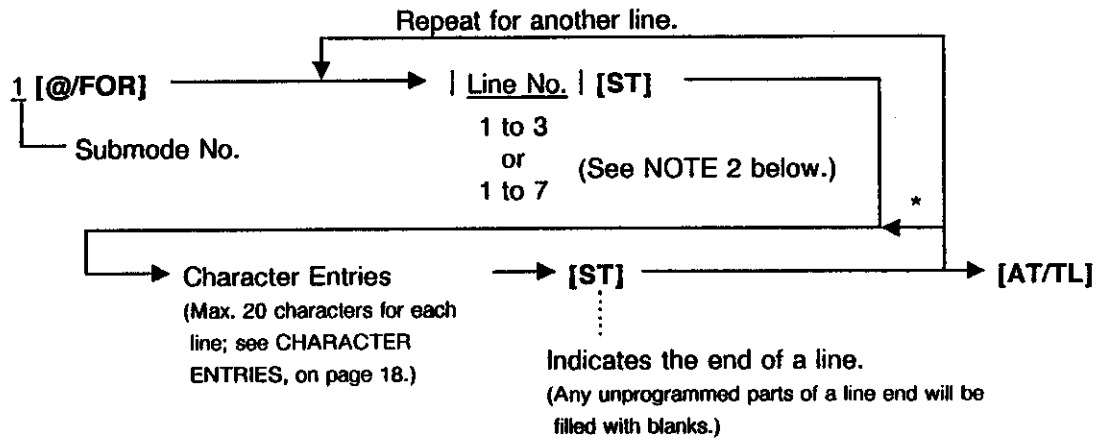

* For sequentially programming lines, the line number specification can be skipped.

- NOTES:**
- For each line, a maximum of 20 regular-sized characters or 10 double-sized characters may be entered. A combination of both types is also available.
  - If the option "Store Name Print by RUBBER STAMP" is selected, no data can be programmed for the store name/message. Therefore, enter 1 to 3 as Line No. for the commercial message data only.  
If the option "Store Name Print by DOT PRINTER" is selected, use 1 through 4 for the store name/message and 5 through 7 for the commercial message data, as Line No.
  - If no commercial message is required on the receipt, program blanks for all three lines. As a result no extra lines will be fed. If any one of the three lines is programmed, the two other lines will cause line feeds.
  - The 4-line range assigned for the store name/message will be either printed or fed, as long as the option "Store Name print by DOT PRINTER" is selected.
  - If any incorrect characters have been programmed, depress the [C] key to clear all the characters on a line and then re-enter characters from the beginning, or end the line with an [ST] and re-program the entire line. The new data will be active.
  - When all the lines have been programmed, do a check by issuing a receipt. Only the lines with errors need to be re-programmed; other lines will not be affected.

ex.) To program the following draft as the Store Name/Message and Commercial Message  
(under the "Store Name by DOT PRINTER" option):

DRAFT:

T	E	C			S	T	O	R	E							Line No. 1					
		1	2	3	4			P	E	A	C	H		D	R	I	V	E	Line No. 2		
				P	H	O	N	E	:		8	7	-	6	4	3	7			Line No. 3	
																				Line No. 4	
T	h	a	n	k		y	o	u												Line No. 5	
											C	a	i	i		a	g	a	i	n	Line No. 6
																					Line No. 7

**OPERATION:** Presumed that nothing has been programmed on each line.

Mode Lock to **SET**, enter 1, depress [**@/FOR**].

(The example below uses the CHARACTER CODE ENTRY method; the DIRECT CHARACTER ENTRY method will be easier if you have PLU KEYBOARD (PK-2), and PROGRAMMING KEYBOARD (TKB-1.)

1 [ST] (Line No. 1)

[#] (space)  
 [X] 30 [#] (T)  
 [X] 15 [#] (E)  
 [X] 13 [#] (C)  
 [#] (space)  
 [#] (space)  
 [X] 29 [#] (S)  
 [X] 30 [#] (T)  
 [X] 25 [#] (O)  
 [X] 28 [#] (R)  
 [X] 15 [#] (E)  
 [ST]

2 [ST] (Line No. 2)

[#] (space)  
 [#] (space)  
 01 [#] (1)  
 03 [#] (3)  
 04 [#] (4)  
 03 [#] (3)  
 [#] (space)  
 26 [#] (P)  
 15 [#] (E)  
 11 [#] (A)  
 13 [#] (C)  
 18 [#] (H)  
 [#] (space)  
 14 [#] (D)  
 28 [#] (R)  
 19 [#] (I)  
 32 [#] (V)  
 15 [#] (E)  
 [ST]

3 [ST] (Line No.)

[#] three times (space)  
 26 [#] (P)  
 18 [#] (H)  
 25 [#] (O)  
 24 [#] (N)  
 15 [#] (E)  
 102 [#] (:)  
 [#] (space)  
 08 [#] (8)  
 07 [#] (7)  
 99 [#] (-)  
 06 [#] (6)  
 04 [#] (4)  
 03 [#] (3)  
 07 [#] (7)

[ST]

5 [ST] (Line No.)

30 [#] (T)  
 118 [#] (h)  
 111 [#] (a)  
 124 [#] (n)  
 121 [#] (k)  
 [#] (space)  
 135 [#] (y)  
 125 [#] (o)  
 131 [#] (u)

[ST]

6 [ST] (Line No.)

[#] ten times (space)  
 13 [#] (C)  
 111 [#] (a)

122 [#] (l)  
 122 [#] (l)  
 [#] (space)  
 111 [#] (a)  
 117 [#] (g)  
 111 [#] (a)  
 119 [#] (i)  
 124 [#] (n)

[ST]

[AT/TL]

	00-00-00	#0
		FO-1
1		TEC STORE
2		1343 PEACH DRIVE
3		PHONE: 87-6437
5		Thank you
6		Call again
		0007 14:43TM

## CLERK NAME PROGRAMMING (Submode No. 2)

### ■ Programming

**CONDITION** Any time outside a sale

**OPERATION** Mode Lock: **SET**

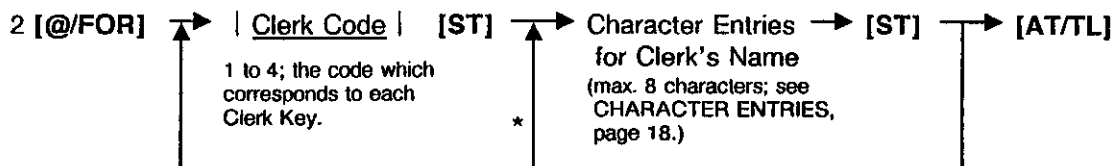

Repeat for another clerk code and name setting.

* ( When the code is sequential from the previous-set code, the Clerk Code entry may be skipped.)

- NOTES:**
1. For the name of each clerk, a maximum of 8 regular-sized or 4 double-sized characters may be entered. A combination of both types is also available.
  2. The programmed name will be printed on each receipt issued by the clerk. If no name is programmed for the clerk, the clerk ID code, such as "1CL" "2CL", etc. will be printed instead.
  3. On the validation slips, the clerk ID code (instead of the name) will be printed regardless of the name programmed here.

ex.) To program Clerk Code 1 with name "JONES",  
Clerk Code 2 with name "SMITH":

Mode Lock to **SET**, Enter 2, depress [**@/FOR**].

Enter 1, depress [**ST**] (Clerk Code)

Enter 20, depress [**#**] (J)

Enter 25, depress [**#**] (O)

Enter 24, depress [**#**] (N)

Enter 15, depress [**#**] (E)

Enter 29, depress [**#**] (S)

Depress [**ST**] (to end Clerk 1)

Enter 2, depress [**ST**] (Clerk Code)

Enter 29, depress [**#**] (S)

Enter 23, depress [**#**] (M)

Enter 19, depress [**#**] (I)

Enter 30, depress [**#**] (T)

Enter 18, depress [**#**] (H)

Depress [**ST**] (to end Clerk 2)

Depress [**AT/TL**] to end this program.

<b>TEC STORE</b>	
1343 PEACH DRIVE	
PHONE: 87-6437	
Thank you	
Call again	
00-00-00 #0	
<b>P02</b>	
1CL	JONES
2CL	SMITH
0008 14:52TM	

## PLU TABLE PROGRAMMING OR CHANGING (Submode No. 4)

### CONDITION

To program new PLUs : ] Any time outside a sale.  
 To change any programmed contents of PLUs (except the following case):

To change programmed contents of PLUs with sales data not zero. ] After PLU Reset.

### OPERATION

Mode Lock : SET

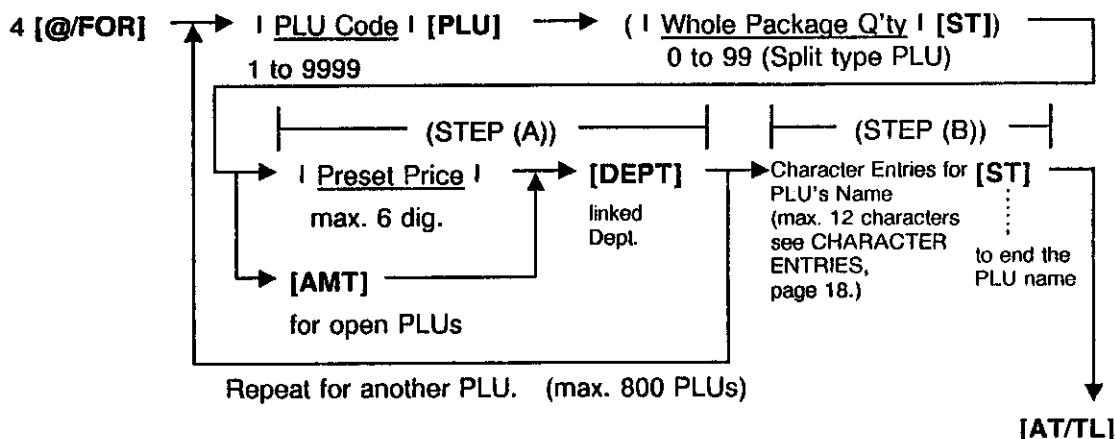

- * ' [ PLU Code ] [ PLU ]' entry may be skipped if the PLU Code is sequential from that of the PLU just set.  
 If this PLU code entry is skipped at very first PLU, the PLU code will automatically programmed as PLU No. 1.

- NOTES :**
- 1) The Positive/Negative, Single-item/Itemized, Taxable/Non-taxable, Food Stampable/Non-Food-Stampable status are determined by those of the department to which each PLU is linked.
  - 2) STEP (A) may be omitted if only the PLU name is set or changed. Likewise, STEP (B) may be omitted if the PLU name is not set or changed.
  - 3) If no name is set for a PLU, the PLU Code (such as "PLU 0001") will be printed as the PLU name on sales receipts.
  - 4) An error results at entry time if the linked department is an other income department.



ex.) To program the following PLUs :

PLU Code	Preset Price	Linked DP	Name	Q'ty Package
PLU 5	\$1.50	03	PLU005	3
PLU 20	\$2.00	02	PLU020	7
PLU 25	open	01	PLU025	
PLU 30	\$0.50	03	SUGAR	

Mode Lock to **SET**, enter 4, depress [**@/FOR**].

5 [PLU] 3 [ST]  
 150 [DEPT 3]  
  
 20 [PLU] 7 [ST]  
 200 [DEPT 2]  
  
 25 [PLU]  
 [AMT] [DEPT 1]  
  
 30 [PLU]  
 50 [DEPT 1]  
 29 [#] (S) 31 [#] (U) 17 [#] (G)  
 11 [#] (A) 28 [#] (R)

Depress [**ST**] (to end the name setting)  
 [**AT/TL**] to end this program.

```

TEC STORE
1343 PEACH DRIVE
PHONE: 87-6437

Thank you
    Call again

00-00-00  #0

          F04
PLU005 03 1.50/ 3
PLU020 02 2.00/ 7
PLU025 01
PLU030 01 0.50
PLU030 SUGAR

004

0012 14:59TM
    
```

### PLU TABLE DELETION

- CONDITION** Anytime outside a sale
- OPERATION** Mode Lock : **SET**

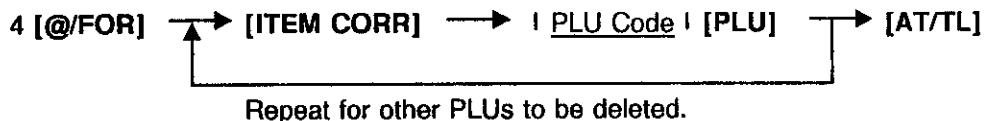

ex.) To delete PLU No. 20 once set in the above programming operation :

Mode Lock to **SET**, enter 4, depress [**@/FOR**]  
 Depress [**ITEM CORR**], enter 20, depress [**PLU**].  
 Depress [**AT/TL**] to end this program.

```

00-00-00  #0

          F04
PLU020
-----
003

0013 15:01TM
    
```

## TIME SETTING OR ADJUSTMENT (Submode 5)

**CONDITION** Any time outside a sale

**OPERATION** Mode Lock : SET

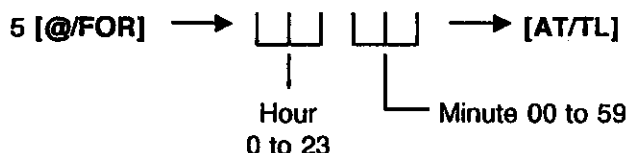

- NOTES :**
- 1) "If an hour value of more than 23 or a minute value of more than 59 is entered, no errors will result. However, in this case, set the time again with correct values.
  - 2) The date will not be changed by setting or adjusting the time.

ex.) To set the time to "10:58"(10:58 a.m.)

Mode Lock to SET, enter 5, depress [ @/FOR ]  
Enter 1 0 5 8 , depress [ AT/TL ].

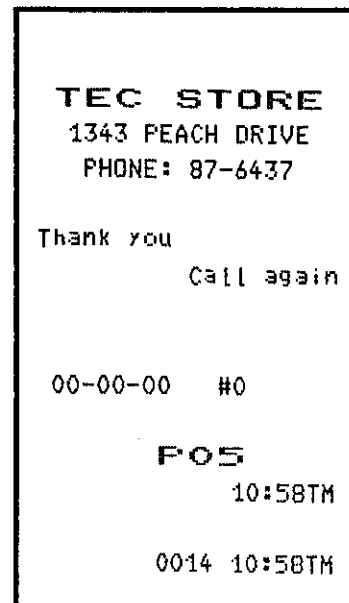

## DATE SETTING OR ADJUSTMENT (Submode 6)

**CONDITION** Any time outside a sale

**OPERATION** Mode Lock : SET

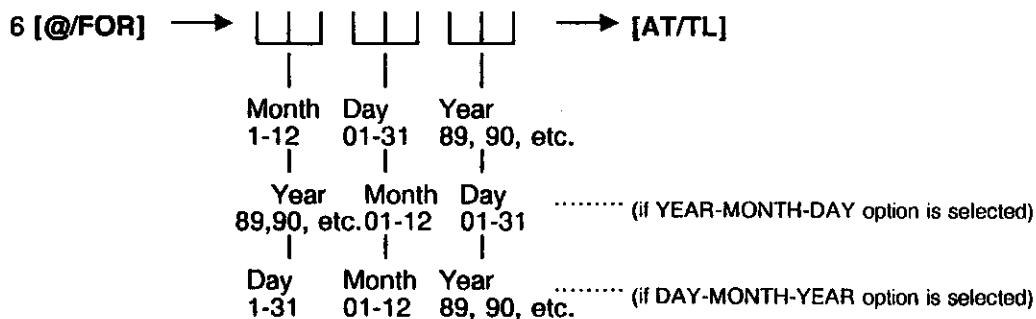

ex.) To set the date to "November 20 1989":

Mode Lock to SET, enter 6, depress [ @/FOR ]  
Enter 1 1 2 0 8 9, depress [ AT/TL ].

**NOTE :** The extra day of a leap year is also computed automatically by the clock circuitry.

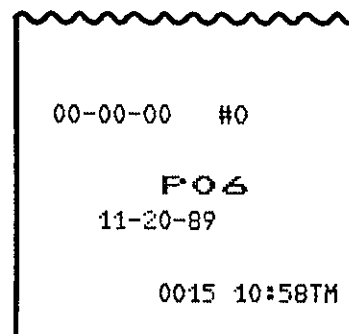

## PLU PRESET-CODE KEY SETTING (Submode 27)

When there are any keys programmed as PLU Preset-code Keys on the ECR Keyboard, and/or when the PLU Keyboard PK-2 (hardware option) is connected to the ECR, a PLU code may be preset to each of those keys in this operation.

- CONDITION** Any time outside a sale
- OPERATION** Mode Lock : SET

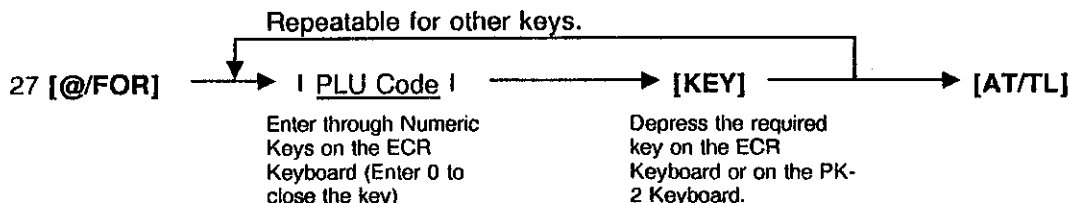

- NOTES :**
1. If the PLU Code entry is skipped and a [KEY] is simply depressed in the above sequence, the preprogrammed PLU Code of the KEY will be displayed.
  2. A non-opened PLU Code (i.e. PLU non-existent in the PLU table file) can be set on a KEY; however, pressing the KEY in sale entries will result in an error unless the code is opened in the PLU TABLE PROGRAMMING operation, Submode 4.
  3. If "0" is entered as PLU Code in the above sequence, the KEY will be closed. Pressing the closed KEY in sale entry will cause an error.

ex) To set the following PLU Codes to the following KEYS on the ECR keyboard and/or on the PLU Keyboard respectively :

Mode Lock to SET.		27 [ @/FOR ]		<p style="text-align: center;"><b>TEC STORE</b> 1343 PEACH DRIVE PHONE: 87-6437</p> <p>Thank you <span style="float: right;">Call again</span></p> <p>11-20-89 #0</p> <p style="text-align: center;"><b>F27</b></p> <p>#059 0005 #092 0020</p> <p style="text-align: right;">0026 11:18TH</p>
<u>PLU Code</u>	(Enter through Numeric Keys on ECR Keyboard)	(Depress the required KEY on ECR or PLU Keyboard)		
5	5	[required key]		
20	20	[required key]		
	[AT/TL]			

Location Code (left side); refer to REMARKS 1 and 2 on the next page.  
PLU Code assigned to the key (right side)

PK-2 KEYBOARD

1	11	21	31	41	51	61	71	81	91	101	111	121
2	12	22	32	42	52	62	72	82	92	102	112	122
3	13	23	33	43	53	63	73	83	93	103	113	123
4	14	24	34	44	54	64	74	84	94	104	114	124
5	15	25	35	45	55	65	75	85	95	105	115	125
6	16	26	36	46	56	66	76	86	96	106	116	126
7	17	27	37	47	57	67	77	87	97	107	117	127
8	18	28	38	48	58	68	78	88	98	108	118	128
9	19	29	39	49	59	69	79	89	99	109	119	129
10	20	30	40	50	60	70	80	90	100	110	120	130

**REMARKS 1.** *The Nos 1 through 130 marked on the PK-2 Keyboard are the KEY Nos to be printed on the left side of the program receipt issued in the operation on the preceding page. If each KEY is not set with a PLU Code, the auto-preset PLU Code identical to the initial KEY No. in the above figure will be active as its preset PLU Code*

*ex.) KEY No.1 ... PLU Code 1  
KEY No.130... PLU Code 130*

2. *When a PLU code is assigned to a PLU Preset-code Key on the ECR Keyboard in the operation on the preceding page, the Hardware Key Code which indicates the absolute location of the key will be printed to the left of the assigned PLU Code. Since it is hard to explain which location code corresponds to each key (due to an irregular numbering), it is suggested to verify the positioning by simply depressing the KEY and reading the code in the display (described in NOTE 1 on the preceding page). This reading operation is applied to the PK-2 Keyboard as well.*

## DEPARTMENT PRESET PRICE SETTING OR CHANGING

**CONDITION** Any time outside a sale

**OPERATION** Mode Lock : SET

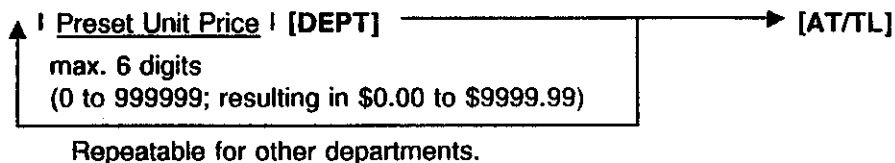

**NOTE :** When the "Preset Unit Price" is skipped and only the [DEPT] key is depressed in the above operation sequence, the department will be an open-price department (i.e. amount entry is always required before the [DEPT] key.)

ex.) To set Preset Unit Price \$2.50 to Dept. 2, and \$1.40 to Dept. 3:

Mode Lock to **SET**,  
Enter 250, depress [DEPT 2].  
Enter 140, depress [DEPT 3].  
[AT/TL] to end.

```

TEC STORE
1343 PEACH DRIVE
PHONE: 87-6437

Thank you
      Call again

11-20-89  #3001

      P O O
02 DF02      2.50
03 DF03      1.40

      0052 12:35TH
  
```

ex.) To reset the Preset Unit Price (\$1.40) of Dept. 3 that was once set (i.e. to change it into an open-price department) :

Mode Lock to **SET**,  
Simply depress [DEPT 3].  
[AT/TL] to end.

```

11-20-89  #3001

      P O O
03 DF03

      0053 12:36TH
  
```

## PLU PRESET PRICE CHANGING

**CONDITION** Any time outside a sale

**OPERATION** Mode Lock : SET

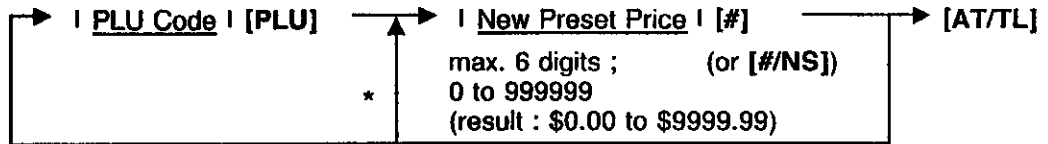

Repeatable for another PLU.

(* Repeatable from here if the PLU Code is sequential.)

- NOTES :** 1) Entering 0 (zero) as New Preset Price will preset the price of \$0.00.  
 2) In this operation, changes of the linked department or programming additional PLUs are not possible.

ex.) To change the preset price of PLU No. 5 (previously programmed with \$1.00 as the preset price) to the new price of \$0.75 :

Mode Lock to **SET**,

Enter 5, depress **[PLU]**.

Enter 75, depress **[#]**.

Depress **[AT/TL]** to end this program.

```

TEC STORE
1343 PEACH DRIVE
PHONE: 87-6437

Thank you
      Call again

11-20-89  #3001

      P O O
PLU005 03 0.75/ 3
      PLU005

      0028 11:20TM
  
```

## % + AND %- PRESET RATE SETTING

A preset rate may be set on each of the [% +] and [%-] key, one independent rate for each key . Once a rate is preset, the % key only will be depressed without a prior rate entry to activate the preset rate. If a rate is entered prior to the depression of the key, the entered rate (manual rate) will be activated instead.

**CONDITION** Any time outside a sale

**OPERATION** Mode Lock : SET

| Preset % Rate | [% +] (For Percent Charge  
Preset Rate)

(0.001 to 99.999(%)) ; use the [ . ] key if a  
decimal portion is contained.)

| Preset % Rate | [%-] (For Percent Discount  
Preset Rate)

ex.) To set 10% on [% +] Key :

Mode Lock to SET, enter 10, depress [% +].

ex.) To set 5% on [%-] Key :

Mode Lock to SET, enter 5, depress [%-].

To reset the rate once set :

Mode Lock : SET,  
Enter 0, depress the required % key.

(Then the % key will always require a  
manual rate entry in sales entries.)

**NOTE :** When two [% +] Keys or [%-] keys are  
installed on keyboard, two different % rates  
(one for each) may be preset, in the same  
manner as described above.

<p><b>TEC STORE</b> 1343 PEACH DRIVE PHONE: 87-6437</p>	
<p>Thank you Call again</p>	
T	11-20-89 #3001
<p><b>FOO</b></p>	
Th: %+	10%
<p>0029 11:20TH</p>	
<p>11-20-89 #3001</p>	
<p><b>FOO</b></p>	
%-	5%
<p>0030 11:21TH</p>	

# LISTING CAPACITY SETTING FOR TENDER MEDIAS

**CONDITION** After Financial Daily Reset

**OPERATION** Mode Lock : SET

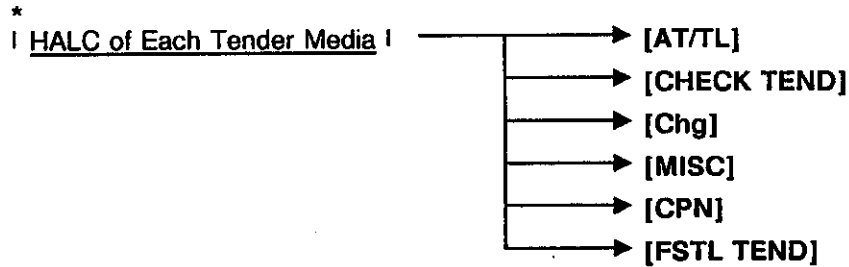

* HALC ..... High Amount Listing Capacity (to be set in a 2-digit code)

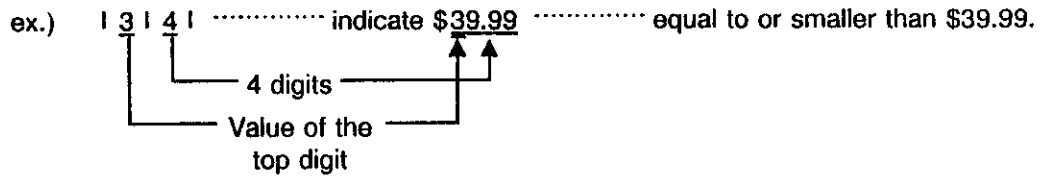

- NOTES :**
- 1) To reset an individual media listing capacity, enter 0 before media key depression in the above operation.
  - 2) The HALC of each tender media is effective only when the media key is used for tendering but not when it is used as Total key.
  - 3) The listing capacity is cleared in "MGR" mode. It cannot be cleared by the [LC OPEN] (or [OPEN]) key.

ex.) To set HALCs as in the following :

<u>Table</u>	<u>Key Operation</u>
\$99.99 [AT/TL]	Mode Lock to SET. Enter 94, depress [AT/TL].
\$999.99 [CHECK TEND]	Enter 95, depress [CHECK TEND].

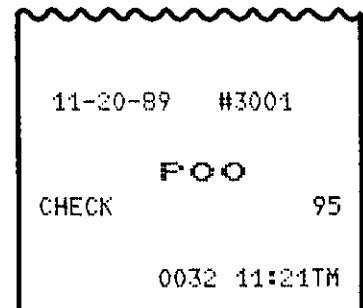
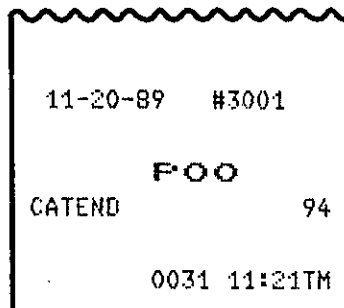



## FOREIGN CURRENCY EXCHANGE RATE SETTING

In this program, the rate of each foreign currencies (corresponding to the [CUR1] to [CUR4] keys) will be set. By setting a rate on each Foreign Currency Key, reading the sale total and tendering in the foreign currency value will be possible for sale finalization.

**CONDITION** Any time outside a sale

**OPERATION** Mode Lock : SET

| Exchange Rate for Foreign Currency 1 | → [CUR 1]

0.000001 to 9999.999999

(Use the [ . ] key if decimal portion is contained in the rate.)

⋮

| Exchange Rate for Foreign Currency 4 | → [CUR 4]

As for how to calculate the Exchange Rate, see the description below.

### Foreign Currency Exchange Rate Calculation

1. The rate must be calculated in the subsidiary currency unit values for both the domestic and the foreign currencies. (In case of calculating the rate from the domestic to a foreign currency with the same zero-suppress form, such as from U.S. \$ to French Franc, it will be no problem even if it is calculated in the main currency of \$ and Franc. However, in case of exchanging from a domestic currency such as \$ or Franc to Japanese yen or Italian Lira, or vice versa, this rule must be obeyed; otherwise a wrong rate will result.)
2. Calculate the required foreign currency value equivalent to the domestic currency value "1". Then the obtained value is the Exchange Rate value to be entered in the setting operation stated above.

For example, if the domestic currency is U.S. \$:

1¢ = xxxx.xxxxxx centimes (French Franc)

= xxxx.xxxxxx pfennigs (Deutsche Mark)

= xxxx.xxxxxx yen (Japanese yen)

etc.

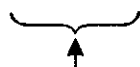

Enter this value as each foreign currency rate.

ex.) To set three foreign currency rates:

Domestic Currency ..... U.S. \$  
 Assigning: [CUR 1] ..... French Franc  
 [CUR 2] ..... Deutsche Mark  
 [CUR 3] ..... Japanese yen

Conditions given for Domestic and Foreign Currencies  
 (The rates here are merely examples.)

(DOMESTIC)	(CUR 1)	(CUR 2)	(CUR 3)
U.S. dollar	French Franc	Deutsche Mark	Japanese yen
↓	↓	↓	↓
\$1.00	= Fr 5.3729	= DM1.7619	= (145.50) ..... in Main Currency Values
↓	↓	↓	↓
1 cent	= 5.3729 Centimes	= 1.7619 pfennigs	= 1.4550 ..... in Subsidiary Currency Values (Enter these values for setting.)

KEY OPERATION for setting the rates above

Mode Lock to **SET**.

- 5 [ . ] 3729 [CUR1] (for French Franc)
- 1 [ . ] 7619 [CUR2] (for Deutsche Mark)
- 1 [ . ] 4550 [CUR3] (for Japanese yen)

■ **Resetting a Foreign Currency Rate Once Set :**

Enter "0" in place of the Exchange Rate for the Foreign Currency in the setting operation. Then the rate for that foreign currency will be reset. The Foreign Currency Key of the rate thus reset cannot be used in sales entries.

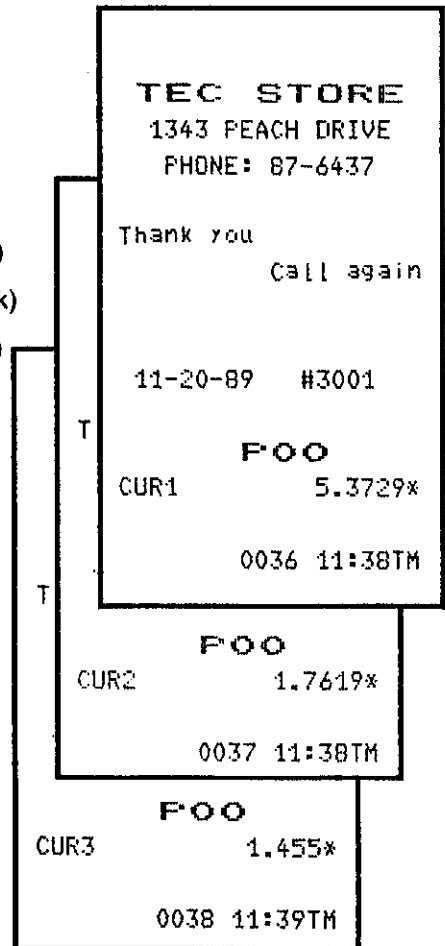

# 5. VERIFICATION OF PROGRAMMED DATA

The programmed data entered in the previous "SET" mode operations may be read for verification purposes.

**CONDITION** Any time outside a sale.

**OPERATION** Mode Lock : X

Follow the operation for each reading below:

(READ CONTENTS)	(KEY OPERATION)	(SAMPLE PAGE)
DEPARTMENT PRESET PRICE READ ..	1 [ST] .....	40
DEPARTMENT STATUS AND LC READ .	2 [ST] .....	40
PLU TABLE READ .....	3 [ST] .....	41
OTHER PROGRAM DATA READ .....	4 [ST] .....	41
USER SYSTEM OPTION READ .....	5 [ST] .....	42
DEPARTMENT GROSS PROFIT RATE READ .....	6 [ST] .....	42
TAX CALCULATION TEST .....	<u>Entry any amount</u>   [TXBL TL] (or [TX1/M]) .....	42

DEPARTMENT PRESET PRICE READ  
(Mode Lock : X, 1 [ST])

DEPARTMENT STATUS AND LC READ  
(Mode Lock : X, 2 [ST])

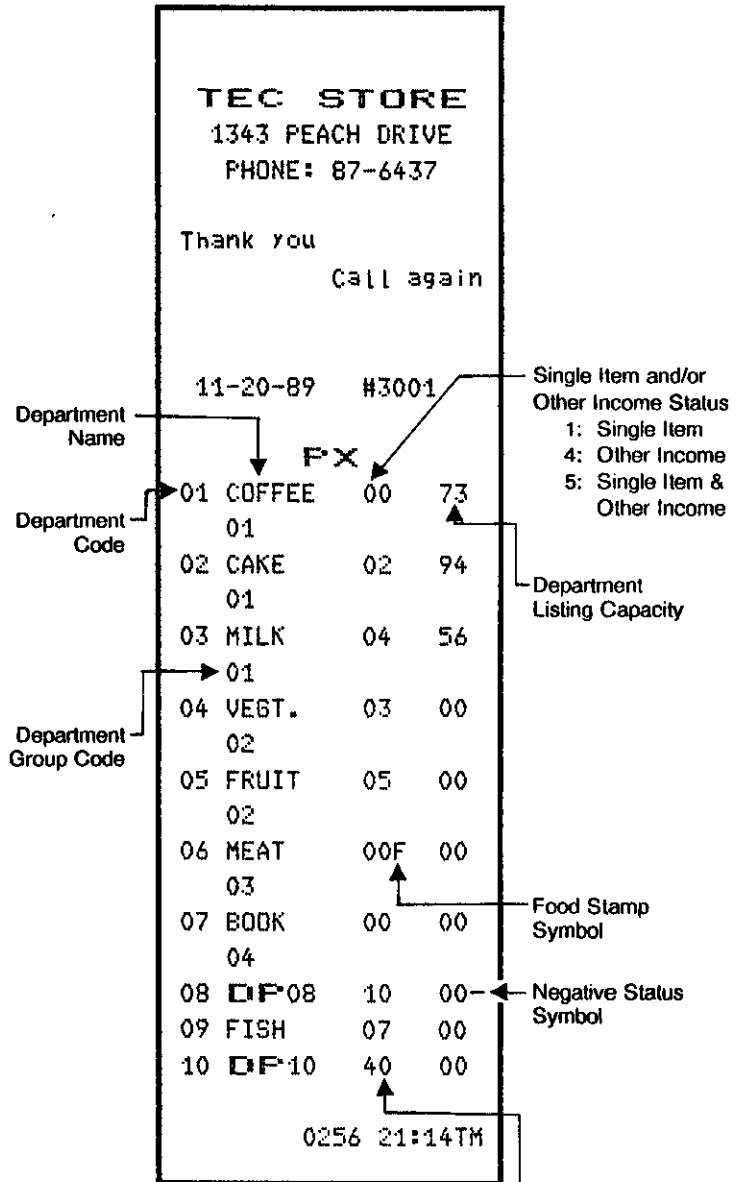
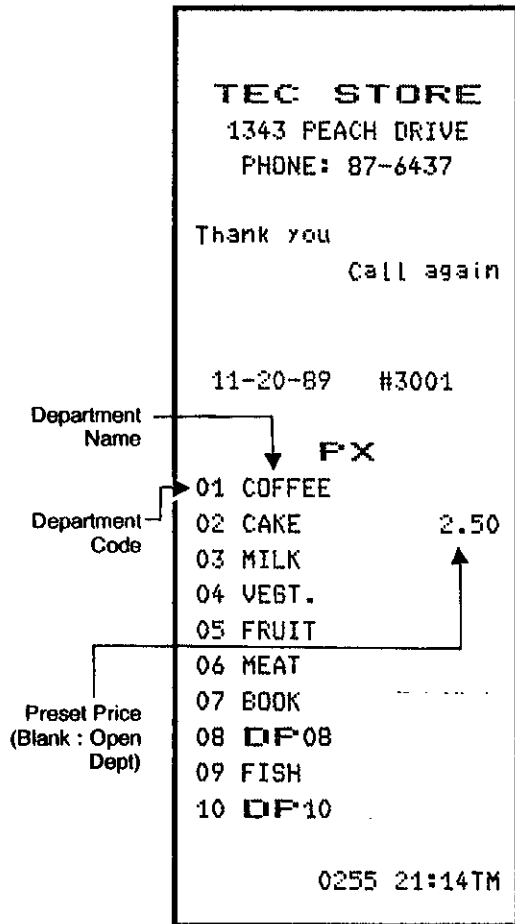

- Tax Status
- 0: Non-taxable
  - 1: Taxable 1
  - 2: Taxable 2
  - 3: Taxable 1 & 2
  - 4: Taxable 3
  - 5: Taxable 1 & 3
  - 6: Taxable 2 & 3
  - 7: Taxable 1 & 2 & 3

PLU TABLE READ  
(Mode Lock : X, 3 [ST])

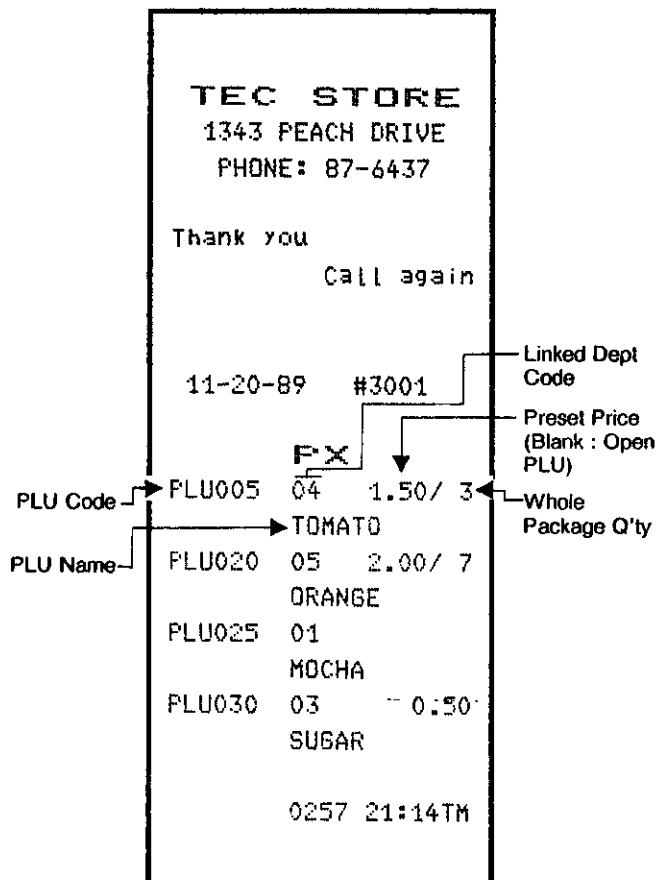

OTHER PROGRAM DATA READ  
(Mode Lock : X, 4 [ST])

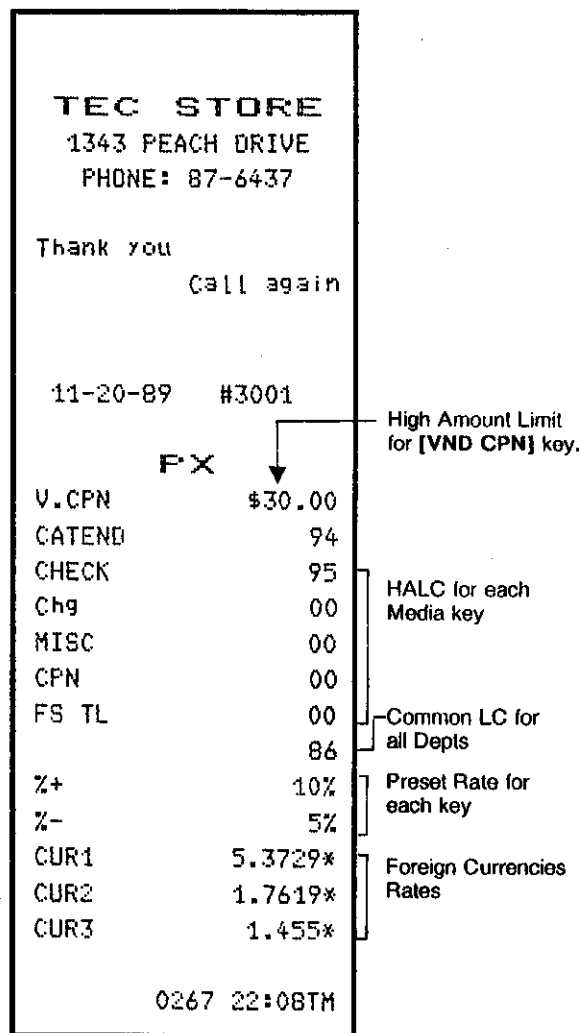

**USER SYSTEM OPTION READ  
(Mode Lock : X, 5 [ST])**

```

TEC STORE
1343 PEACH DRIVE
PHONE: 87-6437

Thank you
          Call again

11-20-89  #3001

      FX

#01          2678
#02           0
#03           0
#04           0
#05           0
#06          234
#07          167
#08           23
#09          235
#10           0
#11           0
#12           0
#13           0

0259 21:15TM
    
```

**DEPARTMENT GROSS PROFIT  
RATE READ  
(Mode Lock : X, 6 [ST])**

```

TEC STORE
1343 PEACH DRIVE
PHONE: 87-6437

Thank you
          Call again

11-20-89  #3001

      FX

01 COFFEE      10%
02 CAKE        20%

0260 21:15TM
    
```

Department Code

Department Name

Gross Profit Rate

Ask your TEC representative for information of the User System Option selections for your store, if necessary.

**TAX CALCULATION TEST (Mode Lock : X)**

! Enter any amount !

—————> Depress [TXBL TL] (or [TX1/M])

The entered amount is displayed.

The tax amount is displayed.





**TEC**

**TOKYO ELECTRIC CO., LTD.**

**E** PRINTED IN JAPAN  
EO1-11014 89111500



## Free Manuals Download Website

<http://myh66.com>

<http://usermanuals.us>

<http://www.somanuals.com>

<http://www.4manuals.cc>

<http://www.manual-lib.com>

<http://www.404manual.com>

<http://www.luxmanual.com>

<http://aubethermostatmanual.com>

Golf course search by state

<http://golfingnear.com>

Email search by domain

<http://emailbydomain.com>

Auto manuals search

<http://auto.somanuals.com>

TV manuals search

<http://tv.somanuals.com>