

TEC

TEC Electronic Cash Register

MA-315-100

Owner's Manual

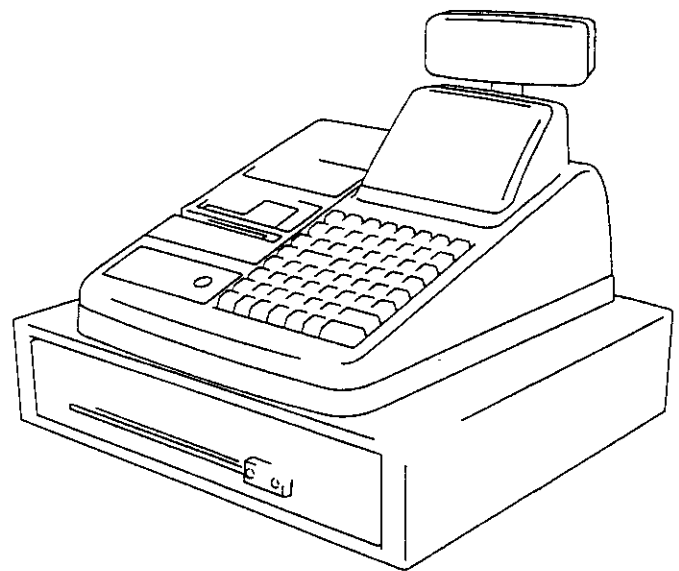

TOKYO ELECTRIC CO., LTD.

WARNING

This equipment generates, uses, and can radiate radio frequency energy and if not installed and used in accordance with the instruction manual, may cause interference to radio communications. It has been tested and found to comply with the limits for a Class A computing device pursuant to Subpart J of Part 15 of FCC Rules, which are designed to provide reasonable protection against such interference when operated in a commercial environment. Operation of this equipment in a residential area is likely to cause interference in which case the user at his own expense will be required to take whatever measures may be required to correct the interference.

WARNING

"THIS DIGITAL APPARATUS DOES NOT EXCEED THE CLASS A LIMITS FOR RADIO NOISE EMISSIONS FROM DIGITAL APPARATUS SET OUT IN THE RADIO INTERFERENCE REGULATIONS OF THE CANADIAN DEPARTMENT OF COMMUNICATIONS."

"LE PRÉSENT APPAREIL NUMÉRIQUE N'EMET PAS DE BRUITS RADIOÉLECTRIQUES DÉPASSANT LES LIMITES APPLICABLES AUX APPAREILS NUMÉRIQUES DE LA CLASSE A PRESCRITES DANS LE RÉGLEMENT SUR LE BROUILLAGE RADIOÉLECTRIQUE ÉDICTÉ PAR LE MINISTÈRE DES COMMUNICATIONS DU CANADA."

1. Introduction

Thank you for choosing the TEC electronic cash register MA-315 series. This instruction manual provides a description of the functions and handling of this register and should be read carefully to ensure optimum performance. Since every consideration has been given to safety and reliability, there is no danger of damaging the machine by incorrect operation.

Please refer to this manual whenever you have any questions concerning the machine. This machine has been manufactured under strict quality control and should give you full satisfaction.

- The specifications described in this manual may be modified by TEC, if necessary.
- Be sure to keep this manual for future reference.

2. Unpacking

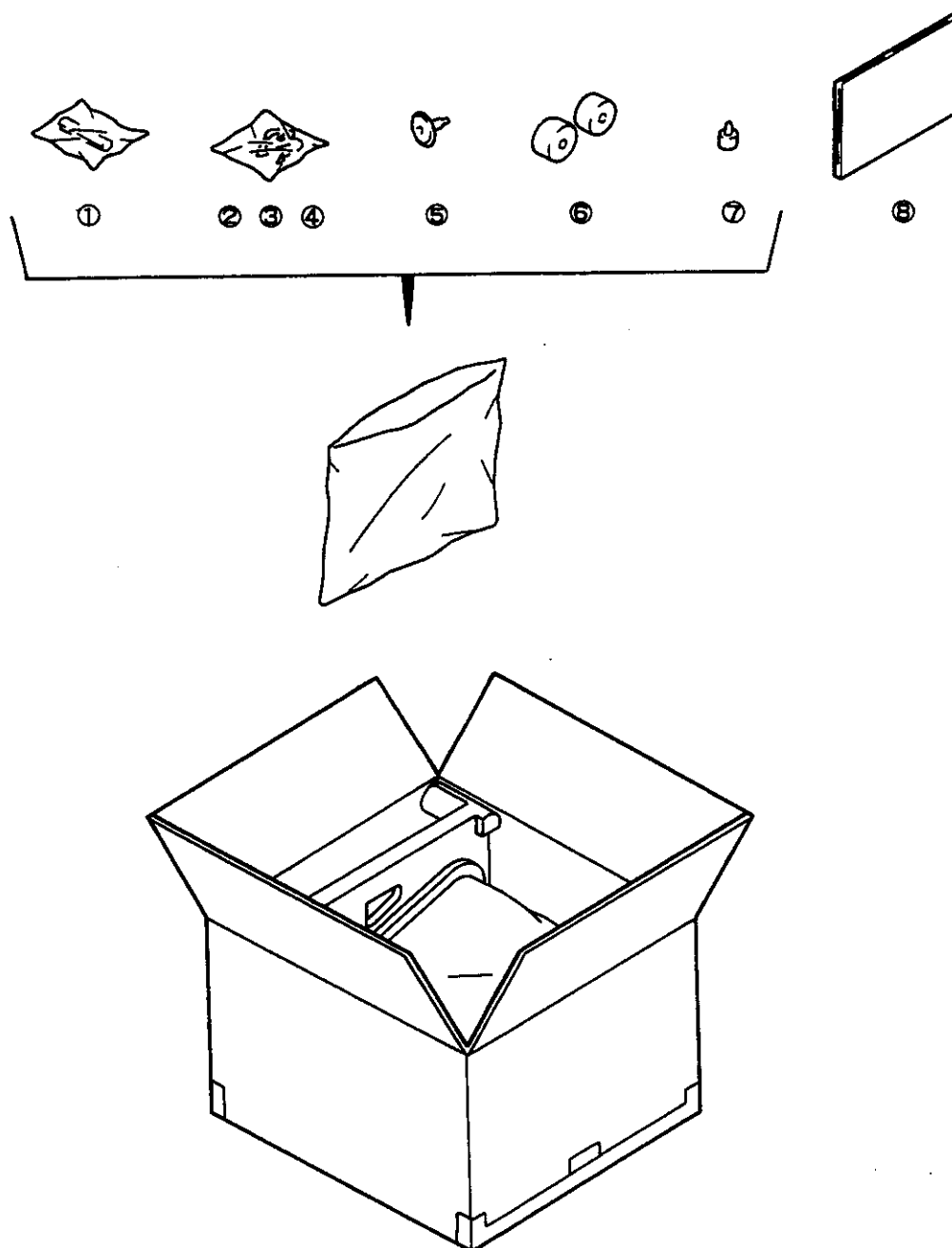

- | | |
|---|------------------------------------|
| ① Ink Roll (1 pc.) | ⑤ Journal Take-up Reel (1 pc.) |
| ② Control Key (REG Key, MGR Key, MA Key, S Key; 2 pcs. respectively) | ⑥ Paper Roll 45mm × Ø50mm (2 pcs.) |
| ③ Drawer Key (2 pcs.) | ⑦ Stamp Ink (1 pc.) |
| ④ Receipt Cover Key (2 pcs.) | ⑧ Owner's Manual (1 pc.) |

3. Precautions

The ECR is a precision machine. Please handle it carefully considering the following guidelines.

Remarks on the Location

Do not place it where unusual temperature changes are expected or where it will be subjected to direct sunlight.

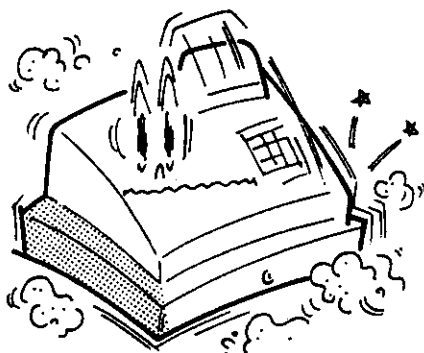
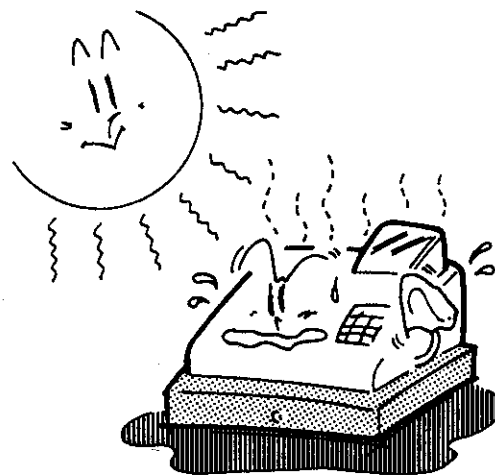

Place it on a flat and level surface with little dust, humidity, vibration, etc.

Keep it away from water sources.

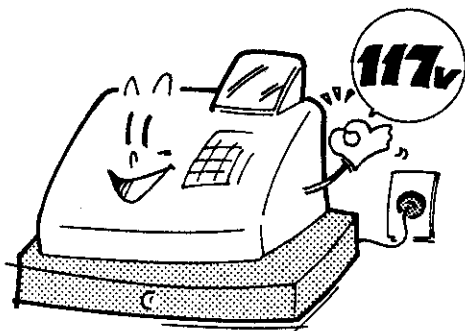
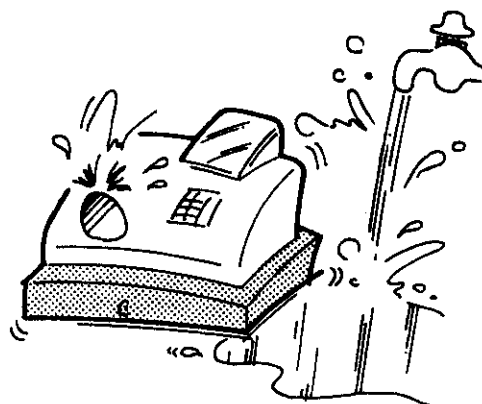

Be certain that the power voltage in your area matches that required for the machine. (The rated voltage is 117V AC.)

The socket-outlet shall be installed near the equipment and shall be easily accessible.

Remarks on Operating the ECR

The keys on the keyboard function with a light touch. Avoid pressing the keys too hard.

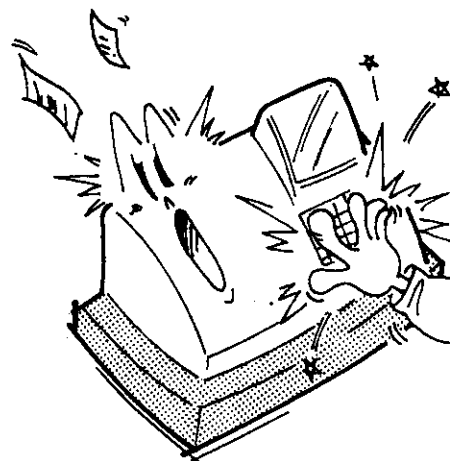
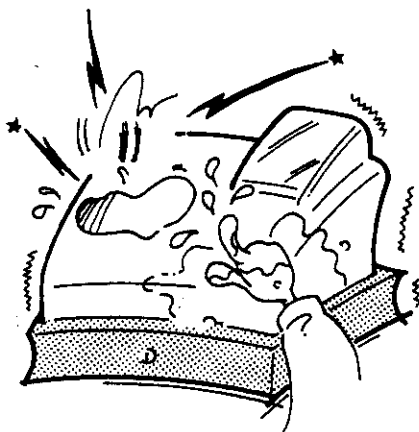

Do not handle the machine with wet hands, since this may cause electrical malfunctions and corrosion of parts.

Do not apply thinner, benzene, or other volatile materials to the cabinet or other plastic parts. Such liquids will cause discoloration or deterioration. If dirty, wipe off with a piece of cloth soaked in a neutral detergent and wrung out thoroughly.



Turn the Control Lock to **OFF** position when all operations are completed after business hours.

Never try to repair the ECR. Call dealer for information of your local TEC representative.



4. Table of Contents

	page
1. Introduction	1
2. Unpacking	2
3. Precautions	3
Remarks on the Location	3
Remarks on Operating the ECR	4
5. Outline of Preparation Procedure Before Operating the ECR	9
6. Appearance and Nomenclature	11
7. Control Lock and Control Keys	12
Control Keys	12
Control Lock	12
8. Display	13
Operator's Display	13
Customer's Display	13
Numeric Display	14
Message Descriptors	14
9. Keyboard	15
Standard Keyboard Layout	15
10. Installing the Receipt/Journal Roll	16
Installing the Receipt Roll	16
Installing the Journal Roll	18
11. Installing the Ink Roll	19
12. Setting the Time and Date	20
Setting the Time	20
Setting the Date	21
Displaying the Time	22
Printing Time and Date	22
13. Tax Table Setting	23
Setting the U.S. (or PST) Tax Tables	23
Setting the GST Rate	27
Setting the Non-taxable Limit Amount	28
Tax Calculation Test	29
14. Register No. Setting	30

15. Optional Key Setting	31
List of Keys	31
Key Installation Setting	32
Blank Keyboard Sketch (for your planning aid)	33
16. Daily Operation Flow	35
17. Cashier Identifying Operation	36
(1) Signing Method	36
(2) Cashier Lock Method	37
(3) Cashier Push Key Method	37
18. Setting Preparation of Each Key and Transaction Entries .	38
Receipt-issue/Non-issue Selection	38
Clearing Errors, or Clearing Wrong Declaration Key or Wrong Numeric Entries	39
Department Keys	40
Programming Department Keys	40
Sale Item Entries Using Department Keys	44
PLU (Price-Look-Up)	49
Programming PLUs	49
Sale Item Entries of PLUs	52
Preset Price Open	56
Listing Capacity Open	57
Percent Charge, Percent Discount	58
Setting Preset Rate for % Keys	58
% Key Operations in Sale Entries	59
Dollar Discount	60
Vendor Coupon	60
Store Coupon	61
Tax Modification	62
Food Stamp Modification	63
Item Correction (Last Line Voiding)	63
Returned Merchandise	64
Void (Designated Line Voiding)	65
All Void (Transaction Cancel)	66
Non-add Number Print	67
Subtotal Read & Print	68
Taxable Total Read	69
Manual Tax Entry	69
Food Stamp Tender	70
Cash Total, Cash Tender	72
Non-cash Media Total, Non-cash Media Tender	74
Multi-tender, Split Tender	76
Tax Exemption	77
Check Cashing	78
No-sale	79
Received-on-Account Payment	80
Paid Out	81
Sale Paid in Foreign Currencies	82
Programming Foreign Currency Keys	82
Entering Sale Paid in a Foreign Currency 1	83

Post-issue Receipt	85
Validation Print	86
Print/Non-print Options on Sale Receipts	88
19. Operations in "MGR" Mode	89
Items programmed to require Manager Intervention	89
Listing Capacity Release	90
20. Operations in "□" Mode	91
21. Read and Reset Reports	92
Programming Operations Relating to Reports	92
Programming Hourly Range Table	92
Selecting Print/Non-print Items on Reports	93
Taking Read and Reset Reports	94
Fundamental Concepts of Various Types of Reports	94
Report Taking Operation	94
Daily Read Reports	95
Daily Reset Reports	97
Periodical Read Reports	98
Periodical Reset Reports	99
Report Sample Format	99
Financial Read or Reset Report (Daily or Periodical)	100
-- <i>Memory Balance</i> --	103
Cashier Read or Reset Report (Daily or Periodical)	104
Daily Hourly Sales Read or Reset Report	105
Daily PLU Read or Reset Report (All or Zone)	106
Daily Media Sales & In-drawer Read Report	107
22. System Option Setting	108
Programming Procedure	108
Address 1	110
Address 2	110
Address 3	111
Address 4	112
Address 5	112
Address 6	113
Address 7	113
Address 8	114
Address 9	114
Address 10	115
Address 11	115
Address 12	116
Address 13	116
Address 14	117
Address 15	117
Address 16	118
23. Program Data Verification	120
Operating Procedure	120
Department Preset Price Read	121
Department LC and Status Read	121

PLU Table Read	122
Other Programmed Data Read	122
System Option Read 1	123
System Option Read 2	123
24. Paper Roll Replacement and Other Maintenance	124
Replacing the Receipt Roll	124
Replacing the Journal Roll	125
Replacing the Ink Roll	126
Replenishing Ink to the Store Name Stamp	127
Manual Drawer Release and Lock	128
Removing the Drawer	129
25. Troubleshooting	130
26. Status Clear and Memory Clear Operations	134
Status Clear	134
Sales Memory Clear	135
All Memory Clear	136
24. Specifications	137

5. Outline of Preparation Procedure Before Operating the ECR

This chapter shows the outline of set-up procedure of the ECR before actually starting the ECR operation.

- 1 Remove the cash register from the carton, referring to Chapter "2. Unpacking" on page 2. And take out all the parts and accessories.

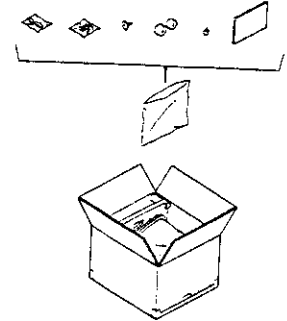

- 2 Remove the tapes and seals for holding parts or protecting the register surfaces.

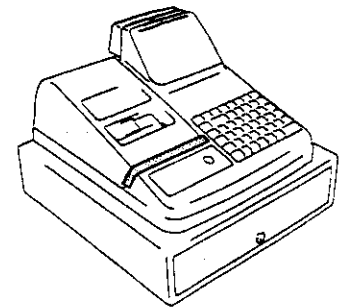

- 3 Plug the power cord of the register into a wall outlet. Make sure that the outlet voltage matches that of the power required for the register.

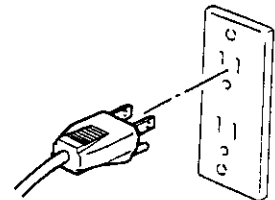

- 4 Insert the **MA** key into the Control Lock.

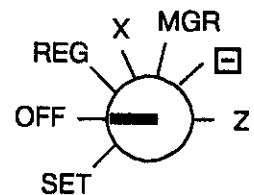

- 5 Turn the Control Lock to the **REG** position.

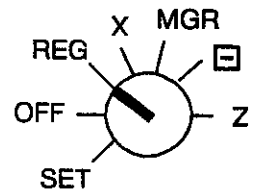

6 Install the Receipt and Journal rolls (referring to Chapter "10. Installing the Receipt/Journal Roll"). Also, install the Ink Roll (referring to Chapter "11. Installing the Ink Roll").

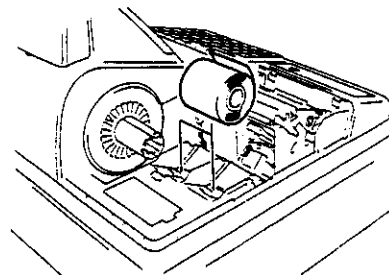

7 If any optional keys are installed or relocated on the keyboard, the optional key setting programming must be performed first before any other programming. Refer to Chapter "15. Optional Key Setting."

8 Set the time and date correctly, referring to Chapter "12. Setting the Time and Date".

9 Set the tax tables, referring to the Chapter "13. Tax Table Setting".

10 When multiple registers are used in one store, or to distinguish this register from others used by other stores in the same chain, set the Register Number referring to Chapter "14. Setting the Register No."

11 Perform programming the register, such as Departments and PLUs, according to the requirement of the market and your store (refer to Chapter 16 and thereafter).

6. Appearance and Nomenclature

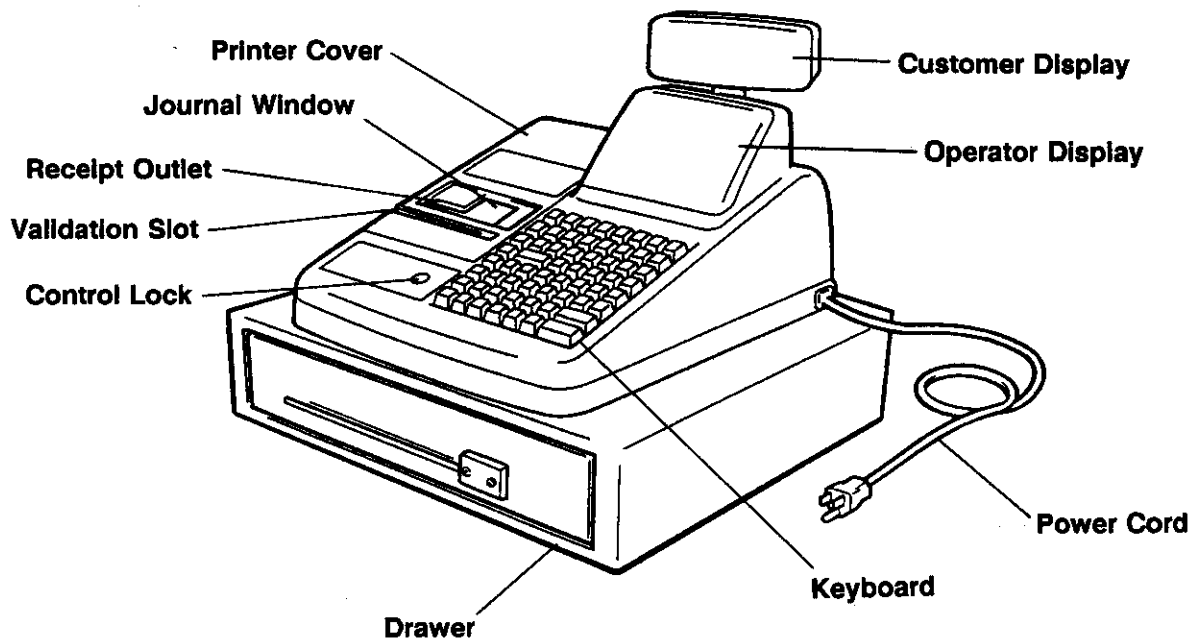

Operator Display

Used by the operator to confirm the entry contents and the status of the register. (page 13)

Customer Display

Provided for the customer to see the amount entered for each item and sale total. (page 13)

Receipt Outlet

The receipt for the finalized sale is issued.

Printer Cover

The cover for the Receipt/Journal printer.

Journal Window

The operator can see which items have already been entered through this window.

Validation Slot

Used to print the required item on the validation slip. (page 86)

Control Lock

It selects the type of register operations. (page 12)

Keyboard

Used to enter sale items. (page 15)

Drawer

Cash and other media are kept here. It automatically opens on finalizing a sale.

7. Control Lock and Control Keys

Control Keys

There are four types of Control Keys: the **REG** key, the **MGR** key, the **MA** key, and the **S** key.



REG Key: The REG key is used by the cashier or clerk who operates ordinary transaction entries. This key can access the positions of **OFF** and **REG** of the Control Lock.

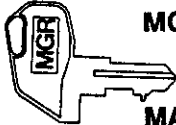

MGR Key: The MGR Key is used by the store manager. This key can access the positions of **OFF**, **REG**, **X**, and **MGR**.

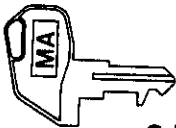

MA Key: The MA Key is used by the owner who will daily supervise the collection of money and printout of transactions recorded by the register. This key is also used by programmer. This key can access the positions of **SET**, **OFF**, **REG**, **X**, **MGR**, \square , and **Z**.

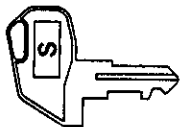

S Key: The S key is used by the owner. This key can access any position including **BLIND** of the Control Lock. However, to prevent programmed data and sales data from being changed by mistake, use the REG, MGR, or MA keys for transaction entries or report taking purposes.

Control Lock

The Control Lock has eight effective positions for different modes of operation, which are accessed by the appropriate Control Keys.

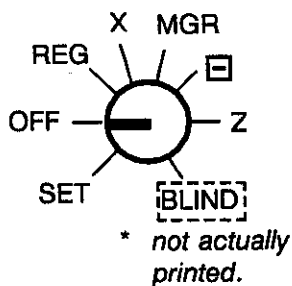

(position)	(function)
SET ...	The register allows programming operations.
OFF ...	Nothing appears on the display in this position. However, the power is being supplied to the register.
REG ...	Ordinary transaction entries are carried out in this mode. Displays the current time while no entries are under way.
X	The sale totals in memory can be read (X reports) and the programmed data can be verified in this position.
MGR ...	This position allows to enter operations requiring Manager Intervention as well as all ordinary transaction entries to be carried out in the "REG" mode.
\square	This is the "Negative Mode" position, which makes entered data processed reversely to the REG or MGR mode. It is used to cancel or adjust sales data already finalized.
Z	All the resettable totals and their respective counters in memory will be read <u>and</u> reset in this position (Z reports)
BLIND .	The register allows special programming operations and memory clear operations.

8. Display

The Operator's Display (front display) is located at the top of the register just above the keyboard. The Customer's Display may be used only as a rear display if left in the retracted position or it can be positioned for viewing at other angles by pulling it upward and turning it to the desired position. The display has two types of display portions -- numeric display and message descriptors (triangular lamps).

Operator's Display

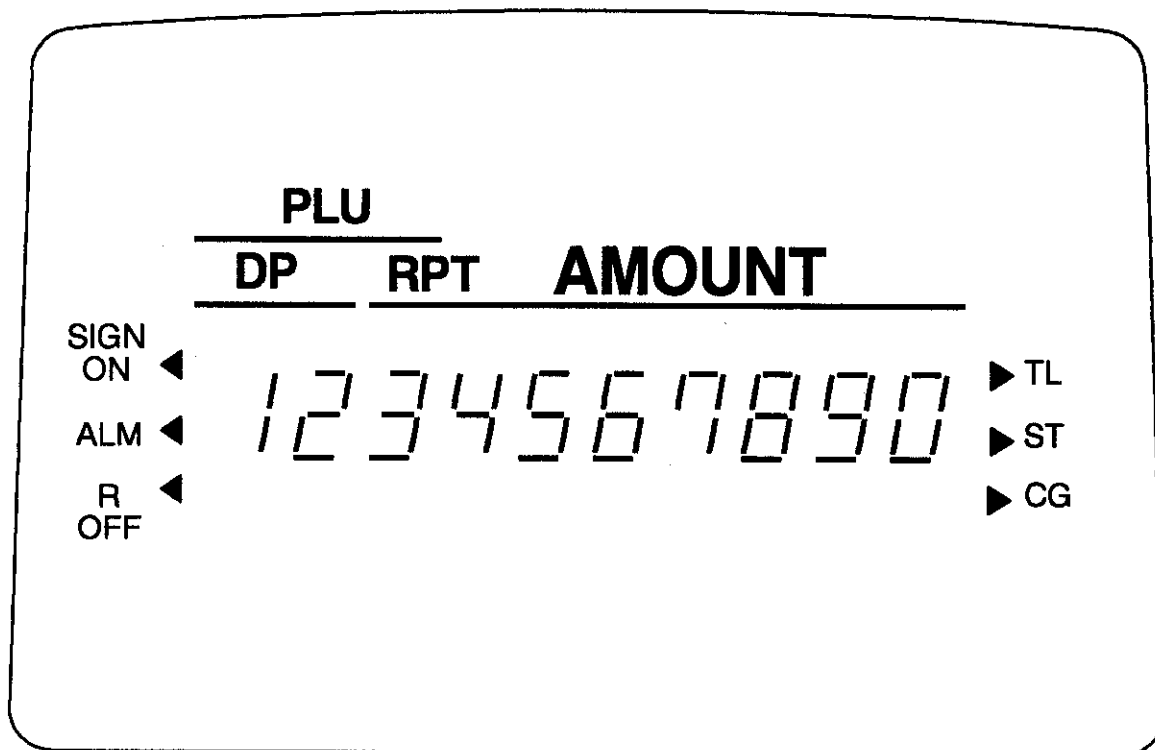

Customer's Display

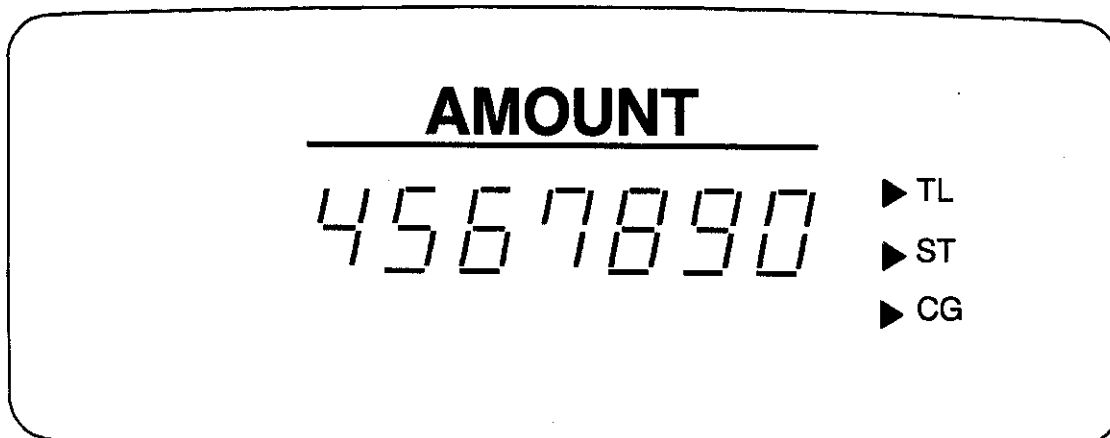

Numeric Display

AMOUNT (8 digits for total display, 7 digits for entries):

Displays the numeric data, such as amount, quantity, etc. When the obtained total or subtotal amount is 8-digit, the **RPT** digit is also used for the amount display. When no entries are under way and the Control Lock is in the **REG** position, the current time is displayed.

DP (2 digits): Displays the code which represents each Department key. It stays lit when repeating the same department entry.

RPT (1 digit): Displays the repeat count of the same item. The count is indicated from the second entry on, and only the last digit will be displayed even if the count exceeds nine.

PLU (3 digits of the DP and RPT are used for this purpose):

Displays the PLU code when any PLU is entered. It goes out when repeating the same PLU entry, then only the RPT digit will be displayed for the repeat entry count.

Message Descriptors (Triangular Lamps)

SIGN ON : Illuminates when a cashier has signed ON when the Cashier Signing Method is selected. (It never illuminates for the Cashier Lock Method or the Cashier Push Key Method.)

ALM : Illuminates with the alarm buzzer to indicate that the last operation or numeric entry was an error. To clear the error condition, depress the **[C]** key.

R OFF : Illuminates when the Receipt-OFF mode is declared by the **[LOG/RECEIPT]** key. In this condition, no receipts will be issued for a sale to be entered. To extinguish this lamp (i.e., to change into Receipt-ON mode for issuing receipts), simply depress the **[LOG/RECEIPT]** key again.

TL : Illuminates with the total amount displayed when a sale is finalized without any amount tendered.

ST : Illuminates with the subtotal amount displayed when the **[ST]** or **[TXBL TL]** key is depressed.

CG : When an amount tendering operation has been performed, this lamp illuminates with the amount of change due displayed.

9. Keyboard

The following is the standard keyboard layout, which was initially set at the factory. This register is designed to be capable of programming most of the keys at desired locations or adding some optional keys in place of the current keys. If you are in need of changing the locations or adding keys, see Chapter "15. Optional Key Setting".

Standard Keyboard Layout

LOG RECEIPT	#/NS	RF	JF	RECEIPT ISSUE	DOLL DISC	% +	% -
RTN MDSE	LC OPEN	PR OPEN	EX	VND CPN	STR CPN	CUR 1	CUR 2
TX1/M	VALI DATE	R/A	PO	1	7	13	CPN
TX2/M	C		@/FOR	2	8	14	MISC
FS/M	7	8	9	3	9	15	FSTL TEND
PLU	4	5	6	4	10	Chg	CHK TND
AMT	1	2	3	5	11	ST	
ITEM CORR	0	00	.	6	12	AT/TL	

10. Installing the Receipt/Journal Roll

Installing the Receipt Roll

①

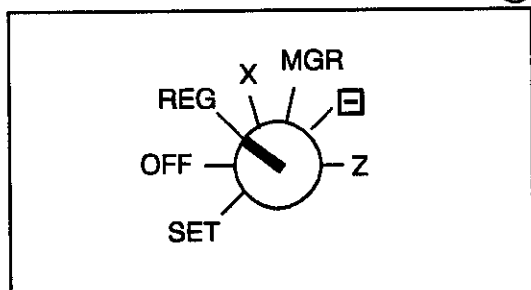

Turn the Control Lock to the **REG** position using a Control Key.

②

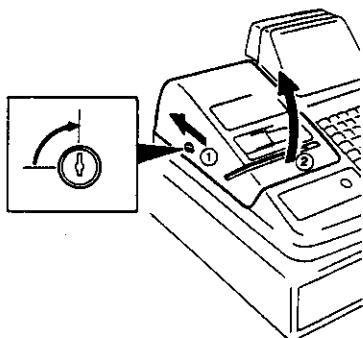

To remove the Printer Cover, insert the Printer Cover Key to the Printer Cover Lock, and turn it 90° clockwise. Then lift the Printer Cover in the direction of the arrow mark ② while pushing the Printer Cover in the direction of the arrow mark ①.

③

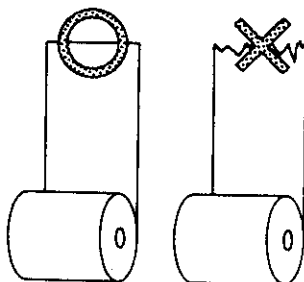

Cut the paper end to make it sharp.

④

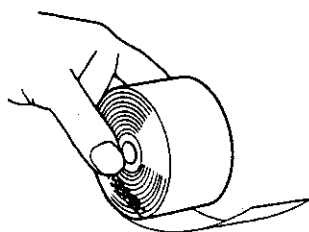

Hold the paper roll so that the paper end will be fed from the bottom.

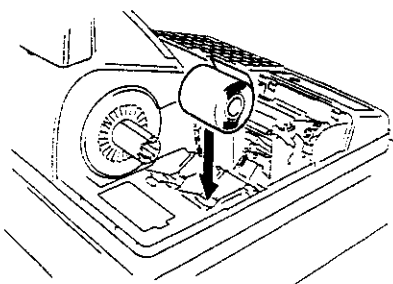

Place the paper roll in the outer side holder of the two roll holders.

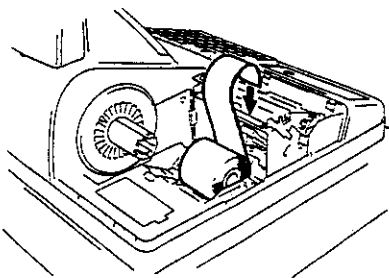

Insert the paper end into the space behind the printer.

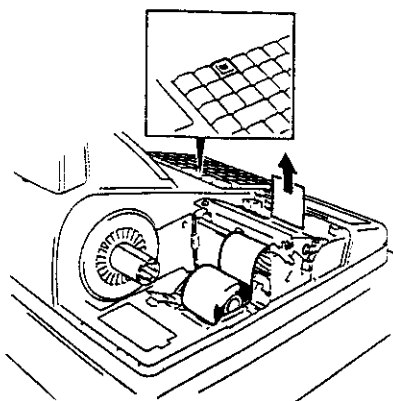

Press the **[RF]** key until about 4 inches (about 10 cm) of paper comes out of the printer.



Attach the Printer Cover, and cut the excess paper with the attached cutter.

Installing the Journal Roll



Follow Steps 1 to 7 for "Installing the Receipt Roll" on the preceding page, except that the paper roll should be placed inner side of the two holders and the [JF] key should be used for the journal roll.

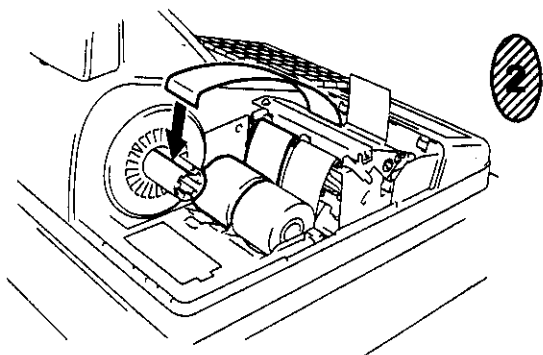

Insert the paper end into the slit on the Take-up Reel and wind it around the reel two or three times.

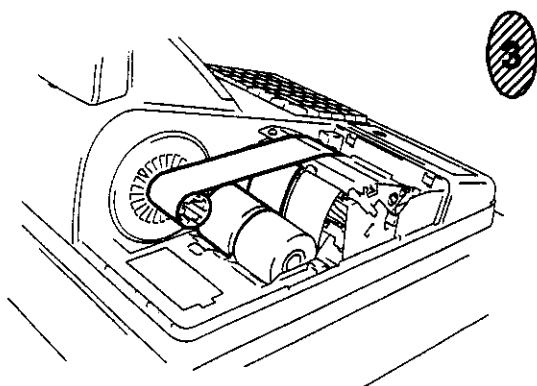

Set the Journal Take-up Reel into the Reel Holder.

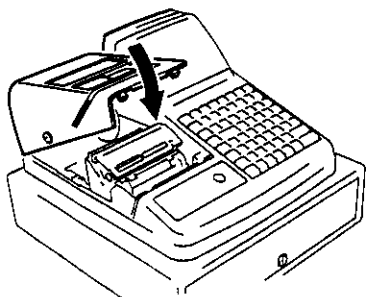

Attach the Printer Cover.

11. Installing the Ink Roll

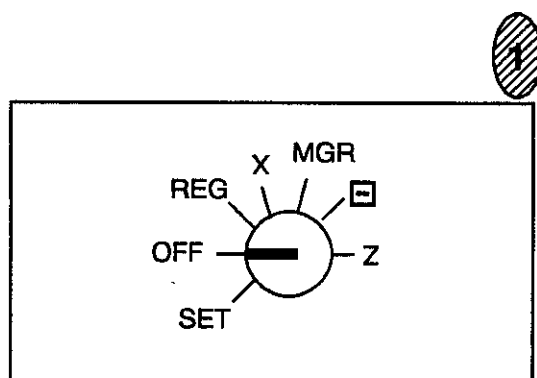

Turn the Control Lock to the **OFF** position.

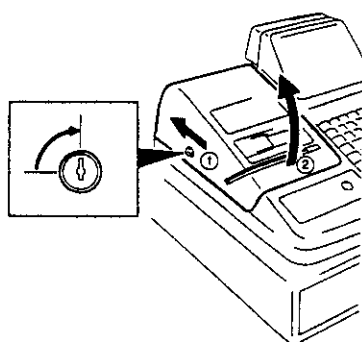

To remove the Printer Cover, insert the Printer Cover Key to the Printer Cover Lock, and turn it 90° clockwise. Then lift the Printer Cover in the direction of the arrow mark ② while pushing the Printer Cover in the direction of the arrow mark ①.

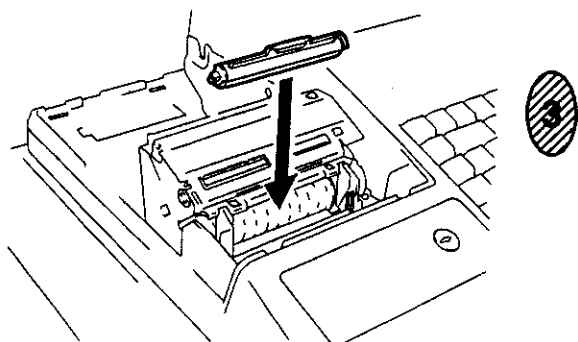

Install the Ink Roll in the direction of the arrow mark.



Attach the Printer Cover.

12. Setting the Time and Date

Setting the Time

The register has a clock function. Once the time is set, the time is kept even when the power is turned off. The 24-hour system (the military time) is used for time setting, display, and printing. Time setting is allowed any time outside a sale.

Condition for Setting: Must be signed off in the Cashier Signing Method. (In other methods, a Cashier Key may or may not be set to ON.) Refer to **Chapter 17**.

NOTE on "Condition":
This is necessary for all program changes.

Setting Procedure

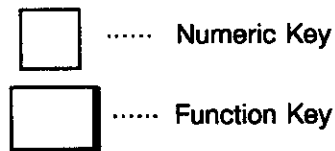

Use the **MA Key** to turn the Control Lock to "SET".

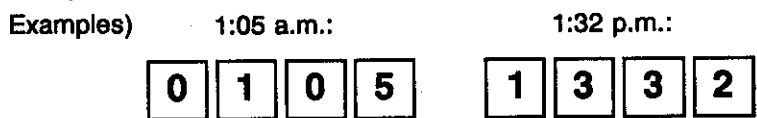
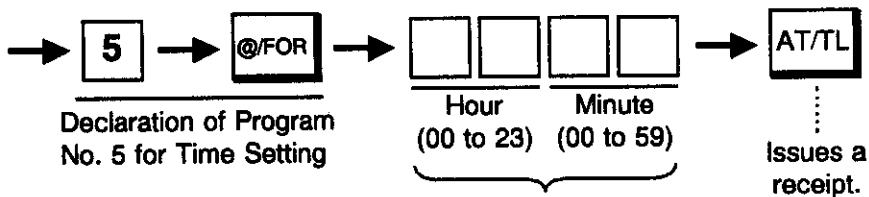
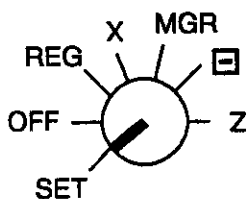

Receipt Print Format

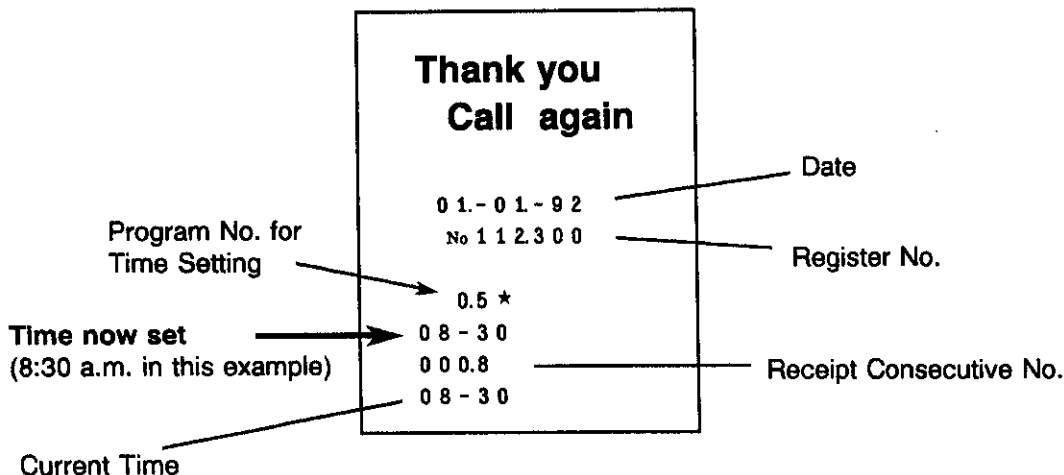

Setting the Date

The register has a calendar function. Once the date and time are correctly set, the day automatically advances at midnight even when the power is turned off. The extra day of a leap year is also computed automatically.

Setting Procedure

Use the **MA Key** to turn the Control Lock to "SET".

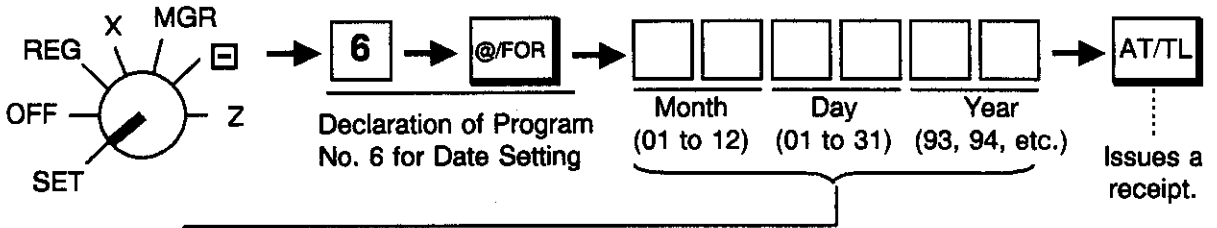

NOTE: The date set/print order is Month-Day-Year. If you want to change the order into Day-Month-Year or Year-Month-Day, select appropriate status of **Bits 7 and 8** in **Address 16** in Chapter "22. System Option Setting".

Examples) To set May 28, 1993:

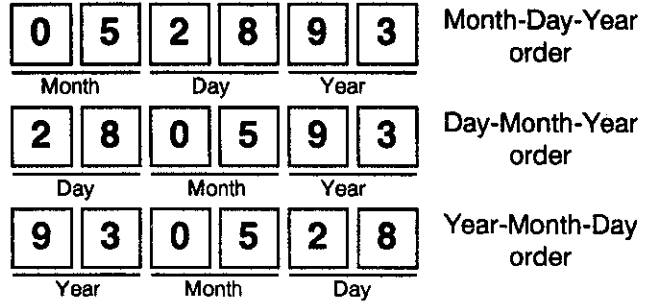

Receipt Print Format

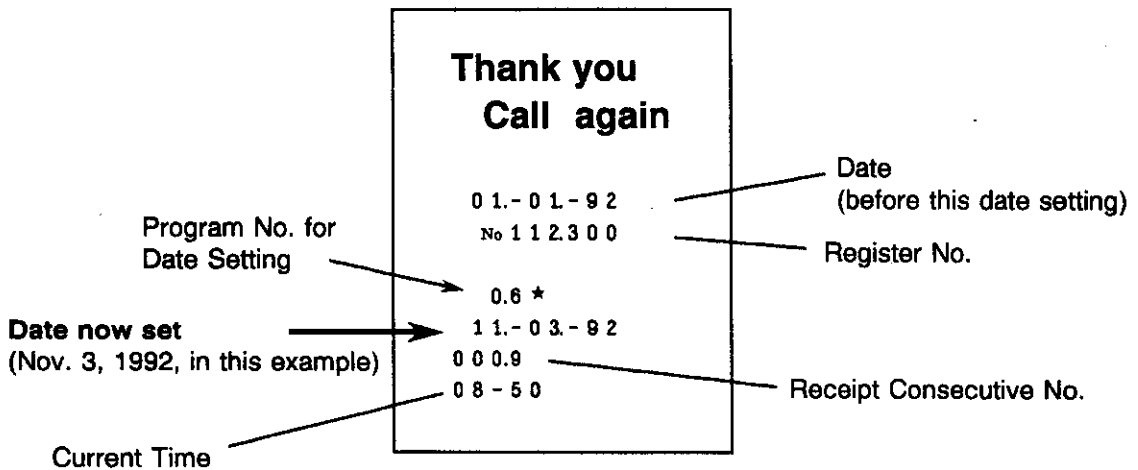

Displaying the Time

The current time is displayed in the "AMOUNT" area when the Control Lock is turned to **REG** from any other position. When the Control Lock position is changed or any entry operation starts, the displayed time disappears.

Time Display Format:
(Example: 1:45 p.m.)

13 - 45

Printing the Time and Date

The current time is printed on every receipt, as the bottom line (*refer to the **Receipt Print Format on the preceding page***). The time can be programmed to non-print, if necessary, by a System Option selection (*refer to Chapter "22. System Option Setting", Address 1 - Bit 1*).

The date is printed on every receipt, as the top line below the Store Name Stamp print (*refer to the **Receipt Print Format on the preceding page***). The quickest way to verify the date print with the Control Lock in **REG** position is to issue a receipt of any transaction (for example a No-sale receipt).

13. Tax Table Setting

For details about the actual tax table, contact to the location where the register was purchased.

Setting the U.S. Tax Tables (also applicable to PST in Canada)

There are three ways to set state and local tax tables. Select one that suits the tax table required to be set.

Condition for Setting: After Daily Financial Reset

NOTE on "Condition":

Unless the register satisfies this condition, the programming operations will not be allowed.

"After ... Reset" means that the designated reset report must be taken before entering the programming (setting) operation. An error will result if the operation is attempted without taking the report.

However, it does not necessarily mean "immediately after ..." When the designated reset report has already been taken and then some operations are performed in the "X", "Z", or "SET" mode, the condition "After ... Reset" is still satisfied and the programming operation is still allowed.

On the contrary, when the designated reset report has been taken but then some sales data relating to that report's output data are entered in the "REG", "MGR", or "☐" mode, the programming operation will no longer be allowed and the same reset report must be taken again.

Thus the condition "After ... Reset" indicates that all the sales data relating to the report data must be zero (except non-resettable memory data). Because of this "Condition" requirement, the report data will be protected from any inconsistencies of sales data entered in the period from a resetting of the report to another resetting of the same report next time. When no condition is specified to a programming (setting) operation, it means that the operation is allowed any time outside a sale but the cashier must be signed off if the Cashier Signing Method is selected (See Chapter 17.).

Setting Procedure:

Use the MA Key to turn the Control Lock to "SET".

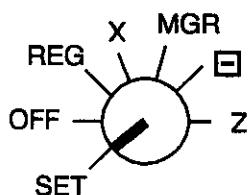

Go to 1), 2), or 3) on the following pages.

Indications of types of keys on the following pages:



..... Individual Numeric Key



..... Data to be entered through Numeric Keys



..... Function Key

1) Tax 1; Full Breaks (Non-cyclic Breaks + Cyclic Breaks)

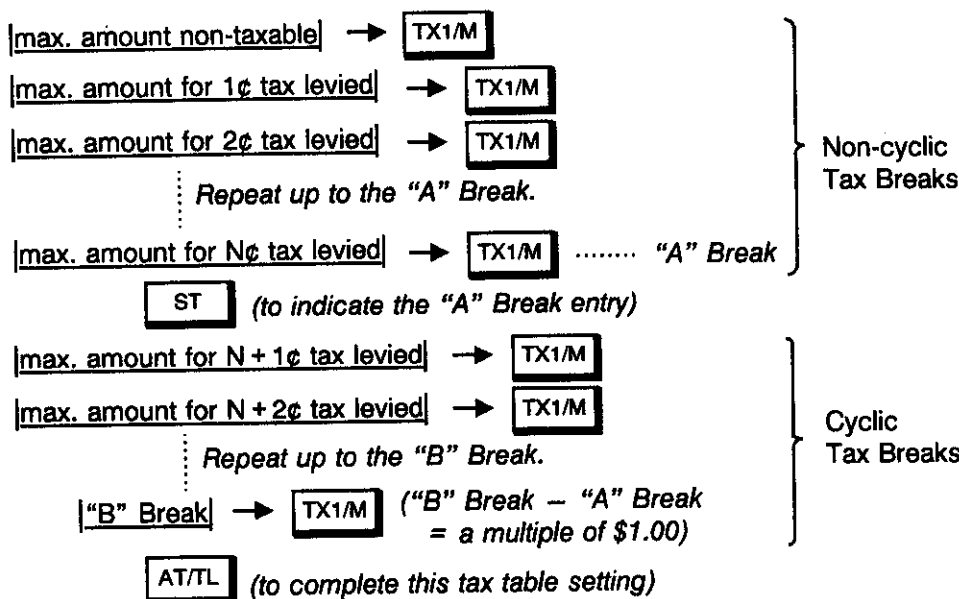

NOTE: Each amount (break) entry may be a maximum of 4-digit value (9999¢).

2) Tax 1; "A" Break and % Rate Combination (Non-cyclic Breaks + % Rate)

First, set all the non-cyclic breaks up to the "A" Break entry and the [ST] key depression shown in the above case of "1) Tax 1 Full Breaks".

↓

Tax Rate applied when exceeding the "A" Break amount

(Max. 6 digits up to 99.9999%. Use the [.] key for a decimal value. Examples: To set 5%, enter 5. To set 5.26%, enter 5→[.]→2→6. The fraction of the amount resulting from this % rate calculation will be rounded off.)

↓

AT/TL (to complete this tax table setting)

3) Tax 1; % Rate Only

0 → **TX1/M** (to indicate that no breaks are entered)

ST

Tax Rate applied to any amount → **AT/TL**

(The description for the Tax Rate in the above case 2) is also applied to this case.)

- NOTES**
1. For Tax 2 table setting in a multi-tax area, follow the same procedure in 1), 2), or 3) above, using the [TX2/M] key instead of [TX1/M].
To install the [TX2/M] key on the keyboard, refer to Chapter "15. Optional Key Setting".
 2. If two tax tables are to be set, the Tax 1 table must be set first. The Tax 1 table setting will automatically reset the old Tax 1 and Tax 2 tables. The Tax 2 table can be set only when the Tax 1 table has been set (i.e., the Tax 2 table alone cannot be set without setting the Tax 1 table).
 3. No second depression of the [ST] key is allowed within one tax table setting. A maximum of 64 breaks may be entered for Tax 1 and Tax 2 tables altogether.

Setting Examples:

ex. 1) Tax 1; Full Breaks

Tax Table		Key Operation	
Amount Range	Tax Levied	Control Lock: SET	
\$0.00 to \$0.10	0¢	1 0	TX1/M
\$0.11 to \$0.22	1¢	2 2	TX1/M
\$0.23 to \$0.39	2¢	3 9	TX1/M
\$0.40 to \$0.56	3¢	5 6	TX1/M
\$0.57 to \$0.73	4¢	7 3	TX1/M
\$0.74 to \$0.90	5¢	9 0	TX1/M
\$0.91 to \$1.08	6¢	1 0 8	TX1/M
... "A" Break		ST	
\$1.09 to \$1.24	7¢	1 2 4	TX1/M
\$1.25 to \$1.41	8¢	1 4 1	TX1/M
\$1.42 to \$1.58	9¢	1 5 8	TX1/M
\$1.59 to \$1.74	10¢	1 7 4	TX1/M
\$1.75 to \$1.91	11¢	1 9 1	TX1/M
\$1.92 to \$2.08	12¢	2 0 8	TX1/M
... "B" Break		AT/TL	

**Thank you
Call again**

11.-03-92
No 112300

TX I

0.0 *

00 *0.10
01 *0.22
02 *0.39
03 *0.56
04 *0.73
05 *0.90
06 *1.08
 *1.08 ST
07 *1.24
08 *1.41
09 *1.58
10 *1.74
11 *1.91
12 *2.08
 *2.08 TL

001.6
08-54

ex. 2) Tax 1; "A" Break and % Rate Combination

Tax Table		Key Operation
<u>Amount Range</u>	<u>Tax Levied</u>	Control Lock: SET
\$0.00 to \$0.09	0¢	9 TX1/M
\$0.10 to \$0.29	1¢	2 9 TX1/M
\$0.30 to \$0.59	2¢	5 9 TX1/M
\$0.60 to \$0.84	3¢	8 4 TX1/M
\$0.85 to \$1.12	4¢	1 1 2 TX1/M
... "A" Break		ST
5% is applied to any amount exceeding the "A" Break.		5 AT/TL

**Thank you
Call again**

11.-03-92
No 112300
TX I

0.0 *
00 *0.09
01 *0.29
02 *0.59
03 *0.84
04 *1.12
*1.12 ST
5. %
001.7
08-54

ex. 3) Tax 1; % Rate Only

Tax Table	Key Operation
10% is applied to any amount.	Control Lock: SET
	0 TX1/M
	ST
	1 0 AT/TL

**Thank you
Call again**

11.-03-92
No 112300
TX I

0.0 *
00 *0.00
*0.00 ST
10. %
001.8
08-54

ex. 4) Tax 2; % Rate Only

Tax Table	Key Operation
5% is applied to any amount.	Control Lock: SET
	0 TX1/M
	ST
	5 AT/TL

**Thank you
Call again**

11.-03-92
No 112300
TX II

0.0 *
00 *0.00
*0.00 ST
5. %
001.9
08-54

Setting the GST Rate (applicable to Canada only)

Please note the following before operating the GST rate setting. The following preparations are required:

- 1) Select the "GST Active" status in Chapter "22. System Option Setting", Address 14 - Bit 1 (some other options can also be selected relating to GST in the same Address).
- 2) If the [GST/M] (GST Modifier) key must be changed to any other location on the keyboard, refer to Chapter "15. Optional Key Setting". On the Standard Keyboard (see page 15) at shipping from the factory, the [FS/M] (Food Stamp Modifier) Key is installed. This key will be changed automatically into the [GST/M] key by the operation described in 1) above.

Condition for Setting: After Daily Financial Reset
(refer to "NOTE on Condition" on page 23.)

Setting Procedure:

Use the **MA Key** to turn the Control Lock to "SET".

This portion is required only when any decimal portion is contained in the rate.

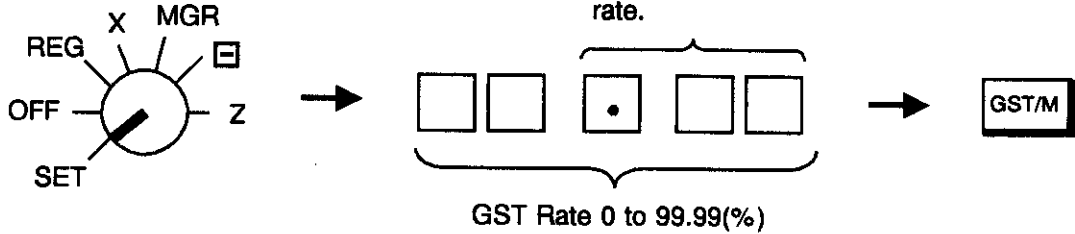

Examples)

- 7% **7**
- 12% **1 2**
- 8.55% **8 . 5 5**
- To reset the rate once set: **0**

**Thank you
Call again**

1 1 - 0 3 - 9 2
No 1 1 2 3 0 0

0.0 *
→ 7. FS

0 0 1.5
0 8 - 5 4

GST Rate 7% is set.

Setting the Non-taxable Limit Amount (applicable to only certain areas in Canada)

This non-taxable amount limit must be set only in certain areas in Canada.

Condition for Setting: After Daily Financial Reset
(refer to **"NOTE on Condition"** on page 23.)

Setting Procedure:

Use the **MA Key** to turn the Control Lock to **"SET"**.

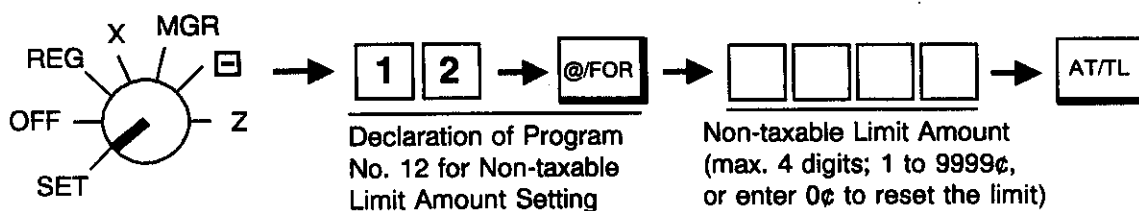

Example)

\$20.00

2

0

0

0

**Thank you
Call again**

11-03-92
No 112300

1.2 *

→ *2000

002.5

09-00

- NOTES**
1. When the sum of the sale portion subject to Tax (PST) 1 and the sale portion subject to Tax (PST) 2 exceeds the Non-taxable Limit Amount programmed here, all the amount subject to either of the two taxes are all taxed. When the sum is less than the programmed limit, Tax 1 is tax-exempted and only Tax 2 is calculated on the sale portion subject to Tax 2.
 2. When the sum of the sale portion subject to Tax (PST) 1 and the sale portion subject to Tax (PST) 2 is negative, the portion subject to Tax 1 will not be taxed.
 3. When the sale portion subject to Tax 1 is tax-exempted, the taxable amount is not stored in Tax 1 memory.
 4. An error results when the [GST/M] key is depressed in sale entries on the ECR with Non-taxable Limit Amount programmed.
 5. This setting must not be operated when Food Stamps are handled in transactions.

Tax Calculation Test

Tax calculation can be tested in the following procedure. This operation will not affect any sales data.

Operating Procedure:

Use the **MA Key** to turn the Control Lock to "X".

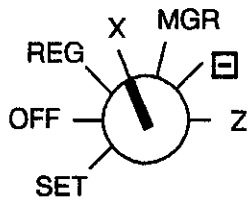

|Amount|



TX1/M (or TXBL
TL)

Enter any amount through Numeric Keys. The entered amount is displayed.

The tax amount (total of all the taxes due) is displayed in the AMOUNT portion. (The Non-taxable Limit Amount setting is disregarded from this display.)

14. Register No. Setting

When multiple registers are used in one store, or to distinguish this register from others used by other stores in the same chain, set the Register Number in the following procedure.

Condition for Setting: Any time outside a sale. Must be signed off in the Cashier Signing Method. (In other methods, a Cashier Key may or may not be set to ON.) Refer to Chapter 17.

Setting Procedure:

Use the **MA Key** to turn the Control Lock to "SET".

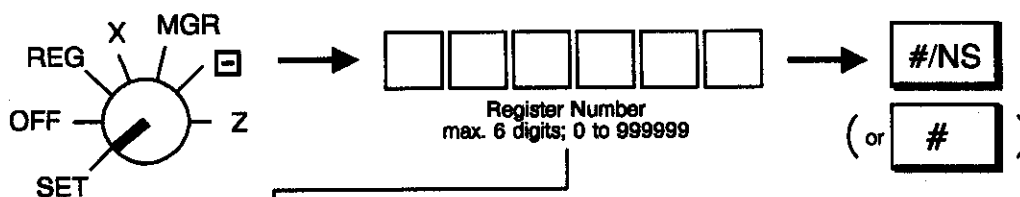

Example)

No. 112300:

1 1 2 3 0 0

Register No. before this setting

Register No. now set

Thank you Call again	
11-03-92	No 0
0.0 *	No 112300
000.4	
13-08	

- NOTES 1.** The Decimal Point cannot be entered in the Register Number.
- 2.** Preceding zeros, if any, will not be printed. For example, if "001234" is entered, "No. 1234" will be printed.
- 3.** The Register Number set here will be printed on the second line below the Store Name Stamp print space on every receipt to be issued.

Thank you Call again		Store Name Stamp print space
11-03-92	←	Date
No 112300	←	Register No.

15. Optional Key Setting

This chapter introduces optional keys (keys not installed on the current Standard Keyboard) that can be programmed. Please note, however, that adding an optional key means to sacrifice another key already installed. If you plan to install any of the Optional Keys or change locations of any of the current keys, this operation must be performed first before any other programming or setting operation (refer to **NOTE 9** at the end of this chapter).

List of Keys

The following is the list of the all the keys that can be programmed on the keyboard. Numeric Keys 0 to 9 are fixed as to their locations, therefore, not included in the list. The "Key Code" assigned to each key in the list is used in the setting procedure next page. For detail functions and operations of each key, refer to Chapters 17 and 18. For a brief information of the Optional Keys, refer to **NOTE 8** at the end of this chapter.

- Keys that must be installed as minimum requirement
 Keys that are already installed on the Standard Keyboard
 Optional Keys

Key Code	Key Name	Key Code	Key Name
0	Code to deactivate the key.	85	NS (No-sale) *2
1 to 15	Department Keys 1 to 15	86	PR OPEN (Preset)
16 to 30	Department Keys 16 to 30	87	LC OPEN (Listing Capacity Open)
51	RF (Receipt Feed)	88	OPEN (PR & LC Open)
52	JF (Journal Feed)	89	VALI DATE (Validation)
53	00 (Double-zero)	90	# (Non-add Number Print) *2
55	• (Decimal Point)	91	#/NS (Non-add Number / No-sale) *2
56	VND CPN (Vendor Coupon)	92	PLU (Price-Look-Up)
57	STR CPN (Store Coupon)	93	@/FOR (At/For; Multiplication)
59	DOLL DISC (Dollar Discount)	94	RECEIPT ISSUE (Post-receipt)
70	% + (Percent Charge)	95	C (Clear)
71	% - (Percent Discount)	97	TX1/M (Tax 1 Modifier)
72	RTN MDSE (Returned Merchandise)	98	TX2/M (Tax 2 Modifier)
73	ITEM CORR (Item Correct)	99	TXBL TL (Taxable Total)
74	VOID (Void)	100	TAX (Manual Tax)
75	ALL VOID (All Void)	101	EX (Tax Exempt)
76	AT/TL (Cash Tender/Total)	108	AMT (Amount)
77	CHK TEND (Check Tender)	115	FS/M (Food Stamp Modifier) for US GST/M (GST Modifier) for CANADA } *3
78	Chg (Charge Total)	120	FSTL TEND (Food Stamp Tender)
79	MISC TEND (Miscellaneous Tender)	121	CUR1 (Foreign Currency 1)
78	CPN (Media Coupon Tender)	122	CUR2 (Foreign Currency 2)
82	ST (Subtotal)	123	CUR3 (Foreign Currency 3)
83	R/A (Received-on-Account)	124	CUR4 (Foreign Currency 4)
84	PO (Paid Out)	127	LOG/RECEIPT (Log/Receipt) *4

- *1. At least one Department Key is required to be installed.
- *2. The [#/NS] key has both [#] and [NS] functions. Therefore, when [#/NS] is installed, neither [#] nor [NS] are necessary.
- *3. Whether the key assigned with Key Code 115 will be [FS/M] or [GST/M] is decided by Chapter 22. System Option Setting, Address 14 - Bit 1 selection.
- *4. When the Signing Method is selected for cashier identification (refer to Chapter 17), this key must be installed. In other cashier identifying methods, this key merely functions as receipt issue/non-issue key.

Key Installation Setting

Condition for Setting: After all Daily and Periodical Resets
(refer to "NOTE on Condition" on page 23.)

Setting Procedure:

Use the **S** Key to turn the Control Lock to the "BLIND" position.

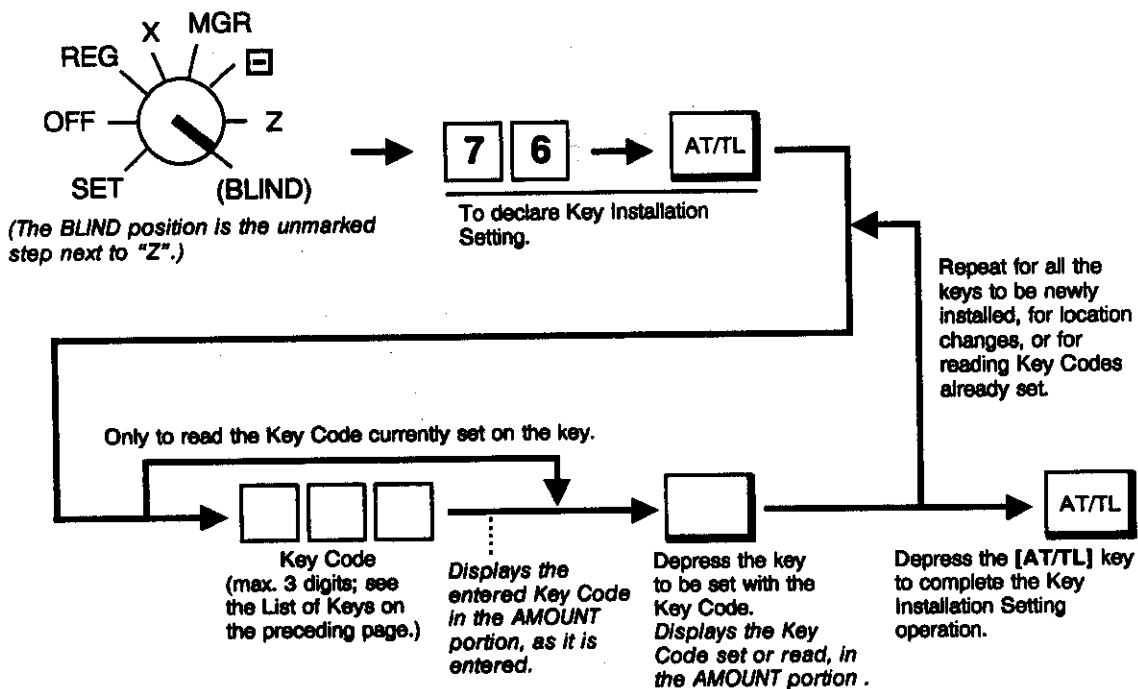

Blank Keyboard Sketch (for your planning aid)

Fill in:
 Key Name →
 Key Code →
 (Refer to the "List of Keys" on the preceding page)

For the Standard Keyboard Layout, refer to Chapter "9. Keyboard".

()	()	()	()	()	()	()	()
()	()	()	()	()	()	()	()
()	()	()	()	()	()	()	()
()	()	()	()	()	()	()	()
()	7	8	9	()	()	()	()
()	4	5	6	()	()	()	()
()	1	2	3	()	()	()	()
()	0	()	()	()	()	AT/TL	()

- NOTES**
1. If Key Installation Setting is operated for the first time, all the keys are already set as in the Standard keyboard Layout. Therefore, set only the keys that are to be changed as to their locations or newly installed.
 2. If a wrong code has been entered and the key has also been depressed (i.e., a wrong code has been set on a key), enter the correct code and depress the key. The code entered last will be effective.
 3. If "0" is entered as Key Code, the key will be dead and its memory will also be closed.
 4. Each of the keys programmed in this operation will have its memory (if any) opened automatically.
 5. The [C] key, if once set with Key Code 95, may be used to clear an error, but it cannot be used immediately after a Key Code entry (for the purpose of clearing the wrong Key Code error). If any Key Code is entered and then the [C] key is depressed, that Key Code will be set on the key that was once the [C] key.
 6. On depressing the final [AT/TL] key, "0.00" is displayed in the AMOUNT portion, indicating that the setting operation is completed. No printing occurs.
 7. Use the Blank Keyboard Layout on the preceding page, if necessary, for your own keyboard plan before starting the setting procedure.
 8. Brief Information on Optional Keys:
Department Keys 16 to 30 ... Key Codes 16 to 30
 Install additional Department Keys if the current Department Keys (1 to 15) are not enough to classify the merchandise in your store.

[VOID] (Void Key) ... Key Code 74

It can delete an item entered before the last item within a sale, which cannot be deleted by the **[ITEM CORR]** key.

[ALL VOID] (All Void Key) ... Key Code 75

It is used to cancel the contents in the current sale all at once.

[NS] (No-sale Key) ... Key Code 85, **[#]** (Non-add Number Print Key) ... Key Code 90

These keys are not necessary if the **[#/NS]** key is installed. If the **[#/NS]** is not installed, those keys should be separately installed for Non-add Number printing and No-sale entries respectively.

[OPEN] (Preset & Listing Capacity Open Key) ... Key Code 88

This is a dual-function key that has both **[LC OPEN]** and **[PR OPEN]** functions. By depressing this key once, both of those functions will be effective.

[TXBL TL] (Taxable Total Key) ... Key Code 99

It simply reads the Taxable Total (sale total amount + taxes due) during a sale. Since the **[ST]** can have the same function, it is usually not necessary. However, when the **[ST]** is programmed to be used to obtain the sale total amount without taxes, **[TXBL TL]** is necessary.

[TAX] (Manual Tax Key) ... Key Code 100

It is used to enter an irregular tax amount that cannot be calculated on the basis of the programmed tax tables, and to add it to the sale total. *For installing this key, please note the following in entering Key Code 100:*

Right:

1	0	0
---	---	---

 →

Key

 The last key is correctly set with Key Code 100 (**[TAX]**)

Wrong:

1	00
---	----

 →

Key

 The

00

 key is newly set with Key Code 1, which is Department 1 Key. The last key is not set with any Key Code.

[GST/M] (GST Modifier Key)... Key Code 115 (common Key Code with **[FS/M]**)

It is necessary in the GST-applicable area in Canada. It reverses the GST taxable/non-taxable status of items. Whether the key with Key Code 115 is used as **[FS/M]** or **[GST/M]** is determined by *System Option, Address 14 - Bit 1 status (refer to Chapter 22)*.

[CUR3], [CUR4] (Foreign Currency Keys 3, 4) ... Key Codes 123, 124

An additional Foreign Currency key besides **[CUR1]** and **[CUR2]**.

9. *If any of the following keys are newly installed or its location is changed, its relevant programming operations are further required (even if once programmed, re-programming is necessary because the program data has been cleared):*

Each Department Key ... Department Status, LC (if required), Preset Price (if required) of the Department

[PLU] ... PLU Table

[TX1/M], [TX2/M], [GST/M] ... Respective Tax Tables or Rates (Tax 1, Tax 2, GST)

[% +], [% -] ... Respective Preset % Rates (if required)

[CUR1] to [CUR4] ... Respective Foreign Currency Exchange Rates

16. Daily Operation Flow

The following shows a typical daily operation flow on the register.

Reference
Chapter

Before Opening the Store ...

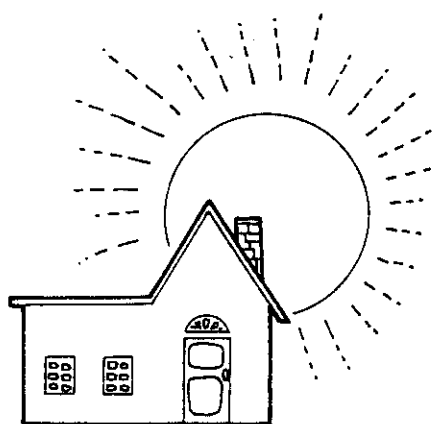

- Ensure that the register is firmly plugged in the wall outlet. 5
- Check if enough portions of Receipt and Journal rolls are left. 10
- Check the time, date, and print condition.

Check the time, date, and print by issuing a No-sale Receipt. ... 17, 18

Setting the time or date ... 12

During Business Hours ...

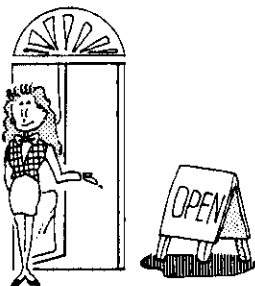

Opening the store

- Transaction entries on the register 17 to 20
- Taking Read (X) Reports periodically. 21

Closing the store

After Closing the Store ...

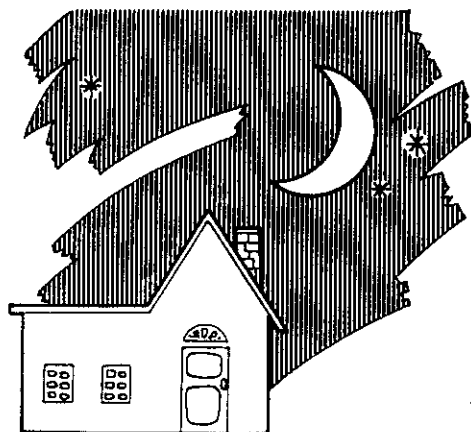

- Taking Daily Reset (Z) Reports 21
- Tear off the print portion of Journal Paper (optional). 24
- Leave the drawer open, and turn the Mode Lock to "OFF". 24
- Take all the cash and other contents from the drawer to the office with the torn Journal and printed Reset Reports.

17. Cashier Identifying Operation

The MA-315 adopts one of the following cashier-identifying methods.

- (1) Signing Method, using the [LOG/RECEIPT] key.
- (2) Cashier Lock Method, using Cashier Locks (barrel locks)
- (3) Cashier Push Key Method, using Cashier Keys (stay-down keys)

Method (1) is the standard feature. To change the cashier-identifying method from (1) to (2) or (3), appropriate System Option selections are necessary as well as hardware options. (Refer to *System Option, Address 15 - Bit 5 in Chapter 22.*)

(1) Signing Method



(LOG/RECEIPT Key)

A cashier needs to "sign ON" for starting transaction entries on the register and identifying the operator. The signed-ON condition is held until a "sign OFF" is operated. A cashier can sign ON only when the register is in the signed-OFF condition. A maximum of 8 cashiers can be identified in this signing method.

Sign ON (operable in signed-OFF condition)

Use the **REG** Key to turn the Control Lock to the **REG** (or **MGR** or **☐**) position.

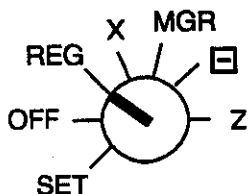

The code being entered is not displayed.

The "SIGN ON" triangular lamp illuminates, and a Sign ON receipt is issued (see the next page).



Transaction entries are now possible (see the following pages).

Cashier Code assigned to each cashier by the store (1 digit; 1 to 8)

Secret Code generated by the cashier (2 digits; any number from 01 to 99)

See **NOTE 1** below.

Sign OFF (operable in signed-ON condition)

Same Control Lock position as the Sign ON (changing the position in a signed-ON condition will cause an error.)



The "SIGN ON" triangular lamp is extinguished, and a Sign OFF receipt is issued (see the next page).

No operations in **REG**, **MGR** or **☐** mode will be allowed until a Sign ON is again operated by a cashier.

NOTES 1. The two-digit Secret Code portion, once entered for a cashier's Sign ON, is set in the memory of the register. The Secret Code of the same cashier is checked every time his/her Sign ON is operated until the Daily Financial Reset Report is taken at the end of the day. Then the Secret Code is reset and a new Secret Code entry will be allowed.

When the Secret Code is within the range of 01 to 09, it is omissible to enter the preceding zero.

2. If the [LOG/RECEIPT] key is simply depressed without a prior numeric entry or with only any Declaration Key (such as [RTN MDSE]), the Receipt ON/OFF function is activated (refer to "Receipt-issue/Non-issue Selection" in the next Chapter) but not Sign ON/OFF.

Sign ON Receipt Format

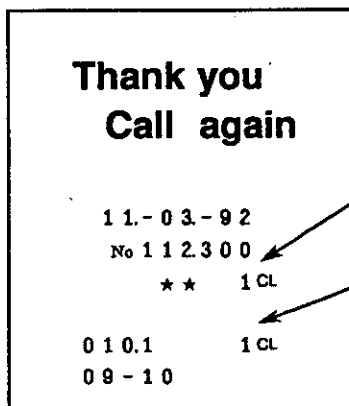

Cashier Code (1 to 8)

The signed-ON Cashier Code is printed on every sale receipt.

(The Secret Code portion is never printed.)

Sign OFF Receipt Format

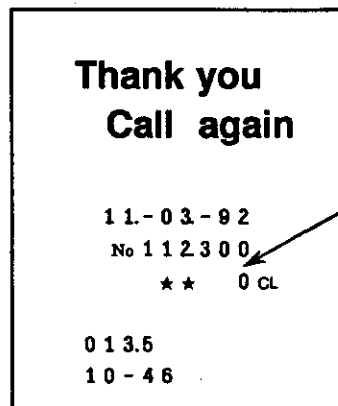

Sign OFF Code (always 0)

(2) Cashier Lock Method

This method is applied when two barrel locks are installed as cashier locks. A maximum of 4 cashiers can be identified in this method.

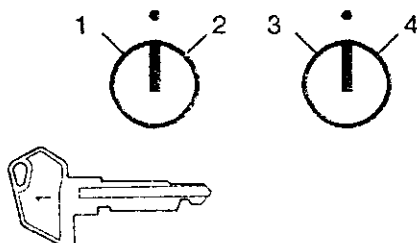

Cashier Keys 1 to 4

Each key (1 to 4) is assigned to each cashier. The register will not operate in the REG, MGR, or mode unless of these keys is inserted and turned to the position (1 to 4) corresponding to the Cashier Key No.

Each of the keys may be inserted and pulled out in the neutral position marked with a dot. When the operating cashier changes to another, the first Cashier Key must be pulled out before inserting another Cashier Key.

- NOTES 1. When this method is adopted, the signing function ("LOG" function) of the [LOG/RECEIPT] key is deactivated. Accordingly, the key is only used as Receipt ON/OFF switch.
2. No receipts are issued on turning ON or OFF a Cashier Key. However, the Cashier Code (1 to 4) is printed near the bottom of every receipt to be issued.

(3) Cashier Push Key Method

This method is applied when four push-stay-down keys are installed as cashier keys.

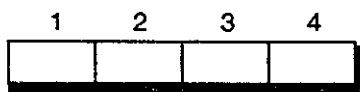

Each key (1 to 4) is assigned to each cashier. The register will not operate in the REG, MGR, or mode unless of these keys is pushed held down.

NOTE: The "NOTES 1 and 2" attached to Method (2) above are also applicable to Method (3).

18. Setting Preparation of Each Key, and Transaction Entries

This chapter describes individual key operations on transaction entries, and setting requirements for the key if necessary.

Receipt-issue/Non-issue Selection

**LOG
RECEIPT** (LOG/RECEIPT Key)

Receipts are issued or not issued according to the "R OFF" triangular lamp illuminated/extinguished status on the Operator Display panel.

"R OFF" (Receipt OFF) Lamp Status Change Operations

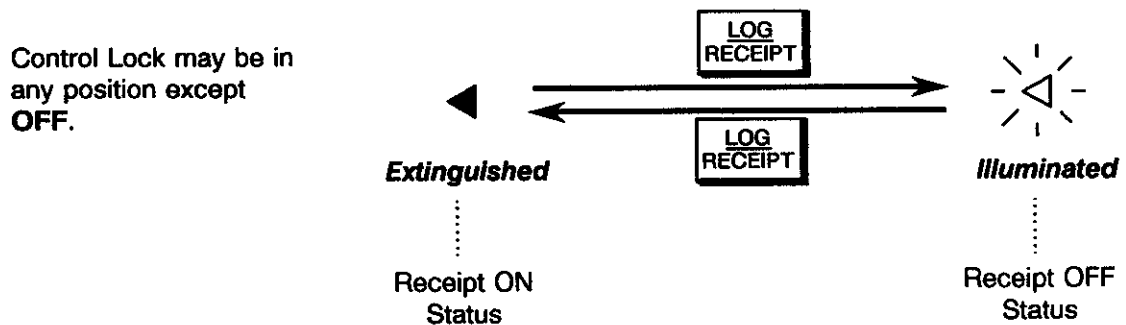







- NOTES 1.** The Control Lock may be in any position (except OFF position) for changing the Receipt ON/OFF status in the signed-ON or signed-OFF condition.
2. The "R OFF" lamp status at the starting of a transaction entry decides whether a receipt will be issued for the transaction or not. Switching the Receipt ON/OFF status during a transaction will not be effective.
 3. If a transaction entered with the "R OFF" lamp extinguished and finalized but a receipt is required, the [RECEIPT ISSUE] (Post-issue Receipt) key can be operated to issue a receipt (see "Post-issue Receipt" on page 85).
 4. Simply depress the [LOG/RECEIPT] key without a numeric entry. If the key is depressed with a prior numeric entry in "REG", "MGR", or "☐" mode, it may turn out to be a Sign ON or Sign OFF operation when the Singing Method is selected for cashier identification (refer to the preceding chapter). However, if any Declaration Key (such as [RTN MDSE]) is already pressed and then the [LOG/RECEIPT] key is pressed, the Declaration Key entry is not canceled by the Receipt ON/OFF status change.

Clearing Errors, or Clearing Wrong Declaration Key or Wrong Numeric Entries

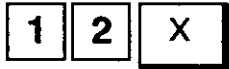

When in sale entries an error has occurred with an alarm buzzer (beeps for about 2 seconds only), a wrong Declaration Key (such as [RTN MDSE], [TX/M], [GST/M], etc.) has been depressed, or a wrong numeric data has been entered; depress the [C] key.

- 1) Error has occurred (the alarm buzzer is generated and the "ALM" lamp illuminates), and the keyboard is locked. →  → The error condition is cleared (the buzzer tone stops and the "ALM" lamp is extinguished). Find the cause of the error, and do the operation again. Refer to "Possible Cause of Error" attached where an error may occur in each operation sequence on the following procedure.
- 2) Declaration Key has been depressed.
ex.) 
- 3) Numeric Keys are entered.
ex.) 
- 4) Declaration Key(s) + Numeric Keys
ex.) 
- 5) Numeric Keys + Non-motorized Key (key that does not trigger printing)
ex.) 
- 6) Combination of 2) to 5) →  → The entered data are all cleared at once.
- 7) Combination of 6) + 1) →  → The entered data are all cleared at once, and the error condition is cleared also. Refer to 1) for finding the cause of error.

NOTE: When data is already entered and printed (through a Department Key, etc.), it cannot be cleared by the [C] key any longer. In need of deleting such data, see the following:

Item Correction (Last Line Voiding)  page 63

Void (Designated Line Voiding)  page 65

All Void (Transaction Cancel)  page 66

Operations in "□" Mode Chapter 20 (page 91)

Department Keys Dept. 1 to Dept. 30

Programming Department Keys

These are department keys through which sales items are registered. A maximum of 30 keys may be installed (Depts 16 to 30 are optional keys).

Programming Department Status:

To use Department Keys, first program how each Department Key is to be used, in accordance with merchandise categories, taxation, operativity of the key, etc.

Condition: After Daily Financial Reset and Periodical Financial Reset (and All PLU Reset if the positive/negative status is to be set)
(refer to "NOTE on Condition" on page 23)

Programming Procedure:

Use the MA Key to turn the Control Lock to "SET".

As for items marked with "NOTE", refer to the corresponding NOTE No. on the next page for further description.

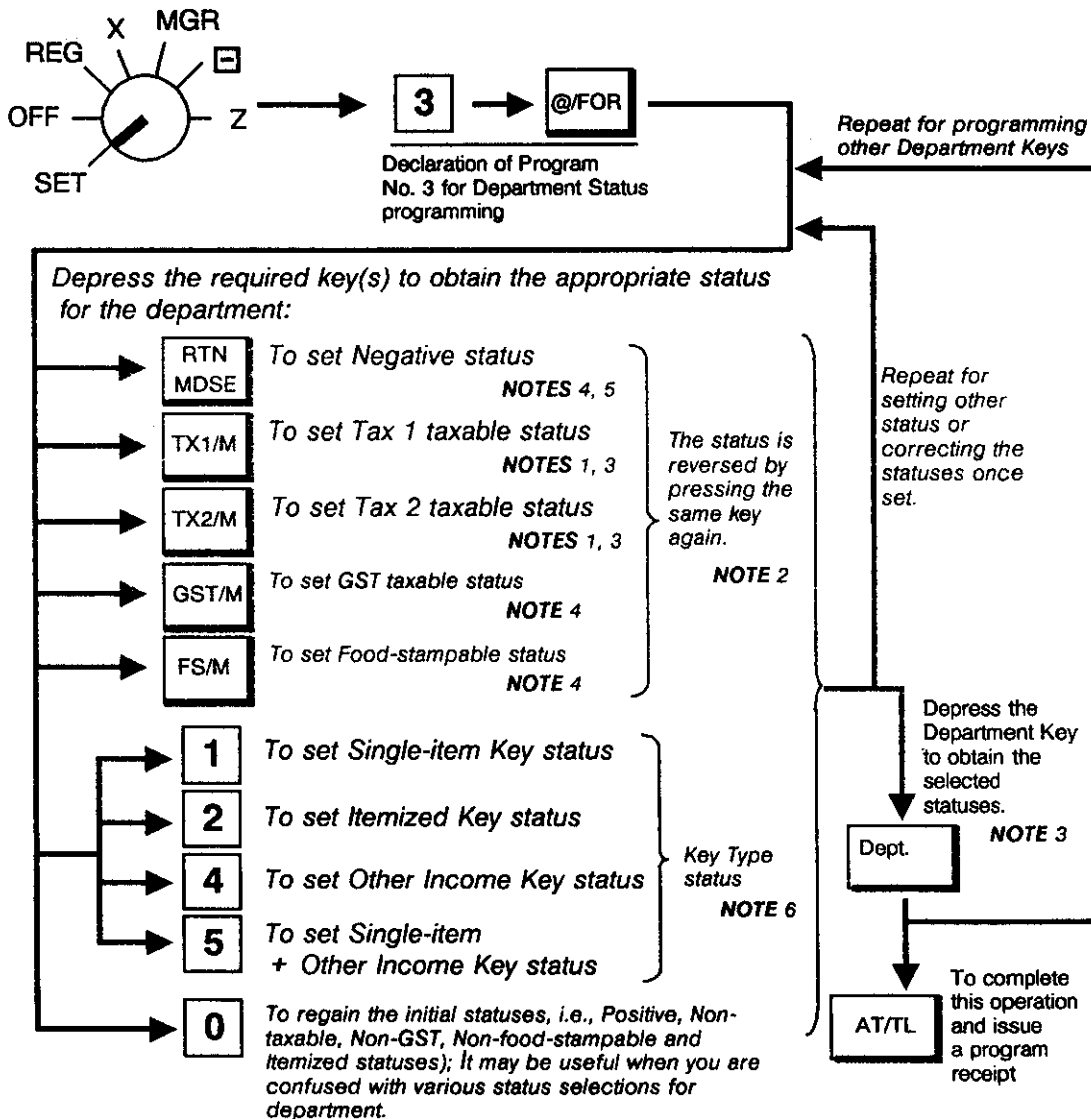

- NOTES 1.** The tax tables of "Tax 1", "Tax 2", and "GST" should be programmed in Chapter "13. Tax Table Setting". Those tax tables will become effective in "REG", "MGR" or "☐" mode for adding the taxes to sale items entered through a Department Keys only when the Department Key is programmed with taxable status for the required tax in this operation.
2. Every time each of the [RTN MDSE], [TX1/M], [TX2/M], [GST/M] and [FS/M] keys in this operation is pressed, the preset status is reversed. For example, if a Department Key is already set with "Tax 1 Taxable" status and the [TX1/M] key is pressed during the setting sequence of that Department Key, it is now set with "Tax 1 Non-taxable" status. If [TX1/M] is again pressed, "Tax 1 Taxable" status is again obtained.
3. The tax (PST) status obtained (as the result of [TX1/M] and/or [TX2/M] depressions) can be verified by reading the numeric value displayed in the rightmost digit of the AMOUNT portion when the individual Department Key is pressed. Similarly, the Key Type status is displayed in the 2nd digit (next to the rightmost digit).

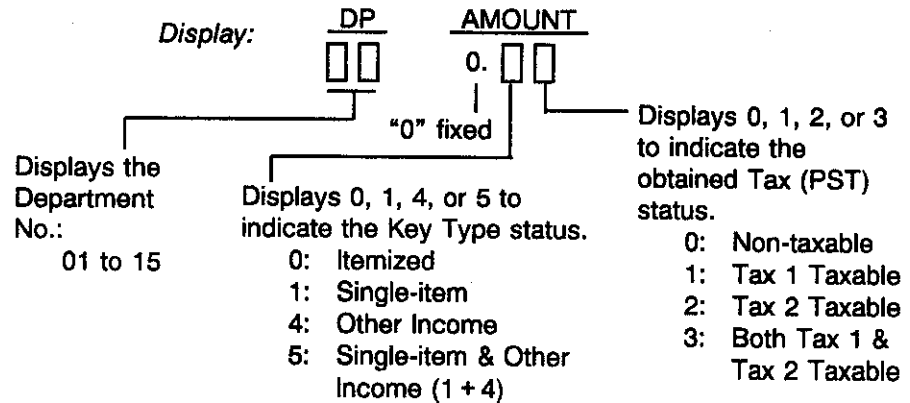

(These status codes are also printed on the program receipt issued when the final [AT/TL] key is pressed; refer to the Receipt Format on next page.)

4. The Negative/Positive status, GST status and Food Stamp status can only be verified on the program receipt (refer to next page) but not in the display. If a wrong status has been set, correct it by performing the programming operation again.
5. If a Department Key is set with Negative status, an amount entered through that key is subtracted from the sale total. It may be used for item entries of coupons, returned bottles, etc.
6. Key Type Description
- Itemized Key:** When a sale item amount is entered through this key, the sale is not finalized until a media key (such as [AT/TL]) is operated. Other items can be entered within one sale receipt sequence.
- Single-item Key:** A sale item entry through this key will automatically finalize the sale as cash outside a sale (i.e. when no other items have been entered within one receipt sequence). However, it will function just as an Itemized Key if operated inside a sale.
- Other Income Key:** It is used to enter items which do not directly become sales for the store, such as lottery, postage, gift wrapping fee, size adjustment fee, utility (payment of electricity and gas), and donation.

Department Status Program Receipt Format:

Key Operation

Control Lock: SET

3 @/FOR

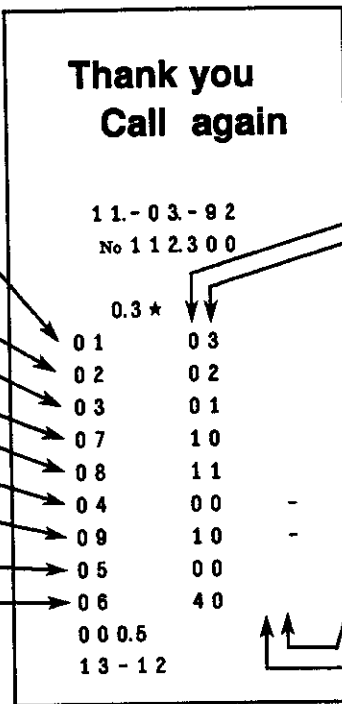
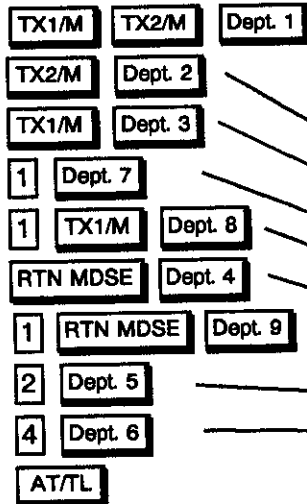

Key Type Status

- 0: Itemized
- 1: Single-item
- 4: Other Income
- 5: Single-item & Other Income

Tax Status (PST)

- 0: Non-taxable
- 1: Tax 1 Taxable
- 2: Tax 2 Taxable
- 3: Both Tax 1 & Tax 2 Taxable

Positive/Negative Status

- Blank: Positive
- : Negative

GST (for CANADA) or Food Stamp Status (for US)

- FS: GST Taxable or Food Stampable
- Blank: GST Non-taxable or Non-food-stampable

Programming Department LCs (Listing Capacities):

The LC setting is used to check an amount limit error. By setting the LC, an amount entry (due perhaps to a mistake by the operator) will be prevented at the earliest stage (i.e. an error will result on entering an excessive amount through the department key).

Condition: After Daily Financial Reset
(refer to "NOTE on Condition" on page 23)

Programming Procedure:

Use the **MA Key** to turn the Control Lock to "SET".

As for items marked with "NOTE", refer to the corresponding NOTE No. on the next page for further description.

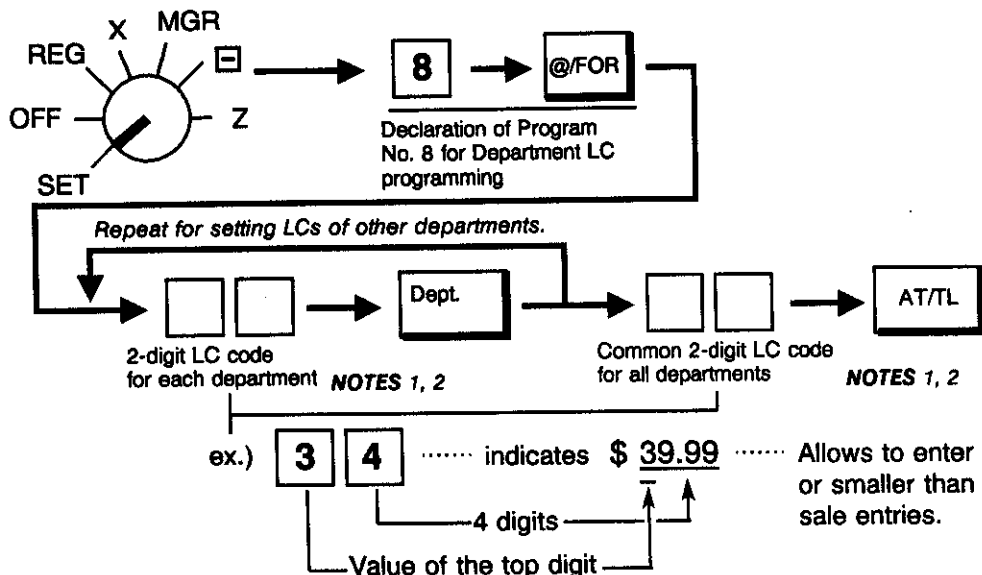

- NOTES 1.** If the individual LC of a department is set, it prevails over the common LC for all departments.
- 2.** To reset a LC once set, enter "0" in place of the 2-digit LC code. Then a maximum of 7-digit amount can be entered in sale entries.

Department LC Program Receipt Format:

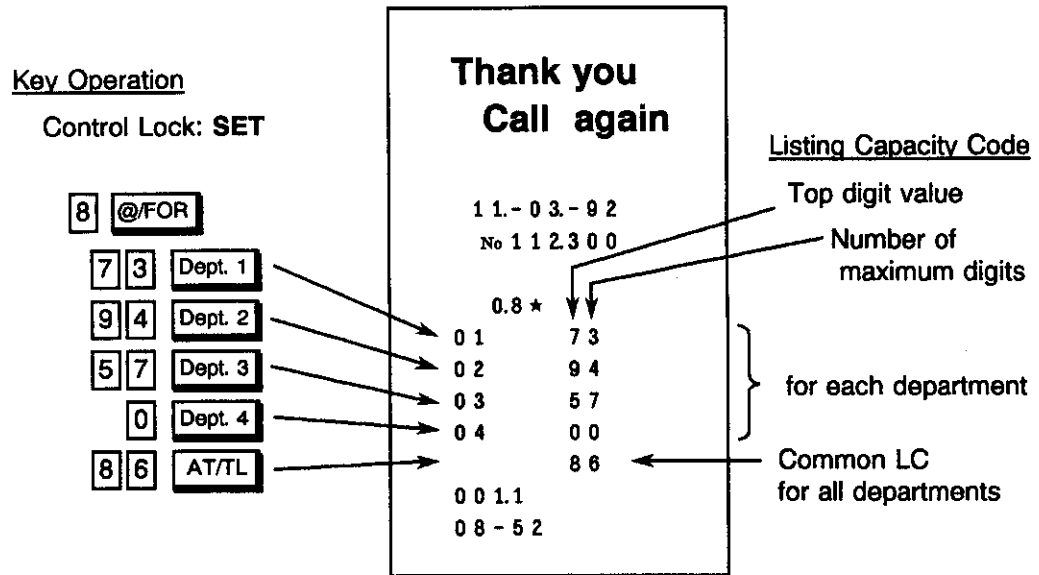

Setting Department Preset Prices:

If a fixed price is always entered through a Department Key in sale entries, a preset price can be set on the Department Key. Please note that once set with a preset price, the Department Key will not accept any other price (open price) unless the [PR OPEN] or [OPEN] key is operated or until the Department Key is again programmed to be an open department.

Condition: Any time outside a sale. Must be signed off in Cashier Signing Method.

Programming Procedure:

Use the MA Key to turn the Control Lock to "SET".

NOTES 1, 2
To set Open Department (to allow manual amount entries)

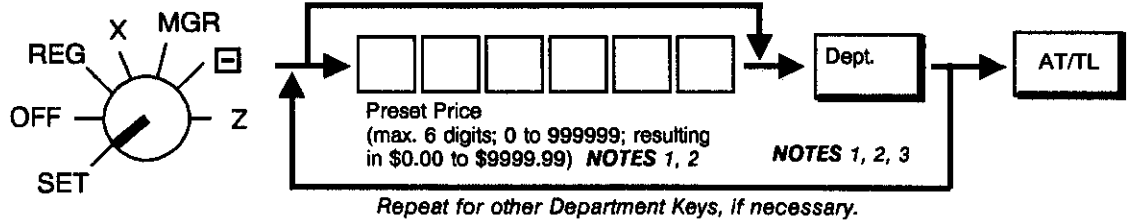

- NOTES 1.** All the Department Keys are open departments (no preset price set) as initial status.
- 2.** If a Department Key is pressed with no Preset Price entry, the Key is set as an open-price Department Key.
- 3.** If "0" is entered as Preset Price, the Department Key is set with Preset Price of \$0.00.

Department Preset Price Setting Receipt Format:

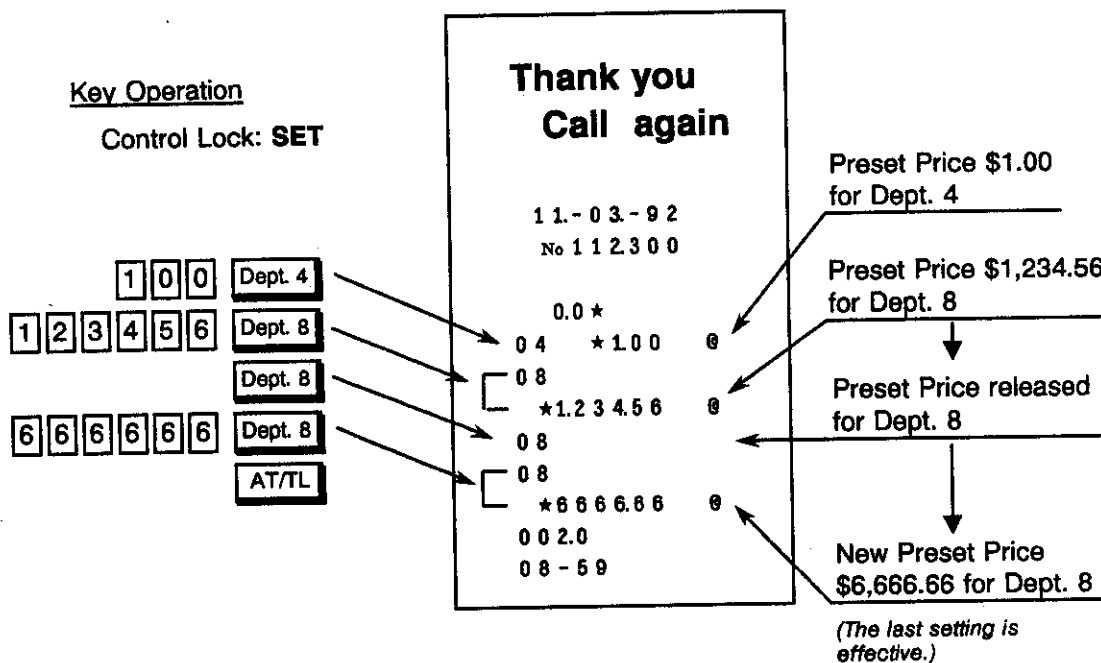

Sale Item Entries Using Department Keys

Various types of department entries are shown below.

Use the **REG Key** to turn to the Control Lock to "REG" position.

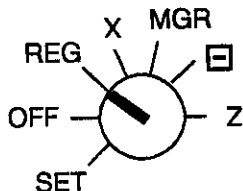

Cashier Sign ON is necessary or a Cashier Key must be set to ON. (Refer to Chapter 17.)

Entry of One Item:

Open-price Department

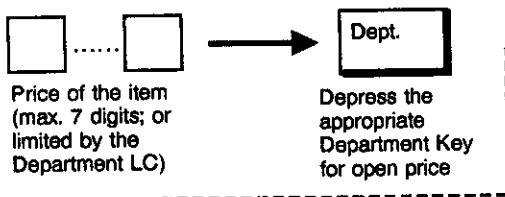

If an error occurs here:

- Possible cause of error:*
- The price entered exceeds the LC. → See the **Listing Capacity Open Entry**.
 - The Department Key is a preset-price key. → Use an open-price Department Key, or see the "Preset-price Department" entry procedure on next page.
 - Entries through that Department requires Manager Intervention. → Ask the manager to turn the Control Lock to **MGR** position. (Refer to Chapter 19.)

Receipt Print Format

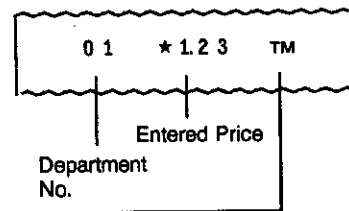

Status Symbol
 TM: Tax 1 or Tax 2 (PST) Taxable
 FM: GST Taxable, or Food Stampable
 TMFM: Tax (PST) Taxable and GST Taxable or Food Stampable
 Blank: Not applicable to any of the above status.

Preset-price Department

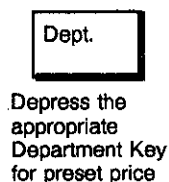

If an error occurs here:

Possible cause of error:

- The Department Key is an open-price key.
 - Use a preset-price Department Key, or see the "Open-price Department" entry on the preceding page.
- Entries through that Department requires Manager Intervention.
 - Ask the manager to turn the Control Lock to MGR position. (Refer to Chapter 19.)

Receipt Print Format

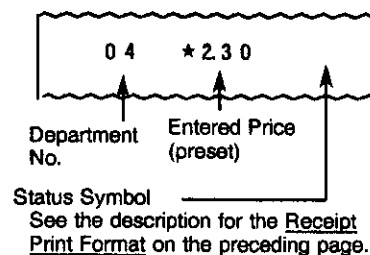

Department Repeat Entry:

Depress again the Department Key used for the department item entry just entered. The item entry is repeated as many times as the Department Key is depressed. (A negative Department entry cannot be repeated.)

Open-price Department Repeat

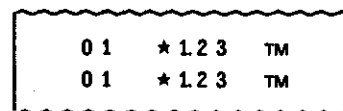
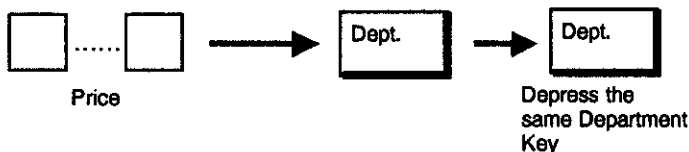

Preset-price Department Repeat

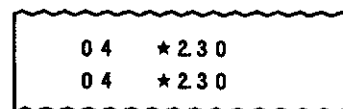
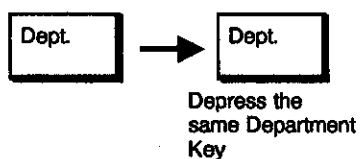

Other Income Department:

Other Income Department Key is used to enter items which do not directly become sales for the store, such as lottery, postage, gift wrapping fee, size adjustment fee, utility (payment of electricity and gas), and donation. Only the difference from ordinary Department Keys is that the amounts entered through this key are processed separately from the ordinary sales total (refer to Chapter "21. Read & Reset Reports").

The operation procedure is the same as ordinary (itemized) Department Keys.

ex.) If Dept. 6 is programmed with no preset price and status of "Other Income", "Itemized", "Non-taxable":

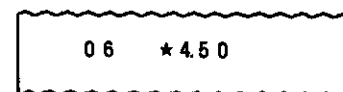
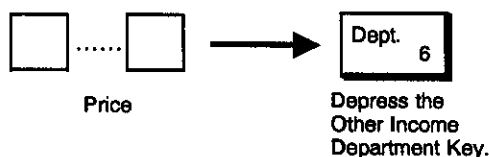

Department Quantity Extension (Multiplication):

When more than three or four items are to be entered with the same Department and price, the Quantity Extension (multiplication) is quicker than the Repeat Entry.

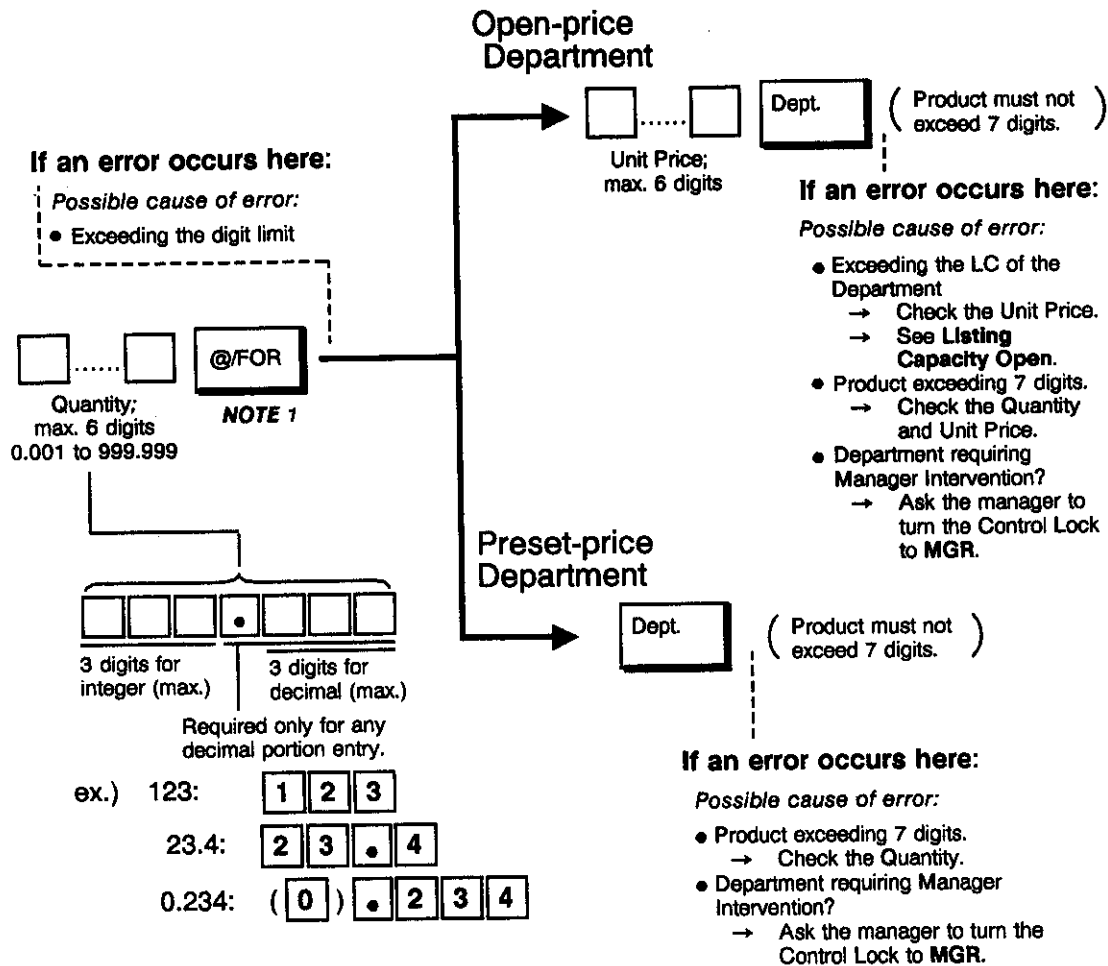

- NOTES 1.** When the Quantity is a 1-digit integer (1 to 9) and a Preset-price Department Key is to follow, the [@/FOR] key is omissible.
- The product obtained by Quantity Extension cannot be repeated.
 - The decimal portion of the Quantity entry is processed down to the 2 digits below the decimal point. The fraction rounding at this time is fixed to ROUND OFF.
 - You can select the rounding process of the fractions of the product (result of multiplication) -- ROUND OFF (initial setting), ROUND UP, or ROUND DOWN. (Refer to Chapter "22. System Option Setting" Address 2 - Bits 1 and 2.

Receipt Print Format for Department Quantity Extension

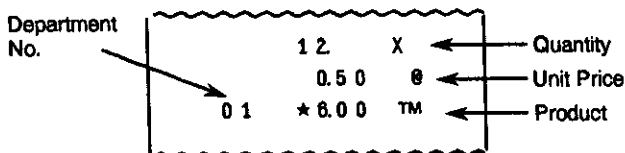

Department SPP (Split-Package-Pricing):

This operation is used when a customer purchases only part but not all of the items in a package (example: only two tomatoes in a priced package of three tomatoes).

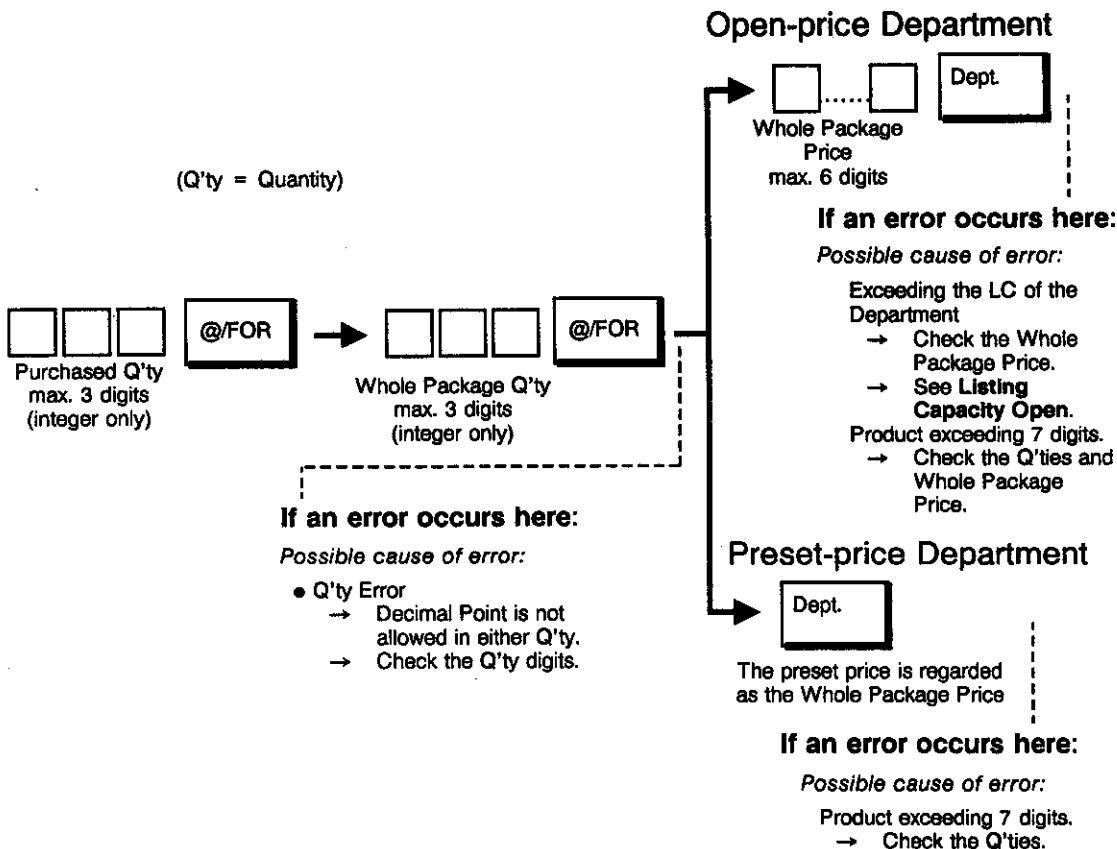

- NOTES**
1. The product (final result amount) obtained by SPP (Split-Package-Pricing) cannot be repeated.
 2. The product must not exceed 7 digits.
 3. The rounding process of the fractions of the product is ROUND UP PRODUCT as initial status. It can be changed to ROUND UP ITEM PRICE (refer to Chapter 22, System Option Setting, Address 2 - Bit 5.)

Receipt Print Format for Department SPP

Example)

Purchased Quantity = 2
Whole Package Quantity = 3
Whole Package Price = \$1.00
Entered through Dept. 1 (open-price, Taxable department)

2 @/FOR 3 @/FOR 1 0 0 Dept. 1

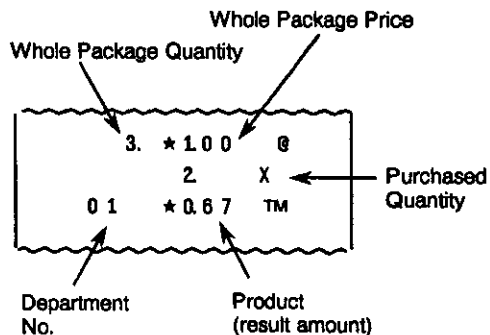

Single-item Department Entry:

If a Department Key is programmed with Single-item status, an entry through the key immediately finalizes the sale as cash and issues a receipt without operating a media key.

Such keys are operated in the same way as ordinary (itemized) Department Keys already described, except that Repeat Entry is not possible using Single-item Department Keys.

- NOTES 1.** A sale item entry through this key will automatically finalize the sale as cash outside a sale (i.e. when no other items have been entered within one receipt sequence). However, it will function just as an Itemized Key if operated inside a sale.
- 2.** Quantity Extension and SPP are also possible using Single-item Department Keys.

Receipt Print Format for Single-item Department Entries

Example 1) -- Entry outside a sale --
 When no sale is under way, an item of \$10.00 is entered through Dept. 7 which is a Single-item department.
 The sale is automatically finalized as cash and a receipt is issued.

1 0 0 0 Dept. 7

**Thank you
Call again**

1 1 . - 0 3 - 9 2
No 1 1 2 3 0 0

0 7 * 1 0 . 0 0
* 1 0 . 0 0 CATL

0 1 0 . 5 1 CL

0 9 - 1 2

Store Name Stamp space
Date
Register No.
Automatically finalized as cash sale (Cash Total)
Receipt Consecutive No.
Current Time Cashier Code

Example 2) -- Entry inside a sale --
 An item of \$5.00 is first entered through Dept. 1 which is an Itemized department.
 Then an item of \$10.00 is entered through Dept. 7 which is a Single-item department.
 The sale is not finalized until a media key is operated.

5 0 0 Dept. 1
1 0 0 0 Dept. 7

**Thank you
Call again**

1 1 . - 0 3 - 9 2
No 1 1 2 3 0 0

0 1 * 5 . 0 0 TM
0 7 * 1 0 . 0 0

⋮

PLU (Price-Look-Up)

PLU (PLU Key)

A "PLU" is an individual merchandise item programmed with its own item code (PLU Code), its link department (and mostly with a Preset Price). By programming PLUs, you can enter an individual item by entering its PLU Code (which should be written on the price tag of the item), instead of entering the price through a Department Key. By taking PLUs Reports, you can analyze the sales data of each individual item. A maximum of 300 PLUs can be programmed.

Programming PLUs**Programming PLU Table:**

Condition: *To change settings of a PLU:* When the required PLU sales total memory is zero (i.e. when no sales are made or after a PLU Reset Report is taken to reset the sales data of the PLU into zero)

To add new PLUs: Any time outside a sale. Must be signed off in Cashier Signing Method.

(refer to "NOTE on Condition" on page 23)

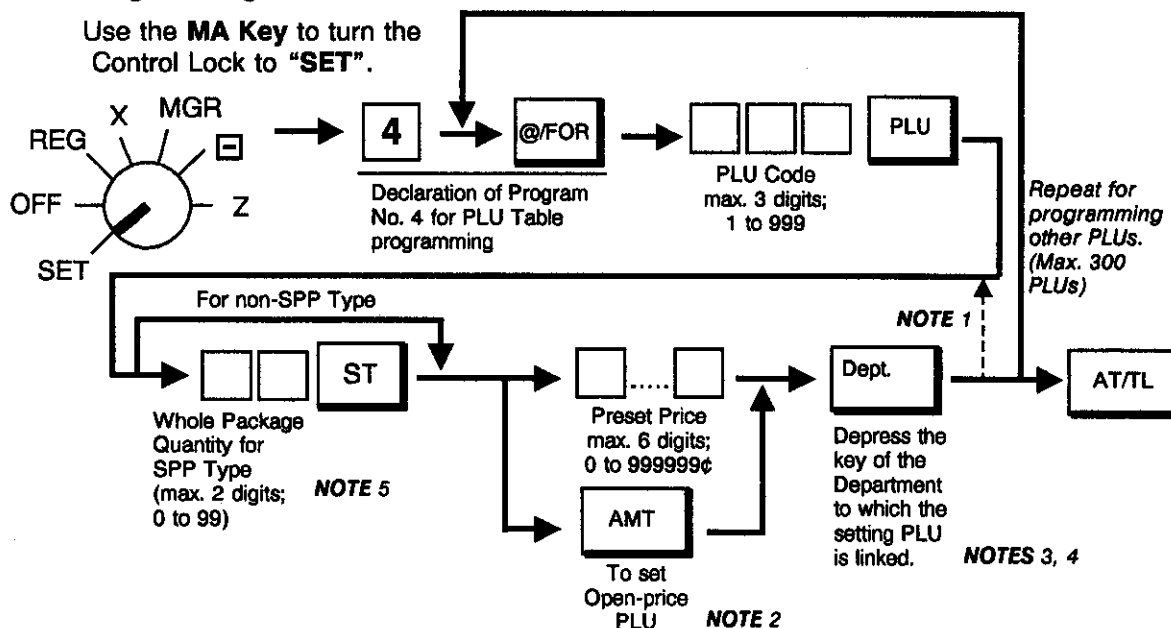
Programming Procedure:

- NOTES 1.** When sequentially programming the PLUs, the code specification can be omitted. When it is omitted at the very first PLU, PLU Code "1" is automatically assigned.
- 2.** An Open-price PLU always requires a price entry through Numeric Keys in sale entries, and may be used for an item that frequently changes its price.
- 3.** The Department Key must not be an Other Income Department. If an Other Income Department Key is depressed, no error occurs here but will occur on entering the PLU in sale entries.
- 4.** The statuses (Positive/Negative Status, Tax (PST) 1 & 2 Status, GST or Food Stamp Status, and Key Type Status except Other Income) of each PLU is decided by the statuses of the Department to which the PLU is linked.
- 5.** SPP = Split-Package-Pricing; refer to **PLU SPP** in **Sale Item Entries of PLUs** on the following pages. The "Preset Price" to follow will be the Whole Package Price for a SPP-type PLU.

PLU Table Program Receipt Format:

Key Operation

Control Lock: **SET**

4 **@/FOR**

PLU Code	Whole Package Quantity	Preset Price	Link Dept.
5 PLU		100	Dept. 4
10 PLU		200	Dept. 2
(11) PLU		12300	Dept. 1
999 PLU		1000	Dept. 3
300 PLU		50	Dept. 5
400 PLU		300	Dept. 9
500 PLU		AMT	Dept. 3
(501) PLU	3 ST	1000	Dept. 1
(502) PLU	10 ST	AMT	Dept. 2
AT/TL			

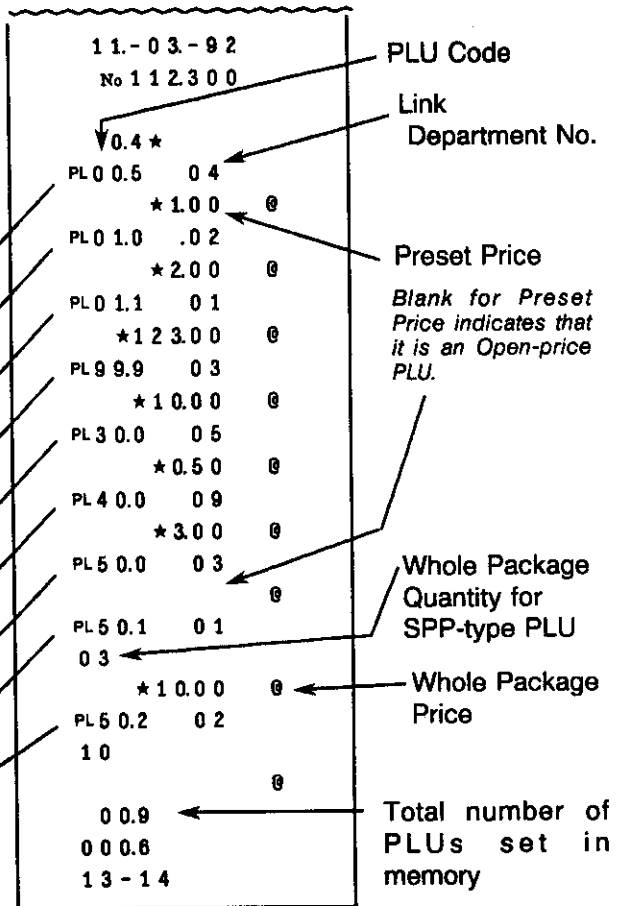

Deleting Individual PLUs:

When any of the PLUs once programmed are not handled any more in the store, they can be deleted.

Condition: When the required PLU sales total memory is zero (i.e. when no sales are made or after a PLU Reset Report is taken to reset the sales data of the PLU into zero)

(refer to "NOTE on Condition" on page 23)

Deleting Procedure:

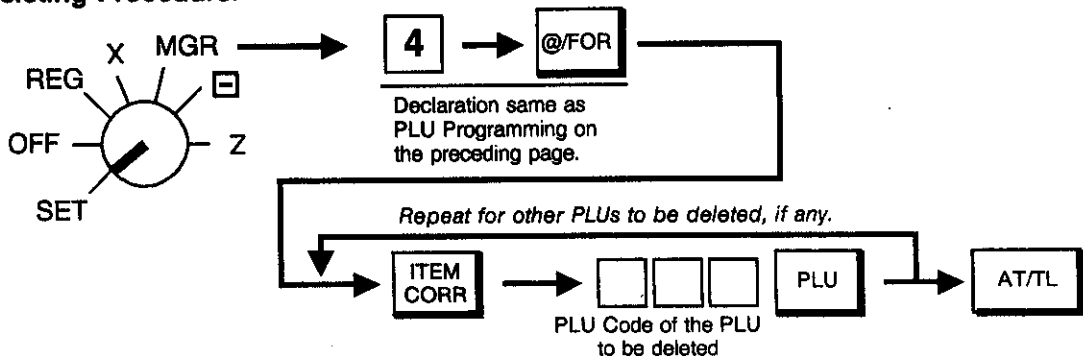

NOTES 1. Deletions are possible PLU by PLU.

2. If all the PLUs must be deleted (i.e., the PLU system itself is not necessary), close the **[PLU]** Key. (Refer to Chapter 15.)

PLU Deletion Receipt Format:

Key Operation

Control Lock: **SET**

4 **@/FOR**

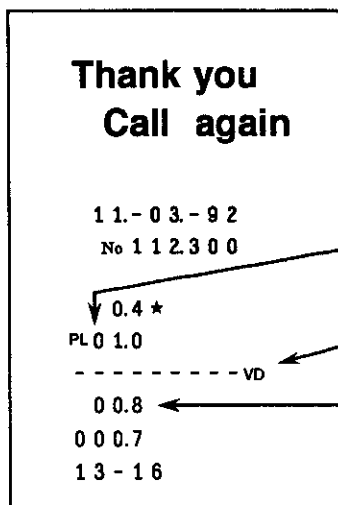
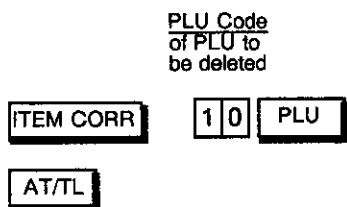

PLU Code deleted

Deletion Symbol Line

Total number of PLUs remaining set in memory

Changing PLU Preset Prices or Whole Package Quantity:

When only changing preset prices and/or whole package quantities of PLUs as part of daily requirements, this operation is quicker than operating "Programming PLU Table".

Condition: Any time outside a sale. Must be signed off in the Cashier Signing Method.

Programming Procedure:

Use the **MA Key** to turn the Control Lock to "SET".

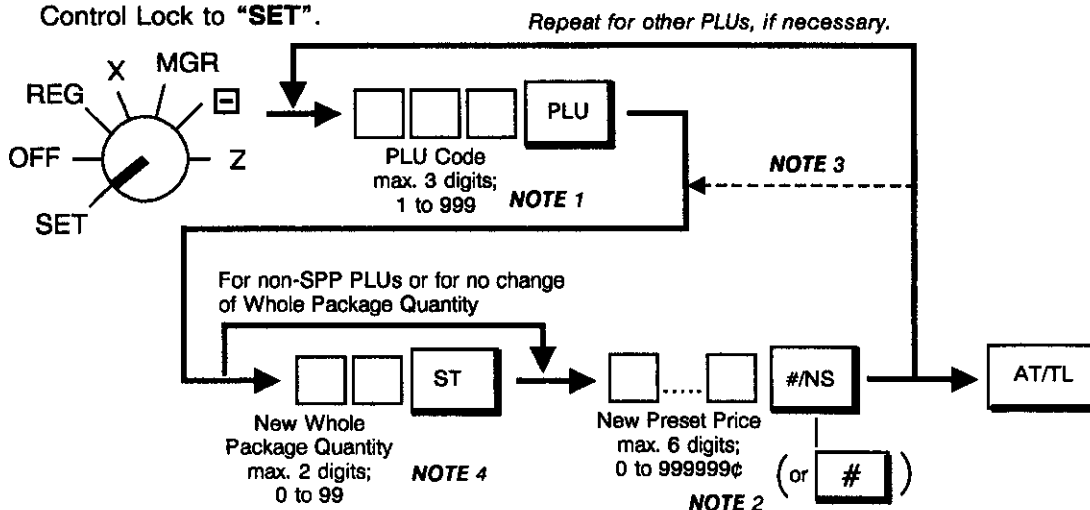

- NOTES 1.** The PLU Codes must exist in the PLU table file already programmed.
2. If "0" is entered as the New Preset Price, price of \$0.00 is set. Neither price setting nor Whole Package Quantity changing are possible for Open-price PLUs in this operation.
3. For sequentially accessing PLU Codes, the code specification can be omitted.
4. The entry of "New Whole Package Quantity" is possible only for SPP-type PLUs (those already set with Whole Package Quantity). When the Whole Package Quantity is changed here, the New Preset Price (i.e., New Whole Package Price) must also be set here.

PLU Price Change Setting Receipt Format:

Key Operation

Control Lock: **SET**

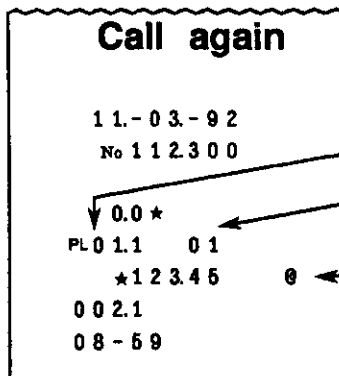
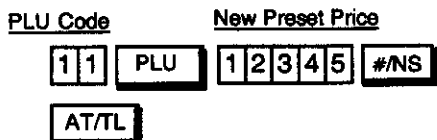

Sale Item Entries of PLUs

Various types of PLU entries are shown below.

Use the **REG Key** to turn the Control Lock to "REG".

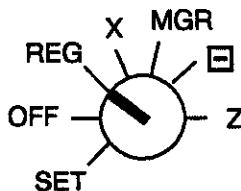

Cashier Sign ON is necessary or a Cashier Key must be set to ON. (Refer to Chapter 17.)

Entry of One PLU Item:

Preset-price PLU

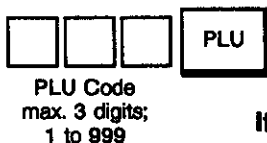

If an error occurs here:

Possible cause of error:

- Undefined PLU Code has been entered.
→ Enter a code of those PLUs programmed.

Open-price PLU

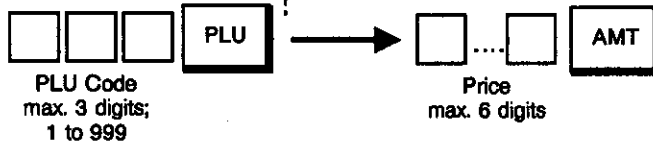

If an error occurs here:

Possible cause of error:

- Exceeding the price digit limit.
→ Check the price.
- The PLU Code entered is a Preset-price PLU.
→ In that case the PLU item is already entered and printed on the [PLU] key depression. Check if the PLU Code and the price are correct.

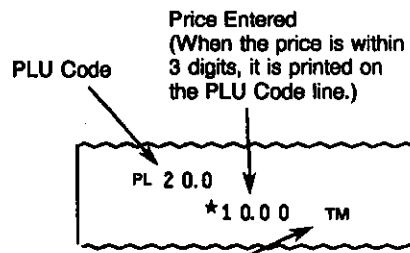

Status Symbol (same with Dept. Items)

- TM: Tax 1 or Tax 2 (PST) Taxable
- FM: GST Taxable or Food-stampable
- TMFM: Tax (PST) Taxable and GST Taxable or Food-stampable
- Blank: Not applicable to any of the above status.

PLU Repeat Entry:

Depress again the last key of the sequence for "Entry of One PLU Item" on the preceding page. The item entry is repeated as many times as the last key is depressed. (A negative PLU entry cannot be repeated.)

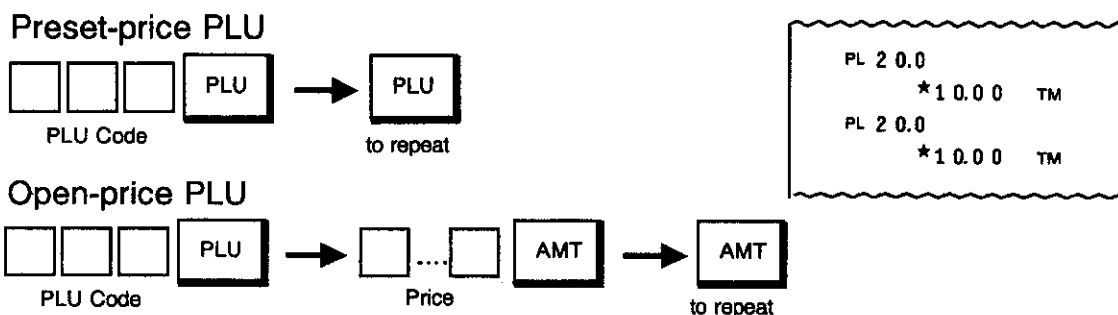

PLU Quantity Extension (Multiplication):

When more than three or four items are to be entered with the same PLU item, the Quantity Extension (multiplication) is quicker than the Repeat Entry.

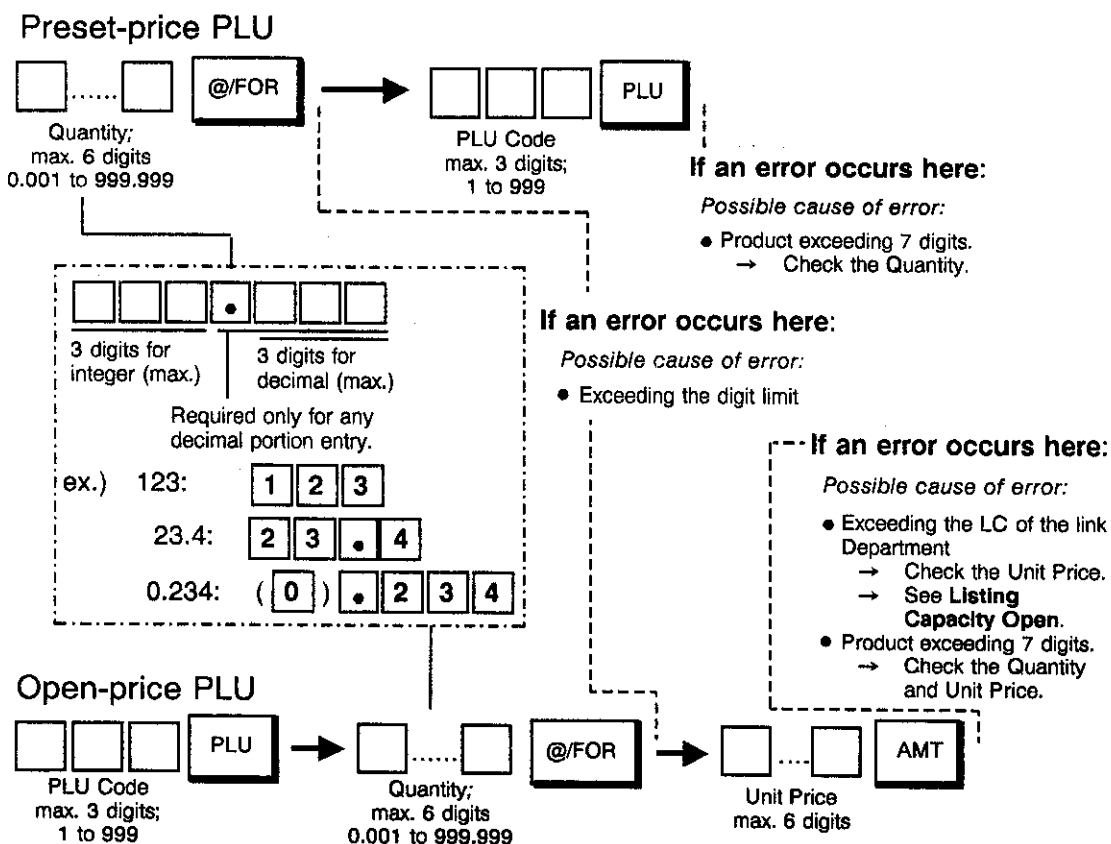

NOTES 1. The product obtained by Quantity Extension cannot be repeated.

2. The decimal portion of the Quantity entry is processed down to the 2 digits below the decimal point. The fraction rounding at this time is fixed to ROUND OFF.

- You can select the rounding process of the fractions of the product (result of multiplication) -- ROUND OFF (initial setting), ROUND UP, or ROUND DOWN. (Refer to Chapter "22. System Option Setting" Address 2 - Bits 1 and 2.)

Receipt Print Format for PLU Quantity Extension

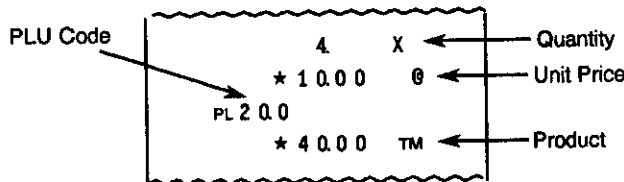

PLU SPP (Split-Package-Pricing):

This operation is used when a customer purchases only part but not all of the items in a PLU package (example; only two tomatoes in a priced package of three tomatoes). (Also, refer to "Department SPP" already described.)

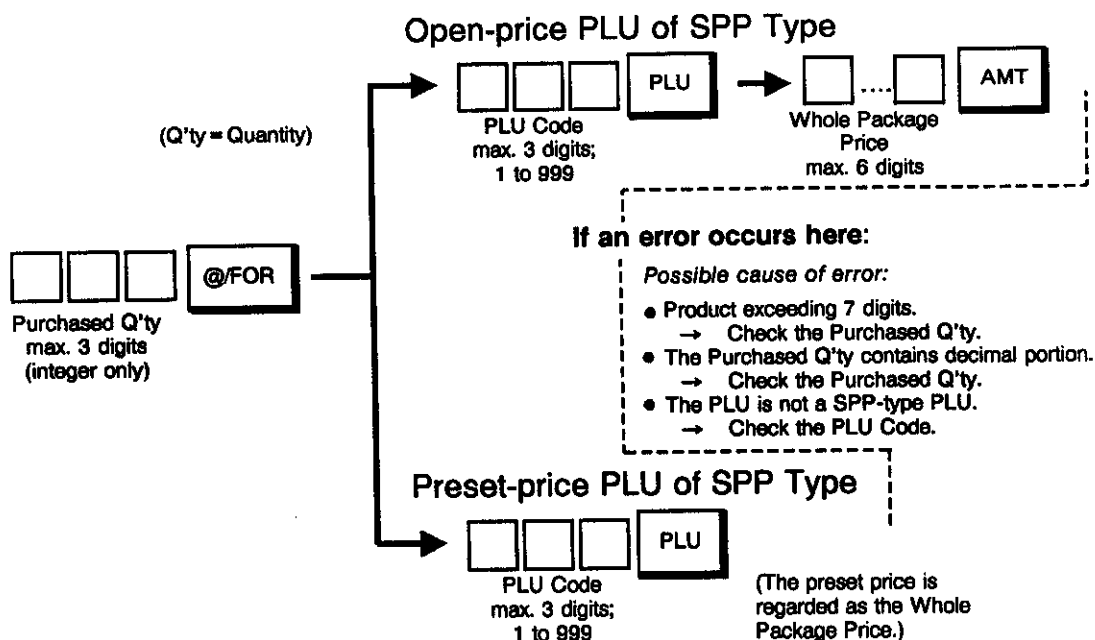

Receipt Print Format for PLU SPP

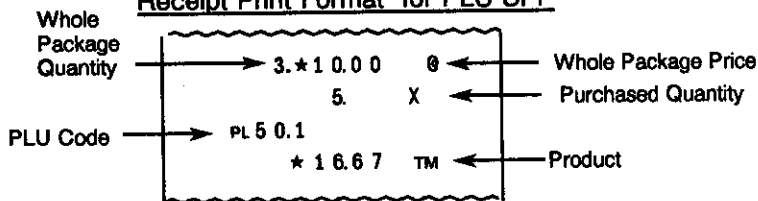

- NOTES 1.** The product (final result amount) obtained by SPP cannot be repeated.
- The product must not exceed 7 digits.
 - The rounding process of the fractions of the product is ROUND UP PRODUCT as initial status. It can be changed to ROUND UP ITEM PRICE (refer to Chapter 22, System Option Address 2 - Bit 5).
 - PLU SPP is possible only using the PLUs of SPP Type (i.e., programmed with Whole Package Quantity).

Single-Item PLU Entry:

If a Department Key is programmed with Single-item status, an entry through a PLU which links to the Department immediately finalizes the sale as cash and issues a receipt without operating a media key (just as the operation using a Single-item Department Key).

Such PLUs are operated in the same way as ordinary (itemized) PLUs already described, except that Repeat Entry is not possible using Single-item PLUs.

NOTES 1. An item entry through such a PLU will automatically finalize the sale as cash outside a sale (i.e. when no other items have been entered within one receipt sequence). However, it will function just as an Itemized PLU if operated inside a sale.

2. Quantity Extension and SPP are also possible using Single-item PLUs.

Receipt Print Format for Single-item PLU Entries

Example 1) -- Entry outside a sale --

When no sale is under way, a PLU item (PLU Code 101, Preset Price \$3.40, linking to a Single-item and Non-taxable department) is entered .

The sale is automatically finalized as cash and a receipt is issued.

1 0 1 PLU

**Thank you
Call again**

11.-03.-92
No 112300

PL 10.1 *3.40
 *3.40 CATL
0107 1 CL
09-.18

Example 2) -- Entry inside a sale --

An item of \$5.00 is first entered through Dept. 1 which is an Itemized department.

Then an item of PLU Code 101 (defined as in *Example 1*) above is entered.

The sale is not finalized until a media key is operated.

5 0 0 Dept. 1
1 0 1 PLU

**Thank you
Call again**

11.-03.-92
No 112300

01 *5.00 TM
PL 10.1 *3.40

⋮

Preset Price Open **PR OPEN** (Preset Open Key) **OPEN** (Open Key)

When an open price must be entered through a Preset-price Department, use the **[PR OPEN]** (or **[OPEN]**) key to release the preset-price status temporarily. Then a price different from the preset-price can be entered for that entry only, in the way as operating an Open-price Department.

Depress **NOTE 1** **PR OPEN** or **NOTES 1, 3** **OPEN** prior to or any time during the entry sequence of the following operations for Open-price Departments (actually operating a Preset-price Department instead) already described:

- Entry of One Department Item** *NOTE 2*
- Other Income Department**
- Department Quantity Extension**
- Department SPP**
- Single-Item Department Entry**

- NOTES 1.** The **[PR OPEN]** (or **[OPEN]**) key must be pressed, at the latest, before the final key of the required Department entry sequence.
2. A price entry by Preset Price Open cannot be repeated. Even if the Preset-price Department Key that has just been used in a Preset Price Open entry sequence is again depressed, the preset price of the key will be entered but not the open price.
3. The **[OPEN]** key is a dual-function key. By depressing it once, it functions as both **[LC OPEN]** and **[PR OPEN]**. For the LC Open function, see the next page.
4. The Preset Price Open entry is not possible for any PLUs.

Example 1) **Entry of One Department Item** sequence:

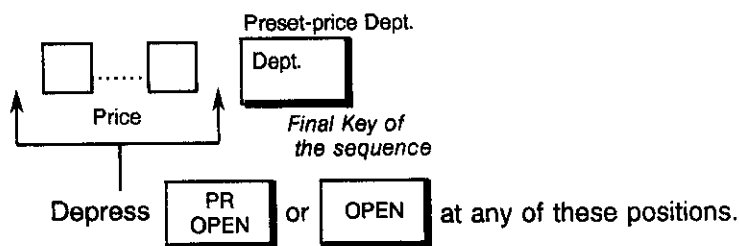

Example 2) **Department Quantity Extension** sequence:

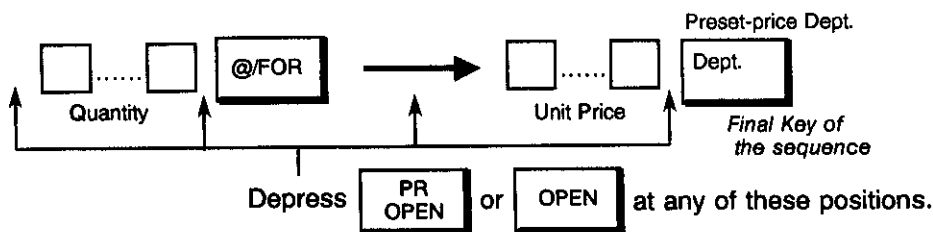

Please note that the entry sequence is the same as that of Open-price Departments, except that the **[PR OPEN]** (or **[OPEN]**) key is additionally depressed and a Preset-price Department Key is operated instead of an Open-price Department.

Listing Capacity Open **LC OPEN** (Listing Capacity Open Key) **OPEN** (Open Key)

As for setting LCs, see "Programming Department LCs" in the "Department Keys" section.

When an item entry price exceeds the LC in sale entries, an error will result. To enter a price larger than the limit defined by the LC, use the **[LC OPEN]** or **[OPEN]** key.

Depress **[LC OPEN]** prior to or any time during the entry sequence of the following operations for Open-price Departments and PLUs already described:

- Entry of One Department Item
- Department Repeat Entry (NOTE)
- Other Income Department
- Department Quantity Extension
- Department SPP
- Single-Item Department Entry
- Entry of One PLU Item
- PLU Repeat Entry (NOTE)
- PLU Quantity Extension
- Single-Item PLU Entry

NOTE: When [OPEN] key is used instead of [LC OPEN], Repeat Entry is not possible (because the [PR OPEN] key function also becomes effective).

Please note that the **[LC OPEN]** or **[OPEN]** key must be pressed, at the latest, before the final key of the required Department or PLU entry sequence. The LC for the department or PLU will be extended with two higher digits for that entry only.

Example 1) Department Quantity Extension sequence:

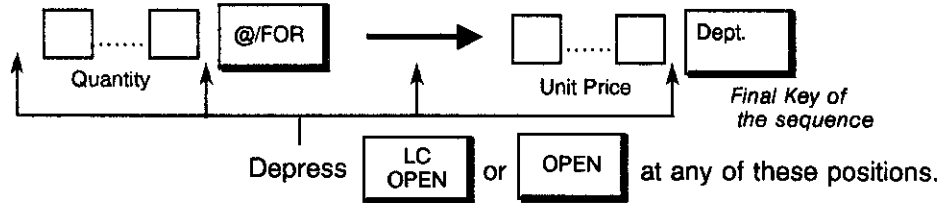

Example 2) PLU Quantity Extension sequence:

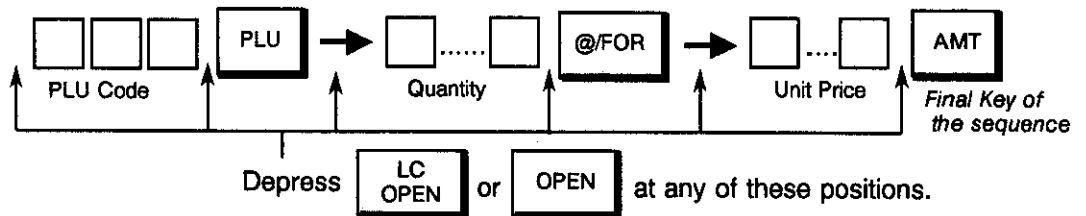

Percent Charge, Percent Discount

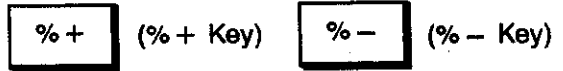

These keys are used to add or subtract a percent rate to or from an individual sale entry item or the entire sale. Each of the keys can function with a rate manually entered or a preset rate. To activate the preset rate entry, rate setting is necessary.

Setting Preset Rate for % Keys

Condition: Any time outside a sale and signed off.

Programming Procedure:

Use the **MA Key** to turn the Control Lock to "SET".

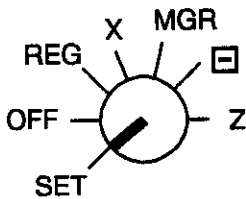

This portion is required only when any decimal portion is contained in the rate.

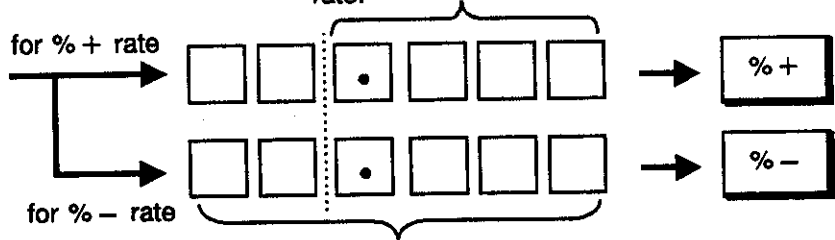

% rate 0 to 99.999

Examples)

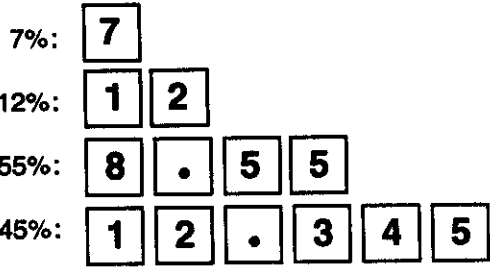

To reset the rate once set:



When "0" is set, the % key will always require a manual rate entry to be operated in sale entries.

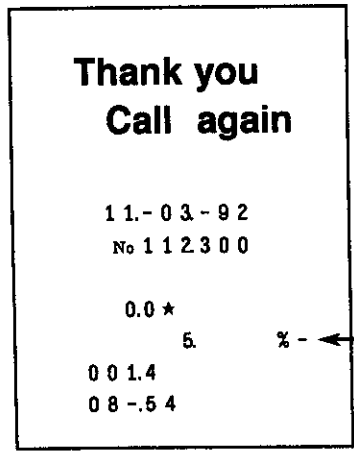
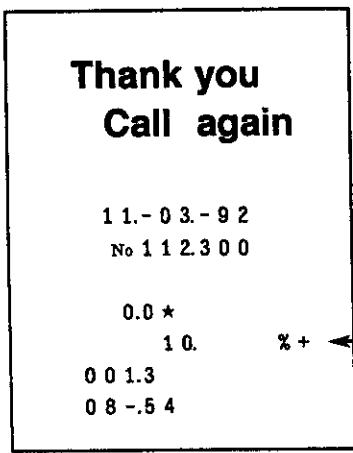

% Key Operations in Sale Entries

Use the **REG** Key to turn the Control Lock to "REG".

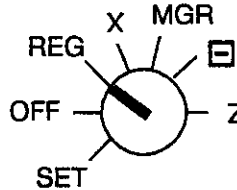

(The **Percent Discount** operation requires the **MGR** position if so programmed by System Option.)

% + Operation Patterns (**% -** operates the same except that the calculated amount will subtract from instead of adding to the sale amount.)

Percent Charge on a Department or PLU Item:

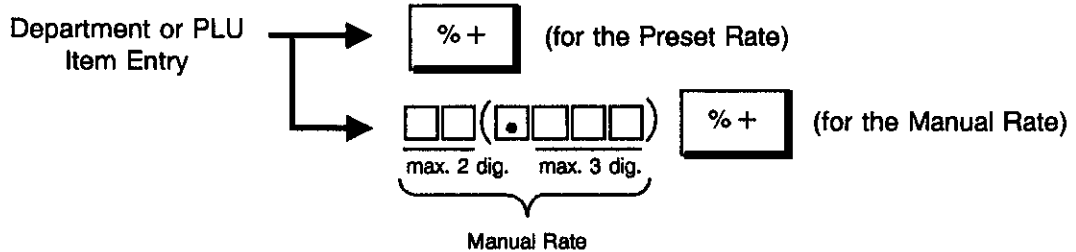

Percent Charge on Sale Total:

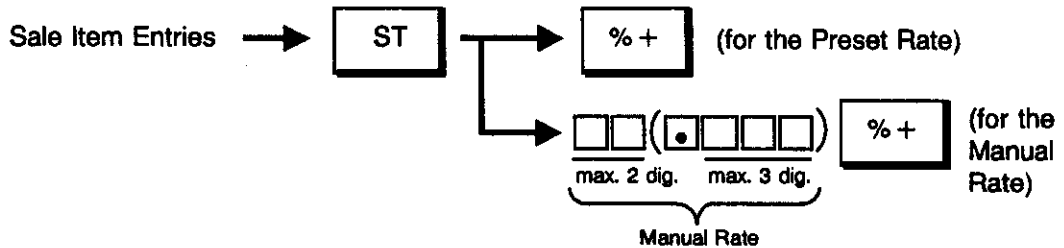

- NOTES 1.** When a rate is manually entered through a % key preset with a rate, the manual rate prevails.
- 2.** A % entry will cause an error if operated after an Other Income Department or Negative Department entry.
- 3.** A % entry after obtaining a Subtotal is usually allowed only once. However, it can be programmed to allow multiple times. (Refer to Chapter "22. System Option Setting", Address 16 - Bit 2.)
- 4.** You can select the rounding process of the fractions of the product (result of multiplication) -- ROUND OFF (initial setting), ROUND UP, or ROUND DOWN. (Refer to Chapter "22. System Option Setting", Address 2 - Bits 1 and 2.)
- 5.** The Percent Discount operation can be programmed to require the MGR position of the Control Lock. (Refer to "22. System Option Setting", Address 5 - Bit 3.)
- 6.** Each of the % keys has its own Tax(PST) Status, GST Status, and Food Stamp Status programmed. Refer to "Tax Modification" (page 62) and "Food Stamp Modification" (page 63) for reversing the status.

Example of % Discount on Item

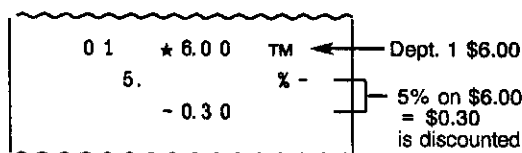

Example of % Charge on Sale Total

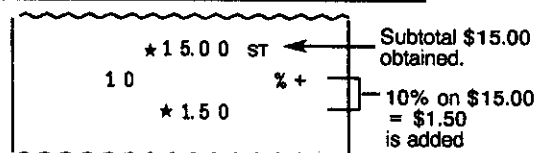

Dollar Discount



Dollar Discount is used to subtract an amount from the sale total.

Use the **REG** Key to turn the Control Lock to "REG".

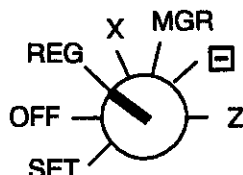

(The Dollar Discount operation requires the MGR position if so programmed by System Option.)

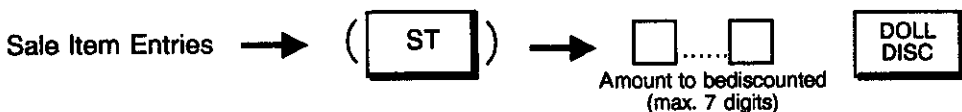

- NOTES 1.** For entering a Dollar Discount that will cause the sale total into negative (credit balance), refer to Chapter "22. System Option Setting" Address 2 - Bit 3:
 If status "Credit Balance Prohibited" (initial status) is selected:
 Over-subtraction of the sale total by Dollar Discount causes an error.
 If status "Credit Balance Allowed" is selected:
 Over-subtraction of the sale total by Dollar Discount is possible.
- 2.** Refer to "Tax Modification" (page 62) and "Food Stamp Modification" (page 63) for reversing the Tax or Food Stamp status of the [DOLL DISC] key.

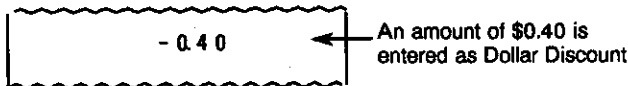

Vendor Coupon



This is a motorized key to enter the amount of vendor coupons received from the customer. The amount entered through this key will be negative and subtract from the sale total.

Use the **REG** Key to turn the Control Lock to "REG".

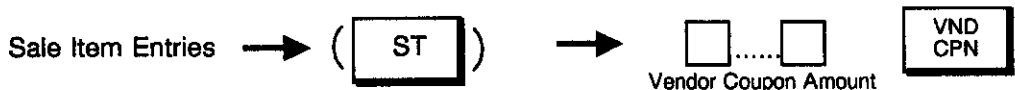
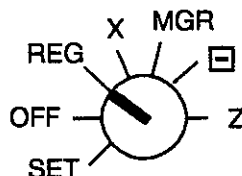

- NOTES 1.** For entering a Vendor Coupon amount that will cause the sale total into negative (credit balance), refer to Chapter "22. System Option Setting" Address 2 - Bit 3:
 If status "Credit Balance Prohibited" (initial status) is selected:
 Over-subtraction of the sale total by Vendor Coupon causes an error.
 If status "Credit Balance Allowed" is selected:
 Over-subtraction of the sale total by Vendor Coupon is possible.
- 2.** Refer to "Tax Modification" (page 62) and "Food Stamp Modification" (page 63) for reversing the Tax or Food Stamp status of the [VND CPN] key.

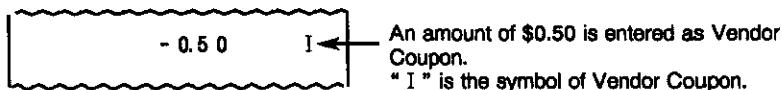

Store Coupon

STR CPN (Store Coupon Key)

This is a declaration key to subtract a store coupon amount redeemed through a department. Store coupon operations will net the department through which they are redeemed. To operate, depress the [STR CPN] key before the coupon amount then operate the appropriate department (but not any PLU).

Depress **STR CPN** prior to or any time during the entry sequence of the following operations for Open-price or Preset-price Departments already described:

- Entry of One Department Item**
- Department Quantity Extension NOTE 3**
- Single-Item Department Entry NOTE 2**

- NOTES 1.** The [STR CPN] key must be pressed, at the latest, before the final key of the required Department entry sequence.
- 2.** The store coupon amount must be entered inside a sale and must not exceed the sale total unless the "Credit Balance Allowed" option is selected. (Refer to Chapter 22: System Option Setting, Address 2 - Bit 3.)
- 3.** Quantity extension (multiplication) is permitted with this key, but no decimal quantity will be accepted.
- 4.** None of PLUs, Negative Departments, Void, Returned Merchandise entries are possible along with the [STR CPN] key within one item.
- 5.** The Store Coupon amount will subtract the Department Amount but will not affect the Department Item Count in the report memory.
- 6.** Refer to "Tax Modification" (page 62) and "Food Stamp Modification" (page 63) for reversing the Tax or Food Stamp status of the [STR CPN] key.

Example 1) **Entry of One Department Item** sequence (using an Open-price Department):

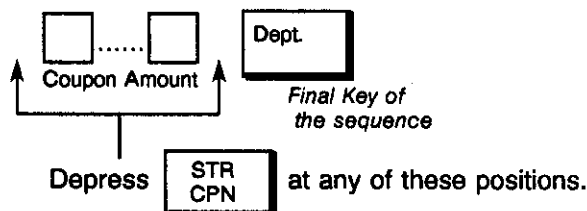

Example 2) **Department Quantity Extension** sequence (using an Open-price Department):

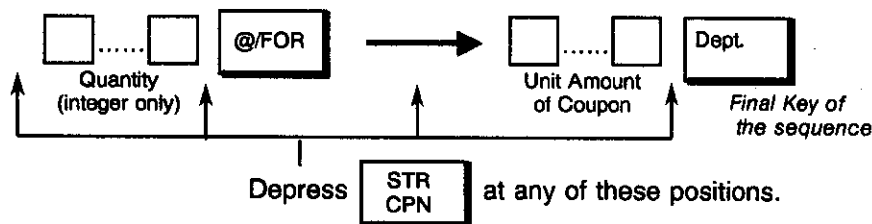

Example of Store Coupon Entry



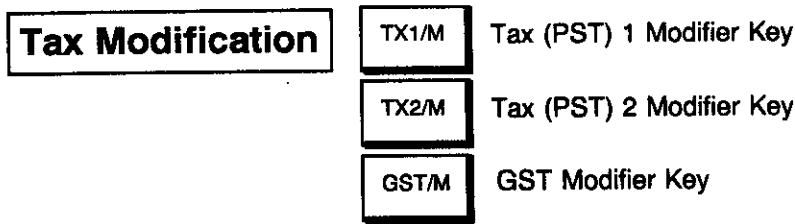

Each of these keys is used to reverse the tax status of a required Department or PLU item to be entered in a sale. It is also used to reverse the tax status status of [% +], [% -], [DOLL DISC], [VND CPN], and [STR CPN] keys. The Modifier Keys are effective only for one entry.

- Depress the required Modifier Key(s) prior to or any time during (before the final key at the latest) the entry sequence of the following operations for Departments and PLUs already described. More than one Modifier Keys can be depressed for the same item entry:

Entry of One Department Item
Department Repeat Entry
Other Income Department
Department Quantity Extension
Department SPP
Single-Item Department Entry
Entry of One PLU Item
PLU Repeat Entry
PLU Quantity Extension
PLU SPP
Single-Item PLU Entry

The tax status of the Department (refer to "Programming Department Keys" on page 40) is reversed:

- Taxable → Non-taxable
- Non-taxable → Taxable

Example) Reversing Tax (PST) 1 status of a Department item **Department Quantity Extension** sequence:

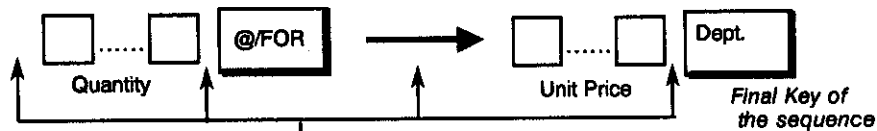

- Depress the required Modifier Key(s) prior to or any time during (before the final key at the latest) the entry sequence of the following operations for Departments and PLUs already described. More than one Modifier Keys can be depressed for the same item entry:

Percent Charge
Percent Discount
Dollar Discount
Vendor Coupon
Store Coupon

The tax status of each key (refer to **Chapter 22: System Option Setting, Addresses 3 & 4** and supplementary descriptions) is reversed:

- Taxable → Non-taxable
- Non-taxable → Taxable

Example) Reversing Tax (PST) 1 status of **Dollar Discount** entry:

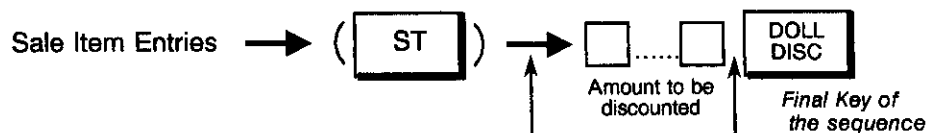

Food Stamp Modification

FS/M

(Food Stamp Modifier Key)

This key is used to reverse the Food Stamp status (food-stampable or non-stampable) of a required Department or PLU item to be entered in a sale. It is also used to reverse the Food Stamp status of [% +], [%-], [DOLL DISC], [VND CPN], and [STR CPN] keys.

The [FS/M] key operates the same as Tax Modifier Keys on the preceding page.

- NOTES 1.** As for the Food Stamp status of each Department, refer to "Programming Department Status" on page 40. The Food Stamp status of each PLU is determined by the status of the link Department.
- 2.** As for the Food Stamp status of each of [% +], [%-], [DOLL DISC], [VND CPN], and [STR CPN] keys, refer to Chapter 16: System Option Setting, Addresses 3 & 4 and supplementary descriptions.

Item Correction (Last Line Voiding)

**ITEM
CORR**

(Item Correct Key)

The last line item (any of the following items that has just been entered within the current transaction) can be deleted by the [ITEM CORR] key.

- Entry of One Department Item
- Department Repeat Entry (NOTE 1)
- Other Income Department
- Department Quantity Extension (NOTE 2)
- Department SPP (NOTE 2)
- Entry of One PLU Item
- PLU Repeat Entry (NOTE 1)
- PLU Quantity Extension (NOTE 2)
- PLU SPP (NOTE 2)
- Percent Charge, Percent Discount
- Dollar Discount
- Vendor Coupon
- Store Coupon
- Received-on-Account (Item only)
- Paid Out (Item only)
- Manual Tax

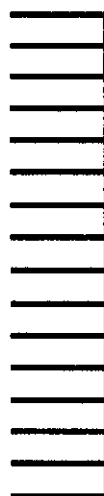

**ITEM
CORR**

Dept. 1 \$6.00 (taxable) is entered but item-corrected.

0 ± -- ★ 6.00 - VD TM

" - - - - -VD " indicates an Item Correction.

- NOTES 1.** When the [ITEM CORR] key is depressed after repeated items, only the last item of the repeated is deleted, decrementing the "RPT" count in the display.
- 2.** When the [ITEM CORR] key is depressed after a Quantity Extension or SPP, the entire product (result of the calculation) is deleted.
- 3.** Void, Returned Merchandise items cannot be deleted by the [ITEM CORR] key. Neither can any media amount be item-corrected even if it is short-tendered.
- 4.** When the [C] key is used to clear any numeric data, the item-correct function is still active for the preceding item. However, if the [C] key is used to clear an error, the preceding item can no longer be item-corrected.

Returned Merchandise



(Returned Merchandise Key)

A Department or PLU item once purchased (i.e. the sale is already finalized) then returned by a customer can be entered as a Returned Merchandise item. If the [VOID] key is not installed on your register, this function may also be used as Void entry (refer to Void entries on the next page).

- Depress the [RTN MDSE] key prior to or any time (before the final key at the latest) during a required Department or PLU item entry sequence. (The only difference is a depression of the [RTN MDSE] key):

- Entry of One Department Item
- Other Income Department
- Department Quantity Extension
- Department SPP
- Single-Item Department Entry
- Entry of One PLU Item
- PLU Quantity Extension
- PLU SPP
- Single-Item PLU Entry

"RT" ... Symbol of Returned Merchandise

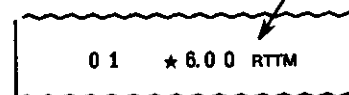

(Repeat entry is not possible using the [RTN MDSE] key.)

Example) Items once entered through an Open-price Department in a Quantity Extension sequence at purchase are now returned:

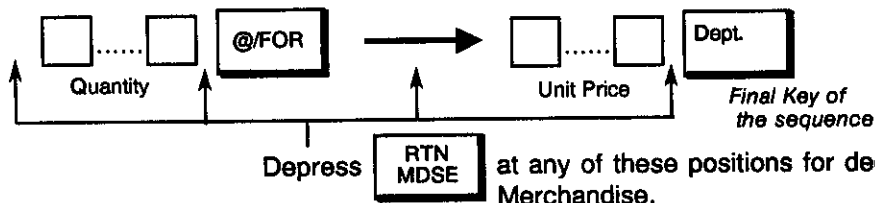

- When an item once purchased with a Percent Charge or Percent Discount is returned, the item can be returned with the Percent Charge/Discount by attaching the [RTN MDSE] key to the same entry procedure as purchase:

Example) Dept. 1, \$6.00 with 5% discount, purchased and returned.

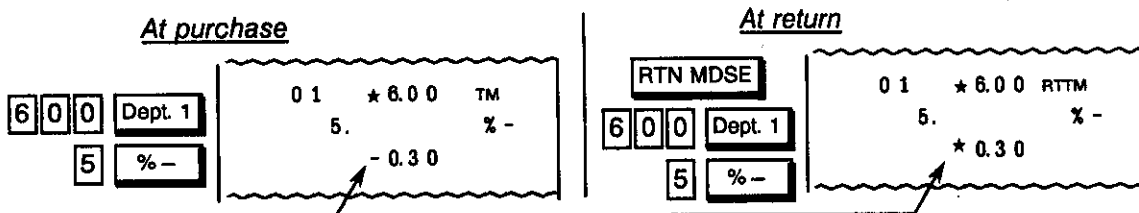

The process of the amount resulted from % calculation is reversed at Return.

- NOTES**
1. The Returned Merchandise entries are possible outside as well as inside a sale.
 2. Over-subtraction of the sale is allowed for Returned Merchandise entries.
 3. Neither Negative Department nor Negative PLU items can be entered as Returned Merchandise.
 4. A Returned Merchandise cannot be item-corrected.
 5. The Returned Merchandise operation requires the MGR position of the Control Lock if so programmed by System Option. (Refer to Chapter "22. System Option Setting", Address 5- Bit 1.)

Void (Designated Line Voiding) **VOID** (Void Key)

A Department or PLU item entered before the last item but canceled in the current sale (which can no longer be deleted by [ITEM CORR]) is entered as a Void item using the [VOID] key. If this key is not installed on your register, the [RTN MDSE] key may be used for voiding purposes (refer to the preceding page). If both [VOID] and [RTN MDSE] are installed, [VOID] should be used to cancel (delete) an item already entered within the current transaction while [RTN MDSE] should be used to record an item that was purchased in a past sale and is now returned.

- Depress the [VOID] key prior to or any time (before the final key at the latest) during a required Department or PLU item entry sequence. (The only difference is a depression of the [VOID] key):

Entry of One Department Item
Other Income Department
Department Quantity Extension
Department SPP
Single-Item Department Entry
Entry of One PLU Item
PLU Quantity Extension
PLU SPP
Single-Item PLU Entry

(Repeat entry is not possible using the [VOID] key.)

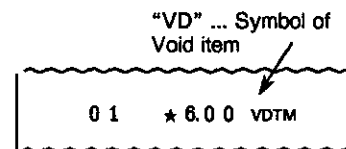

Example) Items once entered through an Open-price Department in a Quantity Extension sequence at purchase are now voided:

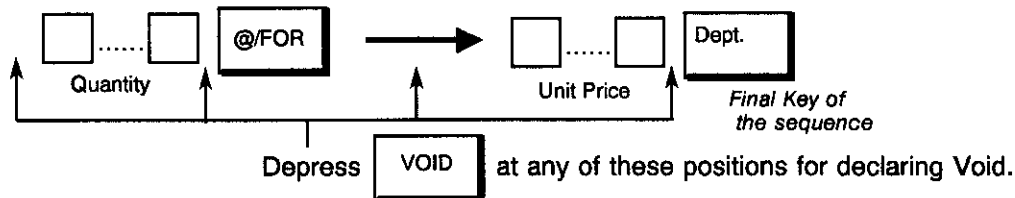

- When an item previously entered with a Percent Charge or Percent Discount is canceled, the item can be voided with the Percent Charge/Discount by attaching the [VOID] key to the same entry procedure as the previous entry:

Example) Dept. 1, \$6.00 with 5% discount entered then voided in a sale:

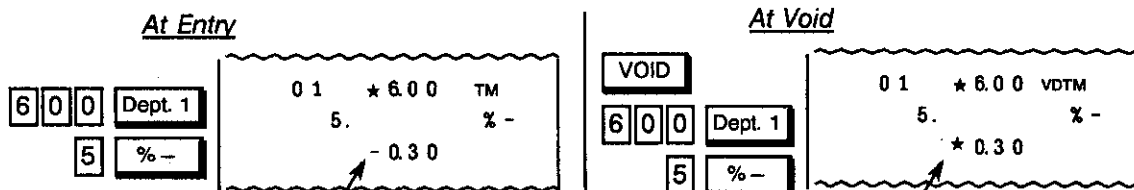

The process of the amount resulted from % calculation is reversed at Void.

- NOTES 1.** The Void entries are usually possible only inside a sale. However, when the option "Credit Balance Allowed" is selected, they are allowed outside a sale as well and over-subtraction of the sale is also allowed. (Refer to Chapter "22. System Option Setting", Address 2 - Bit 3.)
3. Neither Negative Department nor Negative PLU items can be entered as Void items.
 4. A Void entry cannot be item-corrected.

All Void (Transaction Cancel)**ALL
VOID**

(All Void Key)

When some items have already been entered in the current sale and the customer cancels the entire contents of the sale, the **[ALL VOID]** key is used.

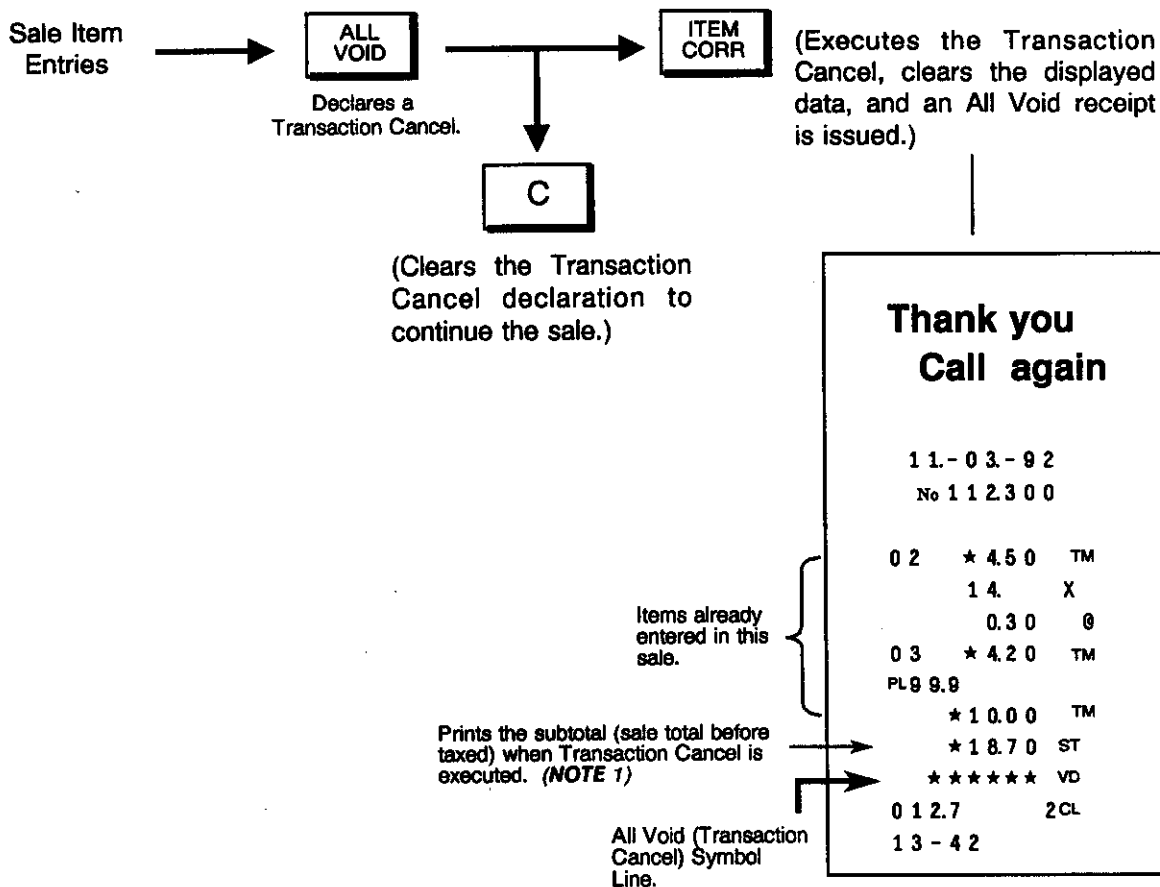

- NOTES 1.** The sale is canceled; therefore, no payment should occur. However, subtotal amount printed on the All Void receipt is processed into the "All Void" total of the report memory.
2. The All Void operation is no longer acceptable when any media key (such as **[AT/TL]**) is entered including short-tendering.
 3. If Tax Exempt (using the **[EX]** key) is entered, the sale can no longer be all-voided.
 4. The All Void function is not effective for Received-on-Account or Paid Out transactions.
 5. When more than 21 items have been entered in the current sale, the All Void function is no longer effective.

Non-add Number Print

#/NS

(Non-add Number Print / No-sale Key)

#

(Non-add Number Print Key)

When any code number is to be recorded for future reference, such as a Check No., Customer No., Credit Card No., House Charge Account No., etc., a Non-add Number Print function is used.

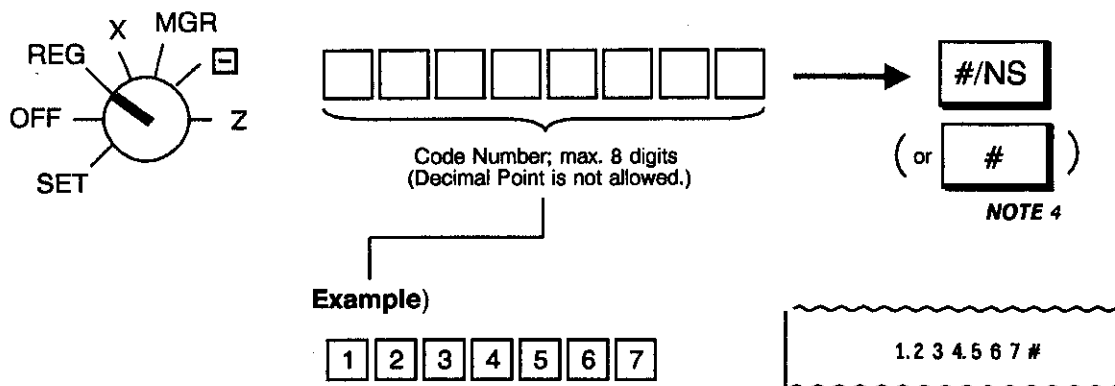

- NOTES 1.** A Non-add Number can be entered at the starting of a sale or any time during a sale if it is not finalized. It is operable any number of times within a sale. However, when operated at the starting, a transaction entry must follow.
2. The entered number will not affect any sales data. It is merely a print for reference.
3. The preceding zeros, if any, will not be printed. For example, if "012300" is entered, "12300" is printed.
3. Usually, Non-add Number entries are prohibited at the starting of a No-sale transaction (i.e, Non-add Numbers cannot be printed on a No-sale receipt). However, a No-sale entry can be programmed to be allowed after a Non-add Number entry (refer to Chapter "22. System Option Setting", Address 15 - Bit 1).
4. The [#] key is operated only for the Non-add Number Print function in REG, MGR, or mode. The [#NS] key operates and functions the same as [#] in this case. When this key is simply depressed without a prior numeric entry in REG or MGR mode, it functions as the [NS] (No-sale) key. (Refer to the section of No-sale.)

Subtotal Read & Print**ST**

(Subtotal Key)

When the sale total of the current sale is to be read by the customer's request or the operator's requirement, the **[ST]** key is used.

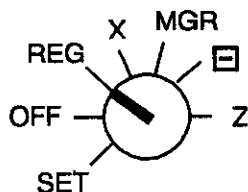
Sale Item
Entries**ST**

The sale total of the items so far entered is displayed in the AMOUNT portion with the "ST" triangular lamp illuminated. At the same time, the sale total is printed. The sale is not finalized yet.

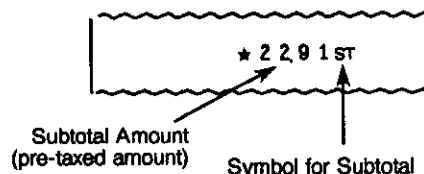

- NOTES 1.** When the **[ST]** key is depressed, the sale total is displayed and printed. However, you can select not to print (display only) by a system option. (Refer to Chapter "22. System Option Setting" - Address 1 - Bit 3.) Even if this non-print option is selected, the subtotal amount is automatically printed when a Percent Charge/Discount or Dollar Discount entry follows a subtotal entry.
- 2.** The displayed subtotal amount includes the taxes due (Tax 1, Tax 2, & GST) while the printed subtotal amount is the pre-taxed amount (amount not including taxes due). As for the displayed amount, you can select to display the pre-taxed amount by a system option. (Refer to Chapter "22. System Option Setting" - Address 15 - Bit 4.) This option is recommended only when both **[ST]** and **[TXBL TL]** (Taxable Total) keys are installed. In that case, **[ST]** displays pre-taxed amount while **[TXBL TL]** displays post-taxed amount (amount including taxes due).
- 3.** If the option "Taxable Total Compulsory" is selected with the function of subtotal display including taxes due (refer to NOTE 2 above), the **[ST]** key must always be depressed before operating media keys for finalizing a sale. (Refer to Chapter "22. System Option Setting", Address 2 - Bit 4.)
- 4.** When the **[ST]** key is depressed more than once consecutively, the subtotal amount is only displayed but no print occurs from the second time one. If the **[C]** key is operated to clear a numeric entry or error, etc. after a subtotal is once obtained, the subtotal amount is again displayed.
- 5.** As for a Percent Entry after obtaining a subtotal, refer to the NOTE 3 attached to the "% Key Operations in Sale Entries" on page 59.

Taxable Total ReadTXBL
TL

(Taxable Total Key)

This is an Optional Key, used only to display the Taxable Total (sale total including taxes) during a sale. The key is usually not necessary since the [ST] key contains this function. If it is installed, however, it is recommended to program the [ST] key to display the pre-taxed amount (for distinguishing it from the [TXBL TL] key function). Refer to **NOTE 2** attached to the section of "Subtotal Read & Print" on the preceding page.

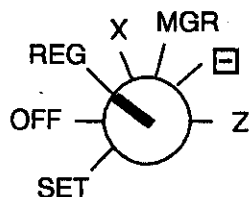
Sale Item
EntriesTXBL
TL

The sale total of the items so far entered is displayed in the AMOUNT portion with the "ST" triangular lamp illuminated. The sale total amount displayed includes taxes due (Tax 1, Tax 2, & GST). No print occurs. The sale is not finalized yet.

- NOTES 1.** If the option "Taxable Total Compulsory" is selected, the [TXBL TL] key must always be depressed before operating media keys for finalizing a sale. (Refer to Chapter "22. System Option Setting", Address 2 - Bit 4.)
- 2.** If the [C] key is operated to clear a numeric entry or error, etc. after a Taxable Total is once obtained, the Taxable Total amount is again displayed.

Manual Tax Entry

TAX

(Manual Tax Key)

This is an Optional Key, used to enter an irregular tax amount that cannot be calculated on the basis of the programmed tax tables, and to add it to the sale total.

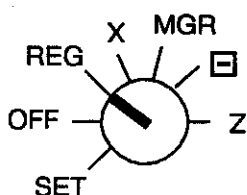
Sale Item
Entries

Tax Amount required
(max. 7 digits)

TAX

The entered tax amount is printed and added to the sale.

- NOTES 1.** The amount entered through the [TAX] is not included in the tax amount automatically calculated at sale finalization. The Manual Tax amount is separately added and is processed into the Manual Tax total (separately from PST Tax 1, Tax 2, and GST) in the report memory.
- 2.** A Manual Tax amount entered can be item-corrected, but cannot be deleted by [VOID] or [RTN MDSE].

Print Format of Manual Tax Entry

★ 0.12 TX ←

A Manual Tax of \$0.12 is entered. The "TX" symbol during a sale indicates Manual Tax. (The same symbol indicates auto-calculated tax when printed at sale finalization.)

Food Stamp Tender

FSTL
TEND

(Food Stampable Total Read / Tender Key)

When a customer wants to pay for his/her sale in food stamps, this key is used to read the food-stampable total and to tender an amount in food stamps. If the sale is to be paid for in combination of food stamps and other media (cash, check, etc.), Food Stamp Tender must be operated first then operate other media total/tender operations referring to the following pages.

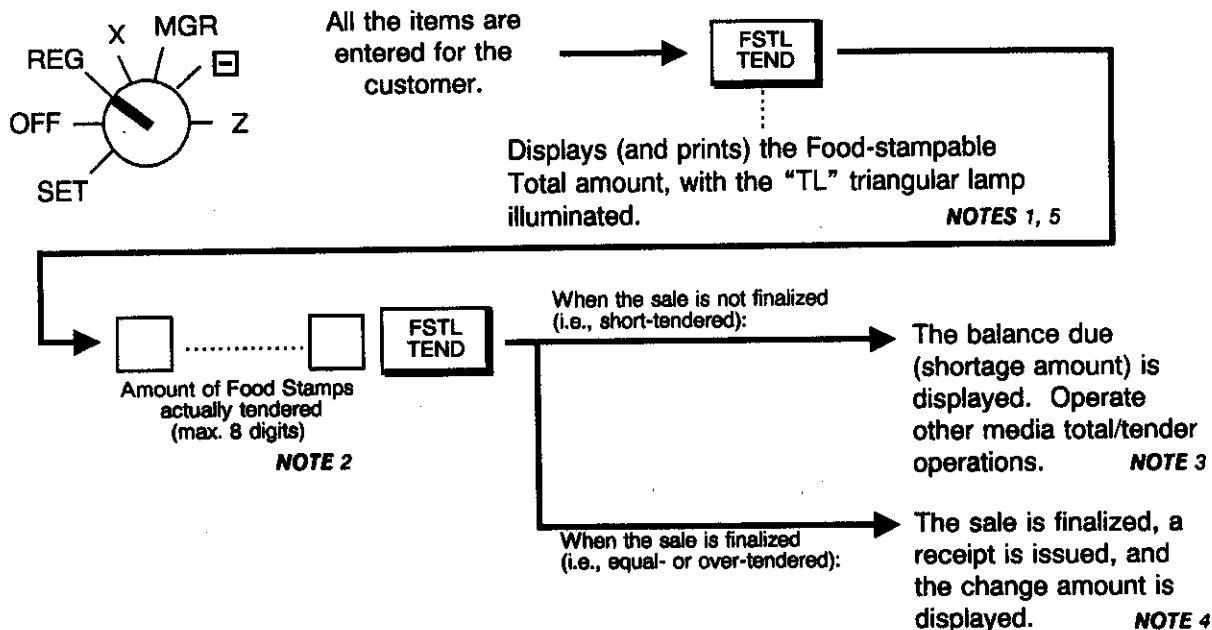

- NOTES 1.** The displayed Food-stampable Total is the limit amount to be paid in food stamps. Accurately, however, the actual limit may become this displayed total + 99¢ due to the combination of changes due refunded in cash.
- 2.** The Amount of Food Stamps actually tendered may exceed the Food-stampable Total previously displayed. In that case, the exceeding amount (besides refunded as change in cash of max. 99¢) will be refunded in food stamps. Also refer to **NOTE 4**.
- 3.** Refer to the **Cash Total, Cash Tender, Non-cash Media Total, Non-cash Media Tender, Multi-tender, and Split Tender** sections on the following pages.
- 4.** The "CG" triangular lamp is illuminated. The change portion by the unit of \$1.00 will be returned in food stamps (0 to 9, indicating dollars, displayed in the "DP" portion). The change portion less than \$1.00 will be returned in cash (displayed in the "AMOUNT" portion).
- 5.** The "Food-stampable Total" is the total of Department and PLU items that are programmed to be "Food-stampable" and are entered in the current sale. As for programming of Food Stamp status, refer to **Programming Department Status** on page 40. As for reversing the Food Stamp status of individual items at the moment of their entries, refer to "**Food Stamp Modification**" on page 63.
- 6.** There are four types of food stamp handlings (GENERAL, ILLINOIS, TEXAS, and NEW JERSEY types) regarding the tax payment for the food-stampable items, and the right type should be selected for your area. (Refer to Chapter "**22. System Option Setting, Address 16 - Bits 4 & 5**". Also refer to the Print Format Samples on the next page.)

Food Stamp Tender Print Format Samples

GENERAL Type

**Thank you
Call again**

11.-03.-92
No 112300

01 *10.00 TMFM
*1.50 TX
*1.150 TL
*1.150 FS TL
*2.000 FS
*0.50 CG
*8.00 FS CG

030.3 1CL
15-04

The customer may pay up to the food-stampable amount plus its taxes due in food stamps.

← Food-stampable Item
← Food-stampable Total (including tax on Food-stampable Total)
← Food Stamp Tendered
← Change in Cash
← Change in Food Stamps

ILLINOIS Type

**Thank you
Call again**

11.-03.-92
No 112300

01 *10.00 TMFM
*10.00 FS TL
*5.00 FS
*0.70 TX
*5.75 CA TL

030.3 1CL
15-04

The customer may pay up to the food-stampable amount in food stamps, and the amount actually paid in food stamps is tax-exempted.

← Food-stampable Item
← Food-stampable Total (excluding tax on Food-stampable Total)
← Food Stamp Tendered
← Cash Total

TEXAS Type

**Thank you
Call again**

11.-03.-92
No 112300

01 *10.00 TMFM
*1.50 TX
*1.150 TL
*1.050 FS TL
*1.000 FS
*1.50 CA TL

030.3 1CL
15-04

The customer may pay up to the food-stampable amount in food stamps, but any taxes due must be paid in cash.

← Food-stampable Item
← Food-stampable Total (excluding tax on Food-stampable Total)
← Food Stamp Tendered
← Cash Total

NEW JERSEY Type

**Thank you
Call again**

11.-03.-92
No 112300

01 *10.00 TMFM
02 *2.00 TM
*10.00 FS TL
*10.00 FS
*0.10 TX
*2.10 CA TL

030.3 1CL
15-04

The customer may pay up to the food-stampable amount in food stamps, and the food-stampable amount is tax-exempted regardless of the actual amount paid in food stamps.

← Food-stampable Item
← Non-stampable Item
← Food-stampable Total (including tax on Food-stampable Total)
← Food Stamp Tendered
← Cash Total

Cash Total, Cash Tender

AT/TL

(Cash Amount Tender/Total Key)

When sale items have all been entered and the customer will pay in cash, this key finalizes the sale and issues a receipt. When the customer will pay in other media (non-cash media), refer to the next section "Non-cash Media Total, Non-cash Media Tender".

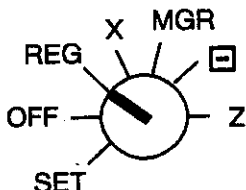

All the items are entered for the customer.

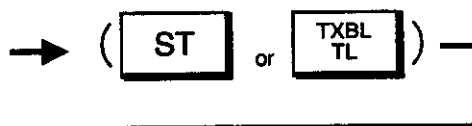

To finalize without tendering (Total function):

AT/TL

Displays the sale total amount (including taxes) with the "TL" lamp illuminated.

The sale is finalized, the drawer opens, and a receipt is issued, printing the "TX" (tax amount) and "CATL" (cash total amount including tax) on separate lines.

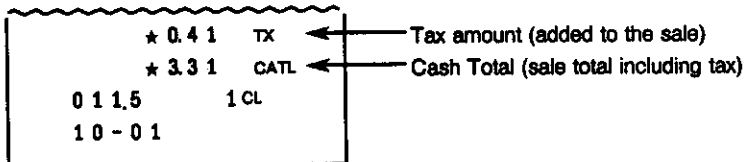

To finalize with a cash amount tendered (Tender Function):

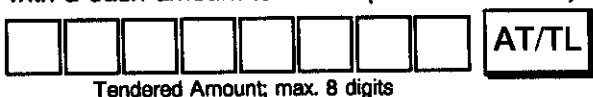

When the amount tendered is equal to or larger than the sale total:

Displays the amount of change due with the "CG" lamp illuminated.

The sale is finalized, the drawer opens, and a receipt is issued, printing the "TX" (tax amount), "TL" (sale total including tax), "CA" (cash amount tendered), and "CG" (change due).

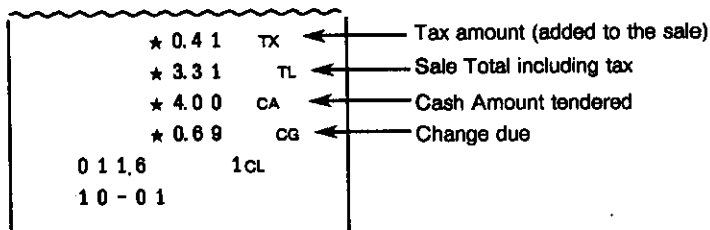

When the amount tendered is smaller than the sale total:

Displays the balance due (shortage), with the "ST" lamp illuminated.

Prints "TX", "TL", and "CA" (short-tendered cash amount). The sale is not finalized. (Refer to the section "Multi-tender, Split Tender".)

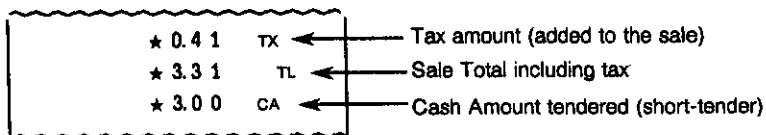

- NOTES**
1. The [AT/TL] key functions as Total Key if simply pressed, or as Tender Key if pressed with a prior amount entry. However, it can be programmed to be used as Tender Key only (refer to Chapter "22. System Option Setting", Address 6- Bit 1).
 2. When the sale total is zero or negative, only the Total Key function is effective regardless of the key option selection described in NOTE 1 above.
 3. When the option "Taxable Total Compulsory" (refer to Chapter "22. System Option Setting", Address 2- Bit 4) is selected, the sale is finalized only after reading the sale total (by [ST] or [TXBL TL]).
 4. When the option "Short-tendering Prohibited" is selected (refer to Chapter "22. System Option Setting", Address 11- Bit 1), short-tendering is not possible.
 5. The [AT/TL] key is also used to finalize a Received-on-Account or Paid Out transaction. (Refer to the respective sections.)
 6. When a sale is partially paid in food stamps, Food Stamp Tender must be operated first. (Refer to the preceding section.)

Non-cash Media Total, Non-cash Media Tender

These keys are non-cash media keys to be used for finalizing a sale as alternative media. The keys operate the same as [AT/TL] key. (Refer to the section "Cash Total, Cash Tender".)

CHK TND	(Check Tender Key)
Chg	(Charge Total Key)
CPN	(Media-Coupon Tender Key)
MISC	(Misc. Tender Key)

Finalizing a Sale as Check:

Use the [CHK TND] key instead of [AT/TL] for finalizing a sale paid for in check.

★ 0.41	TX	←	Tax amount (added to the sale)
★ 3.31	TL	←	Sale Total including tax
★ 4.00	CK	←	Check Amount tendered
★ 0.69	CG	←	Change due (returned in cash)
011.7	1CL		
10-03			

- NOTES 1.** The [CHK TND] key functions as Tender Key only. However, it can be programmed to have both Tender and Total functions (refer to Section "22. System Option Setting", Address 7 - Bit 1).
2. When the key is programmed as Tender-only key, attempting to finalize a negative-balance sale will cause an error.
3. When the option "Taxable Total Compulsory" (refer to Chapter "22. System Option Setting", Address 2 - Bit 4) is selected, the sale is finalized only after reading the sale total (by [ST] or [TXBL TL]).
4. When the option "Short-tendering Prohibited" is selected (refer to Chapter "22. System Option Setting", Address 11 - Bit 1), short-tendering is not possible.
5. When the option "Over-tendering Prohibited" is selected (refer to Chapter "22. System Option Setting", Address 7 - Bit 4), over-tendering is not possible.
6. The [CHK TND] key is also used to finalize a Received-on-Account. (Refer to the respective sections.)

Finalizing a Sale as Charge:

Use the [Chg] key instead of [AT/TL] for finalizing a sale to be processed as Charge account. The key may be used to finalize in non-cash media other than Check, Media-Coupon, and Misc., such as house charge, credit card, etc. (whatever media the store defines to be acceptable).

★ 0.41	TX	←	Tax amount (added to the sale)
★ 3.31	CHTL	←	Charge Total (sale total including tax)
011.8	1CL		
10-03			

- NOTES 1.** The [Chg] key functions as Total Key only. However, it can be programmed to have both Tender and Total functions (refer to Section "22. System Option Setting", Address 8 - Bit 1).
2. When the option "Taxable Total Compulsory" (refer to Chapter "22. System Option Setting", Address 2 - Bit 4) is selected, the sale is finalized only after reading the sale total (by [ST] or [TXBL TL]).

3. When the option "Short-tendering Prohibited" is selected (refer to Chapter "22. System Option Setting", Address 11 - Bit 1), short-tendering is not possible.
4. When programmed as Tender-and-Total Key and the option "Over-tendering Prohibited" is selected (refer to Chapter "22. System Option Setting", Address 8- Bit 4), over-tendering is not possible.

Finalizing a Sale as Media-Coupon:

Use the [CPN] key instead of [AT/TL] for finalizing a sale to be processed as Media-Coupon sale.

★ 0.41	TX	← Tax amount (added to the sale)
★ 3.31	TL	← Sale Total including tax
★ 4.00	CP	← Media-Coupon amount tendered
★ 0.69	CG	← Change due (returned in cash)
011.9	1CL	
10-03		

NOTES: Refer to **NOTES 1 to 6** attached to the "Finalizing a Sale as Check" on the preceding page. However, the initial set statuses are different from the [CHKTND] key. Therefore, refer to Chapter "22. System Option Setting", Address 10 also.

Finalizing a Sale as Misc. (Miscellaneous Media):

Use the [MISC] key instead of [AT/TL] for finalizing a sale to be processed as Misc. sale. The "Misc." media may be any non-cash media other than described above (whatever media the store defines to be acceptable).

★ 0.41	TX	← Tax amount (added to the sale)
★ 3.31	TL	← Sale Total including tax
★ 4.00	MS	← Misc. Media amount tendered
★ 0.69	CG	← Change due (returned in cash)
011.9	1CL	
10-03		

NOTES: Refer to **NOTES 1 to 6** attached to the "Finalizing a Sale as Check" on the preceding page. However, the initial set statuses are different from the [CHKTND] key. Therefore, refer to Chapter "22. System Option Setting", Address 9 also.

Multi-tender, Split Tender

AT/TL

CHK
TND

Chg

CPN

MISC

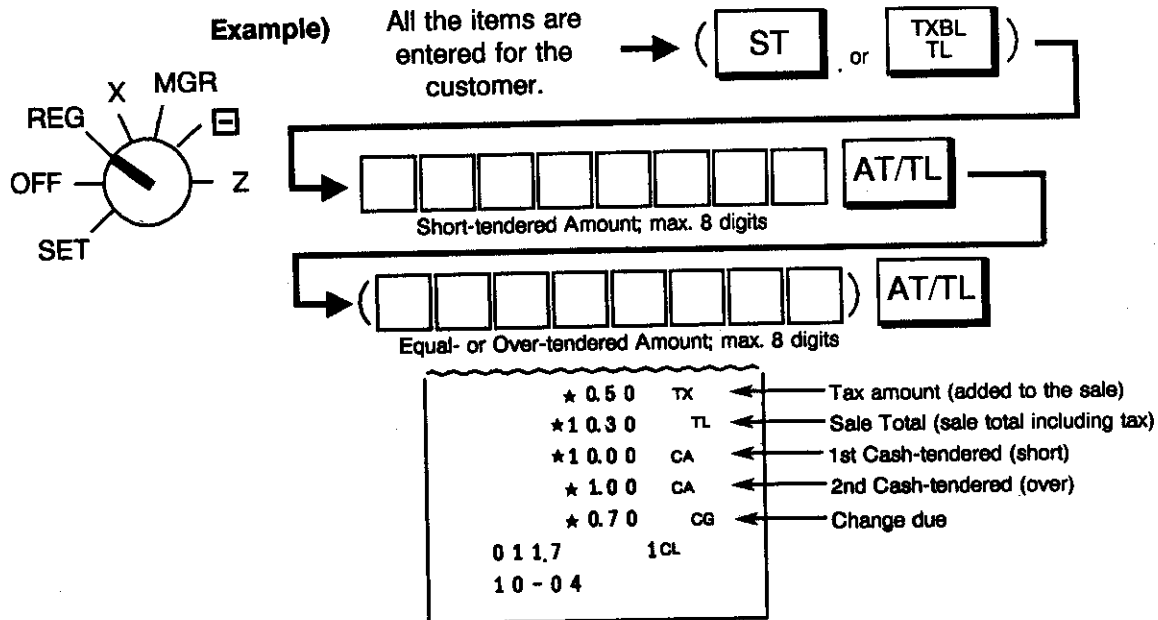
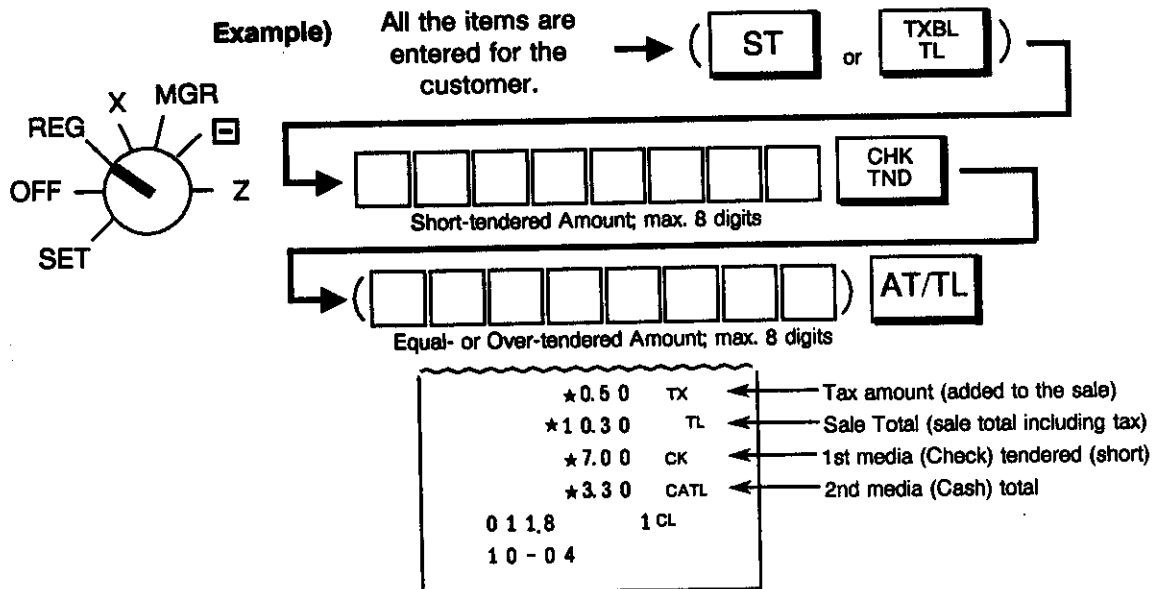
(media
keys)**Multi-tender (Short-tender repeated by the same media):****Split Tender (Short-tender repeated by the different media):**

- NOTES 1.** In both Multi-tender and Split-tender operations, the sale is finalized and a receipt is issued on reaching the sale total amount.
- 2.** Only the media keys programmed to have "Tender" function and to allow "Short-tendering" can be operated with a short-tendered amount entry in the above operation sequences.
- 3.** If a media key is depressed without an amount tender entry and is programmed to function as Total key, the sale is then finalized on that stage processing the balance at that moment into that media.

Tax Exemption

EX (Tax Exempt Key)

When an entire sale must be exempted from designated or all taxes (Tax/PST 1, Tax/PST 2, GST), the **[EX]** key is used near the end of the sale finalization. (To exempt an individual item from designated taxes, only Tax Modifier Keys are used in entering the item. Refer to the section "Tax Modification".)

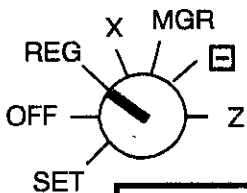

All the items are entered for the customer.



To exempt the sale from **designated** taxes:

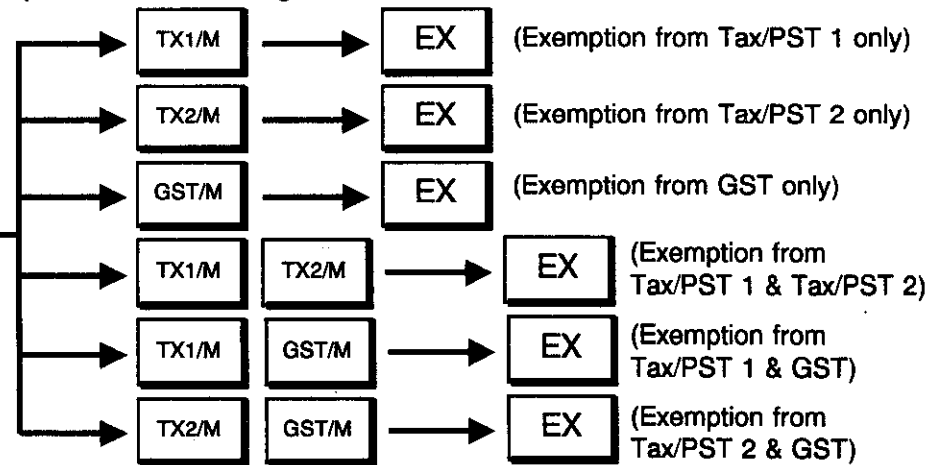

The sale portion (pre-taxed amount) subject to the tax exemption (Tax/PST 1 in this example).

At the same time, the display shows the Sale Total due (including non-exempted taxes and excluding exempted taxes).

To exempt the sale from **all** taxes:

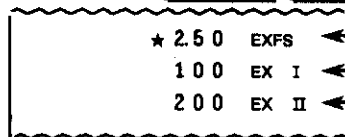
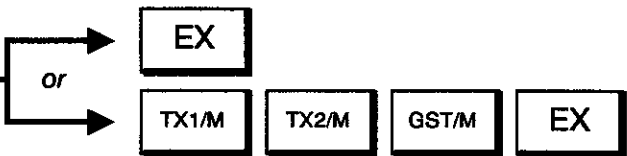

← Sale portion (pre-taxed) exempted from GST
 ← Sale portion (pre-taxed) exempted from Tax/PST 1
 ← Sale portion (pre-taxed) exempted from Tax/PST 2

At the same time, the display shows the Sale Total due (excluding all taxes).

- NOTES 1.** The Tax Exempt entry cannot be item-corrected.
2. After depressing the **[EX]** key, the sale must only be finalized (for payment through media keys).
3. If the "Non-taxable Amount Limit" is set for certain areas in Canada, using the **[GST/M]** key will cause an error and GST Exemption is not allowed. The "Non-taxable Amount Limit" judgment function is still active even after tax exemption of PST1 or PST2.

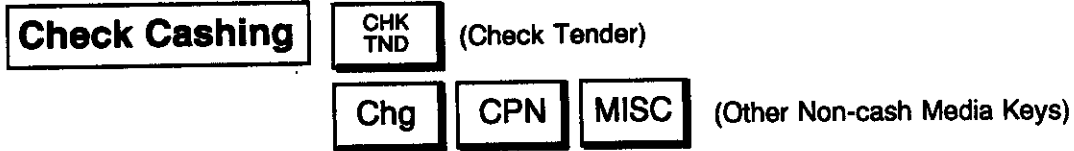

Check cashing (cashing non-cash media) requested by a customer is entered through a non-cash media key. It is operable only outside a sale (i.e. when no sale is underway on the register).

Operable outside a sale only

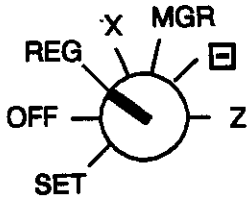

To cash a check:

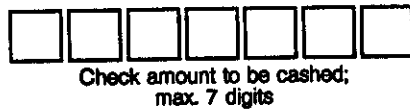

Example) To enter \$10.00:

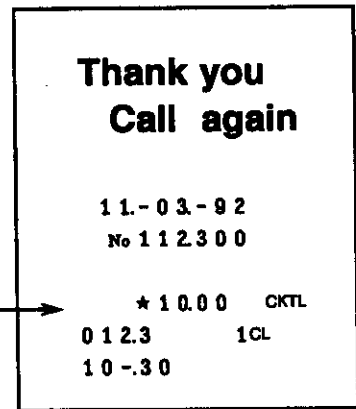
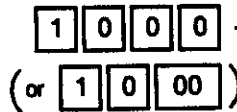

To cash other non-cash media:

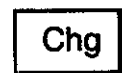

- NOTES 1.** When the media key is depressed, the drawer opens to enable exchanging the check (or other non-cash media) into cash.
- 2.** The [CHK TND] key is programmed to allow cashing as initial status. It can be programmed to prohibit it. (Refer to Chapter "22. System Option Setting", Address 7 - Bit 3.)
- 3.** The non-cash media keys other than [CHK TND] are programmed to prohibit cashing as initial status. Each of them can be programmed to prohibit it. (Refer to Chapter "22. System Option Setting", Bit 3 of Address 8, 9, or 10.)
- 4.** The cashing operation will not increment the No-sale Counter of the report memory.

No-sale**#/NS**

(Non-add Number Print / No-sale Key)

NS

(No-sale Key)

The No-sale transaction is used to open the drawer without relating to a sale, for such purposes of giving changes (to break a large-amount bill), checking the receipt/journal print condition, date or time accuracy, etc. This operation must be performed outside a sale only.

Operable outside a sale only

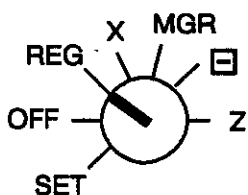

→ **#/NS** (or **NS**)

No-sale Transaction Symbol →

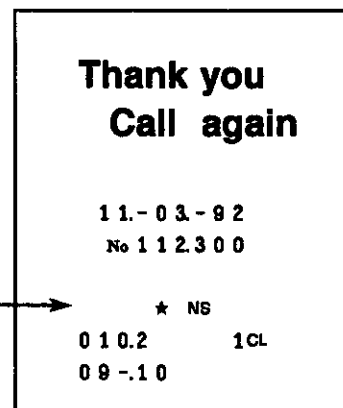

- NOTES 1.** *The drawer opens, and a No-sale receipt is issued.*
- 2.** *Usually, Non-add Number entries are prohibited at the starting of a No-sale transaction (i.e., Non-add Numbers cannot be printed on a No-sale receipt). However, a No-sale entry can be programmed to be allowable after a Non-add Number entry (refer to Chapter "22. System Option Setting", Address 15 - Bit 1).*
- 3.** *The [#/NS] key operates and functions the same in this case. When this key is depressed with a prior number entry, it functions as the Non-add Number Print key. (Refer to the section of Non-add Number Print.)*

Received-on-Account Payment

R/A (Received-on-Account Key)

A received-on-account transaction is used to identify money which is in the drawer but not due to business. For example, a customer pays for a sale finalized as a charge on a past day, or the cashier records the change reserve in the drawer loaned from the store office. This operation must be performed outside a sale only.

Operable outside a sale only

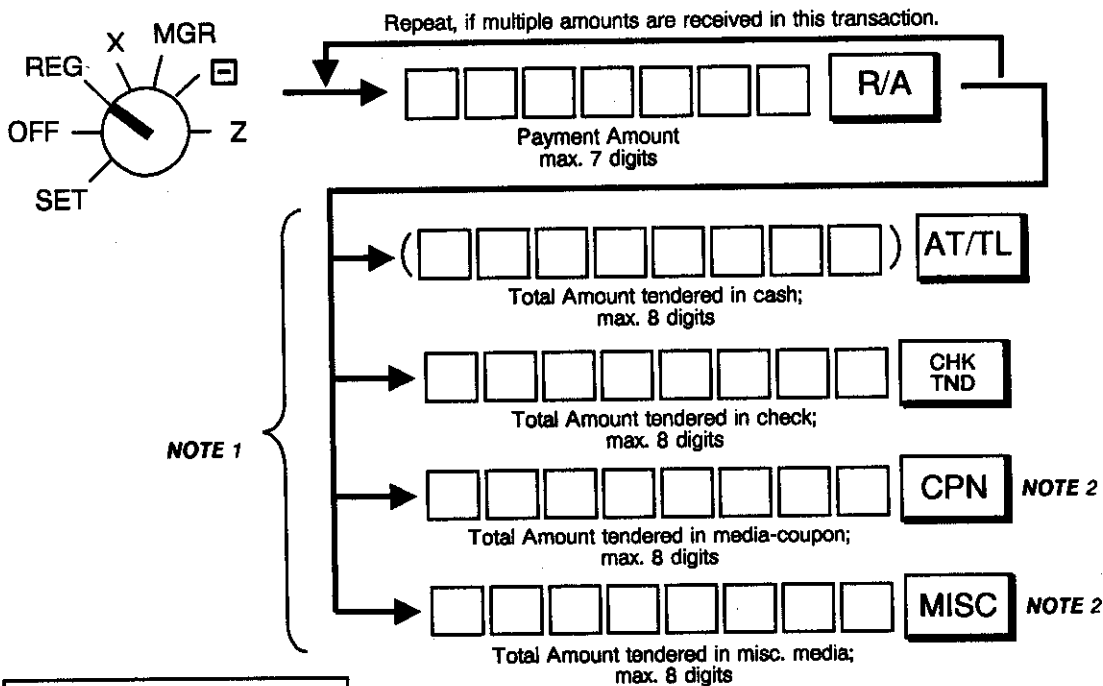

**Thank you
Call again**

11-03-92
No 112300

★ 1 0 0 0	RA	
★ 2 5 0	RA	
★ 1 2 5 0	CATL	

0 1 0 3 1CL

0 9 - 1 0

- NOTES 1.** For finalizing the transaction, the [Chg] key cannot be used. For further operation using the media keys, refer to the sections "Cash Total, Cash Tender" and "Non-cash Media Total, Non-cash Media Tender". Also refer to the section "Multi-tender, Split Tender".
- 2.** Finalizing by [CPN] or [MISC] key can be prohibited. (Refer to Chapter "22. System Option Setting", Bit 5 in Address 10 or 9.
- 3.** The R/A Counter in the report memory increments on each [R/A] key depression.

Paid Out**PO**

A paid-out transaction is used when an amount of money is removed from the drawer without relating to a sale, for the purpose of paying to wholesalers, etc. This operation must be performed outside a sale only.

Operable outside a sale only

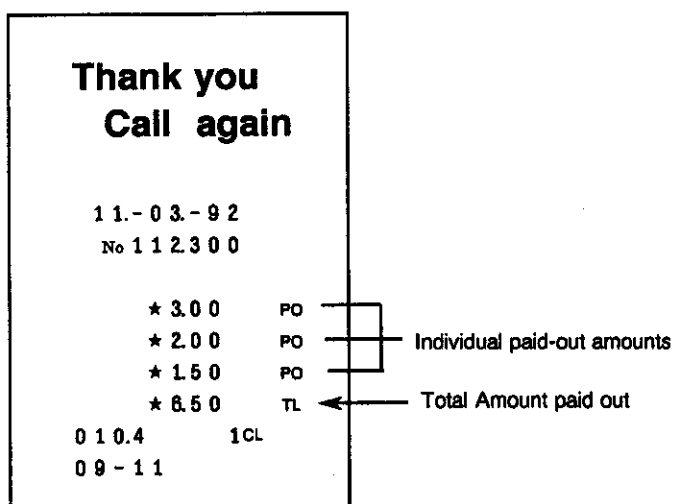
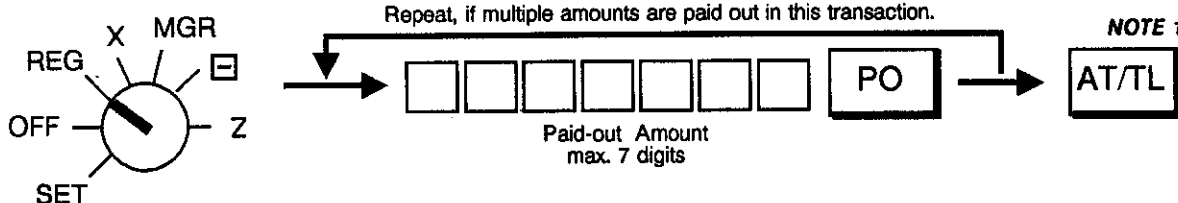

- NOTES 1.** For finalizing the transaction, only the [AT/TL] key can be used (i.e., only cash can be paid out) without entering a prior amount.
2. The PO Counter in the report memory increments on each [PO] key depression.
3. The Paid Out transaction can be programmed to require the MGR position of the Control Lock. (Refer to the chapter "22. System Option Setting", Address 5 - Bit 2. If so programmed, an error will occur on depressing the [PO] key. In that case, ask the store manager to turn the Control Lock to the MGR position for the operation.

Sale Paid in Foreign Currencies **CUR1** **CUR2** **CUR3** **CUR4**

(Foreign Currency Keys)

Foreign currencies may be tendered for payment of a sale. A maximum of four Foreign Currency Keys are available; the [CUR3] and [CUR4] keys are Optional Keys. One currency should be assigned for each key.

Programming Foreign Currency Keys

Before operating the keys, the following programming operations are necessary.

Setting Foreign Currency Exchange Rate:

Set the exchange rate of the currency. Change the rate daily, if necessary.

Condition: Any time outside a sale. Must be signed off in the Cashier Signing Method.

Programming Procedure:

Use the **MA** Key to turn the Control Lock to the "SET" position.

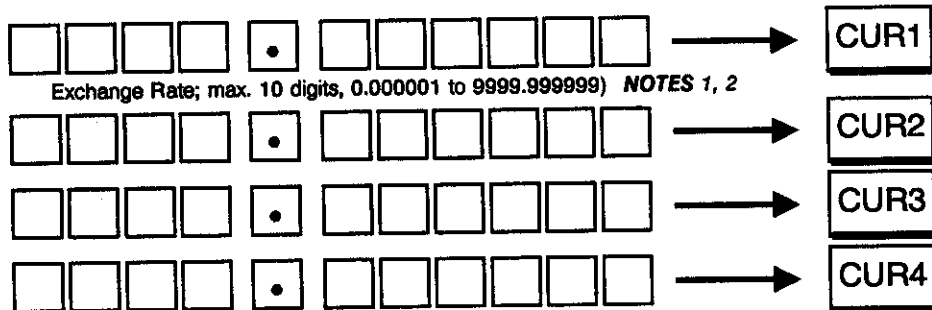
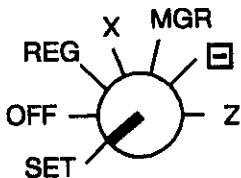

NOTES 1. Obtain the rate by calculating in the subsidiary currency unit values for both the domestic and the foreign currency. (In case of calculating the rate from the domestic to a foreign currency with the same zero-suppress form, such as from U.S. \$ to French Franc, it will be no problem. However, in case of exchanging from a domestic currency such as U.S. \$ to a foreign currency such as Japanese yen, this rule must be obeyed; otherwise a wrong rate will result.)

2. Calculate the required foreign currency value equivalent to the domestic currency value "1". Then the obtained value is the Exchange Rate value to be entered in the setting operation above.

Example) Domestic Currency is US\$:

- 1¢ = xxx.xxxxx centimes (French Franc)
- = xxx.xxxxx pfennigs (Deutsche Mark)
- = xxx.xxxxx yen (Japanese yen)
- etc.



Enter this value as the foreign currency exchange rate.

3. If "0" is set as the exchange rate, that key cannot be used in sale entries.

Example) 0.7143 for Currency 1:

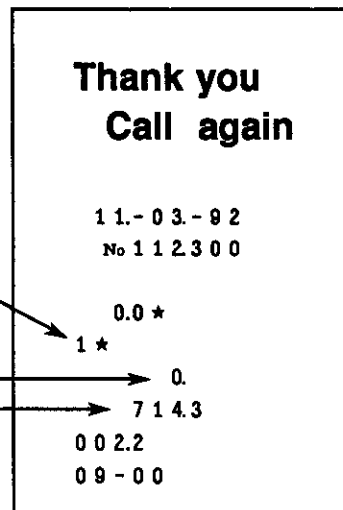
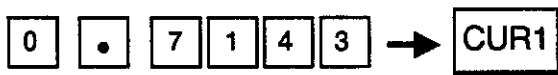

Setting Foreign Currency Amount Division Position (Display Form):

Select the appropriate amount division position for each foreign currency -- "0.00" (initial status) such as US\$ or "0" such as Japanese yen. The currency tender amount is displayed in the selected form.

Refer to Chapter "22. System Option Setting":

- Address 12 - Bit 5 for Foreign Currency 1 ([CUR1])
- Address 12 - Bit 6 for Foreign Currency 2 ([CUR2])
- Address 12 - Bit 7 for Foreign Currency 3 ([CUR3])
- Address 12 - Bit 8 for Foreign Currency 4 ([CUR4])

Entering Sale Paid In a Foreign Currency 1

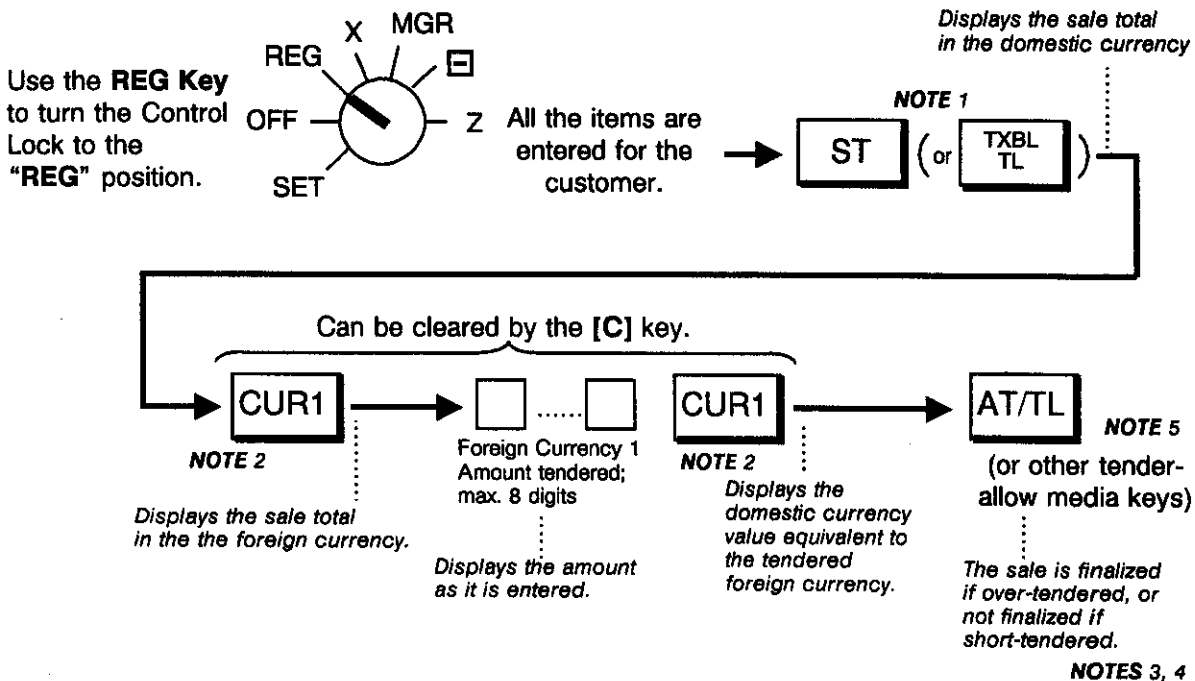

- NOTES 1.** The [ST] (or [TXBL TL]) key is not required after a short-tender entry.
- 2.** The [CUR2], [CUR3], and [CUR4] keys operate the same fashion as [CUR1] key for tendering Foreign Currencies 2, 3, and 4 respectively.
- 3.** When over-tendered:
The sale is finalized, the drawer opens, and the change due is displayed in the domestic currency which is to be returned to the customer.
When short-tendered:
The sale is not finalized. Any other media tendering may follow (refer to the section "Multi-tender, Split Tender").
- 4.** The tendered amount is processed into the following in the report memory:
 - Domestic media (of the key operated -- Cash, Check, Charge, Media-Coupon, Misc.) total
 - Foreign Currency (of the key operated -- CUR1, CUR2, CUR3, CUR4) in the foreign currency value.
 - The amount is not processed into the corresponding media-in-drawer total.
- 5.** The final media key must be programmed to allow tendering.
- 6.** A negative-balance sale cannot be finalized with a Foreign Currency key.
- 7.** The Foreign Currency keys cannot be used to finalize Received-on-Account payment entries.

Example)

Key Operation and Display

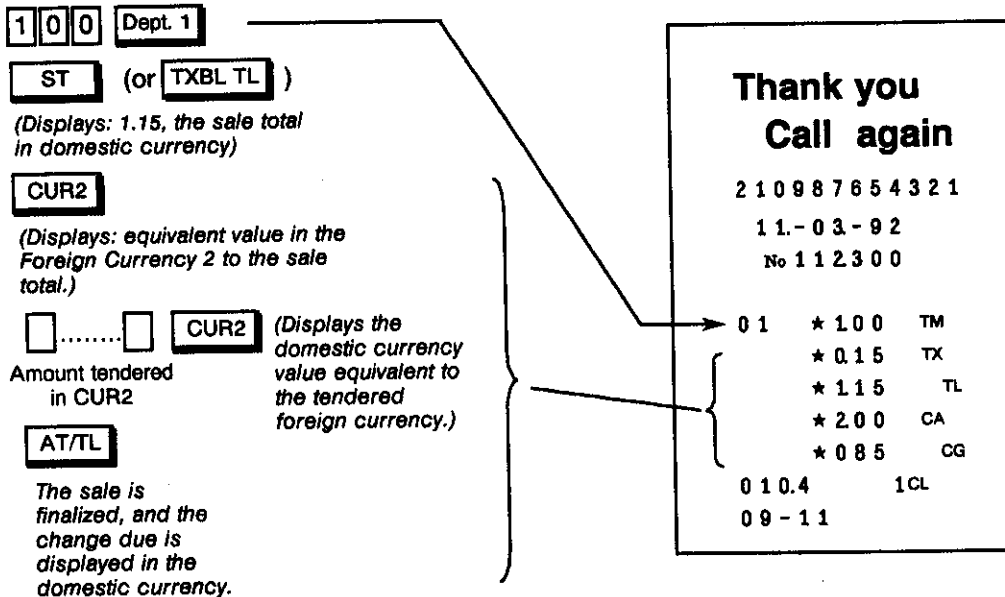

The amount tendered is not printed in the foreign currency value (but domestic value only). Neither is the exchange rate printed.

Post-issue Receipt

**RECEIPT
ISSUE**

(Post-issue Receipt Key)

When a sale is finalized with the "R OFF" lamp extinguished (the illuminated/extinguished status can be switched by the [LOG/RECEIPT] key), a receipt is automatically issued. However, if a sale is finalized with the "R OFF" lamp illuminated but a receipt is required by the customer, this key works.

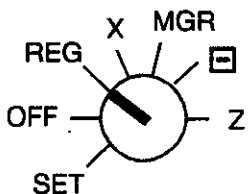

A sale is finalized, but no receipt is issued (i.e., when the "R OFF" lamp is illuminated.)



**RECEIPT
ISSUE**

A post-issue receipt is issued for the sale just finalized.

- NOTES 1.** When a sale has contents of 20 print lines or less, the post-issue receipt will be an itemized receipt, just as the ordinary receipt.
- 2.** When a sale has contents of more than 20 print lines, the post-issue receipt will be a total-only receipt.
- 3.** The Post-issue Receipt function is not effective for Received-on-Account, Paid Out, No-sale, or All Void transaction.
- 4.** If a Non-add Number print is entered at the top of a sale, the number will not be printed on the post-issue receipt.
- 5.** The Consecutive No. printed on the Post-issue Receipt is the same as the Consecutive No. that was to be printed on the normal receipt if it had been issued (i.e., it matches the Consecutive No. printed for the sale on the Journal.)

Post-issue Receipt
(for a sale containing 20
print lines or less)

**Thank you
Call again**

11.-03-92
No 112300

05 * 2.00
05 * 2.00
* 4.00 ST

10. % -
- 0.40

01 * 0.55 TM
* 0.06 TX
* 4.21 CATL

010.6 1CL
09-14

Post-issue Receipt
(for a sale containing
more than 20 print lines)

**Thank you
Call again**

11.-03-92
No 112300

*24.00 TL
010.7 1CL
09-15

Validation Print**VALI
DATE**

(Validation Key)

To perform a validation print of a sale item or a media entry, insert a validation slip to the Validation Slot and depress this key. The sale item or media data just entered is printed on the slip. Withdraw the slip to go on any other operation.

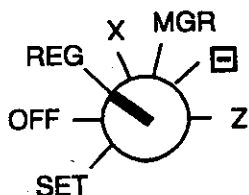

A required sale item or media is entered.

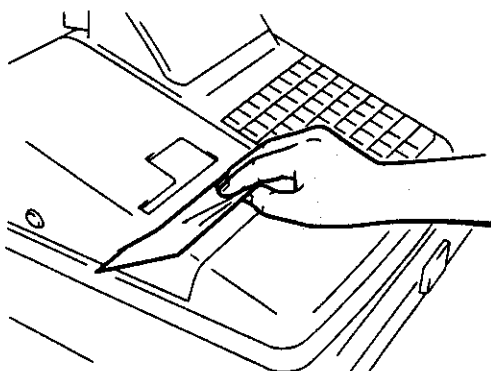

NOTE 1
Insert a slip to the Validation Slot. (See the sketch below.)

**VALI
DATE**

- NOTES 1.** On this register, depressing the **[VALIDATE]** key will execute printing regardless of presence/absence of a slip. Before depressing the key, be certain to insert a slip to the Validation Slot. (If no slip is inserted, the validation print will occur over the last printed line on the receipt.)
2. After validation print, be certain to remove the slip from the Validation Slot.
 3. The number of validation print operations are processed into the Validation counter in the report memory.
 4. The following options are selective in relation to validation print (Refer to Chapter "22. System Option Setting". Also refer to the print format on the next page.):
 - 1) Non-print Selection (**Address 12**)
 - Consecutive No. Non-print (**Bit 2**) ... Initial Status: Print
 - Cashier ID Non-print (**Bit 3**) ... Initial Status: Print
 - 2) Number of times for validation print of the same item (**Address 12 - Bit 1**)
 - Single-validation (only once allowed) (initial status), or
 - Multi-validation (any number of times allowed)
 - 3) Validation Print Content after each non-cash media tender (**Addresses 7 to 10**)
 - Sale Total Print, or Tendered Amount Print (**Bit 2**)
 - Initial Status for each Media:
 - [CHK TND]** ... Tendered Amount Print
 - [Chg]** ... Sale Total Print
 - [MISC]** ... Tendered Amount Print
 - [CPN]** ... Tendered Amount Print
- (In case of a short-tender, the tendered amount is always printed regardless of the status selection above.)

Validation Print Examples

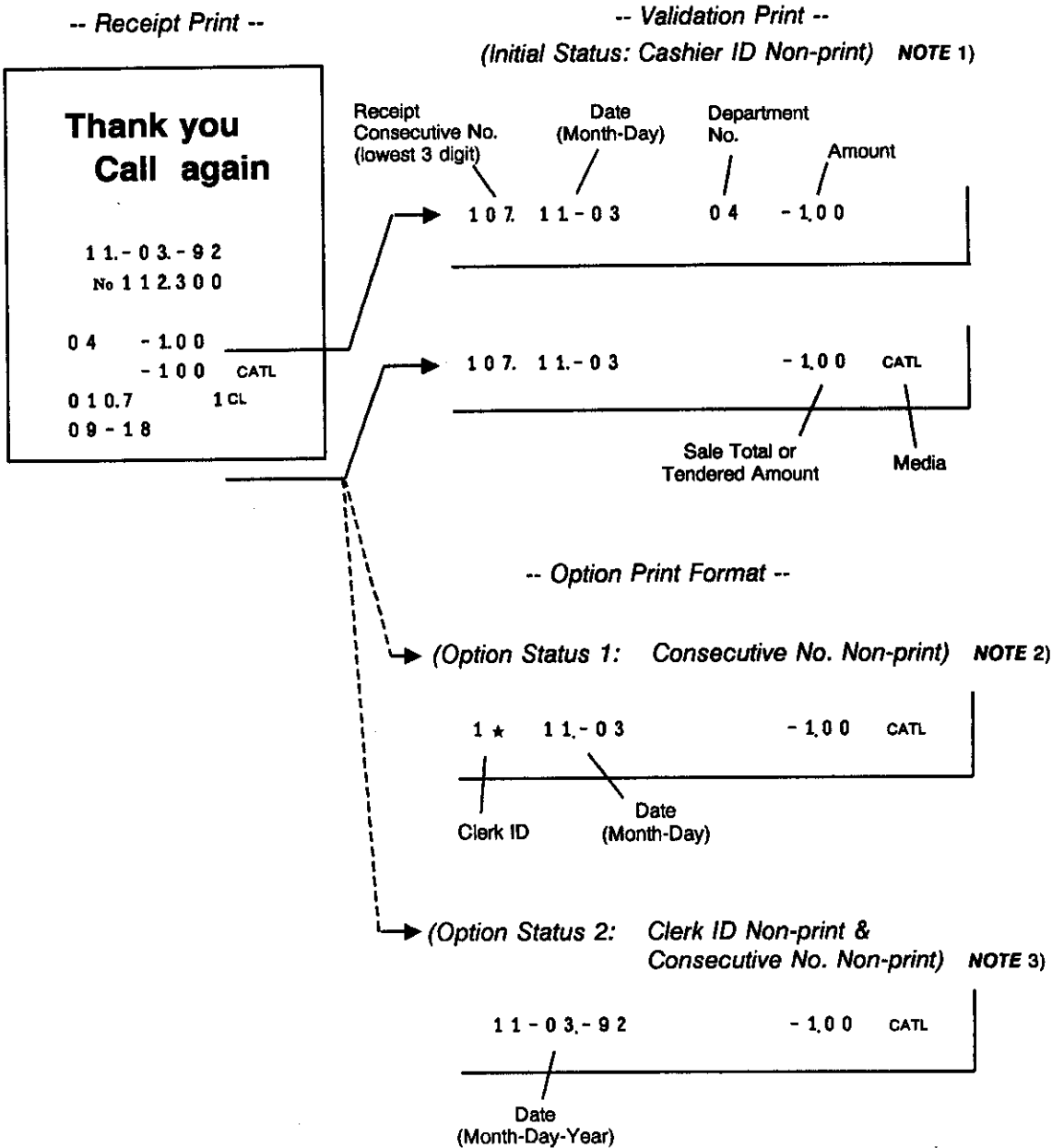

NOTE: It is not possible to print both Consecutive No. and Clerk ID on a validation slip.
Only one of the following is selective relating to Cashier ID and Consecutive No.:

- 1) Cashier ID Non-print & Consecutive No. Print (Initial Status)
System Option Address 12, Bit 2 RESET & Bit 3 RESET(or SET)
- 2) Consecutive No. Non-print & Cashier ID Print (Option Status 1)
System Option Address 12, Bit 2 SET & Bit 3 RESET
- 3) Cashier ID Non-print & Consecutive No. Non-print (Option Status 2)
System Option Address 12, Bit 2 SET & Bit 3 SET

Print/Non-print Options on Sale Receipts

The following are items that can be programmed to be printed or not on sale receipts.

To change the print/non-print status, refer to Chapter "22. System Option Setting". For changing the print/non-print status of each item, further refer to the Address No. and Bit No. in the chapter.

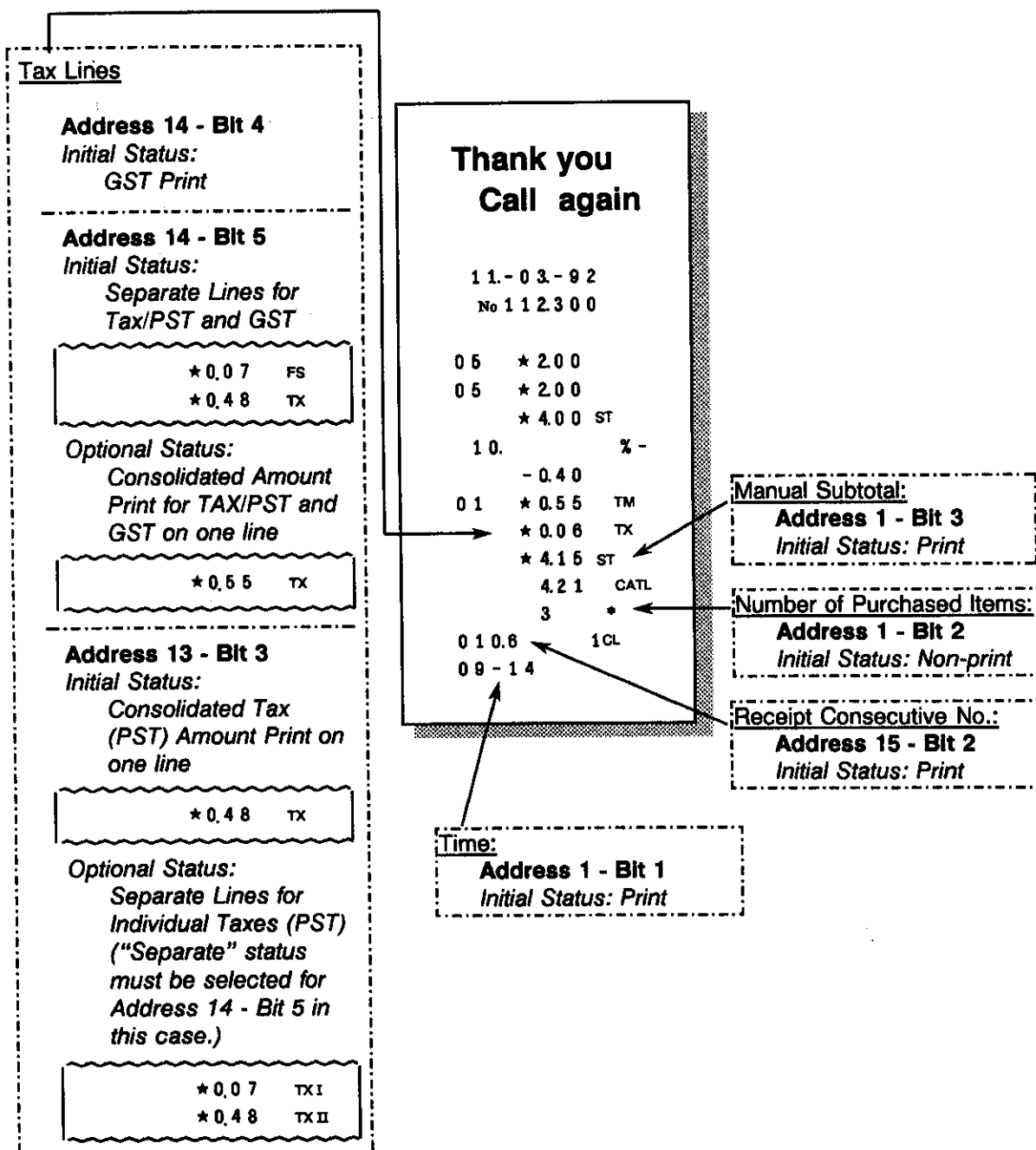

19. Operations in "MGR" Mode

This chapter describes operations to be performed in the "MGR" position of the Control Lock, which the Store Manager can access using the **MGR** or **MA** key.

Items programmed to require Manager Intervention

During daily sale entry operations, the cashier may call for Manager Intervention. The following is the operation flow of Manager Intervention.

- 1) During operations, the cashier comes across an item that requires Manager Intervention. The cashier, already informed of it, may immediately call for Manager Intervention. Or the cashier, without knowing of it, attempts the operation, and an error results, clears the error by the **[C]** key, and then calls for Manager Intervention.
- ↓
- 2) The Store Manager goes to the cashier counter with the **MGR** or **MA** key.
- ↓
- 3) The cashier explains what kind of operation is to be entered, and removes the **REG** key from the Control Lock at the "REG" position.
- ↓
- 4) The Store Manager insert the **MGR** or **MA** key and turns it to the "MGR" position.
- ↓
- 5) The cashier operates the required item.
- ↓
- 6) The Store Manager returns the **MGR** or **MA** key to the "REG" position and pulls it out.
- ↓
- 7) The cashier returns the **REG** key to the "REG" key position and continues sale entry operations.

The following are the tables of the keys and operations that are programmable with Manager Intervention. Fill in the tables by marking in the "Not required" or "Required" column of each item, referring to the System Option Setting Addresses (Chapter 22). Or only to read the set status of each Address and Bit, refer to Chapter 23. *Program Data Verification*.

Keys and Manager Intervention Status

KEY	MGR Position		Reference (See Chapter "22. System Option Setting".)
	Not required	Required	
[RTN MDSE]			Address 5 - Bit 1
[PO]			Address 5 - Bit 2
[DOLL DISC] and [% -]			Address 5 - Bit 3

Operations and Manager Intervention Status

OPERATION	MGR Position		Reference (See Chapter "22. System Option Setting".)
	Not required	Required	
Credit Balance (over-subtraction of the sale by [DOLL DISC], [VOID], [STR CPN], or [VND CPN] keys)			Address 2 - Bit 3
Negative Department or negative PLU Entries			Address 5 - Bit 4
Negative-balance Sale Finalization by Non-cash Media Keys.			Address 5 - Bit 5

Listing Capacity Release

Listing Capacities (amount limits) may be programmed on Departments (each open-price PLU is ruled by the Listing Capacity of its link Department). These LCs (Listing Capacities) are programmed to check an excessively high amount entry by cashier's mistake at the earliest stage. Guide your cashiers as in the following procedure:

- 1) During sale entries by a cashier, an error occurs when a Department or PLU item has entered.



- 2) The cashier clears the error by the [C] key. The cashier confirms the amount and operates the item again.



- 3) If the same error occurs again, the cashier attempts to enter the amount using the [LC OPEN] or [OPEN] key, allowing two further digits for an entry.



- 4) If the operation results in an error again, it means that the amount still cannot be entered by the [LC OPEN] or [OPEN] key function.



- 5) The cashier calls for Manager Intervention.



The procedure thereafter is the same as Steps 2) to 7) for the Items programmed to require **Manager Intervention** on the preceding page.

Reference: For reading the Listing Capacity of each Department:

Chapter 23. Program Data Verification, -- Department LC and Status Read --

For setting the Listing Capacities of specific Departments:

Programming Department Status on page 40.

20. Operations in "☐" Mode

This chapter describes operations to be performed in the "☐" position of the Control Lock, which the Store Owner or a person so authorized can access using the **MA** key.

Instead of using the [RTN MDSE] or [VOID] keys in the "REG" or "MGR" mode for deleting individual sale items, the "☐" mode automatically processes positive items into negative and negative into positive. To operate, turn the Mode Lock to the "☐" position using the **MA** key, and enter the items, one by one, just as in the "REG" mode as reading the sale receipt (issued at the time of the purchase) or tracing the returned items as if the "REG" mode. A positive balance resulted in the "☐" mode indicates the amount to be paid back to the customer. The "☐" mode operation may occur from time to time during the day, on the cashier's request, just as in the case of ordinary Manager Interventions, when a customer comes to the cashier counter to return or cancel all the items that were once purchased and finalized (in which case the **All Void** operation is no longer effective).

Receipt Samples in "REG" and "☐" Modes

Receipt issued in "REG" or "MGR" Mode

```

Thank you
Call again

1 1.- 0 3.- 9 2
No 1 1 2.3 0 0

0 1  * 5.5 0  TM
1 0.      % +
      * 0.5 0
0 1  * 2.0 0  TM
1 0.      % -
      - 0.2 0
      * 1.0 5  TX
      * 8.3 5  CATL
0 1 1.7      2 CL
0 9 - 3 2
  
```

These two receipts contain the same sale items and media finalization. The operations are also the same except the Control Lock position.

The cashier merely follows the purchase receipt (on the left) and enters the same items in the "☐" mode, finalizing with the same media, in case the customer has returned or canceled the entire sale after once finalized that sale.

Receipt issued in "☐" Mode

```

Thank you
Call again

1 1.- 0 3.- 9 2
No 1 1 2.3 0 0

      ** RT ← "☐" Mode
0 1  * 5.5 0  TM Receipt
1 0.      % + Header
      * 0.5 0
0 1  * 2.0 0  TM
1 0.      % -
      - 0.2 0
      * 1.0 5  TX
      * 8.3 5  CATL
0 1 2.0      2 CL
1 0 - 0 2
  
```

NOTE 1. The following items, transactions or operations cannot be entered in the "☐" mode (but allowed in "REG" or "MGR" only):

- No-sale
- Check Cashing
- Validation
- Post-issue Receipt

2. In the "☐" mode, the Listing Capacities and the status requiring Manager Intervention will all be released, i.e., the same handing as in the "MGR" mode.

21. Read and Reset Reports

This chapter describes the operation to take each report and its contents. The report function is one of the most beneficial features of this register. As sales data are entered, the register processes the data into appropriate totals and counters in the report memory. The reports are not only a form of sales data records but will also be a valuable guide to a more prosperous future of your store if you fully utilize and analyze them.

Programming Operations Relating to Reports

Programming Hourly Range Table

The "Hourly Sales Report" is available as part of the report function. However, sales data entered in "REG", "MGR", or "☐" mode are processed into Hourly Ranges only after programming an Hourly Range Table. If you have started operations on the register without this programming operation performed, the "Hourly Sales Report" cannot be taken (an error will result on attempt to take this report). The Hourly Sales Report table must be programmed before a day starts in order to obtain Hourly Sales Reports for the day and thereafter.

Condition: After Hourly Sales Reset
(refer to "NOTE on Condition" on page 23)

Programming Procedure:

Use the **MA Key** to turn the Control Lock to "SET".

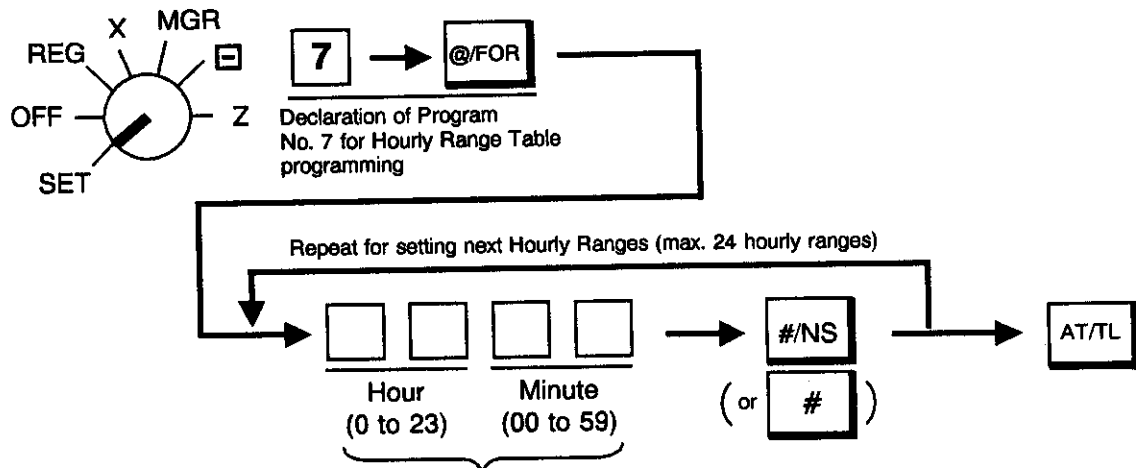

Enter the time that ends the Hourly Range, in the 24-hour system using the military time. (The time to start is the time entered for the preceding Hourly Range.)

(See NOTES 2, 3)

- NOTES 1.** A maximum of 24 hourly ranges may be set.
- 2.** Do not set an hourly range across 24:00, such as "from 23:00 to 1:00". Such setting does not cause an error in programming but the sales data will not be processed into that hourly range.

3. If an hour value of more than 23 or a minute value of more than 60 is set, it will not result in an error but the data will not be processed into that hourly range.
4. To change the table of hourly ranges once set, partially or entirely, do the entire setting operation over again.
5. To clear the hourly range table once set, operate in SET mode



Example):

Hourly Range Table

up to 8:00
 8:00 to 9:00
 9:00 to 10:00
 10:00 to 13:00
 13:00 to 16:30
 16:30 to 18:00

Key Operation

Control Lock: SET

7 @/FOR
800 #/NS
900 #/NS
1000 #/NS
1300 #/NS
1630 #/NS
1800 #/NS
AT/TL

**Thank you
Call again**

1 1 - 0 3 - 9 2
No 1 1 2 3 0 0

0.7 *
 08 - 00
 09 - 00
 10 - 00
 13 - 00
 16 - 30
 18 - 00
 00 10
 08 - .5 1

Selecting Print/Non-print Items on Reports

The following table shows the items on reports that can be programmed to be printed or non-printed according to your store's requirements. For further details of programming, refer to Chapter "22. System Option Setting". If you have started operations on the register without this programming operation performed, print or non-print status of each item is determined by the "Initial Status" in the following table. It is recommended, therefore, to change Print/Non-print status of each item after once taking all the reports.

Item	Initial Status Before Change	System Option Address No. - Bit No.
GT (Grand Total)	Print	Address 1 - Bit 4
Validation Counter	Non-print	Address 1 - Bit 5
Sum of Negative Departments	Non-print	Address 1 - Bit 6
Sum of All Departments (except Other Income Depts)	Non-print	Address 11 - Bit 2
Sum of Other Income Departments	Non-print	Address 11 - Bit 3
Net Sale With Taxes	Print	Address 13 - Bit 1
Net Sale Without Taxes	Non-print	Address 13 - Bit 2
Receipt Consecutive No. on Journal and every Receipt	Print	Address 15 - Bit 2
Receipt Consecutive No. Resetting	Non-resettable	Address 15 - Bit 3

Taking Read and Reset Reports

Fundamental Concepts of Various Types of Reports

Four types of Reports are available in connection with the Control Lock positions and the periods of data accumulation:

Daily Read Report: It can be issued at any time and any number of times during the day. It allows to read the sales data recorded up to the moment since the corresponding Reset Report was issued last time (usually yesterday). Taking this type of report will not affect any sales data in the report memory.

Daily Reset Report: The contents and format are the same as the Daily Read Report. However, it should be issued only once at the end of the day usually after closing the store. It is the "final" report that should be kept in file. Taking this type of report will clear all the resettable totals and counters in the report memory after the report is issued.

Periodical Read Report: It can be issued at any time and any number of times during a certain period defined by the store (one week, one month, etc.). Thus it allows to read the sales data accumulated up to the moment since the corresponding Periodical Reset Report was issued last time.

Periodical Reset Report: The contents and format are the same as the Periodical Read Report. However, it should be issued only once at the end of the defined period as the "final" report and be kept in file. Taking this type of report will clear all the resettable totals and counters in the report memory after the report is issued.

In addition, Read Reports (Daily or Periodical) are called "X" reports since the reports are taken with the Control Lock positioned to "X" and the header "X" is printed. Reset Reports (Daily or Periodical) are called "Z" reports, taken with the Control Lock positioned to "Z", printing the header "Z". Please also note the Reset Report Counter is printed on each Reset (Z) Report only. By this counter, you can be sure that no illegal Reset Reports were taken between the one taken last time and the one taken now.

CAUTION: Whenever you turn the Control Lock to the "Z" position, be sure that you are taking Reset Reports (final reports) and that the sales data will be cleared by the operation to follow.

Report Taking Operation

The following are the key operations to take specific reports. Be certain that the "R OFF" lamp status suits your requirement:

"R OFF" Lamp		Illuminated: Read Reports are printed on journal only. However, Reset Reports are printed on both journal and receipt.	Reverse the status, if necessary, by depressing <div style="border: 1px solid black; padding: 2px; display: inline-block; margin-top: 5px;">LOG RECEIPT</div>
		Extinguished: Read and Reset Reports are printed on both journal and receipt.	
NOTE: The [RECEIPT ISSUE] key is not effective in X or Z mode.			

Daily Read Reports:

Daily Financial Read (X) Report

Use **MGR** or **MA** Key.

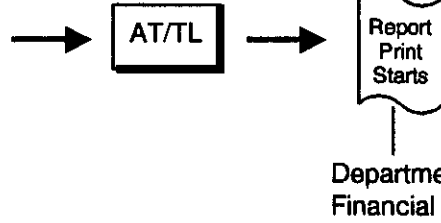
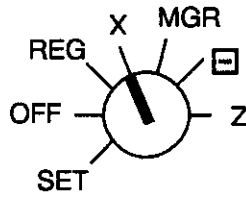

See page 100 for sample format.

Daily Cashier Read (X) Report for Signing Method (operable in signed-OFF condition only)

Use **MGR** or **MA** Key.

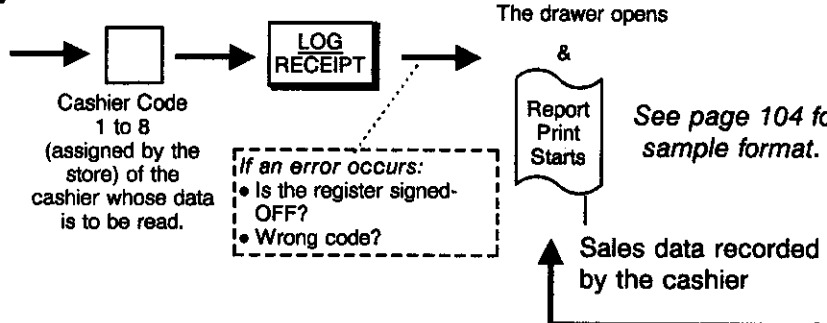
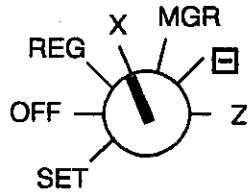

See page 104 for sample format.

Daily Cashier Read (X) Report for Cashier Lock Method

Use **MGR** or **MA** Key.

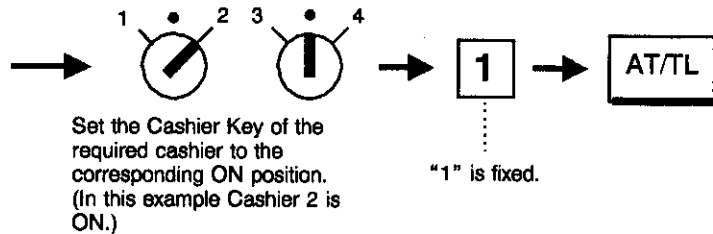
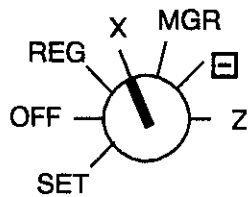

Daily Cashier Read (X) Report for Push Key Method

Use **MGR** or **MA** Key.

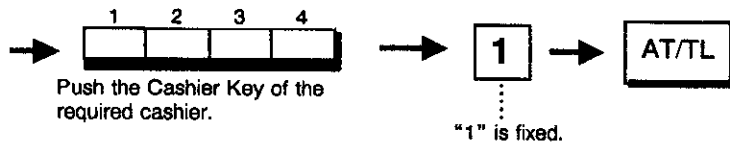
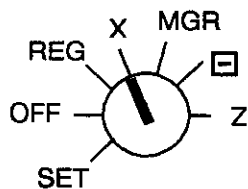

Daily Hourly Sales Read (X) Report

Use **MGR** or **MA** Key.

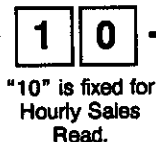
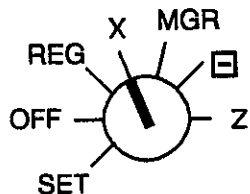

The drawer does not open.



See page 105 for sample format.

Sales data in each Hourly Range.
(Refer to the "Programming Hourly Range Table" on the first page of this chapter.)

All PLU Sales Read (X) Report

Use **MGR** or **MA** Key.

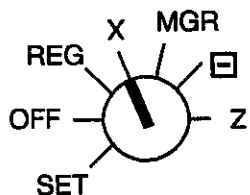

The drawer does not open.



See page 106 for sample format.

Sales data of all the PLUs with any sales data recorded.
(PLUs with zero sales data are skipped.)

Zone PLU Sales Read (X) Report

Use **MGR** or **MA** Key.

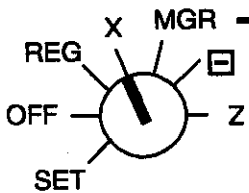

PLU Code that starts the required zone (range) for this report (max. 3 digits).



PLU Code that ends the zone (max. 3 digits).



The drawer does not open.



See page 106 for sample format.

The Start PLU Code must be equal to or smaller than the End PLU Code. When equal, the data of only one PLU is read. Entering a "0" zero) will cause an error.

Sales data of the PLUs of the codes in the range of the designated zone.
(PLUs with zero sales data are skipped.)

Media Sales and In-drawer Read (X) Report

Use **MGR** or **MA** Key.

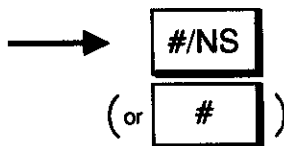
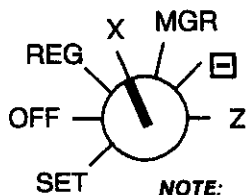

The drawer opens.



See page 107 for sample format.

Each Media Sales Total,
Each Media-in-drawer Amount

NOTE: This report must be taken, if necessary, before the Daily Financial Reset (Z) Report is taken. Otherwise, all the media data are reset by the Financial Reset.

Daily Reset Reports:

Daily Financial Reset (Z) Report

Use MA Key.

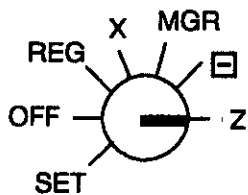

The drawer opens



Department Sales Data & Financial Sales Data

See page 100 for sample format.

Daily Cashier Reset (Z) Report for Signing Method (operable in signed-OFF condition only)

Use MA Key.

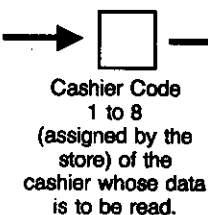
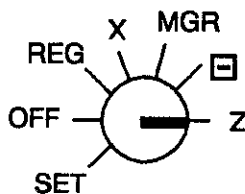

If an error occurs:

- Is the register signed-OFF?
- Wrong code?

The drawer opens



See page 104 for sample format.

Sales data recorded by the cashier

Daily Cashier Reset (Z) Report for Cashier Lock Method

Use MA Key.

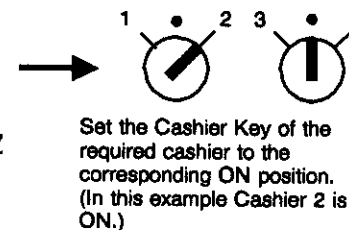
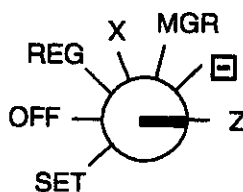

"1" is fixed.

1



Daily Cashier Reset (Z) Report for Push Key Method

Use MA Key.

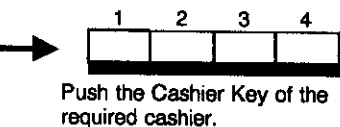
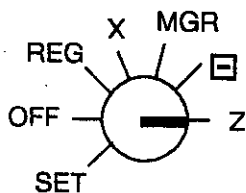

"1" is fixed.

1



Daily Hourly Sales Reset (Z) Report

Use **MA Key**.

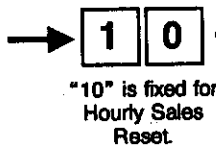
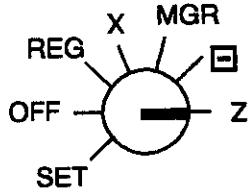

AT/TL

The drawer does not open.



See page 105 for sample format.

Sales data in each Hourly Range.
(Refer to the "Programming Hourly Range Table" on the first page of this chapter.)

All PLU Sales Reset (Z) Report

Use **MA Key**.

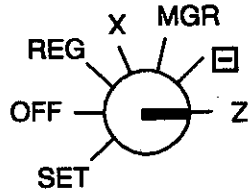

PLU

The drawer does not open.



See page 106 for sample format.

Sales data of all the PLUs with any sales data recorded.
(PLUs with zero sales data are skipped.)

Zone PLU Sales Reset (Z) Report

Use **MA Key**.

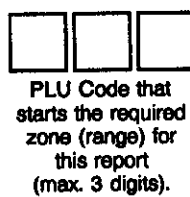
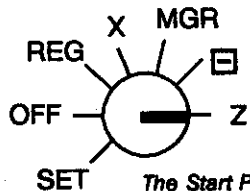

@/FOR

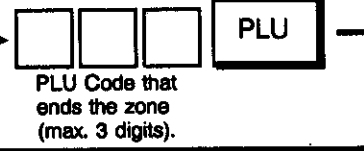

The drawer does not open.



See page 106 for sample format.

The Start PLU Code must be equal to or smaller than the End PLU Code. When equal, the data of only one PLU is read.

NOTE: If this reset report is necessary, it must be taken before the "All PLU Reset Report" (i.e., all the PLUs sales data are reset by All PLU Reset).

Sales data of the PLUs of the codes in the range of the designated zone.
(PLUs with zero sales data are skipped.)

Periodical Read Reports:

Periodical Financial Read (X) Report

Use **MGR** or **MA Key**.

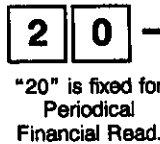
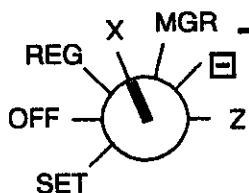

AT/TL

The drawer opens

&



See page 100 for sample format.

Department Sales Data & Financial Sales Data for the period

Periodical All Cashier Read (X) Report

(regardless of any Cashier Identifying method; Signed-OFF condition is required for Signing Method)

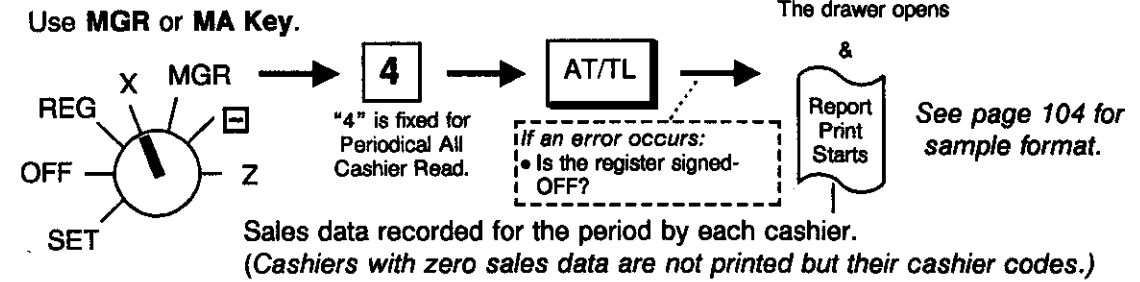

Periodical Reset Reports:

Periodical Financial Reset (Z) Report

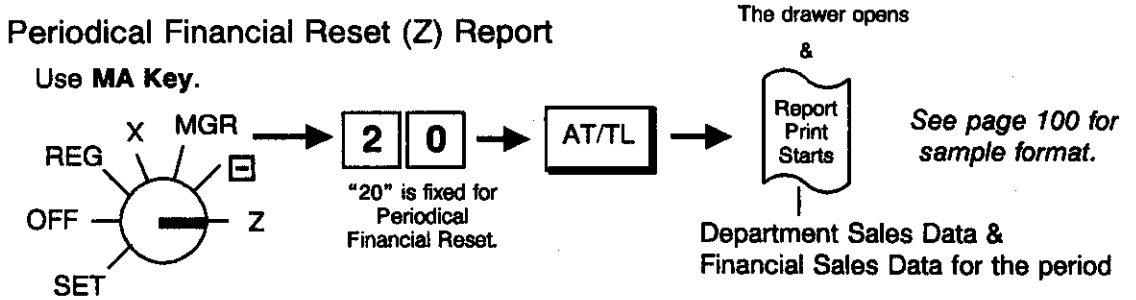

Periodical All Cashier Reset (Z) Report

(regardless of any Cashier Identifying method; Signed-OFF condition is required for Signing Method)

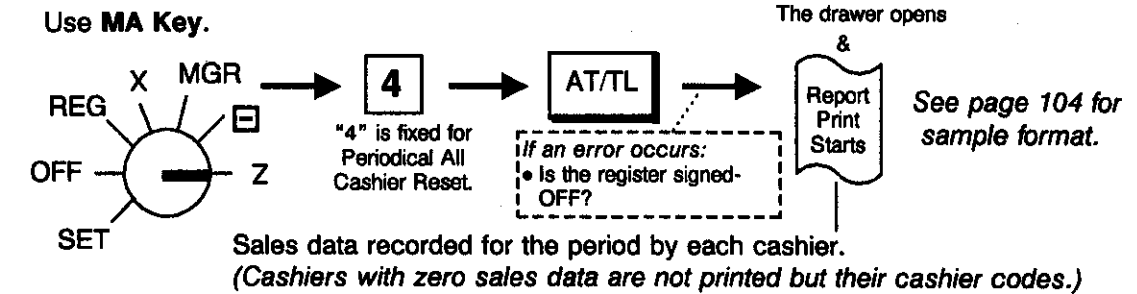

Report Sample Format

On the following pages are sample formats of respective reports. In referring to those formats, please note the following conditions:

- In each report format, all the items that can be programmed to print are placed. (Refer to **"Selecting Print/Non-print Items on Reports"** on the second page of this chapter for further information.)
- The data contents are merely examples to show the report format. The numeric data may not balance correctly. (Refer to the **"Memory Balance"** attached to the Daily Financial Read or Reset Report.) Neither the programmed contents nor sales data placed as examples in various operating procedures in Chapter "18. Setting Preparation of Each Key and Transaction Entries" nor any other chapters are related to the numeric data in the report formats.

Financial Read or Reset Report (Daily or Periodical)

**Thank you
Call again**

11-03-92
No 112300

Z

★13.470.84	GT
543.	GS
★13.470.84	GS
01	15 CU
32.	
★68.42	
0.56	%
02	8 CU
79.	
★46.41	
0.38	%
03	18 CU
★390.	
★12.086.45	
98.94	%
04	2 CU
2.	
-2.00	
05	1 CU
3.	
★1.50	
0.01	%
06	1 CU @
3.	@
★0.15	@
07	1 CU
★1.	
10.00	
0.08	%
08	2 CU
2.	
★3.00	
0.02	%
09	1 CU
4.	
-12.00	
10	0 CU
0.	
★0.00	
0.00	%
507.	TL
★12.201.78	TL

X: Daily Read
Z: Daily Reset
20X: Periodical Read
20Z: Periodical Reset

Date

Register No.

Report Type Symbol

Grand Total (non-resettable) (Initial Status: Print)

Gross Sale: Item Count
Amount

Dept. 1 Sales: Customer Count
Item Count
Amount
Sales Ratio

Dept. 2 Sales: Customer Count
Item Count
Amount
Sales Ratio

Dept. 3 Sales: Customer Count
Item Count
Amount
Sales Ratio

Dept. 4 Sales: Customer Count
Item Count
Amount

Dept. 5 Sales: Customer Count
Item Count
Amount
Sales Ratio

Dept. 6 Sales: Customer Count ("@" indicates Other Income Dept.)
Item Count
Amount

Dept. 7 Sales: Customer Count
Item Count
Amount
Sales Ratio

Dept. 8 Sales: Customer Count
Item Count
Amount
Sales Ratio

Dept. 9 Sales: Customer Count
Item Count
Amount

Dept. 10 Sales: Customer Count
Item Count
Amount
Sales Ratio

Sum of All Depts. except Other Income Depts.: Item Count
(Item Count does not include Negative Depts.) Amount] (Initial Status: Non-print)

1	% +	Percent Charge	Count	
★ 0.9 5	% +		Amount	
5 0 7.	NS	Net Sale Without Tax:	Item Count] (Initial Status: Non-print)
★1 2.2 0 2 7 3	NS		Amount	
★ 0.0 7	FS	GST Amount		(Prints only when GST Feature is selected)
★ 1.2 1 0.4 8	TX I	Tax(PST) 1	Amount	
★ 4.3 7	TX II	Tax(PST) 2	Amount	
★ 0.4 2	TX III	Manual Tax	Amount	
5 0 7.	NS	Net Sale With Tax:	Item Count] (Initial Status: Print)
★1 3.4 1 8.0 7	NS		Amount	
3.	0	Sum of Other Income Departments:	Item Count] (Initial Status: Non-print)
★ 0.1 5	0		Amount	
1	% -	Percent Discount on Subtotal:	Count	
★ 0.4 0	% -		Amount	
1	CP -	Vendor Coupon	Count	
★ 0.5 0	CP -		Amount	
1	-	Dollar Discount:	Count	
★ 0.4 0	-		Amount	
2 6	CU TL	Total Customer Count		
★1 3.4 1 6.9 2	TL	All Media Sales	Amount	
2 2	CUCA	Cash Sales:	Customer Count	
★1 3.3 9 3.9 5	CATL		Amount	
1	CUCK	Check Sales:	Customer Count	
★ 7.2 6	CKTL		Amount	
2	CUCH	Charge Sales:	Customer Count	
★ 8.3 1	CHTL		Amount	
1	CUMS	Misc. Sales:	Customer Count	
★ 6.9 0	MSTL		Amount	
0	CUCP	Media-Coupon Sales:	Customer Count	
★ 8.5 0	CPTL		Amount	
0	CUFS	Food Stamp:	Customer Count] (Prints only when Food Stamp Feature is selected.)
★ 8.0 0	FSTL		Amount	
2	RA	Received-on-Account Payment:	Count	
★ 1 2.5 0	RA		Amount	
3	PO	Paid Out	Count	
★ 6.5 0	PO		Amount	
★1 3.3 9 4.7 1	CAID	Cash-in-drawer	Amount	
2	CK	Check	Count	
★ 1 0.5 0	CKID	Check-in-drawer	Amount	
2	CH	Charge	Count	
★ 8.3 1	CHID	Charge-in-drawer	Amount	
1	MS	Misc.	Count	
★ 6.9 0	MSID	Misc.-in-drawer	Amount	
1	CP	Media-Coupon	Count	
★ 0.5 0	CPID	Media-Coupon-in-drawer	Amount	
0	FS	Food Stamp	Count	
★ 0.0 0	FSID	Food Stamp-in-drawer	Amount	
★ 0.0 0	FSCG	Food Stamp Change (Amount of change refunded in FS)] (Prints only when Food Stamp Feature is selected.)
2	VD	Item Correct:	Count	
★ 3.0 3	VD		Amount	
2	VD II	Void:	Count	
★ 1 1.0 0	VD II		Amount	
3	VD III	Misc. Void:	Count] (Item Corr and Void on other items than Departments and PLUs.
★ 0.7 5	VD III		Amount	

---These items are printed on Daily Reports only but not on Periodical Reports.

(Prints only when Food Stamp Feature is selected.)

1 VD IV
 *18.70 VD IV
 1 % -
 *0.32 % -
 1 SP
 *1.00 SP
 6
 -14.00
 5 RT
 *1.30 RT
 *0.17 TX -
 1 RT II
 *3.25 RT II
 *1.00 FSTL
 1
 *1,210.471 TXTL
 2
 *87.34 TXTL
 2 EX
 *1.00 EXFS
 *6.00 EX I
 *8.00 EX II
 *0.00 EXFS I
 *0.00 EXFS II
 1
 0
 *0.00 ID
 2
 1
 *1.00 ID
 3
 0
 *0.00 ID
 4
 0
 *0.00 ID
 1
 1*
 0001Z
 0207
 13-53

All Void (Transaction Cancel): Count
 Amount
 Percent Discount on Item: Count
 Amount
 Store Coupon: Count
 Amount
 Sum of Negative Departments: Item Count
 Amount (Initial Status: Non-print)
 Returned Merchandise: Item Count
 Amount
 Negative or Returned Tax Amount
 Negative Mode ("E" position): Count
 Amount
 Total of Sale Amount subject to GST (for GST Feature only)
 Total of Sale Amount subject to Tax(PST) 1
 Total of Sale Amount subject to Tax(PST) 2
 Total Tax Exempt Customer Count
 GST Exempt Amount (for GST Feature only)
 Tax(PST) 1 Exempt Amount
 Tax(PST) 2 Exempt Amount
 Food Stamp Tax 1 Exempt Amount (Prints only when ILLINOIS or NEW JERSEY type of Food Stamp system is selected.)
 Food Stamp Tax 2 Exempt Amount
 Foreign Currency 1:
 Tender Count
 Amount-in-drawer (in the specific currency value)
 Foreign Currency 2:
 Tender Count
 Amount-in-drawer (in the specific currency value)
 Foreign Currency 3:
 Tender Count
 Amount-in-drawer (in the specific currency value)
 Foreign Currency 4:
 Tender Count
 Amount-in-drawer (in the specific currency value)
 No-sale Count
 Validation count (Initial Status: Non-print)
 Reset Count (of each Reset Report); prints on Reset Reports only
 Receipt Consecutive No.
 Current Time

These items are
 printed on Daily
 Reports only but
 not on Periodical
 Reports.

-- Memory Balance --

Grand Total = Sum of Daily Gross Sales

NOTE

Gross Sale = (Sum of All Depts) + (Sum of Tax/PST 1 & 2 and Manual Tax)
 + (Percent Charge) + (Percent Discount on Item)
 + (Sum of Negative Depts) + (Item Correct) + (Void)
 + (Returned Merchandise) + (Negative Tax) + (GST) + (All Void)
 + ("☐" Mode) + (Store Coupon)

Net Sale With Tax

NOTE

= (Sum of All Depts) + (Sum of Tax/PST 1 & 2 and Manual Tax)
 + (Percent Charge) + (GST)
 = (Gross Sale) – (Percent Discount on Item) – (Sum of Negative Depts)
 – (Item Correct) – (Void) – (Returned Merchandise) – (Negative Tax)
 – (All Void) – ("☐" Mode) – (Store Coupon)

All Media Sales

= (Net Sale With Tax) – (Percent Discount on Subtotal) – (Dollar Discount)
 – (Vendor Coupon) + (Sum of Other Income Depts.)
 = (Cash Sales) + (Check Sales) + (Charge Sales) + (Misc. Sales)
 + (Media-Coupon Sales) + (Food Stamp Sales)

Sum of All Hourly Range Sales = Net Sale With Tax

Sum of Sales (Gross Sale) by All Cashiers = Gross Sale

"☐" Mode = Gross Sale in "☐" Mode

NOTE: "Sum of All Depts" does not include Other Income Depts, but includes Negative Departments.

Cashier Read or Reset Report (Daily or Periodical)

Daily Cashier Read or Reset Report

```

Thank you
Call again

11-03-92
No 112300

          Z
**      2 CL
          10 CU
        63.  GS
      *160.41 GS
          3.  @
      *0.15  @
          0.00 1Z
020.5     2 CL
13-43
    
```

X: Daily Read
Z: Daily Reset

Report Type Symbol

Cashier Code of the required cashier

Gross Sale: Customer Count

Item Count

Amount

Other Income Depts Total: Item Count

Amount

(Initial Status:
Non-print)

Reset Count of each cashier's Daily Reset Report (prints on Reset Reports only)

Cashier Code of the required cashier (prints for Cashier Lock or Cashier Push Key Method only)

Periodical Cashier Read or Reset Report

```

Thank you
Call again

11-03-92
No 112300

          4Z
**      1 CL
          16 CU
        480.  GS
      *13.310.43 GS
          0.  @
      *0.00  @
**      2 CL
          ...
**      3 CL
          ...
**      4 CL
          ...
          0.00 1Z
020.6
13-43
    
```

4X: Periodical All Cashier Read
4Z: Periodical All Cashier Reset

Report Type Symbol

Sales Data by Cashier 1 (same as in the Daily Report above)

Sales Data by Cashier 2 (same as in the Daily Report above)

Sales Data by Cashier 3 (same as in the Daily Report above)

Sales Data by Cashier 4 (same as in the Daily Report above)

(When no sales data is recorded, only the Cashier Code is printed.)

Reset Count of this Reset Report (prints on Reset Reports only)

Daily Hourly Sales Read or Reset Report

**Thank you
Call again**

11-03-92
No 112300

10Z

★★

08-00
09-00

10CU

*13.27558

10-00

16CU

*14249

13-00
16-30
18-00

0001Z

020.4
13-43

10X: Daily Read
10Z: Daily Reset

Report Type Symbol

Sales Data from 18:01:00 yesterday to 8:00:59 ... No sales recorded

Sales Data from 8:01:00 to 9:00:59 ... No sales recorded

Customer Count

Net Sale With Tax



Sales Data in Hourly Range from 9:01:00 to 10:00:59

Customer Count

Net Sale With Tax



Sales Data in Hourly Range from 10:01:00 to 13:00:59

Sales Data from 13:01:00 to 16:30:59 ... No sales recorded

Sales Data from 16:31:00 to 18:00:59 ... No sales recorded

Reset Count of this Reset Report (*printed on Reset Reports only*)

Daily PLU Read or Reset Report (All or Zone)

Daily All PLU Read or Reset Report

**Thank you
Call again**

11-03-92
No 112300

Z

PL 3 0.0	3.	
	★150	
PL 4 0.0	4.	
	-1200	
PL 5 0.0	3.	
	★600	
PL 5 0 1	5.	
	★1667	
PL 5 0.2	13.	
	★910	
PL 9 9.9	6.	
	★6000	
	30.	TL
	★8127	TL
	0001Z	
020.1		
13-30		

X: Daily Read
Z: Daily Reset

Report Type Symbol

PLU Code 300 (disregard the decimal point in the code):

Sale Item Count
Sale Amount

PLU Code 400:

Sale Item Count
Sale Amount

PLU Code 500:

Sale Item Count
Sale Amount

PLU Code 501:

Sale Item Count
Sale Amount

PLU Code 502:

Sale Item Count
Sale Amount

PLU Code 999:

Sale Item Count
Sale Amount

Total of PLUs read in this report: Sale Item Count (Positive PLUs only)
Amount (Positive PLUs – Negative PLUs)
Reset Count of PLU Reset Report (including Zone Reset): *printed on Reset Reports only*

Daily Zone PLU Read or Reset Report

The format is the same as "All PLU Read or Reset Report" above. Only the difference is that the Zone Read or Reset Report outputs only the PLUs in the zone designated by the key operation to take the report.

Daily Media Sales & In-drawer Read Report

**Thank you
Call again**

1 1 - 0 3 - 9 2

No 1 1 2 3 0 0

	X	
	2 6	CU TL
★	1 3.4 1 6.9 2	TL
★	1 3.3 9 4.7 1	CAID
	2	CK
★	1 0.5 0	CKID
	2	CH
★	0.3 1	CHID
	1	MS
★	6.9 0	MSID
	1	CP
★	0.5 0	CPID
	0	FS
★	0.0 0	FSID
★	0.0 0	FSCG
1		
	0	
★	0.0 0	ID
2		
	1	
★	1.0 0	ID
3		
	0	
★	0.0 0	ID
4		
	0	
★	0.0 0	ID
0 2 0.3		
1 3 - 4 2		

Report Type Symbol (Daily Read Report only)

Total Customer Count
All Media Sales Amount
Cash-in-drawer Amount
Check Count
Check-in-drawer Amount
Charge Count
Charge-in-drawer Amount
Misc. Count
Misc.-in-drawer Amount
Media-Coupon Count
Media-Coupon-in-drawer Amount
Food Stamp Count
Food Stamp-in-drawer Amount
Food Store Change (Change refunded in Food Stamps)
Foreign Currency 1:
Count
Amount-in-drawer (in specific currency value)
Foreign Currency 2:
Count
Amount-in-drawer(in specific currency value)
Foreign Currency 3:
Count
Amount-in-drawer(in specific currency value)
Foreign Currency 4:
Count
Amount-in-drawer(in specific currency value)

22. System Option Setting

This chapter is provided for your selections of the register's basic functions according to the market and your requirements, some of which are already indicated for reference in other chapters as to print/non-print items, key functions, etc.

Programming Procedure

The System Options are divided into 16 addresses and each address is further divided into a maximum of 8 bits (Bits 1 to 8). Each Address table is placed on the following pages.

Condition: After Daily Financial Reset
(refer to "NOTE on Condition" on page 23)

Programming Procedure:

Use the **MA Key** to turn the Control Lock to "SET" or the **S Key** to turn the Control Lock to "BLIND".

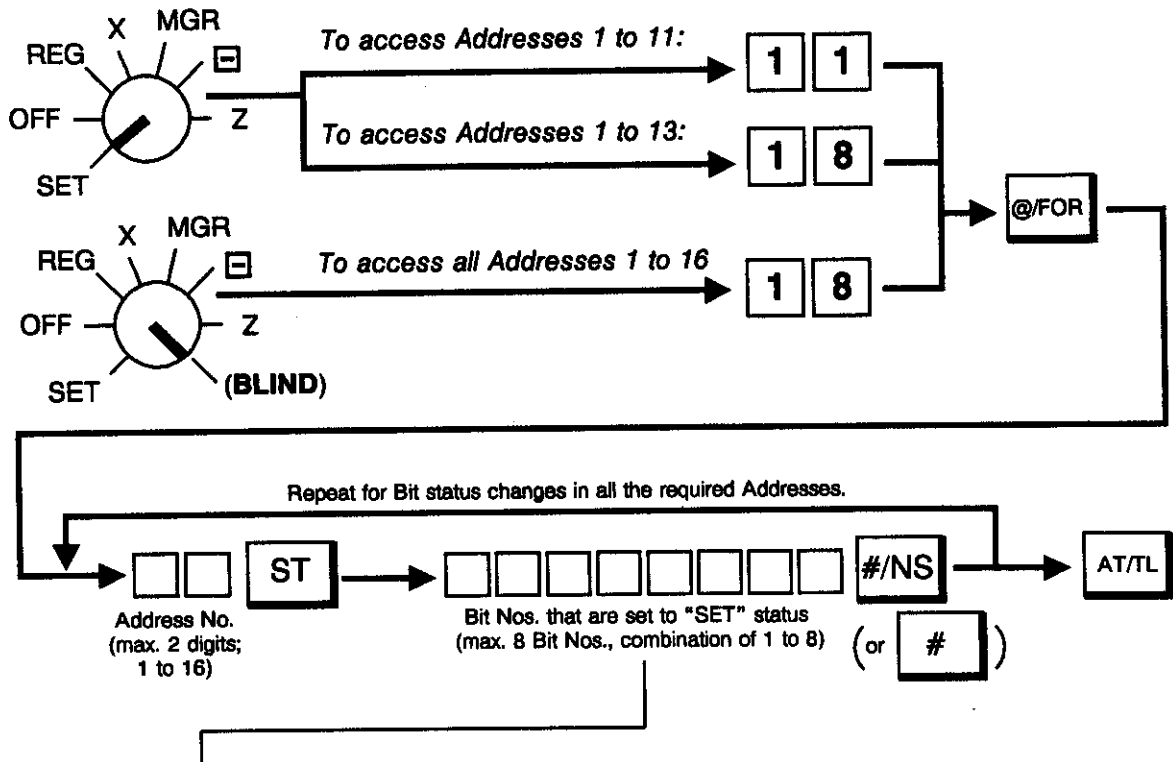

Enter a maximum of eight-digit number composed of Bit Nos. whose status must be set to the "SET" status in the Address. If there is no Bit Nos. to be set to the "SET" status, enter "0" for the Address.

- Examples) To SET Bit 2 only Enter 2.
 To SET Bits 2 and 3 Enter 23.
 To SET all the Bits Enter 12345678.
 To RESET all the Bits Enter 0.

To change any Bit in an Address, enter the Address No. and enter all the SET Bit Nos again. If a Bit No. is not included in the SET Bit Nos, the Bit will be RESET.

NOTES 1. Any Bit No. shaded and filled with "-- vacant --" in the Address tables on the following pages will be disregarded even if it is SET or RESET. (However, if ever SET, it will not result in an error.)

2. The Initial Status of each Bit is indicated by a dotted frame such as:

If you have never changed the Bit statuses in the Address before, the Initial Status is active. Therefore, only the Bit status changes of the required Addresses may be entered. If an All Memory Clear is operated (refer to Chapter "26. Status Clear and Memory Clear Operations"), all the Bits in all the Address automatically regain the Initial Status.

Programming Example) To select the following options:

Address 1 (refer to the next page)

Bit 1: Time NON-PRINT (SET status)

Bit 2: Purchased Item Count NON-PRINT (SET status)

Other Bits are to be all RESET (PRINT)

Control Lock: **BLIND**

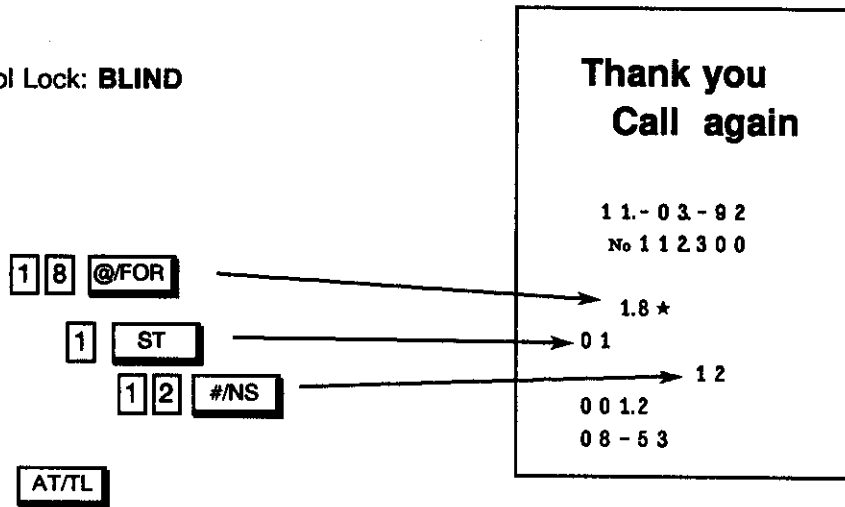

Address: **1** Initial SET Bit Nos. **2 5 6**
 (Non-print Options 1) Your Selection

Bit No.	Content	Selective Status	
		RESET	SET
1	Time on Journal and Every Receipt	PRINT	NON-PRINT
2	Purchased Item Count on Sale Receipts	PRINT	NON-PRINT
3	Manual Subtotal on Sale Receipts	PRINT	NON-PRINT
4	GT (Grand Total) on Financial Reports (in X and Z modes)	PRINT	NON-PRINT
5	Validation Counter on Financial Reports (in X and Z modes)	PRINT	NON-PRINT
6	Sum of Negative Department Data on Financial Reports (in X and Z modes)	PRINT	NON-PRINT
7, 8	-- vacant --		

Address: **2** Initial SET Bit Nos. **0**
 (Optional Functions 1) Your Selection

Bit No.	Content	Selective Status	
		RESET	SET
1	Fraction Rounding Process on Quantity Extension or % Calculations	Round OFF	ROUND UP
2	Fraction Rounding Process on Quantity Extension or % Calculations	Follow Bit 1 status.	ROUND DOWN
3	Credit Balance (over-subtraction of the sale by [DOLL DISC], [VOID] keys, etc.) in REG mode	PROHIBITED	ALLOWED
4	Obtaining Taxable Total (sale total including taxes) by [TXBL TL] or [ST] key before finalizing each sale	NOT COMPULSORY	COMPULSORY
5	SPP Fraction Round-up Process	ROUND UP PRODUCT	ROUND UP ITEM PRICE
6 to 9	-- vacant --		

Supplementary Description:

- Bit 1 & Bit 2: If both RESET, ROUND OFF status is obtained.
 If both SET, Bit 2 status prevails, i.e., ROUND DOWN.
 (Fraction Rounding Process on tax/PST calculations is fixed to ROUND OFF, out of the application of the process selected here. As for GST, see Address 14 - Bits 2 & 3)
- Bit 3: The [RTN MDSE] key is operable to turn the sale into negative regardless of this bit status selection.

Bit 5: ex.) When a customer wants 2 items (Purchased Quantity) of the 3 items (Whole Package Quantity) of \$1.00 (Whole Package Quantity):

RESET status (ROUND UP PRODUCT)

$$\{100 \text{ (Whole Package Price)} + 3 \text{ (Whole Package Q'ty)}\} \times 2 = 66.666\dots$$

→Round up to **\$0.67**

RESET status (ROUND UP ITEM PRICE)

$$100 \text{ (Whole Package Price)} + 3 \text{ (Whole Package Q'ty)} = 33.333\dots$$

→Round up to \$0.34 (Item Price). Then $\$.034 \times 2 = \mathbf{\$0.68}$

Address:

Initial SET Bit Nos.

(Tax Status, Food Stamp Status 1) Your Selection

Bit No.	Content	Selective Status	
		RESET	SET
1	[% +] key PST/Tax Status	NON-TAXABLE	TAXABLE
2	[% -] key PST/Tax Status	NON-TAXABLE	TAXABLE
3	[DOLL DISC] key PST/Tax Status	NON-TAXABLE	TAXABLE
4	[% +] key GST or Food Stamp Status	GST NON-TAXABLE, or Non-food-stampable	GST TAXABLE, or Food-stampable
5	[% -] key	GST NON-TAXABLE, or Non-food-stampable	GST TAXABLE, or Food-stampable
6	[DOLL DISC] key	GST NON-TAXABLE, or Non-food-stampable	GST TAXABLE, or Food-stampable
7, 8	-- vacant --		

Supplementary Description:

Bit 1 & Bit 2: RESET status The keys always operates as Non-taxable.
 SET status .. The keys become PST/Tax Taxable if they are used after depressing the [ST] key. The keys obey Department PST/Tax status if they are used after entering a Department or PLU item.

Bit 3: RESET status The key always operates as Non-taxable.
 SET status .. The key always operates as Taxable.

Whether "GST" Status is applied or "Food Stamp" Status is applied for Bits 4 to 6 here is determined by the Address 14 - Bit 1 status selection.

Bit 4 & Bit 5: RESET status The keys always operates as GST Non-taxable or Non-food-stampable.
 SET status .. The keys become GST Taxable or Food-stampable if they are used after depressing the [ST] key. The keys obey Department GST or Food Stamp status if they are used after entering a Department or PLU item.

Bit 6: RESET status The key always operates as GST Non-taxable or Non-food-stampable.
 SET status .. The key always operates as GST Taxable or Food-stampable.

Address: **4** Initial SET Bit Nos. 0
 (Tax Status, Food Stamp Status 2) Your Selection

Bit No.	Content	Selective Status	
		RESET	SET
1	[STR CPN] key PST/Tax Status	NON-TAXABLE	TAXABLE
2	[VND CPN] key PST/Tax Status	NON-TAXABLE	TAXABLE
3	[STR CPN] key GST or Food Stamp Status	GST NON-TAXABLE, or Non-food-stampable	GST TAXABLE, or Food-stampable
4	[VND CPN] key GST or Food Stamp Status	GST NON-TAXABLE, or Non-food-stampable	GST TAXABLE, or Food-stampable
5 to 8	-- vacant --		

Supplementary Description:

Bit 1 & Bit 2: RESET status The keys always operates as PST/Tax Non-taxable.
 SET status .. The key always operates as PST/Tax Taxable.

Whether "GST" Status is applied or "Food Stamp" Status is applied for Bits 3 & 4 here is determined by the Address 14 - Bit 1 status selection.

Bit 3 & Bit 4: RESET status The key always operates as GST Non-taxable or Non-food-stampable.
 SET status .. The key always operates as GST Taxable or Food-stampable.

Address: **5** Initial SET Bit Nos. 0
 (MGR Intervention Requirement) Your Selection

Bit No.	Content	Selective Status	
		RESET	SET
1	[RTN MDSE] key	Not required	Required
2	[PO] key	Not required	Required
3	[DOLL DISC] and [% -] keys	Not required	Required
4	Negative Departments and Negative PLUs	Not required	Required
5	Non-cash Media Keys to finalize a negative-balance sale	Not required	Required
6 to 8	-- vacant --		

Supplementary Description:

Bit 1 to Bit 5: RESET status The key can operate in "REG" mode.
 SET status .. Operating the key in "REG" mode will cause an error. The Control Lock must be turned to "MGR" position (or "☐" position for reverse process).

Address: **6** Initial SET Bit Nos. → **0**
 ([AT/TL] Key Function) Your Selection →

Bit No.	Content	Selective Status	
		RESET	SET
1	Tender and Total Functions in finalizing a sale	TENDER or TOTAL	TENDER only
2 to 8	-- vacant --		

Supplementary Description:

Bit 1: RESET status ... The key functions as Tender Key with a prior amount entry or as Total Key without any amount entry.
 SET status ... The key always requires a tender amount entry.

Address: **7** Initial SET Bit Nos. → **1 2 3**
 ([CHK TND] Key Function) Your Selection →

Bit No.	Content	Selective Status	
		RESET	SET
1	Tender and Total Functions in finalizing a sale	TENDER or TOTAL	TENDER only
2	Validation Print Content on Over-tendering	SALE TOTAL	TENDERED AMOUNT
3	Cashing with no purchase, using this key.	PROHIBITED	ALLOWED
4	Over-tendering (tendering an amount larger than the sale total, resulting in calculation of change due)	ALLOWED	PROHIBITED
5 to 8	-- vacant --		

Supplementary Description:

Bit 1: Refer to the "Supplementary Description" of Bit 1 attached to Address 6 above.
 BIT 2: RESET status ... Prints the sale total amount.
 SET status ... Prints the tendered amount.
In case of a short-tender, the tendered amount is always printed regardless of this bit status selection.
 Bit 3: RESET status ... Customers' checks cannot be cashed outside a sale.
 SET status ... Customers' checks can be cashed with no purchase outside a sale.
 Bit 4: This Bit status selection is effective only in tendering operation.
 SET status ... If this bit is SET and also Address 11 - Bit 1 is SET (for Short-tendering Prohibited), an amount equal to the sale total is always required for tendering.

Address: **8**

Initial SET Bit Nos. →

1

([Chg] Key Function)

Your Selection →

Bit No.	Content	Selective Status	
		RESET	SET
1	Tender and Total Functions in finalizing a sale	TENDER or TOTAL	TOTAL only
2	Validation Print Content on Over-tendering	SALE TOTAL	TENDERED AMOUNT
3	Cashing with no purchase, using this key	PROHIBITED	ALLOWED
4	Over-tendering (tendering an amount larger than the sale total, resulting in calculation of change due): effective only when Bit 1 is RESET	ALLOWED	PROHIBITED
5 to 8	-- vacant --		

Supplementary Description:

Bit 1: RESET status ... The key functions as Tender Key with a prior amount entry or as Total Key without any amount entry.

SET status ... The key functions as Total Key only.

Bits 2, 3, & 4: Same as Bits 2, 3, & 4 in Address 7 ([CHK TND] Key Function).

Address: **9**

Initial SET Bit Nos. →

1 2

([MISC] Key Function)

Your Selection →

Bit No.	Content	Selective Status	
		RESET	SET
1	Tender and Total Functions in finalizing a sale	TENDER or TOTAL	TENDER only
2	Validation Print Content on Over-tendering	SALE TOTAL	TENDERED AMOUNT
3	Cashing with no purchase, using this key	PROHIBITED	ALLOWED
4	Over-tendering (tendering an amount larger than the sale total, resulting in calculation of change due)	ALLOWED	PROHIBITED
5	Finalizing Received-on-Account Transactions	ALLOWED	PROHIBITED
6 to 8	-- vacant --		

Supplementary Description:

Bits 1, 2, 3, & 4: Same as Bits 1 2, 3, & 4 in Address 7 ([CHK TND] Key Function).

Bit 5: SET status ... Received-on-Account transaction cannot be finalized by this media key.

Address: **1 0**

Initial SET Bit Nos. →

1 2 4

([CPN] Key Function)

Your Selection →

Bit No.	Content	Selective Status	
		RESET	SET
1	Tender and Total Functions in finalizing a sale	TENDER or TOTAL	TENDER only
2	Validation Print Content on Over-tendering	SALE TOTAL	TENDERED AMOUNT
3	Cashing with no purchase, using this key	PROHIBITED	ALLOWED
4	Over-tendering (tendering an amount larger than the sale total, resulting in calculation of change due)	ALLOWED	PROHIBITED
5	Finalizing Received-on-Account Transactions	ALLOWED	PROHIBITED
6 to 8	-- vacant --		

Supplementary Description:

Bits 1, 2, 3, & 4: Same as Bits 1 2, 3, & 4 in Address 7 (**[CHK TND]** Key Function).

Bit 5: Same as Bit 5 in Address 9 (**[MISC]** Key Function).

Address: **1 1**

Initial SET Bit Nos. →

0

(Optional Functions 2)

Your Selection →

Bit No.	Content	Selective Status	
		RESET	SET
1	Short-tendering using any media key. (applicable to [AT/TL] , [CHK TND] , [Chg] , [MISC] , [CPN])	ALLOWED	PROHIBITED
2	Sum of all Departments (except Other Income Departments) on Financial Reports	NON-PRINT	PRINT
3	Sum of Other Income Departments on Financial Reports	NON-PRINT	PRINT
4 to 8	-- vacant --		

Address: **1** **2**

(Validation and Foreign Currency Options)

Initial SET Bit Nos. →

0

Your Selection →

Bit No.	Content	Selective Status	
		RESET	SET
1	Validation allowed for same item	Only Once	Any number of times
2	Receipt Consecutive No. on Validation	PRINT	NON-PRINT
3	Cashier ID on Validation	PRINT	NON-PRINT
4	-- vacant --		
5	Foreign Currency 1 ([CUR1]): Display Format for Amount of Zero (zero-suppress form)	0.00 (for unit format such as U.S. \$)	0 (for unit format such as Japanese yen)
6	Foreign Currency 2 ([CUR2]): Display Format for Amount of Zero (zero-suppress form)	0.00 (for unit format such as U.S. \$)	0 (for unit format such as Japanese yen)
7	Foreign Currency 3 ([CUR3]): Display Format for Amount of Zero (zero-suppress form)	0.00 (for unit format such as U.S. \$)	0 (for unit format such as Japanese yen)
8	Foreign Currency 4 ([CUR4]): Display Format for Amount of Zero (zero-suppress form)	0.00 (for unit format such as U.S. \$)	0 (for unit format such as Japanese yen)

Supplementary Description:

Bit 2 & Bit 3: Refer to the section "Validation Print" in Chapter 18.

Address: **1** **3**

(Non-print Options 2)

Initial SET Bit Nos. →

2

Your Selection →

Bit No.	Content	Selective Status	
		RESET	SET
1	"Net Sale With Tax" Line on Financial Reports	PRINT	NON-PRINT
2	"Net Sale Without Tax" Line on Financial Reports	PRINT	NON-PRINT
3	Tax(PST) Amount Line(s) on Sale Receipts when Tax(PST) 1 and Tax(PST) 2 are programmed.	CONSOLIDATED LINE (into one tax amount)	SEPARATE PRINT LINES
4 to 6	-- vacant --		

Supplementary Description:

- Bit 3: RESET status ... The tax amount line is only one, consolidating the amounts of the two taxes into one.
- SET status ... The amounts of the two taxes are printed on individual lines. This status selection is effective only when Address 14 - Bit 5 is SET (for GST separate print from PST).

Address: **1 4**

(GST Options)

Initial SET Bit Nos. →

4 5

Your Selection →

Bit No.	Content	Selective Status	
		RESET	SET
1	Food Stamp Feature (for US) or GST Feature (for certain areas in Canada)	FOOD STAMP <i>(All bit status selections below are disregarded)</i>	GST
2	Fraction Rounding Process on GST Calculations.	<i>Follow Bit 3 status.</i>	ROUND UP
3	Fraction Rounding Process on GST Calculations.	ROUND OFF	ROUND DOWN
4	GST Amount Lines on Sales Receipts	NON-PRINT	PRINT
5	PST & GST Amount Lines Print Format on Sales Receipts (when Bit 4 is SET)	CONSOLIDATED AMOUNT LINE	SEPARATE LINES
6	Sale amount subject to PST calculation	INCLUDING PST	EXCLUDING PST
7, 8	-- vacant --		

Supplementary Description:

Bit 2 & Bit 3: If both RESET, ROUND OFF status is obtained.
 If both SET, Bit 3 status prevails, i.e., ROUND DOWN.
 (For Fraction Rounding Process on Quantity Extension and % calculations, see Address 2 - Bits 1 & 2. As for fraction rounding process on PST calculations, ROUND OFF status is fixed.)

Bit 5: If SET status is selected, you can further select printing of PST1 and PST2 on one consolidated line or separate lines. (See Address 13 - Bit 3.)

Address: **1 5**

(Optional Functions 3)

Initial SET Bit Nos. →

4

Your Selection →

Bit No.	Content	Selective Status	
		RESET	SET
1	No-sale Transaction Entry After Non-add Number Print Entries	PROHIBITED	ALLOWED
2	Receipt Consecutive No. on Journal and every Receipts in any mode	PRINT	NON-PRINT
3	Receipt Consecutive No. Resetting	NON-RESETTABLE	RESETTABLE
4	Amount Display by [ST] key depression during a sale	SUBTOTAL (Sale Total excluding Taxes)	TAXABLE TOTAL (Sale Total including Taxes)
5	Cashier Identifying Method	Signing Method	Cashier Lock or Push Key Method
6 to 8	-- vacant --		

Supplementary Description:

- Bit 1: RESET status ... Non-add Numbers cannot be printed on No-sale receipts.
 SET status ... Non-add Numbers can be printed on No-sale receipts.
- Bit 3: RESET status ... The Consecutive No. will increment every time a receipt is issued or a transaction is finalized. It is non-resettable.
 SET status ... When a Daily Financial Reset Report is issued, the Consecutive No. is automatically reset. On the first receipt issued after the reset report, the Consecutive No. "0001" will be printed. If this status is selected, it is recommended to take the Daily Financial Reset Report at the end of all operations on the register for the day (so that the first receipt will always start with Consecutive No. 0001 every day).
- Bit 4: RESET status ... This status should be selected when both [ST] and [TXBL TL] keys are installed on the keyboard. Then [ST] displays SUBTOTAL while [TXBL TL] displays TAXABLE TOTAL.
 SET status ... This status should be selected when only [ST] is installed but not [TXBL TL].
 Depressing [ST] always prints (if "PRINT" option is selected at Address 1- Bit 3) SUBTOTAL regardless of this bit status selection.
- Bit 5: RESET status ... Sign ON & Sign OFF are entered through the [LOG/RECEIPT] key.
 SET status ... Cashier Locks or Cashier Push Keys are used for identifying the operating cashier.

Address: Initial SET Bit Nos. →

(Optional Functions 4) Your Selection →

Bit No.	Content	Selective Status	
		RESET	SET
1	Drawer-close before starting any operation in any mode except SET and BLIND.	NOT COMPULSORY See NOTE next page	COMPULSORY
2	Number of times allowed for % (% + or % -) entries after once depressing [ST] during a sale	ANY NUMBER OF TIMES	ONLY ONCE
3	Single Drawer or Two Drawers	SINGLE DRAWER	TWO DRAWERS
4	Food Stamp Type	Follow Bit 5 status.	Other Types
5	Food Stamp Type	GENERAL	Other Types
6	Journal Print Format	IPD	INPD
7	Date Setting and Print Order	Follow Bit 8 status.	Day-Month-Year
8	Date Setting and Print Order	Year-Month-Day	Month-Day-Year

Supplementary Description:

- Bit 1: RESET status ... Any operation is possible with the drawer kept open.
 SET status ... If any operation is attempted in REG, X, MGR, \square , or Z mode with the drawer kept open, an error results and keys on the keyboard are locked.
- Bit 2: RESET status ... Even when a % is entered after once obtaining a subtotal during a sale, another % entry is possible if preceded with a prior depression of the [ST] key.
 SET status ... A second % entry after once entering a % after a subtotal within a sale will cause an error.
- Bit 3: SET status (TWO DRAWERS)
 ... Select this status when two drawers are connected. Drawer 1 will correspond to Cashier 1 and 2, and Drawer 2 will correspond to the other cashiers.
- Bit 4 & Bit 5: Bit 4 and Bit 5 both RESET... **GENERAL** Type
 The customer may pay up to the food-stampable amount plus its taxes due in food stamps. (The FOOD STAMPABLE TOTAL read in the display includes the taxes due.)
 Bit 4 SET and Bit 5 RESET... **ILLINOIS** Type
 The customer may pay up to the food-stampable amount in food stamps, and the amount actually paid in food stamps is tax-exempted. (The FOOD STAMPABLE TOTAL read in the display does not include its taxes due.)
 Bit 4 RESET and Bit 5 SET... **TEXAS** Type
 The customer may pay up to the food-stampable amount in food stamps, but any taxes due must be paid in cash. (The FOOD STAMPABLE TOTAL read in the display does not include its taxes due.)
 Bit 4 and Bit 5 both SET ... **NEW JERSEY** Type
 The customer may pay up to the food-stampable amount in food stamps, and its taxes due are all exempted regardless of the actual amount paid in food stamps. (The FOOD STAMPABLE TOTAL read in the display does not include its taxes due.)
- Bit 6: RESET status (IPD = Item Print Detail)
 ... Printing all the detail data on the journal roll just as on the receipt.
 SET status (INPD) = Item Not Print Detail
 ... Printing only negative (credit) items, transaction total, and media of payment, but not ordinary department or PLU items.
- Bit 7 & Bit 8:
 Both RESET ... Year-Month-Day order
 Both SET ... Bit 7 status prevails, i.e., Day-Month-Year order.

23. Program Data Verification

Whenever programming operations are performed, it is recommended to issue Program Verification receipts to check the programmed data before entering any other operation.

Operating Procedure

Condition: Any time outside a sale

Programming Procedure:

Use the **MGR** or **MA Key** to turn the Control Lock to "X".

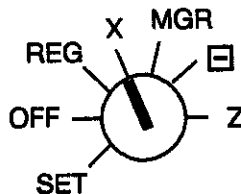

"R OFF" Lamp

Illuminated:
Verification data is printed on journal only.

Extinguished:
Verification data is printed on both journal and receipt.

Reverse the status, if necessary, by depressing

LOG RECEIPT

The **[RECEIPT ISSUE]** key is not effective in X mode.

		<u>Contents to be Printed for Verification</u>	<u>Format Page</u>
1	ST	Department Preset Price Read: Preset Price of each Department	121
2	ST	Department LC and Status Read: LC (Listing Capacity) and Status of each Department	121
3	ST	PLU Table Read: Preset Price, Whole Package Quantity & Price, and Link Department of each PLU	122
4	ST	Other Programmed Data Read: Foreign Currency Exchange Rates, GST Rate, Non-taxable Amount Limit for CANADA Tax, % + & % - Preset Rates	122
5	ST	System Option Read 1: System Option Setting, Addresses 1 to 11	123
9	ST	System Option Read 2: System Option Setting, Addresses 1 to 16	123

Department Preset Price Read

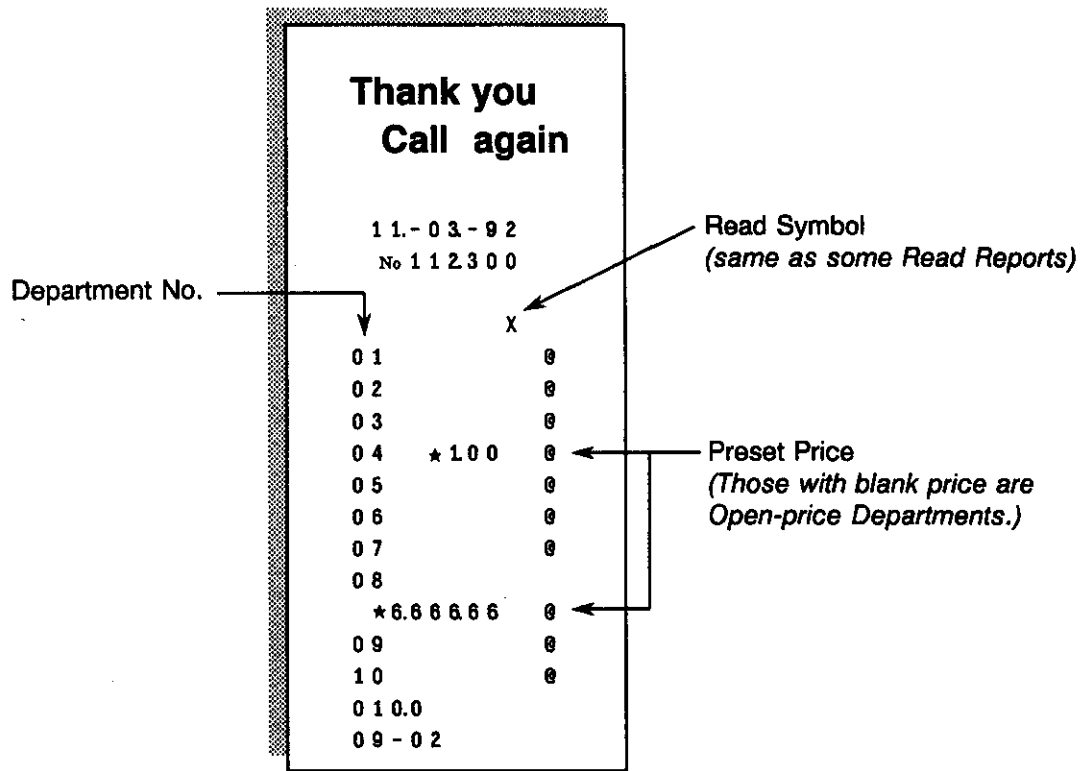

Department LC and Status Read

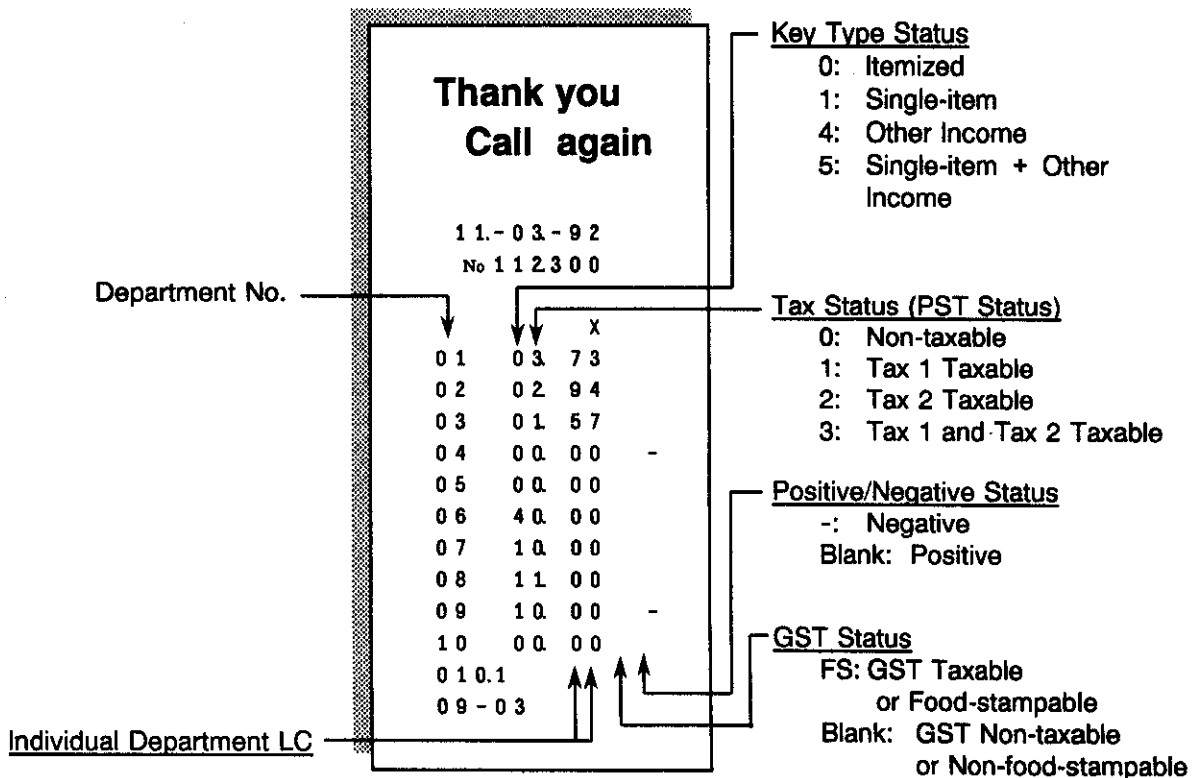

PLU Table Read

**Thank you
Call again**

11.-03.-92
No 112300

X

PL0 0.5 04

*1.00 0

PL0 1.1 01

*12345 0

PL3 0.0 05

*0.50 0

PL5 0.0 03

0

PL5 0.1 01

3

*10.00 0

PL5 0.2 02

10

0

PL9 9.9 03

*10.00 0

010.2

09-04

PLU Code →

Link Department No. →

Preset Price (Blank Price means that it is an Open-price PLU.) →

Whole Package Quantity →

Whole Package Price (preset) →

Whole Package Quantity →

Whole Package Price is open →

SPP PLUs {

Other Programmed Data Read

**Thank you
Call again**

11.-03.-92
No 112300

X

86

10. %+

10. %-

7. FS

1 *

0.

714.3

2 *

0.

5

*20.00 TX

010.3

09-05

Common LC for All Departments →

%+ Preset Rate →

%- Preset Rate →

GST Rate (if GST Feature is selected) →

Foreign Currency 1: →

Integer Digits of Exchange Rate →

Decimal Digits of Exchange Rate →

Foreign Currency 2: →

Integer Digits of Exchange Rate →

Decimal Digits of Exchange Rate →

Non-taxable Amount Limit (Canada Tax) →

Foreign Currencies 3 and 4 Rates are printed also if the keys are opened. →

System Option Read 1

System Option Read 2

**Thank you
Call again**

11-03-92
No 112300

	X
01	
	256
02	
	0
03	
	0
04	
	0
05	
	0
06	
	0
07	
	123
08	
	1
09	
	12
10	
	124
11	
	0
010.6	
09-07	

Address
No.

**Thank you
Call again**

11-03-92
No 112300

	X
01	
	256
02	
	0
03	
	0
04	
	0
05	
	0
06	
	0
07	
	123
08	
	1
09	
	12
10	
	124
11	
	0
12	
	0
13	
	2
14	
	45
15	
	4
16	
	128
010.6	
09-08	

SET Bit Nos.

NOTE: The above samples show the Initial SET Bit Nos of each Address.

24. Paper Roll Replacement and Other Maintenance

Replacing the Receipt Roll

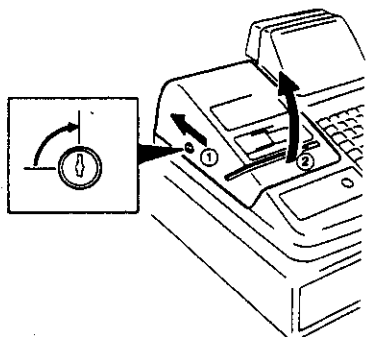

To remove the Printer Cover, insert the Printer Cover Key to the Printer Cover Lock, and turn it 90° clockwise. Then lift the Printer Cover in the direction of the arrow mark ② while pushing the Printer Cover in the direction of the arrow mark ①.

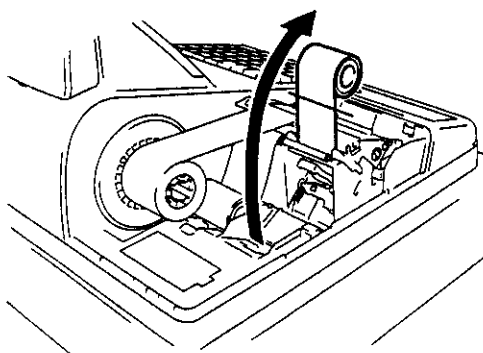

Cut the Receipt Paper as shown in the figure.

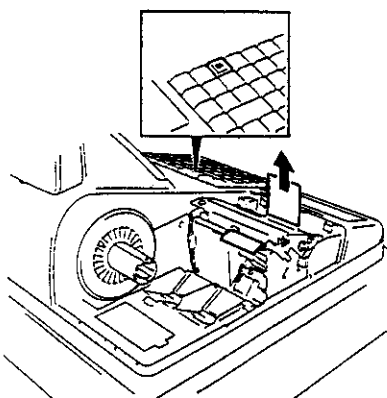

Depress the [RF] key to feed the remaining paper end.

CAUTION: *Never try to pull out the remaining paper end by hand. It may cause the paper jam.*

Load new roll paper as described in Chapter 10.



Replacing the Journal Roll

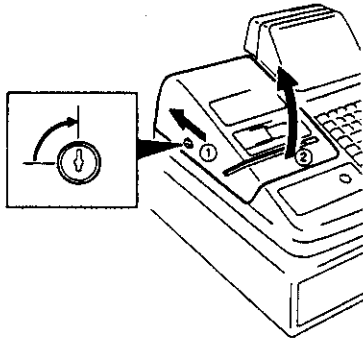

To remove the Printer Cover, insert the Printer Cover Key to the Printer Cover Lock, and turn it 90° clockwise. Then lift the Printer Cover in the direction of the arrow mark ② while pushing the Printer Cover in the direction of the arrow mark ①.

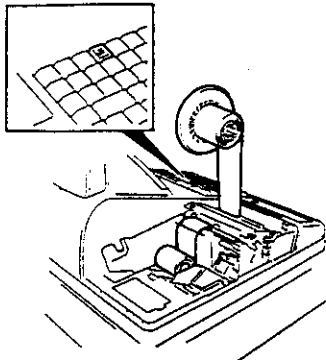

Depress the [JF] key to wind up enough of the Journal Paper, then cut the paper as shown in the figure. Depress the [JF] key to feed the remaining paper end.

CAUTION: *Never try to pull out the remaining paper end by hand. It may cause the paper jam.*

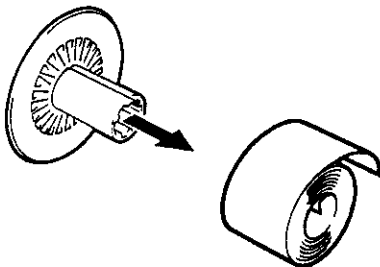

The wound-up portion of the paper can be easily removed from the Reel by pulling it side ways.

Load new roll paper as described in Chapter 10.



Replacing the Ink Roll

①

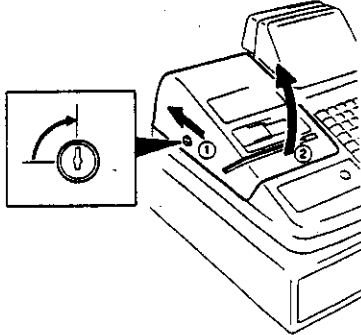

To remove the Printer Cover, insert the Printer Cover Key to the Printer Cover Lock, and turn it 90° clockwise. Then lift the Printer Cover in the direction of the arrow mark ② while pushing the Printer Cover in the direction of the arrow mark ①.

②

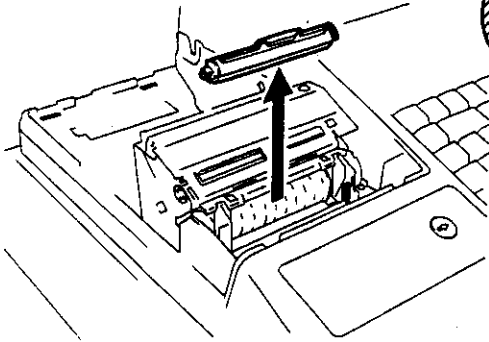

Remove the old Ink Roller by pulling it in the direction of the arrow mark.

③

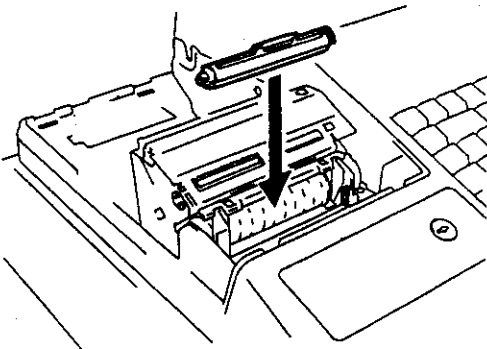

Install a new one by inserting it in the direction of the arrow mark.

④



Attach the Paper Cover.

Replenishing Ink to the Store Name Stamp

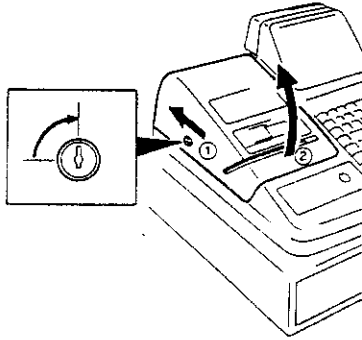

To remove the Printer Cover, insert the Printer Cover Key to the Printer Cover Lock, and turn it 90° clockwise. Then lift the Printer Cover in the direction of the arrow mark ② while pushing the Printer Cover in the direction of the arrow mark ①.

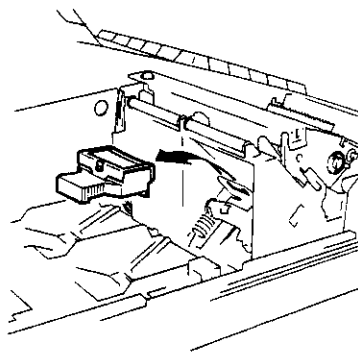

Remove the Store Name Stamp by pulling it in the direction of the arrow mark.

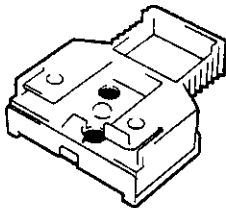

Apply only two or three drops. Stamp may not print dark immediately. Allow time for ink to saturate the stamp.

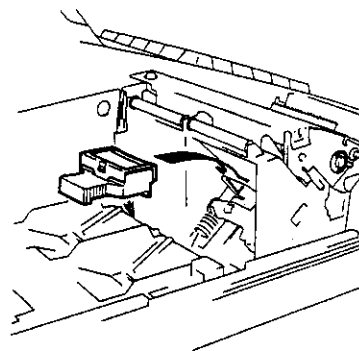

Install the stamp by inserting it in the direction of the arrow mark.



Attach the Printer Cover.

Manual Drawer Release and Lock

The drawer opens automatically when a registration is performed. In the event of a power failure or other trouble, the drawer can be opened manually in the following manner.

Releasing



Remove the Drawer Key Cap.

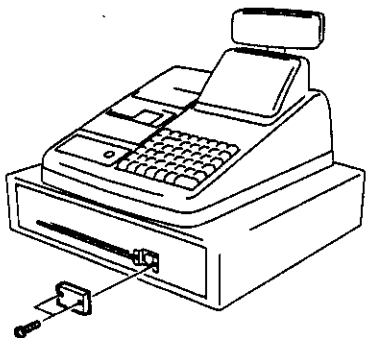

Insert the Drawer Release Key into the Drawer Release Lock, then turn the key clockwise. The drawer will now open.

The Drawer Release Key can be taken out by returning it to the original position.

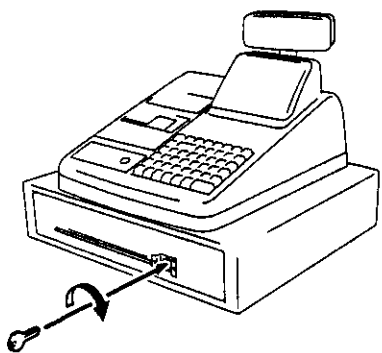

Locking

When the drawer is closed, it is automatically locked and will not open without the Drawer Release Key or transaction entries.

Removing the Drawer

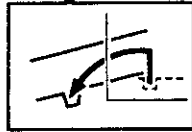
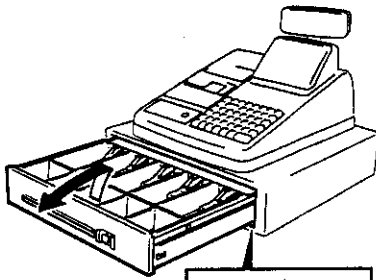

Pull the drawer out, and when it stops by the stopper, lift the drawer up and pull it again.

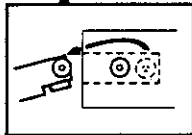
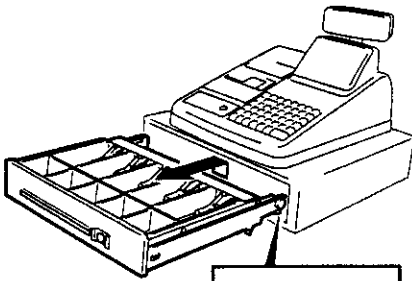

When it stops again by the roller fixed in the drawer case, lift it and pull it again.

25. Troubleshooting

This section describes actions against operation problems.

When an error occurs ; The error tone beeps and the triangular lamp "ALM" illuminates.

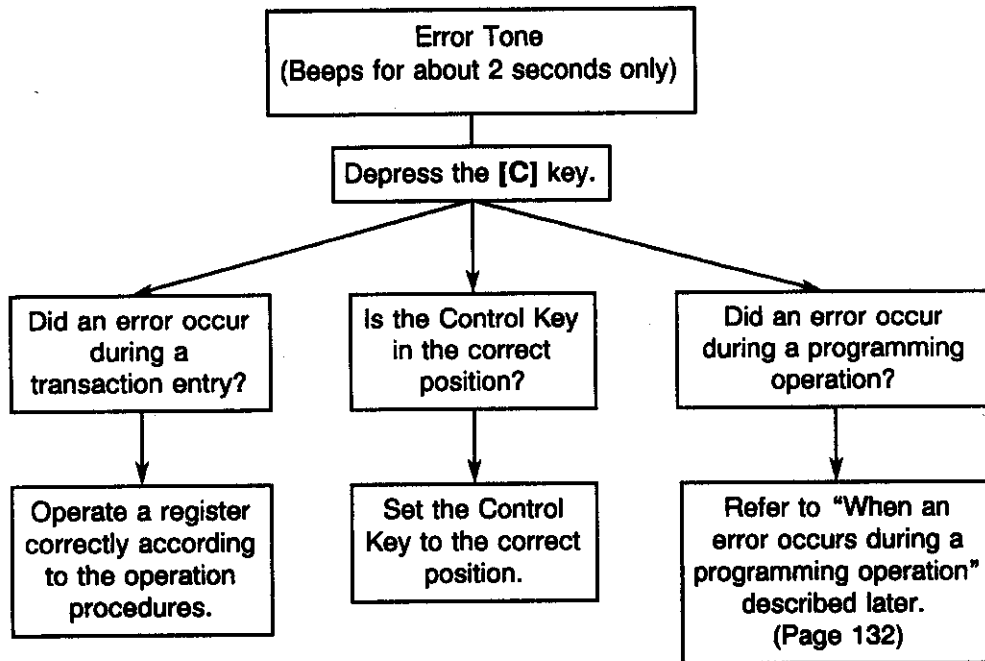

When an transaction entry cannot execute in the "REG", "MGR", or "E" mode;

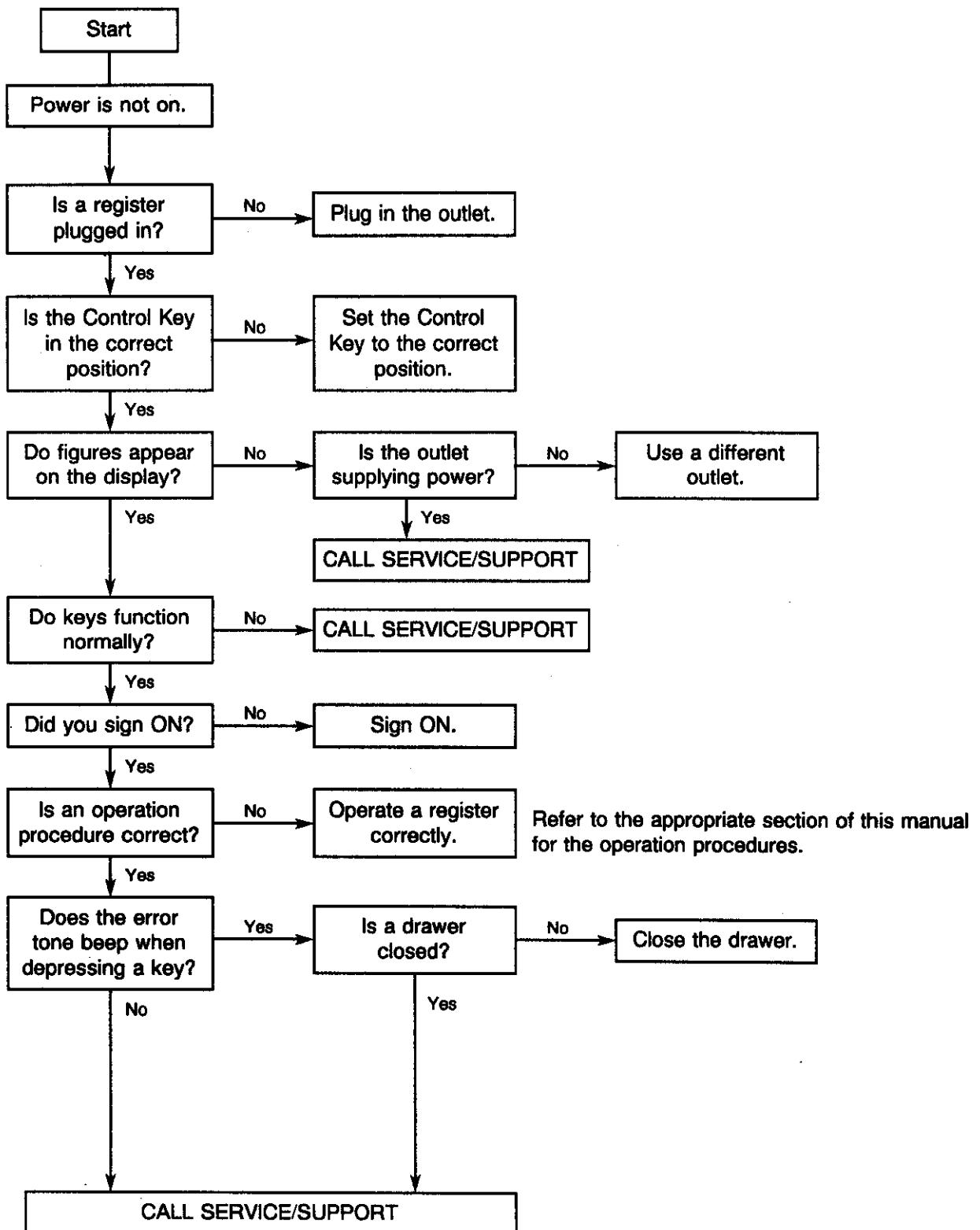

When an error occurs during a programming operation;

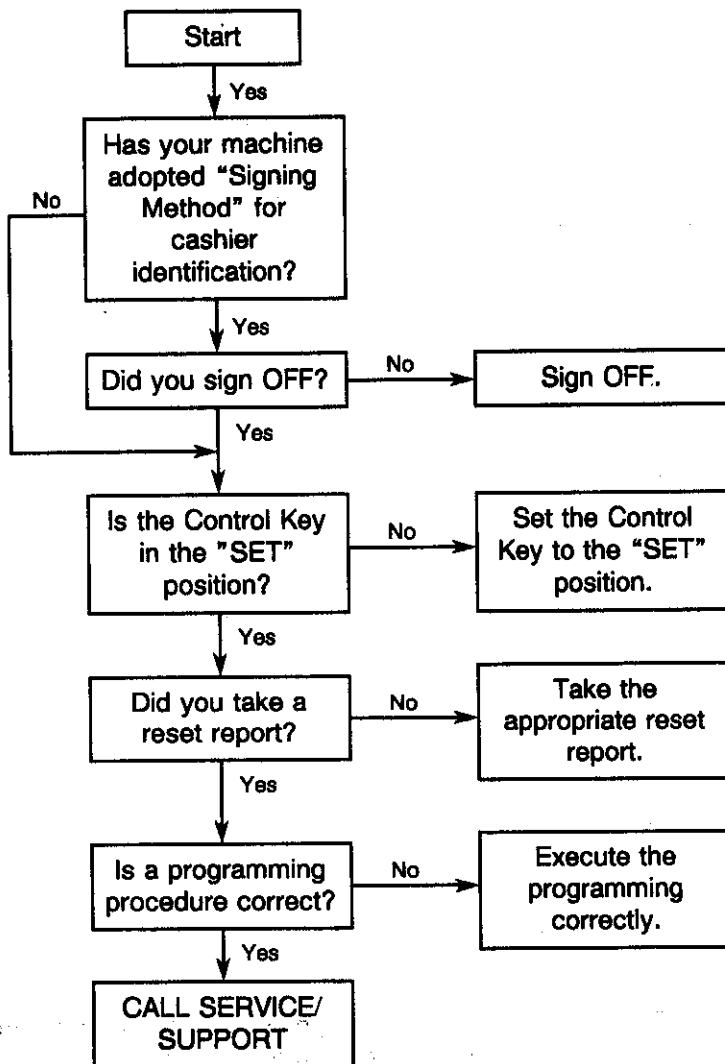

When printing condition is abnormal;

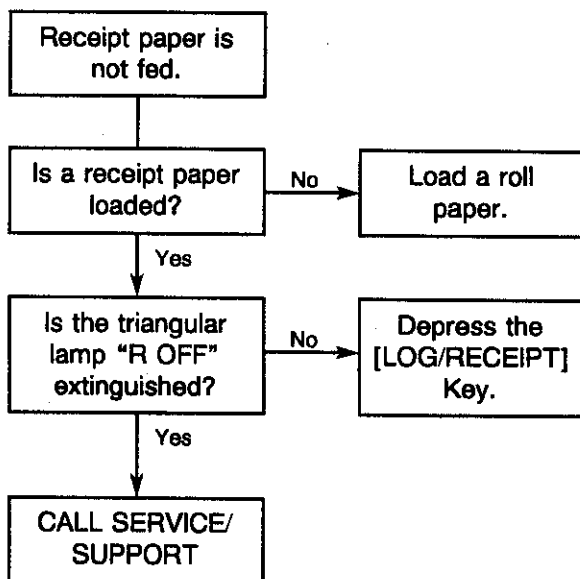
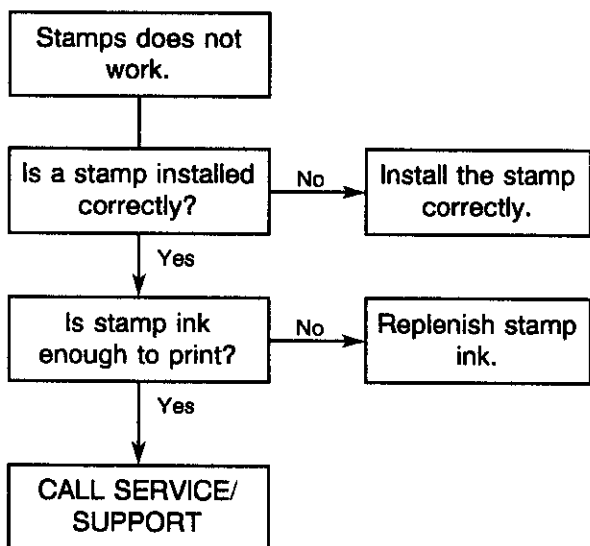
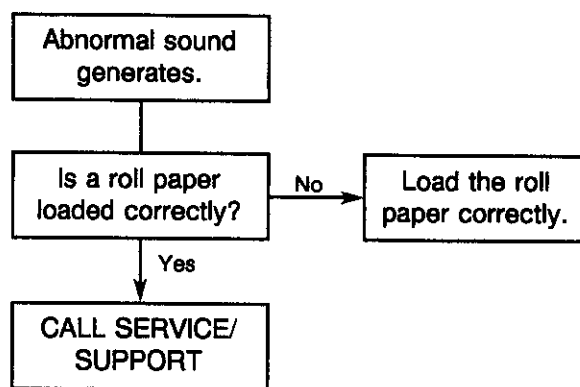
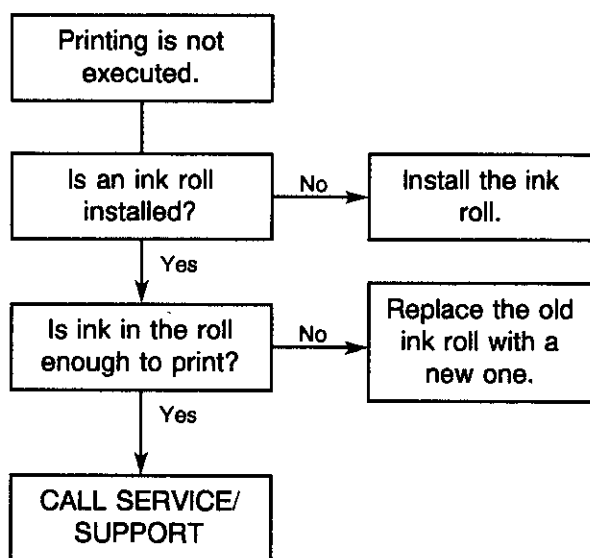

26. Status Clear and Memory Clear Operations

The operations described in this chapter are provided for initial start-up of the machine or emergency but not to be operated as part of daily routines. Do not perform any of these operations unless it is really necessary.

Status Clear

The operation defined as "Status Clear" will only clear an error or key-locked condition that disables normal operations (though it seldom happens). Thus neither the sales data nor the programmed data will be cleared by a Status Clear (except that when a Status Clear is operated to clear a key-locked condition during a sale, the sale item data already entered for the current sale will only be cleared).

The Status Clear also has the function to obtain the condition "after all sales data resets" (as if all sales data had been reset) but will not actually affect any sales data. Such a condition is required in some programming operations and is usually obtained by taking the required reset reports. However, when you do not want the sales data to be reset because it is still in the business hours, etc., this function of the Status Clear will be effective. But be careful in using the function; depending on the programming item, sales data resets may really be necessary instead of a Status Clear, to keep consistency between the programmed data and the sales data.

Operating Procedure

Condition: Any time, outside or during any operation sequence

Operation:

Remove the plug of the register's power cord from the wall outlet (to turn OFF the power).

Use the **S** Key to turn the Control Lock to "BLIND".

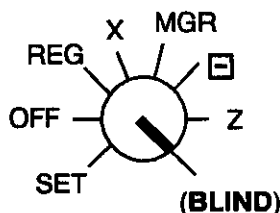

Plug in the cord (to turn ON the power).

A Status Clear receipt is issued.

Status Clear Symbol Line
Date, Register No., Consecutive No., and Time are not reset.

Thank you Call again	
1 1 - 0 3 - 9 2	
No 1 1 2 3 0 0	
0 0	* 0.0 0
0 2 7.1	
1 3 - 0 4	

Zero-amount Display & Print Format
(may vary depending on the designation in the last "Sales Memory Clear" or "All Memory Clear" (refer to the following pages.) Initial Format: 0.00

Sales Memory Clear

The operation defined as "Sales Memory Clear" will only clear the sales data accumulated in the register's memory (report memory). The programmed data will not be cleared. By operating a Sales Memory Clear, all the sales data including non-resettable totals and counters, Reset Report Counts, Receipt Consecutive No. are cleared.

Warning : This clear operation deletes all sales data stored in the register's memory.

Operating Procedure

Condition: Any time, outside or during any operation sequence except during Key Setting or Key Location Changing (Chapter 15) or System Option Setting (Chapter 22).

Operation:

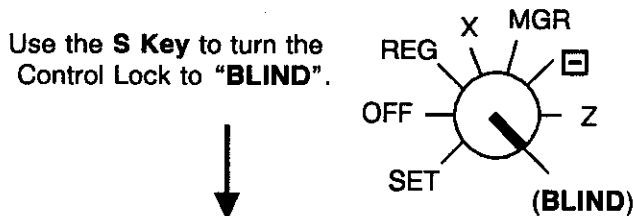

Depress the following Numeric Key according to the display and print format for zero amount:

Numeric Key	Zero-amount Format
3	0 . 0 0
1	. 0

— for use in US or Canada

Depress the **AT/TL** key.

A Sales Memory Clear receipt is issued.

Sales Memory Clear Symbol Line
(03 for Numeric 3, or 01 for Numeric 1)

Receipt Consecutive No. is reset to 0001.

(Date, Register No., and Time remain unreset.)

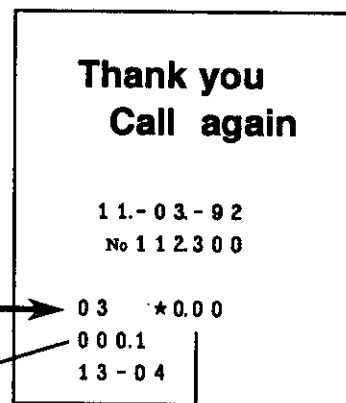

Zero-amount Display & Print Format designated here.

NOTE: When a Sales Memory Clear is operated, the condition "after all sales data reset" is obtained, just as "Status Clear" or "All Memory Clear". Therefore, no Reset Reports need to be taken for starting any programming operation.

All Memory Clear

If the register becomes completely inoperative due to battery discharge or malfunction of the program memory, the All Memory Clear operation must be carried out. When an All Memory Clear is operated, all the memory contents that have been stored in the RAM will be cleared (i.e., the programmed data and the sales data). Along with the clearing process, the designated zero-amount format is set and "Initial Data" and "Initial Status" for respective programming items are automatically set.

Warning : This clear operation deletes all programmed data and sales data stored in the register's memory. (i.e., a register goes back to initial status.)

Operating Procedure

Condition: Any time, outside or during any operation sequence except during Key Setting or Key Location Changing (Chapter 15) or System Option Setting (Chapter 22).

Operation:

Use the **S** Key to turn the Control Lock to "BLIND".

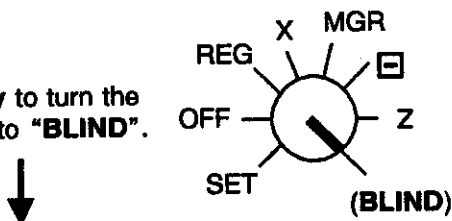

Depress the following Numeric Key according to the display and print format for zero amount:

Numeric Key	Zero-amount Format
3 9	0 0 0 .
1 9	. 0

— for use in US or Canada

Depress the **AT/TL** key.

An All Memory Clear receipt is issued.

All Memory Clear Symbol Line
(39 for Numeric 39, or 19 for Numeric 19)

Receipt Consecutive No. is reset to 0001.

(Date and Time remain unreset.)

Zero-amount Display & Print Format designated here.

Register No. is reset to zero. But No. 0 is printed from the next receipt on.

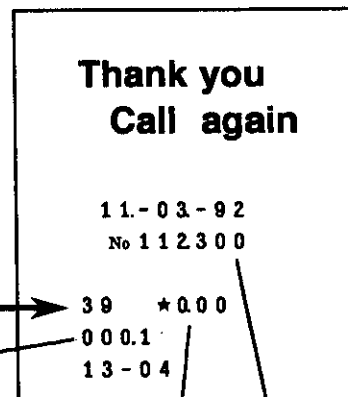

NOTES 1. When a All Memory Clear is operated, the condition "after all sales data reset" is obtained, just as "Status Clear" or "Sales Memory Clear". Therefore, no Reset Reports need to be taken for starting any programming operation.

27. Specifications

Size	...	460mm (width) × 400mm (depth) × 308mm (height including rubber feet) (or 376mm (height) when Customer's Display is popped up.)
Weight	...	12.5kg
Power Required	...	AC 117V; 60Hz
Power Consumed	...	0.32A
Ambient Temperature	...	0°C to 40°C
Relative Humidity	...	10% to 90% RH
Size of Receipt and Journal Rolls	...	45mm(width) x 80mm(diameter)

Amount and Counter Totals In Report Memory

Report	Daily				Periodical Report Memory
	Amount (digits)	Item Count (digits)	Operation Count (digits)	Customer Count (digits)	
<u>Financial Report Items</u>					Provided (except media-in-drawer totals)
Grand Total (non-resettable)	16				
Other Items <i>NOTE</i>	9	5 (+ 2 decimal)	5	5	
Reset Counter			4		

Department	9	5 (+ 2 decimal)		5	Provided
PLU	9	5 (+ 2 decimal)			
Reset Counter			4		
<u>Cashier</u>					Provided
Gross Sale	9	5 (+ 2 decimal)		5	
Other Income Total	9	5 (+ 2 decimal)			
Reset Counter			4		
Hourly Range Sale	9			5	
Reset Counter			4		

NOTE: Some items have an Amount and a Counter, some have an Amount only, others have a Counter only. The counter type varies depending on the item.

Memory Protection

Long-lasting rechargeable lithium battery for memory protection.

Specifications are subject to change without notice.

STAMP ORDER

Dear Customer;

A Receipt Stamp (Electro-stamp) "Thank you Call again" comes with each unit. If you prefer printing your company name or message to "Thank you Call again" for receipt inprint, please place order with using the order form below.

Please complete the order form and mail with your check for \$25.00 US Dollar.

Replenishment ink is also available \$1.50 US Dollar for purple ink.

----- CUT OFF ----- CUT OFF ----- CUT OFF -----

TEC STAMP ORDER FORM			DATE _____																
ORDER TO:	carda International P.O. Box 2539 San Antonio, Texas 78299 (512) 224-8400 (210) 226-8313 (Fax No.) 1-800-255-9217 (Toll Free)																		
SOLD TO:	COMPANY NAME _____																		
	ADDRESS _____																		
	CITY _____ COUNTRY _____																		
	YOUR NAME _____																		
	PHONE _____ ZIP CODE _____																		
Please show the text of your stamp here (word only). <div style="border: 1px dashed black; height: 100px; width: 100%;"></div>	TEC MODEL: MA-315																		
	<table border="1" style="width: 100%; border-collapse: collapse;"> <thead> <tr> <th style="text-align: center;">Description</th> <th style="text-align: center;">UNIT PRICE</th> <th style="text-align: center;">Q'TY</th> <th style="text-align: center;">AMOUNT</th> </tr> </thead> <tbody> <tr> <td style="text-align: center;">STAMP</td> <td style="text-align: center;">\$25.00</td> <td></td> <td></td> </tr> <tr> <td style="text-align: center;">Replenishment Ink</td> <td style="text-align: center;">\$1.50</td> <td></td> <td></td> </tr> <tr> <td colspan="3" style="text-align: right;">TOTAL</td> <td></td> </tr> </tbody> </table>	Description	UNIT PRICE	Q'TY	AMOUNT	STAMP	\$25.00			Replenishment Ink	\$1.50			TOTAL					
Description	UNIT PRICE	Q'TY	AMOUNT																
STAMP	\$25.00																		
Replenishment Ink	\$1.50																		
TOTAL																			
Please mail your check with order form. More detail, please contact to Carda International.																			

- NOTES:**
1. If order two or more design stamps, please make copies of this form.
 2. Carda International is an independent company and is not affiliated with TEC.
 3. Carda International also accepts a custom logo with an extra cost.



TEC

TOKYO ELECTRIC CO., LTD.

E EO1-11069 93032000 ©

Free Manuals Download Website

<http://myh66.com>

<http://usermanuals.us>

<http://www.somanuals.com>

<http://www.4manuals.cc>

<http://www.manual-lib.com>

<http://www.404manual.com>

<http://www.luxmanual.com>

<http://aubethermostatmanual.com>

Golf course search by state

<http://golfingnear.com>

Email search by domain

<http://emailbydomain.com>

Auto manuals search

<http://auto.somanuals.com>

TV manuals search

<http://tv.somanuals.com>