

# TOSHIBA

# OWNER'S MANUAL

## Color Television

COLORSTREAM® **WOW**™  
by SRS (S)®

# 32HFX71

# 36HFX71

### Owner's Record

The model number and serial number are on the back of your TV. Record these numbers in the spaces below. Refer to these numbers whenever you communicate with your Toshiba dealer about this TV.

Model number:

Serial number:

Introduction

Connecting  
your TV

Using the  
Remote Control

Setting up  
your TV

Using the TV's  
Features

Appendix

Index

# Important Information

**WARNING**

**TO REDUCE THE RISK OF FIRE OR ELECTRIC SHOCK,  
DO NOT EXPOSE THIS APPLIANCE TO RAIN OR  
MOISTURE.**

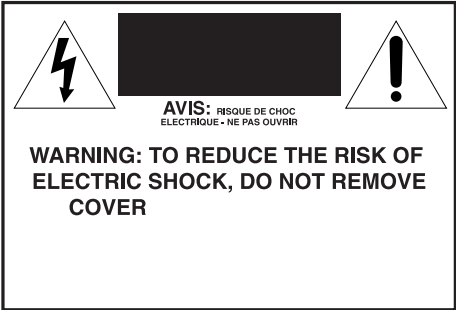

<b>Introduction</b> .....	<b>4</b>	Using the multi-window feature .....	33
Welcome to Toshiba .....	4	Using the favorite function .....	33
Exploring your new TV .....	4	Using the strobe function .....	33
<b>Connecting your TV</b> .....	<b>5</b>	Using the LOCKS menu .....	34
Connecting a VCR .....	5	Entering the PIN code .....	34
Connecting a cable converter box .....	6	Using the V-CHIP menu .....	35
Connecting a cable converter box and VCR .....	6	ENABLE BLOCKING .....	35
Connecting a DVD player or satellite receiver and a VCR .....	7	TV RATING (Independent rating system for broadcasters) .....	35
Connecting a DVD player with component video and a VCR .....	8	MPAA RATING (Independent rating system for movies) .....	36
Connecting a DTV receiver/set-top box with component video and a VCR .....	9	BLOCKING OPTION .....	36
Connecting two VCRs .....	10	Unlocking programs temporarily .....	37
Connecting a camcorder .....	10	Locking channels .....	37
Connecting an audio system .....	11	Locking video inputs .....	38
Connecting an A/V receiver .....	11	Using the front panel lock feature .....	39
<b>Using the remote control</b> .....	<b>12</b>	Changing the PIN code .....	39
Preparing the remote control for use .....	12	Adjusting the picture .....	40
Installing the remote control batteries .....	12	Selecting the picture mode .....	40
Remote Control functional key chart .....	13	Adjusting the picture quality .....	40
Programming the remote control for use with your audio/video devices .....	15	Saving new preference .....	41
Device code setup .....	15	Using the flesh tone feature .....	41
Searching and sampling the code of a device (991) ....	15	Using the Digital Noise Reduction (DNR) feature ...	41
Verifying the device code (990) .....	16	Selecting the cinema mode .....	42
Using the volume lock feature (993) .....	16	Selecting the color temperature .....	42
Operational feature reset (980) .....	16	Resetting picture adjustments .....	42
Device code table .....	17-20	Selecting the video input source .....	43
Learning about the remote control .....	21	Labeling the video input sources .....	43
<b>Setting up your TV</b> .....	<b>22</b>	Using the closed caption feature .....	44
Learning about the menu system .....	22	Setting the sleep timer .....	45
Changing the on-screen display language .....	23	Setting the clock .....	45
Selecting the antenna input .....	23	Adjusting the sound .....	46
Adding channels to the TV's memory .....	24	Muting the sound .....	46
Programming channels automatically .....	24	Selecting stereo/SAP broadcasts .....	46
Adding and erasing channels manually .....	25	Using the WOW™ surround sound feature .....	47
Adjusting the tilt correction feature .....	25	Adjusting the sound quality .....	47
Changing channels .....	26	Resetting audio adjustments .....	48
<b>Using the TV's features</b> .....	<b>27</b>	Using the sub-woofer system "CYCLONE™" .....	48
Adjusting the channel settings .....	27	Turning off the built-in speakers .....	49
Switching between two channels .....	27	Selecting the Audio OUT sound .....	49
Programming your favorite channels .....	27	Using the StableSound™ feature .....	50
Labeling channels .....	28	Selecting the background of the menu display .....	50
Viewing the wide-screen picture formats .....	30	Displaying on-screen information .....	50
Selecting the image shape .....	30	Viewing the demonstration mode .....	51
Watching PIP/double-window .....	31	Understanding the auto power off feature .....	51
Switching the main and sub-pictures .....	32	Understanding the last mode memory feature .....	51
Changing the position of the small picture .....	32	<b>Appendix</b> .....	<b>52</b>
Freezing the sub-picture .....	32	Specifications .....	52
		Troubleshooting .....	53
		Limited United States Warranty .....	54
		<b>Index</b> .....	<b>55</b>

## Introduction

### Welcome to Toshiba

Congratulations! You have purchased one of the finest TVs on the market. The goal of this manual is to guide you through setting up and operating your Toshiba TV as quickly as possible.

This manual applies to models 32HFX71 and 36HFX71. Before you start reading, check your model number by looking at the rear of the TV.

Instructions in this manual are based on using the remote control. You can also use the controls on the TV if they have the same name as those on the remote control.

Please read all the safety and operating instructions carefully, and keep the manual for future reference.

### Exploring your new TV

You can operate your TV by using the buttons on the front panel or the remote control. The back panel and front panel (behind the door) provide all the terminal connections you will need to connect other equipment to your TV. See "Connecting your TV" on page 5.

### Please Note

On some models, the SET UP menu automatically appears on-screen the first time the TV is turned on.

To change the menu settings, see "Setting Up Your TV" on page 22 for details.

To close the menu, either press EXIT or turn the TV off.

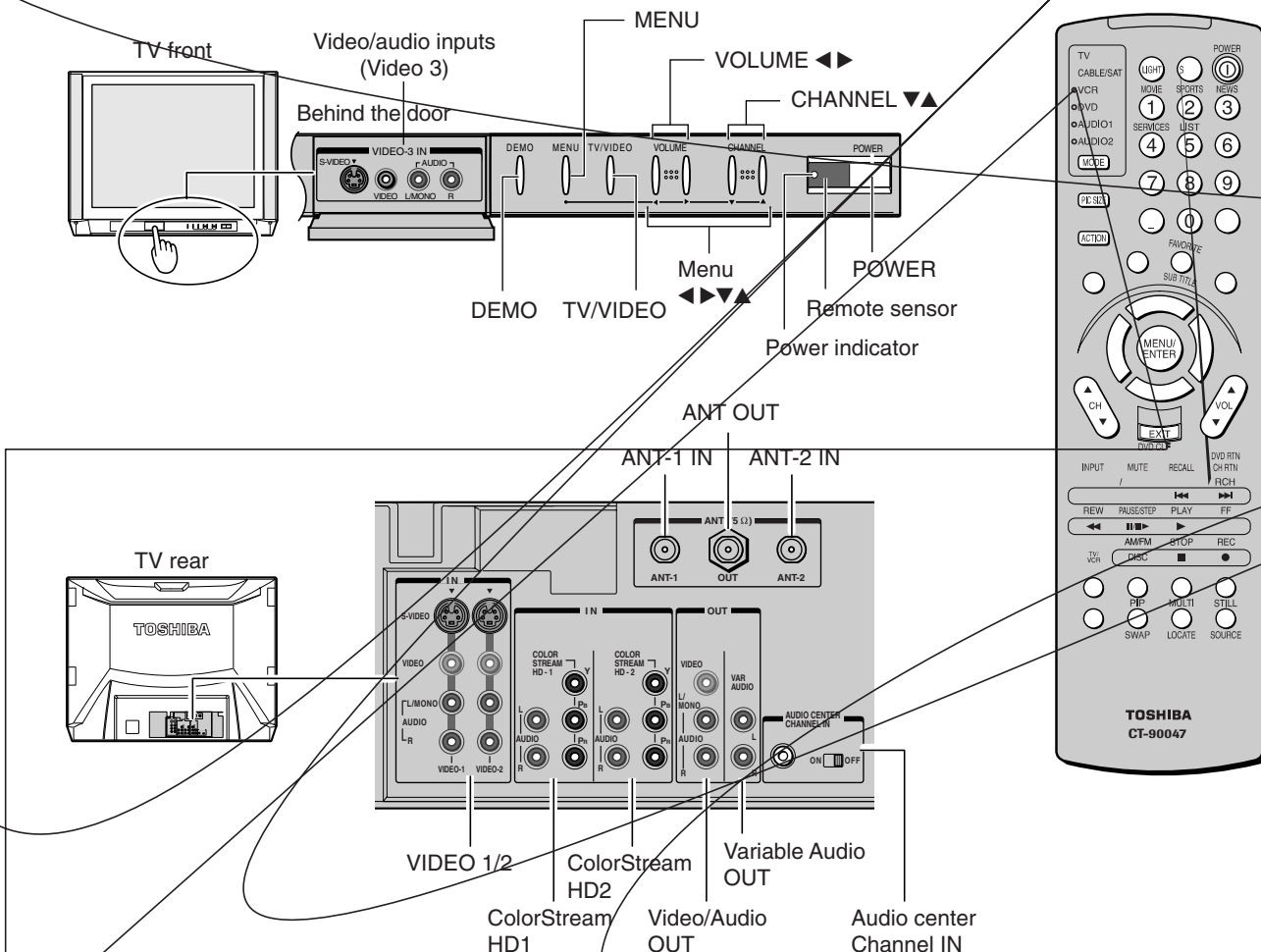

## Connecting your TV

If you have not connected electronic equipment before, or you have been frustrated in the past, you may wish to read this section. (Cables are not supplied.)

- A coaxial cable is the standard cable that comes in from your antenna or cable converter box. Coaxial cables use “F” connectors.
- Audio and video cables are usually color-coded according to use: yellow for video and red and white for audio. The red audio cable is for the stereo right channel, and the white audio cable is for the stereo (or mono) left channel. If you look at the rear panel of the TV, you will see that the terminals are color-coded in the same manner as the cables.
- S-video cables provide better picture performance. S-video cables can only be used with S-video compatible components.
- ColorStream® cables come in sets of three and provide the best picture performance. ColorStream cables can only be used with ColorStream compatible components.

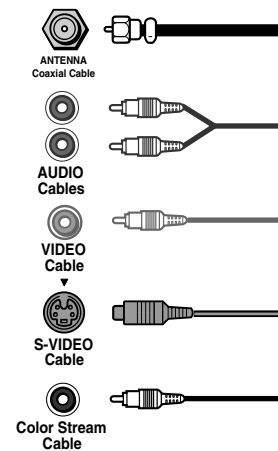

### Caution:

Do not plug the TV in until you have finished connecting all of your equipment.

## Connecting a VCR

This connection allows you to watch local channels and video programs, play or record on the VCR while watching TV, and record from one channel while watching another channel.

You will need:

- one coaxial cable
- one pair of audio cables (one single audio cable for a mono VCR)
- one video cable (one S-video cable for an S-VHS VCR)

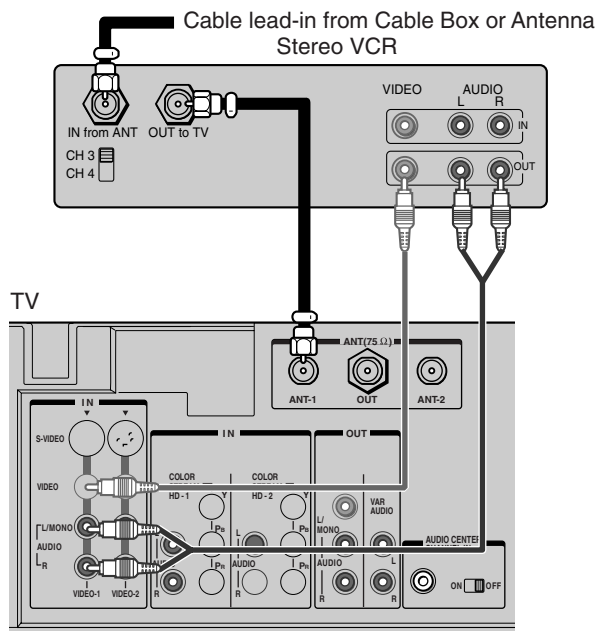

### Note:

If you have a mono VCR, connect L/Mono to VCR Audio OUT using only one audio cable.

If you have an S-VHS VCR, use an S-video cable (in the S-video jacks) instead of the regular video cable.

Do not connect a regular video cable and an S-video cable to Video-1 (or Video-2) at the same time.

## Connecting a cable converter box

This connection allows you to watch basic and premium cable channels.

To use the TV's features, select ANT-1. To view premium channels, select ANT-2, tune the TV to channel 3 or 4 (whichever channel is vacant in your area), and use the converter box to change channels.

You will need:

- two coaxial cables

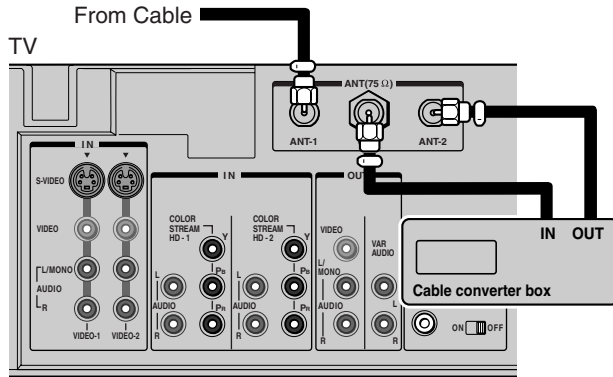

**Note:**

*When you use a converter box with your TV, the remote control will not operate some features, such as programming your favorite channels, labeling channels, and locking channels.*

## Connecting a cable converter box and VCR

This connection allows you to watch and record basic and premium cable channels, watch videotapes, and record one channel while watching another channel. To use the TV's features, select ANT-1. To view premium channels or record with the VCR, select ANT-2, tune the TV to channel 3 or 4 (whichever channel is vacant in your area), and use the converter box to change channels.

You will need:

- three coaxial cables
- one pair of audio cables (one single audio cable for a mono VCR)
- one video cable (one S-video cable for an S-VHS VCR)

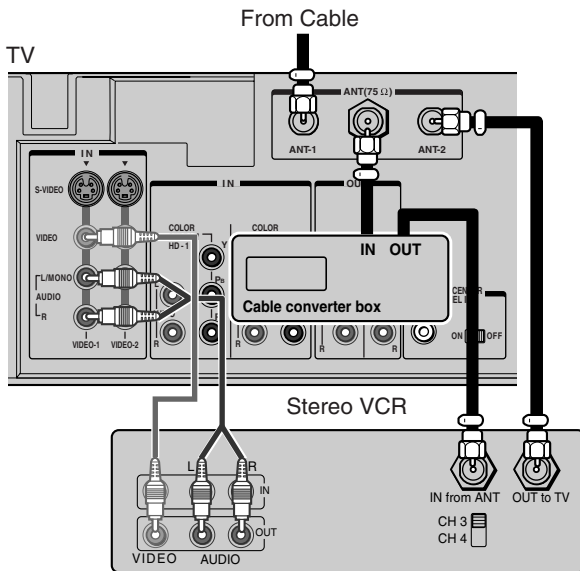

**Note:**

*If you have a mono VCR, connect L/Mono to VCR Audio OUT using only one audio cable.*

*If you have an S-VHS VCR, use an S-video cable (in the S-video jacks) instead of a regular video cable. Do not connect a regular video cable and an S-video cable to Video-1 (or Video-2) at the same time.*

*When you use a converter box with your TV, the remote control will not operate some features, such as programming your favorite channels, labeling channels, and locking channels.*

# Con an

This  
prog  
chan

You

- d
  - t
  - f
  - d
  - o
  - r
- il cable  
of audio cables (one single and one pair of audio cables  
o VCR)  
cable (between the TV and VCR)  
o cable (between the TV and DVD player/satellite

## ing a DVD player or satellite receiver

on allows you to watch DVD/satellite, VCR, and TV  
record one TV channel while watching another

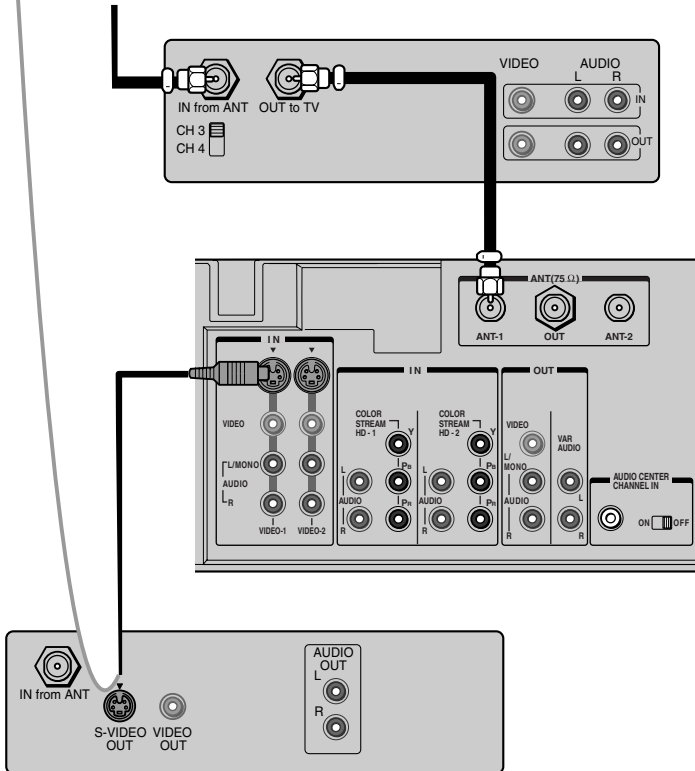

## Connecting a DVD player with component video and a VCR

This connection allows you to watch DVD, VCR, and TV programs, and record DVD and TV programs. You can record from one source while watching a program from another source.

Your TV has ColorStream component video inputs. Connecting your TV to a ColorStream-compatible DVD player (such as a Toshiba ColorStream-equipped DVD player) can greatly enhance picture quality and realism.

You will need:

- one coaxial cable
- three pairs of audio cables (two single and one pair of audio cables for a mono VCR)
- two video cables
- one set of ColorStream video cables (one S-video cable for a non-ColorStream DVD player; see notes at right)





## Connecting a DTV receiver/set-top box with or component video and a VCR

This connection allows you to watch DTV (digital TV broadcast), VCR, and TV programs, and record DTV and TV programs. You can record from one source while watching a program from another source.

Your TV has ColorStream component video inputs. Connecting your TV to a ColorStream-compatible DTV receiver can greatly enhance picture quality and realism.

You will need:

- one coaxial cable
- three pairs of audio cables (two single and one pair of audio cables for a mono VCR)
- two video cables
- one set of ColorStream video cables (one S-video cable for a non-ColorStream DTV receiver; see notes at right)

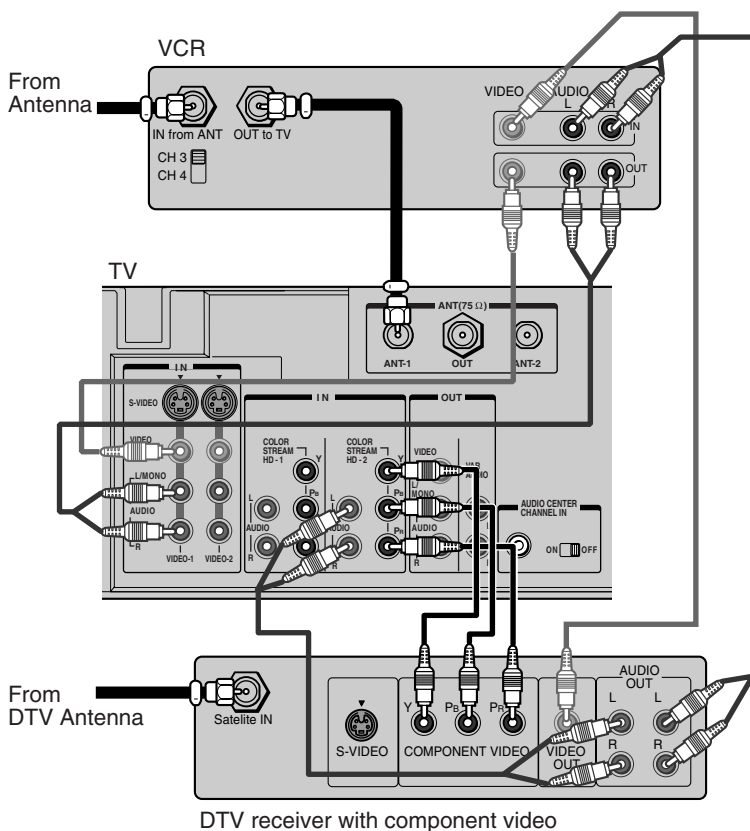

### Note:

For the highest possible picture quality, you must use ColorStream video cables between the TV and DTV receiver. You can connect the ColorStream cables from the DTV receiver to either ColorStream jack on the TV (HD1 or HD2).

The ColorStream HD1 and HD2 jacks can be used with Progressive (480p) and Interlace (480i, 1080i) scan systems.

If your DTV receiver is not ColorStream-compatible, use the S-video connections (both audio and video) instead of the ColorStream connections. Do not connect both S-Video and ColorStream cables between the TV and DTV receiver at the same time.

To record from the DTV receiver, set the VCR to Line IN. To monitor recording from the DTV receiver, set the VCR to Line IN, and set the TV to Video-1.

### Caution:

The unauthorized recording of television programs, videotapes, and other materials may infringe upon the provisions of copyright laws.

## Connecting two VCRs

This connection allows you to record (dub/edit) from one VCR to another VCR while watching a videotape. You can also record from one TV channel while watching another TV channel.

You will need:

- one coaxial cable
- two pairs of audio cables (two single audio cables for mono VCRs)
- two video cables (two S-video cables for S-VHS VCRs)

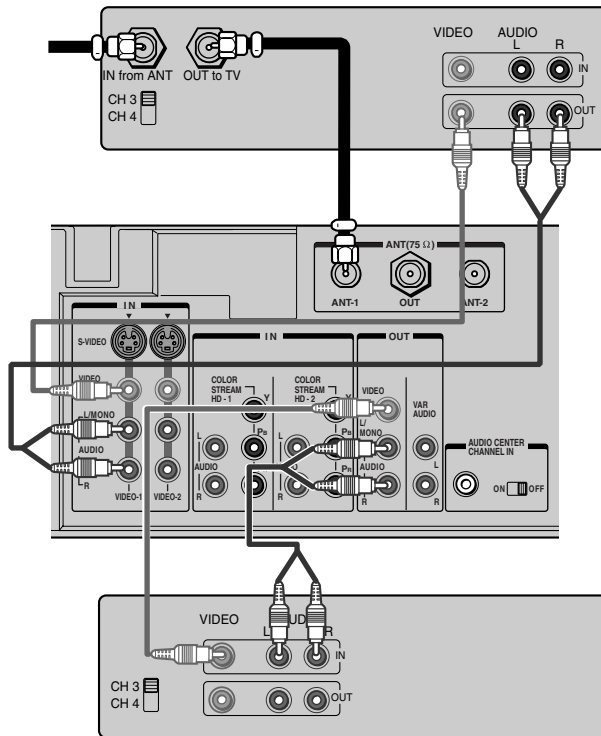

## Connecting a camcorder

This connection allows you to watch video materials recorded on a camcorder.

You will need:

- one pair of audio cables
- one video cable (one S-video cable for an S-VHS camcorder)

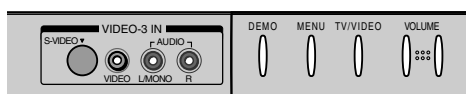
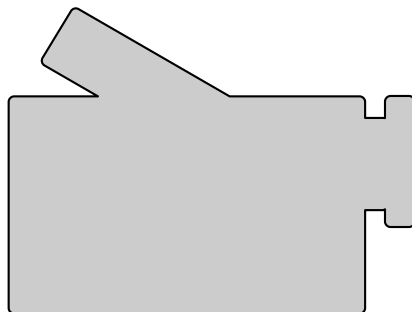

ver to

nd, you can  
al speakers as

channel

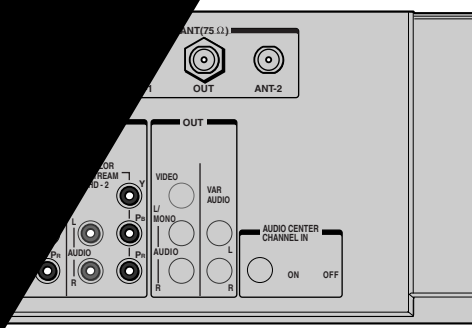

## Using the remote control

### Preparing the remote control for use

Your Toshiba TV remote control has one dedicated TV mode and five universal modes: VCR, Cable/SAT, DVD, Audio1, and Audio2. The target devices and default devices being programmed for each mode are as follows:

Target device/Mode mapping

Mode	Device
TV	Toshiba TV
CABLE/SAT	Universal Cable, Satellite
VCR	Universal VCR, DVD, LD, Cassette
DVD	Universal DVD, VCR, LD, Cassette
AUDIO1	Universal Audio: Amp., Tuner, Misc.Audio, CD/MD
AUDIO2	Universal Audio: CD/MD, Amp., Tuner, Misc.Audio

Default device codes

Mode	Default device
TV	Toshiba TV
CABLE/SAT	Toshiba Satellite receiver
VCR	Toshiba VCR
DVD	Toshiba DVD
AUDIO1	Pioneer Audio receiver
AUDIO2	Pioneer LD

Repeatedly press MODE to cycle among the modes. If you own different brands of audio/video devices, you must first program your remote control (see “Programming the remote control for use with your audio/video devices” on page 15).

### Installing the remote control batteries

To install the batteries:

- Slide the battery cover off the back of the remote control.

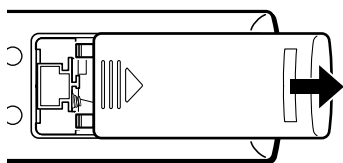

- Install two “AA” size alkaline batteries. Match the + and – signs on the batteries to the signs on the battery compartment.

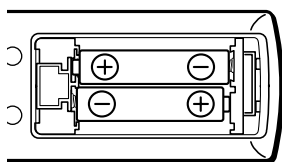

- Slide the battery cover back on to the remote control until the lock snaps.

#### Note:

Your TV's remote control may not operate certain features on your VCR, cable TV converter, or other electronic device.

Refer to the owner's manuals for your other devices to determine their available features. If your TV's remote control does not operate a specific feature on a device, use the remote control that came with the device.

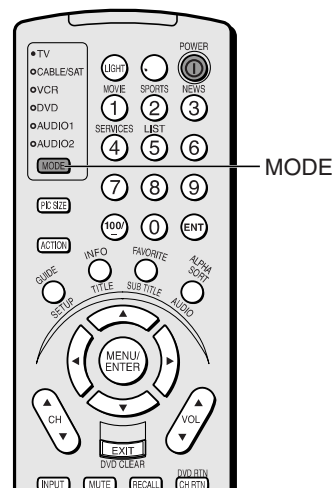

#### Caution:

- Dispose of batteries in a designated disposal area. Do not throw batteries into a fire.
- Do not mix battery types or combine used batteries with new ones.
- If the batteries are dead or if you will not use the remote control for a long time, remove the batteries to prevent battery acid from leaking into the battery compartment.

#### Note:

- Battery life expectancy is about one year with normal use.

## Remote Control functional key chart

Key Label	Toshiba TV (TV)	Cable (CBL/SAT)	Satellite (CBL/SAT)	VCR	DVD/LD	Receiver (AUDIO)	CD/MD (AUDIO)	Cassete (VCR)
LIGHT	Lights the remote key, and toggles between enabled and disabled Illumination mode.							
SLEEP	Sleep timer	---	---	---	---	---	---	---
POWER	Power	Power	Power	Power	Power	Power	Power	Power
1/MOVIE	Digit 1	Digit 1	Digit 1	Digit 1	Digit 1	AV input 1	Digit 1	Digit 1
2/SPORTS	Digit 2	Digit 2	Digit 2	Digit 2	Digit 2	AV input 2	Digit 2	Digit 2
3/NEWS	Digit 3	Digit 3	Digit 3	Digit 3	Digit 3	AV input 3	Digit 3	Digit 3
4/SERVICES	Digit 4	Digit 4	Digit 4	Digit 4	Digit 4	AV input 4	Digit 4	Digit 4
5/LIST	Digit 5	Digit 5	Digit 5	Digit 5	Digit 5	CD	Digit 5	Digit 5
6	Digit 6	Digit 6	Digit 6	Digit 6	Digit 6	Tuner	Digit 6	Digit 6
MODE	Remote control device mode selection							
PIC SIZE	Selects the image shape.	This button is not available for other devices connected to this TV.						
7	Digit 7	Digit 7	Digit 7	Digit 7	Digit 7	Phono	Digit 7	Digit 7
8	Digit 8	Digit 8	Digit 8	Digit 8	Digit 8	Cassette	Digit 8	Digit 8
9	Digit 9	Digit 9	Digit 9	Digit 9	Digit 9	Aux	Digit 9	Digit 9
ACTION	---	Menu	Action, Menu	Menu	Menu	---	---	---
100/-	100	100	100	100	100	100	100	100
0	Digit 0	Digit 0	Digit 0	Digit 0	Digit 0	Digit 0	Digit 0	Digit 0
ENT	---	CH Enter	CH Enter	CH Enter	---	---	---	---
GUIDE/SETUP	---	Guide	Guide	Program	DVD setup	Program	Program	---
INFO/TITLE	---	---	INFO	---	TITLE= Top menu	---	---	---
FAVORITE/ SUBTITLE	Favorite CH	---	Favorite CH	---	Subtitle	---	---	---
ALPHASORT/ AUDIO	---	---	Alphasort	---	Audio	---	---	---
MENU/ ENTER	Menu open/ Enter	Select	Select	Enter	Enter	---	---	---
▲▼	Menu select	Menu select	Menu select	Menu select	Menu select	---	---	---
◀▶/(FAV) ▶▶	Menu select/ (FAV) ▶▶	Menu select	Menu select	Menu select	Menu select	---	---	---
VOL ▲▼	Volume up/down*	Volume up/down*	Volume up/down*	Volume up/down*	Volume up/down*	Volume up/down*	Volume up/down*	---
EXIT/ DVD CLEAR	Exit	Exit	Exit	Exit	DVD clear	Exit/Clear	Exit/Clear	Exit/Clear
CH ▲▼	Channel up/down	Channel up/down	Channel up/down	Channel up/down	---	Channel up/down	---	---
INPUT	TV/Video select	← TV	← TV	VCR input	← TV	Input	← TV	← TV
MUTE	Sound mute*	Sound mute*	Sound mute*	Sound mute*	Sound mute*	Sound mute*	Sound mute*	---
RECALL	On-screen display	On-screen display	On-screen display	On-screen display	On-screen display	---	---	---
CH RTN/ DVD RTN	Previous channel	Previous channel	Previous channel	Previous channel	DVD return	---	---	---
SLOW/ DIR	▶ ---	---	---	Forward ---	Forward Reverse	---	---	---
SKIP/ SEARCH	▶ ---	---	---	---	Forward Reverse	CH forward CH reverse	Forward Reverse	Forward Reverse
REW	VCR →	VCR →	VCR →	Rewind	Rewind	Rewind	Rewind	Rewind
PAUSE/STEP	VCR →	VCR →	VCR →	Pause	Pause	Pause	Pause	Pause
PLAY	VCR →	VCR →	VCR →	Play	Play	Play	Play	Play
FF	VCR →	VCR →	VCR →	F. Forward	F. Forward	F. Forward	F. Forward	F. Forward

Key Label	Toshiba TV (TV)	Cable (CBL/SAT)	Satellite (CBL/SAT)	VCR	DVD/LD	Receiver (AUDIO)	CD/MD (AUDIO)	Cassette (VCR)
TV/VCR	VCR →	Bypass A/B	TV/SAT	TV/VCR	---	---	---	---
AM/FM DISC	---	---	---	---	Disc shift	AM/FM	Disc shift	Deck side A/B switch
STOP	VCR →	VCR →	VCR →	Stop	Stop	Stop	Stop	Stop
REC	VCR →	VCR →	VCR →	Record	---	Record	Record	Record
PIP CH ▲▼	PIP channel up/down	← TV	← TV	← TV	← TV	← TV	← TV	← TV
PIP	PIP on/off	← TV	← TV	← TV	← TV	← TV	← TV	← TV
MULTI	Strobe	← TV	← TV	← TV	← TV	← TV	← TV	← TV
STILL	PIP Still	← TV	← TV	← TV	← TV	← TV	← TV	← TV
SWAP	PIP Swap	← TV	← TV	← TV	← TV	← TV	← TV	← TV
LOCATE	PIP Locate	← TV	← TV	← TV	← TV	← TV	← TV	← TV
SOURCE	PIP Source	← TV	← TV	← TV	← TV	← TV	← TV	← TV

**Notes:**

- "—" will send nothing.
  - "← TV" will jump to TV.
  - "→ VCR" will jump to last active VCR or DVD. Active VCR/DVD is defined as the mode that remains for a minimum of 5 seconds, or if a key is pressed in that mode.
- \* The VOLUME and MUTE will jump to "TV" by default. When the volume is unlocked, all the devices will have their own volume. The AUDIO1/2 (Receiver, CD) modes will have their own volume even if Volume Lock is on TV, CABLE/SAT, VCR, or DVD. See "Using the Volume Lock feature" on page 16.

# Programming the remote control for use with your audio/video devices

## Device code setup

1. Refer to the Device code table on pages 17 – 20 to find the code for the brand of your device.  
If more than one number is listed, try each one separately until you find the one that works.
2. Press MODE until the Mode indicator of the device (CABLE/SAT, VCR, DVD, AUDIO1, AUDIO2) lights up.
3. While holding down the RECALL button, press the Channel Number buttons to enter the four-digit code of your brand of device. If a valid code is entered, the mode indicator will blink twice. If an invalid code is entered, the mode indicator will blink one long blink.
4. Point the remote control at the device and press POWER to test the code.  
If the device turns on, you have entered the correct code.  
If the device does not respond to the remote control, you may have entered the wrong code. Repeat steps 3 and 4 using another code.
5. Press MODE to select the TV mode to control the TV.

## Searching and sampling the code of a device (991)

If you do not know the device code for a particular target unit, you can cycle the remote control through the available codes for that device mode and sample the functions to find the code that properly operates the target device. The keys available to be sampled, provided they are applicable to that mode, are 0, 1, 2, 3, POWER, VOL ▲, CH ▲, PLAY, and STOP. Invalid keys will be ignored while in program mode.

To cycle through each available device code and sample its functions:

1. Press MODE to select the mode you want to set up.
2. While holding down the RECALL button, press 9 –9 –1.  
The remote control will enter program mode.
3. Point the remote control at the target device and press POWER (or other function buttons that are available to be sampled).
4. If the device responds to the remote control:  
Press RECALL to store the device code.  
The mode indicator will blink twice and the remote control will exit the program mode.  
If the device does not respond to the remote control:  
Press ▲, and then press POWER.  
Repeat this step until the device responds to the remote control, and then press RECALL.

**Note:** When a search cycle is completed, the mode indicator will blink three times. The remote control will begin to cycle through the available codes again. If no key is pressed within 10 seconds while programming, the remote control will exit the program mode and return to the previous code.

### Note:

- Every time you replace the batteries, you must reprogram the remote control.
- Some newer VCRs are capable of working on either of two remote codes. These VCRs have a switch labeled "VCR1/VCR2." If your VCR has this kind of switch and does not respond to any of the codes for your VCR brand, set the switch to the other position (VCR1 or VCR2) and reprogram the remote control

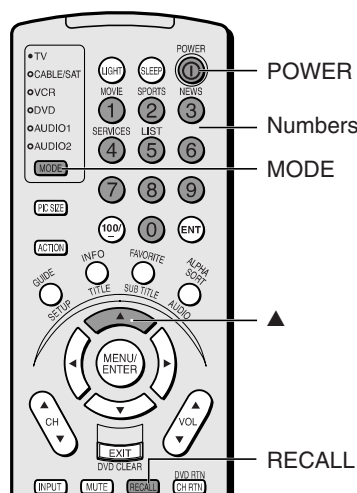

### Verifying (990)

Use this feature to verify the device code for your other devices. The number of times the 1, 2, 3, and 4 buttons is the 4-digit code.

For example, the device code of the VCR:

1. Press the VCR mode.
2. While holding down the RECALL button, press 9-9-0.
3. Press 1.
4. Press 2.
5. Press 3.
6. Press 4.

The Mode indicator of the VCR mode is "0385."

### Volume Lock Feature (993)

This feature allows you to lock the volume controls in TV, CBL/SAT, and DVD modes, and the volume controls (MUTE) can be programmed (locked) to the device code. This feature does not apply to the AUDIO1/2 modes.

To lock the volume controls to always jump to the device code:

1. Press MODE to select the CABLE/SAT mode.
2. While holding down the RECALL button, press 9-9-3.
3. Press VOL ▲.

The Mode indicator will blink two times (locked).

The following table describes in more detail the Volume Lock implementation.

Volume Locked to	TV	CBL/SAT	VCR	DVD	AUD1	AUD2
TV (default)	TV	TV	TV	TV	AUD1	AUD2
CBL/SAT	CBL/SAT	CBL/SAT	CBL/SAT	CBL/SAT	AUD1	AUD2
VCR	VCR	VCR	VCR	VCR	AUD1	AUD2
DVD	DVD	DVD	DVD	DVD	AUD1	AUD2
AUD1	AUD1	AUD1	AUD1	AUD1	AUD1	AUD1
AUD2	AUD2	AUD2	AUD2	AUD2	AUD2	AUD2

To reset the volume controls to the original device code:

1. While holding down the RECALL button, press 9-9-3.
  2. Press VOL ▼.
- The Mode indicator will blink four times (unlocked).

### Operational feature reset (980)

This feature clears all setup features not related to "Device code set up" and resets the Volume Lock to "TV."

To reset the features:

- While holding down the RECALL button, press 9-8-0.
- The Mode indicator will blink two times, and then pause and blink two more times.

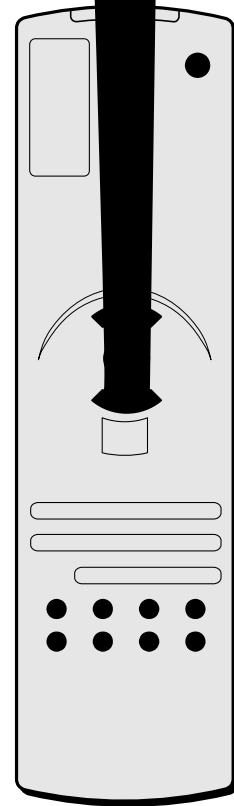



## Device code table

### Cable box setup codes

Brand	Code
ABC	0020, 0022, 0026, 0027, 0030, 0032, 0033, 0036
Allegro	0172, 0334
Americast	0918
Antronix	0041, 0226
Archer	0041, 0172, 0226, 0816
BBT	0286
Belcor	0075
Bell & Howell	0033
Bell South	0918
Cable Star	0075
Cabletenna	0041
Cableview	0041
Century	0172
Citizen	0172, 0334
Colour Voice	0044, 0050
Comtronics	0059
Contec	0038
Digi	0656
Eastern	0021
Emerson	0816
Everquest	0034, 0059
Focus	0419
GC Electronics	0075, 0226
Garrard	0172
Gemini	0034, 0089, 0816
General Instrument	0030, 0295, 0495, 0829
GoldStar	0059, 0163
Goodmind	0816
Hamlin	0028, 0039, 0053, 0278, 0292
Hitachi	0030
Hytex	0026
Jasco	0034, 0172, 0334
Jerrold	0022, 0030, 0031, 0033, 0034, 0043, 0295, 0495, 0829
Linsay	0459
Magnavox	0046
Memorex	0019
Movie Time	0082, 0175
NSC	0082, 0089, 0175
Novaplex	0637
Oak	0026, 0038
Optimus	0040
Panasonic	0019, 0040, 0126
Panther	0656
Paragon	0019
Philips	0044, 0046, 0050, 0172
Pioneer	0042, 0163, 0552, 0896
Popular Mechanics	0419
Prelude	0789
Pulsar	0019
Quasar	0019
RCA	0040
Radio Shack	0034, 0334, 0816, 0902
Realistic	0226
Recoton	0419
Regal	0039, 0278, 0292
Regency	0021
Rembrandt	0030, 0089
Runco	0019

SL Marx	0059
Samsung	0059, 0163
Scientific Atlanta	0027, 0036, 0496, 0896
Seam	0529
Signal	0034, 0059
Signature	0030
Sprucer	0040
StarSight	0441, 0561
Starcom	0022, 0034
Stargate	0034, 0059, 0789, 0816
Starquest	0034
Sylvania	0020
TFC	0329
TV86	0082
Tandy	0277
TeleCaption	0240
Televue	0059
Texscan	0020
Timeless	0437
Tocom	0031, 0032
Toshiba	0019
Tusa	0034
Unika	0041, 0172, 0226
United Artists	0026
Universal	0041, 0075, 0172, 0210, 0226
Viewstar	0046, 0082, 0277
Zenith	0019, 0073, 0544, 0918
Zentek	0419

### Satellite Receiver setup codes

Brand	Code
AlphaStar	0791
Chaparral	0072, 0235
Curtis Mathes	0080
Echostar	0288, 0299, 0794, 1024
Expressvu	0794
General Instrument	0380, 0646, 0888
HTS	0794
Hitachi	0838
Homecable	0257
Hughes Network Systems	0768
IQ	0229
IQ Prism	0229
JVC	0794
Jerrold	0380, 0646
Legend	0288
Macom	0080
Magnavox	0741, 0743
Memorex	0288, 0743
Next Level	0888
Panasonic	0720
Philips	0741, 0743
Primestar	0380, 0646
RCA	0162, 0411, 0585, 0874
Radio Shack	0888
Realistic	0071
STS	0229
Sony	0658
Star Choice	0888
Toshiba	0080, 0101, 0768, 0809, 1071, 1072, 1073
Uniden	0071, 0093, 0257, 0741, 0743
Zenith	0080, 0875

## Device code table

### VCR setup codes

Brand	Code	Brand	Code	Brand	Code
Admiral	0067, 0228	Kenwood	0057, 0060, 0086, 0403	Radix	0056
Adventura	0019			Randex	0056
Aiko	0297	Kodak	0054, 0056	Realistic	0019, 0054, 0056, 0065, 0066, 0067, 0081, 0085, 0123
Aiwa	0019, 0056, 0326	LXI	0056	ReplayTV	0633, 0635
Akai	0060, 0072, 0080, 0125	Lloyd's	0019, 0227	Ricoh	0053, 0272
America Action	0297	Logik	0091	Runco	0058
American High	0054	MEI	0054	STS	0061
Asha	0259	MGA	0062, 0080, 0259	Samsung	0064, 0070, 0072, 0259
Audiovox	0056	MGN Technology	0259	Sanky	0058, 0067
Beaumarck	0259	MTC	0019, 0259	Sansui	0019, 0060, 0086, 0228, 0290, 0498
Bell & Howell	0123	Magnasonic	0297	Sanyo	0065, 0066, 0123, 0259
Broksonic	0021, 0140, 0203, 0228, 0314, 0380, 0498	Magnavox	0019, 0054, 0058, 0100, 0129, 0168	Scott	0062, 0064, 0140, 0203, 0229, 0231
CCE	0091, 0297	Magnin	0259	Sears	0019, 0054, 0056, 0061, 0065, 0066, 0073, 0076, 0085, 0123, 0124
Calix	0056	Marantz	0054, 0100	Semp	0064
Canon	0054	Marta	0056	Sharp	0067, 0081
Capehart	0039	Matsushita	0054, 0181, 0473	Shintom	0091
Carver	0100	Memorex	0019, 0054, 0056, 0058, 0065, 0066, 0067, 0123, 0181, 0228, 0259, 0326, 0473, 1056, 1181, 1281	Shogun	0070, 0259
Cineral	0297	Minolta	0061, 0124	Singer	0091
Citizen	0056, 0297	Mitsubishi	0062, 0067, 0080, 0086	Sony	0019, 0051, 0052, 0053, 0054, 0272, 1051
Colt	0091	Motorola	0054, 0067	Sunpak	0272
Craig	0056, 0066, 0091, 0259, 0290	Multitech	0019, 0091	Sylvania	0019, 0054, 0062, 0100, 0129
Curtis Mathes	0054, 0060, 0079, 0181	NAD	0077	Symphonic	0019
Cybernex	0070, 0259	NEC	0057, 0059, 0060, 0086, 0123	TMK	0055, 0227, 0259
Daewoo	0039, 0064, 0297, 0580	Nikko	0056	Tatung	0060
Daytron	0039	Nikon	0053, 0272	Teac	0019, 0060
Denon	0061	Noblex	0259	Technics	0054, 0181
Dynatech	0019	Olympus	0054	Teknika	0019, 0054, 0056
Electrohome	0056	Optimus	0056, 0067, 0077, 0123, 0181, 0451, 0473, 1067, 1081, 1181, 1281	Thomas	0019
Electrohome	0056	Optonica	0081	Tivo	0637
Emerex	0051	Orion	0021, 0203, 0228, 0314, 0498	Toshiba	0062, 0064, 0076, 0085, 0229, 0231, 0385
Emerson	0019, 0021, 0055, 0056, 0062, 0080, 0087, 0107, 0140, 0203, 0227, 0228, 0231, 0297, 0313, 0314, 0380, 0498, 0580	Panasonic	0054, 0096, 0181, 0244, 0473, 0635, 1081, 1181, 1281	Totevision	0056, 0259
Fisher	0066, 0073, 0085, 0123	Penney	0054, 0056, 0057, 0059, 0061, 0073, 0259	Unitech	0259
Fuji	0052, 0054	Pentax	0061, 0124	Vector	0064
Funai	0019	Philco	0054, 0228, 0498	Vector Research	0057, 0059
GE	0054, 0067, 0079, 0221, 0259	Philips	0054, 0081, 0100, 0129, 0637, 1100, 1200	Video Concepts	0059, 0064, 0080
Garrard	0019	Pilot	0056	Videosonic	0259
Go Video	0451, 0545, 0662	Pioneer	0077, 0086	Wards	0019, 0054, 0061, 0066, 0067, 0079, 0081, 0091, 0100, 0168, 0231, 0259
GoldStar	0056, 0057	Portland	0039	White Westinghouse	0228, 0297
Gradiente	0019, 0027	Profitronic	0259	XR-1000	0019, 0054, 0091
HI-Q	0066	Proscan	0079, 0221	Yamaha	0057
Harley Davidson	0019	Protec	0091	Zenith	0019, 0052, 0053, 0058, 0228, 0498, 0656
Harman/Kardon	0057, 0100	Pulsar	0058, 0070		
Harwood	0087, 0091	Quarter	0065		
Headquarter	0065	Quartz	0065		
Hitachi	0019, 0060, 0061, 0124	Quasar	0054, 0096, 0181, 0473, 1181		
Hughes Network Systems	0061	RCA	0054, 0061, 0067, 0079, 0096, 0124, 0125, 0168, 0221, 0259		
JVC	0027, 0060, 0086, 0403	Radio Shack	0019, 1056		
Jensen	0060				
KEC	0056, 0297				
KLH	0091				

## Device code table

### DVD setup codes

Brand	Code
Aiwa	0660
Denon	0509, 0653
GE	0541
Harman/Kardon	0601
JVC	0577, 0642
Kenwood	0553
Magnavox	0522
Marantz	0558
Mitsubishi	0540
Onkyo	0522, 0646
Optimus	0590
Panasonic	0509, 0651
Philips	0522, 0558
Pioneer	0544, 0590, 0651
Proscan	0541
RCA	0541
Samsung	0592
Sharp	0649
Sherwood	0652
Sony	0552
Technics	0509
Theta Digital	0590
Toshiba	0522
Yamaha	0509, 0564
Zenith	0522, 0610

### Laser Disc setup codes

Brand	Code
Aiwa	0222
Carver	0083, 0213, 0342
Denon	0078, 0191
Disco Vision	0042
Funai	0222
Harman/Kardon	0213
Hitachi	0042
Magnavox	0213, 0236
Marantz	0083, 0213
Mitsubishi	0078
NAD	0078
Optimus	0078
Panasonic	0223
Philips	0083, 0213
Pioneer	0042, 0078
Quasar	0223
Realistic	0222
Samsung	0342
Sega	0042
Sony	0212, 0220
Technics	0223
Theta Digital	0213
Yamaha	0236

### CD Player setup codes

Brand	Code
ADC	0037
Adcom	0174, 0253
Aiwa	0143, 0176
Akai	0175
Audio Alchemy	0213
Audio-Technica	0189
BSR	0213, 0264
Burmester	0439
California Audio Labs	0048, 0322
Carrera	0213
Carver	0176, 0198, 0318, 0456
DAK	0264
DKK	0019
Denon	0022, 0892
Emerson	0174, 0183, 0324, 0488
Fisher	0107, 0193, 0198, 0361
GE	0028
Garrard	0264, 0299, 0412, 0439
Genexxa	0051, 0183, 0324
Harman/Kardon	0176, 0192, 0445
Hitachi	0051, 0174
JVC	0091
Kenwood	0047, 0056, 0209, 0645, 0700, 0845
Kodak	0306
Krell	0176
Kyocera	0037
LXI	0324
Linn	0176
Luxman	0112
MCS	0048
MTC	0439
Magnavox	0176, 0324
Marantz	0048, 0176, 0199
McIntosh	0306
Mission	0176
NAD	0038, 0318
NEC	0253
NSM	0176
Nikko	0183, 0189, 0193
Onkyo	0120, 0887
Optimus	0019, 0051, 0056, 0106, 0164, 0198, 0213, 0215, 0299, 0324, 0361, 0439, 0445, 0456, 0487, 1082
Panasonic	0048, 0322, 0386, 0771
Parasound	0213, 0439
Philips	0176, 0306, 0645
Pioneer	0051, 0263, 0324, 0487, 1082
Proton	0176
QED	0176
Quasar	0048
RCA	0028, 0072, 0174, 0198, 0324, 0783
Realistic	0174, 0183, 0198, 0199, 0439
Rotel	0176, 0439
SAE	0176
STS	0037
Sansui	0176, 0221, 0324
Sanyo	0106, 0198
Scott	0174, 0183, 0324
Sears	0324
Sharp	0056, 0199, 0880
Sherwood	0199, 0215, 0445, 1086
Sony	0019, 0204, 0509, 0623, 0624
Soundesign	0164
Tascam	0439
Teac	0193, 0199, 0412, 0439
Technics	0048, 0322
Toshiba	0038, 0318
Vector Research	0213
Victor	0091
Wards	0072, 0176
Yamaha	0055, 0189, 0206
Yorx	0480

## Device code table

### Amplifier setup codes

Brand	Code
Aiwa	0425
Carver	0288
Curtis Mathes	0319
Denon	0179
GE	0097
Harman/Kardon	0911
JVC	0350
Linn	0288
Magnavox	0288
Marantz	0288
Optimus	0319, 0414
Panasonic	0327
Philips	0288, 0911
Pioneer	0032, 0319
Realistic	0414
Sony	0239, 0708
Soundesign	0097
Technics	0327
Toshiba	0372
Victor	0350
Wards	0032, 0097
Yamaha	0373

### Cassette Player setup codes

Brand	Code
Aiwa	0048, 0216, 0219
Akai	0302
Carver	0048
Denon	0095
Fisher	0093
Garrard	0327, 0458
Harman/Kardon	0048, 0201
JVC	0263, 0292
Kenwood	0089
Magnavox	0048
Marantz	0028, 0048
Mitsubishi	0302
Onkyo	0154, 0155, 0301
Optimus	0046, 0239, 0356, 0458
Panasonic	0248
Philips	0048
Pioneer	0046, 0118, 0239
Revox	0209
Sansui	0028, 0048
Sherwood	0356
Sony	0189, 0262, 0310
Teac	0327
Technics	0248
Toshiba	0360, 0361
Victor	0292
Wards	0046
Yamaha	0113, 0116

### Misc. Audio setup codes

Brand	Code
Aiwa	0029, 0178, 0423
Fisher	0071
Harman/Kardon	0496
JBL	0496
JVC	0092
Jerrold	0478, 0539
Nikko	0395
Paramount Pictures	0336
RCA	0075
SSI	0336
Schneider	0395
Scientific Atlanta	0479
Sony	0029, 0178, 0595
Soundesign	0395
Starcom	0478
Yorx	0395

### Receiver setup codes

Brand	Code
ADC	0550
Adcom	0635
Aiwa	0140, 0177, 0208, 0424, 1108, 1424
Akai	0095, 0243
Capetronic	0550
Carver	0027, 0061, 0208, 0379, 1108, 1208
Casio	0214
Clarinette	0214
Curtis Mathes	0099
Denon	0023, 0292, 0790, 1123, 1179
Emerson	0443
Fisher	0061, 0238, 0379
Garrard	0443, 0482
Harman/Kardon	0129, 0208, 0910
Inkel	0081
JBL	0129
JVC	0093
Kenwood	0046, 0061, 0096, 0205, 0332, 0333, 1046, 1071, 1332, 1588
Koss	0443
LXI	0200
Linn	0208
Lloyd's	0214
MCS	0058, 0365
Magnavox	0147, 0208, 0214, 0410, 0550, 1108, 1208
Marantz	0058, 0147, 0208, 1108, 1208
Modulaire	0214
NAD	0339
NEC	0254
Nakamichi	0116, 0366
Onkyo	0119, 0154, 0399
Optimus	0061, 0099, 0196, 0200, 0205, 0238, 0550, 0689, 0757, 0820, 1042
Panasonic	0058, 0328, 0537, 1537
Penney	0214
Philips	0208, 0410, 1108, 1208

Pioneer	0033, 0099, 0169, 0550, 0649, 1042, 1273
Proscan	1273
Quasar	0058
RCA	0073, 0365, 0379, 0549, 0550, 1173, 1273
Realistic	0182, 0200, 0214
Sansui	0208, 0212, 0365, 1108
Sanyo	0238, 0820
Scott	0182, 0341
Sharp	0205
Sherwood	0081, 0510, 0521
Sony	0177, 0187, 0493, 1061, 1077, 1177, 1277
Soundesign	0689
Sunfire	0332, 0333, 1071, 1332
Teac	0182, 0482
Technics	0058, 0227, 0328, 0537, 1327, 1328, 1537
Thorens	1208
Victor	0093
Wards	0033, 0073, 0099, 0177, 0208
Yamaha	0195, 0205, 1195
Yorx	0214
Zenith	0876

## Learning about the remote control

The buttons used for operating the TV only are described here. For a complete list of the remote control's functions, see the "Remote Control functional key chart" on pages 13–14.

**POWER** turns the TV on and off

**SLEEP** allows access to the automatic TV shut-off function (page 45)

**LIGHT** The first press of the LIGHT button lights the keypad and turns on the Illumination mode. With the Illumination mode on, pressing any other key lights the keypad for 5 seconds (10 seconds if you're in programming mode). Subsequent presses of the LIGHT button toggle between turning the Illumination mode on and off.

**Channel Numbers (0-9, 100)** allow direct access to channels (page 26)

**MODE** cycles through the six device modes: TV, CABLE/SAT, VCR, DVD, AUDIO1, and AUDIO2. The mode indicator lights remain lit for 10 seconds (page 15).

**PIC SIZE** cycles through the three picture formats: Normal, L, and Compression (page 30)

**FAVORITE** allows access to the Multi-Window function (page 31)

**MENU** allows access to on-screen programming menu (page 27)

**ENTER** sets programming menu information (page 27)

**▲▼◀▶** select or adjust programming menus (page 27)

**(FAV) ◀▶** cycles through favorite channels (page 27)

**CH ▲▼** cycles through programmed channels (page 27)

**VOL ▲▼** adjusts the volume level (page 27)

**EXIT** exits the programming menu (page 27)

**INPUT** selects the video input (page 27)

**MUTE** mutes the sound (page 27)

**RECALL** displays on-screen menu (page 27)

**CH RTN** returns to the previous channel (page 27)

**PIP CH** selects the PIP/double-window channel (page 31)

**PIP ON/OFF** turns the PIP/double-window feature on and off (page 31)

**PIP SW** switches between multi-window function (page 33)

**PIP SIZE** adjusts the PIP/double-window picture (page 32)

**PIP SW** switches the main and sub-pictures (page 32)

**LOCATE** changes the display position of the small picture (page 32)

**SOURCE** selects the PIP/double-window picture source (page 31)

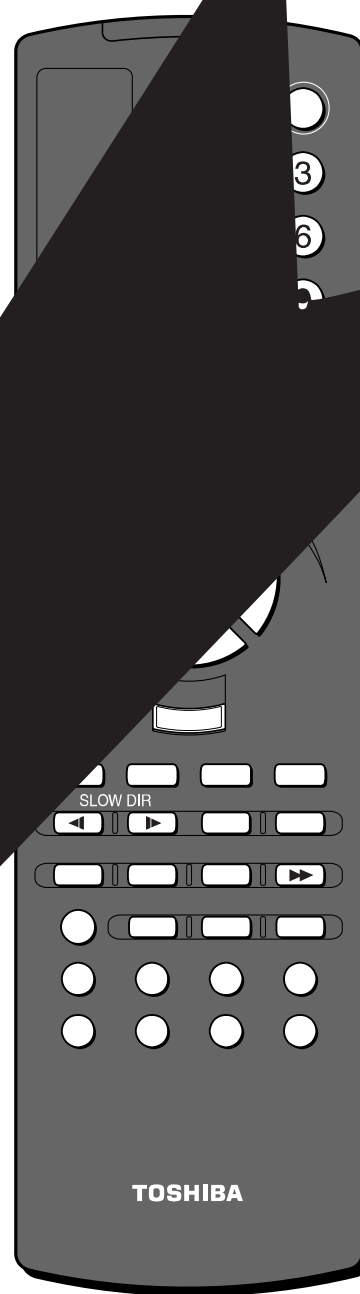

# Setting up your TV

## Learning about the menu system

After you have installed the batteries and programmed the remote control, you will need to set some preferences on the TV using the menu system. You can access the menus using the buttons on your TV or remote control.

1. Press MENU to display menu.
2. Press ◀ or ▶ to select menu.
3. Press ▲ or ▼ select an item.
4. Press ◀ or ▶ to select or adjust a setting.

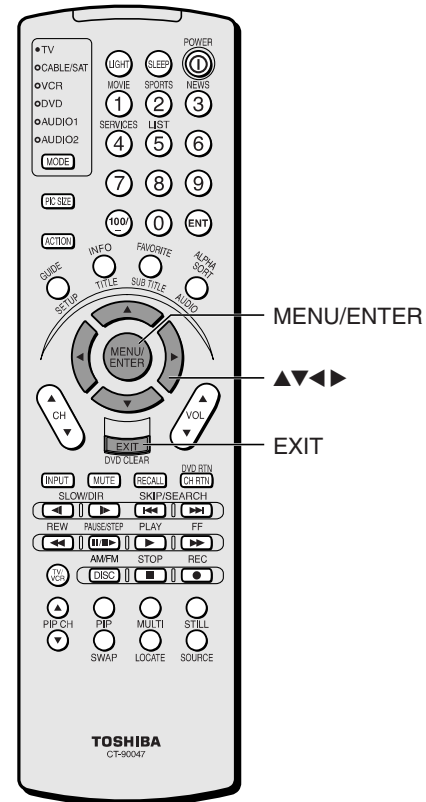
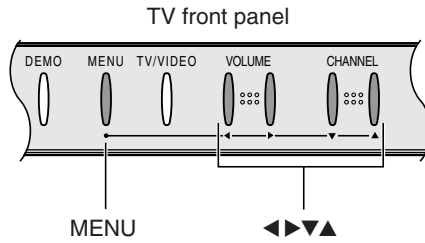
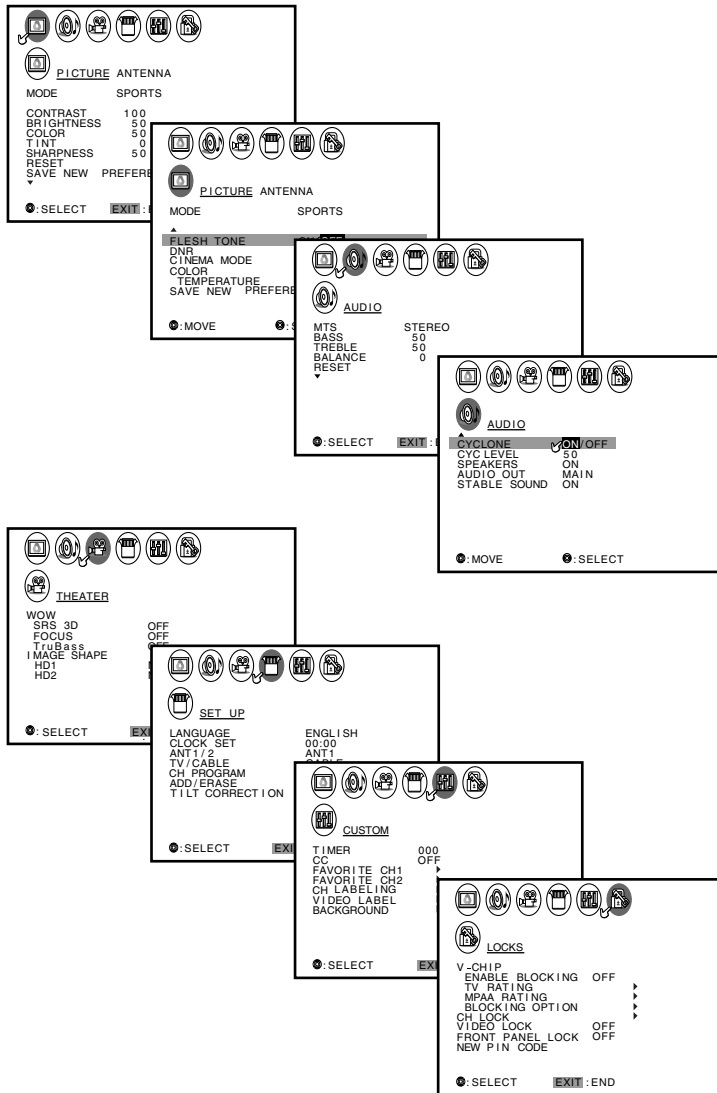

**Note:**  
You can change the background of the menu.  
See page 50 for details.

- Press ENTER to activate the function settings in the CUSTOM menu, etc.
- The main menu display will disappear automatically if you do not make a selection within 15 seconds; the other displays will disappear automatically within 6 seconds.
- If you want to close all the on-screen displays instantly, press EXIT.

## Changing the on-screen display language

Choose from three different languages (English, French and Spanish) for the on-screen display of adjustment menus and messages.

To select a language:

1. Press MENU, and then press ◀ or ▶ until the SET UP menu appears.
2. Press ▲ or ▼ to highlight LANGUAGE.

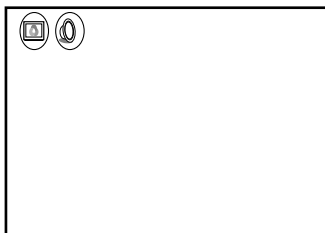

## Adding channels to the TV's memory

When you press Channel ▲ or ▼, your TV will stop only on the channels stored in the TV's channel memory.

Follow the steps below and on the next page to program all active channels into the TV's memory.

### Programming channels automatically

Your TV can automatically detect all active channels in your area and store them in its memory. After the channels are stored automatically, you can manually add or erase individual channels (see page 25).

To program channels automatically:

1. Press MENU, and then press ◀ or ▶ until the SET UP menu appears.
2. Press ▲ or ▼ until the TV/CABLE is highlighted.
3. Press ◀ or ▶ to highlight either TV or CABLE, depending on which you use. If you use an antenna, highlight TV; if you use cable, highlight CABLE.

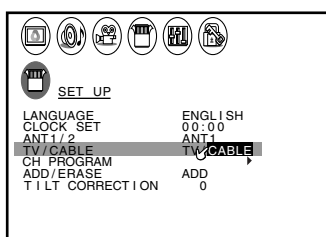

4. Press ▼ to select CH PROGRAM.

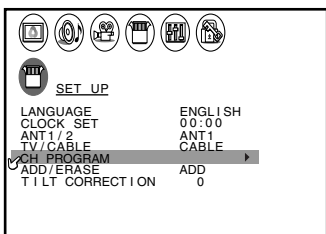

5. Press ◀ or ▶ to start channel programming. The TV will automatically cycle through all the TV or Cable channels (depending on which you selected), and store all active channels in the channel memory.

While the TV is cycling through the channels, the message "Programming Now—Please Wait" appears.

6. When channel programming is complete, the message "Completed" appears.
7. Press Channel ▲ or ▼ to view the programmed channels.

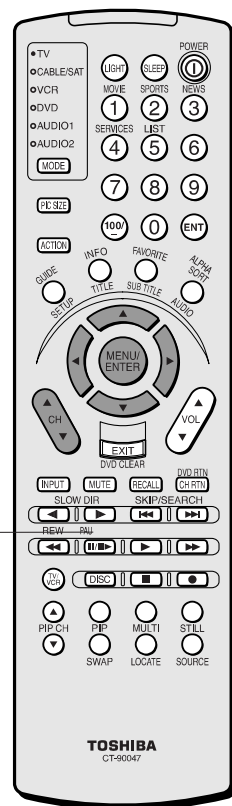



## Adding and erasing channels manually

After you have programmed the channels automatically, you can manually add or erase specific channels.

To add or erase channels:

1. Select the channel you want to add or erase. If you are adding a channel, you must select the channel using the Channel Number buttons.
2. Press MENU, and then press ◀ or ▶ until the SET UP menu appears.
3. Press ▲ or ▼ to highlight ADD/ERASE.

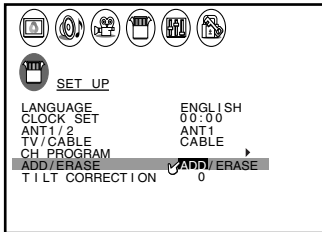

4. Press ◀ or ▶ to select ADD or ERASE, depending on the function you want to perform.
5. Press ▼ to add (or erase) the channel.
6. Repeat steps 1-5 for other channels you want to add or erase.

## Adjusting the tilt correction feature

When you install the TV or change the direction of the TV, the picture may suffer from color shading and/or tilt of the picture because of the Earth's magnetic field. If so, the following adjustment should be made for the best possible picture.

To adjust the tilt correction:

1. Press MENU, then press ◀ or ▶ until the SET UP menu appears.
2. Press ▲ or ▼ to highlight TILT CORRECTION.
3. Press ◀ or ▶ to correct any tilt of the picture between +10 and -10.

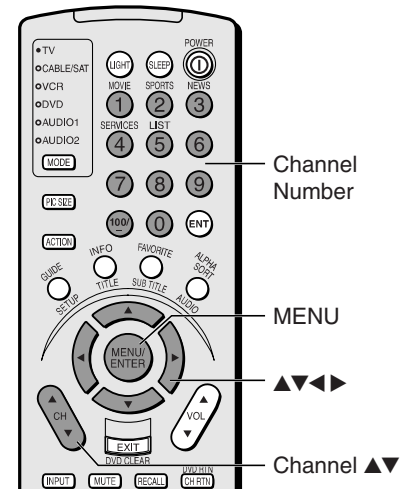
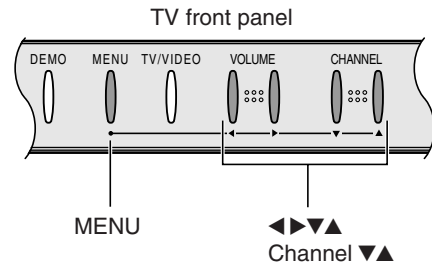
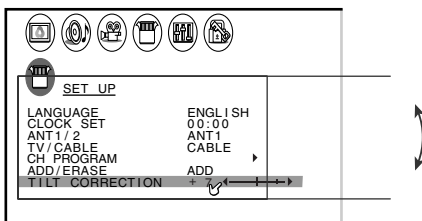

## Changing channels

To change to the next programmed channel:

Press Channel ▲ or ▼ on the TV or remote control.

To change to the specific programmed channel:

Press and hold Channel ▲ or ▼ for about one second. The TV will enter the channel surf mode.

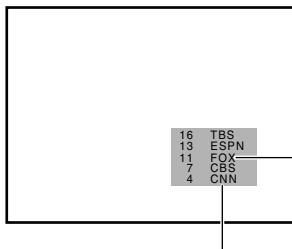

Repeatedly press or hold channel ▲ or ▼ while the channel surf mode is on-screen to scroll the channel list. Release the button to display the highlighted channel.

To change to a specific channel (programmed or unprogrammed):

Press the Channel Number buttons (0-9 and 100).

For channels 100 and higher, press the 100 button, and then the next two numbers. For example, to select channel 102, press 100-2-5.

## Using the TV's features

### Adjusting the channel settings

#### Switching between two channels

You can switch between two channels without entering an actual channel number each time.

To switch between two channels:

1. Select the first channel or video mode you want to view.
2. Select a second channel with the Channel Number buttons (0-9, 100).
3. Press CH RTN. The previous channel will be displayed.

Each time you press CH RTN, the TV will switch back and forth between the two channels.

#### Programming your favorite channels

You can preset up to 9 of your favorite channels each for FAVORITE CH1 and FAVORITE CH2 modes using the Favorite Channel Programming feature. Pressing Favorite Channel buttons will

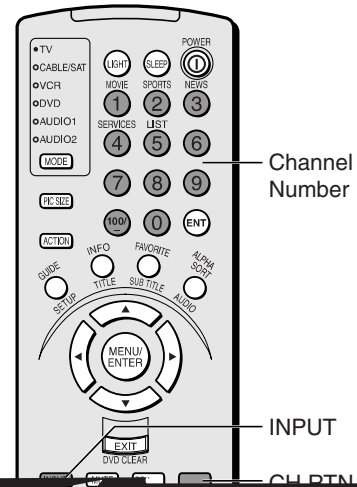

Press the CUSTOM menu

FAVORITE CH1 or FAVORITE CH2

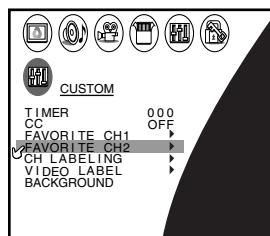

Press ◀ or ▶ to display the FAVORITE CH1 menu.

CH INPUT will be highlighted.

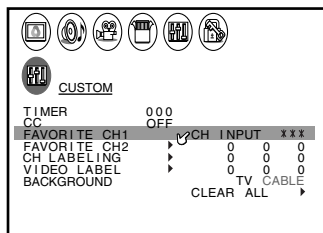

4. Press the Channel Number buttons to enter one of your favorite channel.
5. Press ENTER.
6. Repeat steps 4 and 5 for other channels.

To select your favorite channels:

Press (FAV) ◀ or ▶.

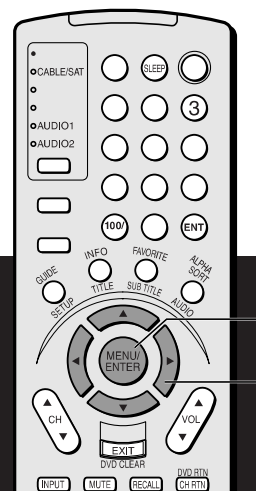

#### Note:

- The (FAV) ◀▶ buttons operate only when a menu screen is displayed.
- The favorite channel feature is not available in ANT2 mode.

To quickly scan through your favorite channels in a 9-picture multi-window:

Press FAVORITE (see page 33).

To clear a favorite channel:

1. Press MENU, and then press ◀ or ▶ until the CUSTOM menu appears.
2. Press ▲ or ▼ to highlight FAVORITE CH2, for example.
3. Press ◀ or ▶ to display the FAVORITE CH2 menu.

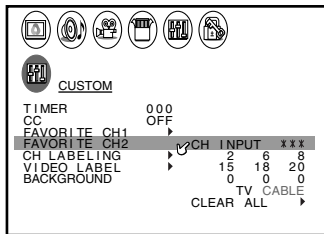

4. Press ▲▼◀▶ to highlight the channel you want to clear, then press ENTER.

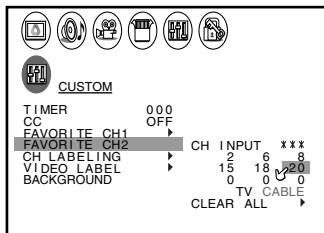

5. Repeat step 4 for other channels.

To clear all favorite channels at once:

Press ▲ or ▼ to highlight CLEAR ALL in step 4 above, and then press ▶ or ◀ to clear all favorite channels at once.

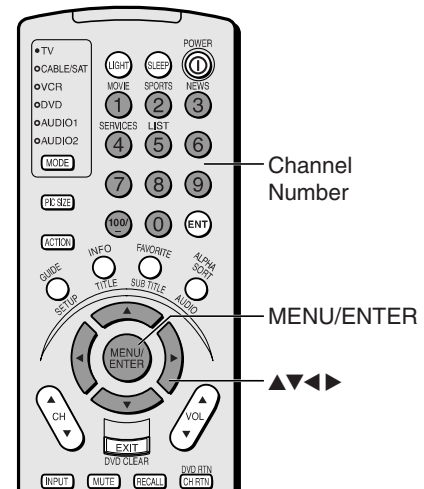
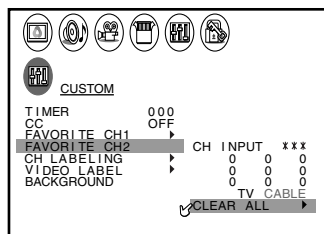

## Labeling channels

Channel labels appear above the on-screen channel number display each time you turn on the TV, change a channel, or press RECALL. You can choose any four characters to identify a channel.

To create channel labels:

1. Press MENU, and then press ◀ or ▶ until the CUSTOM menu appears.
2. Press ▲ or ▼ to highlight CH LABELING.
3. Press ◀ or ▶ to display the CH LABELING menu.  
CH INPUT will be highlighted.

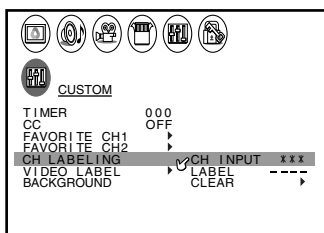

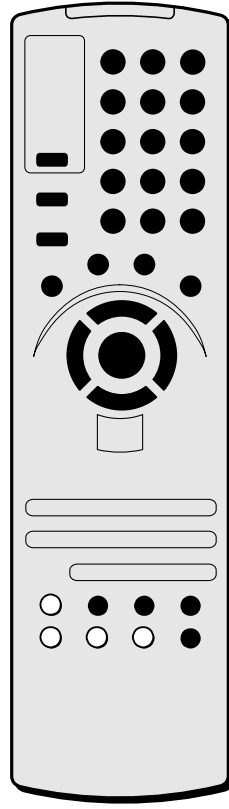

Introduction

Connecting  
your TV

Using the  
Remote Control

Setting up  
your TV

Using the TV's  
Features

Appendix

Index

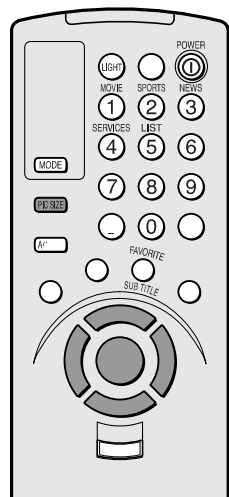

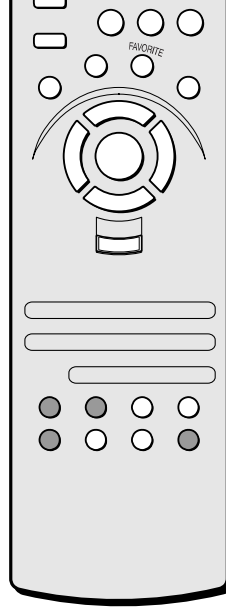

Introduction

Connecting  
your TV

Using the  
Remote Control

Setting up  
your TV

Using the TV's  
Features

Appendix

Index

## Switching the main and sub-pictures

Press SWAP while you are using the PIP feature to switch the main and sub-pictures. The main and sub-pictures will switch each time you press the SWAP button.

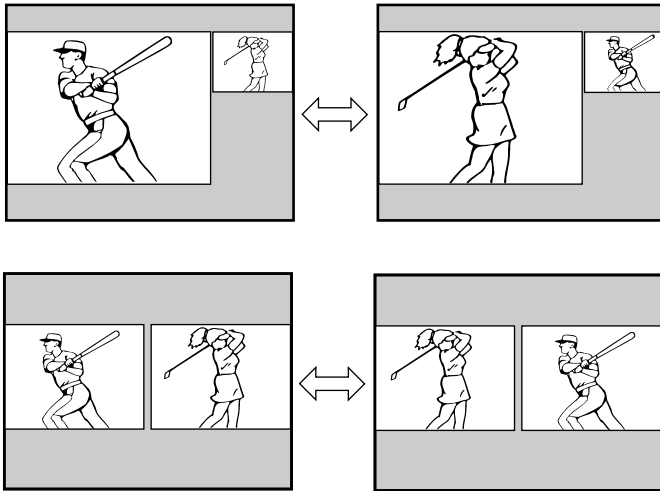

## Changing the position of the small picture

Press LOCATE repeatedly while you are watching a small picture. The display position of the small picture will change in the following order:

**Note:** The LOCATE button is not available while in the double-window mode.

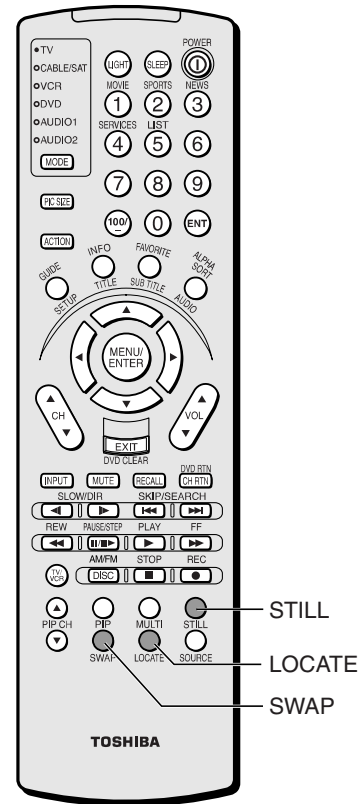
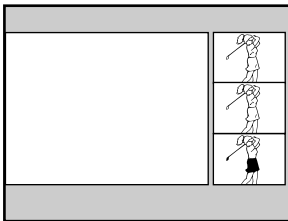



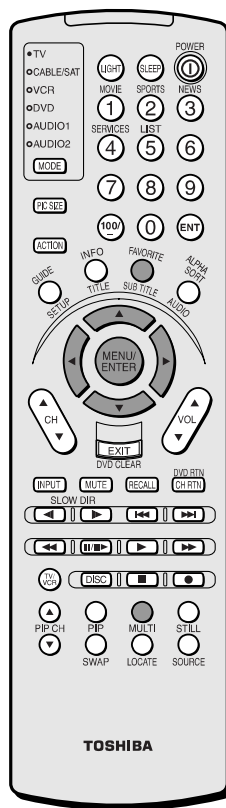

Introduction

Connecting your TV

Using the Remote Control

Setting up your TV

Using the TV's Features

Appendix

Index

## Using the LOCKS menu

The LOCKS menu includes the V-Chip, CH Lock, Video Lock, and New PIN Code functions. You can use these functions after entering the correct PIN code.

### Entering the PIN code

1. Press MENU, and then press ◀ or ▶ until the LOCKS menu appears.

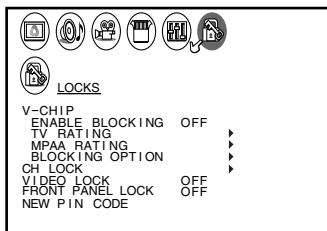

2. Press ▲ or ▼ to display the PIN code entering mode.

- Blocking Reset status: Set your 4-digit code by pressing the Number buttons (0-9), and then press ENTER.
- When the PIN code is already stored: Press the Number buttons (0-9) to enter the 4-digit PIN code used for blocking channels, and then press ENTER.

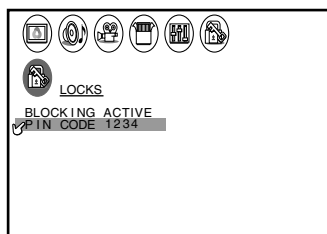
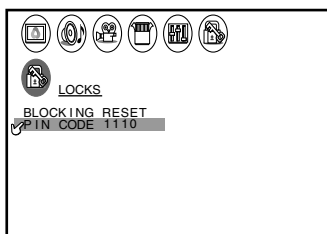

If a wrong PIN code is entered, the message “Incorrect” appears. Enter the code again, and then press ENTER.

If you cannot remember the PIN code, while in the PIN code entering mode, press the RECALL button four times within five seconds. The PIN code will be released (Blocking Reset status restored).

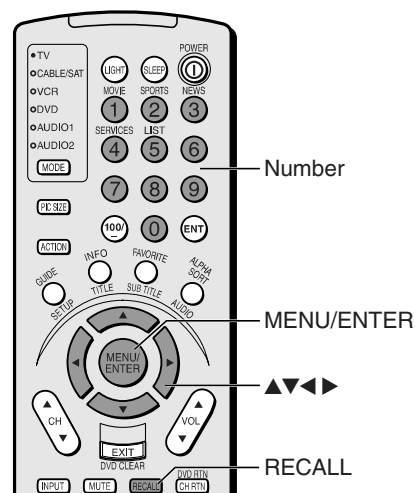
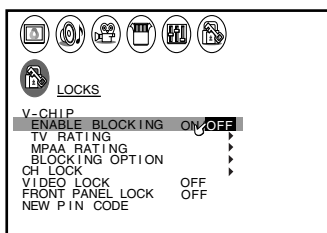

Continue to set each item following the steps on the next page.

## Using the V-CHIP menu

Some TV programs and movies include signals that classify the content of the program (violence, sex, dialog, language). The V-CHIP control feature in this TV detects the signals and blocks the programs according to your selections. To use this feature, perform the following setup.

### ENABLE BLOCKING

1. From the LOCKS menu, select ENABLE BLOCKING.
2. Press ◀ or ▶ to select ON or OFF.  
ON : To enable your setting (Lock)  
OFF: To release your setting (Unlock)

**Note:** The CH LOCK function is not affected with this selection.

### TV RATING (Independent rating system for broadcasters)

1. From the LOCKS menu, select TV RATING.
2. Press ◀ or ▶ to display the TV RATING menu.
3. Press ▼ or ▲ to select item.
4. Press ▶ to lock (display "X")  
Press ◀ to unlock (display "✓")
5. Repeat steps 3 and 4 to set the next item.

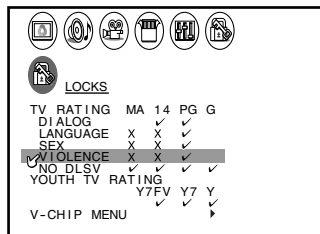

The TV age-based ratings and content themes you can lock are listed in the table below.

Ratings	Description and Content themes
MA	Mature Audience Only (This program is specifically designed to be viewed by adults and therefore may be unsuitable for children under 17.) <b>L) Crude or indecent language S) Explicit sexual activity V) Graphic violence</b>
14	Parents Strongly Cautioned (This program contains some material that many parents would find unsuitable for children under 14 years of age.) <b>D) Intensely suggestive dialog L) Strong, coarse language S) Intense sexual situations V) Intense violence</b>
PG	Parental Guidance Suggested (This program contains material that parents may find unsuitable for younger children.) <b>D) Some suggestive dialog L) Infrequent coarse language S) Some sexual situations V) Moderate violence</b>
G	General Audience (Most parents would find this program suitable for all ages.)
Y7, Y7FV	Directed to Older Children (This program is designed for children age 7 and above. Note: Programs in which fantasy violence may be more intense or more combative than other programs in this category are designated Y7FV.)
Y	All Children (This program is designed to be appropriate for all children)

### LOCKS menu

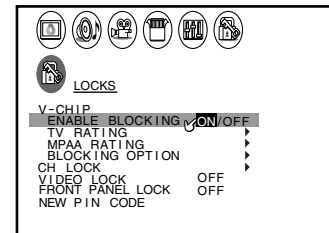

To select each item:

Press ▼ or ▲.



Press RECALL to display the rating of the TV program you are currently watching.

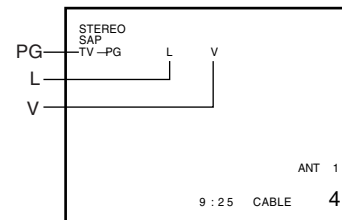

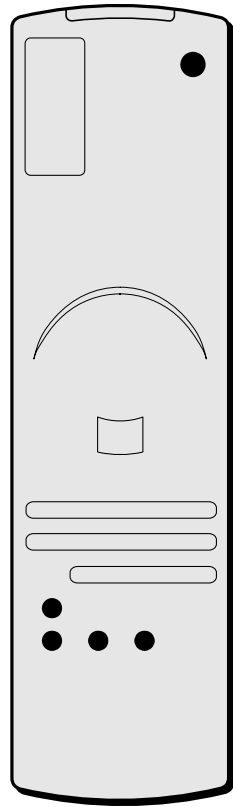

annels. The TV  
annel ▲▼  
clear the setting.

LOCK. CH INPUT will be

LOCK menu.

uttons to enter the channel you  
if you are currently watching cannot be

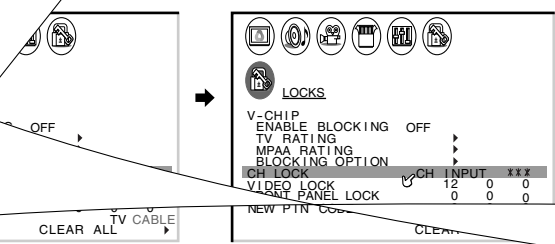

4. Repeat steps 3 and 4 for other channels. channels. w 3.8 4951393.91.86495.8674 26393.810

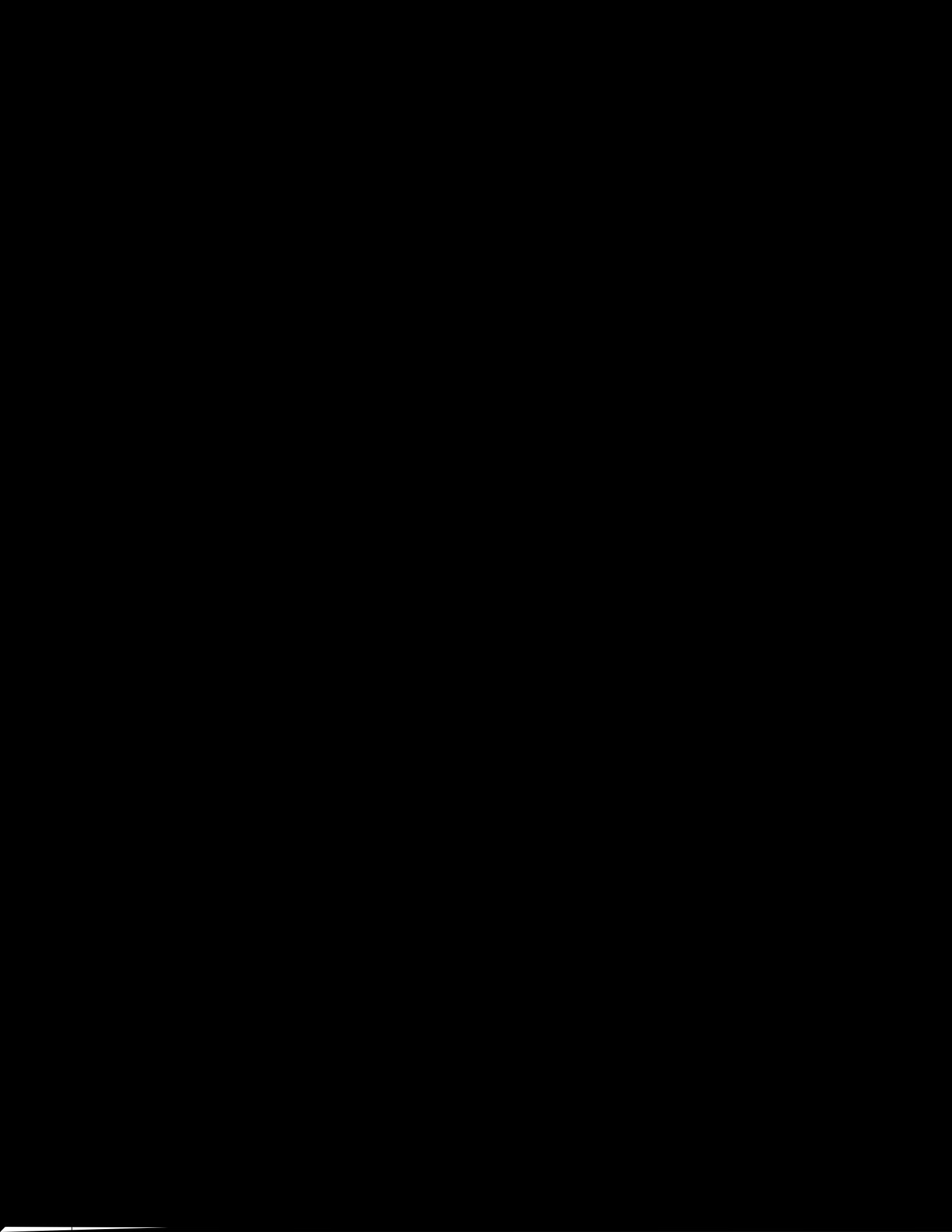

## Using the front panel lock feature

Lock the front panel buttons to prevent the buttons from being pressed accidentally (by children, for example). When the front panel lock is in ON mode, all control buttons on the TV front panel (except POWER) do not operate.

To lock the front panel:

1. From the LOCKS menu, select FRONT PANEL LOCK.
2. Press ◀ or ▶ to highlight ON.

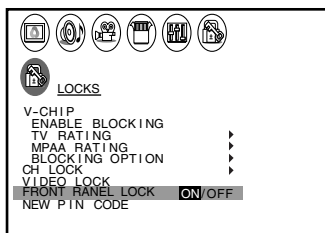

## Adjusting the picture

### Selecting the picture mode

You can select your desired picture type from four picture modes: Sports, Standard, Movie, and Preference.

Mode	Picture Quality
Sports	Bright and dynamic picture (factory setting)
Standard	Standard picture setting (factory setting)
Movie	Movie-like picture setting (factory setting)
Preference	Your personal preference*

\*(see "Saving new preference" on page 41.)

To select the picture mode:

1. Press MENU, and then press ◀ or ▶ until the PICTURE menu appears.
2. Press ▼ or ▲ to select MODE.
3. Press ◀ or ▶ to highlight the mode you prefer.

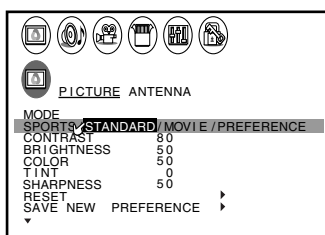

### Adjusting the picture quality

You can adjust the picture quality to your personal preferences, including the contrast, brightness, color, tint, sharpness, flesh tone, noise reduction and color temperature.

Selection	◀ Pressing ▶	
contrast	lower	higher
brightness	darker	lighter
color	paler	deeper
tint	reddish	greenish
sharpness	softer	sharper

To adjust the picture quality:

1. Press MENU, and then press ◀ or ▶ until the PICTURE menu appears.
2. Press ▼ or ▲ until the item you want to adjust is highlighted.
3. Press ◀ or ▶ to adjust the level.

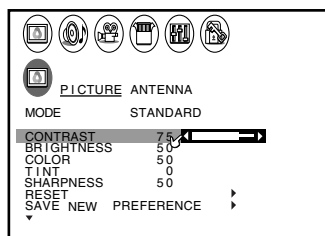

The PICTURE qualities you adjusted can be saved in the TV's memory with the SAVE NEW PREFERENCE feature (see page 41). You can keep these settings or choose factory set options, as described under "Selecting the picture mode" above.

### Note:

If you select one of the factory-set picture modes (SPORTS, STANDARD, or MOVIE) and then change a picture quality setting (for example, increase the contrast), the picture mode automatically changes to PREFERENCE in the Picture menu.

To save your new picture quality settings, you must select SAVE NEW PREFERENCE (see page 41) before closing the Picture menu or the TV will return to the previous picture mode.

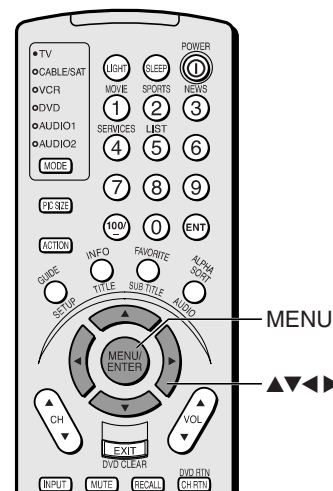
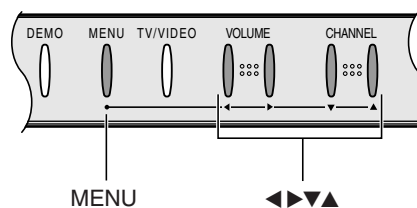



## Saving new preference

You can save the PICTURE qualities (contrast, brightness, color, tint, and sharpness) you adjusted in the picture preference mode.

To save your new preferences:

1. Press MENU, and then press ◀ or ▶ until the PICTURE menu appears.
2. Press ▲ or ▼ to highlight SAVE NEW PREFERENCE.
3. Press ◀ or ▶. When complete, the menu displays "DONE".

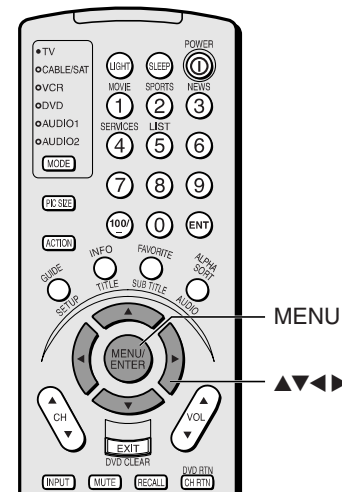
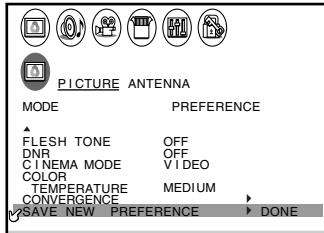

You can choose your saved preferences by selecting PREFERENCE (see "Selecting the picture mode" on page 40).

## Using the flesh tone feature

This feature displays natural flesh tones by correcting the tint.

To turn on the flesh tone feature:

1. Press MENU, and then press ◀ or ▶ until the PICTURE menu appears.
2. Press ▲ or ▼ to highlight FLESH TONE.
3. Press ◀ or ▶ to highlight ON.

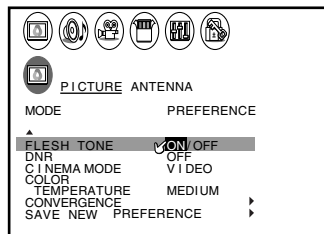

## Using the Digital Noise Reduction (DNR) feature

This feature allows you to reduce visible interference in your TV picture. This is useful when receiving a broadcast with a weak signal or playing back a video cassette or disc damaged by repeated use.

To turn on the DNR feature:

1. Press MENU, and then press ◀ or ▶ until the PICTURE menu appears.
2. Press ▲ or ▼ to highlight DNR.
3. Press ◀ or ▶ to highlight AUTO.

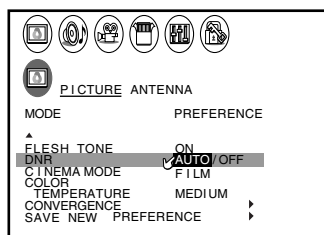

To turn off the DNR feature:

Highlight OFF in step 3 above.

## Selecting the cinema mode

When you view a DVD movie (3-2 pulldown processed) from a DVD player connected to the ColorStream (component video) inputs on the TV, smoother and more natural motion can be obtained by setting the CINEMA MODE to FILM (auto).

To set the CINEMA MODE to FILM (auto):

1. Press MENU, and then press ◀ or ▶ until the PICTURE menu appears.
2. Press ▲ or ▼ to highlight CINEMA MODE.
3. Press ◀ or ▶ to select FILM.

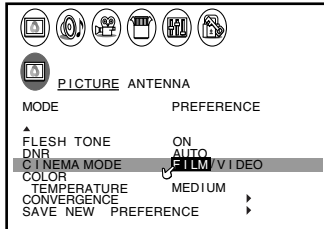

To set the CINEMA MODE to VIDEO (off):

Press ◀ or ▶ to select VIDEO in step 3 above.

## Selecting the color temperature

You can change the quality of the picture by selecting from three preset color temperatures: cool, medium, and warm.

To select the color temperature:

1. Press MENU, and then press ◀ or ▶ until the PICTURE menu appears.
2. Press ▲ or ▼ to highlight COLOR TEMPERATURE.
3. Press ◀ or ▶ to highlight the mode you prefer.

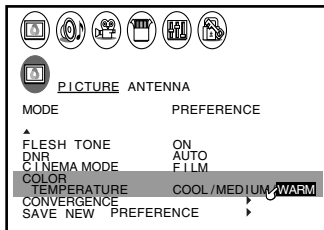

Mode	Picture Quality
cool	blueish
medium	neutral
warm	reddish

## Resetting picture adjustments

The RESET function adjusts the picture qualities to the following factory settings:

Contrast .....	max (100)	Color temperature .....	cool
Brightness .....	center (50)	DNR .....	auto
Color .....	center (50)	Mode .....	sports
Tint .....	center (0)		
Sharpness .....	center (50)		

To reset the picture adjustments:

1. Press MENU, and then press ◀ or ▶ until the PICTURE menu appears.
2. Press ▲ or ▼ to highlight RESET.
3. Press ◀ or ▶. The menu displays "DONE".

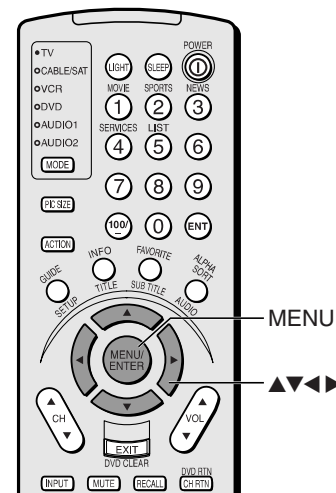
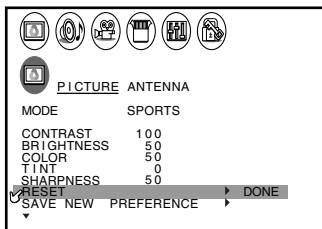



## Using the closed caption feature

The closed caption feature has two options:

- Captions—An on-screen display of the dialogue, narration, and sound effects of TV programs and videos that are closed captioned (usually marked as “CC” in TV listings).
- Text—An on-screen display of information not related to the current program, such as weather or stock data (when provided by individual stations).

To view captions or text:

1. Tune the TV to the desired program.
2. Press MENU, and then press ◀ or ▶ until the CUSTOM menu appears.
3. Press ▼ or ▲ to highlight CC.

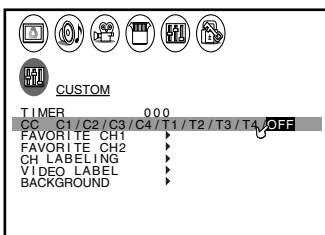

4. Press ◀ or ▶ to highlight the desired closed caption mode, as follows:

- To view captions, highlight C1, C2, C3, or C4 (C1 displays translation of the primary language in your area).

**Note:** If the program or video you selected is not closed captioned, no captions will display on the screen.



- To view text, highlight T1, T2, T3, or T4.

**Note:** If text is not available in your area, a black rectangle may appear on your screen. If this happens, turn the Closed Caption feature OFF.

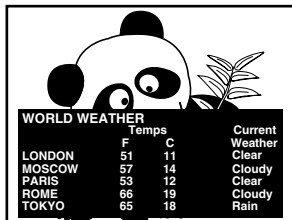

To turn off the Closed Caption feature:

Highlight OFF in step 4.

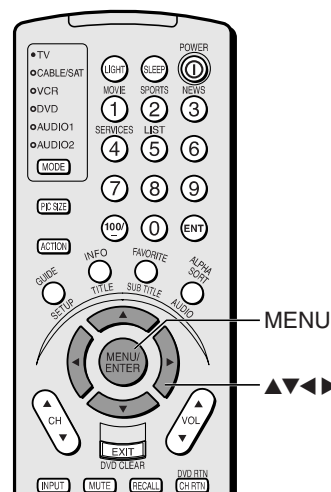

### Note:

A closed caption signal may not display in the following situations:

- when a videotape has been dubbed
- when the signal reception is weak
- when the signal reception is nonstandard

## Setting

To set the

1. Press S

... of time left until the TV  
..., press SLEEP once.

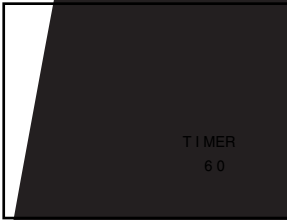

To

T

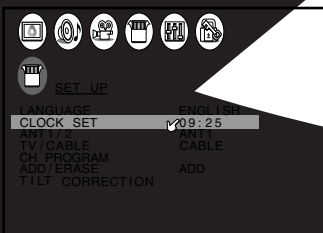
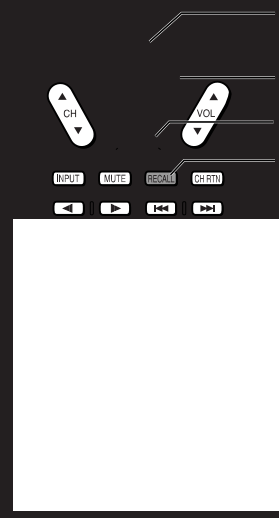

Int

Connecting  
your TV

col

Ind

## Adjusting the sound

### Muting the sound

Press MUTE to temporarily turn off the sound. While the sound is off, the screen will display the word “1/2 MUTE” or “MUTE” in the lower right corner. Every time you press the button, the mute mode will change in the following order.

→ Normal → 1/2 MUTE → MUTE →

When you select “MUTE” mode, the closed caption feature is automatically activated. To deactivate this feature, press MUTE again. This feature works only when the closed caption mode is set to OFF. See “Using the closed caption feature” on page 44 for more information.

### Selecting stereo/SAP broadcasts

The multi-channel TV sound (MTS) feature allows you to listen to high-fidelity stereo sound while watching TV. MTS can also transmit a second audio program (SAP) containing a second language, music, or other audio information (when provided by individual stations).

When the TV receives a stereo or SAP broadcast, the word STEREO or SAP appears on-screen every time the TV is turned on, the channel is changed, or the RECALL button is pressed.

The MTS feature is not available when the TV is in VIDEO mode.

To listen to stereo sound:

1. Press MENU, and then press ◀ or ▶ until the AUDIO menu appears.
2. Press ▲ or ▼ to highlight MTS.
3. Press ◀ or ▶ to highlight STEREO.

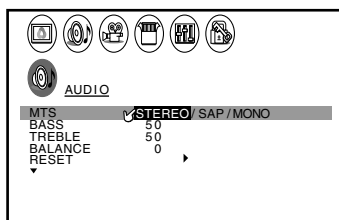

You can leave your TV in STEREO mode because it will automatically output the type of sound being broadcast (stereo or monaural). The word “STEREO” or “SAP” displays in yellow in the menu when the TV receives the signal.

If the stereo sound is noisy, select MONO to reduce the noise.

To listen to SAP (if available):

1. Press MENU, and then press ◀ or ▶ until the AUDIO menu appears.
2. Press ▲ or ▼ to highlight MTS.
3. Press ◀ or ▶ to highlight SAP. You will hear the station's second audio program (if available) from the speakers, while viewing the original program's picture (see note at right).

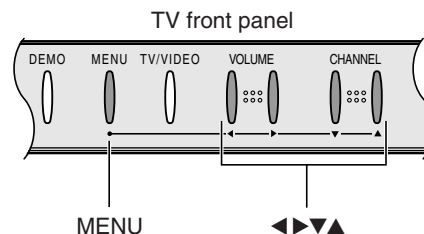
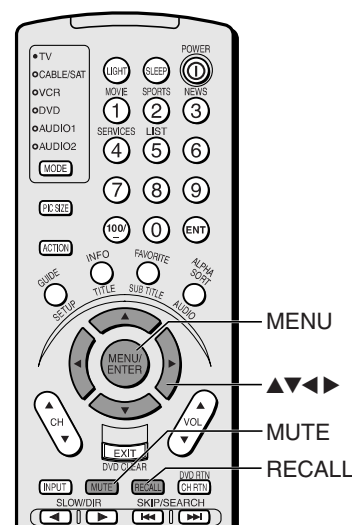

#### Note :

A second audio program (SAP) can be heard only on those TV stations that offer it.

For example, a station might broadcast music as a second audio program. If you have SAP on, you will see the current program on the screen but hear music instead of the program's normal audio.

However, if you have SAP on, and the station you are watching is not currently broadcasting a second audio program, you will see the picture but not hear any sound. If this happens, put the TV in STEREO mode so you can hear the station's normal audio.

## Using the WOW™ surround sound feature

The WOW™ surround sound feature expands the audio listening field wider and deeper to create exceptional sound quality from the TV's speakers. WOW consists of the three features: SRS 3D, FOCUS and TruBass, being turned on. The feature uses stereo signals from a TV broadcast or video input.

To adjust the WOW feature:

1. Select STEREO mode (see "Selecting stereo/SAP broadcasts" on page 46).
2. Press MENU, and then press ◀ or ▶ until the THEATER menu appears.
3. Press ▲ or ▼ to highlight the desired WOW feature you want to adjust, then press ◀ or ▶ to adjust the item.

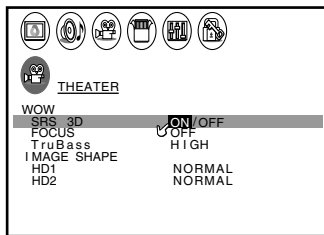

- SRS 3D — To turn on or off the surround sound effect.
- FOCUS — To turn on or off the vocal emphasis effect.
- TruBass — To select your desired bass expansion level from among HIGH, LOW or OFF.

## Adjusting the sound quality

You can change the quality of your TV's sound by adjusting the bass, treble, and balance.

To adjust the sound quality:

1. Press MENU, and then press ◀ or ▶ until the AUDIO menu appears.
2. Press ▲ or ▼ to highlight the item you want to adjust.

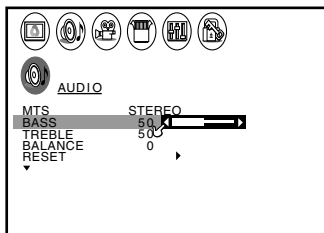

3. Press ◀ or ▶ to adjust the level.
  - ◀ makes the sound quality weaker or decreases the balance in the right channel, depending on the item selected.
  - ▶ makes the sound quality stronger or decreases the balance in the left channel, depending on the item selected.

### Note:

If the broadcast is monaural, the SRS 3D effect does not work.

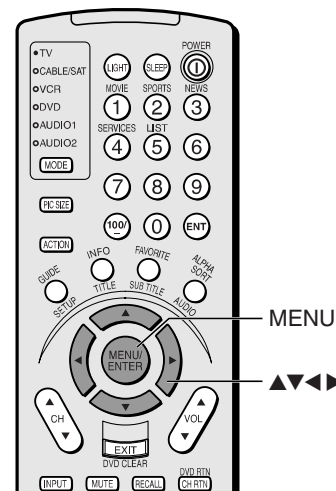

WOW is a trademark of SRS Labs, Inc.

WOW technology is incorporated under license from SRS Labs, Inc.

## Resetting audio adjustments

The RESET function returns the audio adjustments to the following factory settings:

Bass ..... center (50)  
Treble ..... center (50)  
Balance ..... center (0)

To reset the audio adjustments:

1. Press MENU, and then press ◀ or ▶ until the AUDIO menu appears.
2. Press ▲ or ▼ to highlight RESET.
3. Press ◀ or ▶. The menu displays “DONE”.

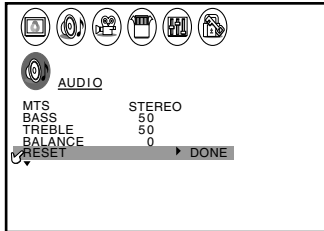

## Using the sub-woofer system “CYCLONE™”

Toshiba’s CYCLONE™ ABX (Acoustic Bass eXpansion) system provides dynamic acoustic reproduction in a self-enclosed bass-reflex sub-woofer system.

To turn on the CYCLONE woofer:

1. Press MENU, then press ◀ or ▶ until the AUDIO menu appears.
2. Press ▲ or ▼ to highlight CYCLONE.
3. Press ◀ or ▶ to highlight ON.

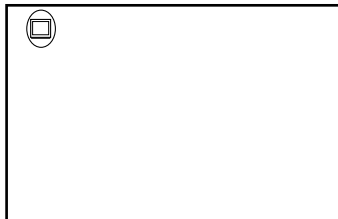



## Turning off the built-in speakers

Use this feature to turn the TV speakers off when you connect an audio system (see “Connecting an audio system” on page 11).

To turn off the built-in speakers:

1. Press MENU, then press ◀ or ▶ until AUDIO menu appears.
2. Press ▲ or ▼ to highlight SPEAKERS.
3. Press ◀ or ▶ to highlight OFF.

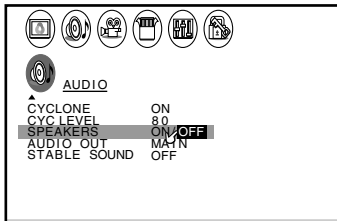

To turn on the built-in speakers:

Highlight ON in step 3 above.

## Selecting the Audio OUT sound

This feature allows you to select the sound source (MAIN or PIP) that is output from the Audio OUT jacks.

This is useful when amplifying or recording the PIP/double-window sound with external equipment while hearing the sound of the main picture through the built-in speakers.

To select the Audio OUT sound:

1. Press MENU, and then press ◀ or ▶ until the AUDIO menu appears.
2. Press ▲ or ▼ to highlight AUDIO OUT.
3. Press ◀ or ▶ to select MAIN or PIP.

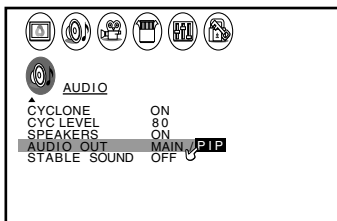

- MAIN: Outputs the sound of the main program.
- PIP : Outputs the sound of the PIP/double-window program.

### Note:

Make sure the volume control of your audio amplifier is set to a moderate listening level.

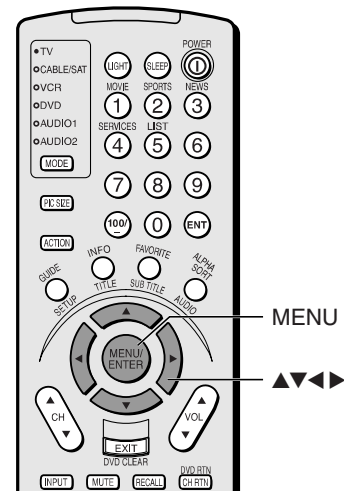

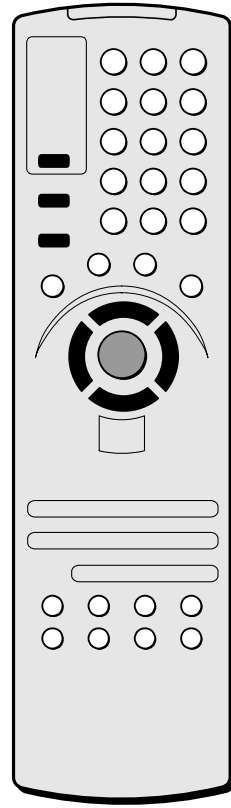

## Viewing the demonstration mode

When you press DEMO on the TV, the TV will automatically demonstrate several of your TV's features. This function is provided for demonstration purposes only.

To stop the demonstration mode:

Press DEMO again.

## Understanding the auto power off feature

The TV will automatically turn itself off after approximately 15 minutes if it is tuned to a vacant channel or if a station completes its broadcast for the day and stops broadcasting on that channel. This feature, however, does not work in the VIDEO mode.

## Understanding the last mode memory feature

If the power is cut off while you are viewing the TV and the power is resupplied, the last mode memory feature will turn the TV on automatically.

If the power is going to be off for a long time or you are going to be away from home for a long time, remove the power plug from the wall outlet to prevent the TV from turning on in your absence.

# Appendix

## Specifications

Television System	NTSC standard
Channel Coverage	VHF: 2 through 13 UHF: 14 through 69 Cable TV: Mid band (A-8 through A-1, A through I) Super band (J through W) Hyper band (AA through ZZ, AAA, BBB) Ultra band (65 through 94, 100 through 125)
Power Source	120 V AC, 60 Hz
Power Consumption	32HFX71: 185 W (average) 36HFX71: 175 W (average)
Audio Power	Main : 10 W + 10 W Sub-woofer : 13 W
Speaker Type	Main : Two 2-3/8 × 4-3/4 inches (60 × 120 mm) Sub-woofer : One 4 inches (100 mm) round
Video/Audio Terminals	S-VIDEO INPUT Y: 1 V(p-p), 75 ohm, negative sync. C: 0.286 V(p-p) (burst signal), 75 ohm VIDEO/AUDIO INPUT VIDEO: 1 V(p-p), 75 ohm, negative sync. AUDIO: 150 mV(rms) (30% modulation equivalent, 47 kohm) ColorStream™ (component video) INPUT Y: 1V(p-p), 75 ohm PB: 0.7 V(p-p), 75 ohm PR: 0.7 V(p-p), 75 ohm AUDIO: 150 mV(rms), 47 kohm VIDEO/AUDIO OUTPUT VIDEO: 1 V(p-p), 75 ohm, negative sync. AUDIO: 150 mV(rms) (30% modulation equivalent, 4.7 kohm) VARIABLE AUDIO OUTPUT 0–300 mV(rms) (30% modulation equivalent, 4.7 kohm) AUDIO CENTER CHANNEL INPUT 300 mV(rms) (30% modulation equivalent, 10 kohm)
Dimensions	32HFX71: Width 34-1/2 inches (875 mm) Height 26-9/16 inches (670 mm) Depth 22-5/8 inches (575 mm) 36HFX71: Width 38-1/4 inches (972 mm) Height 29-5/8 inches (753 mm) Depth 24-1/4 inches (615 mm)
Mass	32HFX71: 157 lbs. (71 kg) 36HFX71: 213.8 lbs. (97 kg)
Supplied Accessories	Remote Control with 2 size “AA” alkaline batteries
Optional TV stand	32HFX71: ST3261 36HFX71: ST3661

Design and specifications are subject to change without notice.



## Limited United States Warranty

Toshiba America Consumer Products, Inc. ("TACP") and Toshiba Hawaii Inc. ("THI") make the following limited warranties. These limited warranties extend to the original consumer purchaser or any person receiving this set as a gift from the original consumer purchaser and to no other purchaser or transferee.

### Limited One (1) Year Warranty

TACP and THI warrant this product and its parts against defects in materials or workmanship for a period of one (1) year after the date of original retail purchase. During this period, TACP and THI will repair or replace a defective part, at their option, with a new or refurbished part, without charge to you. TACP/THI Authorized Service Station personnel will come to your home when warranty service is required. Depending on the type of repair required, the service will either be performed in your home or the set will be taken to the TACP/THI authorized service station for repair and returned to your home at no cost to you.

### Limited Two (2) Year Warranty of Picture Tube

TACP and THI further warrant the picture tube in this product against defects in materials or workmanship for a period of two (2) years after the date of original retail purchase. During this period, TACP and THI will repair or replace a defective picture tube at their option, with a new or refurbished picture tube, without charge to you, except that if a defective picture tube is replaced after one (1) year from the date of the original retail purchase, you pay labor charges involved in the replacement.

### Rental Units

The warranty for rental units begins with the first rental or thirty (30) days from the date of shipment to the rental firm, whichever comes first.

### Commercial Units

Products sold and used for commercial use have a limited ninety (90) day warranty for all parts, labor and picture tube.

### Owner's Manual and Demographic Card

You should read this owner's manual thoroughly before operating this product. You should complete and mail the enclosed Demographic card within ten days after you, or the person who has given you this product as a gift, purchased this product. This is one way to enable TACP/THI to provide you with better customer service and improved products. Failure to return the Demographic card will not affect your rights under this warranty.

### Your Responsibility

The above warranties are subject to the following conditions;

- (1) You must retain your bill of sale or provide other proof of purchase.
- (2) All warranty servicing of this product must be made by an Authorized TACP/THI Service Station.
- (3) These warranties are effective only if the product is purchased and operated in the U.S.A. or Puerto Rico.
- (4) Labor service charges for set installation, set up, adjustment of customer controls and installation or repair of antenna systems are not covered by this warranty. Reception problems caused by inadequate antenna systems are your responsibility.
- (5) Warranties extend only to defects in materials or workmanship as limited above and do not extend to any product or parts which have been lost or discarded by you or to damage to products or parts caused by misuse, accident, damage caused by Acts of God, such as lightning or fluctuations in electric power, improper installation, improper maintenance or use in violation of instructions furnished by us; or to units which have been modified or had the serial number removed, altered, defaced or rendered illegible.

## How to Obtain Warranty Service

If after following all of the operating instructions in this manual and checking the "Troubleshooting" section, you find that service is needed:

- (1) Call the TACP toll-free number 1-800-631-3811 to find the nearest TOSHIBA Authorized Service Station. In Hawaii, contact Toshiba Hawaii, Inc. 327 Kamakee Street, Honolulu, Hawaii 96814 (808) 591-9281
- (2) Present your bill of sale or other proof to the Authorized Service Station. "Authorized TACP/THI service station personnel will come to your home when warranty service is required. Depending on the type of repair required, the service will either be performed in your home or the set will be taken to the TACP/THI Authorized service station for repair and returned to your home at no cost to you."

For additional information,  
visit our web site:  
**[www.toshiba.com](http://www.toshiba.com)**

All warranties implied by state law, including the implied warranties of merchantability and fitness for a particular purpose, are expressly limited to the duration of the limited warranties set forth above. With the exception of any warranties implied by state law as hereby limited, the foregoing warranty is exclusive and in lieu of all other warranties, guarantees, agreements and similar obligations of manufacturer or seller with respect to the repair or replacement of any parts. In no event shall TACP or THI be liable for consequential or incidental damages.

No person, agent, distributor, dealer or company is authorized to change, modify or extend the terms of these warranties in any manner whatsoever. The time within which action must be commenced to enforce any obligation of TACP or THI arising under this warranty or under any state, or law of the United States or any state thereof, is hereby limited to 90 days from the date you discover or should have discovered, the defect. This limitation does not apply to implied warranties arising under state law.

This warranty gives you specific legal rights and you may also have other rights which may vary from state to state. Some states do not allow limitation on how long an implied warranty lasts, when an action may be brought, or the exclusion or limitation of incidental or consequential damages, so the above provisions may not apply to you.



### ATTENTION CANADIAN CONSUMERS:

Canadian consumers are requested to complete the special Canadian "Warranty Registration Form" enclosed, and forward this completed form with a copy of bill of sale to TOSHIBA OF CANADA to "Register and Validate" their warranty.

Products purchased in the U.S.A. and used in Canada are not covered by these warranties.

Products Purchased in Canada and used in the U.S.A. are not covered by these warranties.

REV. 09-01

# Index

## A

A/V receiver connection .....	11
ANT 1/2 .....	23
Antenna cables .....	5
Audio cables .....	5
AUDIO OUT sound, selecting .....	49
Audio system connection .....	11
Auto power off .....	51

## B

BACKGROUND selection .....	50
Back of the TV .....	4

## C

Cable converter box connection .....	6
Camcorder connection .....	10
CH ▲▼ buttons .....	26
Channel surf mode .....	26
CH LABEL .....	28
CH LOCK .....	37
CH RTN button .....	27
Channel Number buttons .....	26
Channel programming	
ADD/ERASE .....	25
Automatic programming .....	24
TV/CABLE selection .....	24
Cinema mode .....	42
Clock, setting .....	45
Closed caption .....	44
ColorStream® cables .....	5
Color temperature .....	42
CYCLONE™ woofer .....	48

## D

Demonstration mode .....	51
Double-window .....	31
DNR (Digital Noise Reduction) .....	41
DTV receiver connection .....	9
DVD connection .....	7, 8

## F I

(FAV) ◀▶ buttons .....	27
FAVORITE button .....	33
Favorite channels .....	27
FOCUS feature .....	47
Front of the TV .....	4
Front panel lock .....	39
Image shape selection .....	30
INPUT button .....	23, 43

## L M

Labeling channels .....	28
Labeling video inputs .....	43
Language selection .....	23
Last mode memory .....	51
Locking channels .....	37
Locking video inputs .....	38
Locks menu .....	34
Menu system .....	22
MTS feature .....	46
MULTI button .....	33
Multi-window feature .....	33
MUTE button .....	46

## P

Picture adjustments	
COLOR TEMPERATURE .....	42
FLESH TONE .....	41
Picture mode .....	40
Picture quality .....	40
PIP feature	
LOCATE button .....	32
PIP button .....	31
PIP CH ▲▼ buttons .....	31
SOURCE button .....	31
STILL button .....	32
SWAP button .....	32
PIC SIZE button .....	30

## R

RECALL button .....	50
Remote control	
Battery installation .....	12
Device code table .....	17-20
Functional key chart .....	13-14
Learning about the buttons .....	21
Operational feature reset .....	16
Programming .....	15
Searching and sampling the code .....	15
Verifying the device code .....	16
Volume Lock feature .....	16
RESET .....	42, 48

## S

SAP sound .....	46
Satellite receiver connection .....	7
Set-top box connection .....	9
SLEEP button .....	45
Sleep timer .....	45
Sound quality adjustments .....	47
SPEAKERS on/off .....	49
Specifications .....	52
SRS 3D surround .....	47
StableSound™ .....	50
Stereo sound .....	46
S-video cables .....	5

## T

TILT CORRECTION .....	25
Troubleshooting .....	53
TruBass feature .....	47
TV/VIDEO button .....	23, 43

## V

V-CHI P	
BLOCKING OPTION .....	36
ENABLE BLOCKING .....	35
MPAA RATING .....	36
NEW PIN CODE .....	39
TV RATING .....	35
Unlocking programs temporarily .....	37
VCR connection .....	5-10
Video cables .....	5
VIDEO LABEL .....	43
VIDEO LOCK .....	38

## W

Warranty .....	54
WOW™ feature .....	47

## **TOSHIBA AMERICA CONSUMER PRODUCTS, INC.**

HEAD OFFICE/82 TOTOWA ROAD, WAYNE, NEW JERSEY 07470  
NATIONAL SERVICE DIVISION:1420B TOSHIBA DRIVE, LEBANON, TN. 37087

## **TOSHIBA HAWAII, INC.**

HEAD OFFICE/327 KAMAKEE STREET, HONOLULU, HAWAII 96814, U.S.A. TEL: (808) 591-9281

## **TOSHIBA OF CANADA LTD.**

HEAD OFFICE/191 McNABB STREET MARKHAM, ONTARIO L3R 8H2, CANADA TEL: (905) 470-5400  
SERVICE CENTERS/TORONTO: 191 McNABB STREET MARKHAM, ONTARIO L3R 8H2, CANADA TEL: (905) 470- 5400  
MONTREAL: 1643, NORTH SERVICE RD., TRANS-CANADA HIGHWAY, DORVAL QUEBEC, H9P 1J1, CANADA  
TEL: (514) 856-4100  
VANCOUVER: 22171 FRASERWOOD WAY, RICHMOND, B.C. V6W 1J5, CANADA TEL: (604) 303-2500

MANUFACTURED BY  
**TOSHIBA AMERICA CONSUMER PRODUCTS, INC.**

ColorStream is a registered trademark of Toshiba Corporation.  
StableSound is a trademark of Toshiba America Consumer Products, Inc.

PRINTED IN USA  
(01-07) B

**TOSHIBA**  
23565306



## Free Manuals Download Website

<http://myh66.com>

<http://usermanuals.us>

<http://www.somanuals.com>

<http://www.4manuals.cc>

<http://www.manual-lib.com>

<http://www.404manual.com>

<http://www.luxmanual.com>

<http://aubethermostatmanual.com>

Golf course search by state

<http://golfingnear.com>

Email search by domain

<http://emailbydomain.com>

Auto manuals search

<http://auto.somanuals.com>

TV manuals search

<http://tv.somanuals.com>