

# TOSHIBA



## Color Television

CN32V71

Owner's Manual

Welcome to  
Toshiba

Connecting  
your TV

Using the  
Remote Control

Setting up  
your TV

Using the TV's  
Features

Appendix

Index

## SAFETY PRECAUTIONS

### WARNING

**TO REDUCE THE RISK OF FIRE OR ELECTRIC SHOCK, DO NOT EXPOSE THIS APPLIANCE TO RAIN OR MOISTURE.**

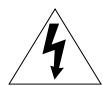
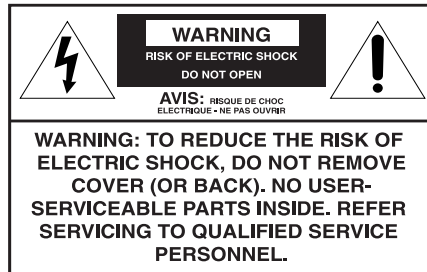

The lightning symbol in the triangle tells you that the voltage inside this product may be strong enough to cause an electric shock. **DO NOT TRY TO SERVICE THIS PRODUCT YOURSELF.**



The exclamation mark in the triangle tells you that important operating and maintenance instructions follow this symbol.

### CAUTIONS

TO PREVENT ELECTRIC SHOCK, DO NOT USE THIS POLARIZED PLUG WITH AN EXTENSION CORD RECEPTACLE OR OTHER OUTLET UNLESS THE PRONGS CAN BE FULLY INSERTED INTO THE OUTLET TO PREVENT ANY EXPOSURE OF THE PRONGS ON THE POLARIZED PLUG.

### ATTENTION

POUR PRÉVENIR LES CHOC ÉLECTRIQUES, NE PAS UTILISER CETTE FICHE POLARISÉE AVEC UN PROLONGATEUR, UNE PRISE DE COURANT OU UNE AUTRE SORTIE DE COURANT, SAUF SI LES LAMES PEUVENT ÊTRE INSÉRÉS À FOND SANS EN LAISSER AUCUNE PARTIE À DÉCOUVERT.

### WARNING

To avoid personal injury:

- Do not stand or climb on the TV.
- Do not put a VCR or any heavy object on top of the TV.

### AVIS

Pour éviter toute blessure:

- Ne pas grimper sur le téléviseur.
- Ne pas placer un magnétoscope ou autre objet lourd sur le téléviseur.

Avoid displaying stationary images on your TV screen for extended periods of time. Stationary patterns generated by a picture-in-picture (PIP) display, computer displays, video games, stock market reports, etc., can become permanently engrained on the picture tube. This damage is not protected by your warranty because it is the result of misuse. If you wish to use your TV to display still images, reduce brightness and contrast settings. Never leave a PIP, computer, or video game display unattended.

This TV set may be used with the Toshiba stand listed on page 35. Use with other stands may result in instability, causing possible injury.

#### *Note to CATV system installers in the USA*

This reminder is provided to call the CATV system installer's attention to Article 820-40 of the NEC, which provides guidelines for proper grounding, and, in particular, specifies that the cable ground shall be connected to the grounding system of the building, as close to the point of cable entry as practical.

## IMPORTANT SAFETY INSTRUCTIONS

## INSTRUCTIONS DE SÉCURITÉ

### CAUTION

PLEASE READ AND OBSERVE ALL WARNINGS AND INSTRUCTIONS CONTAINED IN THIS SECTION AND THOSE ON YOUR TV SET.

RETAIN THIS SECTION FOR REFERENCE.

### ATTENTION

VEUILLEZ LIRE ET OBSERVER LES AVERTISSEMENTS ET INSTRUCTIONS CONTENUS DANS CES PAGES ET CEUX INDIQUÉS SUR LE TÉLÉVISEUR PROPREMENT DIT.

### CONSERVER CETTE BROCHURE POUR TOUTE RÉFÉRENCE

Electrical energy can perform many useful functions. This TV set has been engineered and manufactured to assure your personal safety. However, improper use can result in potential electrical shock or fire hazards. In order not to defeat the safeguards incorporated in this TV set, observe the following basic rules for antenna/TV installation, use and servicing.

**Do not remove the cabinet cover. This may expose you to dangerous voltages. Refer all servicing to qualified service personnel.**

L'énergie électrique sert pour de nombreuses fonctions. Ce téléviseur a été conçu et fabriqué pour assurer votre entière sécurité. Mais il y a danger d'électrocution et d'incendie en cas d'utilisation inappropriée. Pour ne pas détériorer le système de sécurité de ce téléviseur, respectez les règles de base pour installer l'antenne et le téléviseur, utiliser le téléviseur ou le réparer.

**Ne pas ouvrir le coffret. Danger d'exposition à des tensions dangereuses. Pour toute réparation, faites appel à un réparateur compétent.**

### INSTALLATION / INSTALLATION

**Power Sources** — The TV set should be operated only from the type of power source indicated on the TV set or as indicated in the Owner's Manual. If you are not sure of the type of power supply in your home, consult your sales person or your local power company. For TV sets designed to operate from battery power, refer to the operating instructions.

**Sources d'alimentation** — Ce téléviseur ne doit fonctionner que sur la source d'alimentation indiquée sur le téléviseur ou dans le mode d'emploi. Si vous ne connaissez pas la tension locale de votre pays, consultez votre revendeur ou la compagnie d'électricité. Pour les téléviseurs qui doivent fonctionner sur batterie, consultez le mode d'emploi.

**Grounding or Polarization** — The TV set is equipped with one of the following type plugs. If the plug should fail to fit the power outlet, contact your electrician to replace your obsolete outlet. **DO NOT** defeat the safety purpose of the type plug on the TV set.

**Terre et polarisation** — Ce téléviseur est équipé d'une des fiches suivantes. Si la fiche ne rentre pas dans la prise d'alimentation, contactez votre électricien pour qu'il remplace la prise qui est probablement trop vieille. **NE PAS** modifier la fiche du téléviseur et enlever la broche de terre. La fiche ne remplirait plus son but.

*A polarized alternating current line plug* — having one blade wider than the other. This plug will fit into the power outlet only one way. If you are unable to insert the plug into the outlet, try reversing the plug.

*Une fiche de courant alternatif polarisée* est une fiche qui a une lame plus large que l'autre. Ce type de fiche ne rentre dans la prise d'électricité que d'une seule manière. Si vous ne parvenez pas à insérer cette fiche dans la prise, essayez dans le sens inverse.

**Alternate Warnings** — A three-wire grounding-type plug — a plug having a third (grounding) pin. This plug will only fit into grounding-type power outlet.

**Avertissements alternatifs** — Ce téléviseur est équipé d'une fiche à trois broches, c'est-à-dire d'une fiche avec une broche de terre. Cette fiche ne rentre que dans une prise d'alimentation avec mise à la terre.

**Water and Moisture** — Do not use the TV set near water — for example, near a bath tub, wash bowl, kitchen sink, or laundry tub; in a wet basement; or near a swimming pool; and the like.

**Eau et humidité** — Ne pas utiliser ce téléviseur à proximité de l'eau — par exemple, près d'une baignoire, cuvette, évier, lessiveuse, ou dans un sous-sol humide, une piscine, ou autres situations similaires.

**Ventilation** — The slots and openings in the cabinet and in the back or bottom are provided for necessary ventilation. Never block or cover these slots and openings to ensure reliable operation of the TV set and to protect it from overheating.

**Ventilation** — Les fentes et ouvertures du coffret, à l'arrière ou sous le téléviseur servent pour la ventilation. Pour garantir un bon fonctionnement et éviter toute surchauffe interne du téléviseur, ne jamais bloquer ou couvrir ces fentes et ouvertures.

- a. Never cover the slots and openings with a cloth or other materials.  
a. Ne jamais recouvrir les fentes et ouvertures d'un tissu ou autre matériel.
- b. Never block the slots and openings by placing the TV set on a bed, sofa, rug or other similar surface.  
b. Ne jamais bloquer les fentes et ouvertures en installant le téléviseur sur un lit, sofa, couverture, ou tout autre surface similaire.
- c. Never place the TV set in a confined space such as a bookcase, built-in cabinet, or any other place of poor ventilation.  
c. Ne jamais installer ce téléviseur dans un espace clos, comme une bibliothèque, un placard mural ou tout autre endroit où la ventilation est insuffisante.

**Heat** — Do not place the TV set near or over a radiator or heat register, or where it is exposed to direct sunlight.

**Chaleur** — Ne pas installer le téléviseur près ou au-dessus d'une source de chaleur, telle qu'un radiateur, un chauffage ou en plein soleil.

**Power-Cord Protection** — Do not allow anything to rest on or roll over the power cord, and do not place the TV set where the power cord is subject to wear or abuse.

**Protection du cordon d'alimentation** — Ne rien laisser sur le cordon ou ne rien faire rouler dessus. Ne pas installer le téléviseur dans un endroit où le cordon pourrait être usé ou abîmé.

**Accessories** — Do not place the TV set on an unstable cart, stand, tripod, bracket, or table. The TV set may fall, causing serious injury to a child or adult, and serious damage to the TV set. Use only with a cart, stand, tripod, bracket, or table recommended by the manufacturer, or sold with the TV set, and should use a mounting accessory recommended by the manufacturer.

**Accessoires** — Ne pas poser le téléviseur sur un chariot, support, trépied, console ou table instable. Le téléviseur pourrait tomber et causer des blessures importantes à un enfant ou un adulte. En outre il pourrait être sérieusement endommagé. Utilisez le téléviseur uniquement avec un chariot, support, trépied, console ou table recommandé par le fabricant, ou vendu avec le téléviseur, et n'utilisez, en cas de montage, que les accessoires recommandés par le fabricant.

A product and cart combination should be moved with care. Quick stops, excessive force, and uneven surfaces may cause the product and cart combination to overturn.

Lorsqu'un chariot est utilisé pour transporter le produit, le déplacer avec précaution. Le chariot et le produit peuvent être renversés en cas d'arrêt subit, de mouvement excessif et de surface non nivelée.



## USE / UTILISATION

**Overloading** — Do not overload wall outlets, extension cords or convenience receptacles beyond their capacity, since this can result in fire or electric shock.

**Surcharge** — Ne pas surcharger les prises murales, les cordons prolongateurs ou les raccords au-delà de leur capacité pour ne pas provoquer d'incendie ou d'électrocution.

During lightning storms, or when the TV set will be left unattended and unused for a long period of time, unplug the power cord from the wall outlet and disconnect the antenna or cable system. This will prevent damage to the TV set due to lightning and power-line surges.

Pendant un orage, ou quand vous prévoyez de ne pas utiliser le téléviseur pendant une longue période, débranchez le cordon d'alimentation de la prise murale ainsi que l'antenne ou le câble. Ceci a pour but d'éviter les dommages que pourrait causer la foudre ou les pointes subites de tension.

**Object and Liquid Entry** — Never push objects of any kind into the TV set through the cabinet slots as they may touch dangerous voltage points or short out parts that could result in a fire or electric shock. Never spill liquid of any kind on the TV set.

**Pénétration de liquide ou d'objet** — Ne jamais laisser pénétrer aucun objet dans ce téléviseur, car il risquerait de toucher des éléments soumis à une tension dangereuse ou de court-circuiter des pièces, ce qui pourrait provoquer un incendie ou une électrocution. Ne jamais répandre de liquide sur ce téléviseur.

**Cleaning** — Unplug the TV set from the wall outlet before cleaning or polishing it. Do not use liquid cleaners or aerosol cleaners. Use a cloth lightly dampened with water for cleaning the exterior of the TV set.

**Nettoyage** — Débranchez le téléviseur de la prise murale avant de le nettoyer ou de le polir. Ne pas utiliser de produits de nettoyage liquides ou de produits en vaporisateur. Utilisez un chiffon légèrement mouillé pour nettoyer l'extérieur du téléviseur.

**Attachments** — Never add accessories that have not been specifically designed for the TV set. Never remodel the TV set by yourself as this can result in a fire hazard or electric shock.

**Fixations** — Ne jamais ajouter d'accessoires non prévus spécialement pour le téléviseur. N'effectuez jamais vous-même des modifications sur le téléviseur pour éviter tout risque d'incendie ou d'électrocution.

If a snapping or popping sound from a TV set is heard continuously or frequently while the TV set is operated, unplug the TV set and consult your dealer or service technician. It is normal for some TV sets to make occasional snapping or popping sounds, particularly when being turned on or off.

Si le téléviseur produit un bruit sec et prolongé ou fréquent quand il est en marche, débranchez-le et adressez-vous à votre revendeur ou à un réparateur. Avec certains téléviseurs, ce genre de bruits occasionnel est normal surtout à la mise sous ou hors tension.

## SERVICE / RÉPARATION

**Damage Requiring Service** — Unplug the TV set from the wall outlet and refer servicing to qualified service personnel under the following conditions:

**Dommages exigeant une réparation** — Débranchez le téléviseur de la prise murale et faites appel à un réparateur qualifié dans les cas suivants:

- a. When the power cord or plug is damaged or frayed.  
a. Le cordon d'alimentation ou la prise est endommagée ou usée.
- b. When liquid has been spilled into the TV set.  
b. Du liquide a été répandu sur le téléviseur.
- c. When the TV set has been exposed to rain or water.  
c. Le téléviseur a été exposé à la pluie ou à l'eau.
- d. When the TV set has been subject to excessive shock by being dropped, or the cabinet has been damaged.  
d. Le téléviseur est tombé et a subi un choc violent, ou le coffret a été endommagé.
- e. When the TV set does not operate normally even though you follow the operating instructions. Adjust only those controls that are specified in the operating instructions. Improper adjustment of other controls may result in damage and will often require extensive work by a qualified technician to restore the TV set to normal operation. When the TV set exhibits a distinct change in performance. This indicates a need for service.  
e. Le téléviseur ne fonctionne pas normalement bien que vous respectiez les instructions du mode d'emploi. Faites uniquement les réglages indiqués dans le mode d'emploi, car tout autre réglage risque de provoquer des dommages qui nécessiteront des réparations supplémentaires pour que le téléviseur fonctionne de nouveau normalement.  
Quand le téléviseur n'offre plus les mêmes performances, une révision est aussi nécessaire.

**Servicing** — Do not attempt to service the TV set yourself. To open or remove the covers may expose you to dangerous voltage or other hazards. Refer all servicing to qualified service personnel.

**Réparation** — N'essayez pas de réparer vous-même le téléviseur. L'ouverture et le retrait des panneaux peut exposer à une tension dangereuse ou à d'autres dangers. Faites toujours appel à un réparateur compétent.

**Replacement Parts** — When replacement parts are required, be sure the service technician certifies in writing that he has used replacement parts specified by the manufacturer that have the same characteristics as the original parts. Unauthorized substitutions may result in fire, electric shock, or other hazards.

**Pièces de rechange** — Lorsque des pièces doivent être remplacées, demandez au réparateur qu'il vous garantisse par écrit qu'il a utilisé les pièces spécifiées par la fabricant et ayant les mêmes caractéristiques que les pièces d'origine. Des substitutions non autorisées peuvent être cause d'incendie, électrocution ou tout autre accident.

**Safety Check** — Upon completion of any service or repairs to the TV set, ask the service technician to perform routine safety checks (as specified by the manufacturer) to determine that the TV set is in safe operating condition, and to so certify.

**Contrôle de sécurité** — Après tout entretien ou toute réparation, demandez au réparateur d'effectuer des contrôles de sécurité (comme prescrit par le fabricant), pour voir si le téléviseur fonctionne normalement, et de vous le certifier.

When the TV set reaches the end of its useful life, improper disposal could result in a picture tube implosion. Ask a qualified service technician to dispose of the TV set.

Quand le téléviseur est devenu inutilisable, ne pas le déposer n'importe où afin d'éviter une implosion du tube. Demandez à un réparateur compétent où vous devez le déposer.

## ANTENNA / ANTENNE

**Outdoor Antenna Grounding** — If an outdoor antenna is installed, follow the precautions below.

An outdoor antenna system should not be located in the vicinity of overhead power lines or other electric light or power circuits, or where it can come in contact with such power lines or circuits.

WHEN INSTALLING AN OUTDOOR ANTENNA SYSTEM, EXTREME CARE SHOULD BE TAKEN TO KEEP FROM CONTACTING SUCH POWER LINES OR CIRCUITS AS CONTACT WITH THEM IS ALMOST INVARIABLY FATAL.

Be sure the antenna system is grounded so as to provide some protection against voltage surges and built-up static charges. Section 810 of the National Electrical Code in the USA and Section 54 of the Canadian Electrical Code in Canada provides information with respect to proper grounding of the mast and supporting structure, grounding of the lead-in wire to an antenna discharge unit, size of grounding conductors, location of antenna discharge unit, connection to grounding electrodes, and requirements for the grounding electrode.

**Mise à la terre de l'antenne extérieure** — Si vous installez une antenne extérieure, veuillez respecter les précautions ci-dessous.

Une antenne extérieure ne doit pas être installée près de lignes électriques aériennes ou autres circuits d'alimentation ou d'éclairage électriques, ou dans un endroit où elle pourrait toucher de tels circuits ou lignes.

LORS DE L'INSTALLATION D'UNE ANTENNE EXTÉRIEURE, SOYEZ EXTRÊMEMENT PRUDENT POUR ÉVITER DE TOUCHER DE TELS CIRCUITS OU LIGNES ÉLECTRIQUES, CAR UN TEL CONTACT ENTRAÎNE PRATIQUEMENT TOUJOURS LA MORT.

L'antenne doit être reliée à la terre par mesure de sécurité contre les hausses brusques de tension et l'électricité statique accumulée. La section 810 du National Electrical Code aux États-Unis et la section 54 du Code électrique du Canada fournissent des informations sur le raccordement à la terre correct du mât et de la structure porteuse, le raccordement de la descente d'antenne à une unité de décharge d'antenne, la taille des conducteurs de mise à la terre, l'emplacement de l'unité de décharge d'antenne, la connexion aux électrodes de terre, et les spécifications des électrodes de terre.

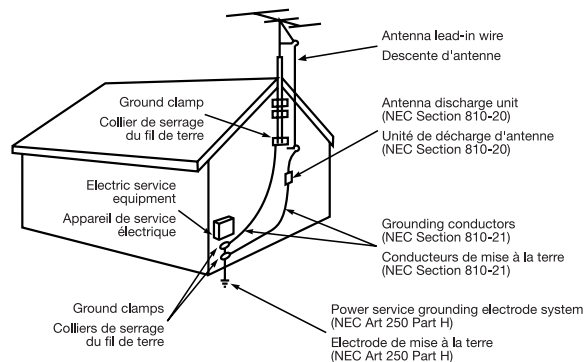

<b>Welcome to Toshiba .....</b>	<b>1</b>
Exploring your new TV .....	1
Selecting a location for the TV .....	1
<b>Connecting your TV .....</b>	<b>2</b>
Connecting a VCR.....	2
Connecting a cable converter box .....	3
Connecting a cable converter box and a VCR .....	3
Connecting a DVD/satellite receiver and a VCR .....	4
Connecting a DVD with ColorStream™ and a VCR .....	4
Connecting two VCRs .....	5
Connecting a camcorder .....	6
Connecting an audio amplifier .....	6
<b>Using the remote control .....</b>	<b>7</b>
Preparing the remote control for use.....	7
Installing the remote control batteries .....	7
Using the remote control with a VCR or a cable TV converter .....	7
Programming the remote control for use with a VCR or a cable TV converter .....	8
Programming the remote control to learn another remote control's operating codes .....	9
VCR code table .....	10
Cable TV converter code table .....	11
Learning about the remote control .....	12
<b>Setting up your TV .....</b>	<b>13</b>
Changing the on-screen display language .....	13
Selecting the antenna input .....	13
Using the ANT/VIDEO button .....	13
Adding channels to the TV's memory .....	14
Programming channels automatically .....	14
Adding and erasing channels manually .....	15
Changing channels .....	15
<b>Using the TV's features .....</b>	<b>16</b>
Adjusting the channel settings .....	16
Switching between two channels .....	16
Programming your favorite channels .....	16
Using the V-Chip .....	17
Selecting a PIN code .....	17
Blocking programs by ratings .....	18
Blocking unrated movies or programs .....	21
Blocking channels .....	21

Labeling channels .....	22
Watching picture-in-picture (PIP) .....	23
Switching the main and small pictures .....	24
Changing the position of the small picture .....	24
Freezing the small picture .....	25
Watching multi-window PIP .....	25
Using the preview mode .....	25
Using the favorite mode .....	26
Using the strobe mode .....	26
Adjusting the picture .....	27
Adjusting the picture quality .....	27
Selecting the color temperature .....	27
Adjusting the picture preferences .....	28
Watching video input .....	28
Displaying on-screen information .....	28
Setting the off-timer .....	28
Auto power off .....	28
Using the closed caption feature .....	29
Adjusting the sound .....	30
Muting the sound .....	30
Selecting stereo/SAP broadcasts .....	30
Adjusting the sound quality .....	31
Using the surround sound feature .....	31
Using the sub-bass system .....	32
Viewing the demonstration mode .....	33
Understanding the last mode memory feature .....	33
<b>Appendix .....</b>	<b>34</b>
Cleaning and care .....	34
Troubleshooting .....	34
Specifications .....	35
Limited United States warranty .....	36
Attention Canadian customers .....	37
<b>Index .....</b>	<b>38</b>

## Welcome to Toshiba

Congratulations! You have purchased one of the finest color TVs on the market. The goal of this manual is to guide you through setting up and operating your Toshiba TV as quickly as possible. Please make sure you've received the following items: TV, remote control, batteries, manual, registration card, and extended service plan literature. If you did not receive all of the items, or any of the items are damaged or broken, please contact your Toshiba dealer. In addition, you may need to purchase other audio or video cables to connect your equipment. See "Connecting your TV" on page 2 for more information.

Please read all the safety and operating instructions carefully before you begin.

## Exploring your new TV

You can operate your TV by using the buttons on the front panel or the remote control. The back panel provides all the terminal connections you will need to connect other equipment to your TV.

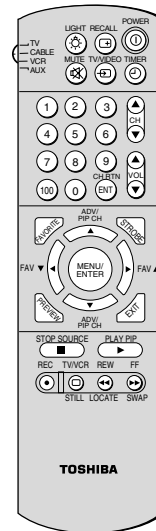
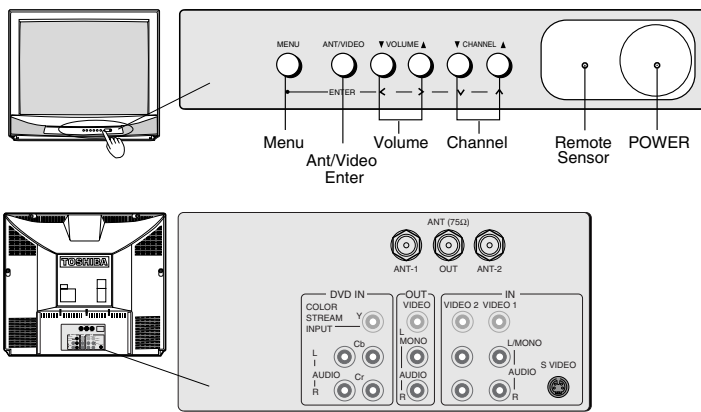

## Selecting a location for the TV

- Place the TV on the floor or on a sturdy platform in a location where light does not directly hit the screen.
- Place the TV far enough from the walls to allow proper ventilation. Inadequate ventilation may cause overheating, which may damage the TV.

The model number and serial number are on the back of your TV. Record these numbers in the spaces below. Refer to these numbers whenever you communicate with your Toshiba dealer about this TV.

Model number: CN32V71

Serial number: \_\_\_\_\_

### Caution:

The plug has one prong wider than the other and will fit only one way into a standard electrical outlet (120 volt AC, 60 Hz). If the plug does not fit into the outlet, try turning it around. If the plug still does not fit, the outlet is probably non-standard and must be replaced by a qualified electrician. **Do not tamper with the plug or try to force it into a non-standard outlet.**

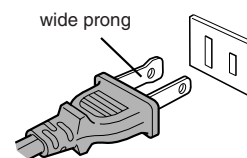

## Connecting your TV

If you haven't connected electronic equipment before, or you have been frustrated in the past, you may wish to read this section. (Cables are not supplied.)

- A coaxial cable is the standard cable that comes in from your antenna or cable converter box. Coaxial cables use "F" connectors.
- Audio and video cables are usually color coded according to use: yellow for video and red and white for audio. The red audio cable is for the stereo right channel, and the white audio cable is for the stereo (or mono) left channel. If you look at the rear panel of the TV, you will see that the terminals are color coded in the same manner as the cables.
- S-video cables provide better picture performance. S-video cables can only be used with S-video compatible components.
- ColorStream™ cables come in sets of three and provide the best picture performance. ColorStream cables can only be used with ColorStream compatible components.

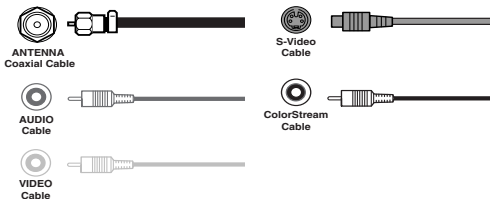

### Caution:

*Do not plug the TV in until you have finished connecting all of your equipment.*

## Connecting a VCR

This connection allows you to watch local channels and video programs, play or record on the VCR while watching TV, and to record from one channel while watching another channel.

You will need:

- one coaxial cable
- one pair of audio cables (only one cable for a mono VCR)
- one video cable

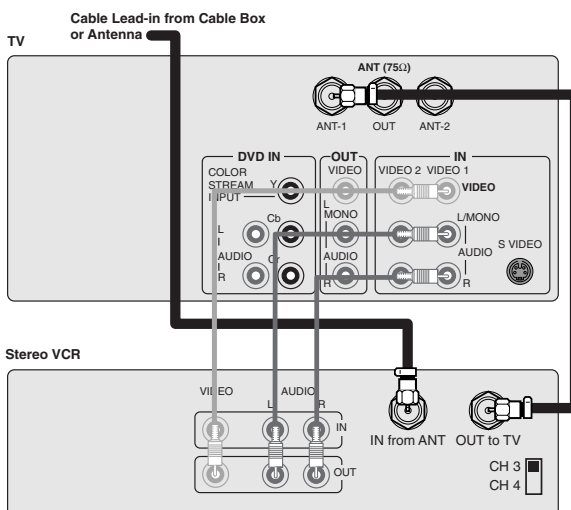

### Caution:

*If using a mono VCR, connect L/Mono to VCR Audio OUT using only one audio cable. If you have a S-VHS VCR, use the S-video connections and remove the video cable.*

*Do not connect the video cable and the S-video cable to Video-1 simultaneously.*



## Connecting a cable converter box

This connection allows you to watch cable and premium channels. You should keep your TV selected to ANT-1 so that you can use the TV features. When viewing premium channels, select ANT-2 and tune the TV to channel 3 or 4 (whichever channel is vacant in your area), then use the converter box to change channels. You will need two coaxial cables.

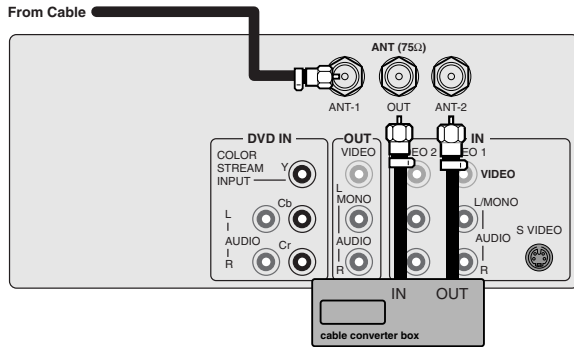

### Note:

When you use a converter box with your TV, there may be features that you cannot program using the remote control, such as labeling channels, blocking channels, and programming your favorite channels.

## Connecting a cable converter box and a VCR

This connection allows you to watch and record basic and premium cable channels, as well as watch videotapes. You should keep your TV selected to ANT-1 so that you can use the TV's features. When viewing premium channels or recording with the VCR, select ANT-2 and change the TV channel to 3 or 4 (whichever channel is vacant in your area), then use the converter box to change channels.

You will need:

- three coaxial cables
- one pair of audio cables (only one cable for a mono VCR)
- one video cable

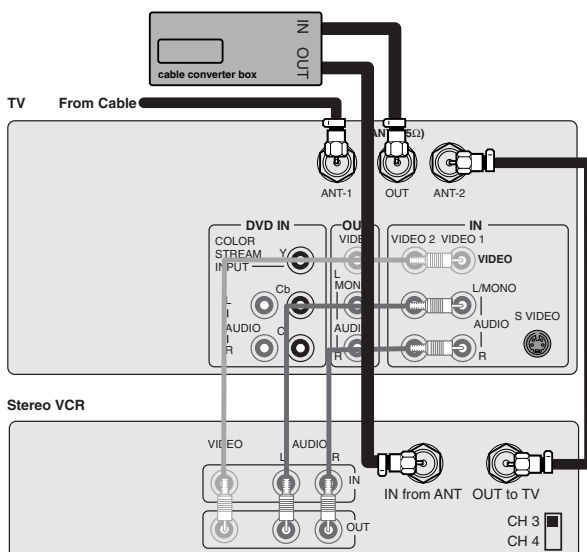

### Caution:

If you want to record one channel while watching another channel, a splitter (not included) must be added between the cable and ANT-1. One output of the splitter goes to ANT-1 and the second output is connected to IN on the cable converter box.

If you have a mono VCR, connect L/Mono to VCR Audio OUT using only one audio cable. If you have a S-VHS VCR, use the S-video connections and remove the video cable. Do not connect the video cable and the S-video cable to Video-1 simultaneously.

When you use a converter box with your TV, there may be features that you cannot program using the remote control, such as labeling channels, blocking channels, and programming your favorite channels.

## Connecting a DVD/satellite receiver and a VCR

This connection allows you to watch DVD/satellite, video and TV programs. You can record from the DVD/satellite receiver and TV, as well as record one TV channel while watching another channel.

You will need:

- one coaxial cable
- three pairs of audio cables (only one cable for a mono VCR)
- two video cables
- one S-video cable

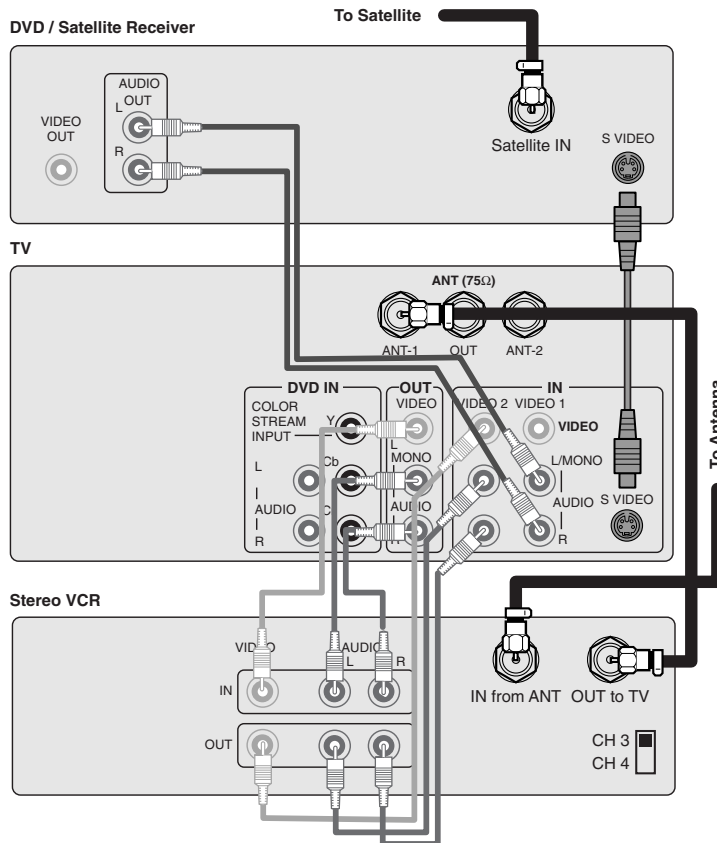

### Caution:

You can use a video cable instead of the S-video cable, but the picture quality will decrease. If you use a S-video cable between the TV and DVD/satellite receiver, make the audio connections only and remove the video connection.

Do not connect the video cable and the S-video cable to Video-1 simultaneously.

## Connecting a DVD with ColorStream™ and a VCR

This connection allows you to watch DVD, video or TV programs and to record DVD or TV programs. You can record from one source and watch a program from another source. Your TV is capable of using ColorStream (color difference). Connecting your TV to a ColorStream compatible DVD, such as a Toshiba DVD, can greatly enhance picture quality and performance.

You will need:

- one coaxial cable
- three pairs of audio cables (only one cable for a mono VCR)
- two video cables
- one set of ColorStream video cables

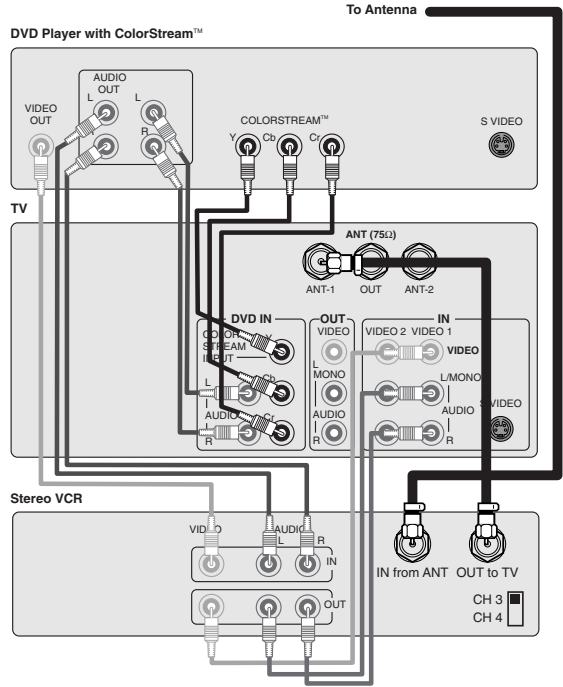

**Caution:**

To play from the DVD, the DVD and TV must use ColorStream connections. To record from the DVD, the DVD and TV must select Video.

**Connecting two VCRs**

This connection allows you to record from one VCR to another VCR while watching a video program. You will also be able to record from one TV channel while watching another channel.

You will need:

- one coaxial cable
- two pairs of audio cables (only two cables for mono VCRs)
- two video cables

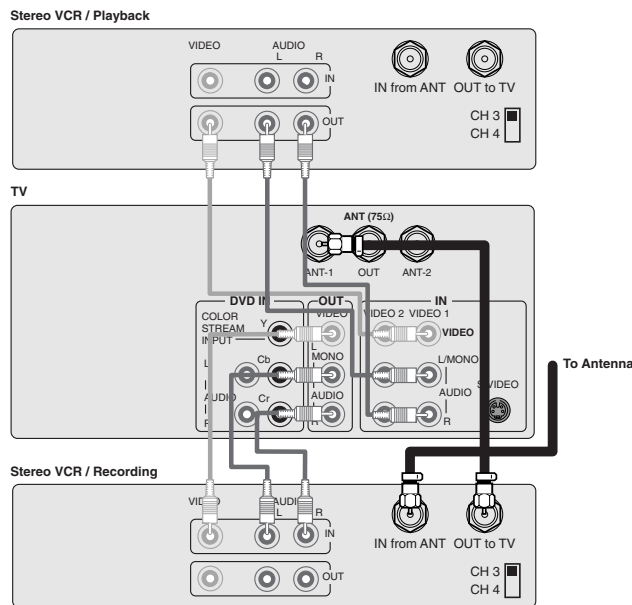

**Caution:**

If you are using a S-VHS VCR, use the S-video connections and remove the video cable. Do not connect the video cable and the S-video cable to Video-1 simultaneously.

## Connecting a camcorder

This connection allows you to watch video materials recorded on a camcorder.

You will need:

- one pair of audio cables
- one video cable

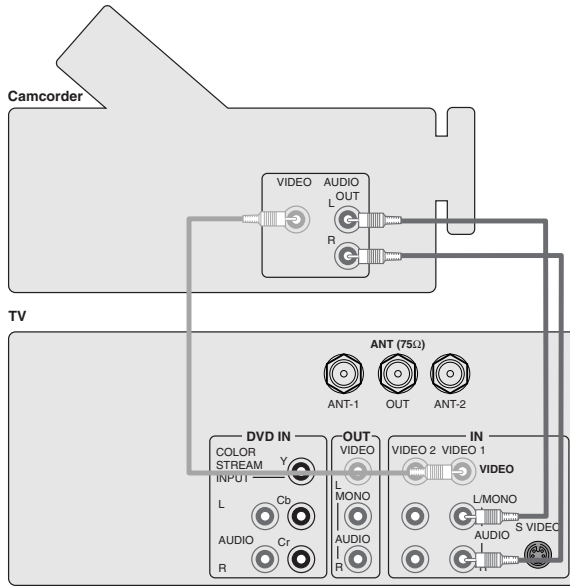

### Caution:

If you are using a S-VHS camcorder with a S-video output, connect this to the S-video input on the TV and remove the video cable. Do not connect the video cable and the S-video cable to Video-1 simultaneously.

## Connecting an audio amplifier

This connection allows you to use an audio amplifier to adjust the audio level. This also allows you to use external speakers.

To control the audio, turn on the TV and the stereo amplifier.

You will need one pair of audio cables.

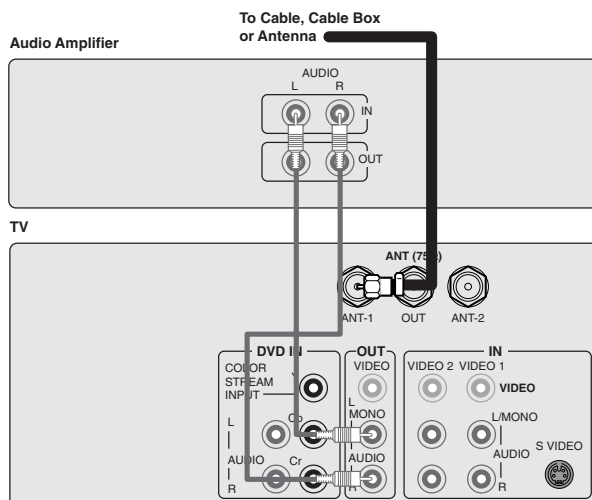

## Using the remote control

### Preparing the remote control for use

With the remote control, you can operate your TV, most VCR models, and cable TV converters together, even if they are different brands. If you will be using your TV with a Toshiba VCR, your remote control is already programmed and ready to use. If you own different brands of VCRs and/or converters, you first have to program your remote control. (See "Programming the remote control for use with a VCR or a cable TV converter" on page 8.)

### Installing the remote control batteries

To install the batteries:

1. Slide the battery cover off of the back of the remote control.

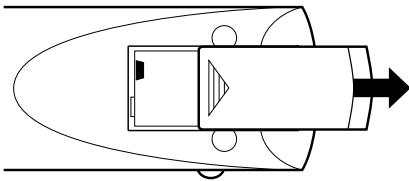

2. Install two "AA" size alkaline batteries. Match the + and - signs on the batteries to the signs on the battery compartment.

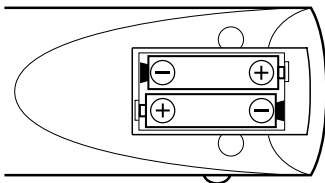

3. Slide the battery cover back on to the remote control until the lock snaps.

### Using the remote control with a VCR or a cable TV converter

To control a Toshiba VCR:

Set the TV/CABLE/VCR/AUX switch to the VCR position. The buttons shown to the right will then control the VCR. The rest of the buttons will operate the TV as usual.

#### Note:

This remote control's functions may or may not operate your VCR or cable TV converter. Refer to the owner's manuals supplied with the equipment to see which features are available. In addition, the original controllers may have features not available on this remote control. If you would like to continue to use these features, you may want to use the original remote control.

#### Caution:

- Dispose of your batteries in a designated disposal area. Do not throw your batteries into a fire.
- Do not mix battery types or combine used batteries with new ones.
- Remove dead batteries immediately to prevent battery acid from leaking into the battery compartment.
- If you do not intend to use the remote control for a long time, remove the batteries.

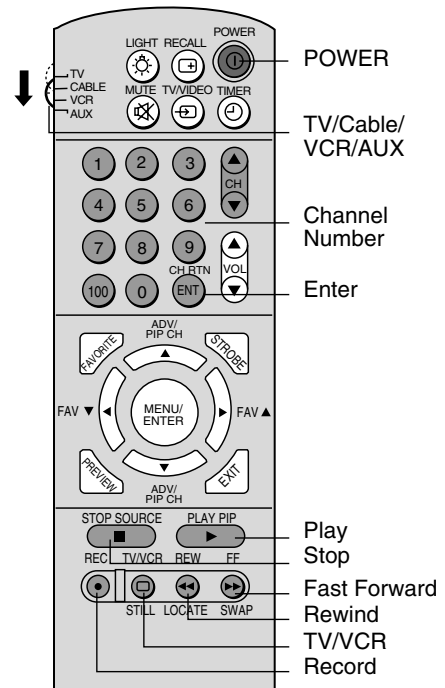

To control a cable TV converter:

Program the remote control to recognize the brand of your converter (see “Programming the remote control for use with a VCR or cable TV converter,” below). The shaded buttons shown on the right will control the cable TV converter.

Set the TV/CABLE/VCR/AUX switch to the CABLE position.

### Programming the remote control for use with a VCR or a cable TV converter

This remote control is pre-programmed to operate Toshiba VCRs. To use VCRs or cable converters other than Toshiba models, you must follow the steps below before you operate your remote control.

1. Refer to the “VCR code table” or “Cable TV converter code table” on pages 10-11 to find the number that corresponds to the brand name of your VCR or converter.

If more than one number is listed, try each one separately until you find the one that works.

2. If you are reprogramming the remote control to operate your:
  - **VCR**, set the TV/CABLE/VCR/AUX switch on the remote control to VCR.
  - **cable converter**, set the TV/CABLE/VCR/AUX switch on the remote control to CABLE.
3. Hold down the RECALL button while using the Channel Number buttons to enter the three-digit code number of your brand of VCR or converter.

The Program Indicator lights for one second when the programming is completed. When an error has occurred, the Program Indicator blinks. Press RECALL again to reset.

4. Point the remote control at the VCR or converter and press POWER to test the code number.

If the VCR or converter turns on, you have entered the right number.

If the VCR or converter does not respond to the remote control, you may have entered the wrong number. Repeat steps 1-4 with another code number.

For future reference, write down the code numbers you used:

VCR code \_\_\_\_\_

Cable code \_\_\_\_\_

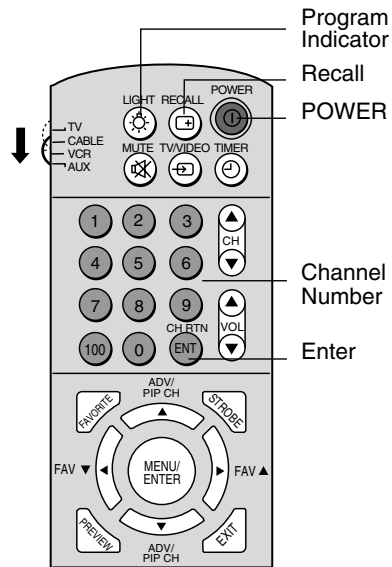

**Note:**

- Each time you replace the batteries, you must reprogram the remote control.
- Some newer VCRs are capable of working on either of two remote codes. These VCRs have a switch labeled “VCR1/VCR2.” If your VCR has this kind of switch, it may not respond to any of the code numbers for your VCR brand name. In this case, set the switch to the other position (VCR1 or VCR2) and reprogram the remote control.

## Programming the remote control to learn another remote control's operating codes

This remote control is capable of learning operating codes from most infrared remote control transmitters. If you set up the supplied remote control to learn the operating codes of one of your existing remote controls, then you will be able to use the supplied remote control to operate both your new Toshiba TV and your existing equipment. The 21 shaded buttons shown on the remote control illustration to the right may be used as learning buttons.

To learn the operating code of another remote control:

1. Set the TV/CABLE/VCR/AUX switch to the AUX position.
2. Place the supplied remote control and the remote control transmitter to be learned head to head, approximately 1 to 3 inches (3 to 8 cm) apart.

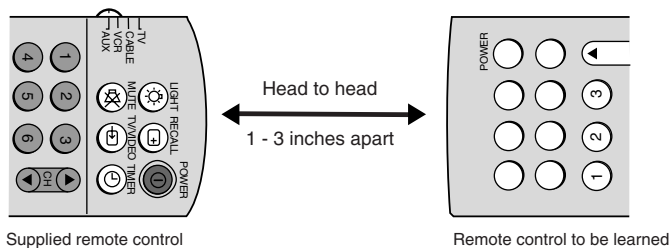

3. Press and hold RECALL and ENTER at the same time to start the learning mode.

The Learning Indicator will blink.

4. Hold down the Learning button you desire (choose one of the shaded buttons shown in the illustration to the right) on the supplied remote control until the Learning Indicator lights.
5. Hold down the button of the function to be learned on the other remote control transmitter for about three seconds until the learning indicator starts blinking.

If the Learning Indicator blinks rapidly, the supplied remote control cannot learn the operating code or an error has occurred. Repeat steps 4 and 5 above to try again.

6. Repeat steps 4 and 5 for each function you would like the supplied remote control to learn.
7. Press EXIT to leave the learning mode.
8. To verify that the supplied remote control learned the operating codes, try using it to operate the equipment. If the equipment does not operate as you expect it should, repeat steps 1 through 7. If necessary, try changing the distance between the two remote controls before attempting the learning process again.
9. Reset the TV/CABLE/VCR/AUX switch to the TV position to control the TV.

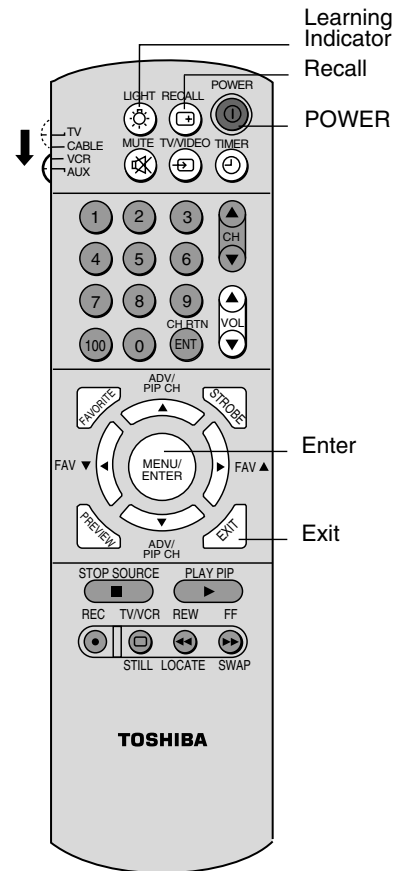

**VCR code table**

<b>Brand name</b>	<b>Code number</b>				
Adventura	019	Jensen	060	Quasar	054, 096
Aiko	297	JVC	027, 060, 086	Radio Shack	019, 056, 344
Aiwa	019	Kenwood	057, 060, 086	Radix	056
Akai	060,068,080,125, 261	KLH	091	Randex	056
American High	054	Kodak	054, 056	RCA	061, 079, 084, 096, 124, 125, 168, 221
Asha	259	Lloyd	019	Realistic	019, 054, 056, 065, 066, 067, 081, 085, 123, 259
Audiovox	056	Lloyd's	227	Ricoh	053
Beaumont	259	Logik	091	Runco	058
Bell & Howell	123	LXI	056	Samsung	064, 259
Brandt	206	Magnavox	054, 058, 100, 129, 168	Sanky	058, 067
Broksonic	140, 203, 230, 314, 380	Magnin	259	Sansui	060, 086
Calix	056	Marantz	054, 100	Sanyo	065, 066, 123, 259
Canon	054	Marta	056	Scott	062, 064, 140, 203, 229, 230, 231
Capehart	039	Masushita	054	Sears	054, 056, 061, 065, 066, 073, 085, 123, 124
Carver	100	MEI	054	Sharp	067, 081
CCE	091, 297	Memorex	019, 054, 056, 058, 065, 066, 067, 123, 259	Shintom	091
Citizen	056, 297	MGA	062, 080	Shogun	259
Colt	091	MGN Technology	259	Singer	091
Craig	056, 066, 091, 259	Minolta	061, 124	Sony	051, 052, 053, 054
Curtis Mathes	054, 060, 079	Mitsubishi	062, 080, 086, 094, 192, 233, 261	STS	061
Cybernex	259	Motorola	054, 067	Sylvania	019, 054, 062, 100, 129
Daewoo	039, 064, 297	MTC	019, 259	Symphonic	019, 344
Daytron	039	Multitech	019, 091	Tatung	060
Dynatech	019	Nad	077	Teac	019, 060
Electrohome	056	NEC	057, 059, 060, 069, 086	Technics	054,181
Electroponic	056	Nikko	056	Teknika	019, 054, 056, 071
Emerex	051	Noblex	259	Telefunken	060, 206
Emerson	019, 021, 056, 062, 080, 087, 140, 203, 227, 228, 230, 231, 297, 313, 314, 380, 498	Olympus	054	TMK	227, 259
Fisher	066, 073, 085, 123	Optimus	056, 067, 077, 123	Toshiba	062, 064, 085, 229, 231, 385
Fuji	052, 054	Optonica	081	Totevision	056, 259
Funai	019, 344	Orion	498	Unitech	259
Garrard	019, 344	Panasonic	054, 096, 181, 244	Vector	064
GE	054, 079, 084, 221	Penney	054, 056, 057, 059, 061, 073, 259	Vector Research	057, 059
Go Video	251, 298	Pentax	061, 084,124	Video Concepts	059, 064, 080
Goldstar	037, 056, 057	Philco	054	Videosonic	259
Gradiente	019	Philips	054, 081, 100, 129	Wards	019, 054, 061, 066, 067, 081, 091, 168, 231, 259
Harley Davidson	019	Pilot	056	XR-1000	019, 054, 091
Harman/Kardon	057, 094	Pioneer	077, 086	Yamaha	057
Harwood	087, 091	Portland	039	Zenith	052, 053, 058
Headquarter	065	Protec	091		
HI-Q	066	Pulsar	058		
Hitachi	060, 061, 084, 124, 254	Quarter	065		
		Quartz	065		



## Cable TV converter code table

Brand name	Code number		
ABC	020, 022, 026, 027, 030, 032, 033, 036, 066	Samsung	059, 163
Antronix	041	Scientific Atlanta	025, 027, 036, 296
Archer	041, 058, 172	Signal	034, 059
Belcor	075	Signature	030
Cable Star	075	SL Marx	059
Cabletenna	041	Sprucer	040
Cableview	041	Standard	
Century	172	Components	174
Citizen	172	Starcom	022, 034, 066
Colour Voice	044, 050	Stargate	034, 059
Comtronics	059, 079	Starquest	034
Contec	038	Sylvania	020
Dae Ryung	027	Televue	059
Eastern	021	Texscan	020
Focus	419	Tocom	031, 032, 078
Garrard	172	Toshiba	019
GC Electronics	035, 075	Tusa	034
Gemini	034, 089	Unika	041, 172
General Instrument	030, 295	United Artists	026
GoldStar	059, 163	United Cable	022
Hamlin	028, 039, 053, 278, 292	Universal	041, 058, 075, 096, 172, 210
Hitachi	030	Viewstar	046, 079, 230
Hytex	026	Zenith	019
Jasco	172	Zentek	419
Jerrold	022, 030, 031, 033, 034, 043, 066, 295		
Macom	052		
Magnavox	046		
Memorex	019		
Movie Time	175		
NSC	089, 175		
Oak	026, 038, 267		
Panasonic	019, 040, 126		
Paragon	019		
Philips	044, 046, 047, 048, 049, 050, 172		
Pioneer	042, 163, 552		
Popular Mechanics	419		
Pulsar	019		
RCA	040		
Recoton	419		
Regal	039, 278, 292		
Regency	021		
Rembrandt	030, 089		
Runco	019		

Welcome to  
Toshiba

Connecting  
your TV

Using the  
Remote Control

Setting up  
your TV

Using the TV's  
Features

Appendix

Index

## Learning about the remote control

**POWER** turns the TV on and off (pages 8 and 28)

**Timer** sets the TV to go off at a set time (page 28)

**TV/Video** selects video input source (page 28)

**Channel ▲ ▼** cycles through programmed channels (page 14)

**TV/Cable/VCR/AUX** switches between TV, Cable, VCR and AUX [Auxiliary] (page 8)

**Channel Numbers** allow direct access to channels (page 15)

**Volume ▲ ▼** adjusts the volume level

**Channel Return** returns to the last viewed channel (page 16)

**Menu** allows access to programming menus (page 13)

**PIP Channels ▲ ▼** cycles through PIP channels (page 23)

**Favorite Channels ▲ ▼** cycles through favorite channels (page 16)

**Enter** sets programmed menu information (pages 16-23 and 26)

**Exit** exits programming menus (page 13)

**PIP Functions** allow access to PIP functions (page 23)

**STOP** press to stop a videotape

**REC** press to start recording a videotape

**PLAY** press to play a videotape

**FF** press to fast forward a videotape

**RR** press to rewind a videotape

**TV/VCR** toggles between TV and VCR when viewing while recording

**Preview** starts the multi-window channel scan of all channels in memory (page 25)

**Favorite** starts the multi-window channel scan of favorite channels (page 26)

**Strobe** starts the multi-window strobe mode (page 26)

**Mute** mutes the sound (page 20, 30)

**Light** press to back-light buttons for five seconds

**Recall** displays screen information (page 18-19, 22 and 28)

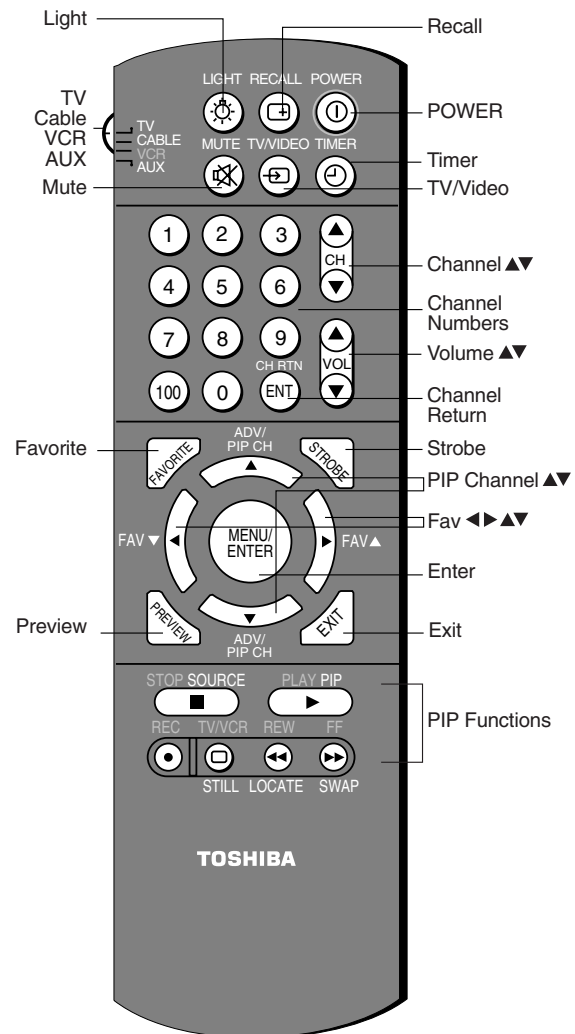

## Setting up your TV

After you've installed the batteries and programmed the remote control, you need to set some preferences on the TV using the menu. You can access the menu with the buttons on your TV or by using the remote control.

- When you make a menu selection, your changes occur immediately. You do not have to press MENU or EXIT to see your changes.
- After fifteen seconds, the menu screen will automatically disappear if you do not make a selection. Your changes will still be saved.
- When you are finished programming the menus, press EXIT.

## Changing the on-screen display language

You can choose from three different languages (English, French and Spanish) for the on-screen displays. Adjustment menus and messages will appear in the language of your choice.

To select a language:

1. Press MENU, then press ◀ or ▶ until the SET UP menu appears.

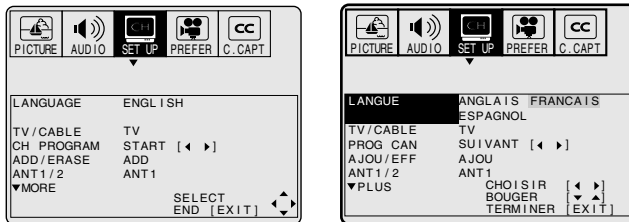

2. Press ▲ or ▼ to highlight LANGUAGE.
3. Press ◀ or ▶ to highlight your desired language.

## Selecting the antenna input

You can connect to two different signal sources by choosing the antenna input (ANT 1 or ANT 2).

To select the antenna input:

1. Press MENU, then use ◀ or ▶ to highlight the SET UP menu.
2. Press ▲ or ▼ to highlight ANT 1/2.

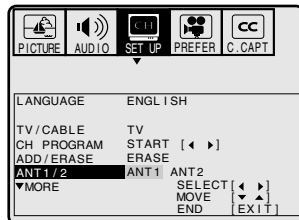

3. Press ◀ or ▶ to highlight either ANT 1 or ANT 2, depending on the antenna terminal you wish to use.

## Using the ANT/VIDEO button

You can monitor or change the signal source that is connected to the TV. By pressing the ANT/VIDEO button on your TV, you can select the VIDEO 1, VIDEO 2, ColorStream, ANT 1 or ANT 2 mode. The signal source you are currently connected to will be displayed in purple.

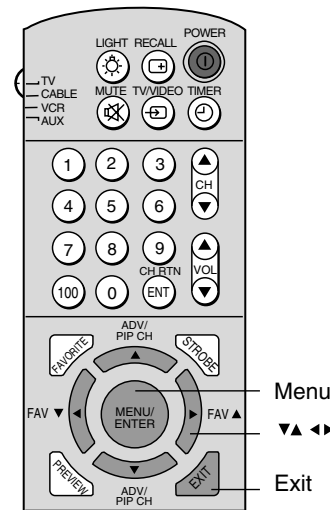
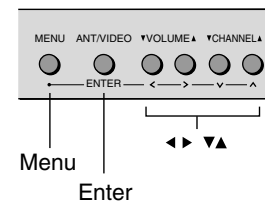

To select the antenna input:

1. Press the ANT/VIDEO button. The signal source you are connected to is displayed in purple.

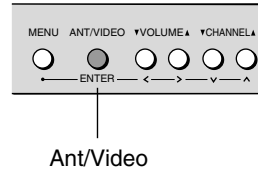
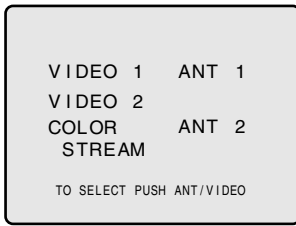

2. Press the button until ANT 1 or ANT 2 is displayed in purple, indicating the antenna terminal you wish to use.

## Adding channels to the TV's memory

Your TV will stop on specific channels that are stored in the TV's channel memory when you press Channel ▲ or ▼. Use the steps below to set all active channels in your area automatically.

### Programming channels automatically

Your TV can automatically detect all active channels and store them in its memory. After the TV has stored the channels in its memory, you can erase channels or add your favorite channels. If you use both ANT-1 and ANT-2 terminals, you must program channels for each input source.

To add channels:

1. Press MENU, then press ◀ or ▶ to highlight the SET UP menu.
2. Press ▲ or ▼ until the TV/CABLE selection is highlighted.
3. Press ◀ or ▶ to highlight either TV or CABLE, depending on which you use.

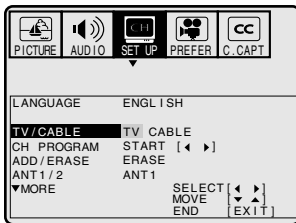

If you use an antenna, choose TV.

If you use cable, choose CABLE.

4. Press ▼ to select CH PROGRAM.
5. Press ◀ or ▶ to start channel programming. The TV will automatically cycle through all the TV or Cable channels (depending on which you selected), and store all active channels in the channel memory.

While the TV is cycling through the channels, the message "Programming Now Please Wait" appears.

6. When channel programming is complete, the message "Completed (channel or cable number)" appears.
7. Press Channel ▲ or ▼ to view the programmed channels.

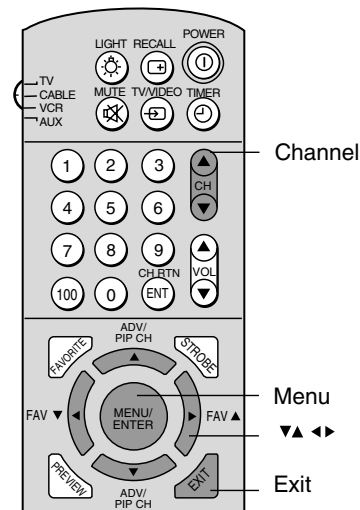

## Adding and erasing channels manually

After you've programmed the channels, you can add or erase specific channels.

To add or erase channels:

1. Select the channel you want to add or erase using Channel ▲ or ▼. If adding channels, you must select the channel to add by using the Channel Number buttons.
2. Press MENU, then press ◀ or ▶ to highlight the SET UP menu.
3. Press ▲ or ▼ to highlight ADD/ERASE.

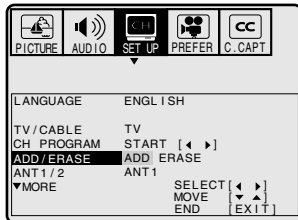

4. Press ◀ or ▶ to select ADD or ERASE, whichever function you want to perform.
5. Repeat steps 1-4 for other channels you want to add or erase.

## Changing channels

To change the channel, you can:

- change the programmed channels using the remote control
- select a channel directly using the remote control
- scan the channels using the TV buttons

To change to the next programmed channel:

Press Channel ▲ or ▼ on the TV or remote control.

To change to a specific channel (programmed or unprogrammed):

Press the Channel Number buttons (0-9 and 100).

For example, to select channel 125, press the 100 button, the 2 button, and the 5 button.

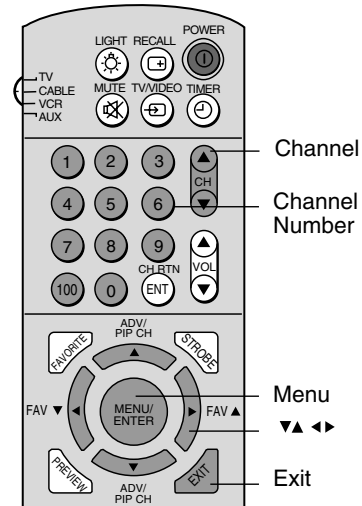
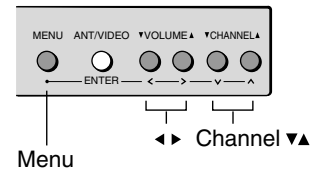

# Using the TV's features

## Adjusting the channel settings

### Switching between two channels

You can switch between two channels without entering an actual channel number each time.

To switch between two channels:

1. Select the first channel you want to view.
2. Select a second channel with the Channel Number buttons (0-9, 100).
3. Press CH RTN. The previous channel will be displayed.

Each time you press CH RTN, the TV will switch back and forth between the two channels.

### Programming your favorite channels

You can preset up to 9 of your favorite channels using the Favorite Channel Programming feature. Because this feature scans through only your favorite channels, it allows you to skip other channels you do not normally watch.

You can still use Channel ▲▼ to scan through all the channels you programmed in the TV's memory.

To program your favorite channels:

1. Select a channel you want to program.
2. Press MENU, then press ◀ or ▶ to highlight the SET UP menu.
3. Press ▲ or ▼ to highlight FAVORITE CH.

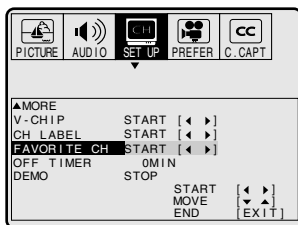

4. Press ◀ or ▶ to display the FAVORITE CH menu. SET/CLEAR will be highlighted.

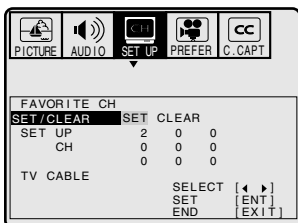

5. Press ◀ or ▶ to highlight SET and press ENTER.
6. Press EXIT to clear the screen.
7. Repeat steps 1 through 6 for up to 8 other channels.

To select your favorite channels:

Press the FAV ▲▼ buttons on the remote control to select your favorite channels.

The FAV ▲▼ buttons will not work until you have programmed your favorite channels.

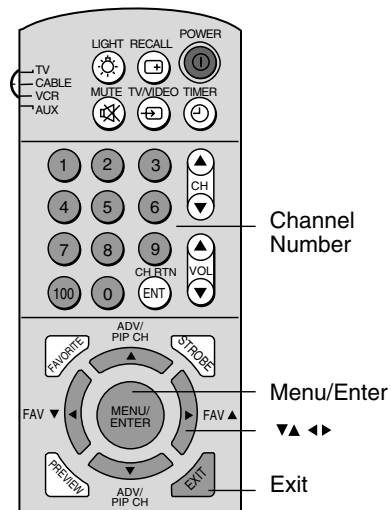
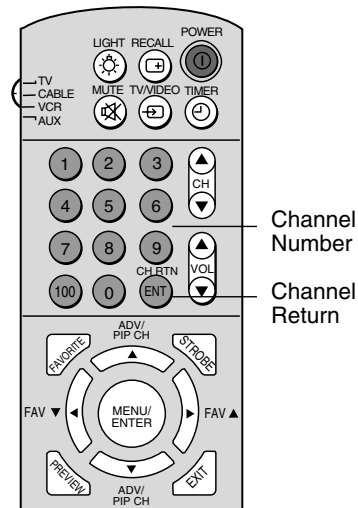

To clear your favorite channels:

1. Select a channel you want to clear.
2. Press MENU, then press ◀ or ▶ to highlight the SET UP menu.
3. Press ▲ or ▼ to highlight FAVORITE CH.
4. Press ◀ or ▶ to display the FAVORITE CH menu. SET/CLEAR will be highlighted.

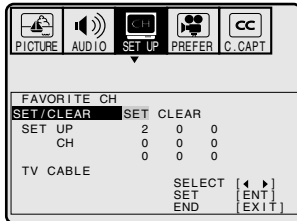

5. Press the ◀ or ▶ to highlight CLEAR.

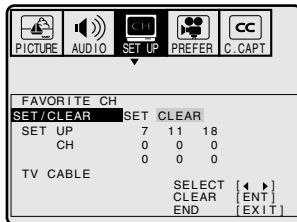

6. Press ENTER until "0" replaces the channel number you want to erase.
7. Press EXIT to clear the screen.
8. Repeat steps 1 through 6 for the other channels.

## Using the V-Chip

You can prevent others from viewing certain programs or channels by using the V-Chip feature.

### Selecting a PIN code

Before you can block programs and channels, though, you must select a personal identification number (PIN) code. The PIN code you select prevents others from changing the rating limits you set.

To select your PIN code and access the V-Chip menus:

1. Press MENU, then press ◀ or ▶ to highlight the SET UP menu.
2. Press ▲ or ▼ to highlight V-CHIP.

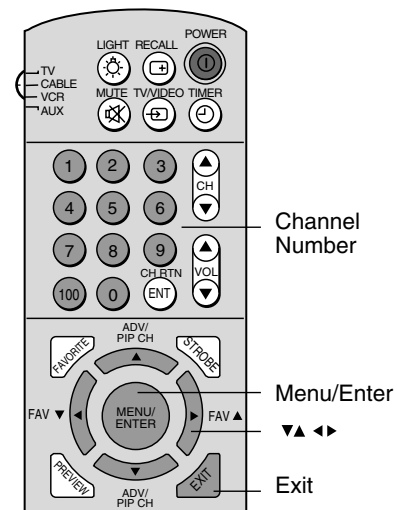
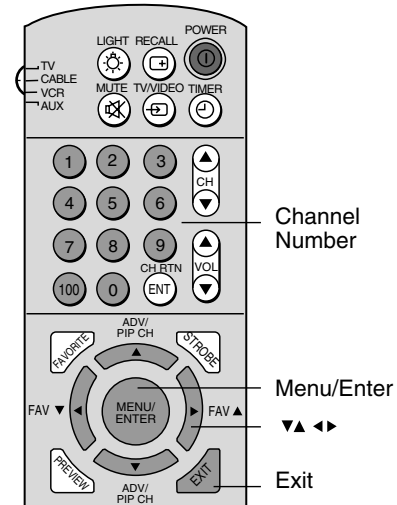
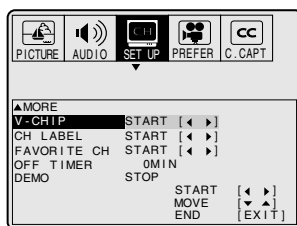

- Press to ◀ or ▶ display the V-CHIP menu.

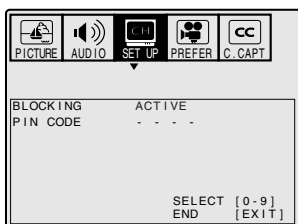

- Use the Channel Number buttons (0-9) to enter your PIN code. If you are accessing the V-Chip menus for the first time, select a four-digit number to be your PIN code. Press ENTER. The BLOCKING menu appears.

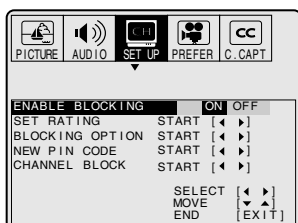

- You may now enable blocking — “Blocking programs by ratings” (see below), “Blocking channels” (see page 21), “To change your PIN code” (below) or “Blocking unrated movies or programs” (see page 21).

To change your PIN code:

- Press MENU, then press ◀ or ▶ to highlight the SET UP menu.
- Press ▲ or ▼ to highlight V-CHIP.
- Press ◀ or ▶ to display the V-CHIP menu.
- Use the Channel Number buttons (0-9) to enter your PIN code. If you are accessing the V-Chip menus for the first time, select a four-digit number to be your PIN code. Press ENTER. The BLOCKING menu appears.
- Press ▲ or ▼ to highlight NEW PIN CODE and press ◀ or ▶ to display the NEW PIN CODE menu.
- Use the Channel Number buttons (0-9) to enter a new code. Press ENTER.
- Press EXIT to return to normal viewing.

**Note:**

If you forget your PIN code, press RECALL four times within five seconds from the V-CHIP menu. This allows you to proceed to the BLOCKING menu and reset your PIN code.

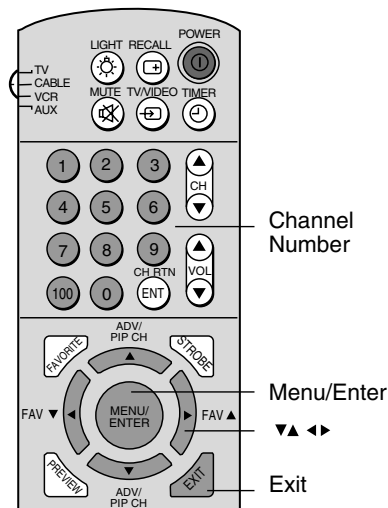

**Blocking programs by ratings**

The Motion Picture Association of America (MPAA) uses a rating system to qualify motion picture content. Television broadcasters employ a rating system to qualify the content of television programs, as well. The MPAA, Youth TV and TV ratings work with the V-Chip feature and allow you to block out programming above the rating limits you determine.

Using the TV's Features



## MPAA Ratings

- X** For adults only.
- NC17** Not intended for anyone 17 or under.
- R** Restricted. Under 17 requires an accompanying parent or adult guardian.
- PG13** Parents strongly cautioned. Some material may be inappropriate for children under 13.
- PG** Parental guidance suggested. Some material may not be appropriate for children.
- G** General audience. Appropriate for all ages.

## Youth TV Ratings

- Y7, Y7 FV** Directed to older children. This program is designed for children age 7 and above. For those programs where fantasy violence may be more intense or more combative than other programs in this category, such programs are designated TV-Y7-FV.
- Y** All children. This program is designed to be appropriate for all children.

## TV Ratings

- MA** Mature audience only. This program is specifically designed to be viewed by adults and therefore may be unsuitable for children under 17.
- Language Crude or indecent language.
- Sex Explicit sexual activity.
- Violence Graphic violence.
- 14** Parents strongly cautioned. This program contains some material that many parents would find unsuitable for children under 14 years of age.
- Dialog Intensely suggestive dialog.
- Language Strong, coarse language.
- Sex Intense sexual situations.
- Violence Intense violence.
- PG** Parental guidance suggested. This program contains material that parents may find unsuitable for younger children.
- Dialog Some suggestive dialog.
- Language Infrequent coarse language.
- Sex Some sexual situations.
- Violence Moderate violence
- G** General audience. Most parents would find this program suitable for all ages.
- No DLSV** Programs without any Dialog, Language, Sex or Violence ratings.

### **Note:**

*To see the rating of the program you are viewing, press **RECALL** at any time.*

To use the V-Chip to block programs by rating:

1. Press MENU, then press ◀ or ▶ to highlight the SET UP menu.
2. Press ▲ or ▼ to highlight V-CHIP.
3. Press ◀ or ▶ to display the V-CHIP menu.
4. Use the Channel Number buttons (0-9) to enter your PIN code. If you are accessing the V-Chip menus for the first time, select a four-digit number to be your PIN code. Press ENTER. The BLOCKING menu appears.

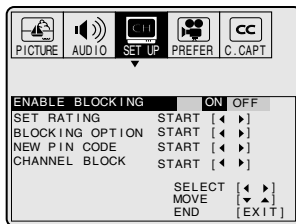

5. Press ▲ or ▼ to highlight ENABLE BLOCKING.
  - Press ◀ or ▶ to highlight ON to enable the V-Chip and program blocking by rating.
  - Press ◀ or ▶ to highlight OFF to disable the V-Chip and program blocking by rating.
6. Press ▲ or ▼ to highlight SET RATING. Then, press ◀ or ▶ to display the SET RATING menu.

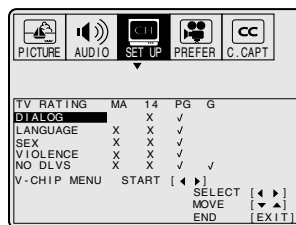
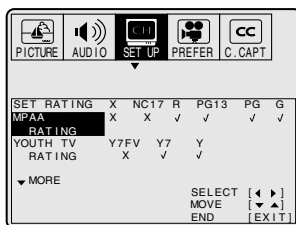

7. Press ▲ or ▼ to highlight MPAA Rating, Youth TV Rating or individual TV Ratings.
8. Press ◀ or ▶ to select the ratings which will be blocked. Blocked ratings are signified by a red "X." Unblocked ratings are signified by a green "✓." As you block ratings, all ratings higher than the ones you select are blocked, as well. For example, if you choose to block the MPAA rating R, the higher ratings, NC17 and X, are automatically blocked, too.
9. When you are done selecting the ratings to be blocked, press EXIT to return to normal viewing.

When you try to view a program with a ratings block, a message will appear listing the program's ratings. The program can still be viewed if you press MUTE and then enter your PIN code to temporarily bypass the block.

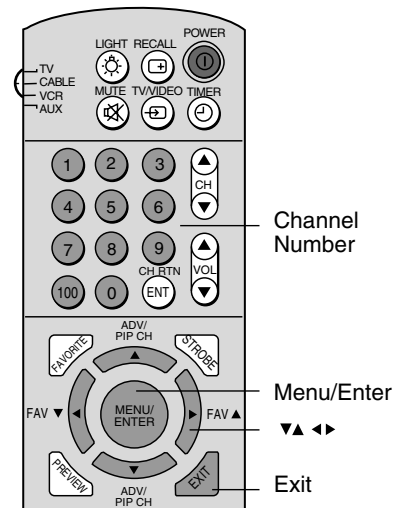

**Note:**

Not all programs are rated. To block programs or movies that are unrated, see "Blocking unrated movies or programs," page 21.

## Blocking unrated movies or programs

Some movies and programs are not rated. You can block these movies and programs using the V-Chip.

To block unrated movies or programs:

1. Press MENU, then press ◀ or ▶ to highlight the SET UP menu.
2. Press ▲ or ▼ to highlight V-CHIP.
3. Press ◀ or ▶ to display the V-CHIP menu.
4. Use the Channel Number buttons (0-9) to enter your PIN code. If you are accessing the V-Chip menus for the first time, select a four-digit number to be your PIN code. Press ENTER. The BLOCKING menu appears.
5. Press ▲ or ▼ to highlight BLOCKING OPTION.
6. Press ◀ or ▶ to display the BLOCKING OPTION menu.
7. Press ▲ or ▼ to highlight MPAA UNRATED.
  - Press ◀ or ▶ to highlight ON to block unrated movies.
  - Press ◀ or ▶ to highlight OFF to unblock unrated movies.
8. Press ▲ or ▼ to highlight TV NONE RATING.
  - Press ◀ or ▶ to highlight ON to block programs with a rating of "TV NONE."
  - Press ◀ or ▶ to highlight OFF to unblock programs with a rating of "TV NONE."
9. Press EXIT to return to normal viewing.

### Note:

Blocking television programs with a rating of "TV NONE" may block emergency messages.

## Blocking channels

You can also choose to block individual channels. These channels will not be seen regardless of the ratings of their programming. You can choose to block up to four TV channels and four cable channels.

To block channels:

1. Use the Channel Number Buttons (0-9) display the television channel you wish to block.
2. Press MENU, then press ◀ or ▶ to highlight the SET UP menu.
3. Press ▲ or ▼ to highlight V-CHIP and then press ◀ or ▶ to display the V-CHIP menu.
4. Use the Channel Number buttons (0-9) to enter your PIN code. If you are accessing the V-Chip menus for the first time, choose a four-digit number to be your PIN code. Press ENTER.
5. Press ▲ or ▼ to highlight CHANNEL BLOCK and then press ◀ or ▶ to display the CHANNEL BLOCK menu.

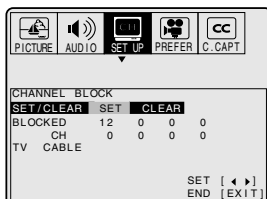

6. Press ◀ or ▶ to:
  - SET the channel as one to be blocked.
  - CLEAR all channels from the list of blocked channels.
7. Press ENTER.

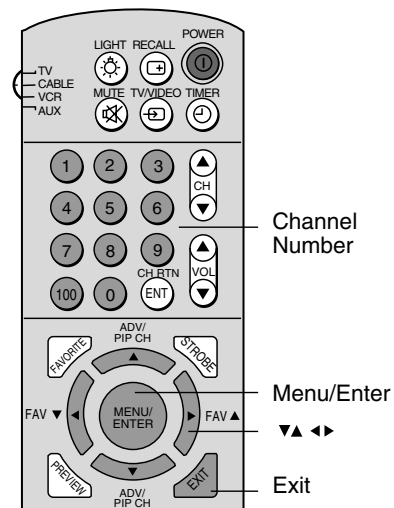

- Repeat steps 1 through 7 to block other channels. When you are finished blocking channels, press EXIT to return to normal viewing.

If you try to display a blocked channel, the TV will not display it, but will display the nearest unblocked channel.

To unblock channels:

- Press MENU, then press ◀ or ▶ to highlight the SET UP menu.
- Press ▲ or ▼ to highlight V-CHIP and then press ◀ or ▶ to display the V-CHIP menu.
- Use the Channel Number buttons (0-9) to enter your PIN code. If you are accessing the V-Chip menus for the first time, choose a four-digit number to be your PIN code. Press ENTER.
- Press ▲ or ▼ to highlight CHANNEL BLOCK and then press ◀ or ▶ to display the CHANNEL BLOCK menu.
- Press ◀ or ▶ to highlight CLEAR and clear all channels from the list of blocked channels. Press ENTER.
- Press EXIT to return to normal viewing.

**Note:**

After programming CHANNEL BLOCK, change channels before turning off the television.

### Labeling channels

Channel labels will appear over the channel number display each time you turn on the TV, select a channel, or press RECALL. You can choose any four characters to identify the channels.

To create channel labels:

- Select a channel you want to label.
- Press MENU then press ◀ or ▶ until the SET UP menu appears.
- Press ▲ or ▼ to highlight CH LABEL.

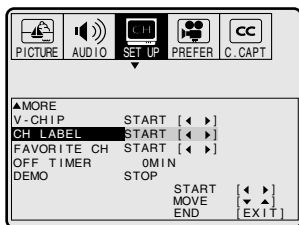

- Press ◀ or ▶ to display the CH LABEL menu. SET/CLEAR will be highlighted.
- Press ◀ or ▶ to highlight SET.

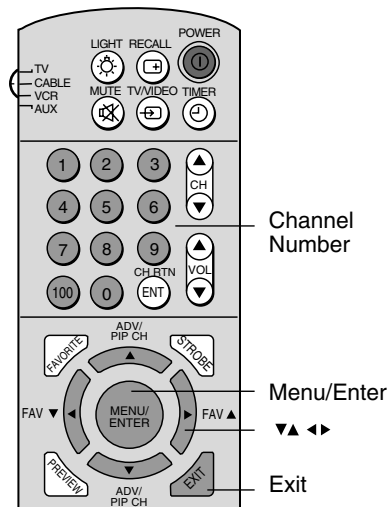
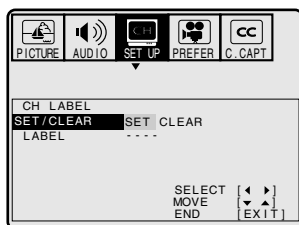

Using the TV's Features

- Press ▼ to highlight LABEL.

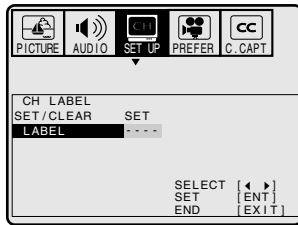

- Assign the label to the channel. Press ◀ or ▶ to enter a character in the first space. Press the button repeatedly until the character you want appears on the screen. Press ENTER.
- Repeat step 7 to enter the rest of the characters.  
If you would like a blank space in the label name, you must choose an empty space from the list of characters. Otherwise, a dash will appear in that space.
- Press EXIT to clear the screen.
- Repeat steps 1 through 8 for other channels. You can assign up to 32 labels.

To erase channel labels:

- Select a channel with a label.
- Press MENU then press ◀ or ▶ until the SET UP menu appears.
- Press ▲ or ▼ to highlight CH LABEL.
- Press ◀ or ▶ to display the CH LABEL menu.  
SET/CLEAR will be highlighted.
- Press ◀ or ▶ to highlight CLEAR.
- Press ENTER.
- Repeat steps 1 through 6 to erase other channel labels.

## Watching picture-in-picture (PIP)

The picture-in-picture (PIP) feature allows you to watch two pictures at the same time. The smaller picture can be a TV broadcast or come from an external source, such as a VCR.

To display a TV broadcast as a small picture:

- Turn on the TV and select the program you want to watch.
- Press the PIP button once to display a small picture. A window 1/9 the size of the screen will appear. Press PIP a second time to display a 1/16 size window.

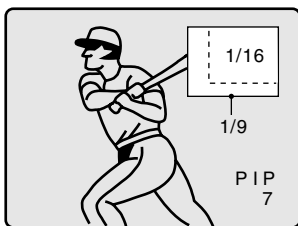

- Press PIP CH ▲▼ to choose the program you want to be displayed as a small picture.

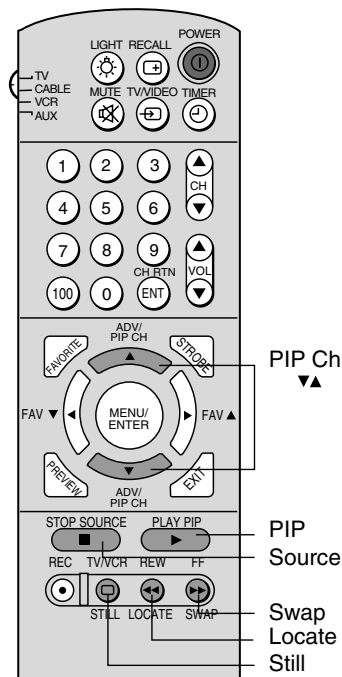
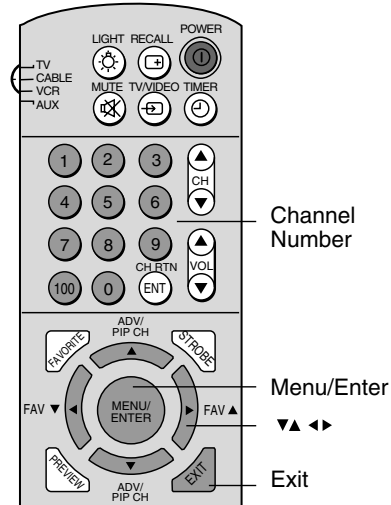

To display a picture from an external source as a small picture:

1. Make sure you have connected the external source equipment properly. For more information, see the "Connecting your TV" on page 2.
2. Turn on the TV and select the program you want to watch.
3. Press the PIP button once to display a small picture. A window 1/9 the size of the screen will appear. Press PIP a second time to display a 1/16 size window.
4. Press SOURCE repeatedly to select the input source (VIDEO 1 or VIDEO 2) for the small picture. The selected source will be displayed in purple. ColorStream cannot be selected.

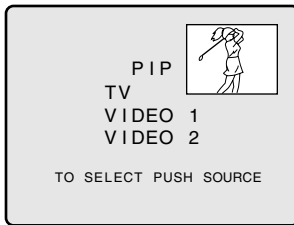

To turn PIP off:

Press PIP once or twice, depending on the size of the small picture screen you selected.

### Switching the main and small pictures

Press SWAP while you are using the PIP feature to switch the main and small pictures. The main and small pictures will switch each time you press the SWAP button.

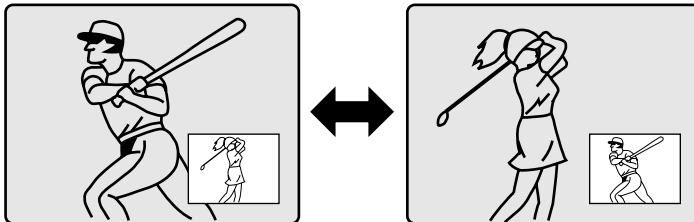

### Changing the position of the small picture

Press LOCATE repeatedly while you are watching a small picture. The display position of the small picture will change in the following order:

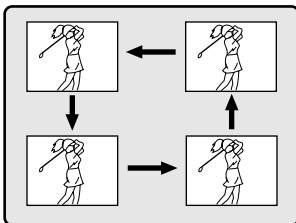

### Note:

PIP cannot be turned on when the ColorStream input is being viewed.

You cannot display the signal sources input through the ANT-2 terminal as a small picture.

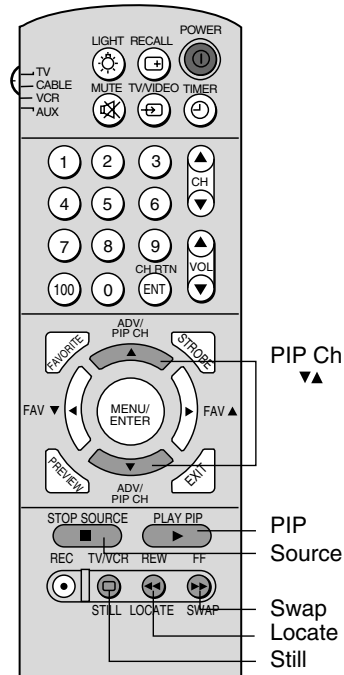

### Freezing the small picture

Press STILL while you are watching a small picture. The small picture will become a still picture. To return to the moving picture, press STILL again.

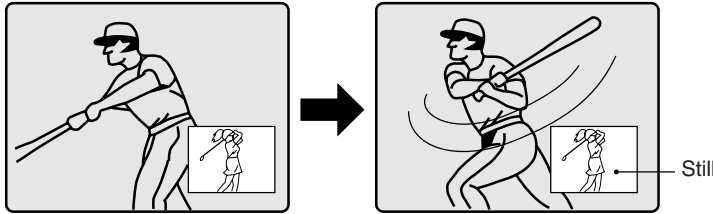

### Watching multi-window PIP

The multi-window feature provides two channel search modes. The first mode is Preview, which scans the channels that are programmed in the TV memory. The second mode is Favorite, which scans the favorite channels you have programmed in the TV memory.

The multi-window feature also provides the Strobe mode, which allows you to view a segment of a program and freeze it in nine successive views.

### Using the preview mode

Before you can use the Preview mode, you must first program the channels into the TV's memory (see page 14, Programming channels automatically).

Once the channels are programmed into memory, when you view the channels in the Preview mode, the TV cycles through all of the programmed channels and shows a few seconds of each channel's programming, then freezes the image and moves onto the next channel in a continuous cycle. The channel numbers appear above each PIP window. The LOCATE, SWAP, PIP CHANNEL ▲▼, SOURCE and STILL buttons do not work with this PIP feature.

To view the Preview mode:

Press PREVIEW.

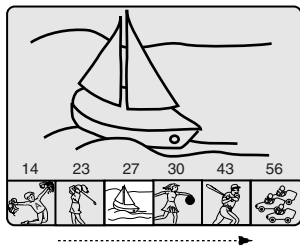

To turn the Preview mode off:

Press PREVIEW again.

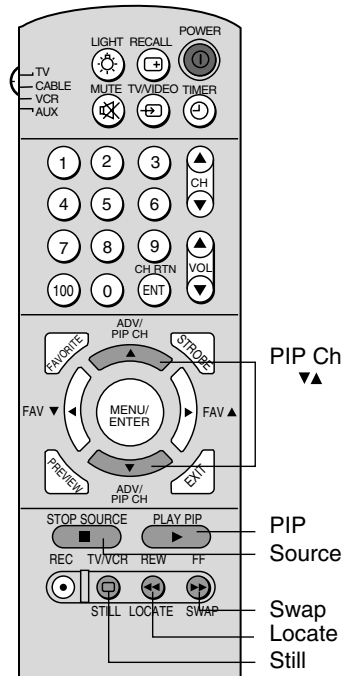

**Note:**

The Preview, Favorite, and Strobe modes cannot be turned on when the ColorStream input is being viewed.

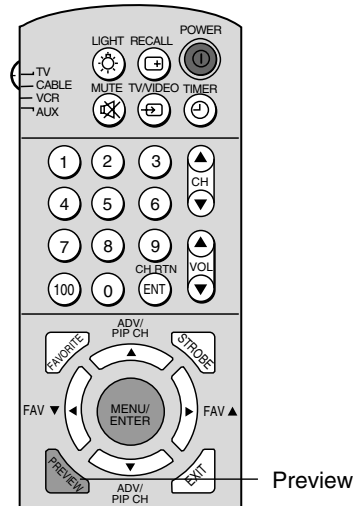

## Using the favorite mode

Before you can use the Favorite mode, you must first program your favorite channels into the TV's memory (see page 16, Programming your favorite channels).

Once your favorite channels are programmed into memory, when you view the channels in the Favorite mode, the TV cycles through up to nine programmed favorite channels and shows a few seconds of each channel's programming, then freezes the image and moves onto the next channel in a continuous cycle. The channel numbers appear above each PIP window. The LOCATE, SWAP, PIP CHANNEL ▲▼, SOURCE and STILL buttons do not work with this PIP feature.

To view the Favorite mode:

1. Press FAVORITE.

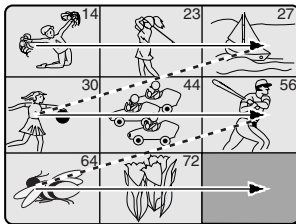

The TV displays up to nine favorite channels.

2. Press ◀ or ▶ to highlight the channel you would like to view and press ENTER.

The favorite channel you selected will appear.

To turn the Favorite mode off:

Press FAVORITE again.

## Using the strobe mode

The Strobe mode allows you to view a segment of a program and freeze it in nine successive views. For example, if you recorded a sports program, you could use the Strobe mode to review a decisive moment. This mode is most useful when viewing a program recorded on a videotape, but the Strobe mode will also function during normal TV viewing.

To view the Strobe mode:

Press STROBE.

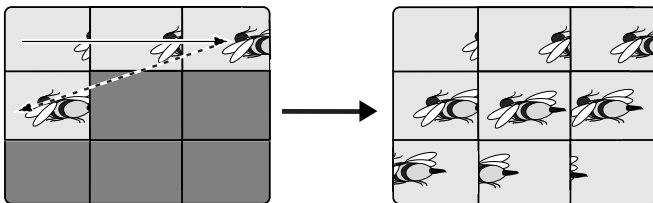

The Strobe mode will display nine successive frames of the program currently playing on the TV.

To cancel the Strobe mode:

Press STROBE again.

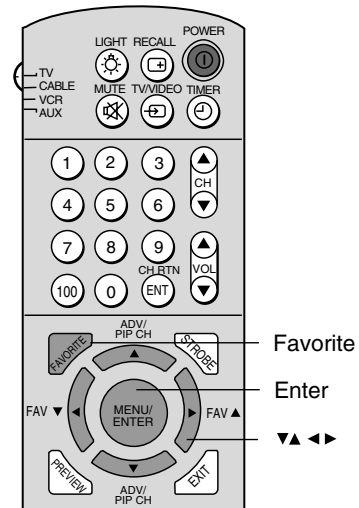

### Note:

The Preview, Favorite, and Strobe modes cannot be turned on when the ColorStream input is being viewed.

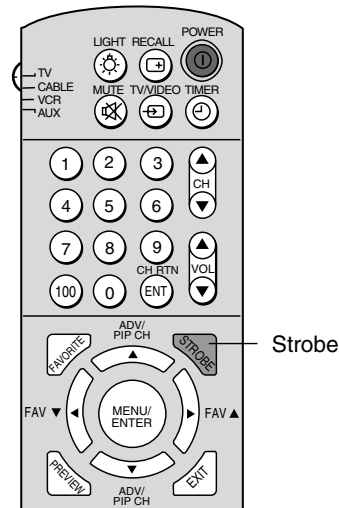



## Adjusting the picture

### Adjusting the picture quality

You can adjust the picture quality to your personal preferences, including the contrast, brightness, color, tint, and sharpness. The qualities you choose will be stored automatically in your TV's memory so you can recall them at any time.

To adjust the picture quality:

1. Press MENU, then press ◀ or ▶ to highlight the PICTURE menu.

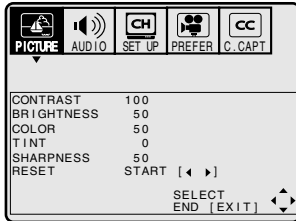

2. Press ▲ or ▼ until the item you want to adjust is highlighted.
3. Press ◀ or ▶ to adjust the level.

The PICTURE items you have adjusted will be stored in the TV's memory automatically. You can keep these settings or choose preset options under the PREFERENCES menu. (See "Selecting the color temperature," below, and "Adjusting the picture preferences" on page 28.)

Selection	◀ Pressing ▶	
contrast	lower	higher
brightness	darker	lighter
color	paler	deeper
tint	reddish	greenish
sharpness	softer	sharper

### Selecting the color temperature

You can change the quality of the picture by selecting from three preset color temperatures: cool, medium, and warm.

To select the color temperature:

1. Press MENU, then press ◀ or ▶ to highlight the PREFERENCES menu.
2. Press ▲ or ▼ to highlight COLOR TEMPERATURE.
3. Press ◀ or ▶ to highlight the mode you want.

Mode	Picture Quality
cool	blueish
medium	neutral
warm	reddish

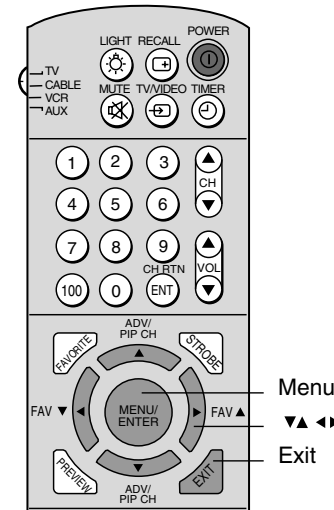
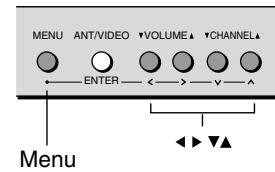

**Note:**

To reset the picture adjustments to the factory settings, select RESET from the PICTURE menu.

## Adjusting the picture preferences

You can select your desired picture type from three preset picture modes: Normal, Theater, and Memory.

To select the picture preferences:

1. Press MENU, then press ◀ or ▶ to highlight the PREFERENCES menu.
2. Press ▲ or ▼ to highlight PICTURE PREFERENCES.
3. Press ◀ or ▶ to highlight the mode you want.

The table below describes the effects of the different preferences.

Mode	Picture Quality
normal	picture quality set at factory
theater	movie-like picture setting
memory	your personal preference*

\*(see “Adjusting the picture quality” on page 27)

## Watching video input

You can use the TV/VIDEO button on the remote control or ANT/VIDEO button on the TV to view a signal coming from other devices, such as VCRs or video disc players that may be connected to your TV. (See “Connecting your TV” on page 2.)

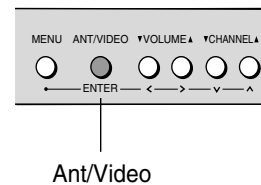

## Displaying on-screen information

Press RECALL to display the following on-screen information:

- Antenna mode (when in TV mode)
- Channel number or VIDEO mode selected
- Channel label (if preset)
- Stereo or SAP (second audio program) audio status

## Setting the off-timer

You can set the TV so it turns off automatically.

To set the off-timer:

1. Press TIMER once to select the OFF TIMER.
2. Press two Channel Number buttons to enter how long you want the TV to remain on (up to three hours, in 10 minute increments). Enter the numbers after the number position starts to blink.
3. Press TIMER to start the timer. The display color will change from purple to blue, then turn off.

To cancel the off-timer:

Press POWER twice, once to turn the TV off, and once to turn it on again.

## Auto power off

The TV will automatically turn itself off after approximately 15 minutes if it is tuned to a vacant channel or if a station completes its broadcast for the day and stops broadcasting on that channel. This feature, however, does not work in the VIDEO mode.

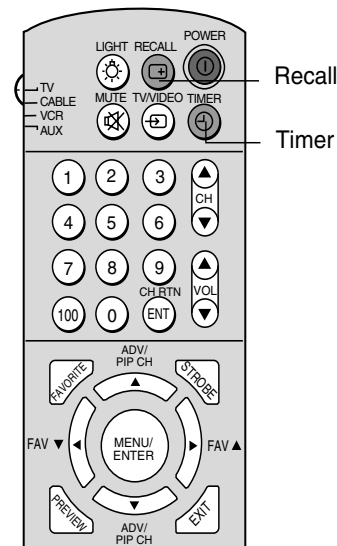

### Note:

The timer can also be set through the SET UP menu.

If you want to see how much time remains before the shut-off time, press TIMER once. The remaining time will be displayed. To erase the display, press TIMER again.

## Using the closed caption feature

You have two options with the closed caption feature: captions or text. A caption is a printed version of the dialogue, narration and/or sound effects of a TV program. Text is information not related to the program that appears on half of the TV screen.

To view captions or text:

1. Select the desired program. The captioned programs are usually marked in your local TV listing by "CC."
2. Press MENU, then press ◀ or ▶ until the C.CAPT menu appears.

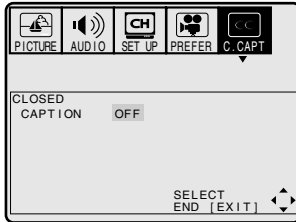

3. Press ▲ or ▼ to highlight CLOSED CAPTION.

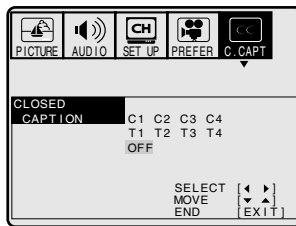

4. Press ◀ or ▶ to select the closed caption mode.
  - Select C1, C2, C3, or C4 to view captions. Select C1 for translation of the primary language in your area.



- Select T1, T2, T3, or T4 to view Text.

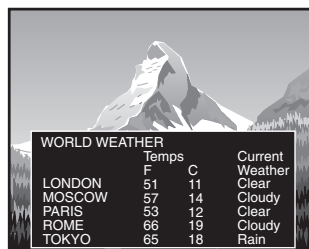

5. To turn off the closed-captioned feature, select OFF in step 4.

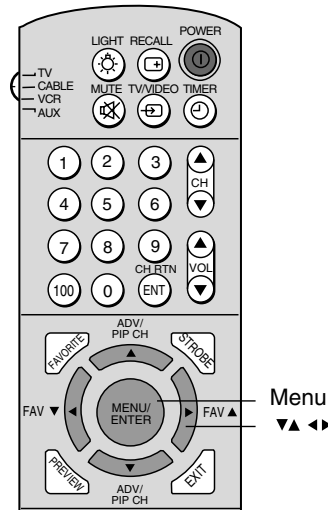

### Note:

A closed caption signal may not be decoded in the following situations:

- when a video tape has been dubbed
- when the signal reception is weak
- when the signal reception is non-standard

When you choose a closed captioned channel and the text mode, the text screen always appears. When there is no signal, however, the text screen will not display text characters.

## Adjusting the sound

### Muting the sound

Press MUTE to temporarily turn off the sound. While the sound is off, the screen will display the word MUTE in the lower right-hand corner. To restore the sound, press MUTE again.

When you press the MUTE button, you automatically activate the closed caption feature. To deactivate this feature, press the MUTE button again. This feature only works when the closed caption mode is set to off. See “Using the closed captioned feature” on page 29 for more information.

### Selecting stereo/SAP broadcasts

You can enjoy watching TV while you listen to high-fidelity stereo sound with the Multi-channel TV Sound (MTS) feature. MTS can also transmit a second audio program (SAP) containing a second language or other audio information.

When the TV receives a stereo or SAP broadcast, the word STEREO or SAP appears on the screen when the TV is on, you change the channel, or press the RECALL button.

The MTS feature is not available while in the VIDEO mode.

To listen to stereo sound:

1. Press MENU, then press ◀ or ▶ until the AUDIO menu appears.

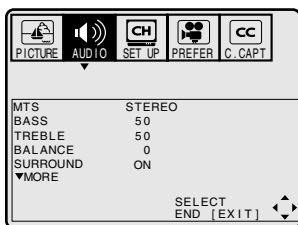

2. Press ▲ or ▼ to highlight MTS.
3. Press ◀ or ▶ to highlight STEREO.

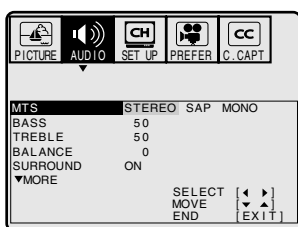

When you are watching a stereo broadcast, the word STEREO is displayed in yellow. You should leave your TV set to STEREO so you can automatically receive stereo or monaural sound, depending on the broadcast type. If the stereo sound is noisy, select MONO to reduce the noise. The word STEREO or SAP is displayed in yellow when the TV receives the signal, and in magenta when you have selected the feature.

To listen to a second audio program:

1. Press MENU, then press ◀ or ▶ until the AUDIO menu appears.
2. Press ▲ or ▼ to highlight MTS.
3. Press ◀ or ▶ to highlight SAP. You will hear only the second audio program from the left and right speakers.

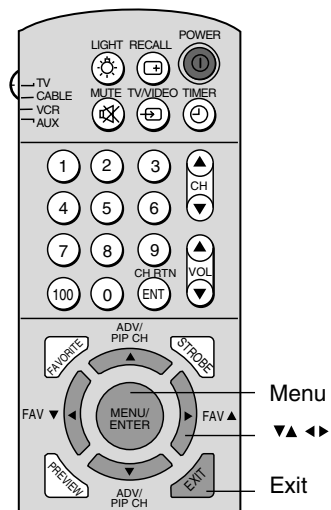
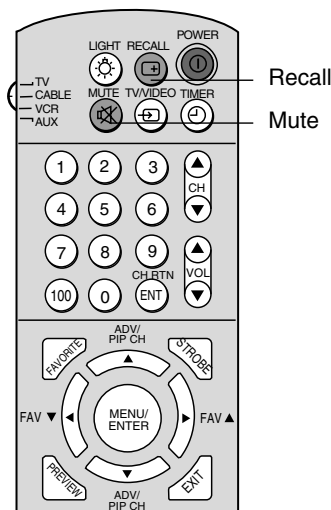

## Adjusting the sound quality

You can change the sound quality of your TV by adjusting the bass, treble, and balance.

To adjust the sound quality:

1. Press MENU, then press ◀ or ▶ until the AUDIO menu appears.

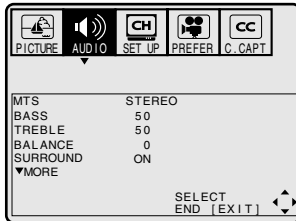

2. Press ▲ or ▼ to highlight the item you want to adjust.
3. Press ◀ or ▶ to adjust the level.

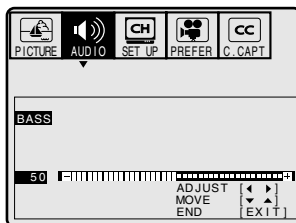

- ◀ makes the sound quality weaker or decreases the balance in the right channel, depending on the item selected.
- ▶ makes the sound quality stronger or decreases the balance in the left channel, depending on the item selected.

## Using the surround sound feature

The surround sound feature expands the audio listening field wider and deeper to create exceptional sound quality from the TV's speakers. The feature uses stereo signals from a TV broadcast or video input.

To turn on the surround sound feature:

1. Select the STEREO mode following the steps under “Selecting stereo/SAP broadcasts” on page 30.
2. Press MENU, then press ◀ or ▶ until the AUDIO menu appears.
3. Press ▲ or ▼ to highlight SURROUND.
4. Press ◀ or ▶ to highlight ON.

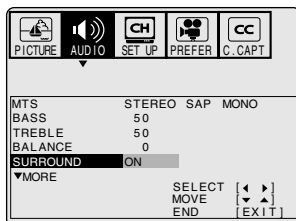

To turn off the surround sound feature:

Choose OFF in step 4 above.

In general, you should leave your TV set to SURROUND so it can automatically produce surround stereo or monaural sound, depending on the broadcast type.

### Using the sub-bass system

The sub-bass system (SBS) allows you to improve bass-performance (even when the sound volume is low).

To activate the sub-bass system:

1. Press MENU, then press ◀ or ▶ until the AUDIO menu appears.
2. Press ▲ or ▼ until SBS is highlighted.

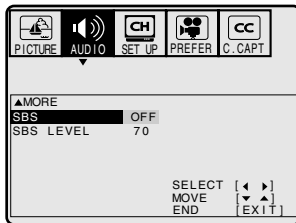

3. Press ◀ or ▶ to highlight ON.

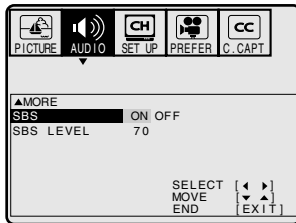

To turn the sub-bass system off:

Select OFF in step 3, above.

To adjust the sub-bass system,

1. Press MENU, then press ◀ or ▶ until the AUDIO menu appears.
2. Press ▲ or ▼ until SBS LEVEL is highlighted.

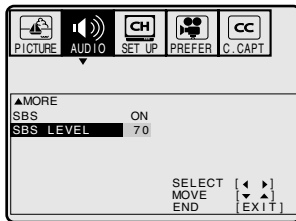

3. Press ◀ or ▶ to adjust the SBS level.

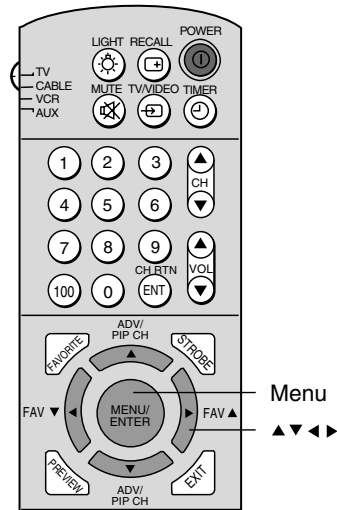
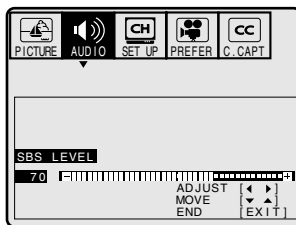

## Viewing the demonstration mode

The demonstration mode (DEMO) is an option available on the SETUP menu. If you select this mode, the TV will demonstrate several of the TV's features.

To stop the demonstration mode:

Select DEMO STOP in the SETUP menu, or press the RECALL, EXIT, or POWER buttons.

## Understanding the last mode memory feature

If the power is cut off while you are viewing the TV and the power is resupplied, the last mode memory feature will turn the TV on automatically.

If the power is going to be off for a long time or you are going to be away from home for a long time, remove the power plug from the wall outlet to prevent the TV from turning on in your absence.

# Appendix

## Cleaning and care

### **WARNING:**

TV sets use high voltage. Do not try to remove the cabinet back. Refer servicing to qualified service technicians.

To clean the TV screen:

1. Unplug the TV to avoid possible shock hazard.
2. Use a clean cellulose sponge or chamois cloth dampened with a solution of mild detergent and warm water to clean the TV screen and trim. Do not use too much water because water spills into the cabinet can cause damage to the TV.
3. Wipe off any excess moisture with a clean dry cloth.
4. Polish the cabinet with a quality furniture polish to maintain the finish and appearance of the cabinet.

### **Caution:**

Never use strong solvents such as thinner, benzene, or other chemicals on or near the cabinet. These chemicals can damage the finish of the cabinet.

## Troubleshooting

Before calling a service technician, please check the following table for a possible cause of the problem and some solutions.

<b>Problem</b>	<b>Solution</b>
TV will not turn on	<ul style="list-style-type: none"><li>• Make sure the power cord is plugged in, then press POWER.</li><li>• The remote control batteries may be dead. Replace the batteries.</li></ul>
No picture, no sound	<ul style="list-style-type: none"><li>• Check the antenna/cable connections.</li></ul>
No sound, picture OK	<ul style="list-style-type: none"><li>• The sound may be muted. Press VOLUME.</li><li>• The station may have broadcast difficulties. Try another channel.</li></ul>
Poor sound, picture OK	<ul style="list-style-type: none"><li>• The station may have broadcast difficulties. Try another channel.</li></ul>
Poor picture, sound OK	<ul style="list-style-type: none"><li>• Check the antenna connections.</li><li>• The station may have broadcast difficulties. Try another channel.</li><li>• Adjust the PICTURE menu.</li></ul>
Poor reception of broadcast channels	<ul style="list-style-type: none"><li>• The station may have broadcast difficulties. Try another channel.</li><li>• Check the antenna connections.</li><li>• If you are using a VCR, make sure the TV/VCR button is set correctly.</li></ul>
Cannot receive above channel 13	<ul style="list-style-type: none"><li>• Make sure TV/CABLE is set to TV mode.</li></ul>
Unable to select a certain channel	<ul style="list-style-type: none"><li>• The channel may be blocked out with the V-Chip feature, or erased with the add/erase feature.</li></ul>
Multiple images	<ul style="list-style-type: none"><li>• The station may have broadcast difficulties. Try another channel.</li><li>• Use a highly directional outdoor antenna.</li></ul>



- Poor color or no color
  - The station may have broadcast difficulties. Try another channel.
  - Adjust the TINT and/or COLOR in the PICTURE menu.
  - If you change the direction of the TV while it is turned on, the picture could suffer from color shading. If so, turn off the TV and allow it to cool down for several hours before turning it on again.
- No stereo or SAP sound from a known MTS broadcast
  - Make sure the MTS feature is set properly.
- The remote control does not operate
  - Check if the TV/CABLE/VCR switch is properly set.
  - There may be an obstruction between the remote control and the remote control sensor.
  - The remote control batteries may be dead. Replace the batteries.
- The V-Chip PIN code does not work
  - Change or reset your PIN code (see Selecting a PIN code, page 17).

## Specifications

Television system	NTSC standard
Channel coverage	VHF: 2 through 13 UHF: 14 through 69 Cable TV: mid band (A-8 through A-1, A through 1) super band (J through W) hyper band (AA through ZZ, AAA, BBB) ultra band (65 through 94, 100 through 125)
Power source	120 AC, 60 Hz
Power consumption	107 W (average)
Audio power	5W + 5W
Speaker type	3-1/8 x 4-3/4 inches (80 x 120 mm)
Video/Audio terminals	S-VIDEO INPUT Y-INPUT: 1V (p-p), 75 ohm, negative sync. C-INPUT: 0.286V (p-p) (burst signal), 75 ohm VIDEO/AUDIO INPUT VIDEO: 1V (p-p), 75 ohm, negative sync. AUDIO: 150 mV (rms) (30% modulation equivalent, 47k ohm) VIDEO/AUDIO OUTPUT VIDEO: 1V (p-p), 75 ohm, negative sync. AUDIO: 150 mV (rms) (30% modulation equivalent, 47k ohm)
Dimensions	Width: 30-13/16 inches (783 mm) Height: 27-5/16 inches (694 mm) Depth: 23-1/8 inches (587 mm)
Weight	125 lbs. (56.8 kg)
Supplied accessories	Remote control with two size "AA" alkaline batteries
Optional TV stand	ST3215

**Design and specifications are subject to change without notice.**

## Limited United States warranty

Toshiba America Consumer Products, Inc. (“TACP”) and Toshiba Hawaii Inc. (“THI”) make the following limited warranties. These limited warranties extend to the original consumer purchaser or any person receiving this set as a gift from the original consumer purchaser and to no other purchaser or transferee.

### Limited one-year warranty

TACP and THI warrant this product and its parts against defects in materials or workmanship for a period of one (1) year after the date of original retail purchase. During this period, TACP and THI will repair or replace a defective part, at their option, with a new or refurbished part, without charge to you. “Authorized TACP/THI service station personnel will come to your home when warranty service is required. Depending on the type of repair required, the service will either be performed in your home or the set will be taken to the authorized TACP/THI service station for repair and returned to your home at no cost to you.”

### Limited two-year warranty of picture tube

TACP and THI further warrant the picture tube in this product against defects in materials or workmanship for a period of two (2) years after the date of original retail purchase. During this period, TACP and THI will repair or replace a defective picture tube, at their option, with a new or refurbished picture tube, without charge to you, except that if a defective picture tube is replaced after one (1) year from the date of the original retail purchase, you pay labor charges involved in the replacement.

### Rental units

The warranty for rental units begins with the first rental of thirty (30) days from the date of shipment to the rental firm, whichever comes first.

### Commercial units

Products sold and used for commercial use have a limited ninety (90) day warranty for all parts, labor and picture tube.

### Owner’s manual and registration card

You should read this owner’s manual thoroughly before operating this product. You should complete and mail the enclosed registration card within ten days after you, or the person who has given you this product as a gift, purchased this product. This is one way to enable TACP/THI to provide you with better customer service and improved products. Failure to return the registration card will not affect your rights under this warranty.

### Your responsibility

The above warranties are subject to the following conditions:

- You must retain your bill of sale or provide other proof of purchase.
- All warranty servicing of this product must be made by an Authorized TACP/THI Service Station.
- **These warranties are effective only if the product is purchased and operated in the U.S.A. or Puerto Rico.**
- Labor service charges for set installation, set up, adjustment of customer controls and installation or repair of antenna systems are not covered by this warranty. Reception problems caused by inadequate antenna systems are your responsibility.
- Warranties extend only to defects in materials or workmanship as limited above and do not extend to any product or parts which have been lost or discarded by you or to damage to products or parts caused by misuse, accident, damage caused by Acts of God, such as lightning or fluctuations in electric power, improper installation, improper maintenance or use in violation of instructions furnished by us; or to units which have been modified or had the serial number removed, altered, defaced or rendered illegible.

### How to obtain warranty service

If after following all of the operating instructions in this manual and checking the section “Troubleshooting,” you find that service is needed;

- Call the TACP toll free number **1-800-631-3811** after you find a defective product or part to find the nearest Toshiba Authorized Service Station.
- Please present your bill of sale or other proof to the Authorized Service Station.

Authorized TACP/THI service station personnel will come to your home when warranty service is required. Depending on the type of repair required, the service will either be performed in your home or the set will be taken to the TACP/THI Authorized service station for repair and returned to your home at no cost to you.

### In the Continental U.S.

If your TV requires service, call toll free:  
1-800-631-3811



### In Hawaii

If your TV requires service, call:  
(808) 521-5377  
327 Kamakee Street, Honolulu, HI 96814

### Limitations

All warranties implied by state law, including the implied warranties of merchantability and fitness for a particular purpose, are expressly limited to the duration of the limited warranties set forth above. With the exception of any warranties implied by state law as hereby limited, the foregoing warranty is exclusive and in lieu of all other warranties, guarantees, agreements and similar obligations of manufacturer or seller with respect to the repair or replacement of any parts. In no event shall TACP or THI be liable for consequential or incidental damages.

No person, agent, distributor, dealer or company is authorized to change, modify or extend the terms of these warranties in any manner whatsoever. The time within which action must be commenced to enforce any obligation of TACP or THI arising under this warranty or under any statute, or law of the United States or any state thereof, is hereby limited to 90 days from the date you discover or should have discovered, the defect. This limitation does not apply to implied warranties arising under state law.

This warranty gives you specific legal rights and you may also have other rights which may vary from state to state. Some states do not allow limitation on how long an implied warranty lasts, when an action may be brought, or the exclusion or limitation of incidental or consequential damages, so the above provisions may not apply to you.

REV. 9-01-98



### Attention Canadian customers

Canadian consumers are requested to complete the special Canadian "Warranty Registration Form" enclosed, and forward this completed form with a copy of bill of sale to TOSHIBA OF CANADA to "Register and Validate" their warranty.

**Products purchased in the U.S.A. and used in Canada are not covered by these warranties.**  
**Products purchased in Canada and used in the U.S.A. are not covered by these warranties.**

# Index

## A

adding and erasing channels manually .....	15
adding channels to the TV's memory .....	14
adjusting	
channel settings .....	16
picture preferences .....	28
picture quality .....	27
sound .....	30
ANT/VIDEO button, using .....	13
antenna input, selecting .....	13
audio amplifier, connecting .....	6
auto power off .....	28

## B

batteries, installing into the remote control .....	7
blocking	
channels .....	21
programs by ratings .....	18
unrated movies or programs .....	21

## C

cable converter box and a VCR, connecting .....	3
cable converter box, connecting .....	3
cable TV converter code table .....	11
camcorder, connecting .....	6
care and cleaning of your TV .....	34
changing	
channels .....	15
on-screen display language .....	13
position of the small picture (PIP) .....	24
channel settings, adjusting .....	16
channels	
adding or erasing manually .....	15
adding to the TV's memory .....	14
blocking with V-Chip .....	21
changing .....	15
favorite, programming .....	16
labeling .....	22
programming automatically .....	14
switching between two .....	16
cleaning and care of your TV .....	34
closed caption feature, using .....	29
code table	
cable TV converter .....	11
VCR .....	10
color temperature, selecting .....	27

connecting	
audio amplifier .....	6
cable converter box .....	3
cable converter box and a VCR .....	3
camcorder .....	6
DVD with ColorStream and a VCR .....	4
DVD/satellite receiver and a VCR .....	4
TV .....	2
VCR .....	2
VCRs, two .....	5

## D

demonstration mode, viewing .....	33
displaying on-screen information .....	28
DVD with ColorStream and a VCR, connecting .....	4
DVD/satellite receiver and a VCR, connecting .....	4

## F

favorite channels, programming .....	16
favorite mode .....	26
freezing the small picture (PIP) .....	25

## L

labeling channels .....	22
language, changing the on-screen display .....	13
last mode memory feature, understanding .....	33
location for TV, selecting .....	1

## M

multi-window PIP .....	25
favorite mode .....	26
preview mode .....	25
strobe mode .....	26
muting the sound .....	30

## O

off-timer, setting .....	28
on-screen display language, changing .....	13
on-screen information, displaying .....	28

## P

picture	
adjusting .....	25, 27
color temperature, selecting .....	27
preferences, adjusting .....	28
quality, adjusting .....	27

picture-in-picture (PIP)		specifications .....	35
changing the position of the small picture .....	24	stereo sound, selecting .....	30
freezing the small picture .....	25	strobe mode .....	26
main and small pictures, switching .....	24	sub-bass system, using .....	32
watching .....	23	surround sound, using .....	31
watching multi-window .....	25	switching between two channels .....	16
PIN code, selecting .....	17	switching the main and small pictures (PIP) .....	24
power, auto off .....	28	<b>T</b>	
preview mode .....	25	troubleshooting .....	34
programming		TV	
channels automatically .....	14	connecting .....	2
favorite channels .....	16	location, selecting .....	1
remote control for use with a VCR		setting up .....	13
or cable TV converter .....	8	<b>V</b>	
remote control to learn .....	9	V-Chip	
programs, blocking with V-Chip .....	18	blocking channels .....	21
<b>R</b>		blocking programs by ratings .....	18
ratings		selecting a PIN code .....	17
blocking programs by .....	18	using .....	17
MPAA .....	19	VCR and a cable converter box, connecting .....	3
TV .....	19	VCR and a DVD with ColorStream, connecting .....	4
unrated movies or programs .....	21	VCR and a DVD/satellite receiver, connecting .....	4
youth TV .....	19	VCR, connecting .....	2
remote control		VCRs, connecting two .....	5
batteries, installing .....	7	video input, watching .....	28
learning about .....	12	<b>W</b>	
preparing for use .....	7	warranty .....	36
programming for use with a VCR		watching	
or cable TV converter .....	8	multi-window picture-in-picture (PIP) .....	25
programming to learn operating codes .....	9	picture-in-picture (PIP) .....	23
using .....	7	video input .....	28
using with a VCR or cable TV converter .....	7		
<b>S</b>			
SAP, selecting .....	30		
satellite receiver/DVD and a VCR, connecting .....	4		
sound			
adjusting .....	30		
muting .....	30		
stereo/SAP broadcasts, selecting .....	30		
sub-bass system, using the .....	32		
surround, using .....	31		

**Toshiba America  
Consumer Products, Inc.**

**Head Office**  
82 Totowa Road  
Wayne, NJ 07470

**Factory Service Center**  
1420B Toshiba Drive  
Lebanon, TN 37087

**Toshiba Hawaii, Inc.**

**Head Office**  
327 Kamakee Street  
Honolulu, HI 96814

**Toshiba of Canada, Ltd.**

**Head Office**  
191 McNabb Street  
Markham, Ontario L3R 8H2  
Canada

**Service Centers**

**Toronto**  
191 McNabb Street  
Markham, Ontario L3R 8H2  
Canada  
Tel: (905) 470-5400

**Montreal**  
1643 North Service Road  
Trans-Canada Highway  
Dorval, Quebec H9P 1J1  
Canada  
Tel: (514) 856-4100

**Vancouver**  
22171 Fraserwood Way  
Richmond, British Columbia V6W 1J5  
Tel: (604) 303-2500

Manufactured by:

**TOSHIBA**

**Toshiba America  
Consumer Products, Inc.**

PRINTED IN USA  
(99-05)B

23563613

## Free Manuals Download Website

<http://myh66.com>

<http://usermanuals.us>

<http://www.somanuals.com>

<http://www.4manuals.cc>

<http://www.manual-lib.com>

<http://www.404manual.com>

<http://www.luxmanual.com>

<http://aubethermostatmanual.com>

Golf course search by state

<http://golfingnear.com>

Email search by domain

<http://emailbydomain.com>

Auto manuals search

<http://auto.somanuals.com>

TV manuals search

<http://tv.somanuals.com>