

TOSHIBA

DVD PLAYER

SD-37VBSB
USER'S GUIDE

Hi-Fi VIDEO
CASSETTE
RECORDER



4 HEAD

Hi-Fi

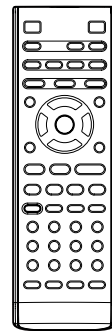
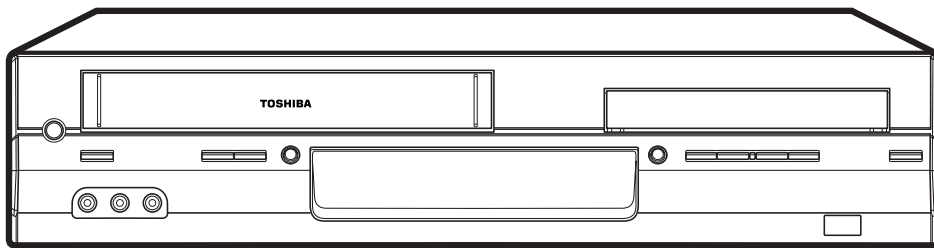



SAFETY PRECAUTIONS

WARNING: TO REDUCE THE RISK OF FIRE OR ELECTRIC SHOCK, DO NOT EXPOSE THIS APPLIANCE TO RAIN OR MOISTURE. DANGEROUS HIGH VOLTAGES ARE PRESENT INSIDE THE ENCLOSURE. DO NOT OPEN THE CABINET. REFER SERVICING TO QUALIFIED PERSONNEL ONLY.

CAUTION: This Digital Video Disc Player employs a Laser System. To ensure proper use of this product, please read this owner's manual carefully and retain for future reference. Should the unit require maintenance, contact an authorized service location -see service procedure.

Use of controls or adjustments or performance of procedures other than those specified herein may result in hazardous radiation exposure.

To prevent direct exposure to laser beam, do not try to open the enclosure. Visible and invisible laser radiation when open and interlocks defeated. DO NOT STARE INTO BEAM.

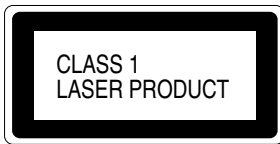

CAUTION: Servicing instructions are for use by qualified service personnel only. To reduce the risk of electric shock do not perform any servicing other than that contained in the operating instructions unless you are qualified to do so.

In the spaces provided below, record the Model and Serial No. located on the rear panel of your DVD video player.

Model No. _____

Serial No. _____

Retain this information for future reference.

The following information applies only to the model for U.K.

General Information

If the socket outlets in your home are not suitable for the plug supplied with this unit, the plug must be cut off and an appropriate one fitted.

The plug severed from this mains lead must be destroyed as it is hazardous if inserted into a live socket.

IMPORTANT

The wires in this mains lead are coloured in accordance with the following code:

BLUE: NEUTRAL

BROWN: LIVE

As the colours of the wires in the mains lead of this unit may not correspond with the coloured markings identifying the terminals in your plug, proceed as follows:

The wire that is coloured blue must be connected to the terminal in the plug which is marked with the letter N or coloured black.

The wire that is coloured brown must be connected to the terminal which is marked with the letter L or coloured red.

Do not connect either wire to the earth terminal which is marked by the letter E or by the safety earth symbol  or coloured green or green-and-yellow.

Use a 5A fuse which is approved by ASTA or BSI to BS1362.

Always replace the fuse cover after changing the fuse.

Location of the required label

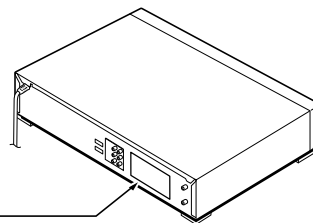

The rating plate and the safety caution are on the rear of the unit.

2





SAFETY PRECAUTIONS

SOME DOS AND DON'TS ON THE SAFE USE OF EQUIPMENT

This equipment has been designed and manufactured to meet international safety standards but, like any electrical equipment, care must be taken if you are to obtain the best results and safety is to be assured.

- DO** read the operating instructions before you attempt to use the equipment.
- DO** ensure that all electrical connections (including the mains plug, extension leads and inter-connections between the pieces of equipment) are properly made and in accordance with the manufacturer's instructions. Switch off and withdraw the mains plug before making or changing connections.
- DO** consult your dealer if you are ever in doubt about the installation, operation or safety of your equipment.
- DO** be careful with glass panels or doors on equipment.

- DON'T** remove any fixed cover as this may expose dangerous voltages.
- DON'T** obstruct the ventilation openings of the equipment with items such as newspapers, tablecloths, curtains, etc. Overheating will cause damage and shorten the life of the equipment.
- DON'T** allow electrical equipment to be exposed to dripping or splashing, or objects filled with liquids, such as vases, to be placed on the equipment.
- DON'T** place hot objects or naked flame sources such as lighted candles or nightlights on, or close to equipment. High temperatures can melt plastic and lead to fires.
- DON'T** use makeshift stands and NEVER fix legs with wood screws - to ensure complete safety always fit the manufacturer's approved stand or legs with the fixings provided according to the instructions.
- DON'T** use equipment such as personal stereos or radios so that you are distracted from the requirements of traffic safety. It is illegal to watch television whilst driving.
- DON'T** listen to headphones at high volume, as such use can permanently damage your hearing.
- DON'T** leave equipment switched on when it is unattended unless it is specifically stated that it is designed for unattended operation or has a stand-by mode. Switch off using the switch on the equipment and make sure that your family know how to do this. Special arrangements may need to be made for infirm or handicapped people.
- DON'T** continue to operate the equipment if you are in any doubt about it working normally, or if it is damaged in any way - switch off, withdraw the mains plug and consult your dealer.

ABOVE ALL

- NEVER let anyone especially children push anything into holes, slots or any other opening in the case - this could result in a fatal electrical shock;**
- NEVER guess or take chances with electrical equipment of any kind**
- it is better to be safe than sorry!**

EXCLUSION CLAUSE

Toshiba shall under no circumstances be liable for loss and/or damage to the product caused by:

- i) fire;
- ii) earthquake;
- iii) accidental damage;
- iv) intentional misuse of the product;
- v) use of the product in improper conditions;
- vi) loss and/or damage caused to the product whilst in the possession of a third party;
- vii) any damage or loss caused as a result of the owner's failure and/or neglect to follow the instructions set out in the owner's manual;
- viii) any loss or damage caused directly as a result of misuse or malfunction of the product when used simultaneously with associated equipment;

Furthermore, under no circumstances shall Toshiba be liable for any consequential loss and/or damage including but not limited to the following, loss of profit, interruption of business, the loss of recorded data whether caused during normal operation or misuse of the product.





Precautions

Notes on handling

- When shipping the DVD/VCR, the original shipping carton and packing materials come in handy. For fully protection, repack the unit as it was originally packed at the factory.
- Do not use volatile liquids, such as insect spray, near the DVD/VCR. Do not leave rubber or plastic products in contact with the DVD/VCR for a long time. They will leave marks on the finish.
- The top and rear panels of the DVD/VCR may become warm after a long period of use. This is not a malfunction.
- When the DVD/VCR is not in use, be sure to remove the disc and turn off the power.
- If you do not use the DVD/VCR for a long period, the unit may not function properly in the future. Turn on and use the DVD/VCR occasionally.

Notes on locating

- Place the DVD/VCR on a level surface. Do not use it on a shaky or unstable surface such as a wobbling table or inclined stand. The loaded disc or video tape may become dis-aligned and damage the DVD/VCR.
- When you place this DVD/VCR near a TV, radio, or VCR, the playback picture may become poor and the sound may be distorted. In this case, place the DVD/VCR away from the TV, radio, or VCR.

Notes on cleaning

Use a soft, dry cloth for cleaning.

- Use a dry cloth to wipe.
Do not use any type of solvent, such as thinner and benzene, as they may damage the surface of the DVD/VCR.
- If you use a chemical saturated cloth to clean the unit, follow that product's instructions.

Notes on moisture condensation

Moisture condensation damages the DVD/VCR. Please read the following carefully.

Moisture condensation occurs, for example, when you pour a cold drink into a glass on a warm day. Drops of water form on the outside of the glass. In the same way, moisture may condense on the head drum or the optical pick-up lens inside this unit, one of the most crucial internal parts of the DVD/VCR.

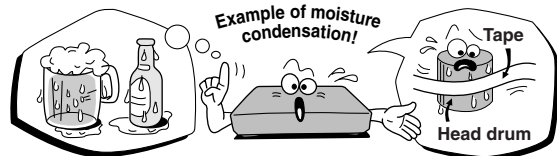

■ **Moisture condensation occurs during the following cases:**

- When you bring the DVD/VCR directly from a cold place to a warm place.
- When you use the DVD/VCR in a room where you just turned on the heater, or a place where the cold wind from the air conditioner directly hits the unit.
- In summer, when you use the DVD/VCR in a hot and humid place just after you move the unit from an air conditioned room.
- When you use the DVD/VCR in a humid place.

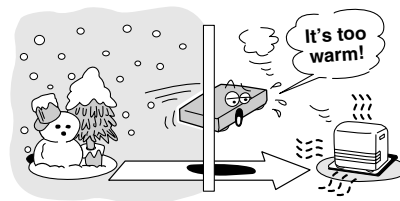

Do not use the DVD/VCR when moisture condensation may occur.

If you use the DVD/VCR in such a situation, it may damage discs and internal parts. Remove the disc or the video tape, connect the power cord of the DVD/VCR to the wall outlet, turn on the DVD/VCR, and leave it for two or three hours. After two or three hours, the DVD/VCR will have warmed up and evaporated any moisture. Keep the DVD/VCR connected to the wall outlet and moisture condensation will seldom occur.

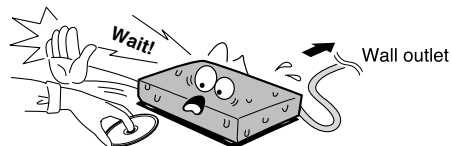



Notes on discs

On handling discs

- Do not touch the playback side of the disc.

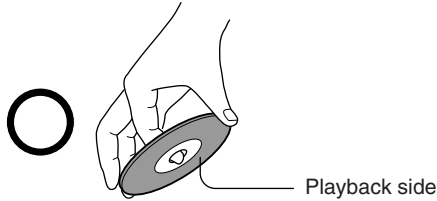

- Do not attach paper or tape to discs.



On cleaning discs

- Fingerprints and dust on the disc cause picture and sound deterioration. Wipe the disc from the centre outwards with a soft cloth. Always keep the disc clean.

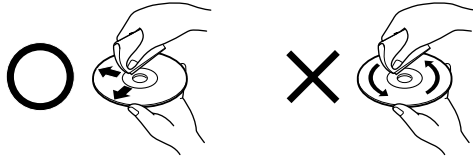

- Do not use any type of solvent such as thinner, benzene, commercially available cleaners or antistatic spray for vinyl LPs. It may damage the disc.

On storing discs

- Do not store discs in a place subject to direct sunlight or near heat sources.
- Do not store discs in places subject to moisture and dust such as a bathroom or near a humidifier.
- Store discs vertically in a case. Stacking or placing objects on discs outside of their case may cause warping.

Structure of disc contents

Normally, DVD video discs are divided into titles, and the titles are sub-divided into chapters. Video CDs and Audio CDs are divided into tracks.

DVD video disc

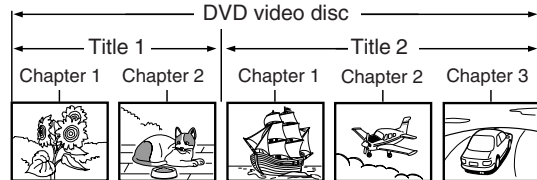

Video CD/Audio CD

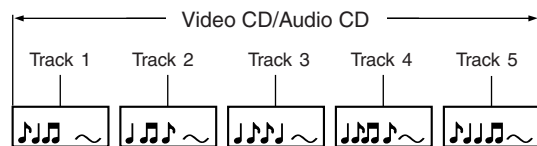

Each title, chapter or track is assigned a number, which is called "title number", "chapter number" or "track number" respectively.

There may be discs that do not have these numbers.

Notes on copyright

The unauthorized recording, use, distribution, or revision of copyrighted materials including, without limitation, television programs, videotapes, and DVDs is prohibited under the Copyright Laws of the United States and other countries, and may subject you to civil and criminal liability.

This product incorporates copyright protection technology that is protected by method claims of certain U.S. patents and other intellectual property rights owned by Macrovision Corporation and other rights owners. Use of this copyright protection technology must be authorized by Macrovision Corporation, and is intended for home and other limited viewing uses only unless otherwise authorized by Macrovision Corporation. Reverse engineering or disassembly is prohibited.

Consumers should note that not all high definition television sets are fully compatible with this product and may cause artifacts to be displayed in the picture. In case of 525 or 625 progressive scan picture problems, it is recommended that the user switch the connection to the "STANDARD DEFINITION" output. If there are questions regarding our TV set compatibility with this model 525p and 625p DVD player, please contact our customer service center.

Manufactured under license from Dolby Laboratories. Dolby, Pro Logic and the double-D symbol are trademarks of Dolby Laboratories.

"DTS" and "DTS Digital Out" are trademarks of Digital Theater Systems, Inc.

DivX, DivX Certified, and associated logos are trademarks of DivX, Inc. and are used under license.



Notes on discs

About this owner's manual

This owner's manual explains the basic instructions of this DVD/VCR. Some DVD video discs are produced in a manner that allows specific or limited operation during playback. As such, the DVD/VCR may not respond to all operating commands. This is not a defect in the DVD/VCR. Refer to instruction notes of discs.

The following symbol may appear on the TV screen during operation.



It means that the operation is not permitted by the DVD/VCR or the disc.

For example, sometimes it is unable to stop the playback of copyright message of the disc when the STOP (■) button is pressed. Alternatively, this symbol may also indicate that the feature is not available for the disc.

Notes on region numbers

The region number of this DVD/VCR is 2. If region numbers, which stand for their playable area, are printed on your DVD video disc and you do not find (2) or (2), disc playback will not be allowed by the player. (In this case, the DVD/VCR will display a message on-screen.)

On Video CDs

This DVD/VCR supports Video CDs equipped with the PBC (Version 2.0) function. (PBC is the abbreviation of Playback Control.) You can enjoy two playback variations depending on types of discs.

• Video CD not equipped with PBC function (Version 1.1)

Sound and movie can be played on this DVD/VCR in the same way as an audio CD.

• Video CD equipped with PBC function (Version 2.0)

In addition to operation of a Video CD not equipped with the PBC function, you can enjoy playback of interactive software with search function by using the menu displayed on the TV screen (Menu Playback). Some of the functions described in this owner's manual may not work with some discs.

Playable discs

This DVD/VCR can play the following discs.

	Disc Mark	Contents	Disc Size	Maximum playback time
DVD video discs		Audio + Video (moving pictures)	12 cm	Approx. 4 hours (single sided disc)
				Approx. 8 hours (double sided disc)
			8 cm	Approx. 80 minutes (single sided disc)
				Approx. 160 minutes (double sided disc)
Video CDs		Audio + Video (moving pictures)	12 cm	Approx. 74 minutes (single sided disc)
			8 cm	Approx. 20 minutes (single sided disc)
Audio CDs		Audio	12 cm	Approx. 74 minutes (single sided disc)
			8 cm	Approx. 20 minutes (single sided disc)

The following discs are also available.

- DVD-R/RW discs of DVD video format
 - CD-R/CD-RW discs of CD-DA, Video CD, SVCD, MP3, JPEG or DivX® format
 - Kodak Picture CD and FUJICOLOR CD format
- Some of these discs may be incompatible.

- You cannot play discs other than those listed above.
- You cannot play discs of DVD-RAM, DVD-ROM, Photo CD, etc., or non standardized discs even if they may be labeled as above.
- Some CD-R/RWs cannot be played back depending on the recording conditions.
- This DVD/VCR uses the PAL colour system, and cannot play DVD video discs recorded in any other colour system (SECAM, etc.).
- NTSC DVD or VCD discs will be playback in black and white if PAL only TV is used.
In this case, if your TV is RGB compatible, select "RGB" in the "Output" menu (see page 53).
Alternatively, use a multi-system TV.
- For MP3/JPEG/DivX® CD, see page 43.

Because of problems and errors that can occur during the creation of DVD and CD Software and/or the manufacture of DVD and CD discs, Toshiba cannot assure that the DVD player contained in this TV will successfully play every disc bearing DVD and CD logos. If you happen to experience any difficulty playing a DVD and/or CD disc on this DVD player, please contact Toshiba Customer Service.

DVD is a trademark of DVD Format/Logo Licensing Corporation.



Contents

Before using your unit

SAFETY PRECAUTIONS	2
Precautions	4
Notes on discs	5
Contents	7
Parts and functions	8
Display	9
Remote control	10
Basic connection	12
Playback connection	13

Setting up the VCR section

Tuning the TV stations and setting the time and date automatically	15
Setting the on-screen language	16
Setting the time and date manually	17
Tuning the TV stations manually	18

Tape playback operation

Loading and unloading a cassette tape	19
Cassette tape playback	20
Special playback	21
Repeat playback	22
Counter display	23
Video Index Search System	24

Recording

Recording a TV program	25
One-touch Timer Recording (OTR)	27
Timer recording	28

Advanced function of VCR section

Stereo recording and playback	30
Duplicating a video tape	32

Disc playback operation

Playing a disc	33
Zooming/Location desired scene	36
Marking desired scenes	37
Repeat playback/A-B Repeat playback	38
Program playback/Random playback (VCD/CD)	39
Changing angles/Title selection/DVD menu ...	40
Changing soundtrack language/Setting surround sound	41
Subtitles/To turn off the PBC/Disc status	42
MP3/JPEG/DivX® and Audio CD operation ...	43
Repeat and program playback using file browser	47

Advanced function of DVD section

Customizing the function settings	49
Temporary cancel the rating level by DVD disc	54
Language code list	55

Additional information

Problems and troubleshooting	56
Video head cleaning	57
Specifications	58

Parts and functions

Front

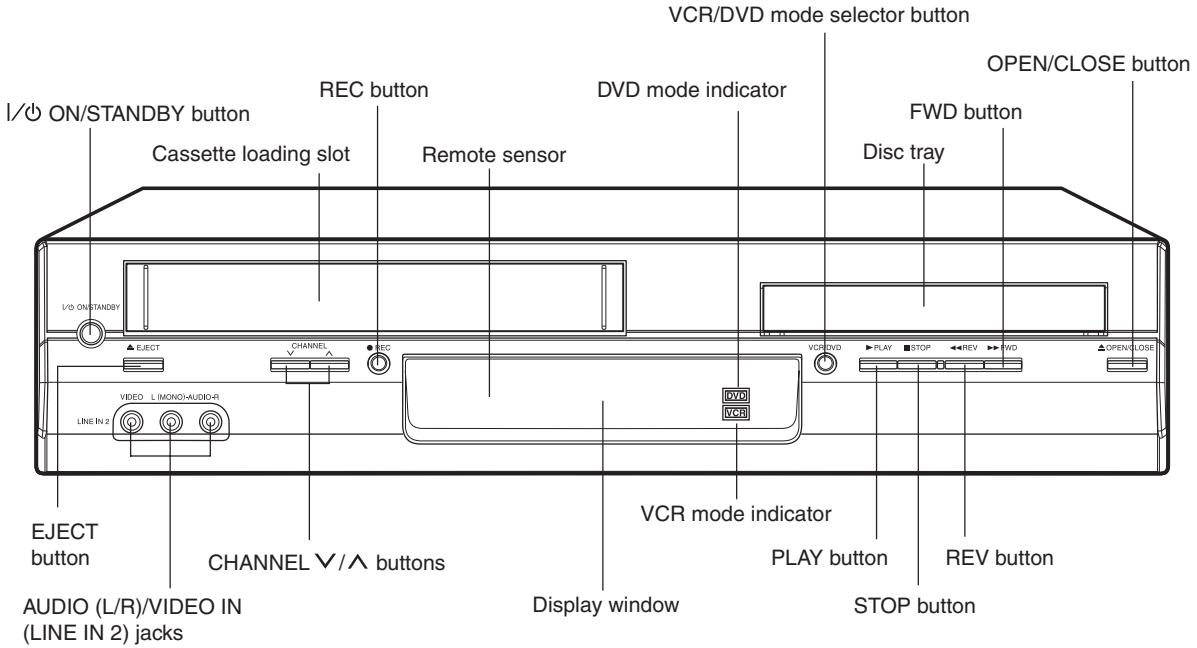

Rear

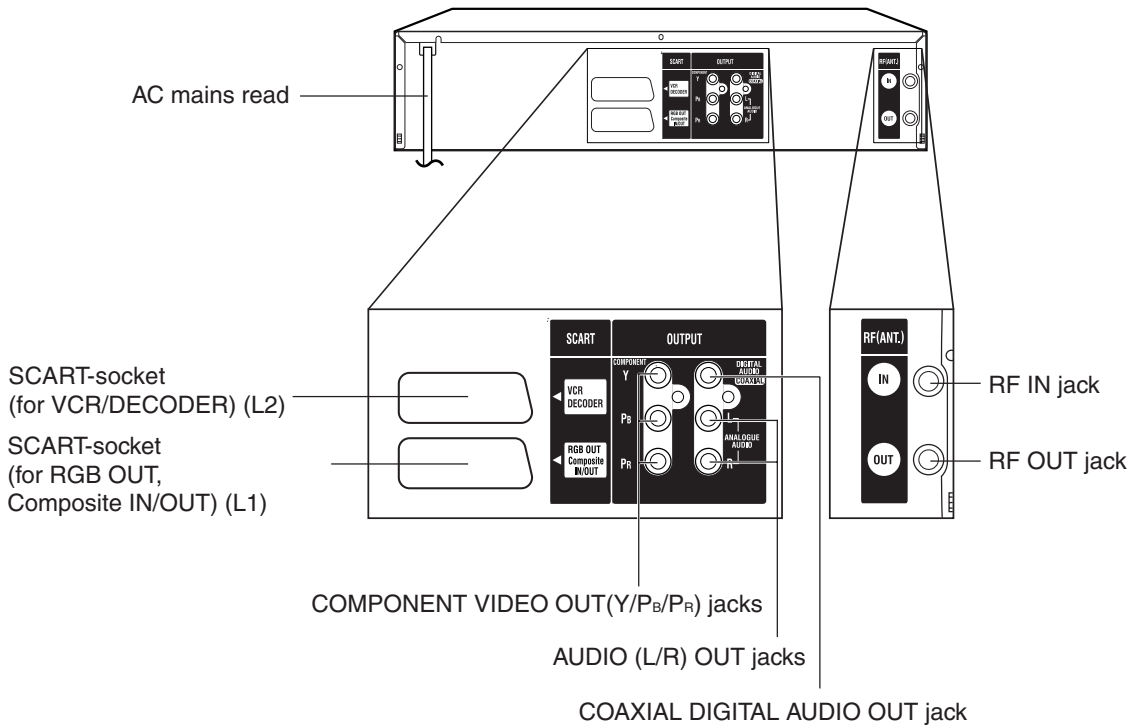



Display

Display window

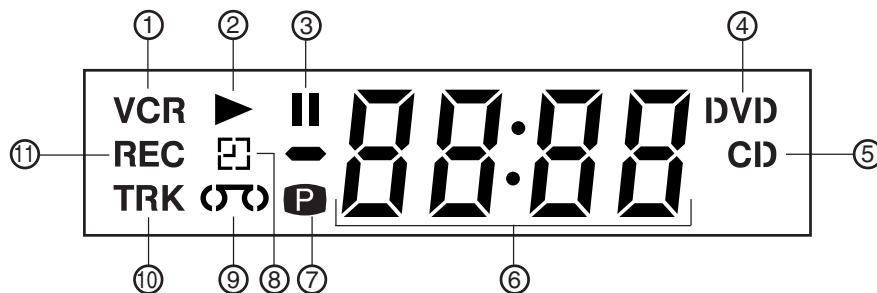

No.	Display	Description
①	VCR	VCR mode of TV/VCR switch
②	▶	Playback (lights) / Auto resume (flashes)
③	⏸	Still picture
④	DVD	DVD disc is inserted.
⑤	CD	CD is inserted.
⑥	10 : 00	Clock display (colon [:] flashes)
	01 : 00	Counter display by hour/minute at VCR/DVD / by minute/second at CD
	2	Track number display for CD
	CH 2	TV channel position display
	L1/L2/L3	External input display
⑦	P	Progressive indicator
⑧	⏸	Timer recording display
⑨	⏮	Video tape is in the unit
⑩	TRK	Track display for CD
⑪	REC	Normal recording display (flashes during One-touch Timer Recording - OTR)

Note:

Some discs may not playback correctly, or chapter number, playback time, etc. may not be displayed.



Remote control

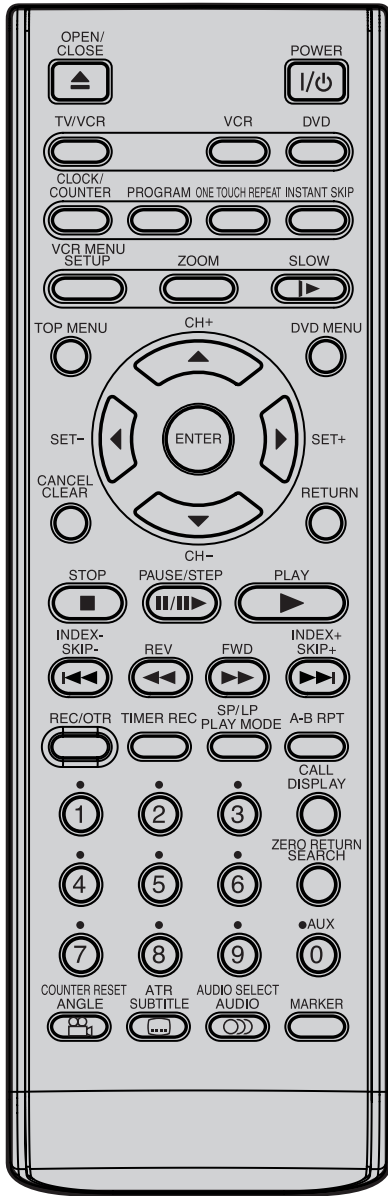

		Page
OPEN/CLOSE	Open or Close the tray	33,34,54
POWER I/⏻	Power on/off	16
TV/VCR	Switch to TV only at Scart connection	26
VCR	Select to operate VCR	16
DVD	Select to operate DVD	33
CLOCK/COUNTER	Change the front Display mode	23
PROGRAM	Confirmation of Timer-Recording	29
ONE TOUCH REPEAT	Skip back about 10 seconds of DVD playback	35
INSTANT SKIP	Skip the unwanted short material of a tape	21
VCR MENU/SETUP	Display menu of setup	16~18,49
ZOOM	Zoom (for DVD playback)	36
SLOW	Slowmotion playback	21,35
TOP MENU	Select title of a DVD disc	40,44,45
DVD MENU	Select menu of a DVD disc	40,45
▲ / ▼ / ◀ / ▶	Cursor buttons	
CH +/-	Select channel of the VCR	25,27,32
ENTER	Enter information in the menu Select option in the menu	
SET -/+	Manual tracking	21
CANCEL/CLEAR	Delete Timer program Cancel input data in the setting mode	15,36,37,39
RETURN	Remove DVD set up menu	49,54
STOP	Stop	20,25,33,34
PAUSE/STEP	Still picture/Recording pause on/off	21,25,32,34,35
PLAY	Playback	20~22,33~35
INDEX -/+	Search for the INDEX mark of a tape	24
SKIP ◀▶	Skip chapter to forward or reverse direction	35
REV	Rewind/Review playback	20,21,35
FWD	Fast Forward/Forward search playback	20,21,35
REC/OTR	Recording/OTR	25,27,32
TIMER REC	Timer recording On/Off	27,29
SP/LP	Sets the tape speed for recording	25,27
PLAY MODE	Select playback mode	38,39
A-B RPT	Repeat playback between A and B (DVD/CD)	38
0-9	Direct channel selection of TV Input setting Enter a security code	15,25,27 32,27,36,39 52,53
CALL/DISPLAY	Display VCR or DVD operation status	23,26,42
ZERO RETURN	Stop the tape when the counter reaches 00:00	23
SEARCH	Jump to desired scene	36
AUX	Scart Input or AV-Front input	13,29,32
COUNTER RESET	Reset the counter to 00:00	23
ANGLE	Change playback angle of a DVD disc	40
ATR	Auto tracking	21
SUBTITLE	Set Subtitle of a DVD disc	42
AUDIO SELECT	Switches sound between mono and stereo	31
AUDIO	Change soundtrack language of DVD	41
MARKER	Index (DVD)	37



Remote control

How to install the batteries

Use **micro batteries type UM-4 (R03/AAA-Size)**.

These batteries are offered as carbon / zinc-type or as alkaline-type. You may use both, but do not mix types. The alkaline type lasts longer compared to the carbon / zinc type but is more expensive.

Note: Flat, weak batteries will leak. **Corrosive** electrolyte will **damage** the remote control handset.

Leak proof batteries will not leak immediately when they are flat. As long as the handset is still working, there is no danger of leakage. To prevent damage, remove the batteries if you do not use the handset for several months.

Damage because of leakage is not covered by the guarantee.

- 1** Open the battery compartment cover in the direction of the arrow.

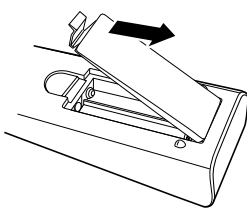

- 2** Install two "R03/AAA" batteries (supplied), paying attention to the polarity diagram in the battery compartment.

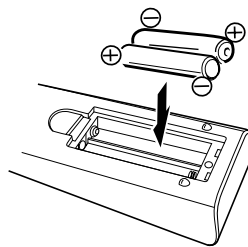

- 3** Replace the compartment cover.

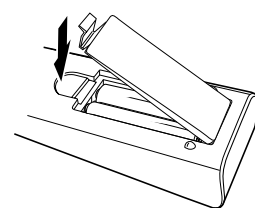

Distance of Remote Control Operation

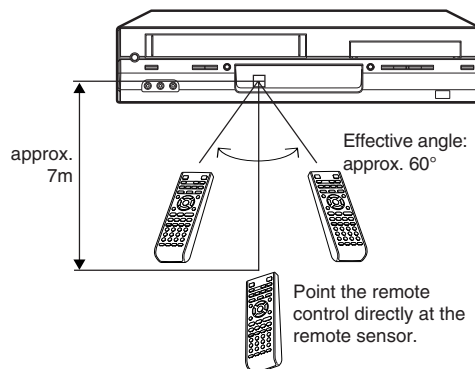

The remote control handset will not work properly in the following cases:

If bright sunlight directly beams onto the unit front.

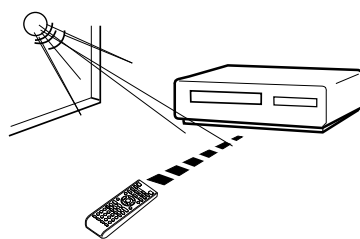

If an obstacle is placed between the unit and the handset.

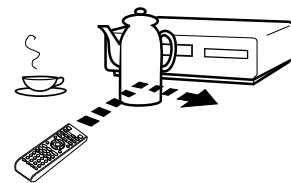

If the batteries have not been installed according to their polarities.

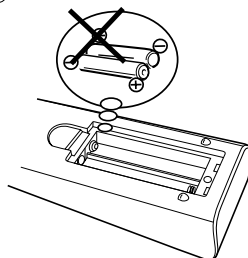

If the batteries are weak.

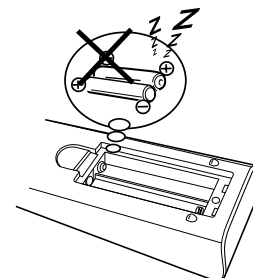

Basic connection

Connect your DVD/VCR to your home's aerial and to your TV-set as shown in the illustration. When you have finished these connections then connect your DVD/VCR to the 230 V / 50 Hz mains.

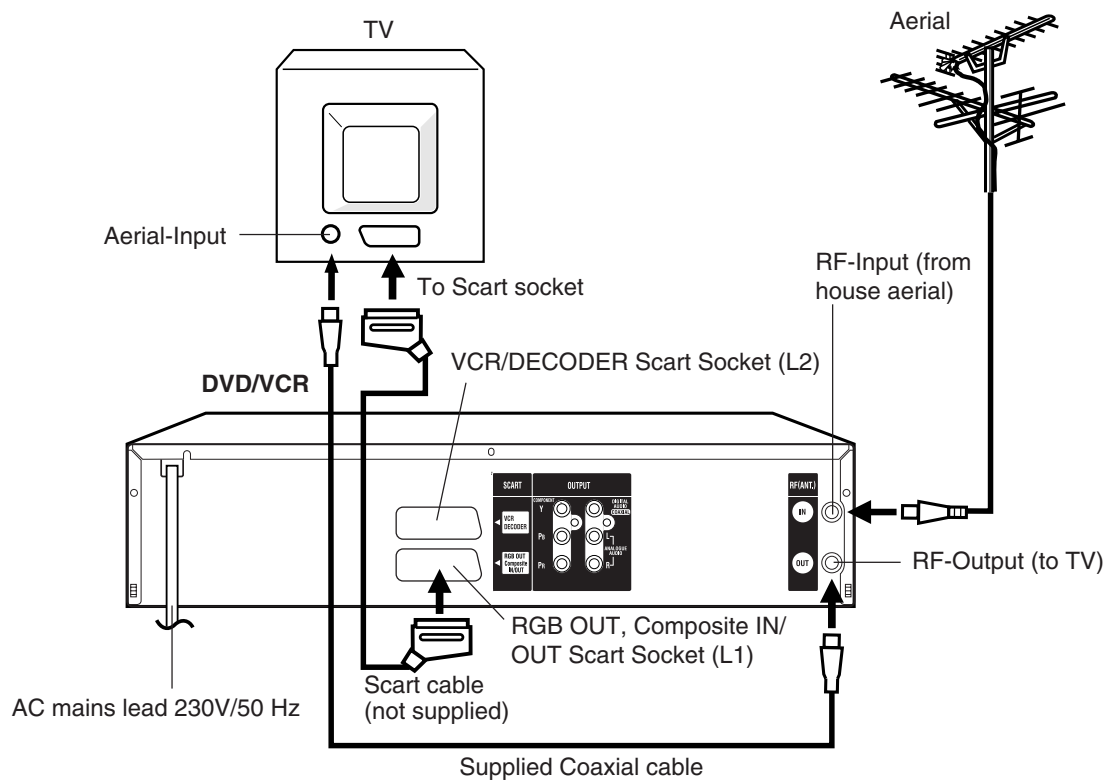

Connect a TV with the Scart socket

In addition to the coaxial cable connection, you should also connect the supplied SCART cable from the DVD/VCR to your TV as shown. As well as transferring the high quality pictures and sound to your TV, the SCART connection can automatically switch the TV to its AV channel for playback.

If your TV-set does not switch to video-playback operation automatically, please turn your TV's video switch to VIDEO position manually.

Note:

Make sure that both the television and the DVD/VCR are switched off before connecting the cables.

Playback connection

The exact arrangement you use to interconnect various video and audio components to the DVD/VCR is dependent on the model and features of each component. Check the Owner's Manual provided with each component for the location of SCART socket.

Connection to a Satellite Receiver

If a Satellite Receiver is used, we recommend the following configuration:

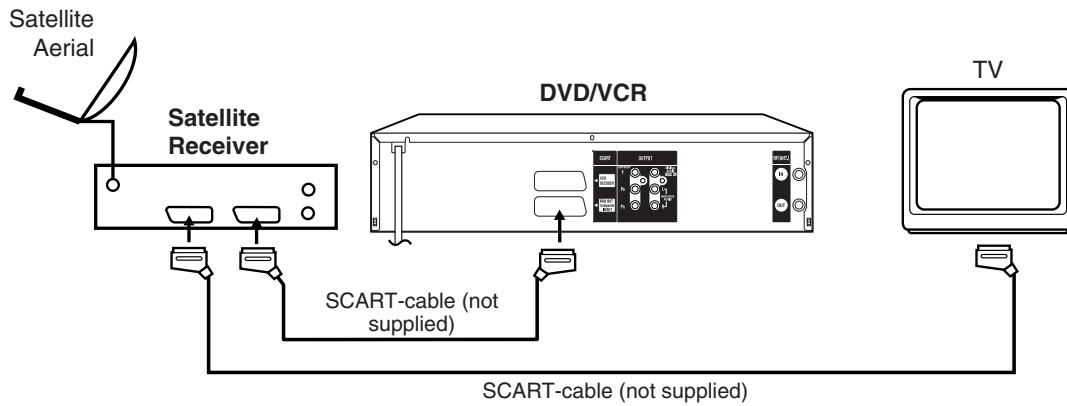

To record from Satellite Receiver press **AUX** on the remote control of DVD/VCR. "L1" will appear on the front display. Select the desired TV-program at Satellite Receiver.

Playback connection

Component video outputs/inputs

■ PROGRESSIVE outputs/inputs

Some TVs or monitors are equipped with component video inputs that are capable of reproducing a progressively scanned video signal. Connecting to these inputs allows you to view the highest quality pictures with less flicker.

■ INTERLACED outputs/inputs

Some TVs or monitors are equipped with component video inputs. Connecting to these inputs allows you to enjoy the highest quality DVD picture playback.

Connecting to an audio system and TV equipped with component video inputs

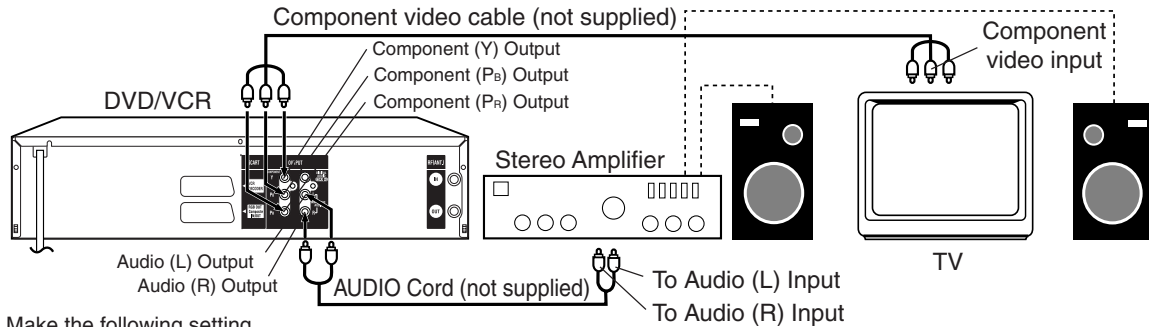

- Make the following setting

TV	On-screen display	See "Output" selection (P.53).
Interlaced inputs		"Component"
Progressive inputs		"Progressive"

Notes:

- Actual labels for component video inputs may vary depending on the TV manufacturer. (ex. Y, R-Y, B-Y or Y, CB, CR)
- In some TVs or monitors, the colour levels of the playback picture may be reduced slightly or the tint may change. In such a case, adjust the TV or monitor for optimum performance.

Note:

In connecting to a TV that are not capable of reproducing a progressively scanned video signal using the component sockets, do not select "Progressive" in "Output" menu. If you do it, the component video outputs does not feed the correct signals and you can not see any picture (see page 53).

Connect to an AV Amplifier with built-in digital surround

If you are using an Amplifier with a built-in digital surround as follows, you can enjoy the various audio systems such as Dolby Digital and DTS by using the Coaxial Digital Output.

Use this connection to connect an:

- AV amplifier with built-in Dolby Digital decoder
- AV amplifier with built-in DTS decoder

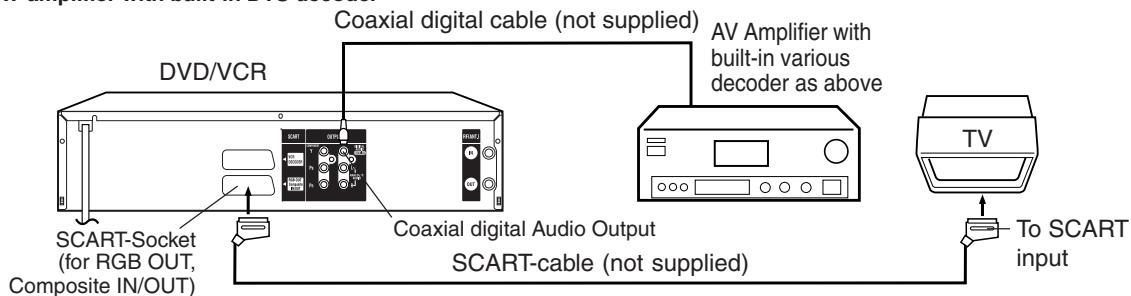

Notes:

- The COAXIAL jack is useful only for DVD section.
- DTS audio will be output only from the COAXIAL output. To hear DTS audio, DTS-Decoder is necessary. When playing DTS-encoded CDs, only noise will be heard from the speakers or analogue stereo outputs.
- Some DTS decoders which do not support DVD-DTS interface may not work properly with the unit.



Tuning the TV stations and setting the time and date automatically

Plug your DVD/VCR into the mains supply and it will start to automatically tune itself in and set the correct date and time.

Notes:

- The DVD/VCR automatically corrects the clock setting every hour and automatically adjusts the clock setting for Daylight Saving Time (see page 16).
- Your DVD/VCR will tune the TV stations as follows.

CH 1	BBC 1
CH 2	BBC 2
CH 3	ITV
CH 4	Channel 4
CH 5	Channel 5
CH 6	Satellite
CH 7	etc.
- Skipped channels still may be selected directly through the **Number buttons (0-9)**.
- To cancel skipping select the skipped channel using the **Number buttons (0-9)**, then press **CANCEL**. The channel No. does not blink any longer, and the channel No. now may be selected again using **CHANNEL** ∇/\wedge .

Preparation

- Make sure that your DVD/VCR is connected properly to the TV.
- Turn on the TV and switch the TV to it's AV channel.

- 1 Plug your DVD/VCR's plug into the mains supply. "Auto" will start to flash in the display. Your DVD/VCR will automatically tune itself in and set the correct time and date (This may take approx. 4 minutes).

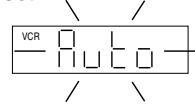

- 2 Press **POWER** I/ψ to turn OFF the DVD/VCR. The broadcast stations received will be turn on your unit.

To skip a channel position

Unwanted channels can be skipped so that they cannot be called up by pressing **CHANNEL** ∇/\wedge . Select the channel to be skipped, then press **CANCEL**. This channel's number will be flashing. That way you can cancel further channels one after the other.

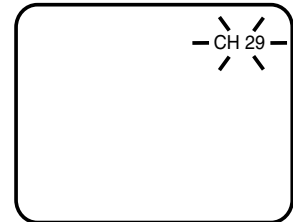
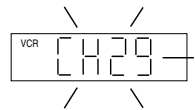

Setting the on-screen language

Turn on your TV and select the AV input mode. So you can follow the setting on TV screen.

Preparation:

- Press the **POWER** I/O button to turn on the DVD/VCR.
- Press **VCR** to select the VCR mode. (The VCR indicator will light.)

You can choose from five different languages for the on-screen displays.

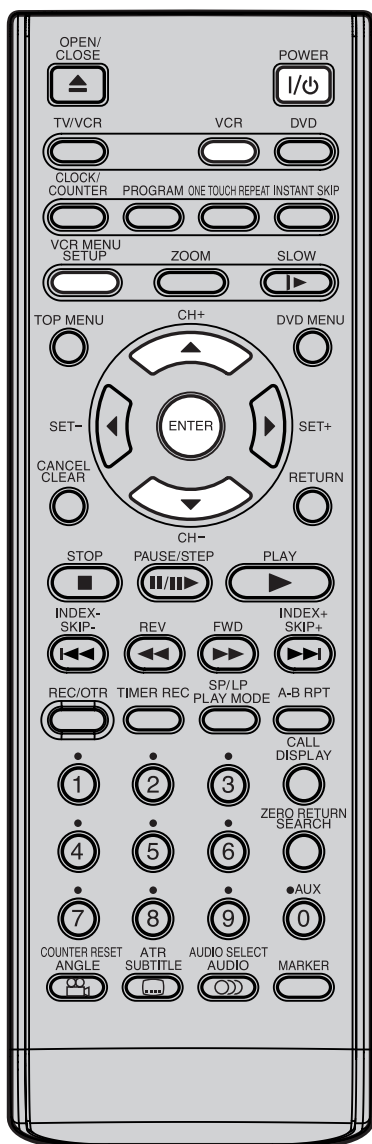

- 1 Press **VCR MENU**. Press ▲ or ▼ to select the **SYSTEM SETUP** menu, then press **ENTER**.
If you use the unit for the first time and press **VCR MENU**, instead of the main menu screen on the right the **LANGUAGE** setup menu screen in step 3 may appear.

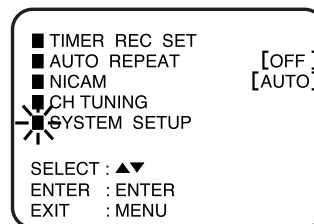

- 2 Press ▲ or ▼ to select the **LANGUAGE** option, then press **ENTER**.

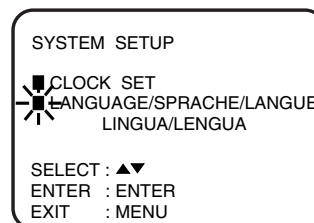

- 3 Press ▲ or ▼ to select the desired language: English, German (DEUTSCH), French (FRANCAIS), Italian (ITALIANO), Spanish (ESPAÑOL), then press **ENTER**.

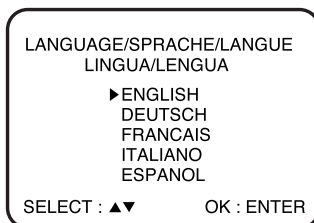

- 4 Press **VCR MENU** repeatedly until the TV picture appears on the screen.

Notes:

- If the unit does not operate properly, or No key operation (by the unit and/ or the remote control): Static electricity, etc., may affect the player's operation. Disconnect the AC power cord once, then connect it again.
- If no buttons are pressed for more than 60 seconds, the MENU screen will return to normal TV-operation automatically.



Setting the time and date manually

You must set the date and time manually for timer recordings if Auto setup process did not set them correctly.

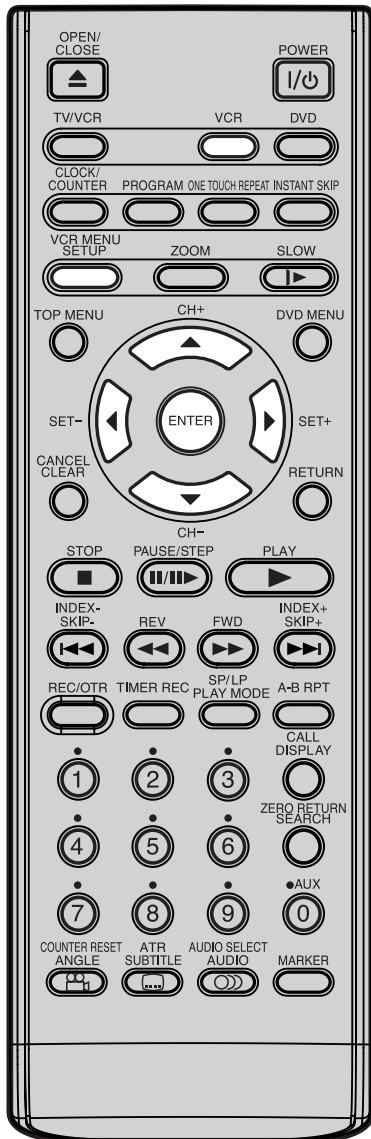

Preparation:

- Turn ON the TV and set to the AV input mode.
- Press **VCR** to select the VCR mode. (The VCR indicator will light.)

Example: Setting the clock to "11:30" October, 28 (SAT), 2006.

1 Press **VCR MENU**. The VCR menu screen will appear.

2 Press **▲** or **▼** to select **SYSTEM SETUP**, then press **ENTER**.

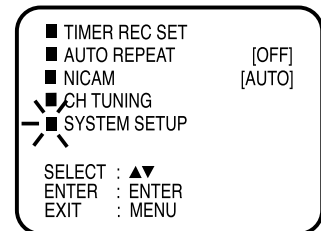

3 Press **▲** or **▼** to select **CLOCK SET**, then press **ENTER**.

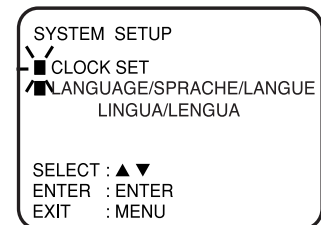

4 Press **◀** or **▶** repeatedly until "28" appears. Then press **▼**.

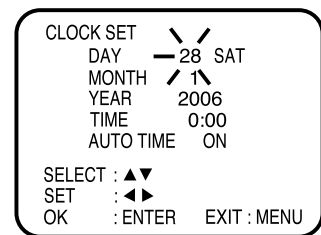

5 Set the **month, year, hour and minute** as in step 4. Then press **ENTER**.

- In case of an erroneous input, press **▲** to go back to previous step and enter again.

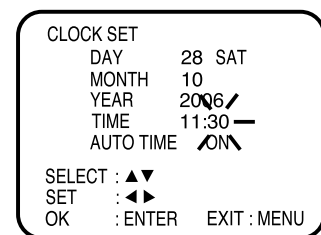

6 Press **◀** or **▶** to select **AUTO TIME ON** or **OFF**. The VCR automatically corrects the clock setting every hour once you set **AUTO TIME** to **ON**.

7 Press **VCR MENU** repeatedly until the TV picture appears on the screen.

8 The clock will begin operation.

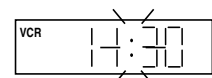

Notes:

- In case of a power failure, the clock will continue to operate for another 30 minutes with quartz-controlled precision. To indicate that the power failure has lasted for an excessive period of time "-:-:" will appear on the display. In this case readjust time and date.
- The **AUTO TIME** function adjusts the clock only if the error is within 5 minutes.
- The VCR automatically adjusts the clock setting for Daylight Saving Time once you set **AUTO TIME** to **ON**.



Tuning the TV stations manually

The Auto setup function (see page 15) memorizes all broadcasts to the suitable CH positions.

However some broadcast may not be memorized due to weak signal. In this case, use manual tuning function.

Preparation

- Turn ON the TV and set to the AV input mode.
- Press **VCR** to select the VCR mode. (The VCR indicator will light)

Example: Preset the BBC 2 on programme position 2.

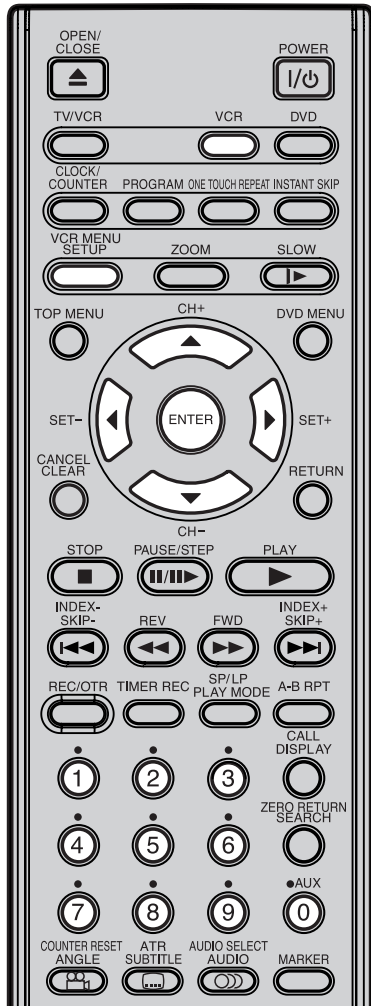

CH 01	BBC 1
CH 02	BBC 2
CH 03	ITV
CH 04	CH4
CH 05	CH5
CH 06	SATELLITE

Note:

Occasionally, the auto search might catch a weak signal and stop. If the TV station signal is weak, you shouldn't store this station.

In that case restart the auto search using ◀ or ▶.

- 1 Press **VCR MENU**. Press ▲ or ▼ to select the CH TUNING. Then press **ENTER**.

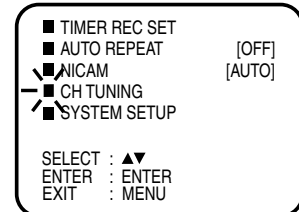

- 2 Press ◀ (falling frequency) or ▶ (rising frequency) once to start the search. It stops at each broadcast automatically ("▶" changes to "||"). Press ◀ or ▶ repeatedly until BBC 2 appears. Only in case of receiving of the weak broadcast (drifting picture), search does not stop. If you want to stop, press ◀ or ▶.

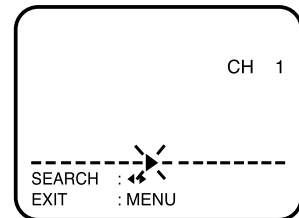

Press **ENTER** to preset. The search menu screen will disappear if the next mode is not activated in less than 50 seconds.

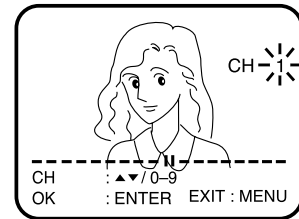

- 3 Press ▲ or ▼ repeatedly until 2 is displayed. (Or enter 0 2 with the **Number buttons (0-9)**). Then press **ENTER**.

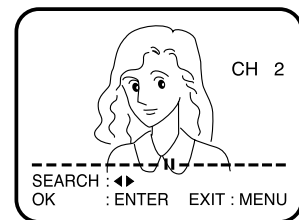

- 4 Repeat the steps 2 and 3 to preset other TV stations.

- 5 Press **VCR MENU** repeatedly until the TV picture appears on the screen.



Loading and unloading a cassette tape

Use only video cassette tapes marked **VHS**.

Loading

Push the center of the tape until it is automatically inserted.

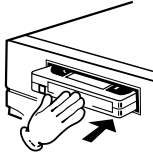

Insert the cassette tape with its labeled side facing up and the erase prevention tab positioned at your left. An inverted cassette tape cannot be inserted.

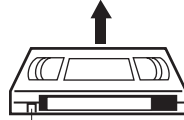

Erase prevention tab

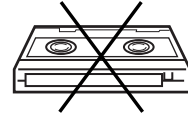

Automatic power ON

When you insert a cassette tape the DVD/VCR power will turn ON automatically.

Automatic playback

When loading a cassette tape without an erase prevention tab, playback will start automatically.

Unloading

1 Press **EJECT** on the DVD/VCR. Even if a tape is being played, press this button only once.

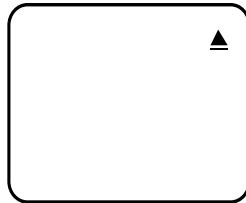
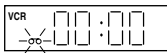

2 Remove the cassette tape.

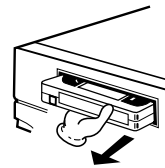

Automatic tape eject

This VCR will automatically rewind the tape when the tape has ended. And when the tape is rewinded to its beginning, the cassette tape will be ejected automatically.

To prevent accidental erasure

Remove the erase prevention tab with a screwdriver.

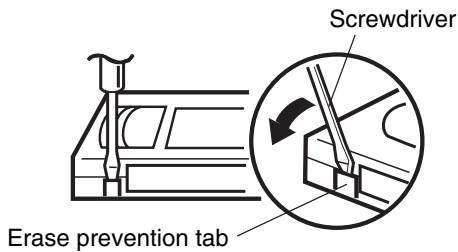

To record again

Cover the hole with a piece of adhesive tape.

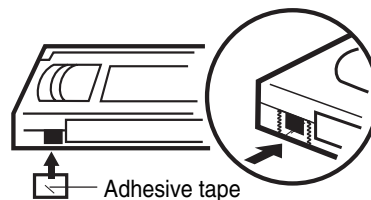

Cassette tape playback

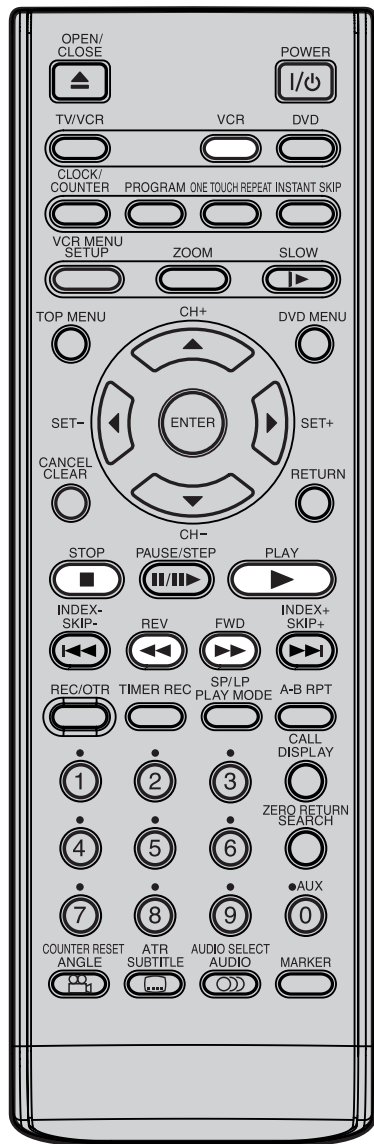

Preparation:

- Turn ON the TV and set to the AV input mode.
- Press **VCR** to select the VCR mode. (The VCR indicator will light.)

- 1 Load a prerecorded tape
(When loading a cassette tape without the erase prevention tab, playback will start automatically).

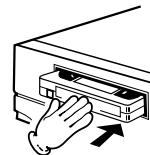

- 2 To start playback
Press **PLAY**.
Playback will start.



- To stop playback
Press **STOP**.

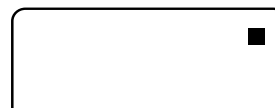
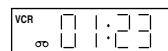

- To rewind the tape or forward it rapidly
Stop the playback or recording with **STOP**.

- To rewind the tape:
Press **REV**.

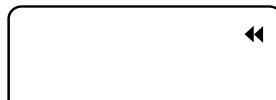

- To forward the tape:
Press **FWD**.

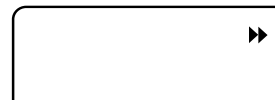

To stop the tape-winding, press **STOP**. To switch to playback directly (without **STOP**), press **PLAY**.

Forward/Reverse picture search mode

When the tape is being wound, you can switch to picture search mode (see next page). To do this, press **REV** or **FWD** and hold it down. The unit will resume the tape winding as soon as the button is released.

NTSC video cassette playback

When using a pre-recorded NTSC video cassette tape, the connected TV set must operate with a 60 Hz vertical frequency. Otherwise the on-screen picture will be affected by vertical rolling. Even if your VCR set is capable of processing NTSC video signals, the picture may be shortened vertically (appearance of black bars at the top and at the bottom of the TV screen). The dubbing of a NTSC video cassette tape to a standard PAL VCR is not possible.

Notes:

- This VCR selects the playback tape speed SP or LP automatically.
- The Cassette tape and DVD disc can be played back simultaneously. If you press **VCR** or **DVD**, the tape playback and DVD playback alternate with each other on the screen.

Special playback

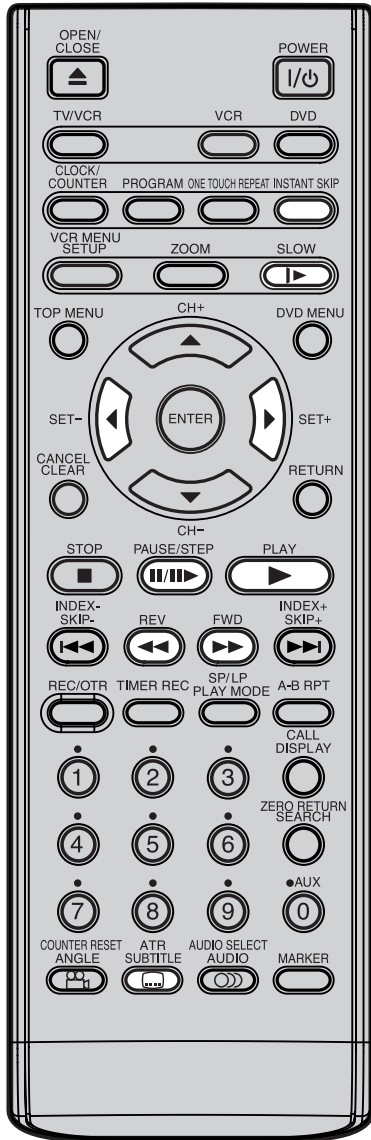

Picture Search

Reverse picture search function

Press **REV** x 1 or x 2 during the playback.

Forward picture search function

Press **FWD** x 1 or x 2 during the playback.
To return to playback: Press **PLAY**.

Still Picture

Press **PAUSE/STEP** during playback. To resume normal playback: Press **PLAY**.



Slow Motion

During playback press **SLOW**.

You can change the slow speed by the additional pressing of **SLOW**.

To return to playback: Press **PLAY**.



Slow tracking and vertical lock adjustment

If noise bars appear in the picture during slow motion, press the **SET +** or **-** to reduce the noise bars.

If the still picture jitters excessively, press **SET +** or **-** to stabilize the still picture.

Frame by Frame picture

During playback, press **PAUSE/STEP** one by one: The picture advances frame by frame.

To return to playback: Press **PLAY**.

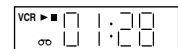

Adjusting tracking condition

Automatic tracking adjustment

Whenever you insert a tape and start playback, automatic tracking starts working and continuously analyzes the signal to enable optimum picture quality during playback.

Manual tracking adjustment

If automatic tracking cannot eliminate noises well during playback, press **SET +** or **SET -** to eliminate the noises. "MANUAL TR." will appear. Press it briefly for a fine adjustment, or press and hold for a coarse adjustment.

To return to automatic tracking, press **ATR**.

Notes:

- The audio output is muted during special playback.
- During picture search mode there will be noise bars which are caused by the system.
- The Special Playback will automatically change to playback after approx. 5 minutes to protect the video tape against excessive wear.

Instant skip

Press **INSTANT SKIP** during playback. The DVD/VCR will search forward through approximately 30 seconds of the tape (e.g. unwanted commercial time) for each press of **INSTANT SKIP** (maximum six presses) and then resume normal playback.

For example: 1 press: 30 seconds of tape
2 press: 60 seconds of tape
3 press: 90 seconds of tape

Repeat playback

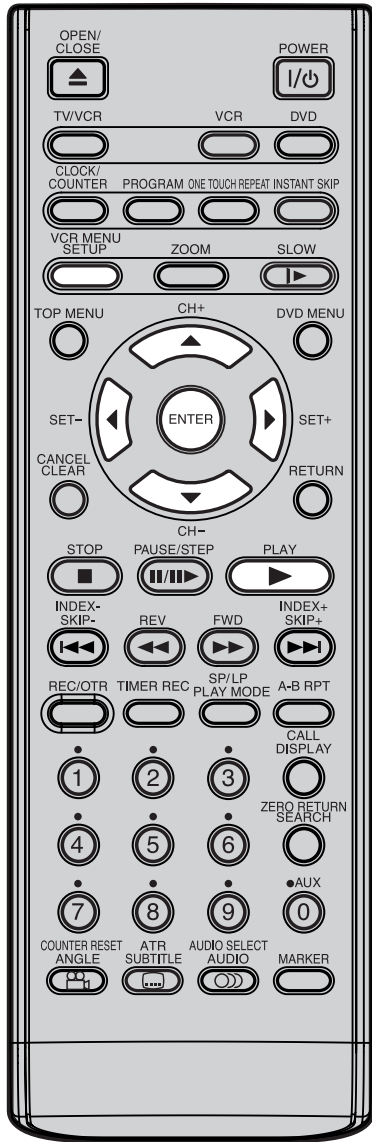

Normal repeat playback

The entire video tape will be played until its end. The tape will then automatically rewind to the beginning and the playback will be repeated.

- 1 Press **VCR MENU**. Press **▲** or **▼** to select **AUTO REPEAT**.

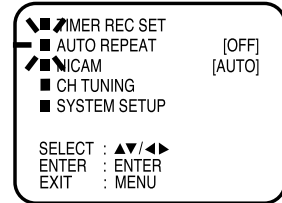

- 2 Then press **◀/▶** or **ENTER** to select **[ON]** or **[OFF]**.
If **[ON]** is selected, the playback will be repeated endlessly.

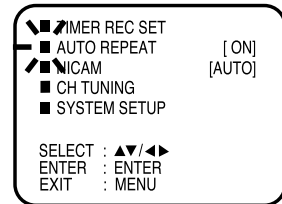

- 3 Press **VCR MENU** until the menu screen is cleared.

- 4 To start the playback, press **PLAY**.
The playback will be repeated endlessly.

To cancel normal repeat mode:

Follow the above step 2, then press **◀/▶** or **ENTER** to select the **OFF** position. Press **VCR MENU** to return to the TV.

Note:

If the unit is turned off or starts recording, the repeat mode is cancelled.



Counter Display

ZERO RETURN function

This function makes tape-rewinding stop at the counter 00:00:00 position automatically.

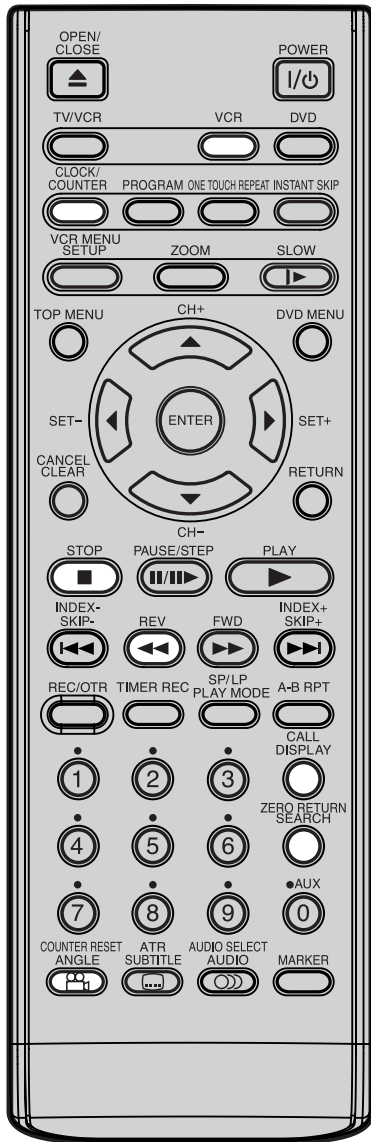

Preparation

- Turn ON the TV and set to the video input mode.
- Press **VCR** to select the VCR mode. (The VCR indicator will light.)

- 1 Press **CALL**.
The counter display shows the tape running time during playback or recording.
The Recorder will indicate REC during recording.

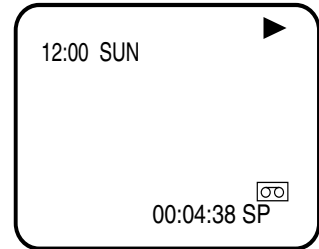
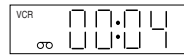

- 2 Press **COUNTER RESET** at the desired tape position. The counter display will be reset to the "00:00:00" position (e.g. the beginning of recording).

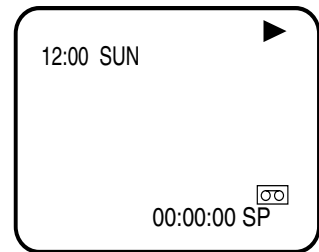

- 3 Press **STOP** when playback or recording is finished.
Press **ZERO RETURN**.
The tape will be rewinded and automatically stop at the "00:00:00" position.

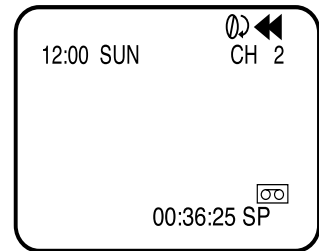

The CLOCK/COUNTER button

Press **CLOCK/COUNTER** during the playback. The clock and tape counter alternate with each other in the display.

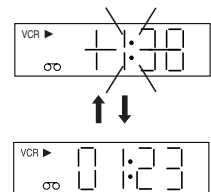

Notes:

- When you load a video cassette, the display indication changes to "00:00".
- The counter display does not function on non-recorded (blank) sections of the tape. When you rewind, fast forward or play tapes through blank sections, the counter display stops.

Note:

You can set the tape counter to 00:00:00 with **COUNTER RESET** anytime. Therefore, the counter display can also indicate 00:00:00, even when the tape counter does not reach its beginning yet. Even if the tape counter indicates 00:00:00, it can be rewinded. If the tape was rewinded over the point of 00:00:00, the minus mark (-) appears in the counter display. Although the tape counter seems to forward when you press **REV**, in fact the tape is being rewinded. When the tape reaches the beginning, the tape-rewinding stops automatically.



Video Index Search System

Whenever a recording is begun an invisible index mark is recorded on the tape. These index marks are all identical, and each mark means: "Here starts a new recording". Every DVD/VCR equipped with the Video Index Search System (VISS) can locate these marks at the beginning of any recording.

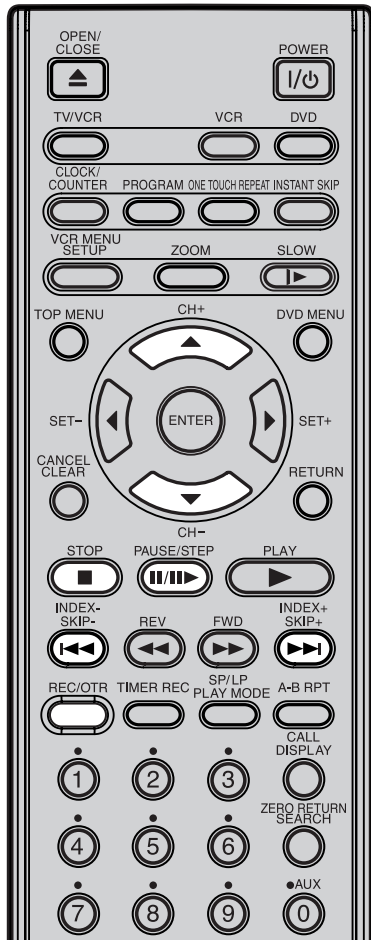

Notes:

- When you record an INDEX mark at the very beginning of the tape, the mark may not be found.
- During INDEX search, the tape may stop and begin to play at a slightly different location.
- INDEX may not function properly with old or worn out video tapes.
- INDEX marks may not be found if it is extremely close to the point where the search began.
- In recording, if you stop recording temporarily, the INDEX mark is not recorded on the tape.

Example: Indexing of TV commercials.

1 Start playback and wait until the end of the TV commercial is reached, then press **STOP**.



2 Press **REC/OTR** once. When the "INDEX" on-screen indication goes off, **STOP** may be pressed. This short recording process will be sufficient to set an index mark. This will result in about 10 seconds of the TV commercials to be overwritten by another recording. Due to the system the end of this recording will be followed by a recording gap (noise signal) of approx. 5 seconds.

Recording several Index Marks

Due to the system only one index mark will be recorded at the beginning of a recording. If you intend to set several index marks during a single recording, follow the procedure below:

1 At the point of the recording where an index mark is to be set press **PAUSE/STEP**. The unit will switch to the recording pause mode.

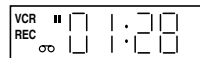

2 Press **CH +/-** repeatedly to switch back to the original TV program. Press **PAUSE/STEP** to resume recording.



Index Search

Press **INDEX +** or **-** during stop or play mode.

For Succeeding programs: Press **INDEX +**.

For Preceding programs: Press **INDEX -**.

(Additional press increases the INDEX NO. up to 9.)

When the **INDEX +** or **-** is pressed, the unit starts searching the INDEX NO. selected and finds the portion, then playback starts automatically.

To stop the Index Search, press **STOP**.



▶▶+3 or ◀◀ is displayed

INDEX NO. (up to 9)



Recording a TV Program

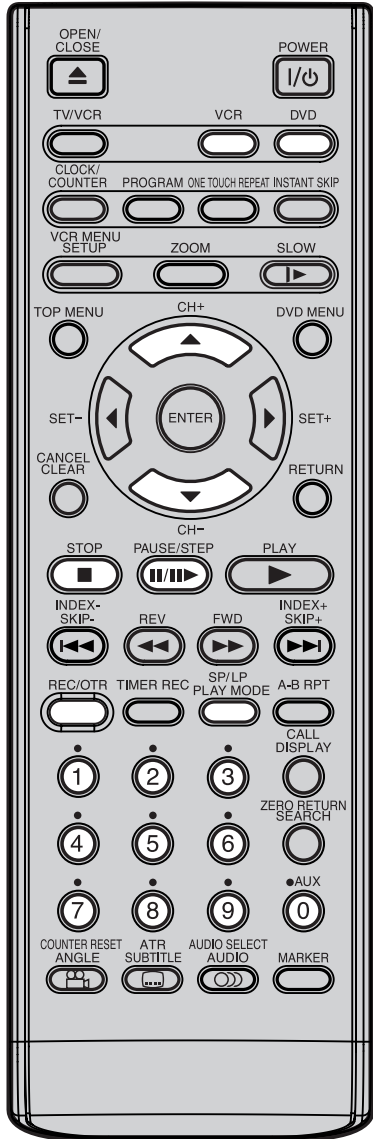

Preparation

- Turn ON the TV and set to the AV input mode.
- Press **VCR** to select the VCR mode. (The VCR indicator will light.)

- 1 Load a blank cassette tape with the erase prevention tab intact. (The DVD/VCR will automatically turn on.)

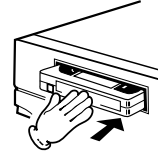

- 2 Select the program (e.g. 29) you want to record with **CH +/-** or **Number buttons (0-9)**.

1~9 : e.g. 5 = press "5"

10~80 : e.g. 29 = press "2" and "9".



- 3 If a recording in Long Play mode is intended, press **SP/LP** to display "LP".

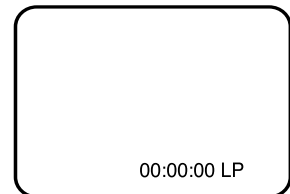

- 4 Press **REC/OTR** to start recording.



If the erase prevention tab is removed, the tape will eject when **REC/OTR** is pressed for recording. (see p.19)

To Stop Recording

Press **STOP**.



To Stop Recording Temporarily

To stop a recording for a short period of time press **PAUSE/STEP**. Press this button again if you want to resume the recording.



Notes:

- Since the DVD/VCR has a built-in TV tuner the TV set may be turned off when recording. The TV set may only be used to check for accurate program adjustments or to monitor recordings.
- If you wish to watch the DVD playback during the recording on VCR, press **DVD** to change to DVD mode and perform the DVD playback (see page 33).

Attention:

A safety circuit turns the pause mode off automatically after 5 minutes, and the DVD/VCR will stop the recording mode.

Recording a TV Program

You can record a program using the TV receiver of the DVD/VCR and at the same time watch another program on the TV set using its receiver. As the DVD/VCR automatically switches the TV set the following points should be observed:

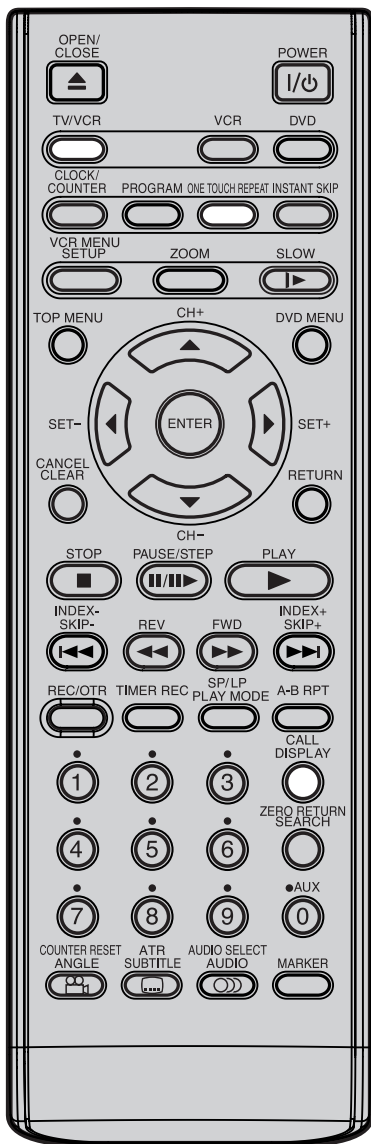

Auto Rewind Feature

The DVD/VCR will automatically rewind when the tape has ended (except during OTR and TIMER REC). It will also eject the cassette tape.

- 1 Press **TV/VCR** until "VCR" appears on the display. Select the program on the DVD/VCR you want to record. This program can be watched on the screen and recorded by the DVD/VCR.

"VCR" indicator goes on.



- 2 While the VCR is recording press **TV/VCR** until the "VCR" indicator on the display goes off. The TV set now displays the program of its built-in receiving module. Select the TV channel you want to watch on the TV set. Although the TV set now shows another program the DVD/VCR will continue recording the previously selected program.

"VCR" indicator goes off.



- 3 Using **TV/VCR** you can switch the TV screen between the DVD/VCR picture and the TV picture. If the "VCR" indicator is lit on the display, you will watch the DVD/VCR picture. This has no trouble on the recording.

"VCR" indicator goes on.



To Display VCR operation Status

Press **CALL**. The clock, day of the week and more informations will be indicated.

To cancel the indicating: Press **CALL** until all indicator disappear.

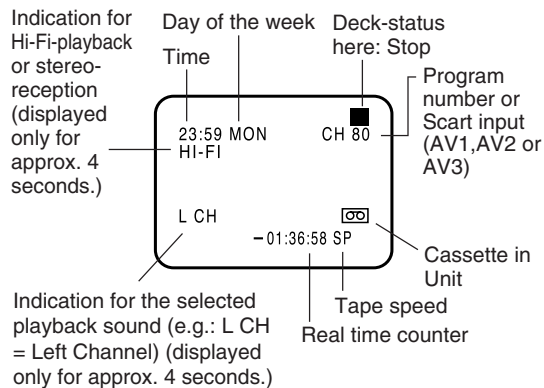



One-touch Timer Recording (OTR)

The one-touch timer recording feature provides a simple and convenient way to make a timed recording.

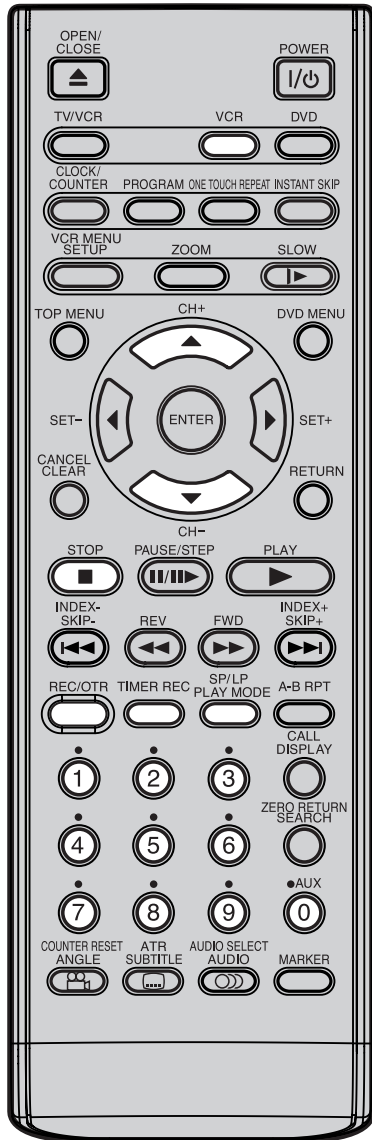

Note:

If the tape supply has not sufficed for OTR recording, the clock symbol (⌚) will blink at the tape-end and then VCR mode will change to DVD mode.

In this case, press **TIMER REC** to cancel the ⌚ blink or press **EJECT** on the DVD/VCR to remove the cassette tape.

Preparation

- Turn ON the TV and set to the AV input mode.
- Press **VCR** to select the VCR mode. (The VCR indicator will light.)

- 1 Load a blank cassette tape with the erase prevention tab intact. (The DVD/VCR will automatically turn on.)

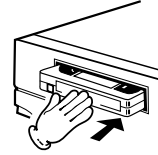

- 2 Select the program (e.g. 29) you want to record with **CH +/-** or **number** buttons.

1~9 : e.g. 5 = press "5"

10~80 : e.g. 29 = press "2" and "9".



- 3 If a recording in Long Play mode is intended, press **SP/LP** to display "LP".

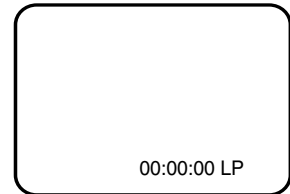

- 4 Press **REC/OTR** twice. The recording will start and stop after 30 minutes. Each additional press of **REC/OTR** will increase the recording time to a maximum of 6 hours (See table below).

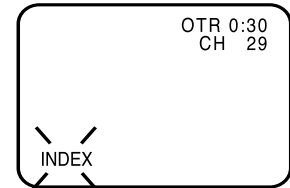

"REC" will keep blinking in the display.

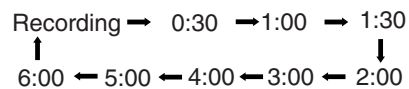

If **REC/OTR** is pressed once during the recording, the remaining time appears on the screen. When pressed again, the recording time is extended to the nearest 30-minute or 1-hour interval.

To Extend the Recording Time

Press **REC/OTR** repeatedly until the desired time appears on the display.

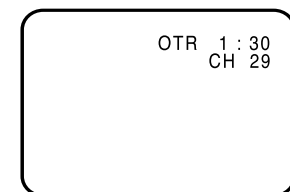

To stop the OTR

Press **STOP**.



Timer recording

Timer recording can be programmed on the TV-screen with the remote control. The built-in timer allows automatic unattended recording of up to 8 programs within 1 month.



Notes:

- In the event of a power failure the data of the automatic recording will be maintained in the built-in memory for about 30 minutes. Also, the clock will continue to run for this period of time. Thereafter the data will be deleted. When the power resumes, the time display will change to "--:--" that the timer setting will have to be set.
- Not all TV Stations transmit PDC signal all of the time, therefore it is advisable to check before setting PDC to ON, if you do set PDC to ON and no signal is received your recording might not take place at all. To check PDC status, change to the channel on your DVD/VCR you wish to record from, if the word "PDC" appears on the screen for a few seconds then that channel is broadcasting PDC and you can set the feature to ON.

Preparation

- Turn ON the TV and set to the AV input mode.
- Press **VCR** to select the VCR mode. (The VCR indicator will light.)
- Load a video cassette with the erase prevention tab intact. Make sure with **CALL** that the time and date are correct.(see page 29).

Example: Timer recording for channel 1, 13:00 to 14:30 with Tape speed LP on timer program number 1.

1 Press **VCR MENU**. Press **▲** or **▼** to select **TIMER REC SET**. Then press **ENTER**.

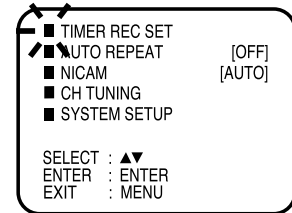

2 Each line stands for one program of the 8 memories. Select one line with **▲** or **▼**. Then press **ENTER**.

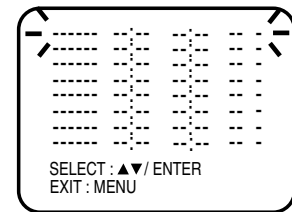

3 Set the desired **date** with **◀** or **▶** or **Number buttons (0-9)**. Then press **▼** to accept it.

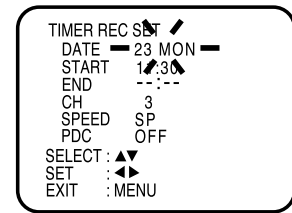

4 Set the **Starting time (13:00), ending time (14:30), channel (1) and Tape speed (LP)** in the same way as the step 3.

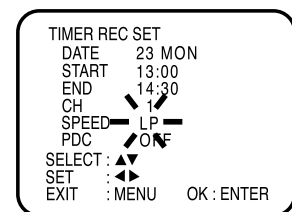

- In case of an erroneous input press **▲** to go back to before step and enter again.

To record with the PDC (Programme Delivery Control) system

The PDC system starts recording when it picks up a special signal transmitted by the broadcaster with the TV programme – even if the TV programme starts early, late or runs on longer than scheduled. In step 4, press **▼** repeatedly until PDC OFF flashes, then press **◀** or **▶** to display "ON" for recording with PDC.

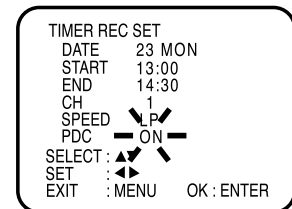

....to be continued to next page



Timer recording

5 Press **ENTER** to accept them.

To enter other programs, repeat steps 2 through 5.

- To return to the normal screen, press **VCR MENU** twice.

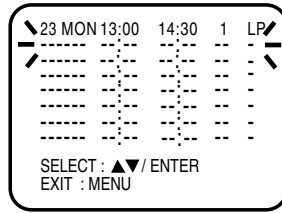

6 Press **TIMER REC**. The clock symbol (⌚) will appear on the display and the DVD/VCR stands by for recording. At the same time, VCR mode will change to DVD mode automatically. You can use DVD even if the VCR is in the Timer recording mode. If you do not use the DVD, turn the power off.

- If the clock symbol (⌚) blinks in the display in spite of the pressing of **TIMER REC**, the cassette may not have been loaded yet. (see page 19)
- If the cassette is ejected in spite of the pressing of **TIMER REC**, the erase prevention tab of the cassette may have been removed. (see page 19)

Notes:

- In case of the timer recording from the scart socket, proceed as follows: In step 4 press ▲ or ▼ repeatedly until the "CH" line blinks. Then press ◀ or ▶ repeatedly until "AV1" or "AV2" or "AV3" appears.
- If the clock symbol (⌚) blinks when the timer recording ended, the TV program has not been completely recorded because of an insufficient tape supply. Press **TIMER REC** to cancel the timer program or press **EJECT** on the DVD/VCR to remove the cassette tape.
- During timer recording standby mode, the VCR mode cannot be selected. To use the VCR, press **TIMER REC** at first, then press **VCR** to change to VCR mode. After you use the VCR, press **TIMER REC** again to put the VCR into timer recording standby mode.

Timer Recording Special Case

Weekly (e.g. WKL-TUE: each Tuesday) or daily (e.g. MON-SAT: Monday to Saturday) Timer recording

Follow the procedure for timer recording on page 28. At picture 3 press ◀ or ▶ repeatedly until the desired setting appears. Then press ▼. When you press ◀ or ▶ repeatedly, the indicator at DATE will change as follows, in case today is Friday.

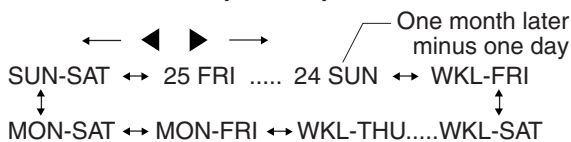

MON-SAT = everyday from Monday to Saturday
WKL-SAT = each Saturday

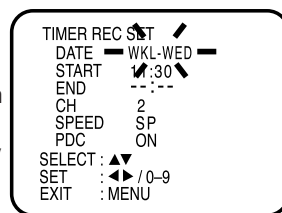

In case of Timer programs-overlapping

Do not overlap timer programs as portions of the conflicting programs will be lost. The first recording time has priority over the next recording time as shown in the diagram below.

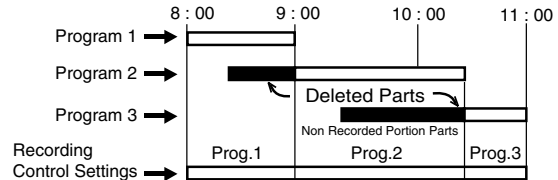

Notes:

- The daily/weekly recording can be made continuously until the recording is canceled or the tape reaches the end.
- During timer recording the automatic rewinding mechanism does not function.

Confirmation / Cancellation of the Timer Recording

1 If the Timer has been activated, now press **TIMER REC** to deactivate the Timer. The clock symbol (⌚) will disappear. Then press **VCR** to change to VCR mode.

2 Press **PROGRAM**. All the 8 Timer memories will appear.

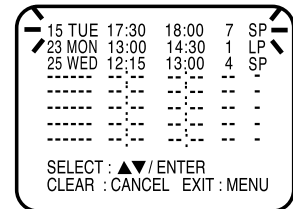

3 To cancel Timer program: Press ▲ or ▼ to select the written line. Then press **CANCEL**. This line is now canceled.

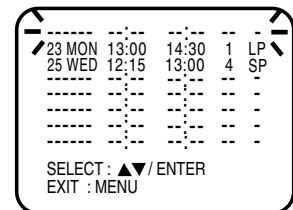

4 Press **VCR MENU** (or **PROGRAM**) repeatedly until the TV-picture appears.



Stereo recording and playback

This DVD/VCR is capable of recording sound in Hi-Fi system. The recording will be performed automatically. NICAM STEREO broadcasts are recorded in its original sound system regardless of the setting. If you wish to record NICAM programmes, select NICAM "AUTO" as follows.

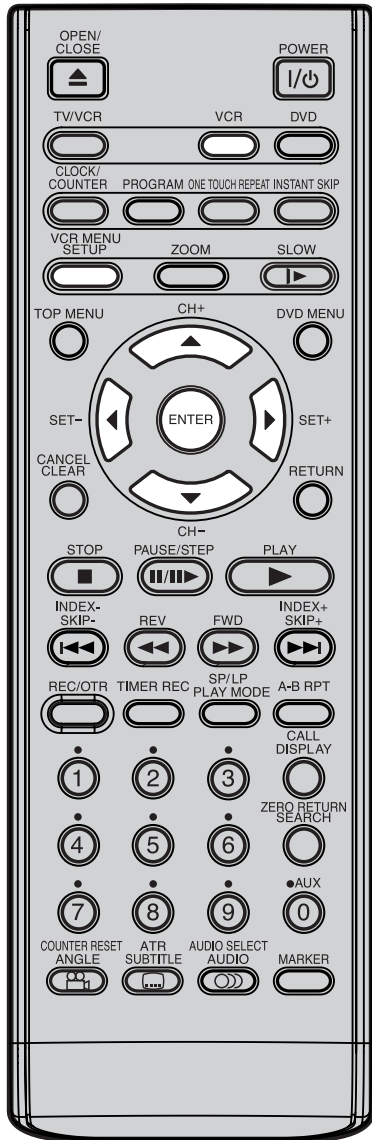

Preparation:

- Turn ON the TV and set to the video input mode.
- Press **VCR** to select the VCR mode. (The VCR indicator will light.)

NICAM stereo sound reception:

- 1 Press **VCR MENU**. Press **▲** or **▼** to select NICAM. Then press **◀/▶** or **ENTER** to select [AUTO].

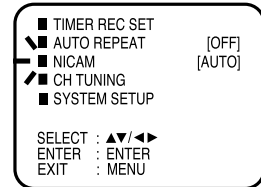

- 2 Press **VCR MENU** repeatedly until the TV picture appears.

NICAM programmes are divided into 4 types as shown below.

NICAM STEREO broadcast
"NICAM ST" illuminates when a NICAM STEREO broadcast signal is received.

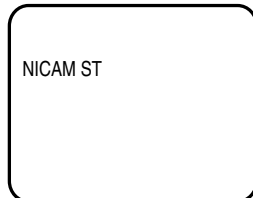

NICAM MONO A broadcast
"NICAM M1" illuminates when a NICAM MONO A broadcast signal is received.

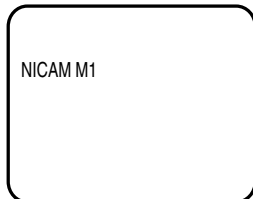

NICAM MONO A B broadcast
"NICAM M1/2" illuminates when a NICAM MONO A and MONO B broadcast signal is received.

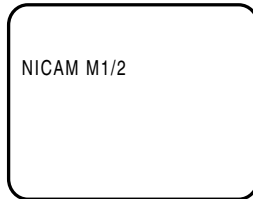

NICAM OFF
It will be displayed for the NICAM signal when the "NICAM [OFF]" is selected in menu screen.

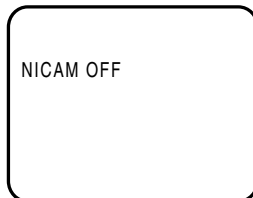

Note:

When listening to a stereo broadcast or playing back a Hi-Fi tape recorded in stereo, you have to connect the DVD/VCR with the stereo audio system or the stereo TV. The sound which is output from the RF OUT jack is monaural.



Stereo recording and playback

Playback

Use **AUDIO SELECT** to select under stereo/mono or bilingual playback. See the table below for more information.

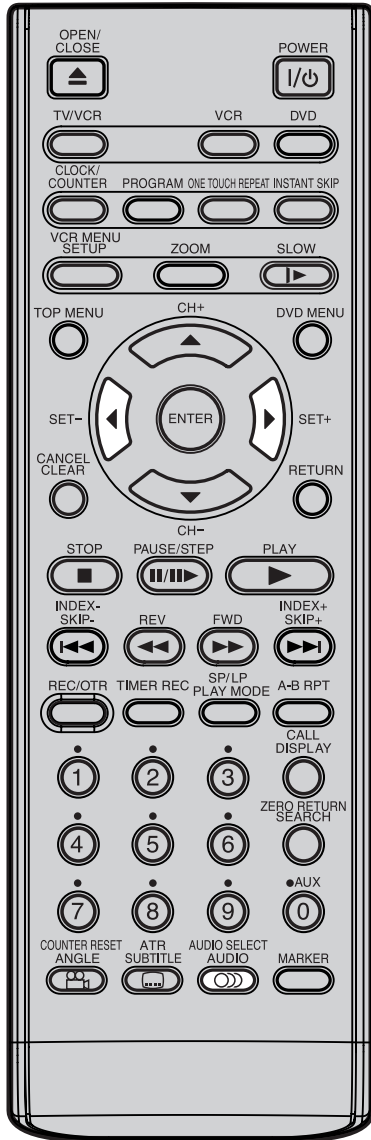

On-screen indications (for 4 sec.)	Stereo playback performed in:	Bilingual playback performed as follows:
STEREO	Stereo	Simultaneously both languages from Hi-Fi track (Mixed sounds)
L CH	Left channel signal output from both loudspeakers	One's mother tongue dubbing (Main sound)
R CH	Right channel signal output from both loudspeakers	Original sound track (Sub sound)
MONO	Mono	One's mother tongue dubbing (Main sound)

HiFi signal indication

It will be displayed for approx. 4 seconds when playing HiFi video cassette tapes.



Note:

When playing Hi-Fi cassette tapes recorded on another VCR, the sound output may be distorted. This is normal and no indication of a unit malfunction. Try to minimize sound distortions by using **SET +/-** or change to MONO by pressing **AUDIO SELECT**.



Duplicating a video tape

When you try to connect with a cable, make sure the power of both units have been turned off. Connect the recording unit with the TV. Therefore you can just watch what the recording unit is recording.

- 1 Load a blank cassette tape with the erase prevention tab intact into the recording DVD/VCR. Load the previously recorded cassette tape into the playback VCR or a video camera.

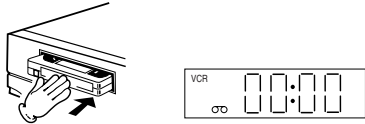

- 2 Use **AUX** or **CH +/-** of the recording DVD/VCR to select the "L1", "L2" or "L3" instead of the preset channel.

- L1 = TV-RGB/Composite Scart Socket
- L2 = VCR/DECODER Scart Socket
- L3 = Front AV jacks

- 3 Press **REC/OTR** and then **PAUSE/STEP** of Recording unit.
- 4 Press **PLAY**-button and then **PAUSE/STEP**-button of Playback unit. Now you can see the still picture of the scene that you wish to duplicate.
- 5 Press **PAUSE/STEP** of both units simultaneously to start the duplicating.

Note:

Before starting the duplicating process, select the proper tape speed using **SP/LP**. For a pre-recorded tape the correct tape speed will be set automatically during playback.

Connection with second Video recorder or Video camera

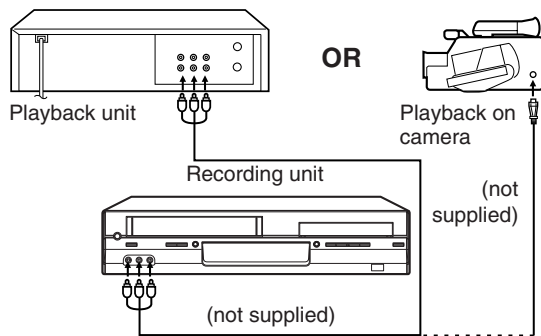

Press **AUX** on the recording unit repeatedly until L3 appears.

Duplicating a disc material onto a video tape

You can record disc material in DVD, Video CD, Audio CD, etc. onto a video tape with this DVD/VCR only. If the DVD disc has a Copy-guard feature, the duplicating is not possible. A symbol mark "© → [X]" will appear on the screen for approx. 4 seconds. See page 33 for more information about the DVD playback.

Preparation:

- Load a cassette tape with the erase prevention tab intact.
- Select the tape speed in the VCR mode. (see P.25)
- Load a disc you wish to duplicate.

- 1 Press **DVD** to select the DVD mode. (The DVD indicator will light)
- 2 Press **PLAY** to start the disc playback.

- 3 During disc playback, press **REC/OTR**.

Notes:

- You can set the duplicating time using the OTR-function. At step 3 above press **REC/OTR** repeatedly until the desired duplicating time appears on the screen. (P.27)
- Only non-protected PAL discs can be dubbed to video tape.

* Unauthorized recording of copyrighted television programs, films, video cassettes and other materials may infringe the rights of copyright owners and be contrary to copyright laws.





Playing a disc

This section shows you the basics on how to play a disc.

CAUTION

Keep your fingers well clear of the disc tray as it is closing. Neglecting to do so may cause serious personal injury.

Basic playback

Preparations:

- When you want to view a disc, turn on the TV and select the corresponding video input connected to the DVD. This may include S-video or component video inputs which are exclusive to DVD playback.
- When you want to enjoy the sound of discs from the audio system, turn on the audio system and select the input connected to the DVD/VCR.

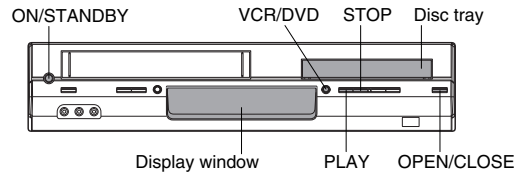

1 Press ON/STANDBY.

The DVD/VCR turns on.



2 Press VCR/DVD to select the DVD mode.

The DVD indicator will light.



3 Press OPEN/CLOSE.

The disc tray opens.



4 Place a disc on the disc tray.

With the playback side down

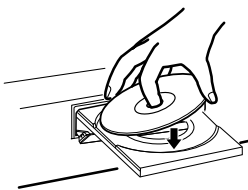

- There are two different disc sizes. Place the disc in the correct guide on the disc tray. If the disc is out of the guide, it may damage the disc and cause the DVD/VCR to malfunction.
- Do not place a disc which is unplayable in this DVD/VCR.

5 Press OPEN/CLOSE or PLAY on the unit.

The disc tray closes automatically. On the TV-screen, "▲" changes to "Reading" and then playback commences.

▲ OPEN/CLOSE

▶ PLAY



6 Press ▲/▼ or ◀/▶ to select title.

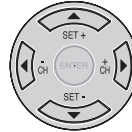

7 Press ENTER.

- Title is selected and play commences.



8 Press STOP to end playback.

■ Resuming facility

- The unit records the stopped point, depending on the disc. "■" appears on the screen. Press **PLAY** to resume playback (from the scene point).
- If you press **STOP** again ("■" appears on the screen.), the unit will clear the stopped point.

■ STOP



■ To start playback in the stop mode

Press **PLAY**.

▶ PLAY





Playing a disc

■ To pause playback (still mode)

Press **PAUSE/STEP** during playback.



To resume normal playback, press **PLAY**.



- The sound is muted during still mode.

■ To stop playback

Press **STOP**.



■ To remove the disc

Press **OPEN/CLOSE**.



Remove the disc after the disc tray opens completely.

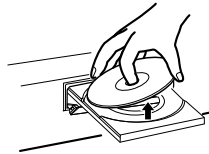

Be sure to press **OPEN/CLOSE** to close the disc tray after you remove the disc.

■ Playing a Disc while the VCR section is recording or standing by for timer recording

- 1) Start to record.
Follow steps 1~5 on page 25.
 - If the DVD/VCR is standing by for recording, turn on the DVD/VCR.
- 2) Press **VCR/DVD** to select DVD mode.
- 3) Play a disc.
Follow steps 3 ~ 5 on page 33.
 - Press **PLAY** if the DVD/VCR does not start to play a disc automatically.
- 4) Stop playback.
Press **STOP** to stop playing a disc.

■ Screen saver function

The screen saver operates when you leave the unit in DVD stop mode for approx. five minutes. The screen will repeatedly get dark gradually and back to normal. Please press any button when you want to return to an usual screen. To turn on or off the screen saver, see page 51.

Notes:

- If a non-compatible disc is loaded, "Incorrect Disc", "Region Code Error" or "Parental Error" will appear on the TV screen according to the type of loaded disc. In this case, check your disc again (see page 6 and 52).
- Some discs may take a minute or so to start playback.
- When you set a single-faced disc label downwards (i.e. the wrong way up) and press **OPEN/CLOSE** or **PLAY** on the unit, "Reading" will appear on the display for a few minutes and then "Incorrect Disc" will continue to be displayed.
- Some discs may not work the resuming facility.
- Resuming cannot function when you play a PBC-featured Video CD while the PBC is on. To turn off the PBC, see page 42.
- Some playback operations of DVDs may be intentionally fixed by software producers. Since this unit plays DVDs according to the disc contents the software producers designed, some playback features may not be available. Also refer to the instructions supplied with the DVDs.
- Do not move the unit during playback. Doing so may damage the disc.
- Use the **OPEN/CLOSE** to open and close the disc tray. Do not push the disc tray while it is moving. Doing so may cause the unit to malfunction.
- Do not push up on the disc tray or put any objects other than discs on the disc tray. Doing so may cause the unit to malfunction.
- In many instances, a menu screen will appear after playback of a movie is completed. Prolonged display of an on-screen menu may damage your television set, permanently etching that image onto its screen. To avoid this, be sure to press **POWER** on your remote control once the movie is completed.
- There may be a slight delay between the button is pressed and the function activates.

■ To obtain a higher quality picture

Occasionally, some picture noise not usually visible on the TV screen during a normal broadcast may appear while playing a DVD video disc. It is because due to high resolution pictures on these discs which include a lot of information. The amount of noise depends on the disc you use with this unit. You should generally reduce the sharpness adjustment on your TV when viewing DVD video discs.



Playing a disc

You can play discs at various speeds.

Playing in fast reverse or fast forward directions

Press **REV** or **FWD** during playback.



REV: Fast reverse playback
FWD: Fast forward playback

Each time you press **REV** or **FWD**, the playback speed changes.

■ To resume normal playback

Press **PLAY**.



Notes:

- The DVD/VCR mutes sound during reverse and forward scan of DVD/VCD video discs.
- The playback speed may differ depending on the disc.

Playing frame by frame

Press **PAUSE/STEP** during still playback.



Each time you press **PAUSE/STEP**, the picture advances one frame.

■ To resume normal playback

Press **PLAY**.



Note:

The sound is muted during frame by frame playback.

Playing in slow-motion

Press **SLOW** during playback.



Each time you press the button, the slow-motion speed changes.

■ To resume normal playback

Press **PLAY**.



Note:

The sound is muted during slow-motion playback.

Locating a chapter or track

Press **SKIP**  or  repeatedly to display the chapter or track number you want.

Playback starts from the selected chapter or track.



To locate succeeding chapters or tracks.



Playback starts from the beginning of the current chapter or track.

When you press twice in quick successions, playback starts from the beginning of the preceding chapter or track.

One touch repeat

Press **ONE TOUCH REPEAT** during playback.

The playback skips back about 10 seconds and starts playing again.

If you press **ONE TOUCH REPEAT** again after the skipping back, it skips back a further 10 seconds.



Notes:

- Some discs may not work with the one touch repeat function.
- Some functions may be unavailable due to the disc configuration.
- Depending on the playback status, one touch repeat may not skip back as intended.

Notes:

- A prohibition symbol "X" may appear at the upper right of the screen. This symbol means either the feature you tried is not available on the disc, or the DVD/VCR cannot access the feature at this time. This does not indicate a problem with the DVD/VCR.
- The unit is capable of holding a still video image or On screen display image on your television screen indefinitely. If you leave the still video image or On screen display image displayed on your TV for an extended period of time, you risk permanent damage to your television screen. Projection televisions are very susceptible.



Zooming/Locating desired scene

Zooming

This unit will allow you to zoom in on the frame image. You can then make selections by switching the position of the frame.

1 Press ZOOM during playback.



The center part of the image will be zoomed in. Each press of **ZOOM** will change the ZOOM Q1 (x 1.3), Q2 (x 1.5) and Q3 (x 2.0).

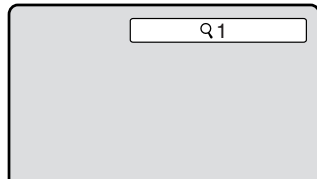

2 Press ▲/▼/◀/▶ to view a different part of the frame.

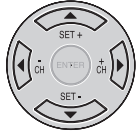

You may move the frame from the center position to UP, DOWN, LEFT or RIGHT direction.

3 In the zoom mode, press ZOOM repeatedly to return to a 1:1 view (Q Off).



Notes:

- You can select the Pause, Slow or Search playback in the zoom mode.
- Some discs may not respond to zoom feature.

Locating desired scene

Use the title, chapter and time recorded on the DVD disc to locate the desired point to playback. In the case of VCD/CD discs, time and track are used to locate the desired point to playback. To check the title, chapter and time, press **DISPLAY**.

1 Press JUMP during playback or resume stop mode.

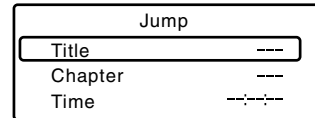

2 Press ▲ or ▼ to select the "Title/Track", "Chapter" or "Time".

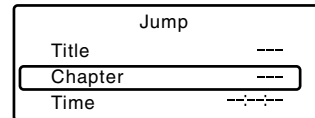

3 Press Number buttons (0-9) to input the number.

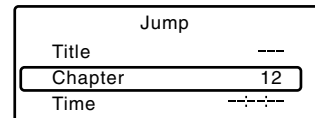
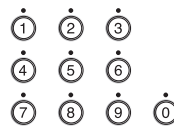

- If you input a wrong number, press **CLEAR**.
- Refer to the package supplied with the disc to check the numbers.

4 Press ENTER. Playback starts.



- When you change the title, playback starts from Chapter 1 of the selected title.
- Some discs may not work in the above operation.

Notes:

- In case of the Audio CD and Video-CD, only Track and Time can be selected.
- In case of the Video-CD playback with PBC, the JUMP does not work. Turn off the PBC (see page 42).

Marking desired scenes

The unit stores the points that you want to watch again up to 3 points. You can resume playback from each scene.

Marking the scenes

1 Press **MARKER** during playback.



2 Select the blank Marker using **▲** or **▼**. Then press **ENTER** at the desired scene.

- Repeat this procedure to set the other 2 scenes.

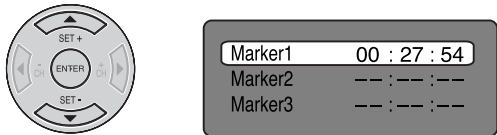

3 Press **MARKER** to clear this display.



Returning to the scenes

1 Press **MARKER** during playback or stop mode.

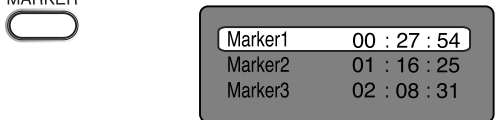

2 Press **▲** or **▼** to select the Marker 1-3.



3 Press **ENTER**.

Playback starts from the marked scene.



■ **To cancel the Marker**

Follow the above steps 1~2, then press **CLEAR**.

Notes:

- Some discs may not work with the marking operation.
- The marking is canceled when you open the disc tray or turn the power off.
- Some subtitles recorded around the marker may fail to appear.
- In case of Video CD with PBC, Marker function is prohibited.

Repeat playback/A-B Repeat playback

Repeat playback

1 Press **PLAY MODE** during playback or stop mode.

SP/SLP
PLAY MODE



2 [DVD]
Press **ENTER** to select "Chapter" or "Title".

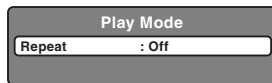

The unit automatically starts repeat playback after finishing the current title or chapter.

[Video CD]

Press **▼** to select "Repeat".
Press **ENTER** to select "Track" or "All".

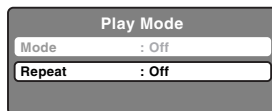

The unit automatically starts repeat playback after finishing the current track.

- If you set the repeat mode during stop mode, press **PLAY** to start Repeat playback.

[Audio CD and MP3 CD]

Please see "Repeat playback (CD)" (see page 47).

3 Press **PLAY MODE** again to clear the screen.

■ To resume normal playback

Select Repeat : "Off" in step 2.

Notes:

- Some discs may not work with the repeat operation.
- In case of Video CD with PBC, Repeat functions are prohibited during playback.
- Chapter/Track repeat function is canceled whenever **SKIP** **◀◀** or **▶▶** is pressed.

A-B Repeat playback

A-B repeat playback allows you to repeat selection between two selected points.

1 Press **A-B RPT** during playback.

A-B RPT



The start point is selected.

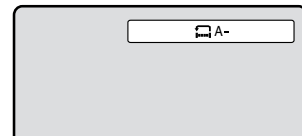

2 Press **A-B RPT** again.

A-B RPT



The end point is selected. Playback starts at the point that you selected. Playback stops at the end point and returns to Point A automatically, then starts again.

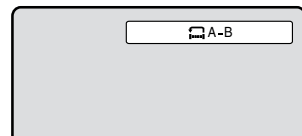

■ To resume normal playback

Press **A-B RPT** again.

A-B RPT



"Off" appears on the screen.

Notes:

- In A-B Repeat mode, subtitles near the A or B locations may not be displayed.
- You cannot set the A-B Repeat for the scenes that include multiple angles.
- A-B Repeat playback does not work when Repeat playback is activated.
- You may not be able to set A-B Repeat, during certain scenes of the DVD.
- A-B Repeat does not work with an interactive DVD, MP3/JPEG/DivX® CD.
- A-B Repeat is prohibited when PBC is on.

Program playback/Random playback

You can arrange the playback order of tracks or files on the disc. And the unit can also select tracks or files at random and playback them. These feature works for Video CD.

For Audio CD and MP3 CD, please see "Random playback (CD)" on page 47 and "Program playback (CD)" on page 48.

Program playback

1 Press **PLAY MODE** during stop mode.

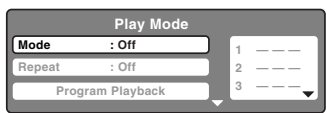

2 Press **▲/▼** to select "Mode", then press **ENTER** to select "Program".

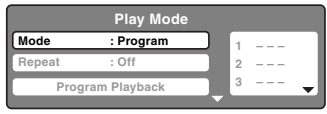
3 Press **◀/▶** to select the programming position. Use Number buttons (0-9) to input the track numbers on sequentially.



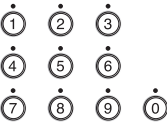

- If you input a wrong number, press **CLEAR**.

4 Press **◀/▶** to return to the left column, then press **▲/▼** to select the "Program Playback" and press **ENTER**.

The programs you selected will start to playback in order.

- To resume normal playback, select Mode "Off" in step 2.

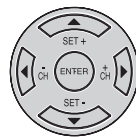
■ To change the program

- Select Mode to "Program" (as step 2), press **◀/▶/▲/▼** to select the track number you want to change, then press **CLEAR**.
- Press **Number buttons (0-9)** to overwrite the new track number.

■ To clear the program one by one

- Select Mode to "Program", press **◀/▶/▲/▼** to select the track number. Then press **CLEAR**.

■ To clear all the programs

- In the left column, press **▲/▼** to select "Clear Program". Then press **ENTER**.

Notes:

- In case of Video CD with PBC, you cannot set Program playback.
- The program is canceled when you open the disc tray or turn the power off.

Random playback

1 Press **PLAY MODE** during playback or stop mode.

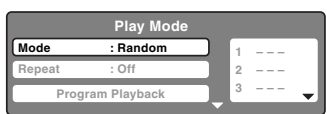

2 Press **▲/▼** to select "Mode", then press **ENTER** to select "Random".

3 Press **PLAY**.



The Random Playback will start.

- If you set "Random" during playback mode, Random playback will begin after the track that is currently being played has ended.
- To resume normal playback, select Mode "Off" in step 2.

Note:

- In case of Video CD with PBC, you cannot set Random function during playback.



Changing angles/Title selection/DVD menu

Changing angles

When playing back a disc recorded with multi-angle facility, you can change the angle that you are viewing the scene from.

1 Press ANGLE during playback.
The current angle will appear.

COUNTER RESET ANGLE

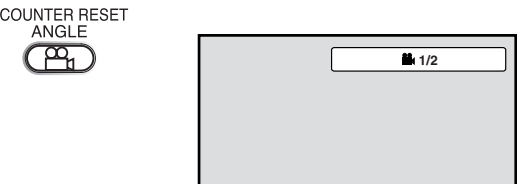

2 Press ANGLE repeatedly until the desired angle is selected.

COUNTER RESET ANGLE



Note:
Depending on the DVD, you may not be able to change the angles even if multi-angles are recorded on the DVD.

Title selection

Two or more titles are recorded on some discs. If the title menu is recorded on the disc, you can select the desired title.

1 Press TOP MENU during playback.
TOP MENU Title menu appears on the screen.



2 Press ▲/▼/◀▶ to select the desired title.

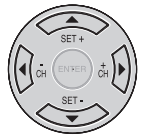

3 Press ENTER or PLAY.
The playback of the selected title will start.



Note:
Depending on the DVD, you may not be able to select the title. Depending on the DVD, a "title menu" may simply be called a "menu" or "title" in the instructions supplied with the disc.

DVD menu

Some DVDs allow you to select the disc contents using the menu. When you playback these DVDs, you can select the subtitle language and sound-track language, etc. using the menu.

1 Press DVD MENU during playback.
DVD MENU The DVD menu appears on the screen.

- Press **DVD MENU** again to resume playback at the scene when you pressed **DVD MENU**.

2 Press ▲/▼/◀▶ to select the desired item.

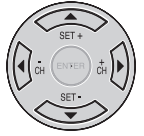

3 Press ENTER.
The menu continues to another screen. Repeat steps 2 and 3 to set the item completely.



Note:
Depending on the DVD, you may not be able to resume playback from the scene point when you press **DVD MENU**.



Changing soundtrack language/Setting surround sound

Changing soundtrack language

You can select the language when you play a multilingual disc.

1 Press AUDIO during playback.
AUDIO SELECT AUDIO
The current soundtrack language will appear.

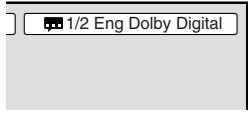

2 Press AUDIO repeatedly until the desired language is selected.
AUDIO SELECT AUDIO
The on screen display will disappear after a few seconds.

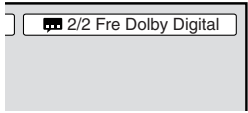

In case of Video CD playback

Audio type changes as follows each time you press **AUDIO**.



Notes:

- If the desired language is not heard after pressing the button several times, the language is not recorded on the disc.
- The selected soundtrack language is canceled when you open the disc tray. The initial default language or available language will be heard if the disc is played back again.

Setting surround sound

This DVD video player equipped with a "QSound". It can produce the effect of being in a cinema or a concert hall.

1 During disc playback press AUDIO.
AUDIO SELECT AUDIO
QSound Off

2 Press ◀ or ▶ to select "On".



The on screen display will disappear after a few seconds.

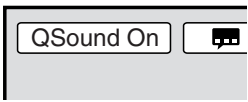

To cancel Surround mode:

Follow the left steps 1~2, then press ◀ or ▶ to select the "Off" position.

Notes:

- The "QSound" is effective only for the sound of disc.
- The QSound setting can also be changed in the function setting (see page 52)
- This function works only when the disc recorded with Dolby Digital is played back.
- When this function works, the volume might changed.
- When the voice is distorted, turn off QSound.



Manufactured under license from QSound Labs, Inc. U.S. patent Nos. 5,105,462, 5,208,860 and 5,440,638 and various foreign counterpart. Copyright QSound Labs, Inc. 1998-2002. QXpander™ is a trademark of QSound Labs, Inc. All rights reserved.

Subtitles/To turn off the PBC/Disc status

Subtitles

When playing back a disc recorded with subtitles, you can select the subtitle language or turn the subtitle off.

1 Press SUBTITLE repeatedly during playback until the desired language is selected.



2 To turn off the subtitle, press SUBTITLE until "Off" appears.



- The on screen display will disappear after a few seconds.

Notes:

- Depending on the DVD, you may not be able to change subtitles, or to turn subtitles on or off.
- While playing a DVD, the subtitle may change when you open or close the disc tray.
- In some cases, a selected subtitle language may not be changed immediately.

To turn off the PBC (see page 6)

1 Press PLAY MODE in the stop mode.



2 Press ▲/▼ to select "Mode", then press ENTER repeatedly until "Off" appear.

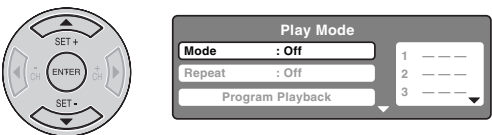

3 Press PLAY MODE again to clear the screen.

■ To turn on the PBC

Follow the above steps 1~2, then press **ENTER** repeatedly until "PBC" appear.

Disc status

With each press of **DISPLAY**, the status of the disc will appear on the screen and change as follows.

CALL DISPLAY



[DVD]

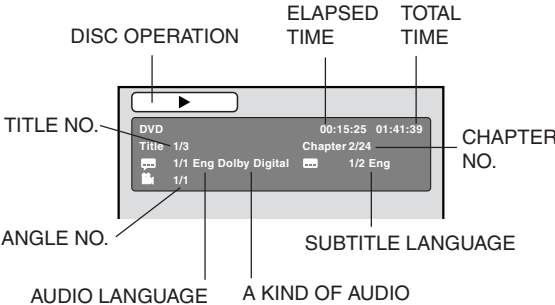

[Video CD]

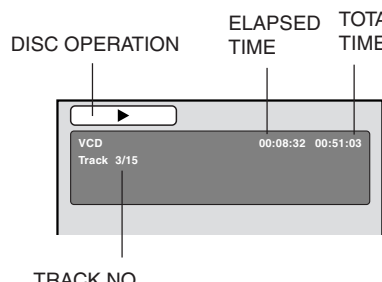



MP3/JPEG/DivX® and Audio CD operation

This player can play back the MP3/JPEG/DivX®-data which has been recorded on CD-R or CD-RW. To produce the MP3/JPEG/DivX®-data, you need a Windows-PC with CD-RW drive and a MP3/JPEG/DivX®-encoding Software (not supplied). The Apple-HFS-System cannot be played.

Note:

This unit requires discs/recordings to meet certain technical standards in order to achieve optimal playback quality. Pre-recorded DVDs are automatically set to these standards. There are many different types of recordable disc formats (including CD-R containing MP3 files). Given the fact that technology in this area is still maturing, Toshiba cannot guarantee that all genre of recordable discs will produce optimal playback quality. The technical criteria set out in this owner's manual are meant as a guide only.

Please be advised that you must obtain permission from the applicable copyright owners to download copyrighted content, including music files, in any format, including the MP3 format, prior to the downloading thereof. Toshiba has no right to grant and does not grant permission to download any copyrighted content.

MP3/JPEG/DivX® CD information

Limitations on MP3/JPEG/DivX® CD playback

- MP3/JPEG/DivX® CD is the disc that is standardized by ISO9660, its file name must include 3-digits extension letters, ".mp3", ".jpg", ".div", ".divx", ".avi".
- MP3/JPEG/DivX® CD must be correspond to the ISO standardized files.
- This unit can read 600 files per directory. If one directory has more than 600 files, it reads up to 600 files, the remaining files will be omitted.
- The unit is able to recognize up to a maximum of 50 directories per disc.
- MP3/JPEG/DivX® CDs cannot be used for the purpose of recording.
- If the CD has both audio tracks and MP3/JPEG/DivX® files, only audio tracks are played.
- It may take more than one minute for this unit to read MP3/JPEG/DivX® files depending on its structure.
- Music recorded by "Joliet Recording Specification" can be played back, the file name is displayed (within 15 letters) on the screen. Long file names will be condensed.
- The music files recorded by "Hierarchical File System" (HFS) cannot be played.

Limitations on display

- The maximum number for display is 15 letters.
Available letters for display are the following:
capital or small alphabets of A through Z, numbers of 0 through 9, and _ (under score).
- Other letters than those above are replaced in hyphen.

To playback MP3/JPEG/DivX® CD in the recorded order

1. Use MP3/JPEG/DivX® software that records data alphabetically or numerically.
2. Name each file including two-digit or three-digit number (ex. "01" "02" or "001" "002").
3. Refrain from making too many sub-folders.

CAUTION:

- Some MP3/JPEG/DivX® CDs cannot be played back depending on the recording conditions.
- The CD-R/RW that has no music data or non MP3/JPEG/DivX® files cannot be played back.

Standard, sampling frequency, and the bit rate:

MP3

MPEG-1 Audio

32kHz, 44.1kHz, 48kHz

32kbps ~ 320kbps (constant bit rate or variable bit rate)

The recommend recording setting for a high-quality sound is 44.1kHz of sampling frequency and 128kbps of constant bit rate.

DivX® video

DivX® version: DivX® 3, 4, 5, and 6 (specifically 3.1.1, 4.1.2, 5.0.2, 5.0.5, 5.1.1, 5.2.1, 6.0 at Home Theater profile).

Audio format: MPEG1 Layer2 (MP2), MPEG1 Layer3 (MP3)

Sampling frequencies: 32kHz, 44.1kHz, 48kHz

Bit rate: 32kbps ~ 320kbps

Resolution: Max 720 x 576 (at 25fps), Max 720 x 480 (at 30fps)

MP3/JPEG/DivX® and Audio CD operation

MP3 CD and Audio CD playback

1 Place an Audio CD or a disc on which MP3 files have been recorded onto the disc tray.

2 A file browser screen will appear on the screen.

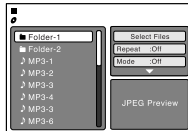

3 Press ▲/▼ to select file.

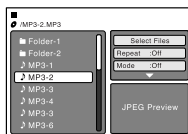

- In case the current directory includes more than 8 files, press ▲ or ▼ to scroll in the file list.
- To see contents in folder, select the folder and then press **ENTER**. To return to the upstairs directory, select “Go Up ...” then press **ENTER**.
- When **PLAY** is pressed after the file browser displayed, playback begins automatically starting from the first file. In this case, if the first file is an MP3 file, only MP3 files are played back in order. If the first file is a JPEG file, the first JPEG file is played back. If the first file is a DivX® file, the first DivX® file is played back. If there is no file at a root directory, playback does not begin automatically.

4 Press **ENTER**. The selected file starts playing back.



5 Press **STOP** to end playback.



- The unit records the stopped point. “■” appears on the screen. Press **PLAY** to resume playback (from the scene point).
- If you press **STOP** again or unload the disc, the unit will clear the stopped point.

About file browser

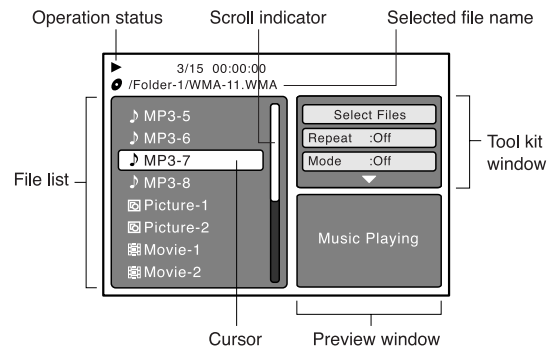

- ♪ : Indicates Music file (Audio/MP3)
- 🖼️ : Indicates Picture file (JPEG)
- 🎬 : Indicates Movie file (DivX® video)

Notes:

- The thumbnail list is displayed when the FUJICOLOR CD or the Kodak Picture CD are played. To display the file browser, press **TOP MENU**.
- In the case of a CD containing a mixture of MP3, JPEG and DivX® files, the files are played back by selecting them from the file browser.
- MP3 or file on the Kodak Picture CD is not recognized on this unit.

Notes:

- During MP3/JPEG Playback, you cannot use JUMP and A-B Repeat functions.
- You can use Repeat (Track or All), Random functions and Program playback for MP3/JPEG/DivX® CD Playback (see “Repeat and program playback using file browser” on pages 47 and 48)

■ Select Files

The file type to make it display in the file browser can be chosen.

1. Press ◀ or ▶ to highlight “Select Files” at right column in the file browser.
2. Press **ENTER**, then press ▲ or ▼ to select file type from the list (Music, Picture or Movie).
3. Press **ENTER** to add/remove check mark. Checked file type will be displayed in the file browser.
4. Press **RETURN** to save the setting.

MP3/JPEG/DivX® and Audio CD operation

JPEG CD playback

1 Place a disc on which JPEG files have been recorded onto the tray.

2 A file browser screen will appear on the screen.

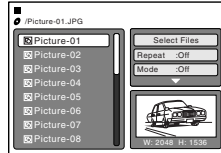

3 Press ▲/▼ to select the file.
To display a thumbnail list, press **DVD MENU**. Press ◀/▶ or ▲/▼ to select the desired file. (To return to a file browser, press **TOP MENU**.)

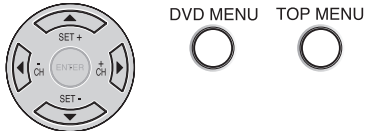

- When **PLAY** is pressed after the file browser displayed, playback begins automatically starting from the first file. In this case, if the first file is a JPEG file, the first JPEG file is played back. If the first file is a DivX® file, the first DivX® file is played back. If the first file is an MP3 file, only MP3 files are played back in order. If there is no file at a root directory, playback does not begin automatically.

4 Press **ENTER** or **PLAY**. The selected picture appears on the screen.

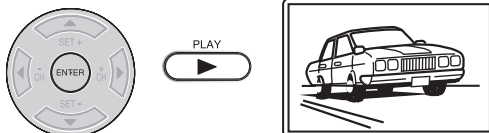

Rotating an image

You can rotate an image by 90 degrees. Press **ANGLE** during playback of the image.

“↺”, “↻”, “↷” or “↵” appears on the screen.

Zoom function also can be used in viewing JPEG files. Press **ZOOM** (see “Zooming” on page 36)

5 Press **STOP** to end playback.



The file browser appears on the screen. If you want to watch the other file, repeat steps 3 ~ 4.

Slide show playback

The slide show enables you to view pictures (files) one after another automatically.

Preparation:

Set “JPEG Interval” setting to “5 Seconds”, “10 Seconds” or “15 Seconds” (see page 51).

1 Select your desired starting file for the slide show in step 3 on the left.

2 Press **ENTER** or **PLAY** to start slide show from the selected file.



- If you press **PAUSE/STEP** during the slide show, the slide show stops temporary. “||” appears briefly on the screen.

If the picture appears upside down or sideways, press **ANGLE** repeatedly until it's right side up.

“↺”, “↻”, “↷” or “↵” appears on the screen.

Press **PLAY** or **SKIP** again to resume the slide show.

- When the slide show playback finished, the file list appears.
- To stop the slide show, press **STOP**. The file list appears.

Notes:

- Zoom function also can be used in viewing JPEG files. See “Zooming” (see page 36).
- During JPEG playback, you cannot use Jump and A-B Repeat functions.

MP3/JPEG/DivX® and Audio CD operation

DivX® CD playback

1 Place a disc on which DivX® files have been recorded onto the tray.

2 A file browser screen will appear on the screen.

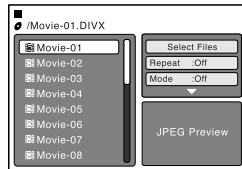

3 Press ▲/▼ to select file.



- When **PLAY** has been pressed after the file browser displayed, playback begins automatically starting from the first file. In this case, if the first file is a JPEG file, the first JPEG file is played back. If the first file is a DivX® file, the first DivX® file is played back. If the first file is an MP3 file, only MP3 file are played back in order. If there is no file at a root directory, playback does not begin automatically.

4 Press **ENTER** or **PLAY**. The selected DivX® movie will be played back on the screen.



5 Press **STOP** to end playback.



The file browser appears on the screen. If you want to watch the other file, repeat steps 3 ~ 4.

Note:

This unit cannot playback DivX® file with WMA sound.

Playing DivX® VOD content

DivX® VOD content is protected by DRM (Digital Rights Management) system. This restricts playback of content to specific registered devices.

If the incorrect DRM file is loaded, "Authorization Error This player is not authorized to play this video." will appear on the screen.

When you attempt to play DivX® VOD, the number of plays is limited and the right message will appear on the screen. If you wish to play it, select "YES".

- If the number of plays goes over the limit, then "Rental Expired" will be displayed, in this case the file will not be played.

View DivX® VOD Rental
This rental has 5 views left.
Do you want to use one
of your 5 views now?

Yes

No

Note:

In order to play DivX® VOD content on this unit, you first need to register the unit with registration code. See page 53.

Repeat and program playback using file browser

Repeat playback (CD)

1 In the file browser, press ◀/▶ or ▲/▼ to select "Repeat" during stop mode.

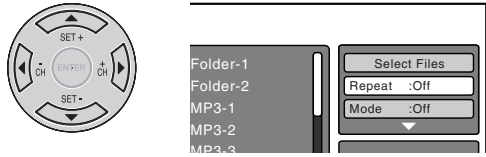

2 Press ENTER to select "Track" or "All".

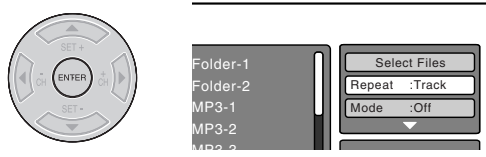

3 Press PLAY.



The unit automatically starts repeat playback after finishing the current track.

Random playback (CD)

1 In the file browser, press ◀/▶ or ▲/▼ to select "Mode" during stop mode.

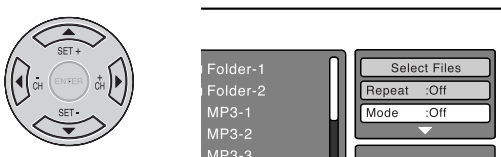

2 Press ENTER to select "Random".

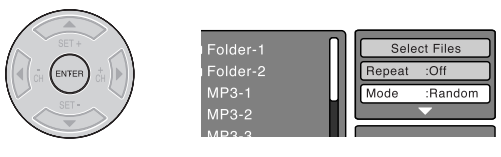

3 Press PLAY.



The Random playback will start.

- **To resume normal playback**
Select Repeat : "Off" in step 2.

Notes:

- The program is canceled when you open the disc tray or turn the power off.
- In case of Audio CD, the function of A-B Repeat can be used. See "A-B Repeat playback" (see page 38).
- Track repeat function is canceled whenever **SKIP** ◀◀ or ▶▶ is pressed.

- **To resume normal playback**
Select Mode : "Off" in step 2.

Repeat and program playback using file browser

Program playback (CD)

1 In the file browser, press ◀/▶ or ▲/▼ to select “Edit Mode”, then press ENTER.



When “Edit Mode” is black color, you can mark the files which you want to add into Program list.

2 Press ◀/▶ or ▲/▼ to select the file you want to add into the program list.

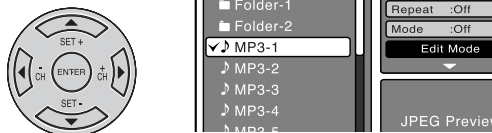

Press ENTER. Selected file was marked.
Repeat this procedure to select the other files.

3 Press ◀/▶ or ▲/▼ to select “Add To Program”. Then press ENTER. All marked files are added into the program list.



•When you finish storing all the files you want into the Program list, select “Edit Mode” again and press ENTER to release edit mode.

4 Press ▲/▼ to select “Program View”, then press ENTER. Program View shows only the programmed files that you have added step 2.

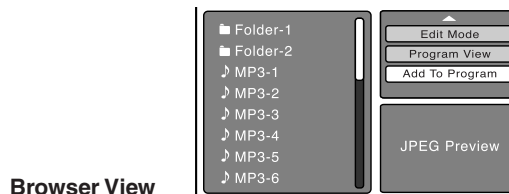

Browser View

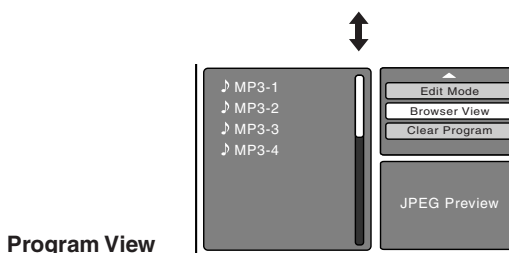

Program View

5 In the Program View, press PLAY. The files start to playback in programmed order that were added by you.

To remove file from program list

In the Edit Mode, switch to Program View. Select the files you want to remove, then press ENTER. Select “Clear Program” and press ENTER. Marked file is removed from program list.



Customizing the function settings

You can change the default settings to customize performance to your preference.

Setting procedure

1 Press **SETUP** during stop mode.

VCR MENU SETUP

The following on-screen display appears.

4 Then press **▶** or **ENTER**. The selectable settings will appear.

2 Press **▲** or **▼** to select the desired section, then press **◀** or **▶**.

5 Change the selection using **▲** or **▼**, by referring to the corresponding pages 50 ~ 53. Press **ENTER** to save the setting.

- Repeat steps 3 and 5 to change other option.
- To select another section, go back to step 2 by pressing **◀** repeatedly.

3 First option will be highlighted. Press **▲** or **▼** to select the desired option.

6 To clear **SETUP** screen, press **SETUP** or **RETURN**.

Setting details

Section	Option	Details	Page
	Menu	To select the language of "Menu", "Subtitle" and "Audio" if more than one language are available on the disc.	50
	Subtitle		
	Audio		
	E.B.L.	To select On or Off for E.B.L. (Enhanced Black Level).	50
	TV Screen	To select a picture size according to the aspect ratio of your TV.	
	Display	To turn On or Off the operational status display on the screen.	51
	Picture Mode	To select a preferred picture mode from "Video", "Film" or "Auto".	
	JPEG Interval	To select a preferred setting for the slide show playback.	
	Screen Saver	To select On or Off for Screen Saver function.	
	DRC	To select On or Off for DRC (Dynamic Range Control).	52
	QSound	To select On or Off for QSound.	
	Parental	To select a preferred parental level for the parental setting.	52
	Password	Input 4-digit password to set the parental level.	
	Output	To select a preferred video output signal from "Interlace" or "Progressive".	53
	DivX(R) VOD	To display your 8-character registration code.	





Customizing the function settings

Setting details

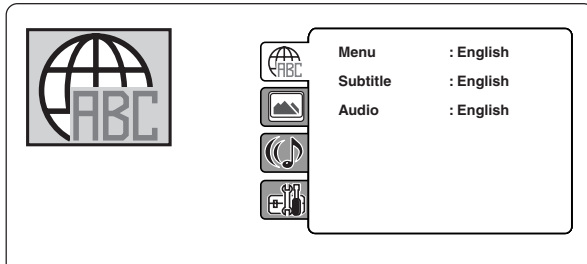

■ Menu, Subtitle, Audio

You can select the language of “Menu”, “Subtitle” and “Audio” if more than one languages are recorded onto the disc.

English, Francais, Espanol, Deutsch, Italiano:
The selected language will be heard or seen.

Other:
Other language can be selected (see “Language code list” on page 55).

Off (Subtitle):
Subtitles do not appear.

Original (Audio):
The unit will select the first priority language of each disc.

Notes:

- If the selected language is not recorded on the disc, the first-priority language is selected.
- If you want to change the OSD language, you can perform it by VCR MENU (see page 16).

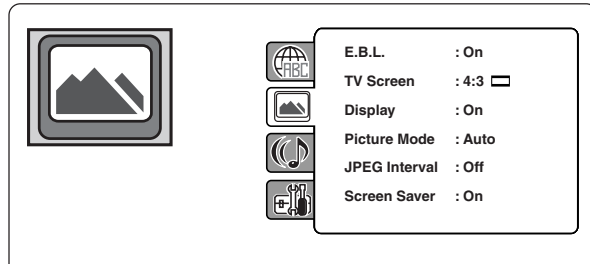

■ E.B.L.

To select the black level of playback pictures, set your preference and monitor’s ability.

On: Enhanced grey scale (0 IRE cut off)

Off: Standard grey scale (7.5 IRE cut off)

■ TV Screen

You have the following screen sizes to choose from:

4:3 (Letter box):

Select this mode when connecting to a conventional TV. When playing back a wide screen-DVD disc, it displays the wide picture with black bands at the top and bottom of screen.

4:3 (Pan scan):

It displays the wide picture on the whole screen with left and right edges automatically cut off.

16:9 (Wide):

Select this mode when connecting to a wide-screen TV. A wide screen picture is displayed full size.

Note:

If the DVD disc is not formatted in the pan & scan style, it displays 4:3 style.



Customizing the function settings

■ Display

On screen display can be switched on or off when you press any buttons.

On: On screen displays appear when you press the buttons (factory setting).

Off: On screen displays do not appear when you press any buttons.

■ Picture Mode

There are two types of source content in pictures recorded in DVD video discs: film content (pictures recorded from films at 24 frames per second) and video content (video signals recorded at 30 frames per second). Make this selection according to the type of content being viewed.

Auto: Select this position normally. The DVD player automatically detects source content, film or video of playback source, and converts that signal in the progressive output format in an appropriate method.

Film: The DVD player converts film content pictures in the progressive output format appropriately. Suitable for playback of film content pictures. The progressive output feature will be most effective under this selection.

Video: The DVD player filters video signal, and converts it in the progressive output format appropriately. Suitable for playback of video content pictures.

Note:

Depending on the disc, pictures may be cut off or doubled. In this case, select "Video".

■ JPEG Interval

You can continuously playback all JPEG files automatically.

After the selection below, the disc will start playback on which JPEG files have been recorded.

Off:
Plays back one file at a time.

5 Seconds:
Plays back images in the form of a slide show at 5 second intervals.

10 Seconds:
Plays back images in the form of a slide show at 10 second intervals.

15 Seconds:
Plays back images in the form of a slide show at 15 second intervals.

■ Screen Saver

The screen saver operates when you leave the unit in DVD stop mode for approx. five minutes. The screen will repeatedly get dark gradually and back to normal.

On:
Screen Saver function is made effective.

Off:
Screen Saver function is invalidated.

Customizing the function settings

Setting details

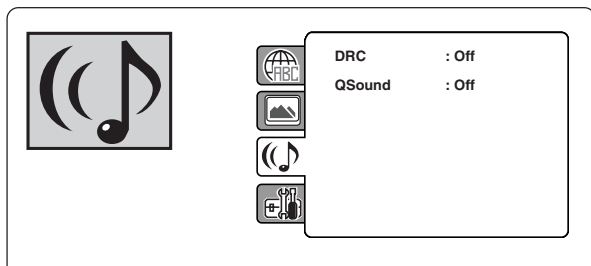

■ DRC

DRC (Dynamic Range Control) enables you to control the dynamic range so as to achieve a suitable sound for your equipment.

Off:

It plays back at the recording level on the disc.

On:

Loud sound such as explosion is toned down slightly when played back. This is suitable when it is connected to a stereo.

Notes:

- This function works only during playback of Dolby Digital recorded discs.
- The level of Dynamic Range Reduction may differ depending on DVD video disc.

■ QSound

This DVD video player equipped with a "QSound". It can produce the effect of being in a cinema or a concert hall.

Off: The QSound is disengaged.

On: The QSound operates.

Notes:

- The QSound setting can also be changed with **AUDIO** on the remote control (see page 41).
- This function works only when the disc recorded with Dolby Digital is played back.
- When this function works, the volume might changed.
- When the voice is distorted, turn off QSound.

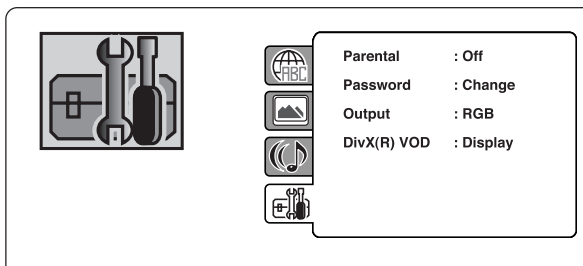

■ Parental control setting

Some discs are specified is not suitable for children. Such discs can be limited not to playback with the unit.

- 1) Press **▲** or **▼** to select "Parental", then press **ENTER**. "Enter Password" screen will appear.
- 2) Press "0000" using **Number buttons (0-9)**. (Please note, this is pre-setting password of this unit). Then press **ENTER**. The parental level list will appear.
 - **Level Off:** The parental control setting does not function.
 - **Level 8:** Virtually all DVD software can be playedback.
 - **Level 1:** DVD software for adults cannot be played back. Then press **ENTER**.
- 3) Press **▲** or **▼** to select from the level 1 to level 8. The limitation will be more severe as the level number is lower.
- 4) Press **OPEN/CLOSE** to activate Parental control setting.

Notes:

- Depending on the discs, the unit cannot limit playback.
- Some discs may not be encoded with specific rating level information though its disc jacket says "adult." For those discs, the age restriction will not work.
- The password is required every time when you change the parental level.
- If you input a wrong number, press **CLEAR**.

■ Set the new password

- 1) Press **▲** or **▼** to select "Password", then press **ENTER**. "Enter Current Password" screen will appear.
- 2) Press **Number buttons (0-9)** to input the current password (If the password has not been set yet after you purchase this unit, it is "0000").
- 3) Then press **ENTER**. "Enter New Password" screen will appear. Press **Number buttons (0-9)** to input the new password.
- 4) Press **ENTER**. Now your new password has been set. Be sure to remember this number!



Customizing the function settings

If you forget the password.

- 1) Press **OPEN/CLOSE** to open the disc tray.
- 2) Remove the disc.
- 3) Press **OPEN/CLOSE** again to close the disc tray. "No Disc" appears on the screen.
- 4) While holding **7** down on the remote control and at the same time press **STOP** on the front panel. "Password Clear" appears on the screen. Now the password has been returned to the initial value ("0000").

■ Output

You can select the video output signal of the DVD video player to the TV from "Interlace" or "Progressive".

RGB:

Select when connecting to a composite TV.

Component:

Select when connecting to a TV equipped with component video inputs but progressive scan is not compatible.

Progressive:

Select when connecting to a TV equipped with component video inputs and progressive scan compatible.

Warning:

Once "Progressive" is selected when connecting to a TV progressive scan incompatible, no image will be seen on the video display.

In this case, you must reset the unit by pressing **STOP** on the front panel for five seconds. The video output will be restored to "RGB" setting, and a picture will once again be seen on a conventional analog display.

Notes:

- Some discs may not be played back with the progressive scanning mode correctly because of the disc characteristics or recording condition.
- Once Progressive scan on, S-video output is disabled.

■ DivX® VOD

In order to play DivX® VOD (Video On Demand) content on this unit, you first need to register the unit with your DivX® VOD content provider. You do this by generating a DivX® VOD registration code, which you submit to your provider.

Press **▲** or **▼** to select "DivX(R) VOD". Then press **ENTER**. Your 8-character registration code is displayed. Make a note of the code as you will need it when you register with a DivX® VOD provider. Then press **ENTER** to select Done.

Note:

If each setup (pages 50 ~ 53) has completed, the unit can always work under the same condition (especially with DVD discs).

Each setup will be retained in the memory even if you turn the power off.

Temporary cancel the rating level by DVD disc

Depending on the DVD disc, the disc may try to temporarily cancel the rating level that you have set. It is up to you to decide whether to cancel the rating level or not.

- 1** Load a DVD disc and press **PLAY** or **OPEN/CLOSE** on the unit (see page 33).

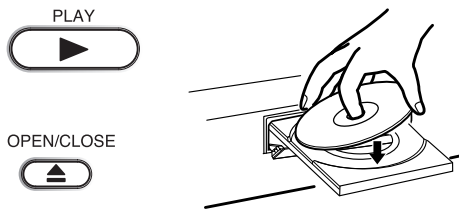

Note:

This temporary cancellation of rating level will be kept until the disc is ejected. When the disc is ejected, the original rating level will be set again automatically.

- 2** If the DVD disc has been designed to temporarily cancel the Rating level, the screen which follows the "Reading" screen will change, depending on which disc is played. If you select "YES" with the **ENTER** key, password input screen will then appear.

- 3** Enter the password with Number buttons (0-9). Then press **ENTER**.

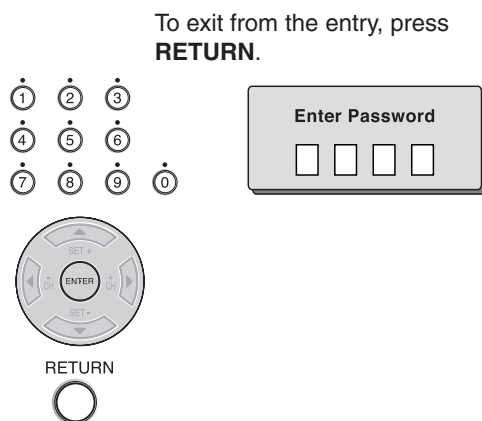

- 4** Playback will commence if the entered password was correct.

Language code list

Enter the appropriate code number for the initial settings "Menu", "Subtitle" and/or "Audio" (see page 50).

Language Name Code	Language Name Code	Language Name Code	Language Name Code
Abkhazian 1112	Fiji 1620	Lingala 2224	Singhalese 2919
Afar 1111	Finnish 1619	Lithuanian 2230	Slovak 2921
Afrikaans 1116	French 1628	Macedonian 2321	Slovenian 2922
Albanian 2927	Frisian 1635	Malagasy 2317	Somali 2925
Amharic 1123	Galician 1722	Malay 2329	Spanish 1529
Arabic 1128	Georgian 2111	Malayalam 2322	Sundanese 2931
Armenian 1835	German 1415	Maltese 2330	Swahili 2933
Assamese 1129	Greek 1522	Maori 2319	Swedish 2932
Aymara 1135	Greenlandic 2122	Marathi 2328	Tagalog 3022
Azerbaijani 1136	Guarani 1724	Moldavian 2325	Tajik 3017
Bashkir 1211	Gujarati 1731	Mongolian 2324	Tamil 3011
Basque 1531	Hausa 1811	Nauru 2411	Tatar 3030
Bengali; Bangla 1224	Hebrew 1933	Nepali 2415	Telugu 3015
Bhutani 1436	Hindi 1819	Norwegian 2425	Thai 3018
Bihari 1218	Hungarian 1831	Oriya 2528	Tibetan 1225
Breton 1228	Icelandic 1929	Panjabi 2611	Tigrinya 3019
Bulgarian 1217	Indonesian 1924	Pashto, Pushto 2629	Tonga 3025
Burmese 2335	Interlingua 1911	Persian 1611	Turkish 3028
Byelorussian 1215	Irish 1711	Polish 2622	Turkmen 3021
Cambodian 2123	Italian 1930	Portuguese 2630	Twi 3033
Catalan 1311	Japanese 2011	Quechua 2731	Ukrainian 3121
Chinese 3618	Javanese 2033	Rhaeto-Romance 2823	Urdu 3128
Corsican 1325	Kannada 2124	Romanian 2825	Uzbek 3136
Croatian 1828	Kashmiri 2129	Russian 2831	Vietnamese 3219
Czech 1329	Kazakh 2121	Samoan 2923	Volapük 3225
Danish 1411	Kirghiz 2135	Sanskrit 2911	Welsh 1335
Dutch 2422	Korean 2125	Scots Gaelic 1714	Wolof 3325
English 1524	Kurdish 2131	Serbian 2928	Xhosa 3418
Esperanto 1525	Laothian 2225	Serbo-Croatian 2918	Yiddish 2019
Estonian 1530	Latin 2211	Shona 2924	Yoruba 3525
Faroese 1625	Latvian, Lettish 2232	Sindhi 2914	Zulu 3631



Problems and troubleshooting

Use the following check list for troubleshooting when you have problems with your unit.
Be sure all connections are properly made when using with other units.

SYMPTOMS	POSSIBLE SOLUTIONS	PAGE
DVD/VCR		
DVD/VCR does not operate.	<ul style="list-style-type: none"> • Make sure the power cord is plugged in. • Try another AC outlet. • Power is off, check fuse or circuit breaker. • Unplug unit, then plug it back in. • Select the DVD or VCR mode before operating. 	– – – – 16,33
No picture.	<ul style="list-style-type: none"> • Aerial connection is not correct or aerial cable is disconnected. • The video channel is not in the correct position or the TV is not set to the video channel. • Check the unit is connected correctly. • The video input selector of the TV is not set to VIDEO. Set to VIDEO (or equivalent). • Channel is set to the external mode. 	12 15 12~14 – –
No sound.	<ul style="list-style-type: none"> • Check the unit is connected correctly. • Check the input selector of the amplifier is set properly. • The unit is in the Special playback mode. 	12~14 – 21,35
The remote control does not function.	<ul style="list-style-type: none"> • Aim at the remote control at the remote sensor. • Operate within Approx. 5 Meters or reduce the light in the room. • Clear the path of the beam. • The batteries are weak. Replace the batteries. • Check the batteries are inserted correctly. • Check the frequency code is set correctly. 	11
VCR		
TV recording does not work.	<ul style="list-style-type: none"> • The erase prevention tab of the video cassette is broken off. • The unit is in the external input mode. 	19
Timer recording does not work.	<ul style="list-style-type: none"> • The time is not set correctly. • The recording start/end time is not set correctly. • The TIMER REC has not been pressed (⏸ is not lit). 	17 28 29
Noise bars on screen.	<ul style="list-style-type: none"> • Tracking adjustment beyond range of automatic tracking circuit. Try Manual tracking adjustment. • Video heads are dirty. • The tape is worn or damaged. 	21 57 –
DVD		
Display is not shown in your language.	<ul style="list-style-type: none"> • Select proper language in the menu options. 	50
Playback doesn't start.	<ul style="list-style-type: none"> • No disc is inserted. • The disc may be dirty. Clean up the disc. • The unit cannot play DVD-ROMs, etc. 	33 5 6
Stopping playback, slow-motion play, repeat play, or memory play, etc. cannot be performed.	<ul style="list-style-type: none"> • Some discs may not do some of the functions. 	–



Problems and troubleshooting/Video head cleaning

SYMPTOMS	POSSIBLE SOLUTIONS	PAGE
No 4:3 (16:9) picture.	• The setup does not match your TV.	50
No on-screen display.	• Set Display On.	51
No surround sound.	• The setup does not match your stereo system.	14
The unit or remote operation key is not functioning.	• Turn off the unit and unplug the AC power cord for several minutes, then replug it.	16
Playback does not start when the title is selected.	• Check the Parental control setting.	52
Audio soundtrack and/or subtitle language is not changed when you playback a DVD.	• Multilingual language is not recorded on the DVD disc.	50
No subtitle.	• Some discs have no subtitles. • Subtitles are cleared. Press SUBTITLE .	– 42
Angle cannot be changed.	• Multi-angles are not recorded on the DVD disc.	40
 appears on the screen.	• The function is prohibited with the unit or the disc.	35

Contact for technical assistance

If you are still having problem, please contact the Toshiba helpline on 0115 976 6958.

Video head cleaning

Video head clogging

The video heads are the means by which the DVD/VCR reads the picture from the tape during playback. In the unlikely event that the heads become dirty enough to be clogged, no picture will be played back. This can easily be determined if, during playback of a known good tape, there is good sound, but no picture (picture is extremely snowy). If this is the case, have the DVD/VCR checked by qualified service personnel.



Good Picture



Snowy Picture

NOTES: • DO NOT ATTEMPT TO CLEAN THE VIDEO HEADS OR SERVICE THE UNIT BY REMOVING THE REAR COVER.

- Video heads may eventually wear out and should be replaced when they fail to produce clear pictures.
- To help prevent video head clogging, use only good quality VHS tapes. Discard worn out tapes.

Specifications

GENERAL

Power supply: AC 230V 50Hz
Power consumption: Operation: 21W
Stand by: 5W
Weight: 3.6 kg
Dimensions: Width : 430.6 mm
Height: 89.7 mm
Depth : 254.7 mm
Input Level: SCART-socket: VIDEO: 1 Vp-p, 75 Ω
AUDIO: 500 mV, 50 k Ω
Audio IN jack: 500 mV, 50 k Ω
Video IN jack: 1 Vp-p, 75 Ω
Output Level: SCART-socket: VIDEO: 1 Vp-p, 75 Ω
AUDIO: 500 mV, 1 k Ω
Audio OUT jack: 500 mV, 1 k Ω
Hi-Fi Frequency Response: 20Hz to 20kHz
Hi-Fi Dynamic Range: More than 75dB

VCR section

Video system: PAL
Video Head: 4 Rotary Heads
Audio Track: Hi-Fi Sound - 2 Tracks / MONO Sound - 1 Track
Channel coverage: IRE-E12, X-Z+2, S1-S41, E21-E69
FWD/REV Time at 25°C: Approx. 1minute and 48 seconds (with E-180 Cassette Tape)

DVD section

Signal system: PAL, NTSC
Applicable disc: DVD (12cm, 8cm), CD (12cm, 8cm)
Audio characteristics
Frequency response: DVD: 4Hz - 22KHz
CD: 4Hz - 20KHz
S/N Ratio: 90dB
Harmonic distortion: 0.06%
Wow and flutter: Below Measurable Level
Output: Audio : (RCA) – 12dB, 1 k Ω
Digital Audio : 0.5Vp-p, 75 Ω
Component video:
Y: 1 Vp-p, 75 Ω
Pr: 0.7 Vp-p, 75 Ω
Pb: 0.7 Vp-p, 75 Ω
Pickup: CD : Wavelength: 775 - 805 nm
Maximum output power: 0.5 mW
DVD : Wavelength: 640 - 660 nm
Maximum output power: 1.0 mW

ACCESSORIES:

Remote control x 1
75 Ω Coaxial Cable x 1
Battery (UM-4) x 2

Design and specifications are subject to change without notice.





TOSHIBA

Following information is only for EU-member states:

The use of the symbol indicates that this product may not be treated as household waste. By ensuring this product is disposed of correctly, you will help prevent potential negative consequences for the environment and human health, which could otherwise be caused by inappropriate waste handling of this product. For more detailed information about recycling of this product, please contact your local city office, your household waste disposal service or the shop where you purchased the product.



J2J50101A SH 06/03

Free Manuals Download Website

<http://myh66.com>

<http://usermanuals.us>

<http://www.somanuals.com>

<http://www.4manuals.cc>

<http://www.manual-lib.com>

<http://www.404manual.com>

<http://www.luxmanual.com>

<http://aubethermostatmanual.com>

Golf course search by state

<http://golfingnear.com>

Email search by domain

<http://emailbydomain.com>

Auto manuals search

<http://auto.somanuals.com>

TV manuals search

<http://tv.somanuals.com>