

# TOSHIBA



## DVD VIDEO PLAYER SD-400V SD-K600

### OWNER'S MANUAL



Introduction 2

Connections 16

Basic playback 20

Advanced playback 26

Function setup 38

Others 46



# SAFETY PRECAUTIONS



The lightning flash with arrowhead symbol, within an equilateral triangle, is intended to alert the user to the presence of uninsulated "dangerous voltage" within the product's enclosure that may be of sufficient magnitude to constitute a risk of electric shock to persons.



The exclamation point within an equilateral triangle is intended to alert the user to the presence of important operating and maintenance (servicing) instructions in the literature accompanying the appliance.



The symbol for CLASS II (Double Insulation)

**WARNING:** TO REDUCE THE RISK OF FIRE OR ELECTRIC SHOCK, DO NOT EXPOSE THIS APPLIANCE TO RAIN OR MOISTURE. DANGEROUS HIGH VOLTAGES ARE PRESENT INSIDE THE ENCLOSURE. DO NOT OPEN THE CABINET. REFER SERVICING TO QUALIFIED PERSONNEL ONLY.

**CAUTION:** TO PREVENT ELECTRIC SHOCK, MATCH WIDE BLADE OF PLUG TO WIDE SLOT, FULLY INSERT.

**ATTENTION:** POUR EVITER LES CHOCES ELECTRIQUES, INTRODUIRE LA LAME LA PLUS LARGE DE LA FICHE DANS LA BORNE CORRESPONDANTE DE LA PRISE ET POUSSER JUSQU'AU FOND.

**CAUTION:** This Digital Video Disc Player employs a Laser System. To ensure proper use of this product, please read this owner's manual carefully and retain for future reference. Should the unit require maintenance, contact an authorized service location - see service procedure.

Use of controls or adjustments or performance of procedures other than those specified herein may result in hazardous radiation exposure.

To prevent direct exposure to laser beam, do not try to open the enclosure. Visible laser radiation when open and interlocks defeated. DO NOT STARE INTO BEAM.

**FCC NOTICE:** This equipment has been tested and found to comply with the limits for a Class B digital device, pursuant to part 15 of the FCC Rule. These limits are designed to provide reasonable protection against harmful interference in a residential installation.

This equipment generates, uses, and can radiate radio frequency energy and, if not installed and used in accordance with the instructions, may cause harmful interference to radio communications.

However, there is no guarantee that interference will not occur in a particular installation. If this equipment does cause harmful interference to radio or television reception, which can be determined by turning the equipment off and on, the user is encouraged to try to correct the interference by one or more of the following measures:

- Reorient or relocate the receiving antenna.
- Increase the separation between the equipment and receiver.
- Connect the equipment into an outlet on a circuit different from that to which the receiver is connected.
- Consult the dealer or an experienced radio/TV technician for help.

**WARNING:** Changes or modifications made to this equipment, not expressly approved by Toshiba, or parties authorized by Toshiba, could void the user's authority to operate the equipment.

The instructions shall state that an ALL-POLE MAINS SWITCH with a contact separation of at least 3 mm in each pole shall be incorporated in the electrical installation of the building.

**CAUTION:** These servicing instructions are for use by qualified service personnel only. To reduce the risk of electric shock do not perform any servicing other than that contained in the operating instructions unless you are qualified to do so.

In the spaces provided below, record the Model and Serial No. located on the rear panel of your DVD video player.

Model No. \_\_\_\_\_

Serial No. \_\_\_\_\_

Retain this information for future reference.

### Location of the required label

PRODUCT IS CERTIFIED BY THE MANUFACTURER TO  
COMPLY WITH DHHS RULE 21 CFR SUBCHAPTER J  
APPLICABLE AT THE DATE OF MANUFACTURE.

MANUFACTURED

TOSHIBA CORPORATION  
1-1,SHIBAURA 1-CHOME,MINATO-KU.  
TOKYO 105-8001,JAPAN

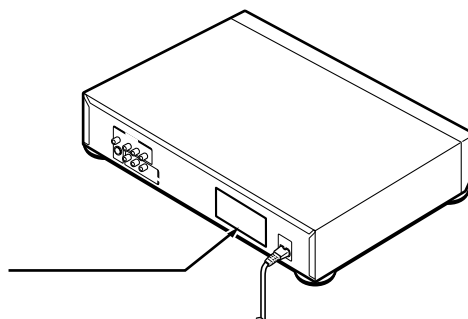

# IMPORTANT SAFETY INSTRUCTIONS

**CAUTION: PLEASE READ AND OBSERVE ALL WARNINGS AND INSTRUCTIONS GIVEN IN THIS OWNER'S MANUAL AND THOSE MARKED ON THE UNIT. RETAIN THIS BOOKLET FOR FUTURE REFERENCE.**

This set has been designed and manufactured to assure personal safety. Improper use can result in electric shock or fire hazard. The safeguards incorporated in this unit will protect you if you observe the following procedures for installation, use and servicing. This unit is fully transistorized and does not contain any parts that can be repaired by the user.

**DO NOT REMOVE THE CABINET COVER, OR YOU MAY BE EXPOSED TO DANGEROUS VOLTAGE. REFER SERVICING TO QUALIFIED SERVICE PERSONNEL ONLY.**

1. Read these instructions.

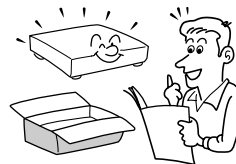

2. Keep these instructions.

3. Heed all warnings.

4. Follow all instructions.

5. Do not use this apparatus near water.

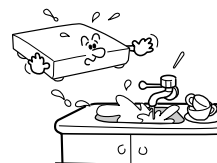

6. Clean only with dry cloth.



7. Do not block any ventilation openings. Install in accordance with the manufacturer's instructions.



8. Do not install near any heat sources such as radiators, heat registers, stoves, or other apparatus (including amplifiers) that produce heat.

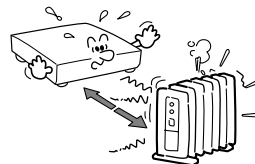

9. Do not defeat the safety purpose of the polarized or grounding-type plug. A polarized plug has two blades with one wider than the other. A grounding type plug has two blades and a third grounding prong. The wide blade or the third prong are provided for your safety. If the provided plug does not fit into your outlet, consult an electrician for replacement of the obsolete outlet.

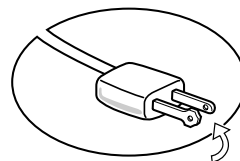

10. Protect the power cord from being walked on or pinched particularly at plugs, convenience receptacles, and the point where they exit from the apparatus.



11. Only use attachments/accessories specified by the manufacturer.

12. Use only with the cart, stand, tripod, bracket, or table specified by the manufacturer, or sold with the apparatus. When a cart is used, use caution when moving the cart/apparatus combination to avoid injury from tip-over.



# IMPORTANT SAFETY INSTRUCTIONS

13. Unplug this apparatus during lightning storms or when unused for long periods of time.

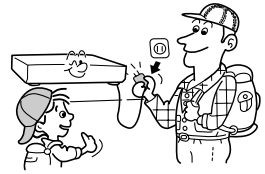

14. Refer all servicing to qualified service personnel. Servicing is required when the apparatus has been damaged in any way, such as power-supply cord or plug is damaged, liquid has been spilled or objects have fallen into the apparatus, the apparatus has been exposed to rain or moisture, does not operate normally, or has been dropped.



15. When you use headphones, keep the volume at a moderate level. If you use the headphones continuously with high volume sound, it may cause hearing damage.



16. Do not overload wall outlets; extension cords, or integral convenience receptacles as this can result in a risk of fire or electric shock.



17. Never insert objects of any kind into this apparatus through openings as they may touch dangerous voltage points or short-out parts that could result in a fire or electric shock. Never spill liquid of any kind on the apparatus.



18. Keep your fingers well clear of the disc tray as it is closing. Neglecting to do so may cause serious personal injury.



19. Do not place a heavy object on or step on the apparatus. The object may fall, causing serious personal injury and serious damage to the apparatus.

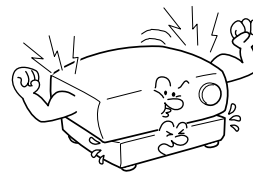

20. Do not use a cracked, deformed, or repaired disc. These discs are easily broken and may cause serious personal injury and apparatus malfunction.

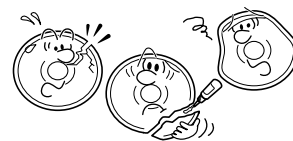

## Precautions

### Notes on handling

- When shipping the DVD video player, the original shipping carton and packing materials come in handy. For maximum protection, repack the unit as it was originally packed at the factory.
- Do not use volatile liquids, such as insect spray, near the DVD video player. Do not leave rubber or plastic products in contact with the DVD video player for a long time. They will leave marks on the finish.
- The top and rear panels of the DVD video player may become warm after a long period of use. This is not a malfunction.
- When the DVD video player is not in use, be sure to remove the disc and turn off the power.
- If you do not use the DVD video player for a long period, the unit may not function properly in the future. Turn on and use the DVD video player occasionally.

### Notes on locating

- Place the DVD video player on a level surface. Do not use it on a shaky or unstable surface such as a wobbling table or inclined stand. The loaded disc may come off the proper position and cause damage to the DVD video player.
- When you place this DVD video player near a TV, radio, or VCR, the playback picture may become poor and the sound may be distorted. In this case, place the DVD video player away from the TV, radio, or VCR.

### Notes on cleaning

Use a soft, dry cloth for cleaning.

- For stubborn dirt, soak the cloth in a weak detergent solution, wring well and wipe. Use a dry cloth to wipe it dry.  
Do not use any type of solvent, such as thinner and benzene, as they may damage the surface of the DVD video player.
- If you use a chemical saturated cloth to clean the unit, follow that product's instructions.

### To obtain a clear picture

The DVD video player is a high technology, precision device. If the optical pick-up lens and disc drive parts are dirty or worn down, the picture quality becomes poor. To obtain a clear picture, we recommend regular inspection and maintenance (cleaning or parts replacement) every 1,000 hours of use depending on the operating environment. For details, contact your nearest dealer.

### Notes on moisture condensation

**Moisture condensation damages the DVD video player. Please read the following carefully.**

Moisture condensation occurs, for example, when you pour a cold drink into a glass on a warm day. Drops of water form on the outside of the glass. In the same way, moisture may condense on the optical pick-up lens inside this unit, one of the most crucial internal parts of the DVD video player.

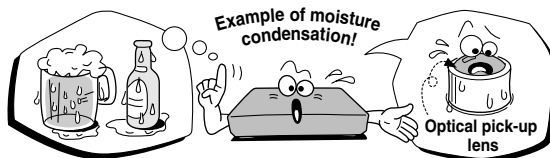

■ **Moisture condensation occurs during the following cases.**

- When you bring the DVD video player directly from a cold place to a warm place.
- When you use the DVD video player in a room where you just turned on the heater, or a place where the cold wind from the air conditioner directly hits the unit.
- In summer, when you use the DVD video player in a hot and humid place just after you move the unit from an air conditioned room.
- When you use the DVD video player in a humid place.

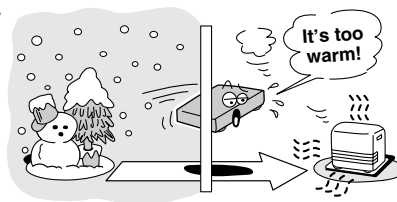

■ **Do not use the DVD video player when moisture condensation may occur.**

If you use the DVD video player in such a situation, it may damage discs and internal parts. Remove the disc, connect the power cord of the DVD video player to the wall outlet, turn on the DVD video player, and leave it for two or three hours. After two or three hours, the DVD video player will have warmed up and evaporated any moisture. Keep the DVD video player connected to the wall outlet and moisture condensation will seldom occur.

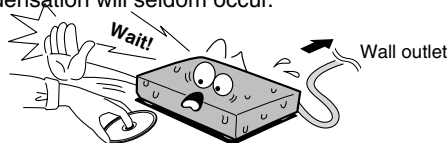



## On handling discs

- Do not touch the playback side of the disc.

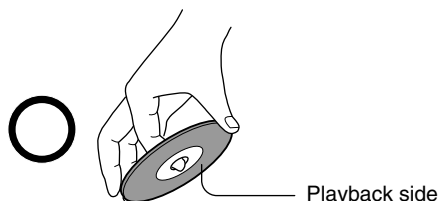

- Do not attach paper or tape to discs.



## On cleaning discs

- Fingerprints and dust on the disc cause picture and sound deterioration. Wipe the disc from the center outwards with a soft cloth. Always keep the disc clean.

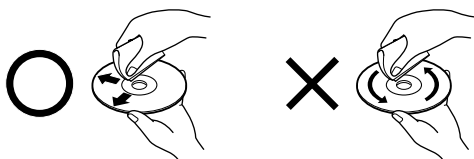

- If you cannot wipe off the dust with a soft cloth, wipe the disc lightly with a slightly moistened soft cloth and finish with a dry cloth.
- Do not use any type of solvent such as thinner, benzene, commercially available cleaners or antistatic spray for vinyl LPs. It may damage the disc.

## On storing discs

- Do not store discs in a place subject to direct sunlight or near heat sources.
- Do not store discs in places subject to moisture and dust such as a bathroom or near a humidifier.
- Store discs vertically in a case. Stacking or placing objects on discs outside of their case may cause warping.

## Structure of disc contents

Normally, DVD video discs are divided into titles, and the titles are sub-divided into chapters. Audio CDs are divided into tracks.

DVD video disc

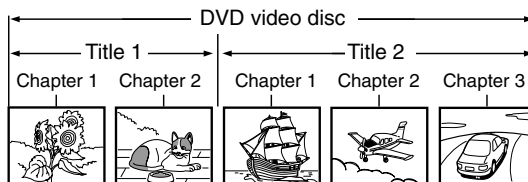

Audio CD

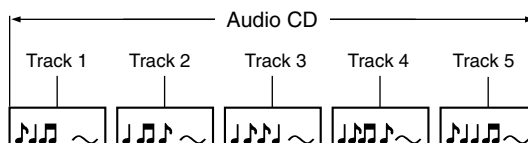

Each title, chapter or track is assigned a number, which is called "title number", "chapter number" or "track number" respectively.

There may be discs that do not have these numbers.

## Notes on copyright

It is forbidden by law to copy, broadcast, show, broadcast on cable, play in public, and rent copyrighted material without permission.

DVD video discs are copy protected, and any recordings made from these discs will be distorted.

This product incorporates copyright protection technology that is protected by method claims of certain U.S. patents and other intellectual property rights owned by Macrovision Corporation and other rights owners. Use of this copyright protection technology must be authorized by Macrovision Corporation, and is intended for home and other limited viewing uses only unless otherwise authorized by Macrovision Corporation. Reverse engineering or disassembly is prohibited.



## Notes on Discs (continued)

### About this owner's manual

This owner's manual explains the basic instructions of this DVD video player. Some DVD video discs are produced in a manner that allows specific or limited operation during playback. As such, the DVD video player may not respond to all operating commands. This is not a defect in the DVD video player. Refer to instruction notes of discs.



"Ⓢ" may appear on the TV screen during operation. A "Ⓢ" means that the operation is not permitted by the DVD video player or the disc.

### Notes on region numbers

The region number of this DVD video player is 1. If region numbers, which stand for their playable area, are printed on your DVD video disc and you do not find  or , disc playback will not be allowed by the player. (In this case, the DVD video player will display a message on-screen.)

### Playable discs

This DVD video player can play the following discs.

	Disc Mark	Contents	Disc Size	Maximum playback time
DVD video discs		Audio + video (moving pictures)	12 cm	Approx. 4 hours (single sided disc)
				Approx. 8 hours (double sided disc)
			8 cm	Approx. 80 minutes (single sided disc)
				Approx. 160 minutes (double sided disc)
Audio CDs		Audio	12 cm	Approx. 74 minutes
			8 cm (CD single)	Approx. 20 minutes

- You cannot play discs other than those listed above.
- You cannot play discs of CD-R, CD-RW, DVD-RAM, DVD-RW, etc., even if they may be labeled marks listed above.
- This DVD video player uses the NTSC color system, and cannot play DVD video discs recorded in any other color system (PAL, SECAM, etc.).

# Table of Contents

## Introduction

● SAFETY PRECAUTIONS .....	2
● IMPORTANT SAFETY INSTRUCTIONS ...	4
● Precautions .....	8
● Notes on Discs .....	9
Notes on region numbers .....	10
● Table of Contents .....	11
● Identification of Controls .....	12
Front panel .....	12
Rear panel .....	12
DVD display .....	13
Remote control .....	14
Loading batteries .....	15
Operating with the remote control .....	15

## Connections

● Connecting to a TV .....	16
Connecting to a TV .....	16
Connecting to an audio system and TV equipped with component video inputs .....	17
● Connecting to Optional Equipment .....	18
Connecting to an amplifier equipped with a Dolby Digital decoder .....	18
Connecting to an amplifier equipped with Dolby Pro Logic Surround .....	18
Connecting to an amplifier equipped with a DTS decoder .....	18
Connecting to an amplifier equipped with an MPEG2 audio decoder .....	19
Connecting to an amplifier equipped with a digital audio input .....	19

## Basic playback

● Playing a Disc .....	20
Basic playback .....	20
Playing in fast reverse or fast forward directions .....	22
Playing frame by frame .....	22
Playing in slow-motion .....	23
Resuming playback from the same location ...	23
● Locating a Specific Title, Chapter, or Track .....	24
Locating a title using the top menu .....	24
Locating a title by entering the title number ...	24
Locating a specific chapter or track directly ...	25
Locating a specific chapter or track .....	25

## Advanced playback

● Accessing a Specific Location Directly ...	26
Entering the time of the desired location .....	26
● Playing Repeatedly .....	27
Repeating a title, chapter, or track .....	27
Repeating a specific segment .....	27
● Playing in a Favorite Order .....	28
Setting titles, chapters, or tracks in a favorite order .....	28
● Playing in Random Order .....	29
Playing titles, chapters or tracks in random order .....	29
● Zooming a Picture .....	30
Zooming a picture .....	30
● Selecting the picture enhancement (E.P.M.) .....	31
Selecting the picture enhancement .....	31
● Selecting the sound enhancement (E.A.M.) .....	32
Selecting the sound enhancement .....	32
● Selecting the Camera Angle .....	33
Changing the camera angle .....	33
● Selecting Subtitles .....	34
Selecting a subtitle language .....	34
● Selecting a Language .....	35
Selecting a playback audio setting .....	35
● Operating in the on-screen display mode ...	36
Operating in the on-screen display mode .....	36

## Function setup

● Customizing the Function Settings .....	38
Setting procedure .....	38
Setting details .....	40

## Others

● Table of Languages .....	46
● Before Calling Service Personnel .....	47
● Specifications .....	48
● LIMITED WARRANTY DVD VIDEO PLAYER .....	49

# Identification of Controls

See the page in  for details.

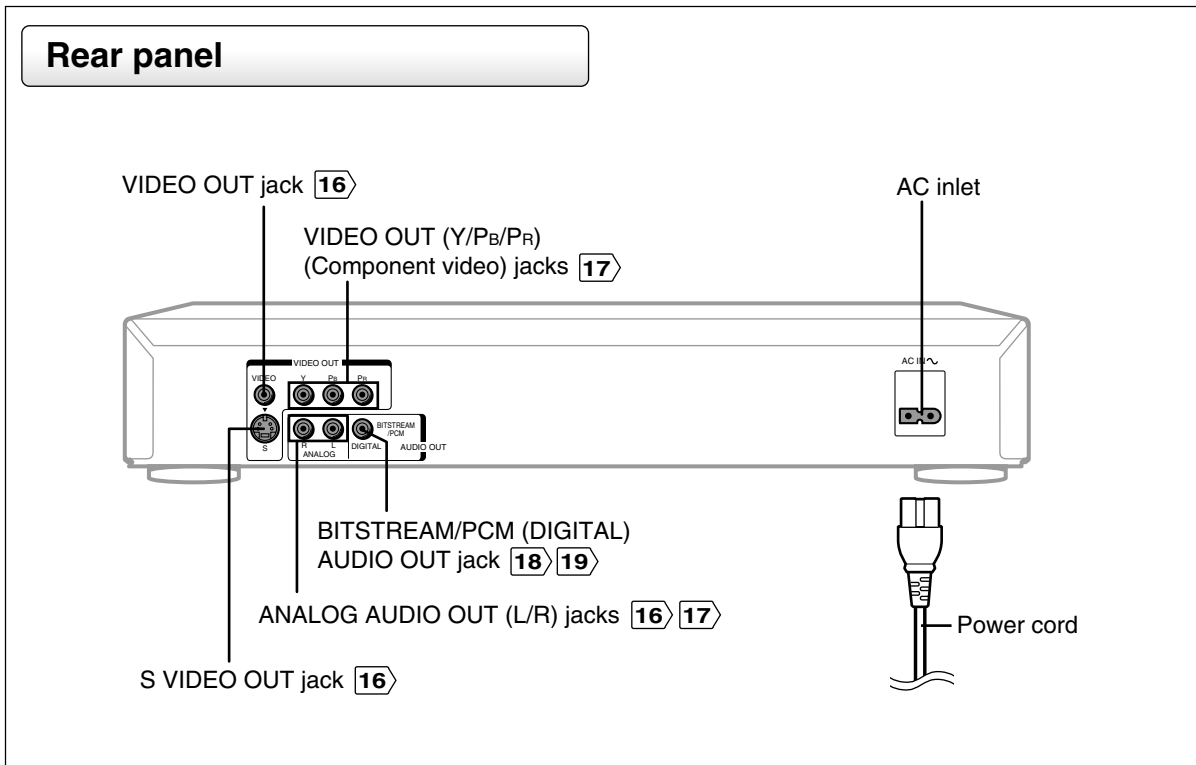
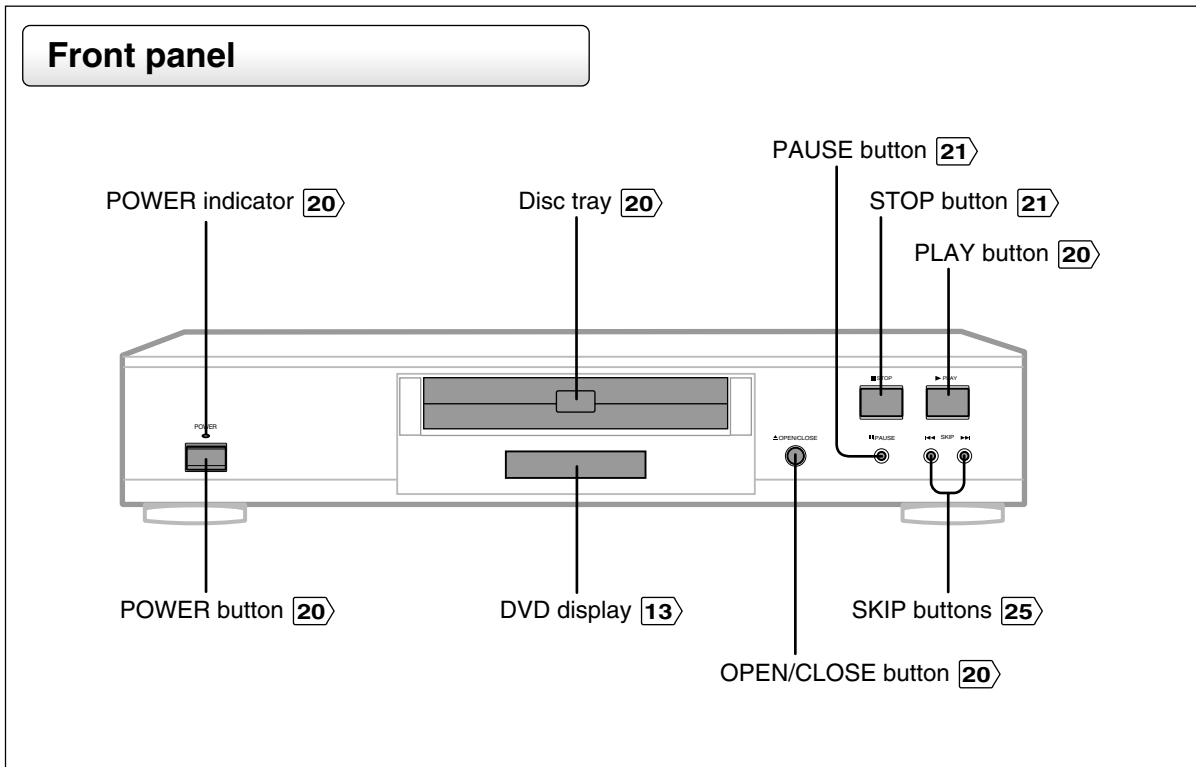

## DVD display

■ Pressing of the FL DIM button on the remote control changes the brightness of the display.

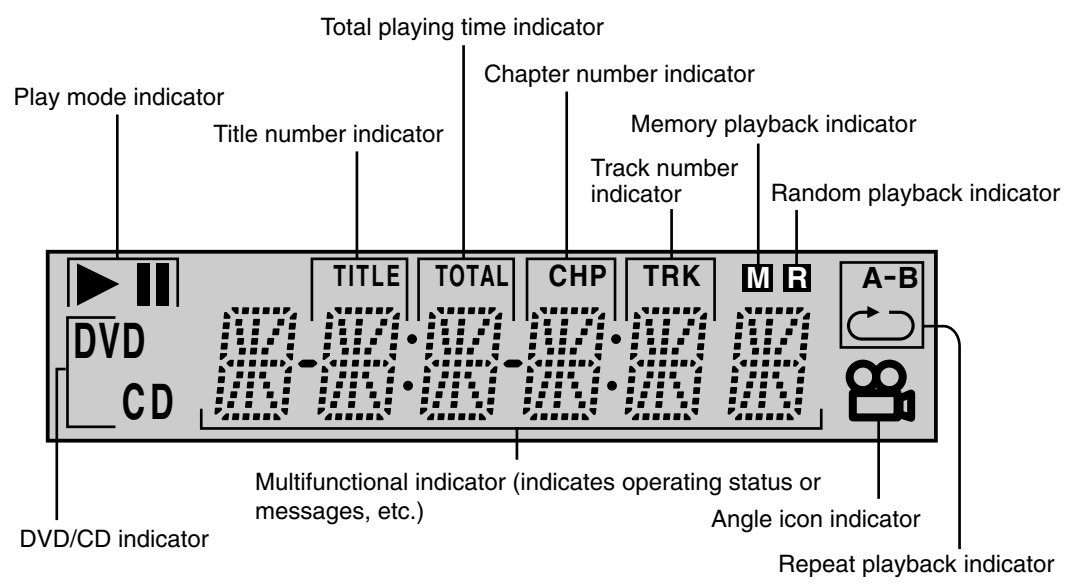
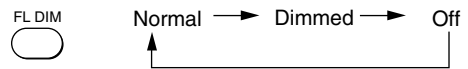

■ When you start playback, the elapsed time indicators appear. Pressing the FL SELECT button switches them to the title/chapter/track number indicators. Some discs may not permit this operation.

The indicators vary depending on the kinds of discs you play.

### DVD video disc

• During playback:

Example

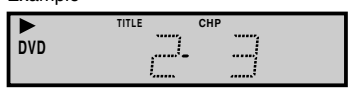

Playing chapter 3 of title 2

Some discs may not display chapter numbers or elapsed time.

### Audio CD

• During playback:

Example



Playing track 6

# Identification of Controls (continued)

The instructions in this manual describe the functions on the remote control. See the page in  for details.

## Remote control

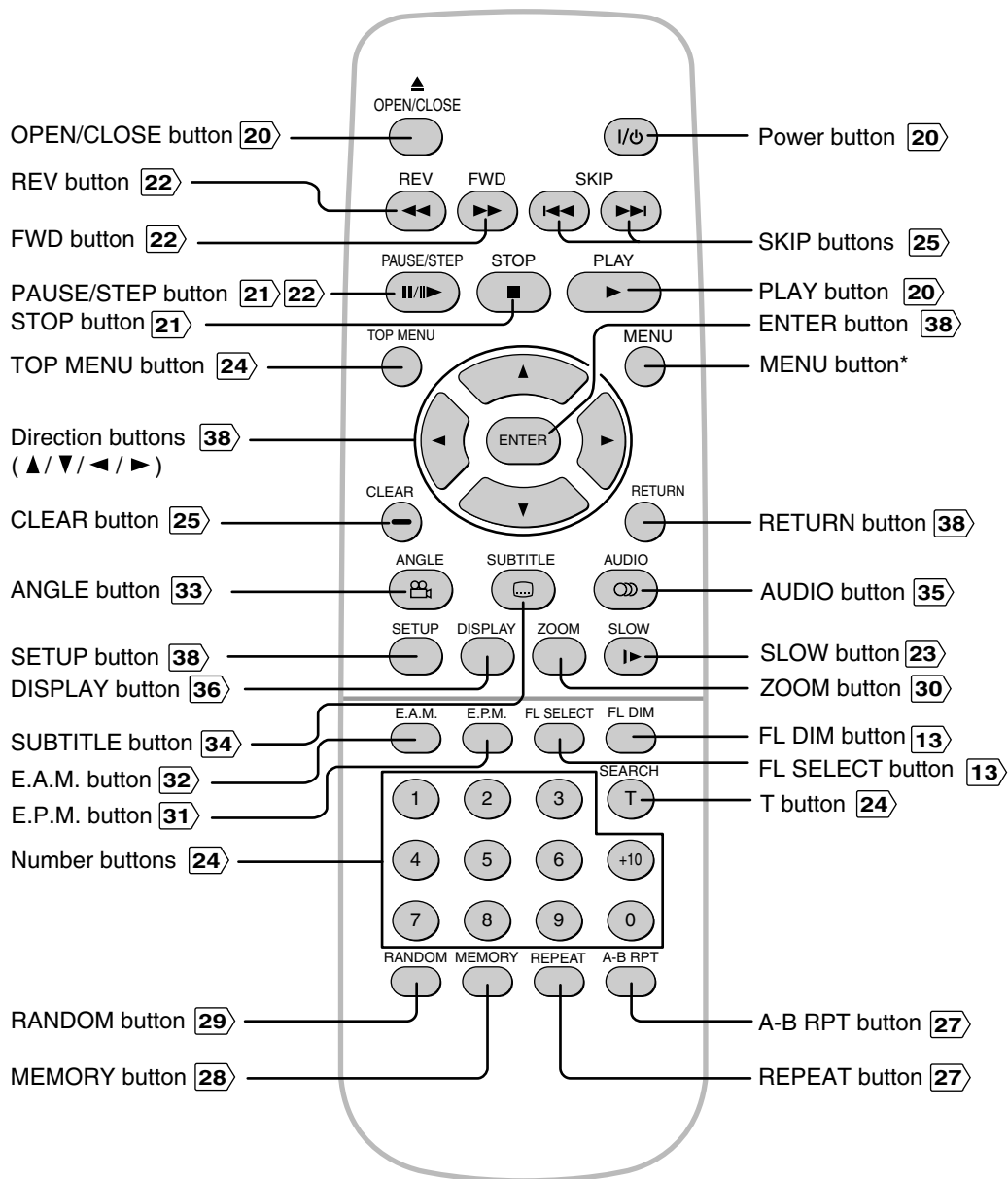

### \* MENU button

Use the MENU button to display the menu included on many DVD video discs. To operate a menu, follow the instructions in "Locating a title using the top menu."

[24]

## ■ About the illustrations of the battery compartment

There are two types of battery compartment in the supplied remote controls. (This does not mean a difference in performance between the two.)

Refer to either illustration depending on the actual remote control.

### Loading batteries

#### 1 Open the cover.

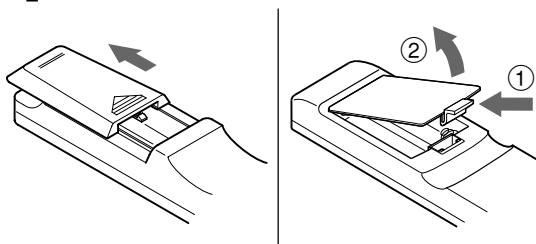

#### 2 Insert batteries (AA size).

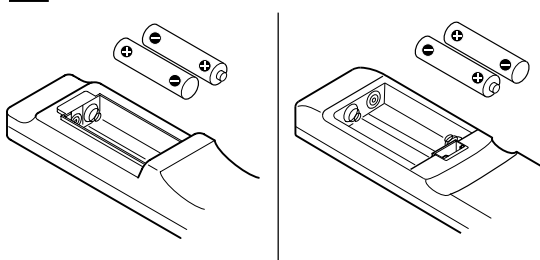

Make sure to match the + and – on the batteries to the marks inside the battery compartment.

#### 3 Close the cover.

### Notes on batteries

Improper use of batteries may cause battery leakage and corrosion. To operate the remote control correctly, follow the instructions below.

- Do not insert batteries into the remote control in the wrong direction.
- Do not charge, heat, open, or short-circuit the batteries. Do not throw batteries into a fire.
- Do not leave dead or exhausted batteries in the remote control.
- Do not use different types of batteries together, or mix old and new batteries.
- If you do not use the remote control for a long period of time, remove the batteries to avoid possible damage from battery corrosion.
- If the remote control does not function correctly or if the operating range becomes reduced, replace all batteries with new ones.
- If battery leakage occurs, wipe the battery liquid from the battery compartment, then insert new batteries.

### Operating with the remote control

#### Point the remote control at the remote sensor and press the buttons.

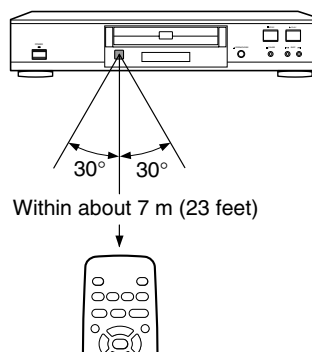

Distance: About 7 m (23 feet) from the front of the remote sensor

Angle: About 30° in each direction of the front of the remote sensor

\* Do not expose the remote sensor of the DVD video player to a strong light source such as direct sunlight or other illumination. If you do so, you may not be able to operate the DVD video player via the remote control.

### Notes on the remote control

- Direct the remote control at the remote sensor of the DVD video player.
- Do not drop or give the remote control a shock.
- Do not leave the remote control near an extremely hot or humid place.
- Do not spill water or put anything wet on the remote control.
- Do not open the remote control.

# Connecting to a TV

Connect the DVD video player to your TV.

For details of output sound, see [35](#).

## Connecting to a TV

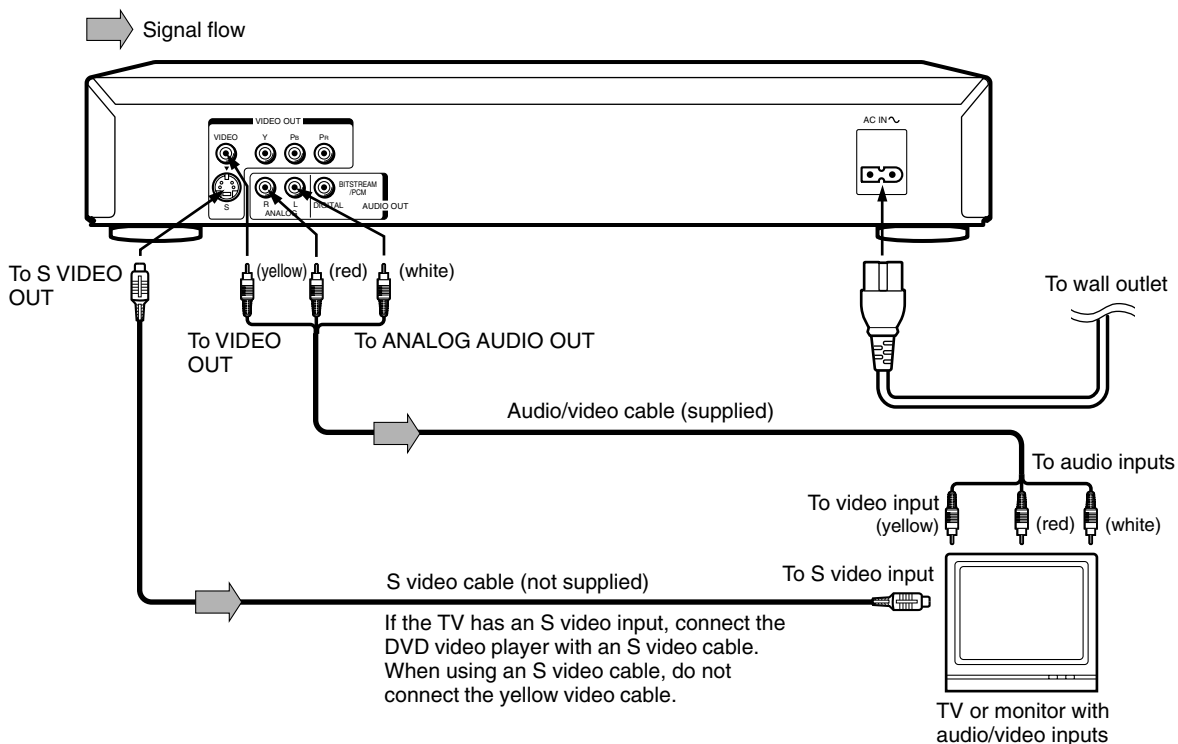

- Make the following setting.

On-screen display	Select:	Page
"Audio Out Select"	"Analog 2ch"	<a href="#">38</a> <a href="#">40</a>

### Notes

- Refer to the owner's manual of the connected TV as well.
- When you connect the DVD video player to your TV, be sure to turn off the power and unplug both units from the wall outlet before making any connections.
- If your television set has one audio input, connect the DVD video player to a Y cable adapter (not supplied) and then connect to your TV.
- Connect the DVD video player directly to your TV. If you connect the DVD video player to a VCR, TV/VCR combination or video selector, the playback picture may be distorted as DVD video discs are copy protected.



## Connecting to an audio system and TV equipped with component video inputs

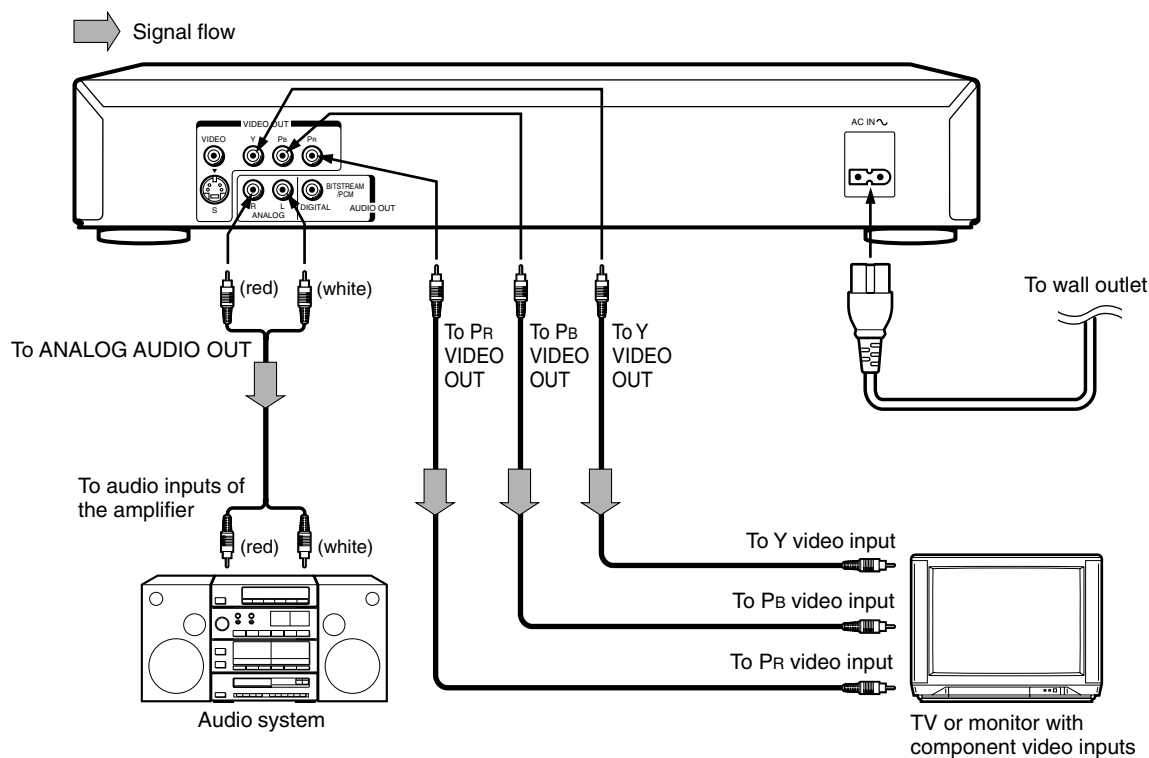

### Component video (ColorStream®) outputs/inputs

Some TVs or monitors are equipped with component video inputs. Connecting to these inputs allows you to enjoy higher quality picture playback.

Actual labels for component video inputs may vary depending on the TV manufacturer. (ex. Y, R-Y, B-Y or Y, Cb, Cr)

In some TVs or monitors, the color levels of the playback picture may be reduced slightly or the tint may change. In such a case, adjust the TV or monitor for optimum performance.

- Make the following setting.

On-screen display	Select:	Page
"Audio Out Select"	"Analog 2ch"	<b>38</b> <b>40</b>





### Notes

- Refer to the owner's manual of the connected equipment as well.
- When you connect the DVD video player to other equipment, be sure to turn off the power and unplug all of the equipment from the wall outlet before making any connections.
- If you place the DVD video player near a tuner or radio, the radio broadcast sound might be distorted. In this case, place the DVD video player away from the tuner and radio.
- The output sound of the DVD video player has a wide dynamic range. Be sure to adjust the receiver's volume to a moderate listening level. Otherwise, the speakers may be damaged by a sudden high volume sound.
- Turn off the amplifier before you connect or disconnect the DVD video player's power cord. If you leave the amplifier power on, the speakers may be damaged.

# Connecting to Optional Equipment

You can enjoy high quality dynamic sounds by connecting the DVD video player to optional audio equipment.

For connection to your TV, see "Connecting to a TV" **16** **17**.  
 For details of output sound, see **35**.

	: Front speaker		: Center speaker
	: Rear speaker		: Signal flow
	: Sub woofer		

## Connecting to an amplifier equipped with a Dolby Digital decoder

### Dolby Digital

Dolby Digital is the surround sound technology used in theaters showing the latest movies, and is now available to reproduce this realistic effect in the home. You can enjoy motion picture and live concert DVD video discs with this dynamic realistic sound by connecting the DVD video player to a 6 channel amplifier equipped with a Dolby Digital decoder or Dolby Digital processor. If you have a Dolby Pro Logic Surround decoder, you will obtain the full benefit of Pro Logic from the same DVD movies that provide full 5.1-channel Dolby Digital soundtracks, as well as from titles with the Dolby Surround mark.

Manufactured under license from Dolby Laboratories. "Dolby", "Pro Logic", and the double-D symbol are trademarks of Dolby Laboratories. Confidential unpublished works. ©1992-1997 Dolby Laboratories. All rights reserved.

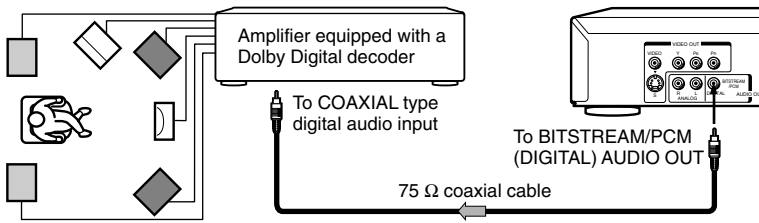

- Use DVD video discs encoded via the Dolby Digital recording system.
- Make the following setting.

On-screen display	Select:	Page
"Audio Out Select"	"Bitstream"	<b>38</b> <b>40</b>
Recording system	 D	<b>35</b>

## Connecting to an amplifier equipped with Dolby Pro Logic Surround

### Dolby Pro Logic Surround

You can enjoy the dynamic realistic sound of Dolby Pro Logic Surround by connecting an amplifier and speaker system (right and left front speakers, a center speaker, and one or two rear speakers).

- With an amplifier equipped with Dolby Digital  
 Connect the equipment the same way as described in "Connecting to an amplifier equipped with a Dolby Digital decoder." Refer to that amplifier's owner's manual and set the amplifier so you can enjoy Dolby Pro Logic Surround sound.
- With an amplifier not equipped with Dolby Digital  
 Connect the equipment as follows.

- Make the following setting.

On-screen display	Select:	Page
"Audio Out Select"	"Analog 2ch"	<b>38</b> <b>40</b>

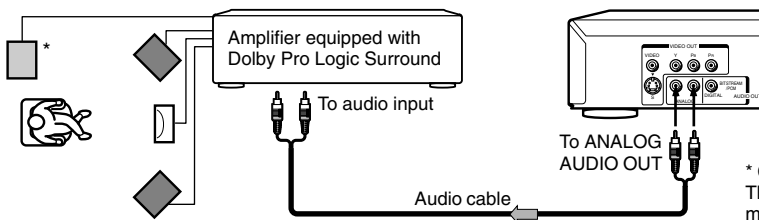

**Be sure to set "Audio Out Select" to "Analog 2ch" when you enjoy sounds of Dolby Pro Logic Surround using this connection.**

\* Connect one or two rear speakers. The output sound from the rear speakers will be monaural even if you connect two rear speakers.

## Connecting to an amplifier equipped with a DTS decoder

### Digital Theater Systems (DTS)

DTS is a high quality surround sound technology used in theaters and now available for home use, on DVD video discs or audio CDs. If you have a DTS decoder or processor, you can obtain the full benefit of 5.1 channel DTS encoded sound tracks on DVD video discs or audio CDs.

"DTS" and "DTS Digital Surround" are trademarks of Digital Theater Systems, Inc.

- Use DVD video discs or audio CDs encoded via the DTS recording system.
- Make the following setting.

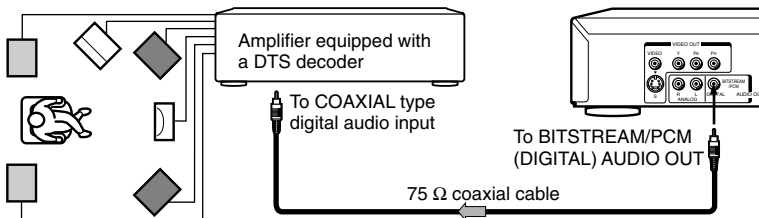

On-screen display	Select:	Page
"Audio Out Select"	"Bitstream"	<b>38</b> <b>40</b>
Recording system	DTS	<b>35</b>

**Warning**

- When you are connecting (via the BITSTREAM/PCM (DIGITAL) AUDIO OUT jack) an AV decoder that does not have Dolby Digital, Digital Theater Systems (DTS) or MPEG2 decoding function, be sure to set "Audio Out Select" to "PCM" from the on-screen displays **38** **40**. Otherwise, high volume sound may damage your hearing as well as the speakers.
- When playing DTS-encoded discs (DVD video discs and audio CDs), excessive noise may be output from the analog stereo jacks. To avoid possible damage to the audio system, you should take proper precautions when the ANALOG AUDIO OUT (L/R) jacks of the DVD video player are connected to an amplification system. To enjoy DTS Digital Surround™ playback, an external 5.1 channel DTS Digital Surround™ decoder system must be connected to the BITSTREAM/PCM (DIGITAL) AUDIO OUT jack of the DVD video player.

**Connecting to an amplifier equipped with an MPEG2 audio decoder**

**MPEG2 sound**

You can enjoy motion picture and live concert DVD video discs with dynamic realistic sound by connecting an amplifier equipped with an MPEG2 audio decoder or MPEG2 audio processor.

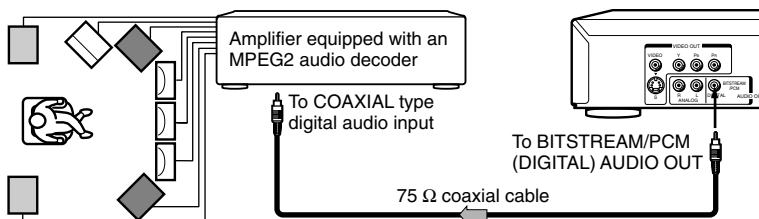

- Use DVD video discs encoded via the MPEG2 recording system.
- Make the following setting.

On-screen display	Select:	Page
"Audio Out Select"	"Bitstream"	<b>38</b> <b>40</b>
Recording system	MPEG	<b>35</b>

**Connecting to an amplifier equipped with a digital audio input**

**2 channel digital stereo**

You can enjoy the dynamic sound of 2 channel digital stereo by connecting an amplifier equipped with a digital audio input and speaker system (right and left front speakers).

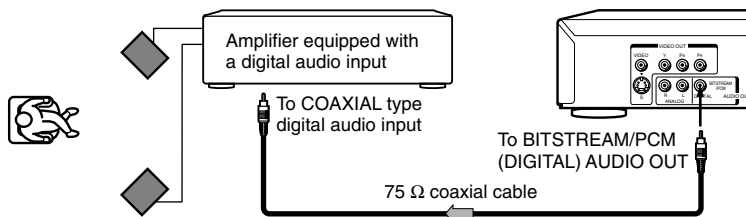

- Make the following setting.

On-screen display	Select:	Page
"Audio Out Select"	"PCM"	<b>38</b> <b>40</b>

**Notes**

- DO NOT connect the BITSTREAM/PCM (DIGITAL) AUDIO OUT jack of the DVD video player to the AC-3 RF input of a Dolby Digital Receiver. This input on your A/V Receiver is reserved for Laserdisc use only and is incompatible with the BITSTREAM/PCM (DIGITAL) AUDIO OUT jack of the DVD video player.
- Connect the BITSTREAM/PCM (DIGITAL) AUDIO OUT jack of the DVD video player to the "DIGITAL (COAXIAL)" input of a Receiver or Processor.
- Refer to the owner's manual of the connected equipment as well.
- When you connect the DVD video player to other equipment, be sure to turn off the power and unplug all of the equipment from the wall outlet before making any connections.
- The output sound of the DVD video player has a wide dynamic range. Be sure to adjust the receiver's volume to a moderate listening level. Otherwise, the speakers may be damaged by a sudden high volume sound.
- Turn off the amplifier before you connect or disconnect the DVD video player's power cord. If you leave the amplifier power on, the speakers may be damaged.

# Playing a Disc

This section shows you the basics on how to play a disc.

## CAUTION

Keep your fingers well clear of the disc tray as it is closing. Neglecting to do so may cause serious personal injury.

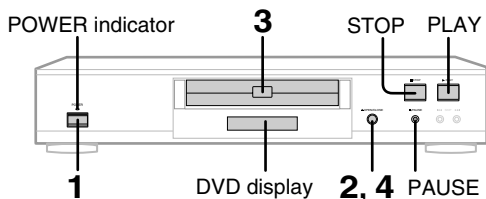

## DVD CD Basic playback

### Preparations

- When you want to view a disc, turn on the TV and select the video input connected to the DVD video player.
- When you want to enjoy the sound of discs from the audio system, turn on the audio system and select the input connected to the DVD video player.

### 1 Press the power button (POWER).



The DVD video player turns on and the POWER indicator on the player illuminates.

When the DVD video player is turned on for the first time, a message appears. Press **ENTER**, and make the proper settings before proceeding to step 2. [45](#)

### 2 Press OPEN/CLOSE.

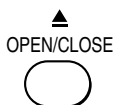

The disc tray opens.

### 3 Place the disc on the disc tray.

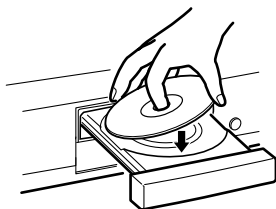

With the playback side down

- There are two different disc sizes. Place the disc in the correct guide on the disc tray. If the disc is out of the guide, it may damage the disc and cause the DVD video player to malfunction.
- Do not place a disc which is unplayable in this DVD video player.

### 4 Press OPEN/CLOSE to close the disc tray.

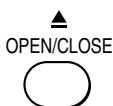

Playback starts.

If you insert a DVD video disc that contains a top menu, a menu may appear. See "Locating a title using the top menu." [24](#)

- You may need to press the TOP MENU or MENU button to display disc menu (depending on the actual DVD video disc.)

### ■ To start playback in the stop mode

Press **PLAY**.



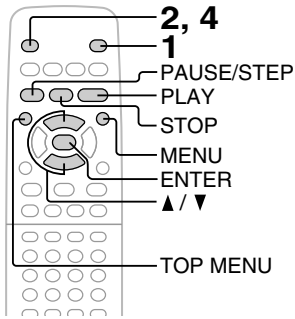





### ■ To obtain a higher quality picture

Occasionally, some picture noise not usually visible during a normal broadcast may appear on the TV screen while playing a DVD video disc because the high resolution pictures on these discs include a lot of information. While the amount of noise depends on the TV you use with this DVD video player, you should generally reduce the sharpness adjustment on your TV when viewing DVD video discs.

### ■ About

The   icons on the heading bar show the playable discs for the function described under that heading.

 : You can use this function with DVD video discs.

 : You can use this function with audio CDs.

### ■ To pause playback (still mode)

Press **PAUSE/STEP** during playback.



To resume normal playback, press the **PLAY** button.

- Sound is muted during still mode.

### ■ To stop playback

Press **STOP**.



### ■ About the screen saver

If you pause a picture of a DVD video disc and leave it still for a long while, the screen saver of the DVD video player automatically appears (when "Screen Saver" is set to "On" [43](#)). To turn off the screen saver, press the **PLAY** button.

### ■ Automatic Power Off function

If the DVD video player is stopped, or the screen saver is engaged for approximately 20 minutes, the DVD video player will automatically turn itself off.

### ■ To remove the disc

Press **OPEN/CLOSE**.

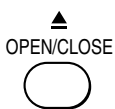

Remove the disc after the disc tray opens completely.

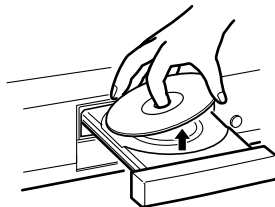

Be sure to press the **OPEN/CLOSE** button to close the disc tray after you remove the disc.

### Notes

- Do not move the DVD video player during playback. Doing so may damage the disc.
- Use the **OPEN/CLOSE** button to open and close the disc tray. Do not push the disc tray while it is moving. Doing so may cause the DVD video player to malfunction.
- Do not push up on the disc tray or put any objects other than discs on the disc tray. Doing so may cause the DVD video player to malfunction.
- In many instances, a menu screen will appear after playback of a movie is completed. Prolonged display of an on-screen menu may damage your television set, permanently etching that image onto its screen. To avoid this, be sure to press the **STOP** button on your remote control once the movie is completed.

## Playing a Disc (continued)

You can play discs at various speeds, and resume playback from the location where you stopped playback.

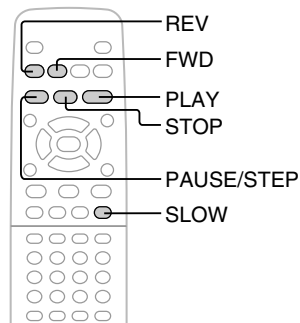

### Playing in fast reverse or fast forward directions

Press REV or FWD during playback.

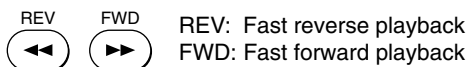

REV: Fast reverse playback  
FWD: Fast forward playback

Each time you press the REV or FWD button, the playback speed changes.

#### ■ To resume normal playback

Press **PLAY**.



#### Notes

- The DVD video player mutes sound and omits subtitles during reverse and forward scan of DVD video discs. However, the DVD video player plays sound during fast forward or fast reverse play of audio CDs.
- The playback speed may differ depending on the disc.

### Playing frame by frame

Press PAUSE/STEP during still playback.



Each time you press the PAUSE/STEP button, the picture advances one frame.

#### ■ To resume normal playback

Press **PLAY**.

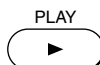

#### Note

The sound is muted during frame by frame playback.

## Playing in slow-motion

### Press SLOW during playback.



Each time you press the SLOW button, the slow-motion speed changes.

### ■ To resume normal playback

Press **PLAY**.



#### Note

The sound is muted during slow-motion playback.

## Resuming playback from the same location

### 1 Press STOP at the location where you want to interrupt playback.



The DVD video player memorizes the location where playback is stopped.

### 2 Press PLAY.



The DVD video player resumes playback from the location where you stopped playback.

### ■ To start playback from the beginning regardless of the location where you stopped playback

1 Press **STOP** twice.



The DVD video player's memory is cleared.

2 Press **PLAY**.



 Playback starts from the beginning of the current title.

 Playback starts from the beginning of the disc.

- If you want to return to the beginning of a DVD video disc, open and close the disc tray once with the OPEN/CLOSE button before pressing the PLAY button.

#### Notes

- The DVD video player's memory is also cleared when:
  - you change the parental lock setting **[43]** or select a disc menu language **[41]**.
  - you open the disc tray.
- There may be a difference in the location where playback resumes depending on the disc.
- Settings you changed using the on-screen displays while the DVD video player keeps a location in the memory may function only after the memory is cleared.

# Locating a Specific Title, Chapter, or Track

Normally, DVD video discs are divided into titles, and the titles are sub-divided into chapters. Audio CDs are divided into tracks. You can quickly locate any specific title, chapter, or track.

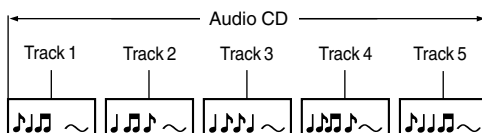
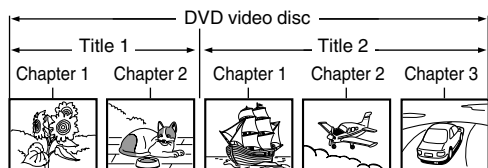

## DVD Locating a title using the top menu

### 1 Press TOP MENU.

TOP MENU



The top menu appears on the TV screen.

e.g.

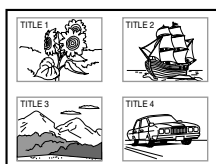

### 2 Press ▲/▼/◀/▶ to select the title you want.

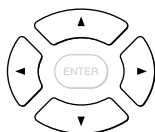

If the titles in the top menu are assigned a number, you can directly locate a specific title by pressing its designated number with the number buttons.

### 3 Press ENTER.

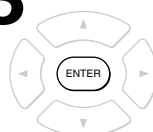

Playback starts from chapter 1 of the selected title.

#### Notes

- The instructions above describe basic procedures which may vary depending on the contents of the DVD video disc. If different instructions appear on the TV screen, follow those instructions.
- If you display the top menu during playback and press the TOP MENU button again without selecting any title, the DVD video player may resume playback from the point where you first pressed the TOP MENU button (depending on the actual DVD video disc.)
- This method of locating a title is available only on a disc that contains a top menu.
- Instruction notes of discs may refer to the button that displays the top menu as TITLE button.

## DVD Locating a title by entering the title number

### 1 Press T.

SEARCH



Make sure that the space of "T (Title)" is highlighted. (You can shift the highlight using the ◀/▶ buttons.)

e.g.

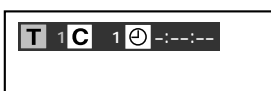

### 2 Enter the number for the title you want, using ▲/▼ or the number buttons.

e.g. To select title 2



To select title 12

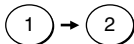

### 3 Press PLAY.

PLAY



Playback starts from chapter 1 of the selected title.

#### Notes

- Pressing the CLEAR button resets the title and chapter numbers. To clear the "T (Title)" and "C (Chapter)" display, press the T button several times.
- This method of locating a title is available only on a disc that contains title numbers.



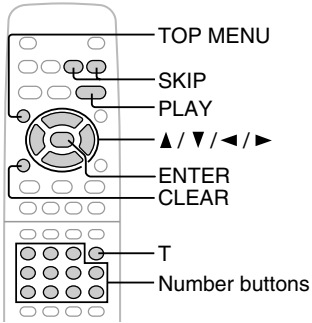

**DVD CD Locating a specific chapter or track directly**

**1 Press T.**

If you are using an audio CD, skip steps 1 and 2, then at steps 3, enter the number for the track you want using the number buttons.



**2 Press ► to highlight the space of “C (Chapter).”**

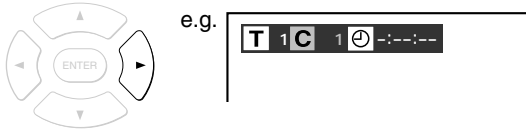

**3 Enter the number for the chapter or track you want, using ▲ / ▼ or the number buttons.**

When you use the number buttons, you can use the +10 button to select numbers from 10 through 99.

e.g. To select chapter or track 25

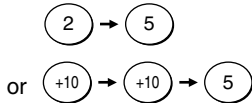

**4 Press PLAY.**

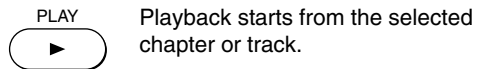

**■ To select a title and chapter number at the same time**

Perform step 1, and enter a title number you want in the space of “T (Title)” using the number buttons or the ▲ / ▼ buttons then perform steps 2 to 4.

**Note**

Pressing the CLEAR button resets the title and chapter numbers. To clear the “T (Title)” and “C (Chapter)” display, press the T button several times.

Basic playback

**DVD CD Locating a specific chapter or track**

**Press SKIP ◀◀ or ▶▶ repeatedly to display the chapter or track number you want.**

Playback starts from the selected chapter or track.

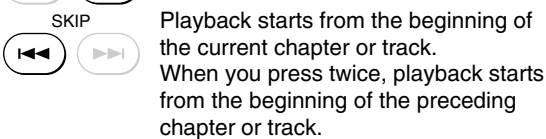
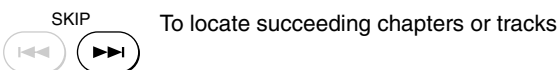

**Notes**

- Some titles may not display chapter numbers.
- If you press and hold the SKIP ◀◀ or ▶▶ button on the front panel during playback, the DVD video player performs fast reverse or fast forward playback. You can vary the speed by pressing the button repeatedly. To locate chapters or tracks during fast reverse or fast forward playback, first press the PLAY button to resume normal playback, then use the SKIP ◀◀ or ▶▶ button.
- When you set “Title Stop” to “Off” [45], you can access chapters in another title. If you go back to the preceding title by pressing the SKIP ◀◀ button, the DVD video player locates the first chapter of the title. When “Title Stop” is set to “On,” you can access chapters only within the current title.

## Accessing a Specific Location Directly

You can access a specific location by entering its corresponding time (hours, minutes, seconds).

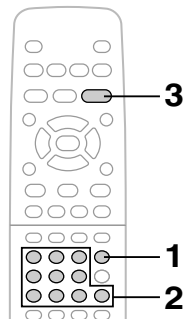

### Entering the time of the desired location

#### 1 Press T three times.

SEARCH



You may have to press further depending on the disc. Press the button repeatedly until the clock icon is highlighted.

e.g.

#### 2 Press the number buttons to enter the time.

e.g.

#### 3 Press PLAY.

PLAY



Playback starts from the desired location.

#### Notes

- Some discs may not respond to this process.
- Some scenes may not be located precisely as you specified.
- This method for accessing specific locations is available only within the current title of the DVD video disc or within the current track of the audio CD.

# Playing Repeatedly

You can play a specific title, chapter, track, or segment repeatedly. (Title repeat, chapter/track repeat, A-B repeat)

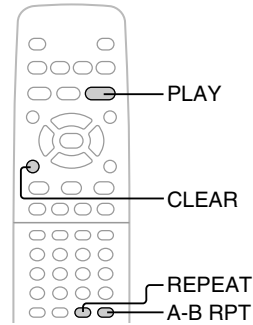
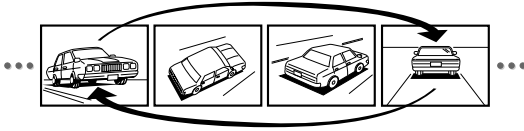

## Repeating a title, chapter, or track

### 1 Press REPEAT.



Each time you press the REPEAT button, the repeat mode changes as follows.

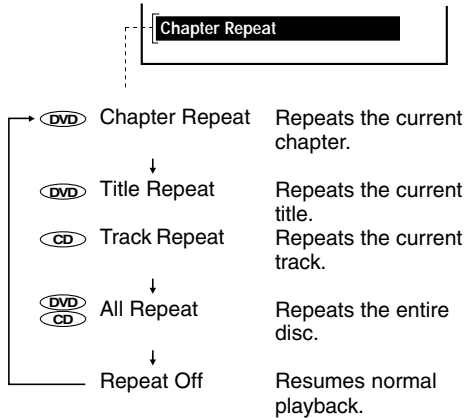

### 2 Press PLAY.



The DVD video player starts repeat playback. Press the PLAY button within about 5 seconds after you press the REPEAT button.

#### ■ To resume normal playback

Press **CLEAR**.



#### Note

Some discs may not permit repeat operation.

## Repeating a specific segment

### 1 Press A-B RPT at the beginning of the segment (point A) you want to play repeatedly.



### 2 Press A-B RPT again at the end of the segment (point B).



The DVD video player automatically returns to point A and starts repeat playback of the selected segment (A-B).



#### ■ To resume normal playback

Press **CLEAR**.



#### Notes

- Some discs may not permit A-B repeat operation.
- You cannot set the A-B repeat function for a segment that includes multiple camera angles **[33]**.
- You can specify a segment only within the current title.
- There may be a slight difference between point A and the location where playback actually resumes depending on the disc.

## Playing in a Favorite Order

You can combine your favorite titles, chapters, or tracks and play them in the order you determine. You can program up to 30 selections into the memory. (Memory playback)

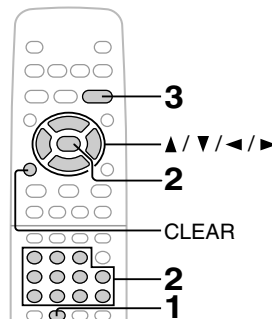

### Setting titles, chapters, or tracks in a favorite order

#### 1 Insert a disc and press MEMORY during stop.



The following display appears.

e.g.

1 T: CT:---
2 T:-- CT:---
3 T:-- CT:---
4 T:-- CT:---
5 T:-- CT:---
6 T:-- CT:---
7 T:-- CT:---

T: Title number  
CT: Chapter number  
or track number

#### 2 Select the items in the order you want by pressing the number buttons, then ENTER for each item.

Each time you press the ◀/▶ button, the space of "T" and "CT" is highlighted in turn. Highlight where you want to enter, then press the corresponding number buttons.

To select another chapter in the same title, you do not need to select the title number.

To select tracks from an audio CD in order, press the **number buttons** for the track, then press the **ENTER** button for each selection you want.

##### Note

The space of "T (Title)" may be showing a number. Neglect this number when using an audio CD.

#### 3 Press PLAY while the display appears on the TV screen.



The DVD video player starts memory playback.

#### ■ To change the programmed selections

- 1 While the display appears on the TV screen, press ▲/▼/◀/▶ to move the highlighted bar to the item you want to change.
- 2 Change the selection following the instructions in step 2.

#### ■ To cancel the programmed selections

- 1 While the display appears on the TV screen, press ▲/▼ to move the highlighted bar to the item you want to cancel.
- 2 Press **CLEAR**.

#### ■ To resume normal playback from memory playback

Press **CLEAR**.



The memory playback indicator disappears.

#### ■ To program during playback

If you press the **MEMORY** button during playback, a programming display appears. Follow steps 2 and 3.

#### Notes

- Some discs may not permit memory playback operation.
- If you press the REPEAT button during memory playback, the DVD video player repeats the current memory playback.
- If you press the MEMORY or RETURN button while the display appears on the TV screen, the display disappears.
- The programmed selections will be cleared when you turn off the DVD video player.

# Playing in Random Order

You can play titles, chapters within a title, or tracks in random order.  
(Random playback)

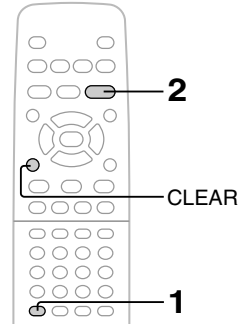

## Playing titles, chapters or tracks in random order

### 1 Press RANDOM.



Each time you press the RANDOM button, the random playback mode changes as follows.

Chapter Random

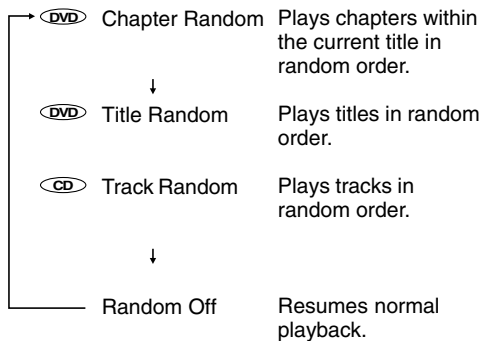

If you press the RANDOM button during playback, the DVD video player automatically starts random playback after finishing the current title, chapter or track.

### 2 Press PLAY.



The DVD video player starts random playback.  
Press the PLAY button within about 5 seconds after you press the RANDOM button.

### ■ To resume normal playback

Press CLEAR.



#### Notes

- Some discs may not permit random playback operation.
- You cannot use the random playback function in conjunction with the memory playback function.

# Zooming a Picture

You can magnify areas within a picture.

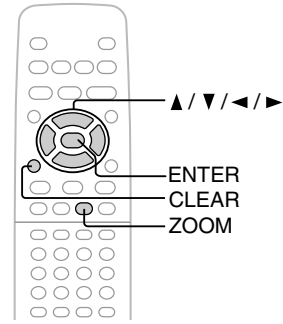
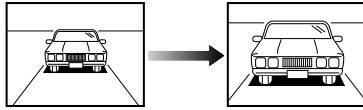

## DVD Zooming a picture

### Press ZOOM during normal, slow or still playback.



The DVD video player enters the zoom playback mode and displays the icon.

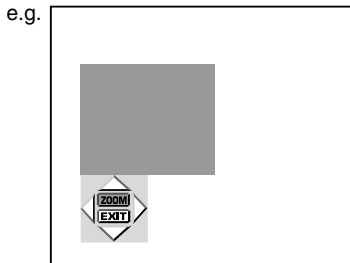

**ZOOM** : As you repeatedly press the ENTER (or ZOOM) button while “ZOOM” is selected, the magnification level changes. Variation of the levels includes reducing.

**EXIT** : If you press the ENTER button while “EXIT” is selected, you can turn off the icon, keeping the current magnification level.

You can shift the highlight within the icon by the ▲/▼/◀/▶ buttons.

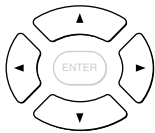

If you press and hold the ▲/▼/◀/▶ buttons, the zoom point shifts.



Pressing the CLEAR button restores the zoom point to the center of the picture.

### To resume normal playback

While “ZOOM” is selected, press ZOOM repeatedly to turn off the icon.

Picture restores the size when the icon disappears.



- The ENTER button cannot cancel zoom playback if you have turned off the icon by selecting “EXIT.” To restore normal picture size, press the ZOOM button to display the icon, then further press the ZOOM button until the icon turns off.

### Notes

- Some discs may not respond to zoom feature.
- During some scenes, the buttons may not work as described.
- Zooming does not work on subtitles or menus included on DVD video discs.
- While the icon is displayed, the ▲/▼/◀/▶ buttons cannot work on menus included on DVD video discs. If you want to view the menus, turn off the icon.
- The magnification level varies depending on the picture size you select. **40**

# Selecting the picture enhancement (E.P.M.\*)

You can easily switch the picture enhancement to your preference.

\*E.P.M.: Enhanced Picture Mode

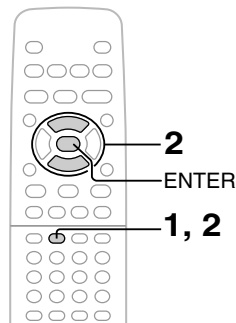

## DVD CD Selecting the picture enhancement

### 1 Press E.P.M.

E.P.M.



The picture enhancement selection appears.

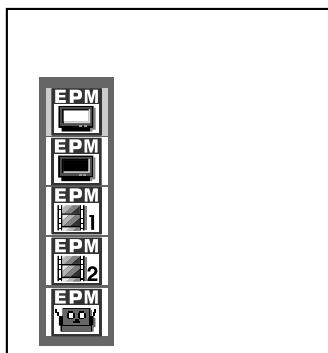

### ■ To turn off the picture enhancement selection

Press **ENTER**.

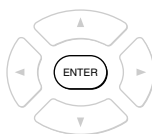

Alternatively leave the DVD video player unoperated for about 5 seconds after having made the selection.

#### Note

Actual effects to pictures may vary depending on the TV. Make the selection to your preference.

### 2 Select the picture enhancement by pressing E.P.M. or ▲ / ▼.

Each time you press the button, the picture enhancement changes.



Normal:  
Standard black level (7.5 IRE).



Enhanced Black Level:  
Enhanced Black Level (0 IRE).



Movie 1:  
To raise brightness to clarify details.



Movie 2:  
To deepen colors.



Animation:  
To raise contrast enhancing colors.

## Selecting the sound enhancement (E.A.M.\*)

You can easily switch the sound enhancement to your preference.

\*E.A.M.: Enhanced Audio Mode

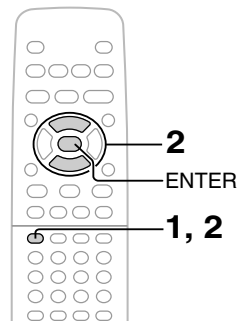

### DVD CD Selecting the sound enhancement

#### 1 Press E.A.M.

E.A.M.



The sound enhancement selection appears.

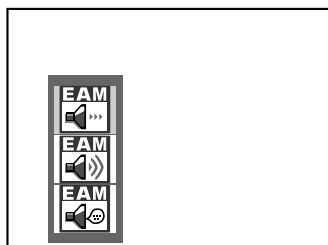

#### 2 Select the sound enhancement by pressing E.A.M. or ▲ / ▼.

Each time you press the button, the sound enhancement changes.



Normal:  
Normal sound.



3D (N-2-2):  
To obtain expansive virtual surround sound effects from just two speakers.



Dialogue:  
To control dynamic range to make dialogues easier to hear (only when playing a DVD video disc recorded on the Dolby Digital recording system).

- To use this enhancement on sounds output from the BITSTREAM/PCM (DIGITAL) AUDIO OUT jack, be sure to set "Audio Out Select" to "PCM". **40**

#### To turn off the audio enhancement selection

Press **ENTER**.

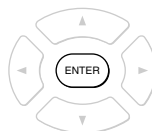

Alternatively leave the DVD video player unoperated for about 5 seconds after having made the selection.

#### Notes

- Actual effects to sounds may vary depending on the speakers. Make the selection to your preference.
- Actual effects to sounds may vary depending on the disc.
- When the DVD video player is connected to an amplifier equipped with Dolby Pro Logic Surround, select "Normal". Otherwise, Dolby Pro Logic Surround may function differently than usual.
- Selecting "Dialogue" disables "Dynamic Range Control" function **40**.

Spatializer® 3-Dimensional Sound Processing provided by Desper Products, Inc.

Certain audio features of this product manufactured under a license from Desper Products, Inc., Spatializer® and the circle-in-square device are trademarks owned by Desper Products, Inc.



## Selecting the Camera Angle

If the scene was recorded from multiple angles, you can easily change the camera angle of the scene you are watching.

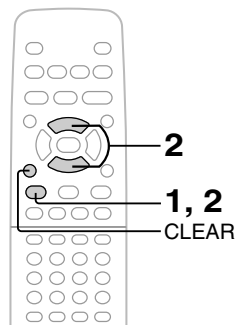
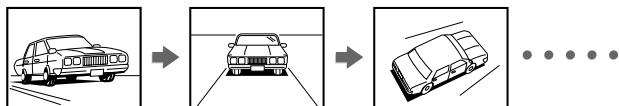

### DVD Changing the camera angle

#### 1 Press ANGLE while playing a scene recorded with multiple angles.



While playing a scene recorded with multiple angles, the angle icon (📷) flashes in the DVD display. Press the ANGLE button while the angle icon is flashing.

e.g.



#### ■ To turn off the angle number display

Press CLEAR.



#### Notes

- You can change the camera angle during still playback. The camera angle changes to the new setting when you resume normal playback.
- If you pause a picture immediately after changing a camera angle, the resumed playback picture may not display the new camera angle.

#### 2 Press ANGLE or ▲ / ▼ while the angle number is displayed on the TV screen.



Each time you press the ANGLE button, the camera angle changes.

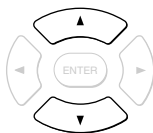

You can change the camera angle directly by pressing the number buttons corresponding to its angle number instead of using the ▲ / ▼ buttons.

# Selecting Subtitles

You can display subtitles on the TV screen and select a subtitle language from those included on the DVD video disc.

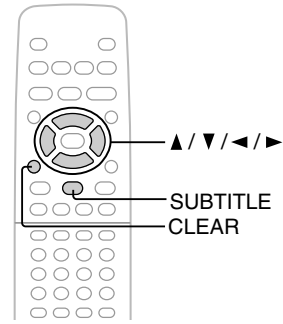
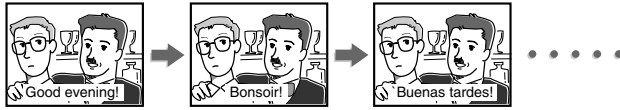

## DVD Selecting a subtitle language

### 1 Press SUBTITLE during playback.

**SUBTITLE** The current subtitle setting is displayed.



e.g.



The abbreviation of the language appears instead of the language name. Refer to the list of languages and their abbreviations. [46](#)

### 2 Press SUBTITLE or ▲ / ▼ while the subtitle setting is displayed on the TV screen.

**SUBTITLE** Each time you press the SUBTITLE button, the subtitle languages included on the DVD video disc change.

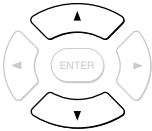

To turn off the subtitle setting display, press the CLEAR or ENTER button.

### ■ To turn subtitles on or off

1 Press **SUBTITLE** during playback.



2 Press **◀ / ▶** while the subtitle setting is displayed on the TV screen, to select "On" or "Off."

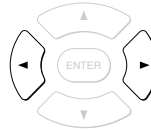

### Notes

- Some DVD video discs are set to display subtitles automatically, and you cannot turn them off even if you set the subtitle function to off.
- During some scenes, the subtitles may not appear immediately after you select "On."
- Some DVD video discs will allow you to make subtitle selections and turn subtitles on or off only via the disc menu.

### Notes

- When you turn on the DVD video player or replace a disc, the player returns to the initial default setting [42](#).
- When you select a subtitle language which is not included on the disc, the DVD video player plays a prior language programmed on the disc.
- During some scenes, the subtitles may not appear immediately after you change the subtitle language.

# Selecting a Language

You can select a preferred language and sound recording system from those included on the DVD video disc.

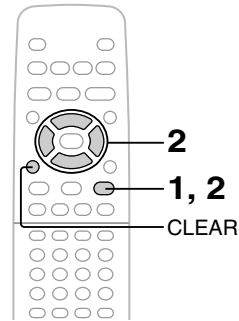
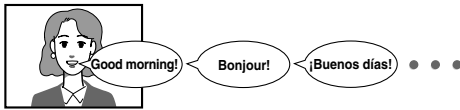

## DVD Selecting a playback audio setting

**1 Press AUDIO during playback.**  
 The current audio setting is displayed.



e.g.

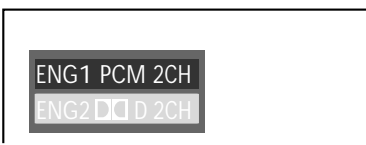

The abbreviation of the language appears instead of the language name. Refer to the list of languages and their abbreviations. **46**

**2 Press AUDIO or ▲ / ▼ while the audio setting is displayed on the TV screen.**



Each time you press the AUDIO button, the audio settings included on the DVD video disc change.

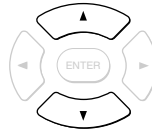

If you press the ◀ / ▶ buttons, you can select output sound format. **40**

To turn off the audio setting display, press the CLEAR button.

### Notes

- When you turn on the DVD video player or replace a disc, player returns to the initial default setting **42**.  
If you select a sound track which is not included on the disc, the DVD video player plays a prior sound track programmed on the disc.
- Some discs allow you to change audio selections only via the disc menu. If this is the case, press the MENU button and choose the appropriate language from the selections on the disc menu.

### Output sound conversion table (sampling frequency/quantization bit)

Discs	Recording system	Audio selection from the menu <b>38</b> <b>40</b> and output jacks on the rear panel					
		"Bitstream"		"Analog 2ch"		"PCM"	
		BITSTREAM/PCM jack	ANALOG AUDIO OUT jacks	BITSTREAM/PCM jack	ANALOG AUDIO OUT jacks	BITSTREAM/PCM jack	ANALOG AUDIO OUT jacks
DVD video discs	Dolby Digital	Bitstream	48 kHz/20 bit	Bitstream	48 kHz/20 bit	48 kHz/16 bit	48 kHz/20 bit
	Linear PCM	48 kHz/16 bit	48 kHz/16 bit	48 kHz/16 bit	48 kHz/16 bit	48 kHz/16 bit	48 kHz/16 bit
		48 kHz/20 bit	48 kHz/16 bit	48 kHz/20 bit	48 kHz/16 bit	48 kHz/16 bit	48 kHz/20 bit
		48 kHz/24 bit	48 kHz/16 bit	48 kHz/24 bit	48 kHz/16 bit	48 kHz/16 bit	48 kHz/24 bit
		96 kHz/16 bit	48 kHz/16 bit	48 kHz/16 bit	—	96 kHz/16 bit	48 kHz/16 bit
		96 kHz/20 bit	48 kHz/16 bit	48 kHz/20 bit	—	96 kHz/20 bit	48 kHz/16 bit
	96 kHz/24 bit	48 kHz/16 bit	48 kHz/24 bit	—	96 kHz/24 bit	48 kHz/16 bit	
DTS	Bitstream	—	Bitstream	—	—	—	
Audio CDs	MPEG1, MPEG2	Bitstream	48 kHz/16 bit	Bitstream	48 kHz/16 bit	48 kHz/16 bit	48 kHz/16 bit
	Linear PCM 44.1 kHz/16 bit	44.1 kHz/16 bit	44.1 kHz/16 bit	44.1 kHz/16 bit	44.1 kHz/16 bit	44.1 kHz/16 bit	
	DTS	Bitstream	(Noise)	Bitstream	(Noise)	Bitstream	(Noise)

◻ : 3D (N-2-2) sound enhancement can function.

# Operating in the on-screen display mode

When you turn on the on-screen display, you can view information on operational status and access the features and settings on-screen.

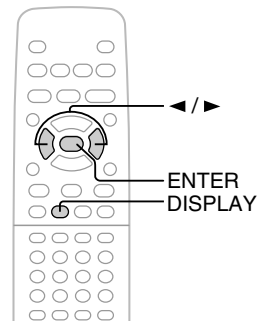

## DVD CD Operating in the on-screen display mode

### Press DISPLAY.

DISPLAY



The following display appears.

Each time you press the DISPLAY button, the on-screen display changes as follows.

If you press the ◀/▶ buttons to select an icon, then press the ENTER button, you can access the feature.

When you select an icon (\*), no need to press the ENTER button.

See the pages in □ for details on the features.

e.g. When playing a DVD video disc



Press DISPLAY again.

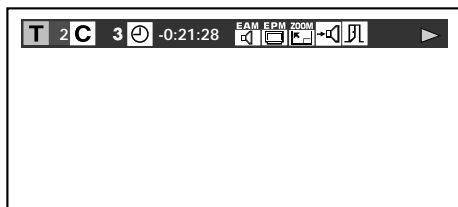

Press DISPLAY again.



- T**\* : Title number (Track number)  
To locate a title or track using the number. **24**
- C**\* : Chapter number  
To locate a chapter using the number. **25**
- ⌚**\* : Elapsed time of the current title  
To enter the time to locate a desired location. **26**
- 🔊** : Audio setting **35**
- ⋮** : Subtitle setting **34**
- 🎥** : Angle setting **33**
- 🔊** : To turn off the display.

- T**\* : Title number (Track number)  
To locate a title or track using the number. **24**
- C**\* : Chapter number  
To locate a chapter using the number. **25**
- ⌚**\* : Remaining time of the current title  
To enter the time to locate a desired location. **26**
- E.A.M** : E.A.M. (Enhanced Audio Mode) setting **32**
- E.P.M** : E.P.M. (Enhanced Picture Mode) setting **31**
- ZOOM** : To zoom a picture. **30**
- 🔊** : "Audio Out Select" setting **40**  
BST: Bitstream 2CH: Analog 2ch PCM: PCM
- 🔊** : To turn off the display.

(continued)

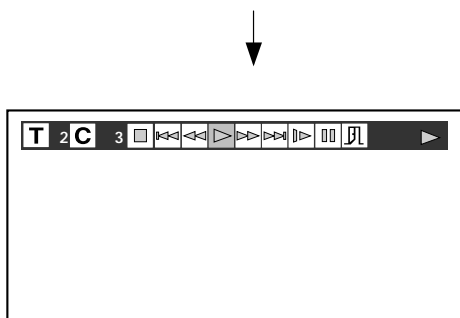

Press DISPLAY again.

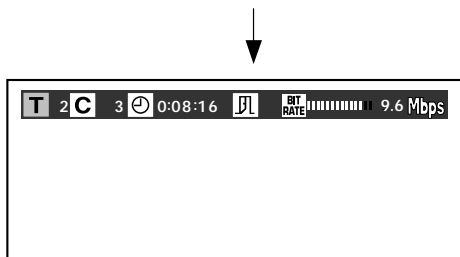



OFF

To turn off the on-screen display, press DISPLAY again.

**T**\* : Title number (Track number)  
To locate a title or track using the number. **[24]**

**C**\* : Chapter number  
To locate a chapter using the number. **[25]**

 : To stop playback. **[21]**

 : Playback starts from the beginning of the current chapter or track. **[25]**

 : Fast reverse playback **[22]**

 : To start playback. **[20]**

 : Fast forward playback **[22]**

 : To locate succeeding chapters or tracks. **[25]**

 : To slow motion playback. **[23]**

 : To pause playback. **[21]**

 : To turn off the display.

The on-screen display will vary depending on the disc.

 : Data transfer rate (Mbit/s)  
= Amount of picture, sound and subtitle data in the DVD video disc transferred per second.  
The larger the value is, the more data processed, but this does not necessarily insure better picture quality.

 : CD-Text  
Displays CD-Text data if included on the audio CDs. (Some letters may not be displayed properly depending on the disc.)

# Customizing the Function Settings

You can change the default settings to customize performance to your preference.

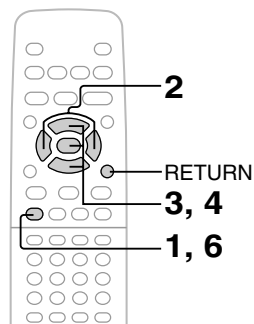

## DVD CD Setting procedure

**1** Press **SETUP** during stop.  
 The following on-screen display appears.

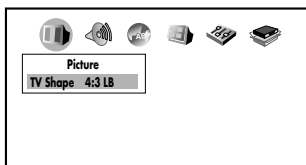

**2** Press **◀/▶** to select a symbol for the setting you want to change.

(See the next page.)

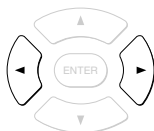

Picture performance settings



Output sound settings



Language settings



Display settings



Operational settings



Initial settings

**3** Press **▲/▼** to select the setting you want to change, then press **ENTER**.

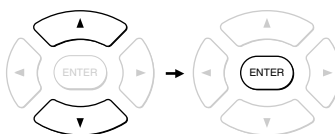

**4** Change the selection by **▲/▼** or other buttons, by referring to the corresponding pages **[39]**, then press **ENTER**.

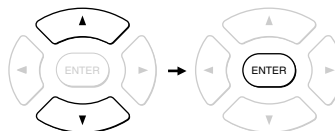

**5** Repeat steps 3 and 4 to change other settings.

To select another operation, go back to step 2.

**6** Press **SETUP**.



The on-screen display disappears.



























■ **To return to the previous display**

Press **RETURN**.



**Notes**

- The on-screen display disappears when you press the **SETUP** button.
- The **SETUP** button can function even during normal playback, however some operations may be inaccessible, and a message will appear. In this case, try again after playback is stopped.

Setting		Details	Page
 TV Shape		To select a picture size according to the aspect ratio of your TV.	40
 Audio Out Select	 	To select an output sound format corresponding to your system connection.	40
Dynamic Range Control		To turn on or off a function that makes faint sounds easier to hear even if you lower the volume during late hours playback.	40
Karaoke Vocal		To turn on or off the vocal output during DVD KARAOKE disc playback.	41
 On-Screen Language	 	To select a preferred language for on-screen displays.	41
Disc Menu Language		To select a preferred language for disc menus.	41
Audio Language		To select a preferred language for the sound track.	42
Subtitle Language		To select a preferred language for subtitles.	42
 On-Screen Displays	 	To turn on or de-activate the operational status display on the TV screen.	43
Background	 	To select the background color or background picture.	43
Screen Saver		To turn the screen saver on or off.	43
 Pause/Still		To select the resolution of still pictures. (Field/Frame)	43
Parental Lock		To turn the parental lock function on or off.	43
Title Stop		To turn on or off a feature that automatically stops playback after a title has been viewed.	45
 On-screen Language TV Shape Audio Out Select	 	To install the initial system setting.	45

# Customizing the Function Settings (continued)

## Setting details

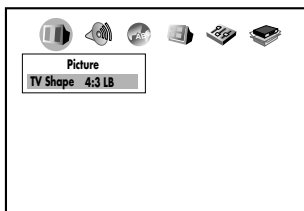

### TV Shape DVD

**4:3 Letterbox:** Select when a standard 4:3 TV is connected. Displays theatrical images with masking bars above and below the picture.



**4:3 Normal:** Select when a standard 4:3 TV is connected. Displays pictures cropped to fill your TV screen. Either or both sides of the picture are cut off.



**16:9 Widescreen:** Select when a 16:9 wide TV is connected.

#### Notes

- The displayable picture size is preset on the DVD video disc. Therefore, the playback picture of some DVD video discs may not conform to the picture size you select.
- When you play DVD video discs recorded in the 4:3 picture size only, the playback picture always appears in the 4:3 picture size regardless of the TV shape setting.
- If you select "16:9 Widescreen" and you own a 4:3 TV set, the DVD playback picture will be horizontally distorted during playback. Images will appear to be horizontally compressed. Always be sure that your TV shape conforms to the actual TV in use.

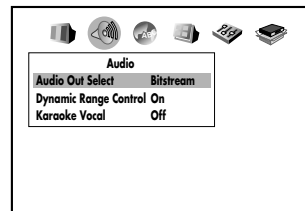

### Audio Out Select DVD CD

Select the output sound format corresponding to your system connection. For details of sound recording systems, see [35](#).

**Bitstream:** Select when connected to an amplifier equipped with a Dolby Digital, DTS, MPEG1 or MPEG2 decoder. [18](#) [19](#)  
The DVD video player outputs digital audio information in the bitstream format when you play a DVD video disc recorded on the Dolby Digital, DTS, MPEG1 or MPEG2 recording system.

**Analog 2ch:** Select when connected to a TV, or Dolby Pro Logic or stereo system via the analog audio jacks. [16](#) [17](#) [18](#)

**PCM:** Select when connected to a 2 channel digital stereo amplifier. [19](#)  
The DVD video player outputs sounds in the PCM 2ch format when you play a DVD video disc recorded on the Dolby Digital, MPEG1 or MPEG2 recording system.

### Dynamic Range Control DVD

**Off:** Full dynamic range is maintained.  
**On:** Dynamic range is reduced.

#### Notes

- This function works only during playback of Dolby Digital recorded discs.
- The level of Dynamic Range Reduction may differ depending on the DVD video disc.



## Karaoke Vocal

Off: The primary vocal is not output.

On: The primary vocal is output when it is recorded on the disc.

### Notes

- The vocal output feature is used during playback of Dolby Digital (multi-channel) recorded DVD KARAOKE discs. This feature allows you to turn off vocal audio tracks, or restore them for background accompaniment.
- When playing KARAOKE, connect appropriate audio equipment such as an amplifier to the DVD video player.

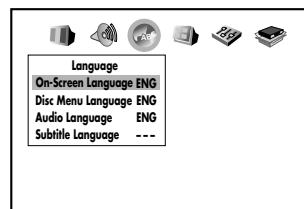

## On-Screen Language

English: To view on-screen displays in English.

Français: To view on-screen displays in French.

Español: To view on-screen displays in Spanish.

## Disc Menu Language

English: To display disc menus in English.

French: To display disc menus in French.

Spanish: To display disc menus in Spanish.

Others: To make a further choice.

After pressing the ENTER button, follow steps 1) - 4) below.

- 1) Obtain the abbreviation of the preferred language from the list **46**.
- 2) Select the first character by pressing the ▲ / ▼ buttons.
- 3) Press the ◀ / ▶ buttons to shift and select the second character by pressing the ▲ / ▼ buttons.

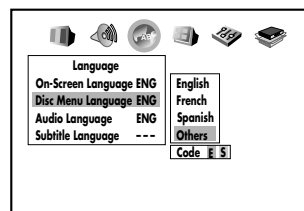

- 4) Press the ENTER button.

### Note

Some DVD video discs may not include your pre-selected language. In this case, the DVD video player automatically displays disc menus consistent with the disc's initial language setting.

# Customizing the Function Settings (continued)

## Setting details

### Audio Language (DVD)

English: To play sound tracks in English.

French: To play sound tracks in French.

Spanish: To play sound tracks in Spanish.

Others: To make a further choice.

After pressing the ENTER button, follow steps 1) - 4) below.

- 1) Obtain the abbreviation of the preferred language from the list **[46]**.
- 2) Select the first character by pressing the ▲ / ▼ buttons.
- 3) Press the ◀ / ▶ buttons to shift and select the second character by pressing the ▲ / ▼ buttons.

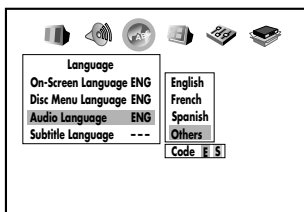

- 4) Press the ENTER button.

#### Note

Some DVD video discs may be played in a different language than you selected. A prior language may be programmed on the disc.

### Subtitle Language (DVD)

English: To display subtitles in English.

French: To display subtitles in French.

Spanish: To display subtitles in Spanish.

No Subtitle: To disable subtitles.

Others: To make a further choice.

After pressing the ENTER button, follow steps 1) - 4) below.

- 1) Obtain the abbreviation of the preferred language from the list **[46]**.
- 2) Select the first character by pressing the ▲ / ▼ buttons.

- 3) Press the ◀ / ▶ buttons to shift and select the second character by pressing the ▲ / ▼ buttons.

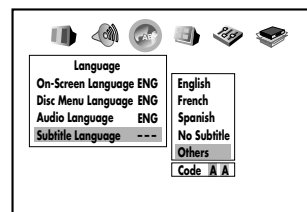

- 4) Press the ENTER button.

#### Notes

- Some DVD video discs may be set to display subtitles in a different language than you selected. A prior subtitle language may be programmed on the disc.
- Some DVD video discs allow you to change subtitle selections only via the disc menu. If this is the case, press the MENU button and choose the appropriate subtitle language from the selection on the disc menu.

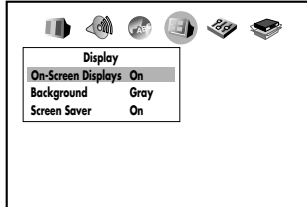

**On-Screen Displays** (DVD) (CD)

- Off: Operational modes (e.g. "||", ">>") are not displayed.
- On: Operational modes (e.g. "||", ">>") are displayed on-screen.

**Background** (DVD) (CD)

- Blue: Blue background.
- Gray: Gray background.
- Picture: To use the picture which appears when you turn on the DVD video player as a background.
- Jacket: To use the jacket picture included on some discs as a background. If it is not included, a gray background will be substituted.

**Screen Saver** (DVD)

- Off: The screen saver is disengaged.
- On: The screen saver operates.

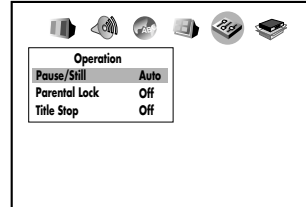
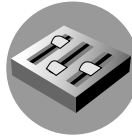

**Pause/Still** (DVD)

- Auto: For normal use. Still and fast motion images can be paused.
- Frame: The resolution of still pictures is improved, so that you can make a motionless picture more clearer when you pause it.

**Parental Lock** (DVD)

DVD video discs equipped with the parental lock function are rated according to their content. The contents allowed by a parental lock level and the way a DVD video disc can be controlled may vary from disc to disc. For example, if the disc allowed you could edit out violent scenes unsuitable for children and replace them with more suitable scenes, or lock out playback of the disc altogether.

- DVD video discs may or may not respond to the parental lock settings. This is not a defect in the DVD video player. Make sure this function works with your DVD video discs.
- Off: The parental lock feature does not function. After pressing the ENTER button, follow step 1) below.
- On: To activate the parental lock feature or change the settings. After pressing the ENTER button, follow steps 1) - 3) below.

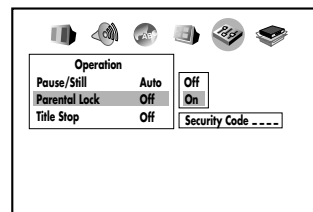

(Continued)

# Customizing the Function Settings (continued)

## Setting details

(Continued)

- 1) Press the number buttons to create a personal 4-digit security code, then press the ENTER button.

If you make a mistake before pressing the ENTER button, press the CLEAR button and enter your 4-digit security code again.

- 2) Enter the code of a country/area whose standards were used to rate the DVD video disc, referring to the list below.

Country/Area	Code
AUSTRALIA	AU
BELGIUM	BE
CANADA	CA
CHINA	CN
CHINA HONG KONG	HK
DENMARK	DK
FINLAND	FI
FRANCE	FR
GERMANY	DE
INDONESIA	ID
ITALY	IT
JAPAN	JP
MALAYSIA	MY
NETHERLANDS	NL
NORWAY	NO
PHILIPPINES	PH
RUSSIAN FEDERATION	RU
SINGAPORE	SG
SPAIN	ES
SWEDEN	SE
SWITZERLAND	CH
TAIWAN	TW
THAILAND	TH
UNITED KINGDOM	GB
UNITED STATES	US

- a) Select the first character by pressing the ▲ / ▼ buttons.
- b) Press the ◀ / ▶ buttons to shift and select the second character by pressing the ▲ / ▼ buttons.
- c) Press the ENTER button.

- 3) Press the ▲ / ▼ buttons to select the parental lock level, then press the ENTER button.

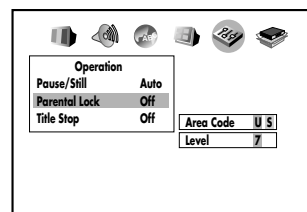

You cannot play DVD video discs rated higher than the level you selected unless you cancel the parental lock function.

For example, when you select level 7, discs rated higher than level 7 are locked out and cannot be played.

The parental lock level is equivalent to the following USA movie ratings.

- Level 7: NC-17
- Level 6: R
- Level 4: PG 13
- Level 3: PG
- Level 1: G

The parental lock levels for other countries/areas than U.S. are included for future use. Check the appropriate parental lock level when you buy a DVD video disc equipped with the parental lock feature in the future.

### ■ To change the parental lock level

Follow steps 1) - 3).

### ■ To change your 4-digit security code

- 1) After selecting "On" or "Off," press the STOP button four times, then press the ENTER button.

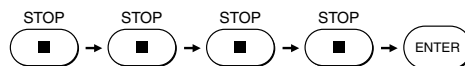

The 4-digit security code is cleared.

- 2) Press the number buttons to create a new 4-digit security code.
- 3) Press the ENTER button.

**Title Stop** DVD

- Off: The DVD video player continues after playback of a title is completed.
- On: The DVD video player stops after playback of a title is completed.

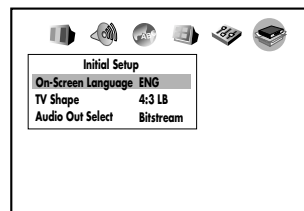
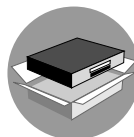
**Initial Setup** DVD CD

- 1) Press the **▲ / ▼** buttons to select "On-Screen Language," and press the **ENTER** button.

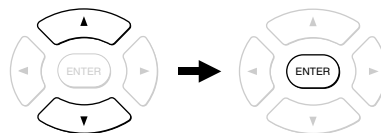

- 2) Select a language pressing the **▲ / ▼** buttons, and press the **ENTER** button.

See page **41**, "On-screen Language."

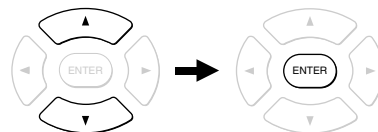

- 3) Make your selection in the same manner as step 1) then step 2).

See page **40**, "TV Shape."

See page **40**, "Audio Out Select."

# Table of Languages

## Table of languages and their abbreviations

Abbreviation	Language	Abbreviation	Language	Abbreviation	Language
---	No alternate language	GN	Guarani	PT	Portuguese
CHI (ZH)	Chinese	GU	Gujarati	QU	Quechua
DUT (NL)	Dutch	HA	Hausa	RM	Rhaeto-Romance
ENG (EN)	English	HI	Hindi	RN	Kirundi
FRE (FR)	French	HR	Croatian	RO	Rumanian
GER (DE)	German	HU	Hungarian	RU	Russian
ITA (IT)	Italian	HY	Armenian	RW	Kinyarwanda
JPN (JA)	Japanese	IA	Interlingua	SA	Sanskrit
KOR (KO)	Korean	IE	Interlingue	SD	Sindhi
MAY (MS)	Malay	IK	Inupiak	SG	Sango
SPA (ES)	Spanish	IN	Indonesian	SH	Serbo-Croatian
AA	Afar	IS	Icelandic	SI	Singhalese
AB	Abkhazian	IW	Hebrew	SK	Slovak
AF	Afrikaans	JI	Yiddish	SL	Slovenian
AM	Amharic	JW	Javanese	SM	Samoaan
AR	Arabic	KA	Georgian	SN	Shona
AS	Assamese	KK	Kazakh	SO	Somali
AY	Aymara	KL	Greenlandic	SQ	Albanian
AZ	Azerbaijani	KM	Cambodian	SR	Serbian
BA	Bashkir	KN	Kannada	SS	Siswati
BE	Belorussian	KS	Kashmiri	ST	Sesotho
BG	Bulgarian	KU	Kurdish	SU	Sundanese
BH	Bihari	KY	Kirghiz	SV	Swedish
BI	Bislama	LA	Latin	SW	Swahili
BN	Bengali, Bangla	LN	Lingala	TA	Tamil
BO	Tibetan	LO	Laotian	TE	Telugu
BR	Breton	LT	Lithuanian	TG	Tajik
CA	Catalan	LV	Latvian, Lettish	TH	Thai
CO	Corsican	MG	Malagasy	TI	Tigrinya
CS	Czech	MI	Maori	TK	Turkmen
CY	Welsh	MK	Macedonian	TL	Tagalog
DA	Danish	ML	Malayalam	TN	Setswana
DZ	Bhutani	MN	Mongolian	TO	Tongan
EL	Greek	MO	Moldavian	TR	Turkish
EO	Esperanto	MR	Marathi	TS	Tsonga
ET	Estonian	MT	Maltese	TT	Tatar
EU	Basque	MY	Burmese	TW	Twi
FA	Persian	NA	Nauru	UK	Ukrainian
FI	Finnish	NE	Nepali	UR	Urdu
FJ	Fiji	NO	Norwegian	UZ	Uzbek
FO	Faroese	OC	Occitan	VI	Vietnamese
FY	Frisian	OM	(Afan) Oromo	VO	Volapük
GA	Irish	OR	Oriya	WO	Wolof
GD	Scottish Gaelic	PA	Panjabi	XH	Xhosa
GL	Galician	PL	Polish	YO	Yoruba
		PS	Pashto, Pushto	ZU	Zulu

# Before Calling Service Personnel

Check the following guide for the possible cause of a problem before contacting service.

## Symptoms and correction

Symptom	Cause	Correction	Page
No power.	<ul style="list-style-type: none"> <li>The power plug is disconnected.</li> </ul>	<ul style="list-style-type: none"> <li>Connect the power plug securely into the wall outlet.</li> </ul>	<b>16</b>
The DVD video player turned off by itself.	<ul style="list-style-type: none"> <li>The automatic power off function turned the unit off.</li> </ul>	<ul style="list-style-type: none"> <li>Press the PLAY button.</li> </ul>	<b>21</b>
No picture.	<ul style="list-style-type: none"> <li>The TV is not set to receive DVD signal output.</li> </ul>	<ul style="list-style-type: none"> <li>Select the appropriate video input mode on the TV so the picture from the DVD video player appears on the TV screen.</li> </ul>	<b>20</b>
	<ul style="list-style-type: none"> <li>The video cable is not connected securely.</li> </ul>	<ul style="list-style-type: none"> <li>Connect the video cable securely into the appropriate jacks.</li> </ul>	<b>16, 17</b>
No sound.	<ul style="list-style-type: none"> <li>The equipment connected with the audio cable is not set to receive DVD signal output.</li> </ul>	<ul style="list-style-type: none"> <li>Select the correct input mode of the audio receiver so you can listen to the sound from the DVD video player.</li> </ul>	<b>20</b>
	<ul style="list-style-type: none"> <li>The audio cable is not connected securely.</li> </ul>	<ul style="list-style-type: none"> <li>Connect the audio cable securely into the appropriate jacks.</li> </ul>	<b>16, 17 18, 19</b>
	<ul style="list-style-type: none"> <li>The audio receiver or TV is turned off.</li> </ul>	<ul style="list-style-type: none"> <li>Turn on the equipment connected with the audio cable.</li> </ul>	<b>20</b>
	<ul style="list-style-type: none"> <li>The setting of output sound format is incorrect.</li> </ul>	<ul style="list-style-type: none"> <li>Select the proper audio setting.</li> </ul>	<b>35, 38 40</b>
The playback picture has occasional distortion.	<ul style="list-style-type: none"> <li>The disc is dirty.</li> </ul>	<ul style="list-style-type: none"> <li>Eject the disc and clean it.</li> </ul>	<b>9</b>
	<ul style="list-style-type: none"> <li>It is in fast forward or fast reverse playback.</li> </ul>	<ul style="list-style-type: none"> <li>Sometimes a small amount of picture distortion may appear. This is not a malfunction.</li> </ul>	–
Brightness is unstable or noises are present in the playback pictures.	<ul style="list-style-type: none"> <li>The effect of copy protection.</li> </ul>	<ul style="list-style-type: none"> <li>Connect the DVD video player directly to the TV. Avoid connecting the DVD video player to a VCR or TV/VCR combination.</li> </ul>	<b>16</b>
The DVD video player does not start playback.	<ul style="list-style-type: none"> <li>No disc is inserted.</li> </ul>	<ul style="list-style-type: none"> <li>Insert a disc.</li> </ul>	<b>20</b>
	<ul style="list-style-type: none"> <li>An unplayable disc is inserted.</li> </ul>	<ul style="list-style-type: none"> <li>Insert a playable disc. (Check the disc type and color system.)</li> </ul>	<b>10</b>
	<ul style="list-style-type: none"> <li>The disc is placed upside down.</li> </ul>	<ul style="list-style-type: none"> <li>Place the disc with the playback side down.</li> </ul>	<b>20</b>
	<ul style="list-style-type: none"> <li>The disc is not placed within the guide.</li> </ul>	<ul style="list-style-type: none"> <li>Place the disc correctly inside the guide on the disc tray.</li> </ul>	<b>20</b>
	<ul style="list-style-type: none"> <li>The disc is dirty.</li> </ul>	<ul style="list-style-type: none"> <li>Clean the disc.</li> </ul>	<b>9</b>
	<ul style="list-style-type: none"> <li>The parental lock function is set.</li> </ul>	<ul style="list-style-type: none"> <li>Cancel the parental lock function or change the parental lock level.</li> </ul>	<b>38, 43</b>
Playback does not follow the course of the disc's program.	<ul style="list-style-type: none"> <li>It is in the mode of repeat playback, memory playback, etc.</li> </ul>	<ul style="list-style-type: none"> <li>These operations may prevent a proper progress of the contents.</li> </ul>	–
Buttons do not work.	<ul style="list-style-type: none"> <li>Power supply fluctuations or other abnormalities such as static electricity may interrupt correct operations.</li> </ul>	<ul style="list-style-type: none"> <li>Turn the power on or off with the Power button. Or disconnect the power plug and insert it into the wall outlet again.</li> </ul>	–
The remote control does not work properly.	<ul style="list-style-type: none"> <li>The remote control is not pointed at the remote sensor of the DVD video player.</li> </ul>	<ul style="list-style-type: none"> <li>Point the remote control at the remote sensor of the DVD video player.</li> </ul>	<b>15</b>
	<ul style="list-style-type: none"> <li>The remote control is too far from the DVD video player.</li> </ul>	<ul style="list-style-type: none"> <li>Operate the remote control within about 7 m.</li> </ul>	<b>15</b>
	<ul style="list-style-type: none"> <li>The batteries in the remote control are exhausted.</li> </ul>	<ul style="list-style-type: none"> <li>Replace the batteries with new ones.</li> </ul>	<b>15</b>

# Specifications

## DVD video player / outputs / supplied accessories

### DVD Video Player

Power supply	120 V AC, 60 Hz
Power consumption	14 W
Mass	2.3 kg
External dimensions	430 × 81 × 225 mm (W/H/D)
Signal system	Standard NTSC
Laser	Semiconductor laser, wavelength 650 nm
Frequency range	DVD linear sound : 48 kHz sampling 4 Hz to 22 kHz 96 kHz sampling 4 Hz to 44 kHz
Signal-to-noise ratio	More than 112 dB
Audio dynamic range	More than 108 dB
Harmonic distortion	Less than 0.002 %
Wow and flutter	Below measurable level (less than ±0.001 % (W.PEAK))
Operating conditions	Temperature: 5 °C to 35 °C, Operation status: Horizontal

### Outputs

Video output	1.0 V (p-p), 75 Ω, negative sync., pin jack × 1
S video output	(Y) 1.0 V (p-p), 75 Ω, negative sync., Mini DIN 4-pin × 1 (C) 0.286 V (p-p), 75 Ω
Component video output	(Y) 1.0 V (p-p), 75 Ω, negative sync., pin jack × 1 (P <sub>B</sub> )/(P <sub>R</sub> ) 0.7 V (p-p), 75 Ω, pin jack × 2
Audio output (BITSTREAM/PCM)	0.5V (p-p), 75 Ω, pin jack × 1
Audio output (ANALOG)	2.0 V (rms), 220 Ω, pin jacks (L, R) × 1

### Supplied Accessories

Audio/video cable .....	1
Remote control (SE-R0049 (SD-400V), SE-R0047 (SD-K600)) .....	1
Batteries (AA) .....	2
Power cord .....	1

- Designs and specifications are subject to change without notice.



## LIMITED WARRANTY DVD VIDEO PLAYER

Toshiba America Consumer Products, Inc. ("TACP"), Toshiba Hawaii ("THI") and Toshiba Canada Limited ("TCL") make the following limited warranties. These limited warranties extend to original purchaser or any person receiving this set as a gift from the original purchaser and to no other purchaser or transferee.

### Limited Ninety (90) Day Warranty

TACP/THI warrant this product against defects in materials or workmanship for a period of ninety (90) days after the date of original retail purchase. During this period, TACP/THI will repair or replace a defective product or part, at their option, with a new or refurbished product or part without charge to you. You must deliver the entire product to a TACP/THI Authorized Service Station. You are responsible for all transportation and insurance charges for the unit to and from the Authorized Service Station. If you live in the U.S.A. you may, at your option, return your DVD Unit to:

Toshiba America Consumer Products Inc.  
Returns Center  
1420C Toshiba Dr.  
Lebanon, TN 37087

Upon receipt we will, at our option, exchange the DVD Unit with a new or refurbished unit. **Canadian consumers are requested to contact TCL. In Hawaii consumers are requested to contact THI.**

### Limited One (1) Year Warranty

TACP/THI further warrant the parts in this product against defects in materials or workmanship for a period of one (1) year after the date of original retail purchase. During this period, TACP/THI will repair or replace a defective product or part, at their option, with a new or refurbished product or part without charge to you, except that if a defective part is replaced after ninety (90) days from the date of the original retail purchase you pay labor charges involved in the replacement. You must also deliver the entire product to a TACP/THI Authorized Service Station. You are responsible for all transportation and insurance charges for the unit to and from the Authorized Service Station. If you live in the U.S.A. you may, at your option, return your DVD Unit to:

Toshiba America Consumer Products Inc.  
Returns Center  
1420C Toshiba Dr.  
Lebanon, TN 37087

Upon receipt we will, at our option, exchange the DVD Unit with a new or refurbished unit. **Canadian Consumers are requested to contact TCL. In Hawaii consumers are requested to contact THI.**

### Rental Units

The warranty for rental units begin with the first rental or thirty (30) days from the date of shipment to the rental firm, whichever comes first.

### Commercial Units

Products sold and used for commercial use have a limited ninety (90) day warranty for all parts and labor.

### Owner's Manual

You should read the owner's manual thoroughly before operating this product. You should complete and mail the enclosed Demographic card within ten (10) days after you, or the person who has given you this product as a gift, purchased this product. This is one way to enable TACP to provide you with better customer service and improved products. Failure to return the card will not affect your rights under this warranty.

### Your Responsibility

The above warranties are subject to the following conditions:

- (1) You must retain your bill of sale or provide other proof of purchase.
- (2) You must notify a TACP/THI/TCL /Authorized Service Station within thirty (30) days after you discover a defective product or part.
- (3) All warranty servicing of this product must be made by a TACP/THI/TCL Authorized Service Station.
- (4) U.S.A. warranties are effective only if the product is purchased and operated in the Continental U.S.A. or Puerto Rico.
- (5) Labor service charges for set installation. Set up, adjustment of customer controls and installation or repair of antenna systems are not covered by this warranty. Reception problems caused by inadequate antenna systems are your responsibility.
- (6) Warranties extend only to defects in materials or workmanship as limited above and do not extend to any product or parts which have been lost or discarded by you or to damage to products or parts caused by misuse, accident, damage caused by Acts of God, such as lighting or fluctuations in electric power, improper installation, improper maintenance or use in violation of instructions furnished by us; or to units which have been altered or modified without authorization of TACP/THI/TCL or to damage to products or part thereof which have had the serial number removed, altered, defaced or rendered illegible.
- (7) Should you elect to return your DVD Unit to TACP after the ninety (90) days and within one (1) year, or after the warranty period has expired: Call (800)-631-3811 to receive information concerning an exchange price. Payment must be enclosed with product in the form of a certified check or money order including reason for return.
- (8) Physically damaged DVD Units are not acceptable for repair or exchange whether in or out of warranty and will be returned as received.

(Continued)

## LIMITED WARRANTY DVD VIDEO PLAYER (continued)

### How to Obtain Warranty Service

- (1) Refer to the troubleshooting guide in your owner's manual. This check list may solve your problem.
- (2) In the U.S.A., only call the TACP toll free number 800-631-3811, or if in Hawaii or Canada see listing below within (30) days after you find a defective product or part.
- (3) Arrange for the delivery of the product to the TACP/THI/TCL Authorized Service Station or TACP Return Center. Products shipped to the Service Station must be insured and safely and securely packed, preferably in the original shipping carton, and a letter explaining the defect and also a copy of the bill of sale or other proof of purchase must be enclosed.

#### In the Continental United States contact:



#### In Hawaii contact:

Toshiba Hawaii Inc.  
327 Kamakee Street  
Honolulu, HA 96814  
(808)-521-5377

#### In Canada contact:

Consumer Electronics Group  
191 McNabb Street  
Markham, Ontario L3R 8H2  
(905)-470-5400

Consumer Electronics Group  
22171 Fraserwood Way  
Richmond, B.C. V6W 1J5  
(604)-303-2500

Consumer Electronics Group  
1643 North Service Road  
Droval, QC H9P 1J1  
(514)-856-4100

All warranties implied by state law, including the implied warranties of merchantability and fitness for a particular purpose, are expressly limited to the duration of the limited warranties set forth above. With the exception of any warranties implied by state law as hereby limited, the foregoing warranty is exclusive and in lieu of all other warranties, guarantees, agreements and similar obligations of manufacturer or seller with respect to the repair or replacement of any parts. In no event shall TACP/THI be liable for consequential or incidental damages.

No person, agent, distributor, dealer or company is authorized to change, modify or extend the terms of these warranties in any manner whatsoever. The time within which an action must be commenced to enforce any obligation of TACP/THI arising under the warranty or under any statute, or law of the United States or any state thereof, is hereby limited to ninety (90) days from the date you discover or should have discovered, the defect. This limitation does not apply to implied warranties arising under state law.

This warranty gives you specific legal rights and you may also have other rights which may vary from state to state. Some states do not allow limitation on how long an implied warranty lasts, when an action may be brought, or the exclusion or limitation of incidental or consequential damages, so the above provisions may not apply to you.

#### ATTENTION CANADIAN CONSUMERS:

Canadian consumers are requested to complete the special Canadian "Warranty Registration Form" enclosed, and forward this completed form with a copy of bill of sale to TOSHIBA OF CANADA to "Register and Validate" their warranty. Product must be purchased from an Authorized Canadian Dealer. Products purchased in the U.S.A. and used in Canada are not covered by these warranties.

#### IMPORTANT: PACKING AND SHIPPING INSTRUCTION

When you send the product to a Service Station, you must use the original carton box and packing material, then insert the original carton box containing the unit into another carton using more packing material.

**TOSHIBA**

Printed in China

## Free Manuals Download Website

<http://myh66.com>

<http://usermanuals.us>

<http://www.somanuals.com>

<http://www.4manuals.cc>

<http://www.manual-lib.com>

<http://www.404manual.com>

<http://www.luxmanual.com>

<http://aubethermostatmanual.com>

Golf course search by state

<http://golfingnear.com>

Email search by domain

<http://emailbydomain.com>

Auto manuals search

<http://auto.somanuals.com>

TV manuals search

<http://tv.somanuals.com>