

# TOSHIBA



## DVD VIDEO RECORDER **D-R160SB**

### OWNER'S MANUAL



**OPERATIONS  
GUIDE**

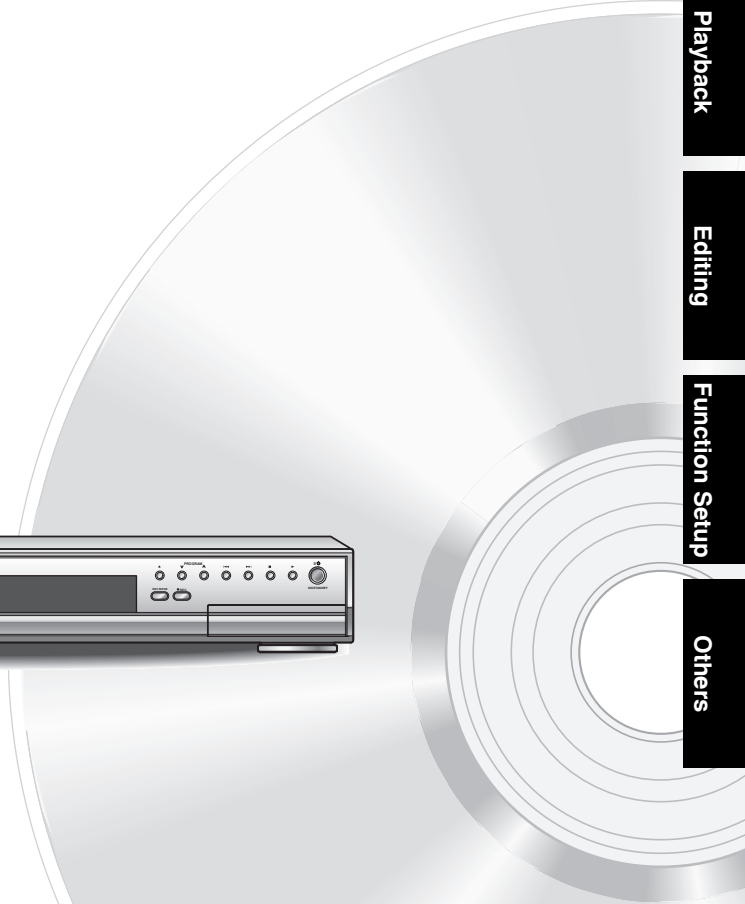



Introduction  
Connections  
Basic Setup  
Recording  
Playback  
Editing  
Function Setup  
Others



# TOSHIBA

# Precautions

**WARNING:** TO REDUCE THE RISK OF FIRE OR ELECTRIC SHOCK, DO NOT EXPOSE THIS APPLIANCE TO RAIN OR MOISTURE.

	<b>CAUTION</b> <b>RISK OF ELECTRIC SHOCK</b> <b>DO NOT OPEN</b>	
<p><b>CAUTION:</b> TO REDUCE THE RISK OF ELECTRIC SHOCK, DO NOT REMOVE COVER (OR BACK). NO USER SERVICEABLE PARTS INSIDE. REFER SERVICING TO QUALIFIED SERVICE PERSONNEL.</p>		

The important note is located on the rear of the cabinet.

	<p>The lightning flash with arrowhead symbol, within an equilateral triangle, is intended to alert the user to the presence of uninsulated "dangerous voltage" within the product's enclosure that may be of sufficient magnitude to constitute a risk of electric shock to persons.</p>
	<p>The exclamation point within an equilateral triangle is intended to alert the user to the presence of important operating and maintenance (servicing) instructions in the literature accompanying the appliance.</p>

## Laser Safety

This unit employs a laser. Only a qualified service personnel should remove the cover or attempt to service this unit, due to the possibility of eye injury.

**CAUTION:** USE OF CONTROLS OR ADJUSTMENTS OR PERFORMANCE OF PROCEDURES OTHER THAN THOSE SPECIFIED HEREIN MAY RESULT IN HAZARDOUS RADIATION EXPOSURE.

**CAUTION:** VISIBLE AND INVISIBLE LASER RADIATION WHEN OPEN AND INTERLOCK DEFEATED. DO NOT STARE INTO BEAM.

**LOCATION:** INSIDE, NEAR THE DECK MECHANISM.

## Power Supply

The power supply is connected and the unit is live when the mains cable is plugged into a 220-240 V~, 50 Hz AC outlet. To operate the unit, press [I/⊙ ON/STANDBY].

**WARNING:** LIVE PARTS INSIDE. DO NOT REMOVE ANY SCREWS.

## Caution

1. Do not attempt to open the cabinet. There are no parts inside you can service. Refer all servicing to qualified service personnel.
2. Slots and openings in the cabinet at the sides and underneath are provided for ventilation. To ensure reliable operation and to protect the unit from overheating, these openings must not be blocked or covered.  
Avoid installation in enclosed spaces such as bookcases unless suitable ventilation is provided.
3. Keep the unit away from radiators and other heat sources.
4. Avoid use near strong magnetic fields.
5. Do not push objects of any kind into the unit through the cabinet slots or openings as they could touch electrically live parts or short circuit parts resulting in a fire or electric shock.
6. Do not spill liquid on the unit. If liquid is spilled and enters the unit, consult qualified service personnel.
7. Do not stand the unit vertically. Use the unit in a horizontal (flat) position only.
8. Before attempting to operate the unit, make sure that the timer recording mode is off.
9. This product is in Stand-by mode when turned off while the mains cable is connected.
10. Do not place any combustible objects on the device (candles, etc.).
11. Before moving the unit, be sure to remove any discs and unplug the mains cable from the AC outlet.
12. Disconnect the mains plug to shut off when find troubles or not in use.
13. The mains plug shall remain readily operable.
14. Read both manual instructions to ensure correct and safe installation and interconnection of the unit in multimedia systems.
15. Keep the distances 20 cm around apparatus of ventilation openings.

## Declaration of Conformity

This product complies with the requirement of the directives

EMC-Directive: 89 / 336 / EEC

Low Voltage Directive: 73 / 23 / EEC

CE Marking: 93 / 68 / EEC

We declare that the following product:

DVD VIDEO RECORDER, Model D-R160SB  
is in compliance with following Regulations.

EN55013: 2001+A1:2003, EN55020: 2002+A1:2003,

EN61000-3-2: 2000, EN61000-3-3: 1995 + A1: 2001

EN60065: 2002

EN60825-1 Edition 1.2: 2001



### A NOTE ABOUT RECYCLING

This product's packaging materials are recyclable and can be reused. Please dispose of any materials in accordance with your local recycling regulations.

This product consists of materials which can be recycled and reused if disassembled by a specialised company.

Batteries should never be thrown away or incinerated but disposed of in accordance with your local regulations concerning chemical wastes.



### Make your contribution to the environment!!!

- Exhausted batteries do not belong in the dustbin.
- You can dispose of them at a collection point for exhausted batteries or special waste.
- Contact your council for details.



### For Customer Use:

Carefully read the Model No. and Serial No. located at the back of the unit and enter the information below. Retain this information for future reference.

Model No. \_\_\_\_\_

Serial No. \_\_\_\_\_

## Connection to Power

Before Switching on make sure that the voltage of your electricity supply is the same as that indicated on the rating plate.

### Mains Cord

This appliance may be fitted with a non-rewireable plug. If it is necessary to change the fuse in a nonrewireable plug the fuse cover must be refitted. If the fuse cover is lost or damaged, the plug must not be used until a replacement available from the appliance manufacturer is obtained.

It is important that the colour of the replacement fuse cover corresponds with the rating marking on the base of the plug.

If the plug has to be changed because it is not suitable for your socket, or becomes damaged, it should be cut off and an appropriate plug fitted following the wiring instructions below. The plug removed must be disposed of safely as insertion into a 13A socket is likely to cause an electrical hazard.

For your own safety read the following instructions carefully before attempting to connect this unit to mains. The wires in this mains lead are coloured in accordance with the following code:

BLUE=NEUTRAL, BROWN=LIVE

### Important

As the colours of the wires in the mains lead of this appliance may not correspond with the coloured markings identifying the terminals in your plug, proceed as follows:-

The wire which is coloured blue must be connected to the terminal which is marked with the letter N or coloured black.

The wire which is coloured brown must be connected to the terminal which is marked with the letter L or coloured red.

No connection is to be made to the earth terminal of the plug.

If a 13 Amp (BS 1363) Plug is used, a 3 Amp Fuse must be fitted, or if any other type of Plug is used a 3 or 5 Amp Fuse must be fitted, either in the Plug or Adaptor, or on the Distribution Board.

Mains Supply:220 - 240V~ 50 Hz - AC only

Do not make any connection to the larger pin marked with the letter "E" or by the symbol  $\perp$  or coloured green or green and yellow.

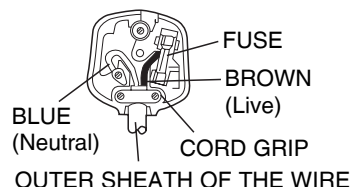

## Installation Location

### For safety and optimum performance of this unit:

- Install the unit in a horizontal and stable position.
- Do not place anything directly on top of the unit.
- Do not place the unit directly on top of the TV.
- Shield the unit from direct sunlight and keep away from sources of intense heat. Avoid dusty or humid locations. Avoid locations with insufficient ventilation for suitable heat dissipation. Do not block the ventilation holes on the sides of the unit. Avoid locations subject to strong vibration or strong magnetic fields.

## Avoid the Hazards of Electrical Shock and Fire

- Do not handle the power cord with wet hands.
- Do not pull on the mains cable to disconnect it from AC outlet. Grasp it by the plug.
- If water is spilled on the unit accidentally, unplug the mains cable immediately and take the unit to an authorized service centre for servicing.

## Moisture Condensation Warning

Moisture condensation may occur inside the unit when it is moved from a cold place to a warm place, after heating a cold room, or under conditions of high humidity. Do not use the unit for at least 2 hours to allow the inside to dry.

## About Copyright

Unauthorized copying, broadcasting, public performance and lending of discs are prohibited. This product incorporates copyright protection technology that is protected by U.S. patents and other intellectual property rights. Use of this copyright protection technology must be authorized by Macrovision, and is intended for home and other limited viewing uses only unless otherwise authorized by Macrovision. Reverse engineering or disassembly is prohibited.

## Notice for the Progressive Scan Outputs

Consumers should note that not all high definition television sets are fully compatible with this product and may cause artifacts to be displayed in the picture. In case of picture problems with 525 or 625 progressive scan output, it is recommended that the user switch the connection to the 'standard definition' output. If there are questions regarding your TV set compatibility with this 525p or 625p DVD recorder, please contact our customer service centre.

## Accessories Supplied

- Remote control with two R6 (AA) batteries

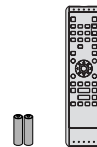

- RF cable



- Owner's Manual

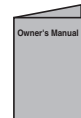

- Quick Guide



- Registration card



## Maintenance

### ■ CLEANING THE UNIT

- Use a soft cloth slightly moistened with a mild detergent solution. Do not use a solution containing alcohol, spirits, ammonia or abrasive.

### ■ CLEANING DISCS

- If a disc becomes dirty, clean it with a cleaning cloth. Wipe the disc from the centre out. Do not wipe in a circular motion.
- Do not use solvents such as benzene, thinners, commercially available cleaners, detergent, abrasive cleaning agents or antistatic spray intended for analogue records.

### ■ DISC HANDLING

- Handle the disc by its edge so that fingerprints and dust do not adhere to the disc surfaces.
- Always store the disc in its protective case when it is not used.

### ■ SERVICING

- If the unit becomes inoperative, do not try to correct the problem by yourself. There are no user serviceable parts inside. Turn the unit off, unplug the mains cable, and consult your dealer or an authorized service centre.

### ■ CLEANING THE DISC LENS

- If the unit does not perform correctly even though you have referred to "Troubleshooting" and the relevant sections in the Owner's Manual, the laser optical pickup unit may be dirty. Consult your dealer or an authorized service centre for inspection and cleaning of the laser optical pickup unit.

Manufactured under license from Dolby Laboratories. "Dolby" and the double-D symbol are trademarks of Dolby Laboratories.

#### Dolby Digital Recording

"Dolby® Digital Recording enables consumers to record high-quality video with stereo sound on recordable DVD discs. The technology, when utilized instead of PCM recording, also saves recordable disc space, allowing for higher video resolution or extended recording time on each DVD. DVDs created using Dolby Digital Recording will play back on all DVD-Video players."

#### Note:

This is true when the players are compatible with actual recordable DVD discs.

"DTS" and "DTS Digital Out" are trademarks of Digital Theater Systems, Inc.

# Table of contents

## Introduction

■ Precautions . . . . .	2
■ Table of contents . . . . .	6
■ Features . . . . .	8
■ Choosing a disc . . . . .	9
■ Index to parts and controls . . . . .	14
■ Preparation of the remote control . . . . .	19
■ On Screen menu . . . . .	20

## Connections

■ Connections . . . . .	24
Using the S-VIDEO OUT or the COMPONENT VIDEO OUTPUT jacks and the ANALOG AUDIO OUT jacks . . . . .	25
Connecting to external equipment . . . . .	25
Digital audio for better sound quality . . . . .	26
After you have completed connections . . . . .	26

## Basic Setup

■ Initial setting . . . . .	28
■ Channel setting . . . . .	29
Auto tuning . . . . .	29
Manual tuning . . . . .	29
To select a channel . . . . .	30
To skip a Preset channel . . . . .	30
Move . . . . .	30
■ Setting the clock . . . . .	31
Auto Clock Setting . . . . .	31
Manual Clock Setting . . . . .	31
■ Selecting the TV aspect ratio . . . . .	33

## Recording

■ Information on DVD recording . . . . .	36
Information . . . . .	36
Recording Mode . . . . .	36
Restrictions on recording . . . . .	37
Information on copy control . . . . .	37
Making discs playable in other DVD player (Finalise) . . . . .	37
■ Selecting the Recording format . . . . .	38
Choosing the recording format of a blank disc . . . . .	38
Reformatting a disc . . . . .	40
Setting Auto Chapter . . . . .	40
Selecting the Sound mode . . . . .	41
Recording Audio Select (XP) . . . . .	41
Setting External Input Audio . . . . .	42
Setting Bilingual Recording Audio . . . . .	42
■ Basic recording . . . . .	43
■ One-touch Timer Recording . . . . .	45
■ Timer Recording . . . . .	47
Checking, cancelling, or correcting the timer programming information . . . . .	51
If the timer programming did not complete correctly . . . . .	51
PDC (Programme Delivery Control) . . . . .	52
Hints for Timer Recording . . . . .	52
Satellite Link . . . . .	53
■ Settings for an external equipment . . . . .	55
Connection to an external equipment . . . . .	55
Recording from an external equipment . . . . .	56
■ Setting disc protection . . . . .	58
■ Finalising discs . . . . .	59
Auto finalise . . . . .	61

## Playback

■ <b>Basic playback</b> . . . . .	<b>64</b>
Playing back a DVD-RW / DVD-R . . . . .	64
Playing back a DVD-VIDEO / Video CD / CD . . . . .	67
Playing back an MP3 / JPEG disc . . . . .	68
Playing back discs using the Disc menu . . . . .	70
Playing back discs using the Title menu . . . . .	70
PBC function for Video CDs . . . . .	70
Playing back a Video CD using the menu . . . . .	71
Cancelling and Recalling the PBC function . . . . .	71
Pause . . . . .	71
Step by step playback . . . . .	71
■ <b>Further playback</b> . . . . .	<b>72</b>
Resume Playback . . . . .	72
Rapid Playback . . . . .	72
Skipping TV commercials during playback . . . . .	72
Fast forward / Fast reverse . . . . .	73
Slow forward / Slow reverse . . . . .	73
■ <b>Special playback</b> . . . . .	<b>74</b>
Zoom . . . . .	74
Marker Setup . . . . .	74
Chasing Playback during Recording . . . . .	75
Simultaneous Playback and Recording . . . . .	75
Searching by Title, Chapter or Track . . . . .	76
Searching by Time . . . . .	77
Repeat Playback . . . . .	77
Random Playback . . . . .	78
Program Playback . . . . .	78
Slide Show . . . . .	79
■ <b>Selecting the format of audio and video</b> . . . . .	<b>80</b>
Switching subtitles . . . . .	80
Switching audio soundtrack . . . . .	80
Switching virtual surround system . . . . .	81
Switching camera angles . . . . .	82
Reducing block noise . . . . .	82

## Editing

■ <b>Information on disc editing</b> . . . . .	<b>84</b>
Guide to a title list . . . . .	84
Edit the recorded disc . . . . .	84
Editing discs . . . . .	85
Notes for deleting titles . . . . .	85
■ <b>Editing discs</b> . . . . .	<b>86</b>
Deleting titles . . . . .	86
Editing title names . . . . .	88
Guide to edit title name . . . . .	90
Adding or deleting chapter marks . . . . .	91
Setting pictures as thumbnails . . . . .	93
Deleting parts of titles . . . . .	95
Dividing a title . . . . .	97
Combining titles . . . . .	98
Adding titles to a Playlist . . . . .	100
Erasing all Playlist . . . . .	102
Setting or releasing the title protection . . . . .	104
Setting or clearing all the chapter marks in one title . . . . .	106

## Function Setup

■ <b>Tour of the Setup menu</b> . . . . .	<b>110</b>
■ <b>Function Setup</b> . . . . .	<b>112</b>
Language setting . . . . .	112
Display setting . . . . .	113
Audio setting . . . . .	114
Parental setting . . . . .	116
Still Mode setting . . . . .	118
TV System setting . . . . .	118
Video Out setting . . . . .	119

## Others

■ <b>Troubleshooting</b> . . . . .	<b>122</b>
■ <b>Language code</b> . . . . .	<b>127</b>
■ <b>Glossary</b> . . . . .	<b>128</b>
■ <b>Specifications</b> . . . . .	<b>130</b>

# Features

Along with playing back CDs and recording, editing, and playing back DVDs, this unit offers you the following features.

## Recording

The unit is compatible with DVD-RW discs which are recordable repeatedly, and DVD-R discs which are recordable only once.

### ■ Recording up to 8 programmes:

You can programme the unit to record up to 8 programmes, up to a month in advance. Daily or weekly programme recordings are also possible.

### ■ One-touch Timer Recording:

You can set your required recording time easily. Every time [REC ●] is pressed during recording, the recording time will be increased by 30 minutes up to 8 hours. The recording automatically stops when the recording time you set is finished.

### ■ Automatic Chapter marker setting:

Chapter markers will be added to recordings as you set them in the Setup menu before starting to record.

### ■ Automatic Title menu making:

The unit creates Title menus automatically when finalising discs.

### ■ Automatic Playlist making (VR mode):

The unit creates a Playlist automatically after recording.

### ■ Automatic finalising (Video mode):

You can finalise discs automatically at the end of the disc space if you set this in the Setup menu.

### ■ Left channel stereo recording:

The unit can record monaural sound from the Left channel as pseudo stereo sound (same Left and Right channels) automatically. (This function is not available for input source of AV3 jacks on the rear panel.)

## Playback

### ■ Theatre surround sound:

When the unit is connected to an amplifier or a decoder compatible with Dolby Digital or DTS, you can enjoy theatre-quality surround sound from discs recorded with the surround sound system.

### ■ Chasing Playback during Recording and Simultaneous Playback and Recording:

You can play the already recorded part of the current recording or another title during recording.

### ■ Quick search:

You can easily find the part you want to watch using the search function. Search for a desired point on a disc by title, chapter or time.

### ■ Playback from Original or Playlist (VR mode):

You can play back titles using either the Original list or a Playlist.

### ■ Virtual Surround System:

You can enjoy stereophonic space through your exciting 2 channel stereo system.

### ■ Playing back an MP3 disc:

You can enjoy MP3 files which are recorded on CD-R/RW.

### ■ JPEG Picture Viewer:

JPEG files formatted on CD-R/RW can be played.

## Editing

### ■ Set / clear chapter markers (VR mode):

You can easily add chapter markers anywhere in your recordings for easy editing.

### ■ Making your own Playlist (VR mode):

While the Original list remains unchanged, you can edit titles as you prefer and create your own Playlist.

Edit title names

Set thumbnail pictures

Set / clear chapter markers

Divide / combine titles

Delete parts of titles

### ■ Protecting titles (VR mode):

To avoid accidental editing or erasing of titles, the protect function is useful when set to "ON" in the Original list.

## Compatibility

### ■ Playing back discs recorded in Video mode on any regular DVD player:

Discs recorded in Video mode can be played back on regular DVD players, including computer DVD drives compatible with DVD-Video playback. You will need to finalise the discs recorded in Video mode to play back in other DVD players.

\* DVD-Video Format (Video mode) is a new format for recording on DVD-R/RW discs that was approved by the DVD Forum in 2000. Adoption of this format is optional for manufactures of DVD playback devices and there are DVD-Video players, DVD-ROM drives and other DVD playback devices available that cannot play back DVD-R/RW discs recorded in the DVD-Video Format.

### ■ PDC:

This system assures that the TV programme you wish to record using timer recording will be recorded exactly from beginning to end even if the actual broadcasting time differs.



# Choosing a disc

When you want to play DVD or CD software, load an appropriate disc into the recorder. There are many types and formats of discs. Please use the following information to select an appropriate disc.

## Notes

- Handle the disc according to the disc instruction manual.
- Toshiba cannot guarantee that all discs bearing the DVD or CD logos will operate as expected. Additionally, Toshiba cannot guarantee that discs recorded in this device will operate properly in other DVD players, recorders and/or personal computer drives.

## DVD disc types

★★★ : Most suitable   ★★ : Can be used   ★ : Some functions are limited   — : Cannot be used

You want to	DVD-RW VR	DVD-RW Video	DVD-R
Record TV programmes	★★★	★★★	★★★
Reuse by deleting unwanted contents	★★★	★★	—
Edit recorded contents	★★★	★	★
Edit/Record from connected equipment	★★★	★★★	★★★
Copy discs for distribution	★★ <sup>*1</sup>	★★★	★★★
Play on other DVD equipment	★★ <sup>*1</sup>	★★★	★★★



Features	DVD-RW VR	DVD-RW Video	DVD-R
<b>Recording</b>			
Rewritable	Yes	Yes	No
Can create chapters at fixed intervals (auto.)	Yes	Yes	Yes
Can create chapters wherever you like (manual)	Yes	No	No
Can record 16:9 size pictures	Yes	Yes	Yes
Can record Copy-Once programmes	Yes	No	No
<b>Editing</b>			
Can perform basic edit functions	Yes	Yes	Yes
Can perform advanced edit functions (Playlist edit)	Yes	No	No

\*1 DVD-RW (VR mode) can only be played on DVD equipment that is VR compatible.

### Note:

For details of the above functions and implied restrictions, see the explanations inside the manual.

## For recording /playback

Disc	Mark	Specification	Remarks
DVD-R		• 4.7GB for General Ver.2.0 (8cm (3¼ in.)) (12cm (4¾ in.))	Read carefully the section “On DVD-R discs” (page 11). Depending on the disc status or the recording equipment, playback of the disc may not be possible on this recorder.
DVD-RW		• 4.7GB for Ver. 1.1 and 1.2 (8cm (3¼ in.)) (12cm (4¾ in.))	Read carefully the section “On DVD-RW discs” (page 11). Depending on the disc status or the recording equipment, playback of the disc may not be possible on this recorder.

## Using different disc types for different purposes









### DVD-R/RW discs when creating your own original discs for distribution

DVD-R discs are designed to comply with the global standard DVD-Video format, and can be recorded only once. DVD-R discs are convenient when you edit your original content (recorded personal events such as a wedding party) with this recorder, transfer them to the recorder and make copies to send to your friends or relatives. The discs can be played on other compatible DVD players. DVD-RW discs, which are rewritable, can be used as well.

We cannot guarantee that DVD-R/RW discs recorded on this recorder will be playable on all DVD recorders/players. Similarly, there is no guarantee that all DVD-R/RW discs recorded on other recorders will be playable on this recorder.

## Choosing a disc (cont'd)

## For playback only

Disc	Mark	Specification	Remarks
DVD video	 	<ul style="list-style-type: none"> <li>• 12cm (4<sup>3</sup>/<sub>4</sub> in.) / 8cm (3<sup>1</sup>/<sub>4</sub> in.)</li> <li>• Region number</li> </ul>	<p>The region number of this DVD recorder is 2. The region number marked on the rear panel must correspond to a specific playable area, that is printed on your DVD video disc. If you do not find Region 2 or ALL regions, or the disc is encoded to permit playback only in regions other than Region 2, disc playback will not be allowed by the recorder.</p>
		 or 	
Audio CD (CD-DA)		<ul style="list-style-type: none"> <li>• 12cm (4<sup>3</sup>/<sub>4</sub> in.) / 8cm (3<sup>1</sup>/<sub>4</sub> in.)</li> </ul>	
CD-R		<ul style="list-style-type: none"> <li>• 12cm (4<sup>3</sup>/<sub>4</sub> in.)</li> </ul>	<p>Depending on the disc status, playback may not be possible.</p>
CD-RW		<ul style="list-style-type: none"> <li>• CD-DA (audio CD) format, MP3, JPEG files</li> </ul>	
VCD (VIDEO CD)	 	<ul style="list-style-type: none"> <li>• 12cm (4<sup>3</sup>/<sub>4</sub> in.)</li> <li>• Version 1.1 and 2.0</li> </ul>	

**DVD** is a trademark of DVD Format/Logo Licensing Corporation.

- You cannot play discs other than those listed above.
- You cannot play non-standardized discs even if they may be labelled as above.
- You cannot play discs with specialized encoding (such as SACD discs) or the DVD audio portions of DVD Audio discs.

- This recorder uses the PAL colour system, and cannot play DVD video discs recorded in any other colour system (NTSC, etc.), even if they have region marks Region 2 or ALL regions.
- Toshiba cannot guarantee that all discs bearing the DVD or CD logos will operate as expected. Please see the discussion of compatibility on page 11.

**RW COMPATIBLE** This label indicates playback compatibility with DVD-RW discs recorded in VR mode (Video Recording Format).

**NOTE**

- This player cannot play the DVD-R discs recorded in VR mode (Video Recording Format).

- Toshiba is not liable for any damage or loss caused directly or indirectly by the malfunction of this recorder, including, without limitation, any one of the following:
  - Failure to record contents intended to be recorded by the consumer.
  - Failure to edit contents as intended by the consumer.
  - When a DVD-R/RW disc created on this recorder is used (e.g., insertion, playback, recording or editing) in another DVD player, recorder or personal computer drive.
  - When a DVD-R/RW disc that is used in the manner described in the immediately preceding bullet point is used again in this recorder.
  - When a DVD-R/RW disc that was recorded in another DVD recorder, or in a personal computer drive is used in this recorder.
- Some functions may not work with personal computer discs.
- Discs recorded in this recorder may not operate as expected on other DVD players, recorders or personal computer drives.

Because of problems and errors that can occur during the creation of DVD and CD software and/or the manufacture of DVD and CD discs, Toshiba cannot guarantee that product will play every feature of every DVD bearing the DVD logo and/or every CD bearing the CD logo. As one of the creators of DVD technology, Toshiba DVD players are manufactured using the highest standards of quality, and as a result, such incompatibilities are rare.

## On DVD-R discs

### ■ Standards

- DVD-R for General Ver.2.0 discs can be used for recording and playback.
- Discs compatible with the following recording mode speed can also be used:  
Ver. 2.0/2x  
Ver. 2.0/4x  
Ver. 2.0/8x
- Select discs labelled "for video", "for recording", "120 min." etc.

### ■ Recording conditions

- Images for which copying is prohibited or restricted (copy once or copy prohibited) cannot be recorded.
- We strongly recommend using any DVD-R 2x, and MAXELL DVD-R 16x to assure good recording quality.

### ■ Discs that have been tested and are proven to be compatible with this recorder:

Verbatim DVD-R 8x

## On DVD-RW discs

### ■ Standards

- Discs labelled DVD-RW Ver.1.1 or 1.2 can be used.
- Discs compatible with the following recording mode speeds can also be used:  
Ver. 1.1/2x  
Ver. 1.2/4x
- Select discs labelled "for video", "for recording", "120 min." etc.

### ■ Recording conditions





- Images for which copying is prohibited (copy prohibited) cannot be recorded. If the disc is labelled as CPRM compatible, images for which copying is restricted (copy once) can be recorded in VR mode.
- We strongly recommend using any DVD-RW 4x disc to assure good recording quality.

### ■ Discs that have been tested and are proven to be compatible with this recorder:

Verbatim DVD-RW 2x

## Marks on DVD video discs

The following are examples of marks and the meanings.

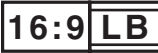
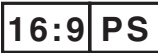
Mark	Meanings
	Number of audio streams recorded in the disc. (2 streams such as English and Japanese in this example.)
	Number of subtitle languages recorded in the disc. (2 subtitle languages are recorded in this example.)
	Number of camera angles recorded in the disc. (3 camera angles are recorded in this example.)
	Pictures are recorded in the standard picture shape (4:3 aspect ratio).
	Pictures are recorded in the letter box picture shape (4:3 aspect ratio with horizontal black bars in the top and bottom of pictures).
	Pictures are recorded in the 16:9 wide picture shape. TVs with 4:3 aspect ratio will display them in the letter box style.
	Pictures are recorded in the 16:9 wide picture shape. TVs with 4:3 aspect ratio will display them in the pan scan style (one or both sides of pictures are cut).
	Actual picture shape may vary depending on the aspect ratio or mode selection of the TV.

## Choosing a disc (cont'd)

## Structure of disc contents

Normally, DVD video discs are divided into titles, and the titles are subdivided into chapters.

Video CDs/Audio CDs are divided into tracks.

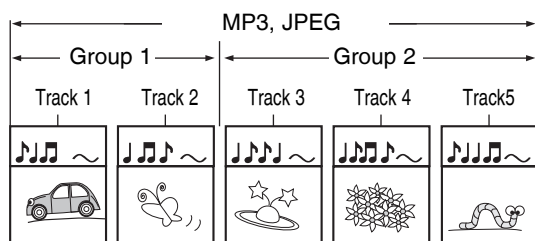
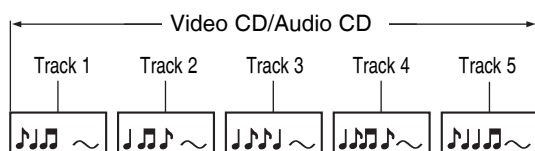
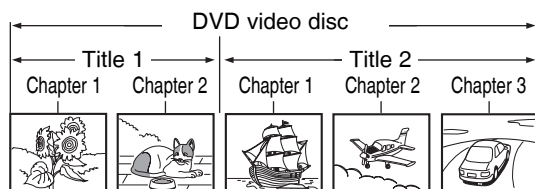

- Title:** Divided contents of a DVD video disc. Roughly corresponds to a story title in short stories.
- Chapter:** Divided contents of a title. This corresponds to a chapter in a story.
- Track:** Divided contents of a Video CD or an Audio CD.
- Group:** Divided contents of a MP3 or JPEG data disc. Consists of number of tracks.

Each title, chapter, or track is assigned a number, which is called "title number", "chapter number", or "track number" respectively.

Some discs may not have these numbers.

## On handling discs

- Do not touch the playback side of the disc.

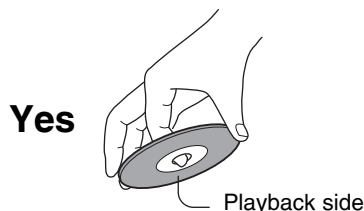

- Do not stick paper or tape to discs.



## On cleaning discs

- Fingerprints and dust on the disc cause picture and sound deterioration. Wipe the disc from the centre outwards with a soft cloth. Always keep the disc clean.



- Do not use any type of solvent such as thinners, benzene, commercially available cleaners or antistatic spray for vinyl LPs. It may damage the disc.

## On storing discs

- Do not store discs in a place subject to direct sunlight or near heat sources.
- Do not store discs in places subject to moisture and dust such as a bathroom or near a humidifier.
- Store discs vertically in a case. Stacking or placing objects on discs outside of their case may cause warping.

## Discs and purposes

The table shows main functions which are available on this recorder per disc category. This will help you choose discs.

	DVD-RW disc Video mode	DVD-RW disc VR mode	DVD-R disc Video mode
Characteristics on this recorder	Suitable for saving data in Video mode format to play on compatible devices.  You can erase recorded contents to use the disc repeatedly.	Suitable for saving data in VR mode format to play on compatible devices.  You can erase recorded contents to use the disc repeatedly.	Suitable for saving data in Video mode format to play on compatible devices.  Once you execute Video mode finalising process on a recorded disc so that it can be played on other players. You cannot make additions, corrections and deletions of contents on the disc.
For the first use	Initialise the disc.	Initialise the disc.	No preparatory steps required.
Recording a TV programme	Yes	Yes	Yes
Erasing recorded contents	Yes If the disc has been executed Video mode finalising process, first cancel the process then delete contents.	Yes You can erase recorded contents without cancelling the finalising process.	Yes Deleting contents cannot restore the disc space. <u>After you execute Video mode finalising process on a recorded disc, you cannot delete contents of the disc.</u>
Recording additional content on a recorded disc	Yes If the disc has been executed Video mode finalising process, first cancel the process then delete contents.	Yes You can add contents without cancelling the finalising process.	Yes <u>After you execute Video mode finalising process on a recorded disc, you cannot add contents to the disc.</u>
Indexing recorded contents Naming a title Creating a thumbnail	Yes Yes Yes <u>After you execute Video mode finalising process on a recorded disc, you cannot name a title or create a thumbnail.</u>	Yes Yes Yes <u>After you execute VR mode finalising process on a recorded disc, you can name a title or create a thumbnail.</u>	Yes Yes Yes <u>After you execute Video mode finalising process on a recorded disc, you cannot name a title or create a thumbnail.</u>
Collecting favourite scenes (Playlist Editing) Making a new title from a Playlist containing favourite scenes (Copy within the same disc)	No  No	Yes  Yes	No  No
Playing contents recorded on this recorder, on other devices	Execute Video mode finalising process on this recorder. This process makes the disc playable on other compatible devices. (Some models excepted.)	Execute VR mode finalising process on this recorder. This process makes the disc playable on other compatible devices. (Some models excepted.)	Execute Video mode finalising process on this recorder. This process makes the disc playable on other compatible devices. (Some models excepted.)
When a message appears and the loaded disc cannot be used	Initialise the disc.	Initialise the disc.	—

# Index to parts and controls

## Front Panel

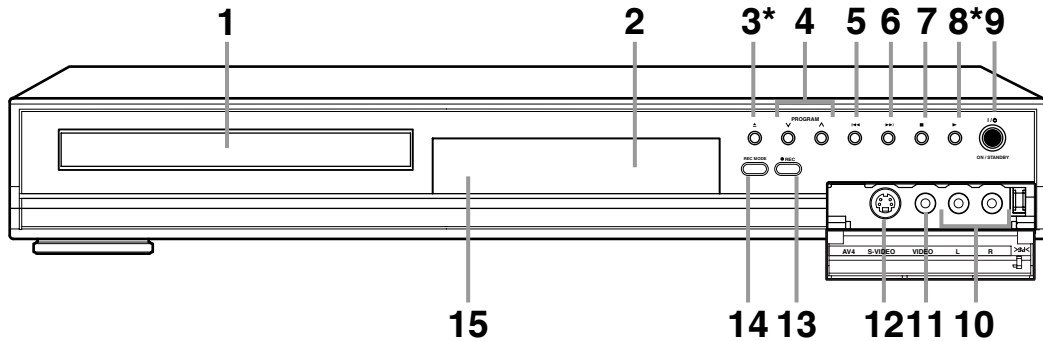

1. **Disc tray**  
Place a disc here when open.
  2. **Display**  
Refer to "Front Panel Display Guide" on page 18.
  3. **▲ (OPEN/CLOSE) button\***  
Press to open or close the disc tray.
  4. **PROGRAM ∇/▲ button**  
Press to change the channel up or down.
  5. **◀◀ (REV) button**  
During playback, press once midway through a chapter or track to go back to the beginning of the current chapter or track. When pressed twice in quick succession, playback will start from the preceding chapter or track.  
During playback, press and hold for 1.5 seconds to fast reverse.  
When playback is paused, press to play reverse step by step.  
When playback is paused, press and hold for 1.5 seconds to slow reverse.
  6. **▶▶ (FWD) button**  
During playback, press to skip to the next chapter or track.  
During playback, press and hold for 1.5 seconds to fast forward.  
When playback is paused, press to play advance step by step.  
When playback is paused, press and hold for 1.5 seconds to slow forward.
  7. **■ (STOP) button**  
Press to stop play or recording.  
Press to stop a timer recording.
  8. **▶ (PLAY) button\***  
Press to start or resume playback.
  9. **I/O (ON/STANDBY) button**  
Press to turn on or off the unit.  
If timer programming is set, press to switch the unit to timer-standby mode.
  10. **AUDIO input jacks (AV4)**  
Use to connect external equipment with a standard Audio cable.
  11. **VIDEO input jack (AV4)**  
Use to connect external equipment with a standard Video cable.
  12. **S-VIDEO input jack (AV4)**  
Use to connect the S-Video output of external equipment with an S-Video cable.
  13. **● REC button**  
Press once to start a recording.  
Press repeatedly to start a One-touch Timer Recording.
  14. **REC MODE button**  
Press to switch the recording mode.
  15. **Remote control sensor**  
Receives signals from your remote control so you can control the unit from a distance.
- \* You can also turn on the unit by pressing these buttons.

### Button names described in the Owner's Manual

The instructions in this manual are described mainly with the operations using the remote control. Some operations can be carried out using the buttons on the front panel.

## Rear Panel

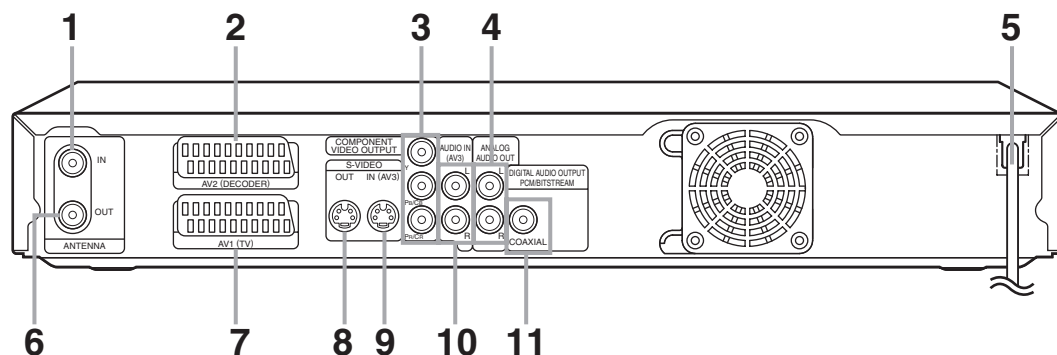

1. **ANTENNA IN jack**  
Connect to an antenna or cable.
2. **AV2 (DECODER) socket**  
Connect to VCR, camcorder, or other Audio-Video equipment.  
Use a commercially available Scart cable.
3. **COMPONENT VIDEO OUTPUT jacks**  
Connect to the component video input jacks on your TV.  
Use a commercially available Component Video cable.
4. **ANALOG AUDIO OUT jacks**  
Connect to the audio input jacks on your TV.  
Use a commercially available Audio cable.
5. **Mains cable**  
Connect to a standard AC outlet.
6. **ANTENNA OUT jack**  
Connect to the Aerial jack on your TV, cable box or direct broadcast system.  
Use the supplied RF cable.
7. **AV1 (TV) socket**  
Connect to the Scart socket on your TV.  
Use a commercially available Scart cable.
8. **S-VIDEO OUT jack**  
Connect to the S-Video input jack on your TV.  
Use a commercially available S-Video cable.
9. **S-VIDEO IN (AV3) jack**  
Connect to the S-Video output jack on your VCR, camcorder or other equipment.  
Use a commercially available S-Video cable.
10. **AUDIO IN (AV3) jacks**  
Connect to the audio output jacks on your VCR, camcorder or other Audio-Video equipment.  
Use a commercially available Audio cable.
11. **DIGITAL AUDIO OUTPUT PCM/BITSTREAM (COAXIAL) jack**  
Connect to an amplifier with a digital input jack such as a Dolby Digital decoder or DTS decoder.  
Use a commercially available Coaxial cable.

### Notes

- Do not touch the inner pins of the jacks on the rear panel. Electrostatic discharge may cause permanent damage to the unit.
- This unit does not have the RF modulator.

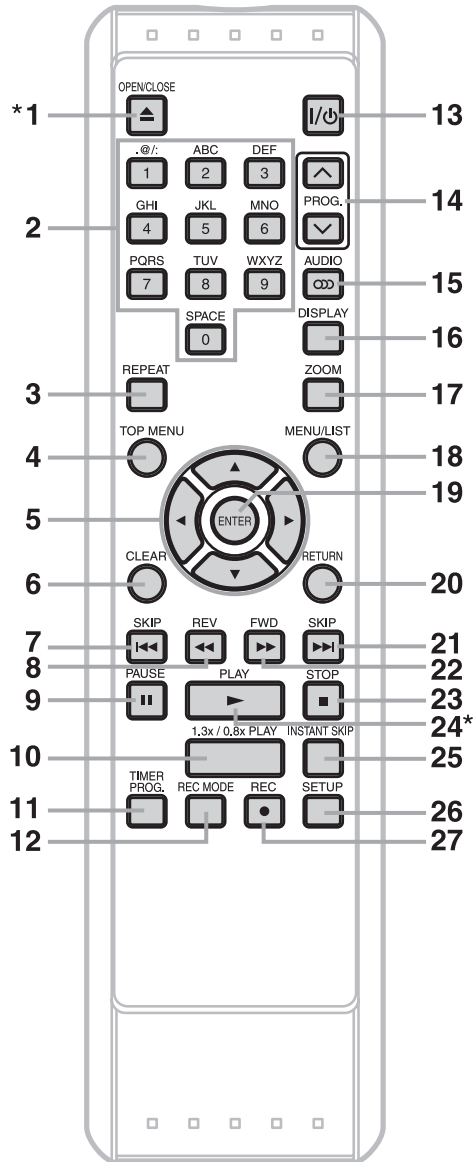



1. **OPEN/CLOSE ▲ button\***  
Press to open or close the disc tray.
2. **Number buttons**  
Press to select channel numbers. Press to select a title/chapter/track on display. Or press to enter values for the settings in the Setup menu.
3. **REPEAT button**  
Press to display the Repeat menu.
4. **TOP MENU button**  
Press to display the Title menu.
5. **Direction buttons (▲ / ▼ / ◀ / ▶)**  
Press to select items or settings.
6. **CLEAR button**  
Press to clear the password once entered or to cancel the programming for CD or to clear the selecting marker number in the marker setup mode or to clear the programme once entered in the Timer Recording setting mode, etc.
7. **SKIP ◀◀ button**  
During playback, press once midway through a chapter or track to go back to the beginning of the current chapter or track. When pressed twice in quick succession, playback will start from the preceding chapter or track. Or when playback is paused, press to play reverse step by step.
8. **REV ◀◀ button**  
During playback, press to fast reverse. Or when playback is paused, press to play slow reverse.
9. **PAUSE || button**  
Press to pause playback or recording.
10. **1.3x / 0.8x PLAY button**  
During playback, press to playback in a slightly faster/slower speed with keeping the audio quality.
11. **TIMER PROG. button**  
Press to display the Timer Programming list.
12. **REC MODE button**  
Press to switch the recording mode.
13. **I/O ON/STANDBY button**  
Press to turn the unit on and off. If timer programmings have been set, press to set the unit in timer-standby mode.
14. **PROG. ▲/▼ buttons**  
Press to change the channel up and down.
15. **AUDIO button**
  - When receiving a bilingual broadcast, press to change the audio out setting to “Main”, “Sub” or “Main/Sub”.
  - Press to change the bilingual audio source of an external equipment to “Main”, “Sub”, or “Main/Sub”. (Available only when the “External Input Audio” in the DVD setup menu is set to “Bilingual” in advance.)
  - Press to display the audio menu during playback.
  - Press to select the sound mode.
16. **DISPLAY button**  
Press to display the On Screen menu on or off.
17. **ZOOM button**  
During playback, press to enlarge the picture on the screen.
18. **MENU/LIST button**  
Press to display the Disc menu. To change Original and Playlist on the TV screen. (VR mode only)
19. **ENTER button**  
Press to confirm or select menu items.
20. **RETURN button**  
Press to return to the previously displayed menu screen.
21. **SKIP ▶▶ button**  
During playback, press to skip to the next chapter or track.  
Or when playback is paused, press to play forward step by step.
22. **FWD ▶▶ button**  
During playback, press to play fast forward. Or when playback is paused, press to play slow forward.
23. **STOP ■ button**  
Press to stop play or recording.
24. **PLAY ▶ button\***  
Press to start or resume play.
25. **INSTANT SKIP button**  
During playback, press to skip 30 seconds.
26. **SETUP button**  
Press to display the Setup menu.
27. **REC ● button**  
Press once to start a recording. Press repeatedly to start a One-touch Timer Recording.

\* The unit can also be turned on by pressing these buttons.

## Front Panel Display Guide

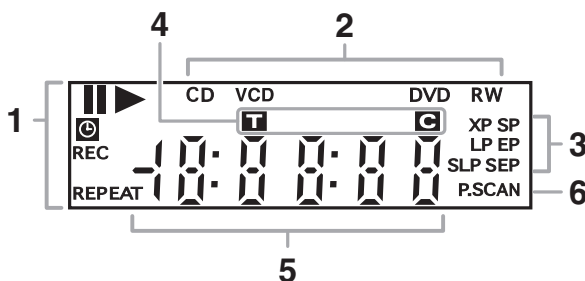

### 1. Current Status of the unit

- :Appears when disc playback is paused. Appears also during step by step playback.
- :Appears when playing a disc.
- :Appears during slow forward or slow reverse playback.
- :Appears when the timer programming or One-touch Timer Recording (OTR) is set and is operating. Flashes when all the timer programmes are finished. Flashes when there is an error in programming.

**REC** :Appears when recording. Flashes when recording being paused.

**REPEAT** :Appears during repeat playback.

### 2. Disc type and Current status of the unit

- CD** :Appears when an Audio CD or a disc with MP3 / JPEG files recorded is inserted into the unit.
- VCD** :Appears when a Video CD is inserted into the unit.
- DVD** :Appears when a DVD is inserted into the unit, or when recording.

### DVD R

:Appears when a DVD-R disc is inserted into the unit.

### DVD RW

:Appears when a DVD-RW disc is inserted into the unit.

### 3. Recording mode

:Selected recording mode appears.

### 4. Title / Track and Chapter mark

**T** :Title / track number

**C** :Chapter number

### 5. Displays the following

- Playing back time
- Current title / chapter / track number
- Recording time / remaining time
- Clock
- Channel number
- One-touch Timer Recording (OTR) remaining time

### 6. P.SCAN

:Appears when the progressive scan system is activated.

### ■ Display message



The unit is turned on.



The disc tray is closing.



The unit is turned off.



A disc is loading.



The disc tray is opening.



Data is being recorded on a disc.

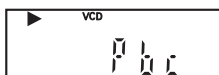

The PBC function of the Video CD is activated.

# Preparation of the remote control

## Installing batteries in the remote control

- Install two R6 (AA) batteries (supplied) into the remote control, carefully match with the polarity indicated inside the battery compartment.

### 1 Open the cover.

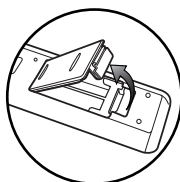

### 2 Insert batteries.

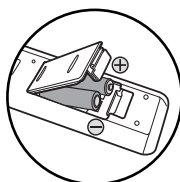

Make sure to match the + and - on the batteries to the marks inside the battery compartment.

### 3 Close the cover.

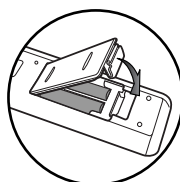

#### Notes:

- Incorrect use of batteries can result in hazards such as leakage and bursting.
- Do not mix new and old batteries together.
- Do not use different kinds of batteries together.
- Make sure that the + and - ends of each battery match the indications inside the battery compartment.
- Remove batteries if the remote control will not be used for an extended period of time.
- When disposing used batteries, please comply with governmental regulations or the public instructions for environmental protection that apply in your country or area.
- Do not recharge, short-circuit, heat, burn or disassemble batteries.

## About the remote control

- Keep in mind the following when using the remote control:

- Make sure there is no obstacle between the remote control and the remote control sensor on the unit.
- Use within the operating range and angle as shown.
- Remote control operation may become unreliable if the remote control sensor of the unit is being exposed by the strong sunlight or fluorescent light.
- Remote controls for different devices can interfere with each other. Be careful when using remote controls for other equipment located close to the unit.
- Replace the batteries when the operating range of the remote control reduces.
- The maximum operable range as follows:
  - **Line of sight:** approximately 7 m
  - **Either side of the centre:** approximately 7 m within 30 degrees

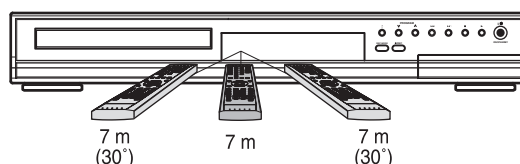

# On Screen menu

This unit uses the following On Screen menu for most operations: Setup menu, Title list, Playlist, Original and Display menu. They allow you to change the playing status of disc during playback.

The Display menu also gives you information on the status of the disc.

## Display menu

With a disc inserted into the unit, press [DISPLAY] to display the On-Screen Display. The menu shows information about what is recorded on the disc.

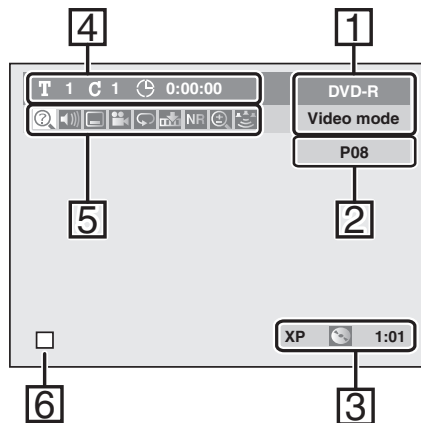

1. **Disc type and format mode**  
In some descriptions in this manual, only one type of disc is indicated as an example.
2. **Position number of the programme**
3. **Recording mode and remaining time**
4. **Title number, chapter number and the elapsed time of disc playback**
5. **Each icon means:**
  - : Search
  - : Audio
  - : Subtitle
  - : Angle (except VR mode)
  - : Repeat
  - : Marker
  - : Noise Reduction
  - : Zoom
  - : Surround
6. **Status of the current disc**

## Setup menus

Press [SETUP] to display the Setup menu, then press [ENTER] to display each menu, using [▲ / ▼]. These menus provide entries to all main functions of the unit.

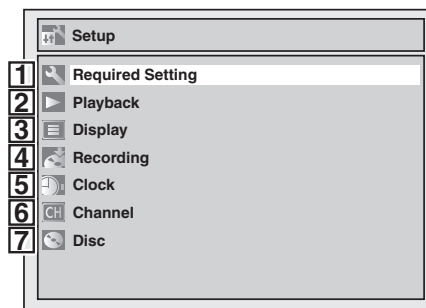

1. **Required Setting:**  
To set up the required setting.
2. **Playback:**  
To set up the unit to play discs as you prefer.
3. **Display:**  
To set up the screen and the front display of the unit as you prefer.
4. **Recording:**  
To set up the unit to record on discs as you prefer.
5. **Clock:**  
To set up the clock of the unit as you need.
6. **Channel:**  
To adjust the channel setting of the unit as you prefer.
7. **Disc / CD Playback Mode:**  
**When a DVD-Video disc (commercially available) or a new DVD-R disc is inserted into the unit, you cannot select "Disc".**  
"CD Playback Mode" is available only when an Audio CD disc or a CD-R/RW disc with MP3 / JPEG files is inserted into the unit.

## &lt;DVD-R, DVD-RW (Video mode)&gt;

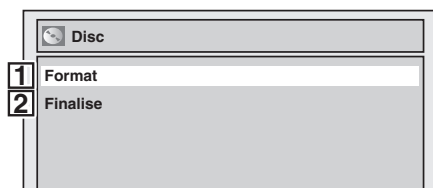

## &lt;DVD-RW (VR mode)&gt;

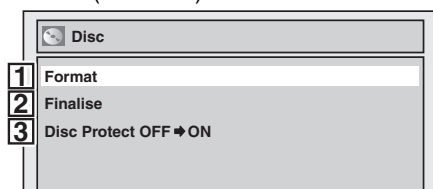

## &lt;Audio CD, MP3, JPEG, Video CD&gt;

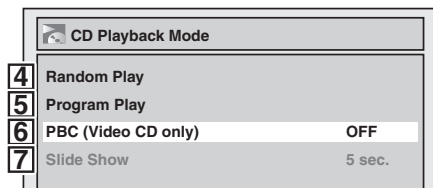
**1. Format (DVD-RW only):**

Allows you to erase all of the recorded contents on the disc.

The disc will be completely blank.

- Erased content cannot be called back.
- A DVD-RW disc formatted with this unit cannot be used on other DVD recorders without any recording using this unit.
- If you want to use a disc only formatted with this unit on other DVD recorder, you have to re-format the disc on that recorder.

**2. Finalise:**

Allows you to finalise a disc containing recorded titles.

**3. Disc Protect (VR mode only):**

Allows you to protect a disc from accidental editing or recording.

**4. Random Play:**

To activate the random playback feature.

**5. Program Play (Audio CD and Video CD only):**

To activate the programmed playback feature.

**6. PBC (Video CD only):**

Turn the PBC function "ON" or "OFF".

**7. Slide Show (JPEG files only):**

Select the display time of the slide show mode.



# Connections

Connect your recorder to your TV or stereo system.

- **Connections**

# Connections

Connect the unit to a TV after considering the capabilities of your existing equipment.  
Before installation, unplug your TV and this unit.

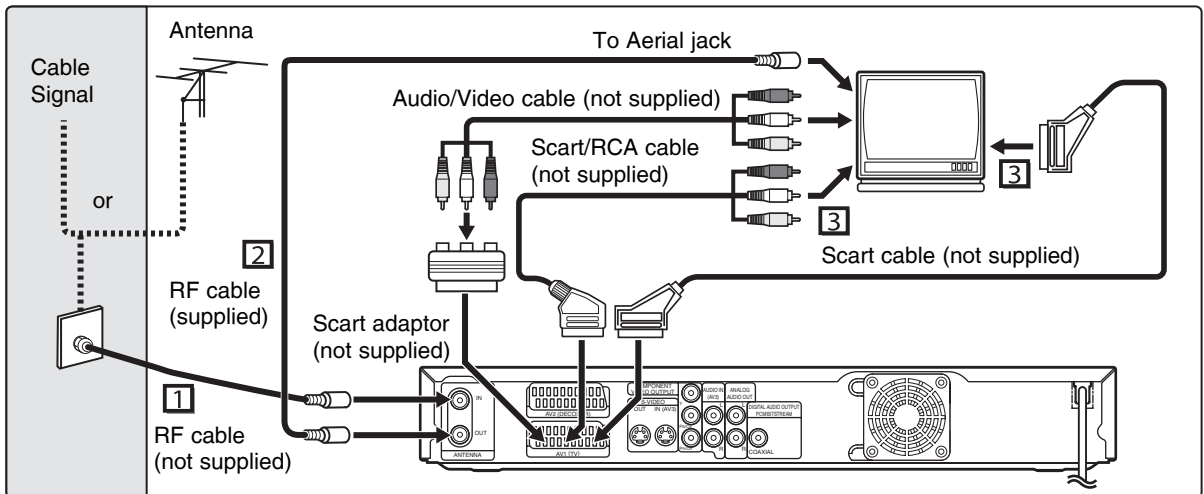

## ■ Using the Scart socket

- 1) Connect the antenna or cable to the **ANTENNA IN** jack of this unit.
- 2) Connect the **ANTENNA OUT** jack of this unit to the **Aerial jack** of your TV. Use the supplied RF cable.
- 3) Connect **AV1 (TV) Scart socket** of this unit to the **Scart socket** of your TV. Use a commercially available Scart cable.

### Notes

- If your TV does not have a Scart socket, use a commercially available Scart adaptor or Scart / RCA cable to connect.
- Connect this unit directly to the TV. If the A/V cables are connected to a VCR, pictures may be distorted due to the copy protection system.
- **When changing the “Video Out” setting (“SCART (RGB)”, “Component Interlace (I)” or “Component Progressive (P)”)**, connect to a Video jack or an S-Video jack on the TV. If the setting is changed, for example, to “Component Interlace (I)” or “Component Progressive (P)” while the scart cable is connected to the TV, a distorted video signal may be output.

### Selecting Progressive Scan (625p <576p> or Interlaced 625i <576i>) Playback

- If your TV is compatible with progressive scanning (625p <576p>), connect the TV to the **COMPONENT VIDEO OUTPUT** jacks of the DVD player and set “Video Out” setting to “Component Progressive (P)” in the setup menu (see page 119). Next, set your TV to the progressive scan mode.
- If your TV is not compatible with progressive scan, set “Video Out” setting to “Component Interlace (I)”.
- Use a commercially available adaptor if the Video input jacks of your TVs or monitors are the BNC type.



## Using the S-VIDEO OUT or the COMPONENT VIDEO OUTPUT jacks and the ANALOG AUDIO OUT jacks

If your TV has an S-Video or a Component Video input jack, use either an S-Video cable (to connect the S-VIDEO OUT jack) or a Component Video cable (to connect the COMPONENT VIDEO OUTPUT jacks), and an Audio Cable (to connect the ANALOG AUDIO OUT jacks).

- S-Video connection provides the good quality picture.
- Component connection provides the better quality picture.

- 1) Follow steps 1 and 2 on page 24.
- 2) Connect S-VIDEO OUT or COMPONENT VIDEO OUTPUT jacks of this unit to the S-Video or Component Video input jacks of your TV. Use a commercially available S-Video cable or Component Video cable.
- 3) Connect the ANALOG AUDIO OUT jacks of this unit to the analogue Audio input jacks of your TV. Use a commercially available Audio cable.

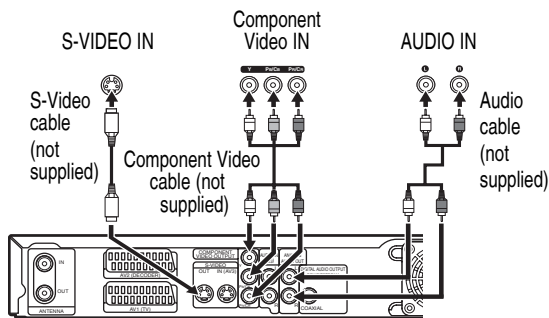

### Note for a TV with no S-Video input jack or Scart socket:

- This unit has no RF modulator, so this type of TV cannot be used.
- Only component connection is compatible with the Progressive Scan.

## Connecting to external equipment

This unit has four input terminals, AV1, AV2 or AV3 on the rear panel and AV4 on the front panel. Be sure that all the units are off before making connections.

### ■ Recording from a DVD player, VCR or other Audio-Video equipment with a Scart output jack (AV2)

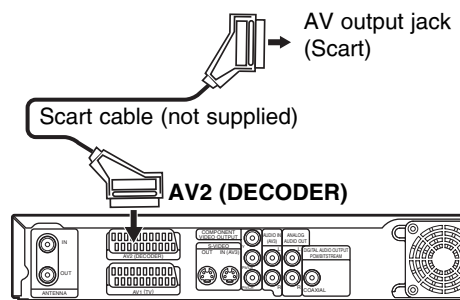

#### Note

- If the external equipment connected to the AV2 jack supplies control voltage to this unit via Pin 8 of the Scart cable, the display functions (e.g. P01) of the remote control cannot be seen on the TV connected to the AV1. In this case, turn off the external equipment to prevent control voltage.

### ■ Recording from a camcorder or other Audio-Video equipment with no Scart output jack (AV3 or AV4)

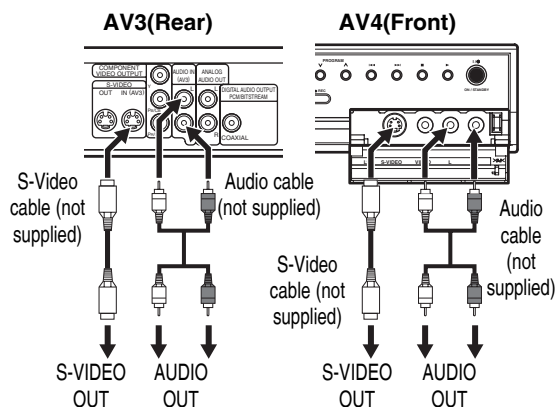

Change the setup. (See page 55.)

If no S-Video input jack is available, connect to VIDEO input jack on the front panel using an RCA Video cable.

## Digital audio for better sound quality

### ■ The connections illustrated below are optional for better sound.

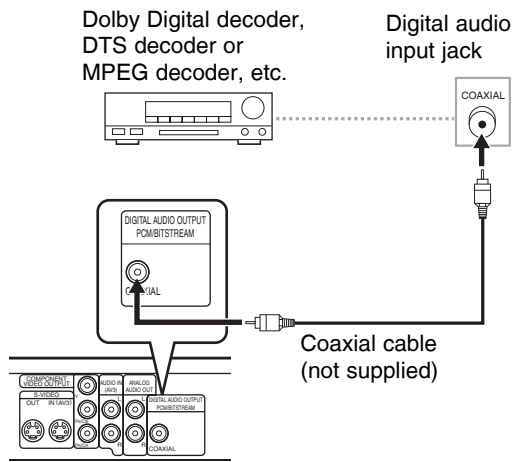

### 1) For clear digital sound quality, use the DIGITAL AUDIO OUTPUT PCM/ BITSTREAM (COAXIAL) jack to connect your digital audio equipment.

If the audio format of the digital output does not match the capabilities of your receiver, the receiver will produce a strong, distorted sound or no sound at all.

### ■ Connecting a Dolby Digital™ decoder, DTS decoder or MPEG decoder

- Connecting multi-channel Dolby Digital decoder allows you to enjoy the multi-channel Dolby Digital surround system as well as DTS decoder, multi-channel surround system.
- After connecting to a Dolby Digital decoder, set "Dolby Digital" to "Stream" in the Audio menu. (See page 115.)
- After connecting to a DTS decoder, set "DTS" to "ON" in the Audio menu. (See page 115.)
- After connecting to a MPEG decoder, set "MPEG" to "Stream" in the Audio menu. (See page 115.)

### ■ Connecting to an MD deck or DAT deck

- The audio source recorded in Dolby Digital multi-channel surround format cannot be recorded using an MD or DAT deck as a digital sound.
- If not connected to a Dolby Digital decoder, set "Dolby Digital" to "PCM" in the Audio menu (see page 115).
- Playing back a DVD using incorrect settings may generate noise distortion, and damage speakers.
- Set "Dolby Digital" and "MPEG" to "PCM" and set "DTS" to "OFF" in the Audio menu (see page 115) for connecting to an MD or DAT deck.
- You can use ANALOG AUDIO OUT jacks for the connection of your audio system.

## After you have completed connections

Switch the input selector on your TV to an appropriate external input channel. For details, refer to the Owner's Manual of your TV.

### Note

- Connect this unit directly to the TV. If the AV cables are connected to a VCR, pictures may be distorted due to the effects of the copy protection system.

# **Basic Setup**

Read this chapter for necessary settings to get started.

- **Initial setting**
- **Channel setting**
- **Setting the clock**
- **Selecting the TV aspect ratio**

# Initial setting

You need to follow these steps when you turn this unit on for the first time.

- 1) Press [I/O ON/STANDBY].
- 2) Turn the TV on. Select the input to which the unit is connected.  
Initial Setting menu will automatically appear.
- 3) Press [ENTER] to start Channel Tuning.

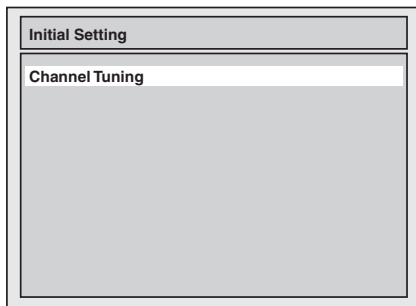

The unit will start getting channels available in your area.

- 4) After channel setting is finished, "Clock Setting" will appear. Then press [ENTER].

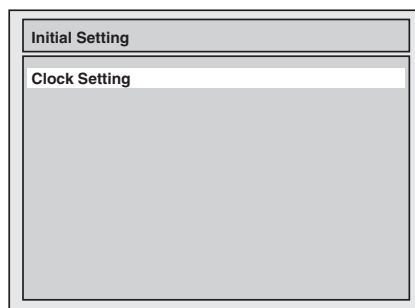

Clock Setting menu will appear.

- 5) Press [ENTER] again, then follow the steps 4 to 5 on page 32 in "Manual Clock Setting".

# Channel setting

Tuning of this unit to broadcast channels can be performed in two ways.

## Auto tuning

Programme the tuner to scan only the channels you can receive in your area.

### 1) In stop mode, press [SETUP].

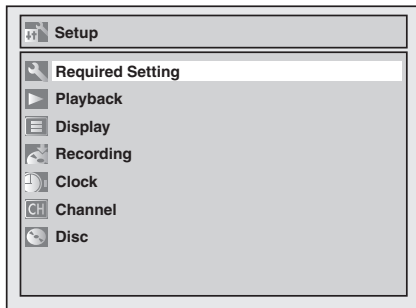

Setup menu will appear.

### 2) Select "Channel" using [▲ / ▼], then press [ENTER].

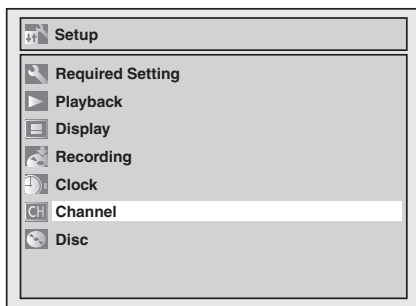

Channel menu will appear.

### 3) Select "Auto Tuning" using [▲ / ▼], then press [ENTER].

The unit will start storing channels available in your area.

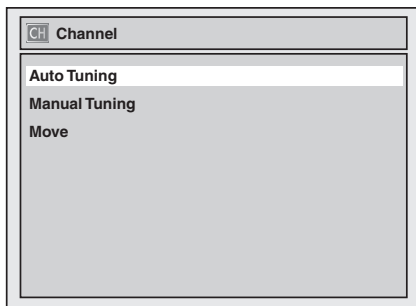

Wait for several minutes to finish channel storing.

### 4) Press [SETUP] to exit.

You can select only the channels memorised in this unit by using [PROG. ▲/▼].

### ■ To select a channel

You can select a channel using [PROG. ▲/▼], or directly enter the channel using [the Number buttons] on the remote control.

### ■ To cancel auto tuning

Press [RETURN] or [SETUP] during scanning.

### Notes

- The selection will be affected by how you receive TV channels in your local area.
- If the auto tuning is cancelled during scanning, some channels not yet tuned may not be received.
- Sorting of TV channels from P01 to P06 will be performed automatically as follows.

P01: BBC1      P02: BBC2      P03: ITV  
P04: CH4      P05: CH5      P06: SKY NEWS

\* If you are using a satellite receiver, turn it on and select SKY NEWS before commencing tuning.

## Manual tuning

Manually tune each channel.

### 1) In stop mode, press [SETUP].

### 2) Select "Channel" using [▲ / ▼], then press [ENTER].

### 3) Select "Manual Tuning" using [▲ / ▼], then press [ENTER].

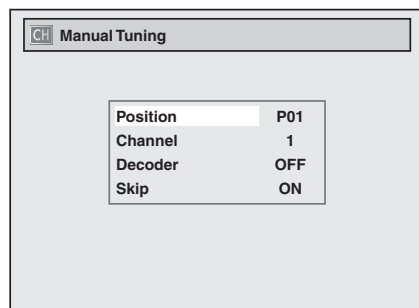

### 4) Select "Position" using [▲ / ▼], then press [▶].

### 5) Select the position number you want using [▲ / ▼], then press [◀].

You can select position numbers 01 to 99.

### 6) Select "Channel" using [▲ / ▼], then press [▶].

## Channel setting (cont'd)

## 7) Press [▲ / ▼] to start scanning.

- The tuner will begin to search up or down automatically. When a channel is found, the unit will stop searching and the picture will appear on the TV screen.
- You can select a desired channel number using [the Number buttons]. Refer to the following Channel Plan table and press the three digits to select the channel number.  
(To select channel 4, press [0] first and then press [0] and [4]. Or press [4] and then “– 4” appears and wait for 2 seconds.)
- If this is the channel you want, press [◀].

Channel Plan	
Ch. Indication	TV Channel
01 - 10	IRA - IRJ, GAP
21 - 69	E21 - E69
74 - 78	X, Y, Z, Z+1, Z+2
80 - 99, 100	S1 - S20, GAP
121 - 141	S21 - S41

This unit can receive the Hyper and Oscar frequency bands.

- If you want to decode scrambled signals, select “Decoder” using [▲ / ▼], then press [▶]. Select “ON” using [▲ / ▼], then press [◀].
- If “Skip” is set to “ON”, select “Skip” using [▲ / ▼], then press [▶]. Select “OFF” using [▲ / ▼], then press [◀].
- To store another channel, repeat steps 4 to 7.

## 8) After completion, press [SETUP] to exit.

## To select a channel

## Notes on using [the Number buttons]:

- Enter channel numbers as a two-digit number for the quickest result. For example, to select channel 6, press [0] and [6]. If you only press [6], channel 6 will be selected after 2 seconds. You can only select channels 1 to 99.
- You can select the external input mode “AV1”, “AV2”, “AV3” or “AV4”.
  - To select “AV1”, press [0], [0], [1].
  - To select “AV2”, press [0], [0], [2].
  - To select “AV3”, press [0], [0], [3].
  - To select “AV4”, press [0], [0], [4].

## To skip a Preset channel

You can set the unit to skip channels you can no longer receive or seldom watch when you access channels using [PROG. ▲/▼].

- Follow steps 1 to 3 in “Manual tuning” on page 29.
- Select “Position” using [▲ / ▼], then press [▶].
- Select the position number you wish to skip using [the Number buttons] or [▲ / ▼], then press [◀].
- Select “Skip” using [▲ / ▼], then press [▶].
- Select “ON” using [▲ / ▼], then press [◀].
  - To skip another channel, repeat steps 2 to 5.
- Press [SETUP] to exit.

## Move

You can replace two channels.

- In stop mode, press [SETUP].
- Select “Channel” using [▲ / ▼], then press [ENTER].
- Select “Move” using [▲ / ▼], then press [ENTER].
- Select the position number you want to move the channel using [▲ / ▼], then press [ENTER].  
You cannot select a position number where “– –” appears next to the number, because “Skip” is set to “ON” for that position number.
- Move the channel to another position number using [▲ / ▼], then press [ENTER].
  - To move another channel, repeat steps 4 to 5.
- Press [SETUP] to exit.

# Setting the clock

## Auto Clock Setting

Channel Tuning must be set before setting Auto Clock.

- 1) In stop mode, press [SETUP].
- 2) Select "Clock" using [▲ / ▼], then press [ENTER].

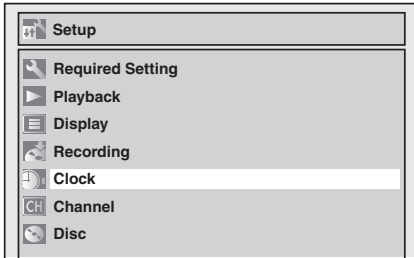

Clock menu will appear.

- 3) Select "Auto Clock Setting" using [▲ / ▼], then press [ENTER].

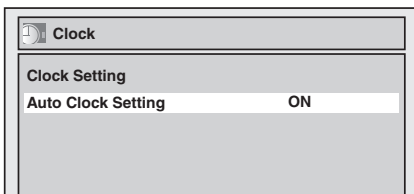

Option window will appear.

- 4) Select "ON" using [▲ / ▼], then press [ENTER].
- 5) Press [SETUP] to exit.
- 6) Press [I/O] ON/STANDBY to turn off.

The Auto Clock function is activated.

This unit will search for the time only when the power is off. Leave the unit off for several minutes to give it time to set the clock.

### Notes

- If you want to cancel "Auto Clock Setting", select "OFF" using [▲ / ▼] at step 4, and then press [ENTER].
- The default setting of "Auto Clock Setting" is "ON".
- The clock may set itself automatically after you connect the antenna cable to the unit and plug in the mains cable. In this case, the current time will appear on the front panel display.
- To set the clock automatically, the channel assigned to "P04" must receive the PDC signal.
- The clock cannot be set automatically if you are not receiving a channel in your area that carries a time signal. In this case, set the clock manually.
- Once the auto clock setting is performed, the unit will correct the current time by receiving PDC broadcasts whenever you turn off the unit.
- The unit will correct the current time automatically at 8:00, if the unit power is turned off.
- Between 23:00 and 1:00, the Auto Clock function will not operate even if the unit power is turned off.

## Manual Clock Setting

- 1) In stop mode, press [SETUP].
- 2) Select "Clock" using [▲ / ▼], then press [ENTER].

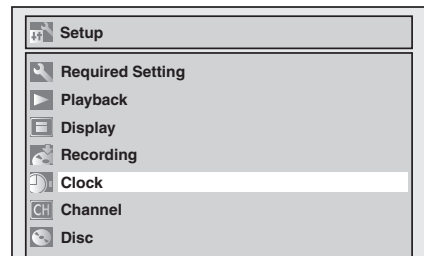

Clock menu will appear.

- 3) Select "Clock Setting" using [▲ / ▼], then press [ENTER].

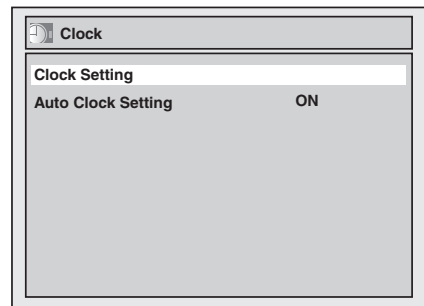

Clock Setting menu will appear.

Press [ENTER] again.

Default date will appear.

### Setting the clock (cont'd)

#### 4) Enter the date (day / month / year) using [▲ / ▼].

Press [▶] to move the cursor to the next field. If you wish to go back to the previous field, press [◀].

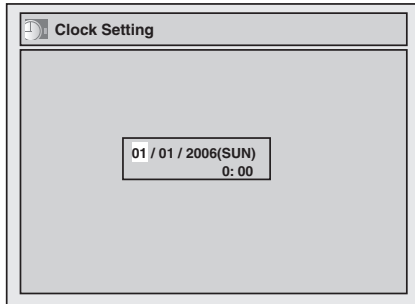

- “SUN / MON / TUE / WED / THU / FRI / SAT” will change automatically as the date is entered.

#### 5) Enter the time (hours / minutes) using [▲ / ▼], then press [ENTER].

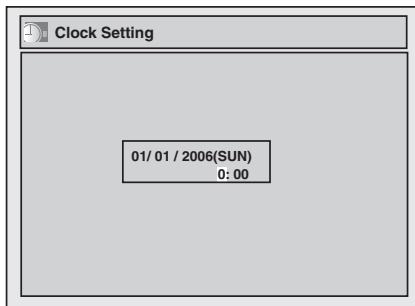

The clock will start.

- Although seconds are not displayed, they will be counted from zero.

#### 6) Press [SETUP] to exit the Clock menu.

#### Note

- Your clock setting will be lost if either there is a power failure or the unit is unplugged for more than 30 seconds when the “Auto Clock Setting” is “OFF”.



# Selecting the TV aspect ratio

You can select the TV aspect ratio to match the format of the programme you are playing back with the unit and that of your TV screen (4:3 standard or 16:9 wide screen TV).

- 1) In stop mode, press [SETUP].
- 2) Select "Required Setting" using [▲ / ▼], then press [ENTER].

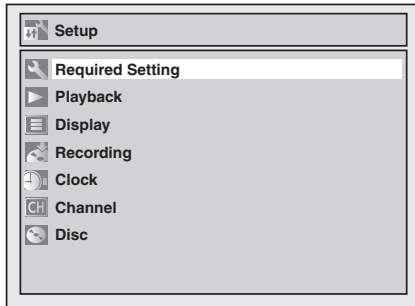

Required Setting menu will appear.

- 3) Select "TV Aspect" using [▲ / ▼], then press [ENTER].

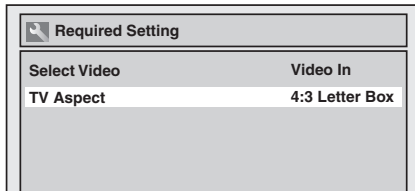

Option window will appear.

- 4) Select the desired option using [▲ / ▼], then press [ENTER].

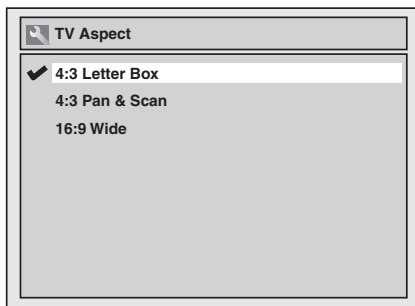

- 5) Press [SETUP] to exit.

## Note

### If you have a standard TV:

- Select "4:3 Letter Box" for a full width picture with black bars at the top and bottom.
- Select "4:3 Pan & Scan" for a full height picture with both sides trimmed.

### If you have a widescreen TV:

- Select "16:9 Wide".



## Symbols in this Section

The following icons show the playable discs for each function described in this section.

**DVD-RW VIDEO** : Video mode DVD-RW disc

**DVD-RW VR** : VR mode DVD-RW disc

**DVD-R** : DVD-R disc

Most instructions are based on the remote control operation, unless otherwise noted. You can use the buttons on the remote control and those on the main unit as well when they have the same function.

# Recording



Recording variations for many types of programmes or situations.

- **Information on DVD recording**
- **Selecting the Recording format**
- **Basic recording**
- **One-touch Timer Recording**
- **Timer Recording**
- **Settings for an external equipment**
- **Setting disc protection**
- **Finalising discs**

# Information on DVD recording

## Information

- This unit can record on DVD-R and DVD-RW. You can record on DVD-R only once. On DVD-RW, you can record and erase many times.
- It is possible to record on DVD-R only in Video mode. DVD-RW can record in the format you select from Video mode or VR mode.
- If you want to record repeatedly on the same disc or if you want to edit the disc after recording, use a rewritable DVD-RW type disc.
- If you want to save recordings without any alteration, use a non-rewritable DVD-R type disc.

Logo	Attributes
	8 cm / 12 cm, single-sided, single layer disc Max. recording time (SEP mode, approx.): 600 minutes (4.7 GB) (for 12 cm) 180 minutes (1.4 GB) (for 8 cm)
	
<b>DVD-R</b>	

## Notes

- **This unit cannot record on CD-R or CD-RW discs.**
- DVD-R/RW and CD-R/RW discs recorded on a personal computer or on a DVD or CD recorder may not be played back if the disc is damaged or dirty or if there is condensation on the player's lens.
- If you record a disc using a personal computer, even if it is recorded in a compatible format, it may not be played back because of the settings of the application software used to create the disc. (Check with the software publisher for more detailed information.)
- Discs recorded in Video mode on this unit cannot record additional information using other DVD recorders.
- It is impossible to use a DVD-RW disc formatted with this unit on other DVD recorder unless the content of the disc was also recorded with this unit.
- Since recording is performed using the Variable Bit Rate (VBR) method, the actual remaining time for recording may be a little shorter than the remaining time displayed on the OSD, depending on the picture you are recording.

## Recording Mode

### ■ Recording Mode

You can select a recording mode from 6 options.

The recording time will vary depending on the recording mode you select as follows.

Disc Size	Recording mode	Recording time	Video/Sound Quality
8cm Disc	XP	18 min	★★★★★
	SP	36 min	★★★★★
	LP	72 min	★★★★
	EP	108 min	★★★
	SLP	144 min	★★
	SEP	180 min	★
12cm Disc	XP	60 min	★★★★★
	SP	120 min	★★★★★
	LP	240 min	★★★★
	EP	360 min	★★★
	SLP	480 min	★★
	SEP	600 min	★

- This table is intended for a standard new single-sided 12 cm/8 cm disc. The recording times listed above are estimates and are for reference purpose only. Actual recording times may vary.
- The audio and video quality of content being recorded may degrade depending on your chosen recording mode.

## Restrictions on recording

You cannot record copy-protected video using this unit. Copy-protected video includes DVD-Video discs and some satellite broadcasts.

**If copy-protected material is detected, recording will pause or stop automatically and an error message appears on the screen.**

**You can only record "Copy-once only" video using a DVD-RW disc in VR mode with Content Protection for Recordable Media (CPRM).**



When recording a TV broadcast or an external input, you can display copy control information on the screen.

### What is "CPRM"?

CPRM is a scrambling copy protection system for the protection of "copy-once" broadcast programmes. This unit is CPRM compatible, which means that you can record copy-once broadcast programmes, but you cannot make a copy of those recordings. CPRM recordings can only be played back on DVD players that are specifically compatible with CPRM.

## Information on copy control

Some satellite broadcasts include copy-protected information. If you wish to record them, refer to the following.

Disc type/Format		Copy-free	Copy-once	Copy-prohibited
	VR mode	ver.1.1,1.2	★	—
		ver.1.1,1.2 CPRM compatible	★	★
DVD-RW	Video mode	ver.1.1,1.2	★	—
		ver.1.1,1.2 CPRM compatible	★	—
	Video mode	ver.2.0	★	—

★ Recordable      — Not Recordable

## Making discs playable in other DVD player (Finalise)

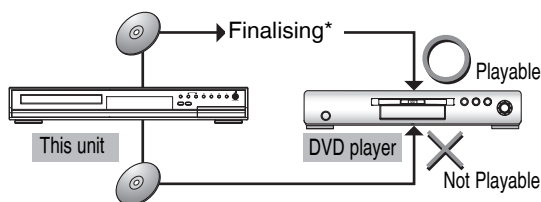

\* You cannot finalise discs recorded in other DVD recorders.

After recording, you must finalise the disc to play it back in other players. (See pages 59-60.)

You cannot finalise discs in other DVD recorders.

### After finalising:

- After DVD-R discs are finalised:
  - A Title menu is created automatically.
  - Undo finalising is impossible.
  - Additional recording or editing is impossible.
- After DVD-RW (Video mode) discs are finalised:
  - A Title menu is created automatically.
  - Undo finalising is possible. (See page 60.)
  - Additional recording or editing is possible if you undo finalise. (See page 60.)
- After DVD-RW (VR mode) discs are finalised:
  - A Title menu is not created.
  - Undo finalising is possible. (See page 60.)
  - Additional recording or editing is possible even without undo finalising.

# Selecting the Recording format

## Choosing the recording format of a blank disc

DVD-RW VIDEO

DVD-RW VR



When inserting a blank disc, the unit automatically starts to initialise the disc. You can also manually format a DVD-RW disc if you wish to reuse it.

**1** In stop mode, press [SETUP].

**2** Select “Disc” using [▲ / ▼], then press [ENTER].

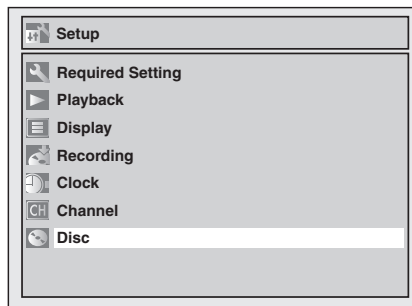

Disc menu will appear.

**3** Select “Format” using [▲ / ▼], then press [ENTER].

<e.g. VR mode>

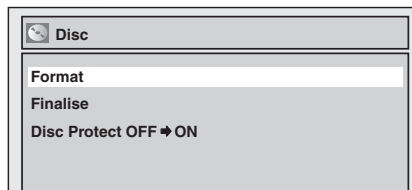

Format menu will appear.



## 4 Select “Format Mode” using [▲ / ▼], then press [ENTER].

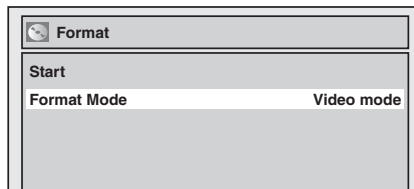

“Video mode” has been selected as the default.

## 5 Select “Video mode” or “VR mode” using [▲ / ▼], then press [ENTER]. The recording format will be set.

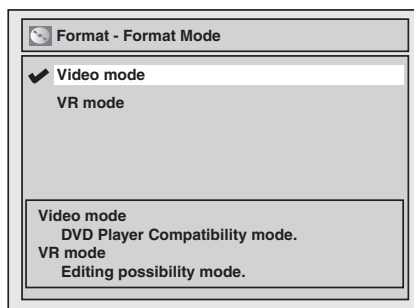

## 6 Press [SETUP] to exit.

## 7 Insert a blank disc. Formatting will start.

## 8 Formatting is complete. “100%” is indicated.

### Notes

- The recording format setting is effective only for DVD-RW discs. You cannot change the recording format for a DVD-R disc. DVD-R discs are always in Video mode.
- **You cannot mix two formats on one DVD-RW disc. If you insert a disc that has been recorded before, the recording format cannot be changed even if you change it in the Setup menu.**
- If a blank DVD+R or DVD+RW disc is inserted, the error message “Disc Error” will appear.

## Selecting the Recording format (cont'd)

## Reformatting a disc

DVD-RW VIDEO | DVD-RW VR

If you are using a DVD-RW disc, you can format the disc by performing "Format". By default it will be in Video mode. You can change this to VR mode in the Setup menu.

**Insert a recordable disc.**

Make sure that the recording format is set to the desired mode (Follow the steps 1 to 6 on pages 38-39).

- 1) In stop mode, press [SETUP].
- 2) Select "Disc" using [ $\blacktriangle$  /  $\blacktriangledown$ ], then press [ENTER].  
Disc menu will appear.
- 3) Select "Format" using [ $\blacktriangle$  /  $\blacktriangledown$ ], then press [ENTER].  
Format menu will appear.
- 4) Select "Start" using [ $\blacktriangle$  /  $\blacktriangledown$ ], then press [ENTER].

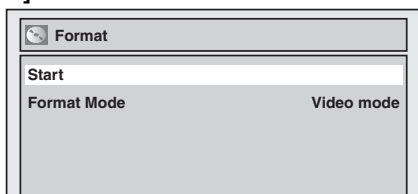

A popup window will appear and prompt you to confirm.

- 5) Select "Yes" using [ $\blacktriangle$  /  $\blacktriangledown$ ], then press [ENTER].  
Formatting will start.  
If you want to cancel formatting, select "No".

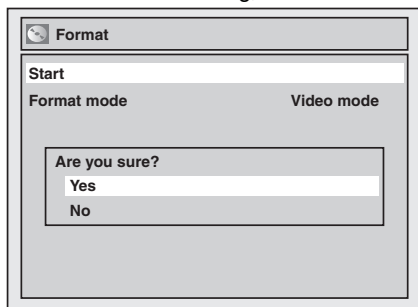
**6) Formatting is complete.**

"100%" is indicated.

**This operation may take awhile to be completed.**

**Notes**

- When you reformat the disc, the contents of the disc are erased.
- It is impossible to record on a disc formatted with this unit in other DVD recorder. When you record a disc with another DVD recorder, format a disc using that DVD recorder.

## Setting Auto Chapter

DVD-RW VIDEO | DVD-RW VR | DVD-R

The unit inserts a chapter mark periodically (every 10 minutes by default) during recording. Using the Auto Chapter menu, you can set this function off or change the time period.

- 1) In stop mode, press [SETUP].
- 2) Select "Recording" using [ $\blacktriangle$  /  $\blacktriangledown$ ], then press [ENTER].
- 3) Select "Auto Chapter" using [ $\blacktriangle$  /  $\blacktriangledown$ ], then press [ENTER].

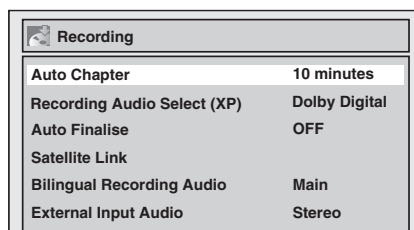

Option window will appear.

- 4) If you wish to set "Auto Chapter" to off, select "OFF" using [ $\blacktriangle$  /  $\blacktriangledown$ ], then press [ENTER].

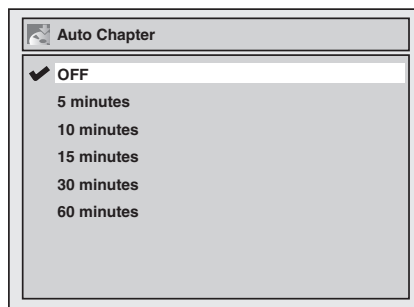

If you wish to change the time period for Auto Chapter, select the required time period using [ $\blacktriangle$  /  $\blacktriangledown$ ], then press [ENTER].

- 5) Press [SETUP] to exit.

**Note**

- You cannot set or clear chapter markers on DVD-R discs manually.



## Selecting the Sound mode

This unit can receive bilingual broadcasts.

You can switch between modes by pressing [AUDIO] on the remote control. Each mode is indicated on the TV screen as follows.

- During reception of bilingual broadcasts

Mode	Audio output	Display on the TV screen
Main	Main audio from both speakers	Main
Sub	Sub audio from both speakers	Sub
Main / Sub	<ul style="list-style-type: none"> <li>• Main audio from the left speaker</li> <li>• Sub audio from the right speaker</li> </ul>	Main / Sub

## Recording Audio Select (XP)

DVD-RW VIDEO | DVD-RW VR | DVD-R

You can enjoy high quality sound recording. This function works only when the recording mode is set to XP.

1) Press [SETUP].

2) Select "Recording" using [▲ / ▼], then press [ENTER].

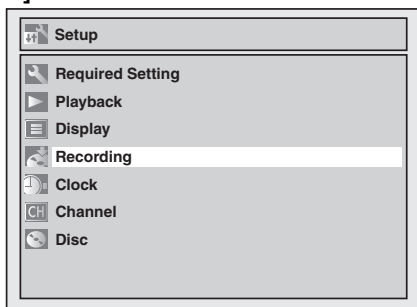

Recording menu will appear.

3) Select "Recording Audio Select (XP)" using [▲ / ▼], then press [ENTER].

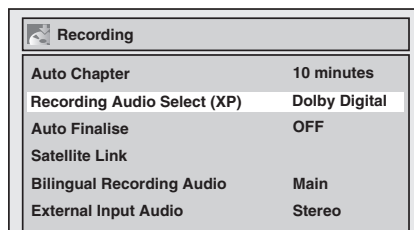

Option window will appear.

4) Select "PCM" or "Dolby Digital" using [▲ / ▼], then press [ENTER].

"Dolby Digital" is selected as a default.

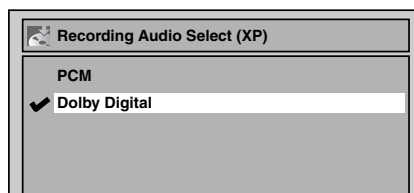

### PCM:

Records PCM audio for the best quality sound.

### Dolby Digital:

Records Dolby Digital audio for good quality sound.

5) Press [SETUP] to exit.

### Notes

- "PCM" stands for Pulse Code Modulation. It changes analogue sound to digital sound without compressing audio data.
- When the recording mode is set to other than XP, the unit records "Dolby Digital" audio automatically even if you selected "PCM".

## Selecting the Recording format (cont'd)

## Setting External Input Audio

DVD-RW VIDEO | DVD-RW VR | DVD-R

When the external input audio is a bilingual broadcast, you can choose "Stereo" or "Bilingual" to record on a DVD.

- 1) In stop mode, press [SETUP].
- 2) Select "Recording" using [▲ / ▼], then press [ENTER].

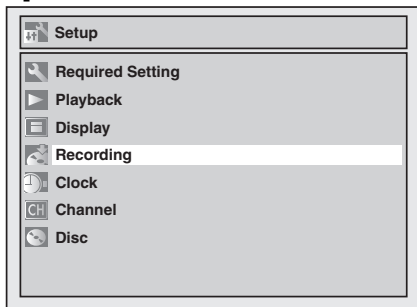

Recording menu will appear.

- 3) Select "External Input Audio" using [▲ / ▼], then press [ENTER].

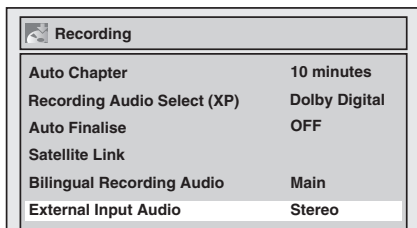

- 4) Select "Stereo" or "Bilingual" using [▲ / ▼], then press [ENTER].

"Stereo" is selected as a default.

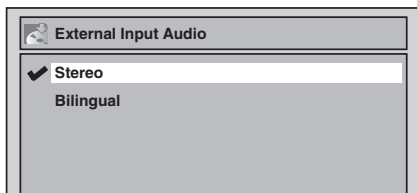

- 5) Press [SETUP] to exit.

## Notes

- If you select "Stereo":  
The audio will be recorded as "stereo audio".
- If you select "Bilingual":  
The audio will be recorded as "bilingual audio" (see "Setting Bilingual Recording Audio" for more detail).

## Setting Bilingual Recording Audio

DVD-RW VIDEO | DVD-R

You can select either "Main" or "Sub" audio to record a bilingual broadcast in Video mode.

- 1) In stop mode, press [SETUP].
- 2) Select "Recording" using [▲ / ▼], then press [ENTER].
- 3) Select "Bilingual Recording Audio" using [▲ / ▼], then press [ENTER].
- 4) Select "Main" or "Sub" using [▲ / ▼], then press [ENTER].

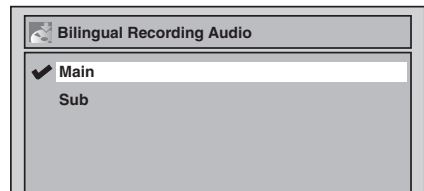

- 5) Press [SETUP] to exit.

## Note

- If you are recording onto a VR mode disc, both "Main" and "Sub" will be recorded regardless of your setting here. And when you play back, you can choose either audio format or a combination of both as your playback audio.

# Basic recording

DVD-RW VIDEO

DVD-RW VR

DVD-R



Follow the steps below to record a TV programme.

- 1** Press [I/O ON/STANDBY] to turn on the unit.  
Turn on the TV and be sure to select the input to which the unit is connected.
- 2** Press [OPEN/CLOSE ▲] to open the disc tray.
- 3** Place the disc on the disc tray with its label facing up. Be sure to align the disc with the disc tray guide.

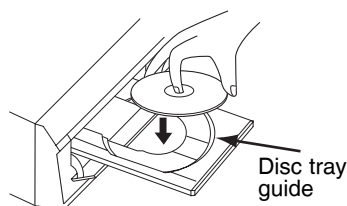

- 4** Press [OPEN/CLOSE ▲] to close the disc tray.  
This operation may take awhile to be completed.

- 5** Select the recording mode using [REC MODE].  
Refer to "Recording Mode" on page 36.

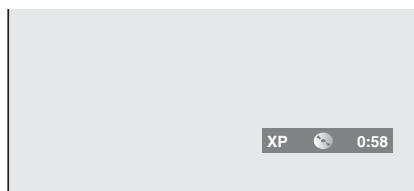

(Continued)



**6** Select the desired channel to record using [PROG.  $\wedge/\vee$ ] or [the Number buttons].

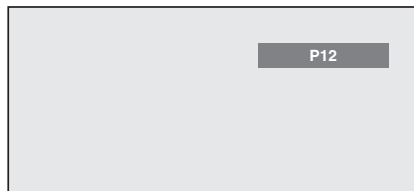

**7** Press [REC ●] to start recording.  
The "●" mark will be displayed for 5 seconds.

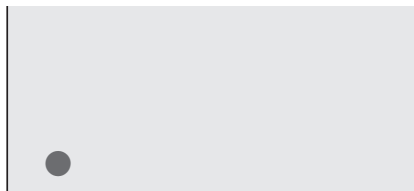

To pause the recording, press [PAUSE ■]. Press [PAUSE ■] or [REC ●] again to resume recording.

**8** Press [STOP ■] to stop the recording.

This operation may take awhile to be completed.

#### Notes

- You can change the channel while in the REC pause mode.
- Recording starts immediately and continues until the disc is full or you stop recording.
- If the clock is not set, the date and time space next to title names in the Original or Playlist will be blank.
- You cannot change the recording mode while in the REC or REC pause mode.
- It is possible to record video only in the PAL system.
- If you want to monitor the programme that you are recording, make sure the device such as a set top box is turned off when it is connected to AV2.

# One-touch Timer Recording

DVD-RW VIDEO

DVD-RW VR

DVD-R



This is a simple way to set the recording time in blocks of 30 minutes. Check that the disc you are recording onto has enough space remaining for the time you set.

- 1 Turn on the unit and insert a recordable disc.**  
Make sure that the TV input is set on the unit.

This operation may take awhile to be completed.

- 2 Select the recording mode using [REC MODE].**  
Refer to "Recording Mode" on page 36.

- 3 Select the desired channel to be recorded using [PROG. ^/∨] or [the Number buttons].**

(Continued)



# 4 Press [REC ●] repeatedly until the desired recording time (30 minutes to 8 hours) appears on the TV screen.

One-touch Timer Recording will start.

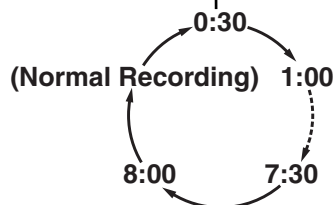
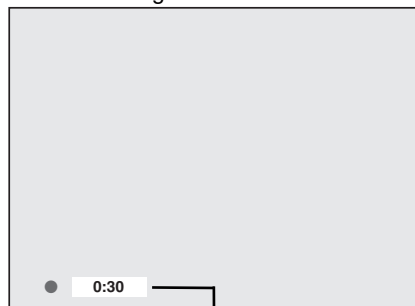

When the unit reaches the specified time, "Writing to Disc" will appear. It may take awhile to write the data onto a disc and then it will be turned off automatically.

To change the recording length during the One-touch Timer Recording, press [REC ●] repeatedly until the desired length appears.

To cancel the One-touch Timer Recording within the specified time, press [STOP ■].

**"Wait for a moment." will appear and this operation may take awhile to be completed.**

## Notes

- The remaining recording time will appear on the TV screen during One-touch Timer Recording. Press [DISPLAY] to see it on the TV screen.
- The remaining recording time will be displayed on the front panel display during One-touch Timer Recording.
- Unlike the timer recording, you can perform the following operations during One-touch Timer Recording.
  - Turn off the power.
  - Use [REC ●] or [STOP ■].
- You cannot use the pause function during One-touch Timer Recording.
- The unit will be turned off automatically under the following conditions.
  - No space remains on the disc.
  - If a power failure occurs.
- When One-touch Timer Recording is finished and the power is turned off, the unit will switch to the timer-standby mode automatically if a timer recording has been programmed. Press [I/O ON/STANDBY] to cancel the timer-standby mode to use the unit continuously.
- If you want to monitor the programme that you are recording, make sure the device such as a set top box is turned off when it is connected to AV2.

# Timer Recording

DVD-RW VIDEO

DVD-RW VR

DVD-R



You can set the unit to record up to 8 programmes, up to a month in advance. Daily or weekly programme recordings are also available.

- Be sure to set the clock before entering a timer programming.
- Insert a recordable disc.

**1** Insert a recordable disc.  
In stop mode, press [TIMER PROG.].  
Timer Programming list will appear.

Timer Programming						
	Date	Start	End	CH	Mode	PDC
1.	---					
2.	---					
3.	---					
4.	---					
5.	---					
6.	---					
7.	---					
8.	---					

**2** Select a programme using [▲ / ▼], then press [ENTER].

(Continued)



### 3 Enter the date using [▲ / ▼], then press [▶].

Timer Programming						
	Date	Start	End	CH	Mode	PDC
1.	01/01	--:--	--:--	AV1		
2.	---					
3.	---					
4.	---					
5.	---					
6.	---					
7.	---					
8.	---					

Each time you press [▼] at the current date, the timer recording date will change as follows.

<e.g. 1st January>

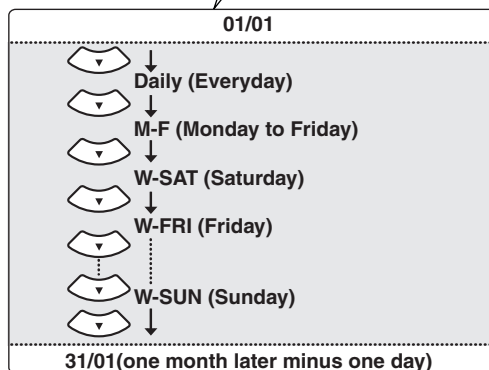

### 4 Enter the time to start and to end using [▲ / ▼], then press [▶].

Timer Programming						
	Date	Start	End	CH	Mode	PDC
1.	01/01	12:57	--:--	AV1		
2.	---					
3.	---					
4.	---					
5.	---					
6.	---					
7.	---					
8.	---					





## 5 Select the channel number to record using [▲ / ▼], then press [▶].

Timer Programming						
	Date	Start	End	CH	Mode	PDC
1.	01/01	12:57	1:57	P08		
2.	---					
3.	---					
4.	---					
5.	---					
6.	---					
7.	---					
8.	---					

To record from the external input, select “AV1”, “AV2”, “AV3” or “AV4”.

## 6 Select the recording mode using [▲ / ▼], then press [▶].

Timer Programming						
	Date	Start	End	CH	Mode	PDC
1.	01/01	12:57	1:57	P08	SP	
2.	---					
3.	---					
4.	---					
5.	---					
6.	---					
7.	---					
8.	---					

Refer to “Recording Mode” on page 36.

## 7 Select PDC to “ON” or “OFF” using [▲ / ▼]. (See page 52.)

(Continued)



## 8 Press [ENTER] when all information required is entered.

Your programme setting is stored.

- To set another programme, repeat steps 2 to 8.
- To exit, press [TIMER PROG.].
- If the recording times of two or more programmes overlap, "Overlap" and overlapped programme numbers are displayed. (See pages 51-53.)

## 9 Press [I/O ON/STANDBY].

The  icon will appear on the front panel display and the unit is set to the timer-standby mode.



- Timer Recording will not work when the power is on.
- When power is on, programmes registered for recording in Timer Recording will be automatically cleared after the end time and date have passed.

**To stop timer recording in progress, press [STOP ■] on the front panel of the unit. [STOP ■] on the remote control is not effective.**

### Notes

- If you have not set the clock, the clock setting window will appear instead of the Timer Programming list at step 1. In this case, press [ENTER]. Then continue from step 4 in "Manual Clock Setting" on page 32 before programming the timer recording.
- Press [◀ / ▶] to move the cursor in the timer programming list.

## Checking, cancelling, or correcting the timer programming information

In the following example, No. 5 timer programming overlaps on No. 1 and No. 6 timer programmes. In such a case, you should correct the programme time to clear the overlap.

Timer Programming						
	Date	Start	End	CH	Mode	PDC
1.	01/01	12:00	13:00	AV3	XP	ON
2.	---					
3.	---					
4.	---					
Overlap No.1 6						
5.	01/01	12:30	14:00	P02	SP	OFF
6.	01/01	13:45	21:00	P12	SEP	OFF
7.	---					
8.	---					

- 1) Press [I/O ON/STANDBY] so that the  icon disappears from the front panel display.
- 2) Press [TIMER PROG.].  
Timer Programming list will appear.
- 3) Check the information on the list to be edited.
- 4) To clear the timer programming, select the desired programme using [▲ / ▼], then press [CLEAR].

### To correct the timer programming

- 1) Select the desired programme using [▲ / ▼], then press [ENTER].
  - 2) Correct the timer programming using [▲ / ▼ / ◀ / ▶].
  - 3) Press [ENTER] again.
- 5) Press [TIMER PROG.] to exit.
  - 6) Press [I/O ON/STANDBY] to return to the timer standby mode.

### Note

- If a timer recording is proceeding, that programme is highlighted in red. In such a case, you cannot select any other programmes.

## If the timer programming did not complete correctly

The error number appears on the Timer Programming list.

Timer Programming						
	Date	Start	End	CH	Mode	PDC
*	01/01	12:57	1:57	P08	E22	ON
2.	---					
3.	---					
4.	---					
5.	---					
6.	---					
7.	---					
8.	---					

The error programme will be displayed in grey with an asterisk and have an error number.

### The error numbers indicate:

- E1–E22, E37–E39: Recording error
  - E23–E24: Unrecordable disc
  - E25:
    - Copy prohibited programme
    - Cannot record because of the NTSC / PAL-60 signal is received.
  - E26–E28: Copy prohibited programme
  - E29: Disc protected
  - E30: Disc full
  - E31: Already recorded 99 titles (Video mode)
  - E32: Already recorded 99 titles (VR mode)
  - E33: Already recorded 999 chapters
  - E34: No space for Control Information
  - E35: PCA (Power Calibration Area) full
  - E36: Already finalised Video format disc
  - E40:
    - There are some unrecorded parts due the overlapped timer programmes.
    - Recording did not start at the start time.
  - E41: Power failure
  - E42: No disc
- The error programme will be deleted once you check the error in the programme list, or once you cancel the timer-standby mode and re-enter it.





Press [CLEAR] to erase the selected programme.

## PDC (Programme Delivery Control)

Programme Delivery Control (PDC) assures that the TV programmes you have programmed for timer recording are recorded exactly from beginning to end, even if the actual broadcasting time differs from the scheduled time due to a delayed start or extension of the programme duration. Furthermore, if a programme is interrupted, the recording will also be interrupted automatically and resumed when the programme starts again.

If the PDC signal drops out because the broadcast signal is weak, or if a broadcasting station does not transmit a regular PDC signal, the timer recording is performed in normal mode (without PDC) even if it was programmed for PDC. If the starting time of the PDC timer recording is between 0:00 and 3:59 on a given day, the PDC function will operate from 20:00 on the previous day to 4:00 on the next day. If the starting time of the PDC timer recording is between 4:00 and 23:59 on a given day, the PDC function will operate from 0:00 on the given day to 4:00 on the next day. This means that if the relevant programme is broadcasted within this period, it is recorded correctly. If the timer is not programmed correctly, the incorrect timer setting stays in effect unless you cancel it. To cancel an incorrect timer setting, refer to "Checking, cancelling, or correcting the timer programming information" on page 51.

## Hints for Timer Recording

- If there is a power failure or the unit is unplugged for more than 30 seconds, the clock setting and all timer settings will be lost.
- If there is no disc or an unrecordable disc in the tray, the  icon will flash and timer recording will not occur. Insert a recordable disc.
- When all timer recordings are complete, the  icon flashes. To play back or eject the recorded disc, press [1/⏻ ON/STANDBY], and then press [PLAY ▶] or [OPEN/CLOSE ▲].
- During timer recording or timer-standby mode (  icon appears on the front panel display), no operations on the unit are available. To make operations available, cancel the timer recording or timer-standby mode (  icon disappears).
- To cancel the timer-standby mode, press [1/⏻ ON/STANDBY].
- If the Start and End times are same, the length of the recording will be set for 24 hours. If the disc becomes full during recording, the unit will turn itself off.
- If two or more programmes overlap, "Overlap" and the overlapped programme number will appear on the display.
- If the Start time is earlier and the End time is later than the current time, the recording will start immediately after you turn the power off.

### ■ The priority of overlapped settings

The unit records programmes according to priority if the timer programmes overlap.

#### ■ If the starting time is same:

- The timer programming set first (PROG. 1) has priority.

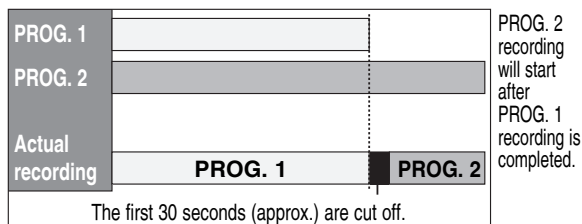

#### ■ If programming has been made at the end of the programming (PROG. 1) currently being recorded:

- The timer programming set first (PROG. 2) has priority. PROG. 3 will not be recorded.

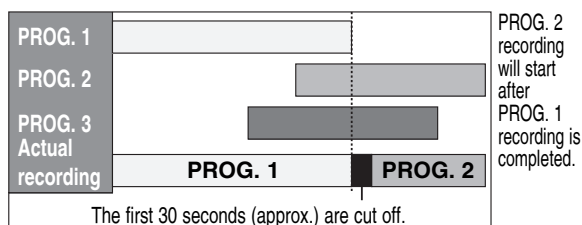

### ■ If the recording time is partially overlapped:

- The timer programming with the earlier start time (PROG. 2) has priority. PROG. 1 will start after PROG. 2 recording is complete.

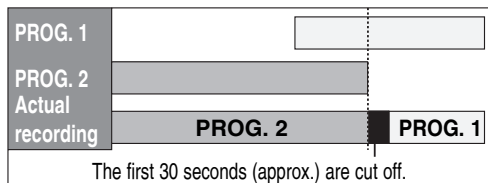

### ■ If the recording time entirely overlaps:

- The shorter timer programming (PROG. 1) is not recorded.

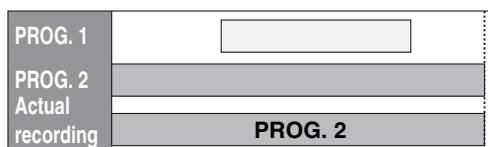

### ■ Note for DVD recording

- If the recording time of two programmes overlap, or the End time of a programme and the Start time of another is same, the first 30 seconds (approx.) of the subsequent programme are cut off.

### ■ If the End time of the programme currently being recorded and the Start time of the subsequent programme are same:

- If PROG. 1 is a DVD recorded programme, the beginning of PROG. 2 may be cut off.

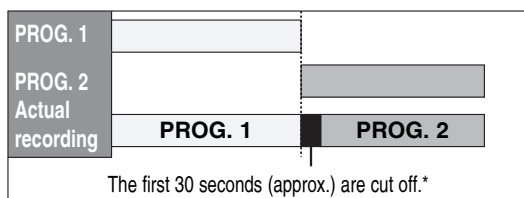

\* If the cut off time exceeds 1 minute, the error number "E40" will appear in the Timer Programming list.

## Satellite Link

You can set the unit to start recording whenever it detects the scart control signal from the external tuner.

### Preparing for the Satellite Link Timer Recording:

#### [Preparation of your set top box]

- The external tuner should be equipped with some kind of timer function. Using timer function of the tuner, set it to be turned on when it comes to the time you want to start recording, and off when it comes to the time you want to finish recording. (Refer to the tuner's manual on how to set the timer.)
- Make sure to turn off the set top box when you finish setting.

#### [Preparation on this unit]

- Make sure to select the desired Recording mode beforehand.

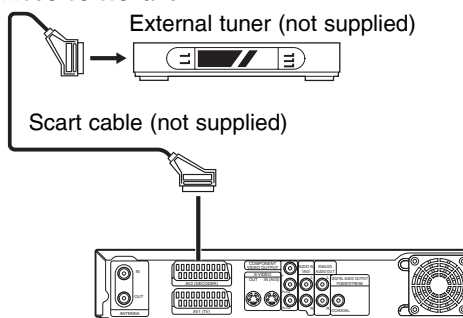

1) Press [SETUP].

2) Select "Recording" using [▲ / ▼], then press [ENTER].

3) Select "Satellite Link" using [▲ / ▼], then press [ENTER].

Satellite Link window will appear.

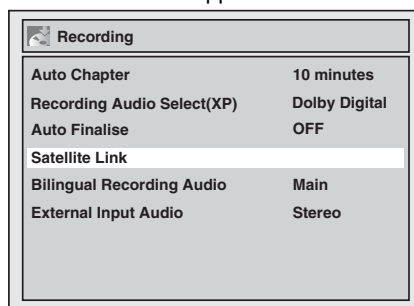

Timer Recording (cont'd)

4) With start time and the recording mode highlighted, press [ENTER].

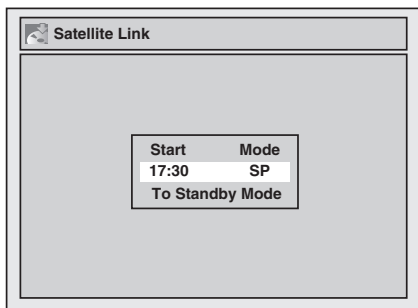

5) Set the desired start time using [▲ / ▼ / ◀ / ▶].

- Change the value for the hour using [▲ / ▼], then confirm with [▶].
- Change the value for the minute using [▲ / ▼], then confirm with [▶].
- The hour can be selected between 0 to 23.
- If you wish to go back to the left, press [◀].

6) Select the desired recording mode using [▲ / ▼], then press [ENTER].

See page 36 for details.

7) With “To Standby Mode” highlighted, press [ENTER] again.

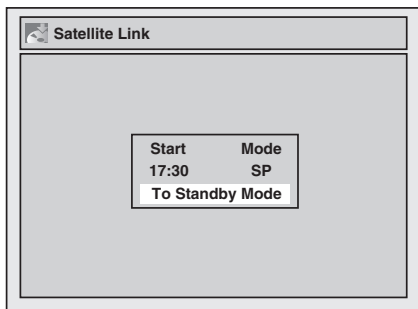

In a second, the unit will be turned off automatically as it goes into the Satellite Link standby mode.

- Until the time you set in “Start”, the clock will appear on the front panel display.
- “sat” will appear on the front panel display at the start time.



**To cancel the Satellite Link function while in the Satellite Link standby mode:**

Press [I/O ON/STANDBY] to turn on the unit.

**To cancel the Satellite Link function while the Satellite Link Timer Recording is in progress:**

Press [STOP ■] on the front panel of the unit.

**Notes**

- If you have not set the clock, the clock setting window will appear at step 3. Follow step 3 in “Manual Clock Setting” on page 31.
- You cannot set the End time for the Satellite Link Timer Recording on this unit.
- Recording picture will be distorted if the copy protection signal is being detected during Satellite Link Timer Recording.
- When a regular Timer Recording and the Satellite Link Timer Recording are overlapped:

	Example 1
Timer Recording Satellite Link	
Actual Recording	

	Example 2
Timer Recording Satellite Link	
Actual Recording	

	Example 3
Timer Recording Satellite Link	
Actual Recording	

# Settings for an external equipment

## Connection to an external equipment

DVD-RW VIDEO | DVD-RW VR | DVD-R

Connect the external equipment using either the input jacks, AV1, AV2, AV3 (Rear) or AV4 (Front). However, for AV4 jacks, you have to select S-VIDEO input or VIDEO input jack depending on the connected devices. Use a commercially available Scart, S-Video or Video cable and an Audio cable for this connection.



**1** In stop mode, press [SETUP].

**2** Select “Required Setting” using [▲ / ▼], then press [ENTER].

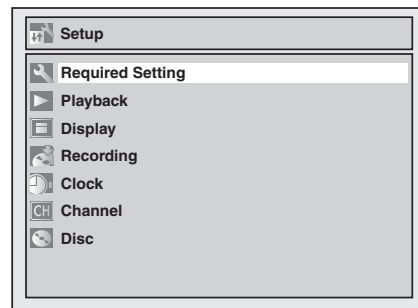

Required Setting menu will appear.

**3** Select “Select Video” using [▲ / ▼], then press [ENTER].

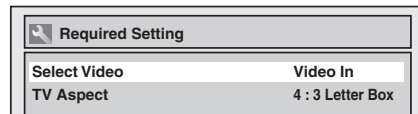

**4** Select the input jack type to be used using [▲ / ▼], then press [ENTER].

<e.g. AV4 (Front)>

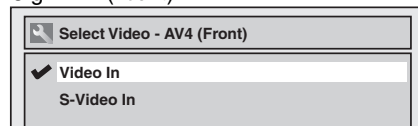

- If you want to use VIDEO input jack (Composite), select “Video In”.
- If you want to use S-VIDEO input jack, select “S-Video In”.

**5** Press [SETUP] to exit.

## Recording from an external equipment

DVD-RW VIDEO

DVD-RW VR

DVD-R



Before recording from external equipment, see page 25 for connection instructions.

**1** Turn the TV and the unit on, and select the input of the TV to which the unit is connected.

**2** Press [OPEN/CLOSE ▲] to open the disc tray, then place the disc to record on.

**3** Press [OPEN/CLOSE ▲] to close the disc tray.

This operation may take awhile to be completed.

**4** Select the input terminal to which the external equipment (AV1, AV2, AV3 or AV4) is connected using [PROG. ▲/▼] or [the Number Buttons].

- To use the input jacks on the back of the unit, select the "AV1", "AV2" or "AV3" position by pressing [0], [0], [1] or [0], [0], [2] or [0], [0], [3] on the remote control or using [PROG. ▼/▲].
- To use the input jacks on the front of this unit, select "AV4" position by pressing [0], [0], [4] on the remote control or using [PROG. ▼/▲].

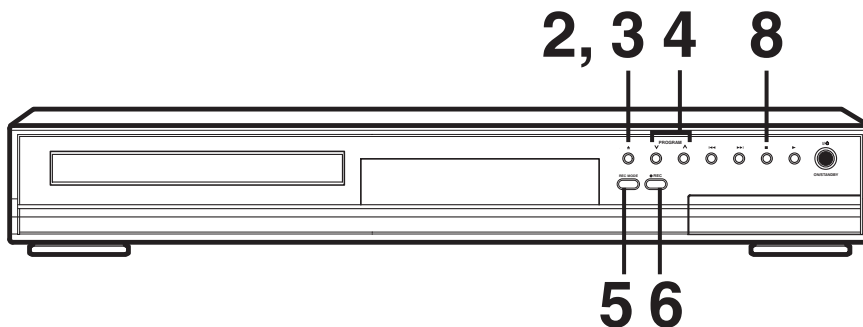





**5** Select a recording mode using [REC MODE].  
(See page 36.)

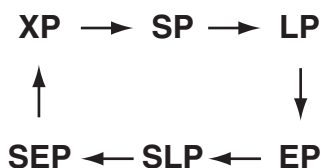

**6** Press [REC ●] on the unit to start recording.

**7** Press the PLAY button on the external recording component.

**8** Press [STOP ■] on the front panel of the unit to stop recording.

This operation may take awhile to be completed.

#### Note

- During recording, if a signal other than PAL is detected (such as NTSC), recording is paused.
- If you want to monitor the programme that you are recording, make sure the device such as a set top box is turned off when it is connected to AV2.

# Setting disc protection

DVD-RW VR



To prevent accidental over-recording, editing or erasing of recordings, you can protect them using the Setup menu.

**1** Insert a recordable disc.  
In stop mode, press [SETUP].

**2** Select “Disc” using [▲ / ▼], then press [ENTER].  
Disc menu will appear.

**3** Select “Disc Protect OFF ➔ ON” using [▲ / ▼], then press [ENTER].

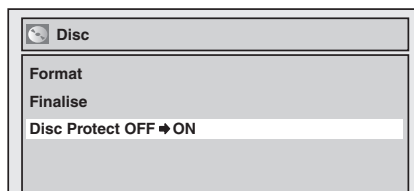

Confirmation window will appear.

**4** Select “Yes” using [▲ / ▼], then press [ENTER].  
The disc is protected.

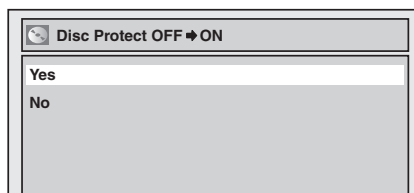

## Notes

- The Disc Protect setting is available only when a disc recorded in VR mode is inserted.
- You can select only “Disc Protect ON ➔ OFF” when a protected disc is inserted.

### To cancel the disc protection:

- Select “Disc Protect ON ➔ OFF” at step 3, then select “Yes”.
- If you insert a disc protected with this unit, “Disc Protect ON ➔ OFF” will appear instead of “OFF ➔ ON”.

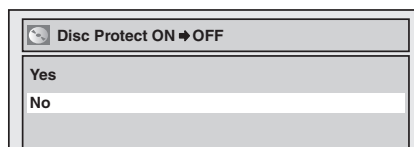

# Finalising discs

DVD-RW VIDEO

DVD-RW VR

DVD-R



You will need to finalise discs to play them back in other players.

Finalising may take from several minutes up to an hour. (A disc recorded in Video mode can take up to 15 minutes. A disc recorded in VR mode can take up to 60 minutes.)

A shorter recording period on the disc will require a longer time period for finalisation. Do not unplug the mains cable during finalisation.

**1** Insert a recordable disc before finalising. In stop mode, press [SETUP].

**2** Select “Disc” using [▲ / ▼], then press [ENTER].  
Disc menu will appear.

**3** Select “Finalise” using [▲ / ▼], then press [ENTER].

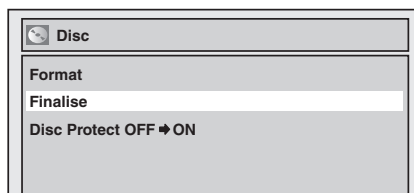

Confirmation window will appear.

(Continued)



**4** Select “Yes” using [ $\blacktriangle$  /  $\blacktriangledown$ ], then press [ENTER].

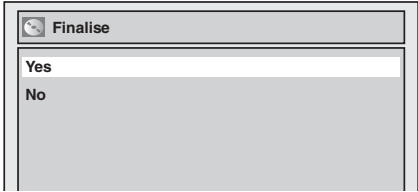

Finalise will start.

**5** Finalising is complete.

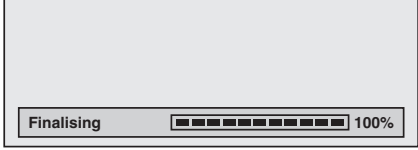
**To cancel finalising (DVD-RW only):**

- After step 4, press [STOP ■]. Select “Yes” using [ $\blacktriangleleft$  /  $\blacktriangleright$ ] and then press [ENTER]. Finalising is canceled and the unit switches to stop mode.
- If  $\odot$  appears when [STOP ■] is pressed, you cannot cancel finalising because the finalising has already reached at a critical point in its process.
- If “No” is selected and [ENTER] or [RETURN] is pressed, finalising is continued.
- You cannot cancel finalising a DVD-R disc once it has started.

**Notes**

- Finalising a disc in Video mode automatically creates a Title menu.
- You can use the unit to record or edit a disc recorded in VR mode even after it is finalised. After you finalise a disc recorded in Video mode, you cannot edit or record anything else on that disc.
- To undo the finalisation of the disc, select “Undo Finalise” at step 3.
- If you insert a DVD-RW disc finalised with this unit, “Undo Finalise” will appear instead of “Finalise”.
- DO NOT power off during finalising. This may result in a malfunction.

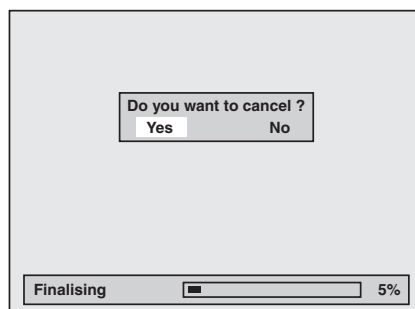

**This operation may take awhile to be completed.**

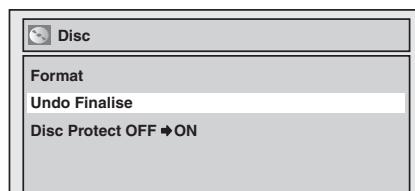

## Auto finalise

DVD-RW VIDEO | DVD-R



You can finalise discs automatically when the disc space runs out if you set this in the Setup menu.

**1** In stop mode, press [SETUP].

**2** Select “Recording” using [▲ / ▼], then press [ENTER].  
Recording menu will appear.

**3** Select “Auto Finalise” using [▲ / ▼], then press [ENTER].

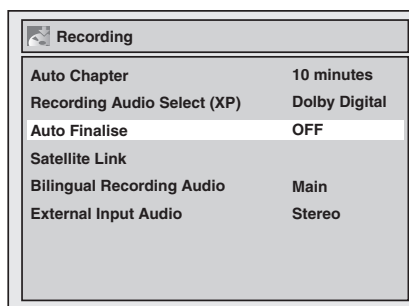

Auto Finalise menu will appear.

**4** Select “ON” using [▲ / ▼], then press [ENTER].  
Your setting will be activated.

**5** Press [SETUP] to exit.

### Note

- Auto finalise function is not available for discs formatted in VR mode.



## Symbols in this Section

The following icons show the playable discs for each function described on this section.

**DVD-RW VIDEO** : Video mode DVD-RW disc

**DVD-RW VR** : VR mode DVD-RW disc

**DVD-VIDEO** : DVD-Video disc

**DVD-R** : DVD-R disc

**CD** : Audio CD

**MP3** : CD-R/RW discs with MP3 files

**JPEG** : CD-R/RW discs with JPEG files

**VCD** : Video CD

**VCD PBC OFF** : Video CD without PBC

Most instructions are based on remote control operation, unless otherwise noted. You can use the buttons on the remote control as well as those on the main unit when they have the same function.

# Playback

Play your favourite contents.

- **Basic playback**
- **Further playback**
- **Special playback**
- **Selecting the format of audio and video**

# Basic playback

## Playing back a DVD-RW / DVD-R

DVD-RW VR

DVD-RW VIDEO

DVD-R



**1** Press [I/O ON/STANDBY] to turn on the unit.  
Turn on the TV and be sure to select the input to which the unit is connected.

**2** Press [OPEN/CLOSE ▲] to open the disc tray.

**3** Place the disc on the disc tray with its label facing up. Be sure to align the disc with the disc tray guide.

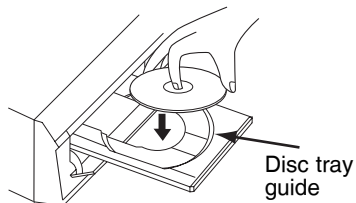

**4** Press [OPEN/CLOSE ▲] to close the disc tray.

This operation may take awhile to be completed.





## 5 Press [TOP MENU] to display the Title menu.

You can switch between the “Original” and “Playlist” in the VR mode using [MENU / LIST].

<Video mode>

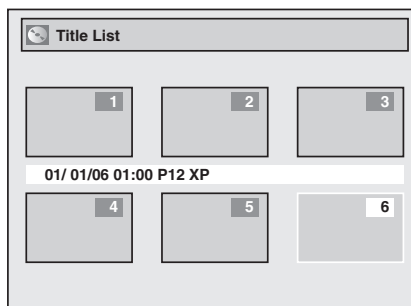

<VR mode>

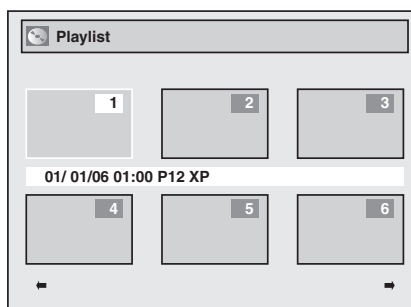

↕ [MENU / LIST]

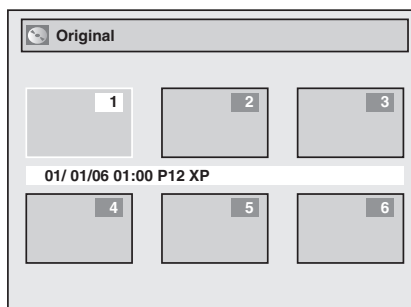

Press [TOP MENU] to resume play.

To exit the Title menu, press [STOP ■] or [RETURN].

(Continued)

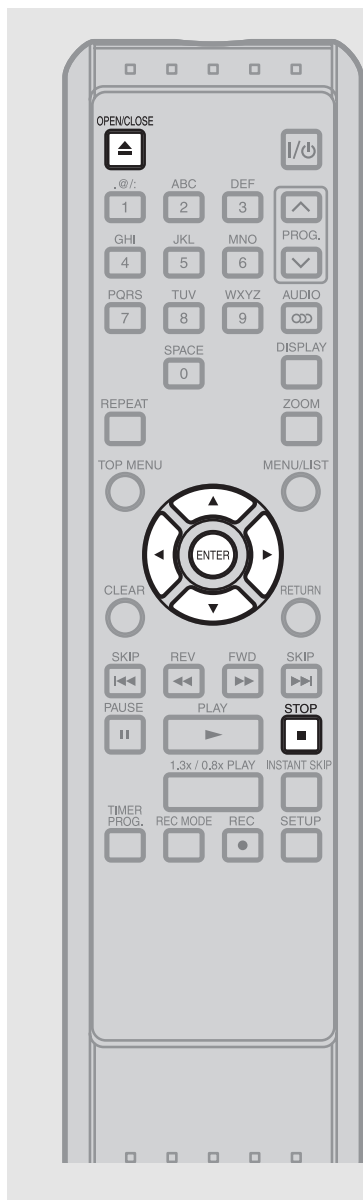

**6** Select the desired title using [**▲** / **▼**/**◀**/**▶**], then press [**ENTER**].

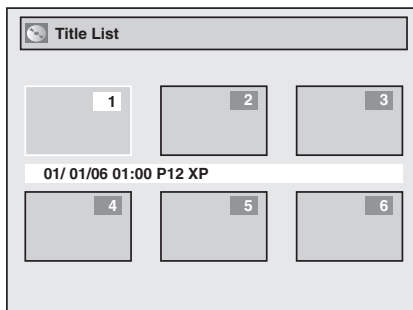

Pop-up window will appear.

**7** Select "Play" using [**▲** / **▼**], then press [**ENTER**].  
Playback will start.

**8** Press [**STOP ■**] to stop playback.  
To eject the disc, press [**OPEN / CLOSE ▲**] to open the disc tray, then remove the disc.  
Press [**OPEN / CLOSE ▲**] to close the disc tray before turning off the unit.

**Notes**

- For DVD-R (Video mode) and DVD-RW (Video mode) discs that are already finalised, a title list will be displayed instead of thumbnails.
- If you insert a DVD-RW recorded in VR mode and it has a Playlist, the Playlist is displayed.
- You can resume playback from where you stopped playing back the disc (Resume playback). See page 72 for details.
- You can also start playback by pressing [**PLAY ▶**] instead of [**ENTER**] at step 6.
- Some discs may start playback automatically.

Title Menu				
1	22/01/06	12:55	P10	XP
2	30/01/06	11:00	P8	XP
3	10/02/06	13:00	P10	LP
4	28/02/06	11:00	P6	LP
5	28/02/06	10:00	P8	EP

## Playing back a DVD-VIDEO / Video CD / CD

DVD-VIDEO

CD

VCD



**1** Press [**I/ON ON/STANDBY**] to turn on the unit.  
Turn on the TV and be sure to select the input to which the unit is connected.

**2** Press [**OPEN/CLOSE ▲**] to open the disc tray.

**3** Place the disc on the disc tray with its label facing up. Be sure to align the disc with the disc tray guide.  
Press [**OPEN / CLOSE ▲**] to close the disc tray.

**4** Press [**PLAY ►**] to start playback.  
Playback will start.  
If you are playing back a DVD-Video or a Video CD, a menu may appear.  
See pages 70-71 for details.

**5** Press [**STOP ■**] to stop playback.

### Note

- Some discs may start playback automatically.

## Free Manuals Download Website

<http://myh66.com>

<http://usermanuals.us>

<http://www.somanuals.com>

<http://www.4manuals.cc>

<http://www.manual-lib.com>

<http://www.404manual.com>

<http://www.luxmanual.com>

<http://aubethermostatmanual.com>

Golf course search by state

<http://golfingnear.com>

Email search by domain

<http://emailbydomain.com>

Auto manuals search

<http://auto.somanuals.com>

TV manuals search

<http://tv.somanuals.com>