

TOSHIBA



DVD RECORDER-VCR

D-VR3SG

OWNER'S MANUAL



Read this booklet first.

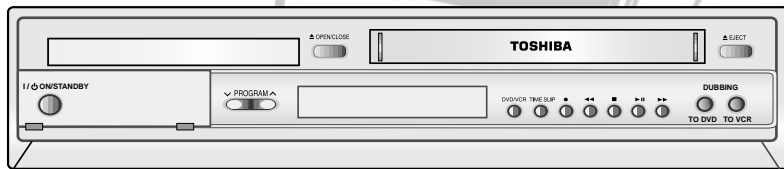

© 2004 Toshiba Corporation

Warning

TO REDUCE THE RISK OF ELECTRIC SHOCK, DO NOT REMOVE THE COVER(OR BACK). NO USER-SERVICEABLE PARTS ARE INSIDE. REFER SERVICING TO QUALIFIED SERVICE PERSONNEL.

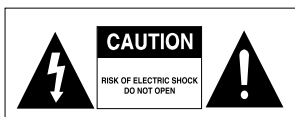

This symbol indicates "dangerous voltage" inside the product that presents a risk of electric shock or personal injury.



This symbol indicates important instructions accompanying the product.

Do not install this equipment in a confined space such as a bookcase or similar unit.

WARNING : To prevent damage which may result in fire or electric shock hazard, do not expose this appliance to rain or moisture.

CAUTION : DVD Recorder-VCRS USE AN INVISIBLE LASER BEAM WHICH CAN CAUSE HAZARDOUS RADIATION EXPOSURE IF DIRECTED. BE SURE TO OPERATE RECORDER CORRECTLY AS INSTRUCTED.

CAUTION
THIS PRODUCT UTILIZES A LASER.
USE OF CONTROLS OR ADJUSTMENTS OR PERFORMANCE OF PROCEDURES OTHER THAN THOSE SPECIFIED HEREIN MAY RESULT IN HAZARDOUS RADIATION EXPOSURE.
DO NOT OPEN COVERS AND DO NOT REPAIR YOUR-SELF. REFER SERVICING TO QUALIFIED PERSONNEL.

CAUTIONS

Caution: To prevent electric shock, match wide blade of plug to wide slot, fully insert.

Attention: Pour éviter les chocs électriques, introduire la lame la plus large de la fiche dans la borne correspondante de la prise et pousser jusqu'au fond.

This product satisfies FCC regulations when shielded cables and connectors are used to connect the unit to other equipment. To prevent electromagnetic interference with electric appliances, such as radios and televisions, use shielded cables and connectors for connections.

IMPORTANT NOTE

The mains lead on this equipment is supplied with a moulded plug incorporating a fuse. The value of the fuse is indicated on the pin face of the plug. If it requires replacing, a fuse approved to BS1362 of the same rating must be used.

Never use the plug with the fuse cover omitted if the cover is detachable. If a replacement fuse cover is required, it must be of the same colour as the pin face of the plug. Replacement covers are available from your dealer.

If the fitted plug is not suitable for the power points in your house or the cable is not long enough to reach a power point, you should obtain a suitable safety approved extension lead or consult your dealer for assistance.

However, if there is no alternative to cutting off the plug, remove the fuse and then safely dispose of the plug. Do not connect the plug to a mains socket, as there is a risk of shock hazard from the bared flexible cord.

- It is permissible to record television programs, film, video tapes and other material only in the event that third party copyrights and other rights are not violated.
- It is prohibited by law to copy, broadcast, show, broadcast on cable, play in public, and rent copyrighted material without permission.
- Some DVD video discs are copy protected, and any recordings made from these discs will be distorted.
- Toshiba is not liable for any damage caused by fires, natural disaster (such as thunder, earthquake, etc...) acts by third parties, accidents, owner's intentional or unintentional misuse, or uses in other improper conditions.
- Toshiba is not liable for incidental damages (such as profit loss or interruption in business, modification or erasure of recorded data, etc.) caused by use or inability to use of this product.
- Toshiba is not liable for any damage caused by neglect of the instructions described in the owner's manual.
- Toshiba is not liable for any damage caused by misuse malfunction through simultaneous use of this product and the connected equipment or software that Toshiba is not concerned with.
- Toshiba does not compensate for contents which were not recorded/edited because of some malfunctions of this product or discs during operation, and is not liable for incidental damages (such as profit loss or interruption in business, etc.) produced by such conditions.

The product unit accompanying this user manual is licensed under certain intellectual property rights of certain third parties. This license is limited to private non-commercial use by end-user consumers for licensed contents. No rights are granted for commercial use. The license does not cover any product unit other than this product unit and the license does not extend to any unlicensed product unit or process conforming to ISO/IEC 11172-3 or ISO/IEC 13818-3 used or sold in combination with this product unit. The license only covers the use of this product unit to encode and/or decode audio files conforming to the ISO/IEC 11172-3 or ISO/IEC 13818-3. No rights are granted under this license for product features or functions that do not conform to the ISO/IEC 11172-3 or ISO/IEC 13818-3.

DANGER	- VISIBLE AND INVISIBLE LASER RADIATION WHEN OPEN. AVOID DIRECT EXPOSURE TO BEAM.
CAUTION	- VISIBLE AND INVISIBLE LASER RADIATION WHEN OPEN. AVOID EXPOSURE TO BEAM.
ATTENTION	- RAYONNEMENT LASER VISIBLE ET INVISIBLE EN CAS D'OUVERTURE. EXPOSITION DANGEREUSE AU FAISCEAU.
ADVARSEL	- SYNLIG OG USYNLIG LASERSTRÅLING VED ÅBNING. UNDGÅ UDSÆTTELSE FOR STRÅLING.
VARO !	- AVATTAESSA OLET ALTTIINA NÄKYVÄÄ JA NÄKYMÄTÖN LASERSÄTEILYLLÄ. ÄLÄ KATSO SÄTEESEEN.
VARNING	- SYNLIG OCH OSYNLIG LASERSTRÅLNING NÄR DENNA DEL ÄR ÖPPNAD. BETRÄKTA EJ STRÅLEN.
ADVARSEL	- SYNLIG OG USYNLIG LASERSTRÅLING NÄR DEKSEL ÅPNES. UNNGÅ EKSPONERING FOR STRÅLEN.
VORSICHT	- SICHTBARE UND UNSICHTBARE LASERSTRAHLUNG, WENN ABDECKUNG GEÖFFNET. NICHT DEM STRAHL AUSSETZEN.
注意	- 打开时有可见及不可见激光辐射。避免激光照射。
注意	- ここを開くと可視及び不可視のレーザー光が出ます。ビームを直接見たり、触れたりしないでください。

Precaution

Important Safety Instructions

CAUTION : PLEASE READ AND OBSERVE ALL WARNINGS AND INSTRUCTIONS GIVEN IN THIS OWNER'S MANUAL AND THOSE MARKED ON THE UNIT. RETAIN THIS BOOKLET FOR FUTURE REFERENCE.

This set has been designed and manufactured to assure personal safety. Improper use can result in electric shock or fire hazard. The safeguards incorporated in this unit will protect you if you observe the following procedures for installation, use and servicing. This unit is fully transistorized and does not contain any parts that can be repaired by the user. DO NOT REMOVE THE CABINET COVER, OR YOU MAY BE EXPOSED TO DANGEROUS VOLTAGE. REFER SERVICING TO QUALIFIED SERVICE PERSONNEL ONLY.

- 1) Read these instructions.
- 2) Keep these instructions.
- 3) Heed all warnings.
- 4) Follow all instructions.
- 5) Do not use this apparatus near water.
- 6) Clean only with dry cloth.
- 7) Do not block any ventilation openings, install in accordance with the manufacturer's instructions.
- 8) Do not install near any heat sources such as radiators, heat registers, stoves, or other apparatus (including amplifiers) that produce heat.
- 9) Do not defeat the safety purpose of the polarized or grounding-type plug. A polarized plug has two blades with one wider than the other. A grounding type plug has two blades and a third grounding prong. The wide

blade or the third prong are provided for your safety. If the provided plug does not fit into your outlet, consult an electrician for replacement of the obsolete outlet.

- 10) Protect the power cord from being walked on or pinched particularly at plugs, convenience receptacles, and the point where they exit from the apparatus.
- 11) Only use attachments/accessories specified by the manufacturer.
- 12) Use only with the cart, stand, tripod, bracket, or table specified by the manufacturer, or sold with the apparatus. When a cart is used, use caution when moving the cart/apparatus combination to avoid injury from tip-over.
- 13) Unplug this apparatus during lightning storms or when unused for long periods of time.
- 14) Refer all servicing to qualified service personnel. Servicing is required when the apparatus has been damaged in any way, such as power-supply cord or plug is damaged, liquid has been spilled or objects have fallen into the apparatus, the apparatus has been exposed to rain or moisture, does not operate normally, or has been dropped.
- 15) When you use headphones, keep the volume at a moderate level. If you use the headphones continuously with high volume sound, it may cause hearing damage.
- 16) Do not overload wall outlets : extension cords, or integral convenience receptacles as this can result in a risk of fire or electric shock.
- 17) Apparatus should not be exposed to dripping or splashing and no objects filled with liquids, such as vases, should be placed on the apparatus.
- 18) Keep your fingers well clear of the disc tray as it is closing. Neglecting to do so may cause serious personal injury.
- 19) Do not place a heavy object on or step on the apparatus. The object may fall, causing serious personal injury and serious damage to the apparatus.
- 20) Do not place the apparatus on amplifiers or equipment that may produce heat.
- 21) Do not cover the ventilating holes for the inside cooling fan.
- 22) Do not use a cracked, deformed, or repaired disc. These discs are easily broken and may cause serious personal injury and apparatus malfunction.
- 23) If the apparatus should smoke or smell, immediately disconnect the power cord from the wall outlet. Wait until the smoke or smell stops, then ask your dealer for a check and repair. Neglecting to do so may cause fire.
- 24) While it is thundering, do not touch the connecting cables or the apparatus.
- 25) The apparatus includes lead, an ingredient of solder human and the environment. When disposing of this apparatus, follow the rules and regulations in your area.

Handling Cautions

- Before connecting other components to this recorder, be sure to turn them all off.
- Do not move the recorder while a disc is being played, or the disc may be scratched or broken, and the recorder's internal parts may be damaged.
- Do not put a flower vase filled with water or any small metal objects on the recorder.
- Be careful not to put your hand into the disc tray.
- Do not place anything other than the disc in the disc tray.
- Exterior interference such as lightning and static electricity can affect normal operation of this recorder. If this occurs, turn the recorder off and on again with the ON/STANDBY button, or disconnect and then reconnect the AC power cord to the AC power outlet. The recorder will operate normally.
- Be sure to remove the disc and turn off the recorder after use.
- Disconnect the AC power cord from the AC outlet when you don't intend to use the recorder for long periods of time.
- Clean the disc by wiping in a straight line from the inside to the outside of the disc.

Maintenance of Cabinet

- For safety reasons, be sure to disconnect the AC power cord from the AC outlet.
- Do not use benzene, thinner, or other solvents for cleaning.
 - Wipe the cabinet with a soft cloth.

Disc Handling

- Use discs with regular shapes. If an irregular disc (a disc with a special shape) is used, this DVD Recorder-VCR may be damaged.

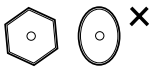

Holding discs

- Avoid touching the surface of a disc where recording is performed.



Cartridge

- This is used to prevent damage by dirt, scratches, etc. when using a DVD-RAM/DVD-RW/DVD-R disc.

DVD-RAM, DVD-RW and DVD-R

- Clean with an optional DVD-RAM/PD disc cleaner. Do not use cleaners or cloths for CDs to clean DVD-RAM/DVD-RW/DVD-R discs.



DVD-Video, CD

- Wipe off dirt or contamination on the disc with a soft cloth.

Cautions on handling discs

- Do not write on the printed side with a ball-point pen or pencil.
- Do not use record cleaning sprays or antistatic. Also, do not use volatile chemicals, such as benzene or thinner.
- Do not apply labels or stickers to discs. (Do not use discs fixed with exposed tape adhesive or leftover peeled-off stickers.)
- Do not use scratch-proof protectors or covers.
- Do not use discs printed with label printers available on the market.
- Do not load warped or cracked discs.

Disc Storage

Be careful not to harm the disc because the data on these discs is highly vulnerable to the environment.

- Do not keep under direct sunlight.
- Keep in a cool ventilated area.
- Store vertically.
- Keep in a clean protection jacket.
- If you move your DVD Recorder-VCR suddenly from a cold place to a warm place, condensation may generate on the operating parts and lens and cause abnormal disc playback. If this occurs, remove the disc and wait for one to two hours with the power on before attempting playback.

ShowView and PlusCode are registered trademarks of Gemstar Development Corporation. The ShowView system is manufactured under license from Gemstar Development Corporation.

Notes on recording and editing

- When you record/edit important content, make trial operations beforehand to confirm the recorder can function properly. Toshiba does not compensate for content which was not recorded/edited because of some malfunction of this product or discs during operation, and is not liable for incidental damages (such as profit loss or interruption of business, etc.) produced in such conditions.
- When the power cord is disconnected or when a power failure occurs during any operation of this product, all contents recorded in this recorder may be erased.
- Depending on the channel or program, an excessive sound. Adjust the initial setting of the recording level when necessary.
- If a program you have set a timer recording includes copy restriction signals, it may not be recorded. When programming a recording, confirm that a program you want to record is not copy-restricted.

Exemptions

- Toshiba is not liable for any damage caused by fires, natural disaster (such as thunder, earthquake, etc.), acts by third parties, accidents, owner's intentional or unintentional misuse, or uses in other improper conditions.
- Toshiba is not liable for incidental damages (such as profit loss or interruption in business, modification or erasure of recorded data, etc.) caused by use or inability to use of this product.
- Toshiba is not liable for any damage caused by neglect of the instructions described in the owner's manual.
- Toshiba is not liable for any damage caused by misuse or malfunction through simultaneous use of this product and the connected equipment or software that Toshiba is not concerned with.
- Toshiba does not compensate for contents which were not recorded/edited because of some malfunctions of this product or discs during operation, and is not liable for incidental damages (such as profit loss or interruption in business, etc.) produced by such conditions.

Power Outage

- After a power outage the clock display will flash. Set the clock to the correct time.

Notes on copyright

- It is prohibited law to copy, broadcast, show, broadcast on cable, play in public, and rent copyrighted material without permission.
- Some DVD video discs are copy protected, and any recordings made from these discs will be distorted.
- This product incorporates copyright protection technology that is protected by method claims of certain U.S. patents and other intellectual property rights owned by Macrovision Corporation and other rights owners. Use of this copyright protection technology must be authorized by Macrovision Corporation, and is intended for home and other limited viewing uses only unless otherwise authorized by Macrovision Corporation. Reverse engineering of disassembly is prohibited.
- This unit incorporates CPRM (Content Protection for Recording Media) technology for copyright protection. Recording and copying on this recorder depend on the contents as described next page.

Disc Specifications

DVD-Video

- A digital versatile disc (DVD) can contain up to 135-minutes of images, 8-language audio and 32 subtitle languages. It is equipped with MPEG-2 picture compression and Dolby 3D surround, allowing you to enjoy vivid and clear theater quality images in the comfort of your own home.
- When switching from the first layer to the second layer of a double-layered DVD Video disc, there may be momentary distortion in the image and sound. This is not a malfunction of the unit.
- Once a DVD-RW/DVD-R recorded in Video Mode is finalised, it becomes DVD-Video.

Audio CD

- An audio disc on which 44.1kHz PCM Audio is recorded.
- Plays CDDA format audio CD-R and CD-RW discs. This unit may not be able to play some CD-R or CD-RW discs due to the condition of the recording.

CD-R/RW

MP3 CD-R/RW

- Only CD-R discs with MP3 files recorded with ISO9660 or JOLIET format can be played back
- Only MP3 files with the ".mp3", and ".MP3" extension can be used.
- For MP3 files recorded with a VBR(Variable Bit Rates), from 32 Kbps to 320 Kbps, the sound may cut in out.
- Playable bitrate range is from 56Kbps to 320Kbps.
- The unit can handle a maximum of 1000 files and folders.

JPEG CD-R/RW

- Only JPEG files with the ".jpg", ".JPG" extension can be used.
- The unit can handle a maximum of 1000 files and folders.
- Maximum size of progressive JPEG is 3M pixels.
- MOTION JPEG is not supported.

Using CD-R/RW

- Use a 700MB(80 minutes) CD-R/RW disc. If possible, do not use a 800MB(90 minutes) or above disc, as the disc may not play back.
 - If the CD-R/RW disc was not recorded as a closed session, you may experience a delay in the early play-back time, and all recorded files may not play.
 - Some CD-R/RW discs may not be playable with this unit, depending on the device which was used to burn them.
- For contents recorded on CD-R/RW media from CDs for your personal use, playability may vary depending on contents and discs.

DVD-R Disc Playback and Recording

- Once a DVD-RW/DVD-R recorded in Video Mode is finalised, it becomes DVD-Video.
- You can record onto the available space on the disc and perform editing functions such as giving titles to discs and programs and erasing programs before finalising.
- When programming is erased from a DVD-R, that space does not become available. Once an area on a DVD-R is recorded on, that area is no longer available for recording, whether the recording is erased or not.

- It takes about 30 seconds for the unit to complete recording management information after recording finishes.
- This product optimizes the DVD-R for each recording. Optimizing is carried out when you start recording after inserting the disc or turn on the unit. Recording onto the disc may become impossible if optimizing is carried out too many times.
- Playback may be impossible in some cases due to the condition of recording.
- This unit can play back DVD-R discs recorded and finalised with a Toshiba DVD recorder. It may not be able to play some DVD-R discs depending on the disc and the condition of the recording.

DVD-RW Disc Playback and Recording

- Recording and playback can be performed on DVD-RW discs in both Video and VR Modes.
 - Once a DVD-RW recorded in VR Mode is finalised, you cannot perform additional recording.
 - Once a DVD-RW recorded in Video Mode is finalised, it becomes DVD-Video.
 - In both modes, playback can be performed before and after finalisation, but additional recording, deleting and editing can not be performed after finalisation.
 - If you want to record the disc in VR Mode and then record in V Mode, be sure to execute Format. Be careful when executing Format because all the recorded data may be lost.
 - A DVD-RW blank disc is initialized to VR Mode when first initialized.
- **DVD-RW (VR mode)**
 - This is a format that is used for recording data on a DVD-RAM or DVD-RW disc. You can repeat recording, editing, deleting, partial deletion, creation of playlist, and etc.
 - A disc that is recorded in this mode may not be played by existing DVD players.

- **DVD-RW (Video mode)**

- This is a format that is used for recording data on a DVD-RW or DVD-R disc. The disc can be played by an existing DVD player once it has been finalised.
- If a disc that has been recorded in Video mode by a different manufacturer's recorder but has not been finalised it cannot be played or additionally be recorded by this recorder.

DVD-RAM Disc Playback and Recording

- DVD-RAM discs come with or without a cartridge. For this product, we recommend DVD-RAM discs that come with cartridges.
- Some cartridges are able to eject the disc inside. Even if you are able to eject the disc, always use the disc with the cartridge to ensure correct operation.
- DVD-RAM discs have a Write Protect tab in order to avoid accidental erasure of recorded data. With the Write Protect tab set to PROTECT, you can play the disc, but recording or erasing will not work. Set the Write Protect tab to UNPROTECT to format the disc or erase data.
- Ensure that the recording mode is set to VR mode. Otherwise, this product will not be able to play the recording.
- You cannot play a DVD-RAM in most DVD players due to compatibility issues.
- Only DVD-RAM standard Version 2.0 discs can be played in this unit.
- DVD-RAM recorded on this unit may not work with other DVD Players. To determine compatibility with these DVD-RAM discs, refer to the user's manual for the player.
- This unit is compatible with both non-cartridge and cartridge DVD-RAM, but the write-protect tabs on cartridge-type discs give better protection to your recordings.

Protection

This DVD Recorder-VCR can allow you to protect the contents of your discs, as described below.

- **Cartridge-protected:** With the write-protect tab set in the protect position, the contents of the disc cannot be recorded, edited, or erased.
- **Program-protected:** See page 90 "Locking the title List Entry"
- **Disc-protected:** See page 101 "Disc Protection"

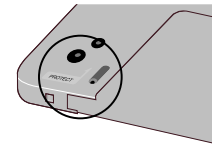

- * DVD-RAM/DVD-RW/DVD-R discs that are incompatible with the DVD-VIDEO format can not be played with this product.
- * For more information on recording a DVD, consult your DVD-RAM/DVD-RW/DVD-R manufacturer.
- * If poor quality DVD-RAM/DVD-RW/DVD-R discs are used, your recordings may fail.

Do not use the following discs!

- LD, CD-G, CD-I, CD-ROM, DVD-ROM, DVD+R and DVD+RW discs should not be used in this product. [Note] Disc types that can be played : CD/CD-R/CD-RW/MP3/JPEG/DVD-Video/DVD-RAM/ DVD-RW/ DVD-R. However, if your DVD-RW disc was recorded with another device, it can be played only if it was recorded and finalised in video mode.
- Some commercial discs and DVD discs purchased outside your region may not be playable with this product. When these discs are played, either "No disc." or "Please check the regional code." will be displayed.
- If your DVD-RW disc is an illegal copy or is not in DVD video format, it may also not be playable.

COPY PROTECTION

- Many DVD discs are encoded with copy protection. Because of this, you should only connect your DVD Recorder-VCR directly to your TV, not to a VCR. Connecting to a VCR results in a distorted picture from copy-protected DVD discs.
- This product incorporates copyright protection technology that is protected by methods claims of certain U.S. patents and other intellectual property rights owned by Macrovision Corporation and other rights owners. Use of this copyright protection technology must be authorized by Macrovision Corporation, and is intended for home and other limited viewing uses only unless otherwise authorized by Macrovision Corporation. Reverse engineering or disassembly is prohibited.
- It is permissible to record television programs, film, video tapes and other material only in the event that third party copyrights and other rights are not violated.

Contents



◆ Getting Started

Warning	2
Precaution	3
General Features	11
Before Reading the User's Manual	12
How to use the DVD Recorder-VCR	12
Description	14
Front Panel	14
Front Panel Display	14
Rear Panel	15
Tour of the Remote Control	16

◆ Connecting & Setting Up

Quick Overview	17
Unpacking	18
Accessories	18
Connecting DVD Recorder-VCR to the TV using the RF Cable	18
Connecting the Scart Cable	19
Connection DVD Recorder-VCR to the TV using the SCART Cable	19
Connecting DVD Recorder-VCR to a Satellite Receiver or Other Equipment	19
Connecting the Video Cable	20
Connecting to a video input jack	20
Connecting to an S-video input jack	21
Connecting the Audio Cable	21
Connecting to your TV	21
Connecting to a stereo amplifier with analog input jacks	22
Connecting to a an AV amplifier with the digital input jack	22
Connecting External Devices	23
Connecting a external devices to the AUX jacks	23
Connecting a Camcorder to the DV IN jack	23

Preparing the Remote Control	24
Setting the Remote Control	24

◆ System Setup

On-Screen Menu Navigation	26
Plug & Auto Setup	27
Setting the Date and Time	28
Presetting the Stations Automatically	29
Presetting the Stations Manually	30
Clearing a Preset Station	31
Changing the Preset Manual Setup Table	32
Selecting the RF OUT Sound Mode (B/G-F/K)	33
Setting the VCR Output Channel	34
Setting Up the Language Features	35
Audio	35
Subtitle	36
Disc Menu	37
On-Screen Menu	38
Setting Up the Audio Options	39
Digital Output	39
DTS	39
Dynamic Compression	39
Setting Up the Display(Video) Options	40
Display(Video) Options	40
Setting Up the Parental Control	41
About the Change Password;	42
VCR Setting	42
Intelligent Picture Control(IPC)	44
Selection the Colour Mode	45
Front Display	46
NICAM	47
AV1 Output	47

◆ Playback

*DVD Playback

Before Playing	48
Region code (DVD-Video only)	48
Disc types that can be played	48
Discs that cannot be played	49
Playing a Disc	49
Using the Search & Skip Functions	51
Searching through a Chapter or Track	51
Skipping Chapters or Tracks	51
Skipping ahead 30 seconds	51
Slow Motion Play / Step Motion Play	51
Slow Motion Play (DVD-VIDEO/DVD-RAM/DVD-RW/DVD-R)	51
Step Motion Play(DVD-VIDEO/DVD-RAM/DVD-RW/DVD-R)	52
About QUICK	52
DVD-VIDEO	52
DVD-RAM/DVD-RW	52
DVD-R	52
Repeat Play	53
Using Repeat Play(For DVD-VIDEO/DVD-RAM/DVD-RW/DVD-R)	53
Using Repeat Play (For Audio CD/MP3)	53
Using the A-B Repeat Function	54
For DVD-VIDEO/DVD-RAM/DVD-RW/DVD-R	54
To return to normal playback	54
Moving to a Scene Directly	54
Selecting the Subtitle & Audio Language	55
Selecting the subtitle language	55
Selecting the Audio language	56
Changing the Camera Angle	56
Using Bookmarks	56
Setting a book mark	57
Bookmarking with DVD-RAM/DVD-RW(VR) disc	57
Playing Back a Bookmark	57
Clearing a Bookmark	58
Zooming-In	58
Check Remaining Time	59
Using the Disc and Top Menu	59
For DVD-VIDEO disc	59
For DVD-RAM/DVD-RW/DVD-R disc	59

Playing Back an Audio CD (CDDA)	60
Audio CD (CDDA) Screen Elements	60
Play Option Mode	61
To change repeat mode	61
To Programme Tracks	62
Photo CD Playback	63
When using a combination MP3/JPEG disc	63
Playing back an MP3 CD	64
Buttons on the Remote Control	64
When using a combination MP3/JPEG disc	64
Using PIP	65
Switching between the PIP and main screens	65
Deactivating PIP	65
*VCR Playback	
Playing the VCR	66
Tracking	66
Special VCR Playback Features	67
Variable Search System	68
Go to [0:00:00] stop	68
End search	68
Scan and play	68

◆ Recording

*DVD Recording

Before Recording	69
Recordable discs	69
Recording Formats	70
Unrecordable pictures	70
Recording the current programme you are watching	71
Pausing/Resuming	71
Making a One Touch Recording(OTR)	72
Using the Showview Feature	72
Modifying Showview Programming	74
Using the Timer Programming Feature	75
Editing Timer Programming Feature	76
Editing the settings for a timer recording	76
Deleting a Timer Programming	77

Showview Extended	78
Watching the Images Being Recorded (Time Slip)	79
Recording From External Devices	79
Recording through a DV jack	80
*VCR Recording	
Basic VCR Recording	80
Special Recording Features	81
Record Speed	81
Copy to DVD or VCR	82
DVD to VCR	82
Direct copy DVD to VCR	82
VCR to DVD	83
Direct copy VCR to DVD	83

◆ Editing

Viewing the Menu Functions for a Disc	84
No Disc	84
DVD-VIDEO	84
CD	85
JPEG+MP3	85
DVD-RAM(VR)	85
DVD-RW(VR)	85
DVD-R(V)	85
Viewing Title List	86
Record List edit items	86
Playing a Title List Entry	87
Renaming a Title List Entry	88
Deleting a Title List Entry	89
Locking a Title List Entry	90
Deleting a Section from a Title List Entry	91
Creating a Playlist Entry	92
Editing a Playlist Entry	94
Playing Playlist Entries	94
Renaming Playlist Entries	95

Editing Scene for a Playlist Entry	95
A. Playing a Desired Scene	96
B. Modifying a Scene (Replacing a Scene)	96
C. Modifying a Scene (Changing the Position of a Scene)	97
D. Adding Scene	97
E. Deleting a Scene from the Playlist	98
Copying a Playlist Entry to the VCR	99
Deleting a Playlist Entry from the Playlist	99
Disc Manager	100
Editing Disc Name	100
Disc Protection	101
Formatting a DVD-RAM/DVD-RW Disc	102
Deleting All Title Lists	103
Cartridge Protect Info (DVD-RAM)	103
Finalising a disc	104
Unfinalising a disc (V/VR mode)	105

◆ Reference

Troubleshooting (DVD-VIDEO/DVD-RAM/ DVD-RW/DVD-R)	107
Troubleshooting	108
Problems and Solutions (VCR)	109
Specifications	110

General Features

The D-VR3 allows you to record and playback high quality digital images on a DVD-RAM/DVD-RW/ DVD-R disc. You can also edit digital images on DVD-RAM/DVD-RW discs.

High quality digital audio and video recording and playback

Record up to about 12-hours of video with a double side 9.4 GB DVD-RAM disc, and up to about 6-hour of video with a 4.7 GB DVD-RAM disc, depending on the recording mode.

Creating DVD-Video title using DVD-RW/DVD-R disc

With D-VR3, create your own DVD-Video title on 4.7 GB DVD-RW/DVD-R discs.

A Variety of Recording Options(DVD)

Select an appropriate recording mode between XP, SP, LP and EP to meet your recording needs. (See page 76)

- XP mode - High quality, about 1 hour
- SP mode - Standard quality, about 2 hours
- LP mode - Low quality, about 4 hours
- EP mode - Lower quality, about 6 hours

Copying digital camcorder content using DV input jack

Record digital camcorder images onto DVD-RAM/DVD-RW/DVD-R discs or Video tape using the DV input jack (IEEE 1394-4pin/4pin). (See page 80.)

Time Slip and Picture In Picture (PIP)

Use the Time Slip function to playback the recorded images while a recording is proceeding (DVD-RAM only).

Use the PIP function to view the playback and recording screens at the same time.









A variety of functions with easy-to-use user interface

Integrated menu system and messaging functionality allow you to perform the desired operations easily and conveniently. With a DVD-RAM/DVD-RW(VR mode) disc, you can edit recorded images, create playlist, and edit images in specific sequence according to your needs.

Before Reading the User's Manual

Make sure to read the following terms before reading the user's manual.

Icons that will be used in manual

Icon	Term	Definition
	DVD	This involves a function available in DVD or Video Mode DVD-R
	RAM	This involves a function available in DVD-RAM
	RW	This involves a function available in DVD-RW
	R	This involves a function available in DVD-R
	CD	This involves a function available in a data CD (CD-R or CD-RW)
	JPEG	This involves a function available in a data picture CD (CD-R or CD-RW)
	MP3	This involves a function available in a data CD (CD-R or CD-RW) on which MP3 is recorded)
	NOTE	This involves tips or instructions on the page that help each function operation
	Preliminary	Check items before operating each function.

About the use of this user's manual

- 1) Be sure to be familiar with Safety Instructions before using this product. (See pages 2-7)
- 2) If a problem occurs, check for Troubleshooting.

Copyright

©2004 Toshiba Corporation.
All rights reserved; No part or whole of this user's manual may be reproduced or copied without the prior written permission of Toshiba Corporation.

How to use the DVD Recorder-VCR

Step 1 Select the disc type

This unit can record on the following types of discs. If you want to repeatedly record on the same disc or you want to edit the disc after recording, select a rewritable DVD-RW or DVD-RAM type disc. If you want to save a recording without any changes, choose a non-rewritable DVD-R.



Step 2 Format the disc to start recording

Unlike a VCR, the recorder automatically starts formatting when an unused disc is inserted. This is required for the preparation of recording on a disc.

Using a DVD-RAM

This type of disc can be formatted in DVD-Video Recording format (VR mode). You can edit recorded images and create a playlist in a specific sequence according to your requirements.

Using a DVD-RW

This type of disc can be formatted in either DVD-Video format (Video mode) or DVD-Video Recording format (VR mode). For an unused disc, a message that asks whether to format in VR Mode or not is displayed. You can play a video mode disc on various DVD components. A VR mode disc allows more varied editing.

Using a DVD-R

This type of disc can be formatted in DVD Video format. After formatting is complete, you can record on the disc. You can play this type of disc on various DVD components only when they have been finalised.



- You can only use one format on a DVD-RW.
- You can change the DVD-RW format to another format. It should be noted that the data of the disc may be lost when changing formats.

Step 3 Recording

There are two different recording methods: Direct Recording and Timer Recording. Timer recording is classified as recording type : Once, Daily or Weekly or recording mode : XP (high quality mode), SP (standard quality mode), LP (long recording mode), and EP (extended mode) according to the recording mode.

Step 4 Playing

You can select the title you want to play in a displayed menu and then immediately start playback.

A DVD consists of sections, called titles, and sub sections, called chapters.

During recording, a title is created between two points where you start and stop recording, DVD-RW/DVD-R discs(in Video mode) can automatically create chapters according to the recording mode when finalised.

Step 5 Editing a recorded disc

Editing on discs is easier than conventional video tapes. The recorder supports many different edit functions, possible only with DVDs.

With a simple and easy edit menu, you can operate various edit functions, such as delete, copy, rename, lock, etc., on a recorded title.

Creating a playlist (DVD-RAM/DVD-RW in VR mode)

With this recorder, you can create a new playlist on the same disc and edit it without the change of the original recording.

Step 6 Finalising & Playing on other DVD components

To play your DVD on other DVD components, finalising may be necessary. First, finish all editing and recording operations, then finalise the disc.

When using a DVD-RW disc in VR Mode

Although finalising is generally unnecessary when playing the disc on a VR Mode compatible component, a finalised disc should be used for playback on that type of component.

When using a DVD-RW disc in Video Mode

The disc should be finalised first to enable playback on anything other than this recorder. No more editing or recording can be made on the disc once it has been finalised.

To enable recording on the disc again, Disc should be unfinalised.

When using a DVD-R disc

You should finalise the disc to play it on a component other than this recorder. You cannot edit or record on the disc once it has been finalised.

Description

Front Panel

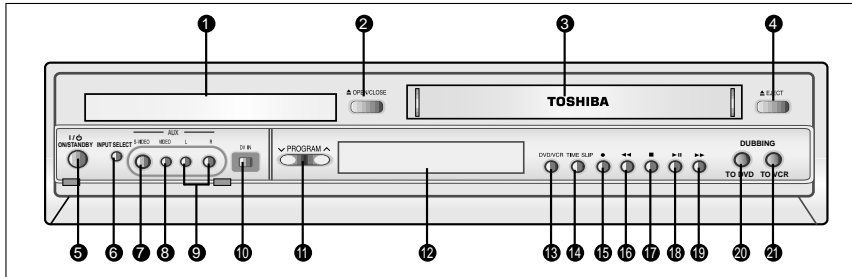

- | | |
|------------------------------------|-------------------------------|
| 1. DVD DECK | 12. FRONT PANEL DISPLAY |
| 2. DVD OPEN/CLOSE BUTTON | 13. DVD/VCR SELECT BUTTON |
| 3. VCR DECK | 14. TIME SLIP BUTTON |
| 4. VCR EJECT BUTTON | 15. RECORD BUTTON |
| 5. ON/STANDBY BUTTON | 16. REW/SKIP BUTTON (VCR/DVD) |
| 6. INPUT SELECT BUTTON | 17. STOP BUTTON |
| 7. S-VIDEO INPUT JACK | 18. PLAY/STILL BUTTON |
| 8. VIDEO INPUT JACK | 19. F.F/SKIP BUTTON (VCR/DVD) |
| 9. AUDIO L,R INPUT JACK | 20. TO DVD BUTTON |
| 10. DV IN JACK | 21. TO VCR BUTTON |
| 11. PROGRAM ∇/\wedge BUTTON | |

Front Panel Display

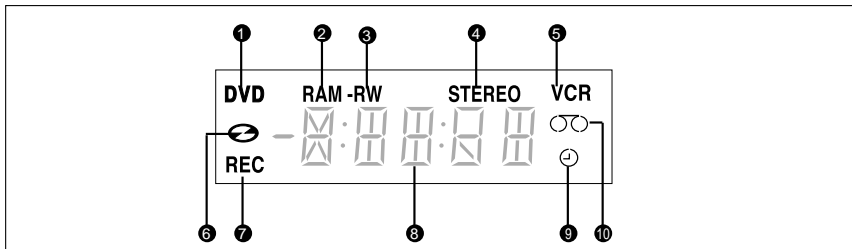

- | | |
|--|--|
| 1. When the indicator is on, DVD is activated. | 7. Record function is working. |
| 2. DVD-RAM is activated. | 8. The time, counter position or current deck status is indicated. |
| 3. DVD-RW or DVD-R is activated. | 9. When you set a Timer recording, it or currentdeck status is indicated. this indicator is light. |
| 4. When you watch STEREO channel or playback Hi-Fi VCR tapes, STEREO indicator lights. | 10. VHS Videotape is loaded. |
| 5. VCR is activated. | |
| 6. DVD or CD media is loaded. | |

Rear Panel

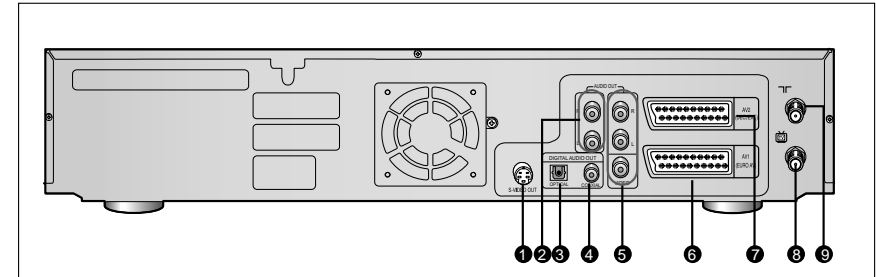

- | | |
|-------------------------------------|--|
| 1. S-VIDEO OUT JACK | 6. AV1 (EURO AV) IN/OUT SCART (EURO-21) SOCKET |
| 2. AUDIO OUT L,R JACK | 7. AV2 (DEC./EXT.) SCART (EURO-21) SOCKET |
| 3. DIGITAL AUDIO OUT JACK (OPTICAL) | 8. OUT TO TV CONNECTOR |
| 4. DIGITAL AUDIO OUT JACK (COAXIAL) | 9. AERIAL IN CONNECTOR |
| 5. AUDIO/VIDEO JACK | |

Tour of the Remote Control

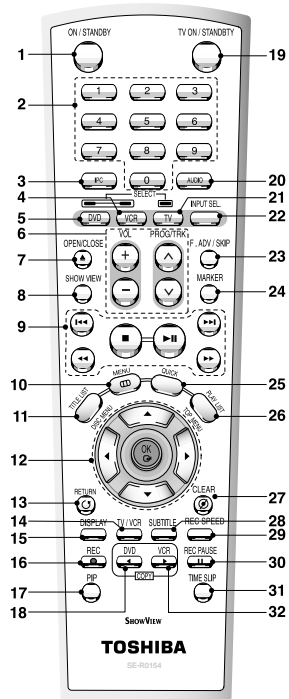

1. ON/STANDBY Button

2. NUMBER Button

3. IPC Button

4. VCR Button

5. DVD Button

Press this when you use a DVD.

6. TV Control Buttons

- VOLUME Button
TV volume adjustment

- PROG/TRK Button
Use this to select a TV programme.

7. OPEN/CLOSE Button

To open and close the disc and Video cassettes.

8. ShowView Button

Press this when you use ShowView.

9. Playback-related Buttons

Search, Skip, Stop, Play/Still

10. MENU Button

Brings up the DVD Recorder-VCR's setup menu.

11. TITLE LIST/DISC MENU Button

Use this to enter the View Recording list/disc menu.

12. OK/DIRECTION Buttons

(UP/DOWN or LEFT/RIGHT Buttons)

13. RETURN Button

14. TV/VCR Button

15. DISPLAY Button

This will display current setting or disc status.

16. REC Button

Use to make a recording on DVD-RAM/-RW/-R discs and Video tape.

17. PIP Button

Use to watch a subprogram on the PIP screen while watching the main program on the main screen.

18. DVD COPY Button

Press this when you copy VCR to DVD.

19. TV ON/STANDBY Button

20. AUDIO Button

Use this to access various audio functions on a disc (DVD mode).

21. TV Button

Press this to operate TV.

22. INPUT SEL. Button

Select input signal in external input mode(Tuner or AV1, AV2 or AUX)

23. F.ADV/SKIP Button

24. MARKER Button

Use this to bookmark a position while playing a disc.

25. QUICK Button

Use this to view the status of the disc that is being played.

26. PLAY LIST/TOP MENU Button

Use this to return to the TOP MENU, or to view the recorded files list.

27. CLEAR Button

28. SUBTITLE Button

Press this to switch the DVD's subtitle language.

29. REC SPEED Button

30. REC PAUSE Button

Use this to pause during recording.

31. TIME SLIP Button

32. VCR COPY Button

Press this when you copy DVD to VCR.

Connecting & Setting Up

Quick Overview

A Quick overview presented in this guide will give you enough information to start using the recorder.

Step 1 : Unpacking



Step 2 : Connecting DVD Recorder-VCR to the TV using the RF Cable



Step 3 : Connecting the Scart Cable



Step 4 : Connecting the Video Cable



Step 5 : Connecting the Audio Cable



Step 6 : Connecting External Devices



Step 7 : Preparing the Remote Control

• Quick Overview	17
• Unpacking	18
• Connecting DVD Recorder-VCR to the TV using the RF Cable	18
• Connecting the Scart Cable	19
• Connecting the Video Cable	20
• Connecting the Audio Cable	21
• Connecting External Devices	23
• Preparing the Remote Control	24

Step 1: Unpacking

Accessories

Check for the supplied accessories below.

- Audio/Video Cable
- RF Cable for TV
- Remote Control
- Batteries for Remote Control (AA Size)
- User's Manual
- * Dispose of batteries according to local environmental regulations. Do not put them in the household trash.

Step 2: Connecting DVD Recorder-VCR to the TV using the RF Cable

To receive television programmes a signal must be received from one of the following sources:

- An outdoor aerial
- An indoor aerial
- A cable television network
- A satellite receiver

- Note
- Make sure that both the television and the DVD Recorder-VCR are switched off before connecting the cables.

- 1 Remove the aerial or network input cable from the television.

- 2 Connect this cable to the 75Ω coaxial socket marked "TR" on the rear of your DVD Recorder-VCR.

- 3 Plug the RF cable supplied into the "ANT" socket on your TV.

- 4 Plug the other end of the RF cable into the connector previously used for the aerial on the television.

- Note
- To obtain better quality pictures and sound on your television, you can also connect your DVD Recorder-VCR to the television via the SCART cable (see next page) if your television is equipped with this type of connection.

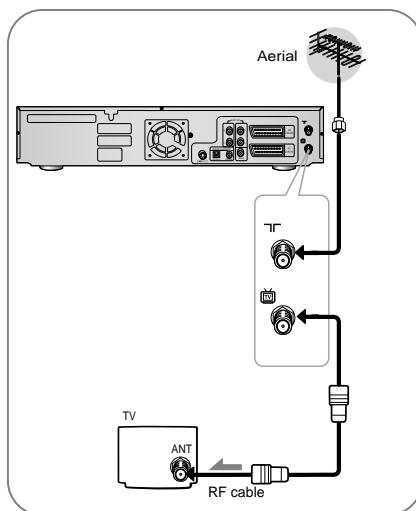

Step 3: Connecting the Scart Cable

Method 1 : Connecting DVD Recorder-VCR to the TV using the SCART Cable

You can connect your DVD Recorder-VCR to the television using the SCART cable if the appropriate input is available on the television. You thus:

- Obtain better quality sound and pictures
- Simplify the setting up procedure of your DVD Recorder-VCR
- Regardless of the type of connection chosen, you must always connect the RF cable supplied. Otherwise, no picture will be visible on the screen when the DVD Recorder-VCR is switched off.
- Make sure that both the television and the DVD Recorder-VCR are switched off before connecting the cables.

1. Connect the RF cable as indicated in the previous section.
2. Connect one end of the SCART cable to the AV1 (EURO AV) socket on the rear of the DVD Recorder-VCR.
3. Plug the other end into the appropriate connector on the television.

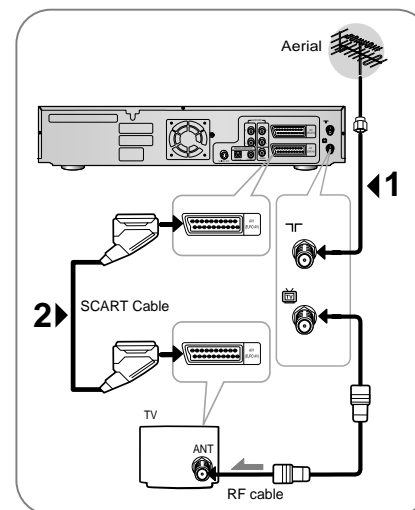

Method 2 : Connecting DVD Recorder-VCR to a Satellite Receiver or Other Equipment

You can connect your DVD Recorder-VCR to a Satellite receiver or other DVD Recorder-VCR using the SCART cable if the appropriate outputs are available on the equipment chosen. The following illustrations give a few examples of the connection possibilities.

1. **AV1(EURO AV): By means of 21-pin Scart Cable**
Plug the SCART Cable with satellite receiver or other equipment into the AV1 (EURO AV) socket on the rear of the DVD Recorder-VCR. After making this connection, select the source by pressing the INPUT SEL. button for the AV1 input sources.
2. **By means of RF Cable**
After making this connection, you must preset the station received through the satellite tuner. RF output channel of the satellite receiver should be adjusted away from channel 60, which is used by the DVD Recorder-VCR, e.g. re-adjust to channel 65.

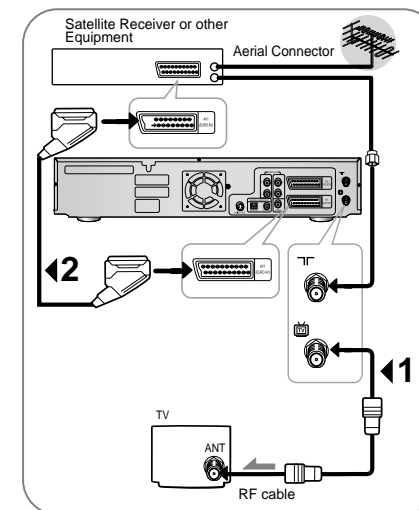

1. AV2 IN: By means of 21-pin Scart Cable

Plug the SCART Cable with satellite receiver or other equipment into the AV2 (DEC./EXT.) socket on the rear of the DVD Recorder-VCR.

After making this connection, select the source by pressing the INPUT SEL. button for the AV2 input sources.

2. By means of RF Cable

After making this connection, you must preset the station received through the satellite tuner.

RF output channel of the satellite receiver should be adjusted away from channel 60, which is used by the DVD Recorder-VCR, e.g. re-adjust to channel 65.

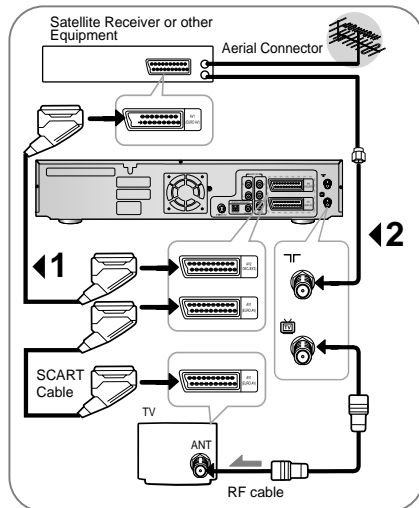

Step 4: Connecting the Video Cable

There are several ways to connect your DVD Recorder-VCR. Select one of the following video connecting methods that best suits you below.

- Method 1 : Connecting to a Video input jack
- Method 2 : Connecting to an S-video input jack

S-Video Modes

• S-Video is available only if your TV supports S-Video input. If S-Video output does not work, check the TV connections and the TV input selection settings.

Method 1 : Connecting to a video input jack

Connect a video (yellow) cable between the VIDEO (yellow) OUT jack on DVD Recorder-VCR and VIDEO (yellow) IN jack on the TV (or AV amplifier).

- You will enjoy regular quality images.
- Connect audio cables (white and red) between the ANALOG AUDIO OUT jack on the DVD Recorder-VCR and AUDIO IN jack on TV (or AV amplifier).

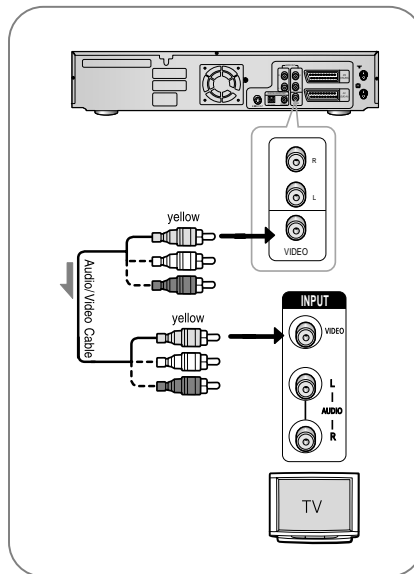
**Method 2 : Connecting to an S-video input jack**

Connect an S-video cable (not supplied) between the S-VIDEO OUT jack on DVD Recorder-VCR and S-VIDEO IN jack on the TV (or AV amplifier).

- You will enjoy high quality images. S-Video separates the picture element into black and white (Y) and color (C) signals to present clearer images than regular video input mode.

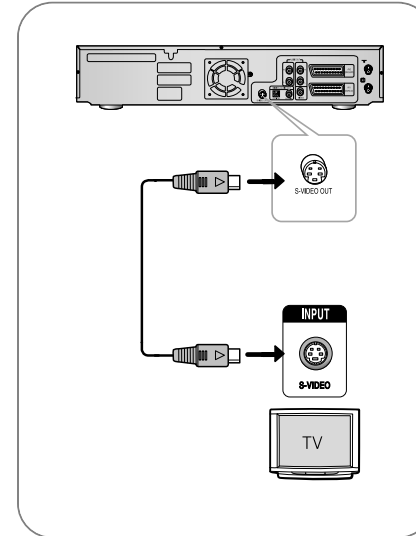

Step 5 : Connecting the Audio Cable

There are several ways to connect your DVD Recorder-VCR. Select the audio connection that best suits you below.

- Method 1 : Connecting to your TV
- Method 2 : Connecting to a stereo amplifier (analog audio out / digital audio out)
- Method 3 : Connecting to an AV amplifier with a digital input jack.

Method 1 : Connecting to your TV

This connection will use your TV's speakers.

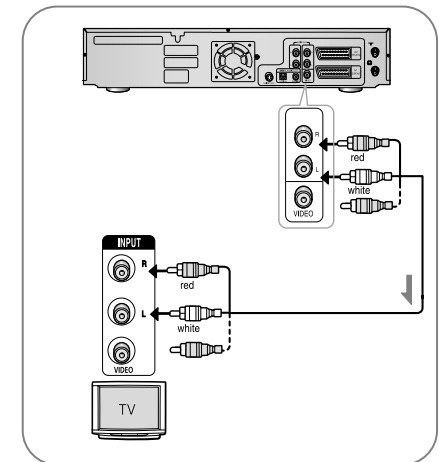

Method 2 : Connecting to a stereo amplifier with analog input jacks

If your stereo amplifier only has audio input jacks (L and R), use the analog audio out jacks.

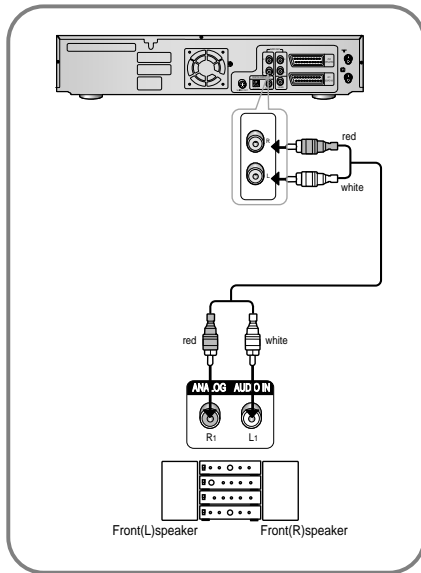

Method 3 : Connecting to an AV amplifier with the digital input jack

If your AV amplifier only has a Dolby Digital or DTS decoder and a digital input jack, use this connection. To enjoy Dolby Digital or DTS sound, you must set up the audio settings. (See page 39)

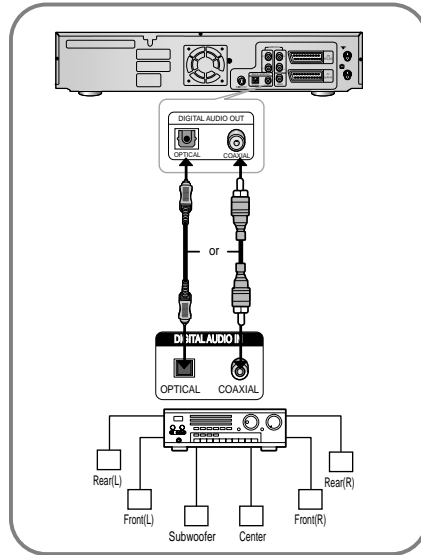

Step 6 : Connecting External Devices

This allows you to connect your DVD Recorder-VCR to other external devices and view or record their outputs.

- **Method 1** : Connecting a external devices to the AUX in jacks.
- **Method 2** : Connecting a Camcorder to the DV IN jack.

Manufactured under license from Dolby Laboratories. "Dolby" and the double-D symbol are trademarks of Dolby Laboratories.

"DTS" and "DTS Digital Out" are trademarks of Digital Theater Systems, Inc.

Method 1 : Connecting a external devices to the AUX jacks

You can use the AUX jacks on the front panel of the DVD Recorder-VCR. You can record from connected equipment.

When an input source is inserted into AUX while viewing TV, the input will be switched to AUX automatically.

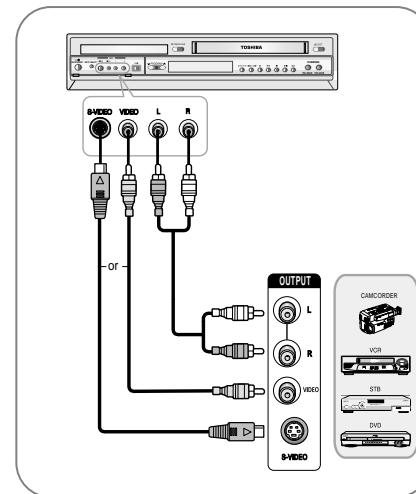

Method 2 : Connecting a Camcorder to the DV IN jack

If your camcorder has a DV output jack, connect it to the DV input jack of your DVD Recorder-VCR.

- If your camcorder has a DV output jack, see page 80 for more information.

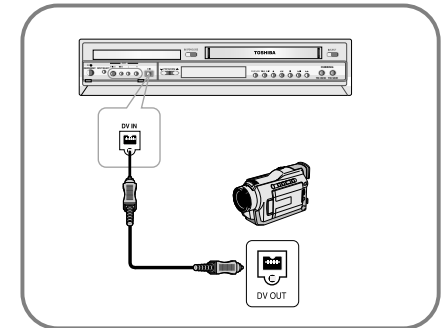

- Some models of DV format digital video cameras may support a different compression format. From such equipment, recording is not possible.
- Depending on the models of DV format digital video cameras, recording may not work properly or some functions may be disabled.

Step 7 : Preparing the Remote Control

Install Batteries in the Remote Control

- Open the battery cover on the back of the remote.
- Insert two AA batteries. Make sure that the polarities (+ and -) are aligned correctly.
- Replace the battery cover.

If remote does not operate properly:

- Check the polarity + - of the batteries (Dry-Cell)
- Check if the batteries are drained.
- Check if remote sensor is blocked by obstacles.
- Check if there is any fluorescent lighting nearby.

Dispose of batteries according to local environmental regulations. Do not put them in the household trash.

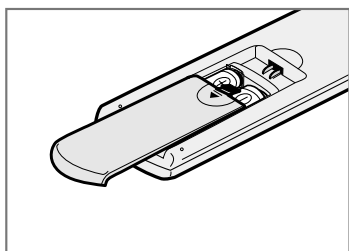

- Do not expose the remote sensor of the recorder to a strong light source such as direct sunlight or other illumination. If you do so, you may not be able to operate the recorder via the remote control.

Setting the Remote Control

Your DVD Recorder-VCR remote control will work with Toshiba televisions and compatible brands.



To determine whether your television is compatible, follow the instructions below.

1. Switch your television on.
2. Point the remote control towards the television.
3. Hold down the TV button and enter the four-figure code corresponding to the brand of your television, by pressing the appropriate numeric buttons.

Controllable TV Codes

Brand name	Brand code			
TOSHIBA	0001	0071	0211	0571
AIWA	0921			
AKAI	0201	0241	0311	0431 0501 0521 0641
BAIRD	0171 0241			
BANG & OLUFSEN	0471			
BEKO	0181			
BLAUPUNKT	0071	0321	0331	
BRIONVEGA	0461 0471 0651			
BUSH	0071 0501 0551 0571			
CROWN	0111	0131	0411	0491 0501 0661
DANSAI	0501			
DEAWOO	0401	0411	0501	
DECCA	0091	0141	0171	0441 0451 0501
FERGUSON	0031	0071	0131	0191 0291 0311 0381
	0541 0601			
FINLUX	0021	0041	0071	0081 0091 0111 0271
	0281 0291 0301 0341 0471			
FISHER	0041	0121	0181	0201 0281 0471 0571
	0651			
FUNAI	0001	0191	0481	0491 0891
GEC	0171 0221			
GOLDSTAR	0201	0251	0281	0411 0501
GOODMANS	0171	0281	0501 0571	
GRANADA	0171	0241	0271	0501 0571 0651 0671
GRUNDIG	0011	0071	0271	0321 0331
HINARI	0241 0411 0571 0631			
HITACHI	0021	0221	0251	0351 0371 0381 0431
	0571 0641 0751			
INNO HIT	0171	0281	0411	0501 0631 0661
ITT	0231	0241	0261	0271 0401 0611
ITT-NOKIA	0231	0241	0261	0271 0401 0611
JVC	0311 0431 0521 0571			
LOEWE OPTA	0471	0501	0571	0651
LUXOR	0241	0261	0271	0281 0351
MAGNAVOX	0501	0071	0191	0221 0461 0471 0591
	0611 0651			
MARANTZ	0201 0501			
MATSUI	0001	0171	0191	0231 0411 0441 0451
	0501 0551 0571			
METZ	0041 0331 0361 0461 0471 0651			
MITSUBISHI	0201	0321	0331	0451 0501 0511 0571
	0651 0771			
NATIONAL	0371	0501	0511	0531 0761 0841 0911
	1061			
NOKIA	0231	0241	0261	0271 0401 0611
NORDMENDE	0281	0351	0381	0421 0431 0461 0521
	0541 0641 0671			
OCEANIC	0481			
ORION	0001	0191	0231	0361 0411 0441 0451
	0501 0551 0611			
PANASONIC	0371	0501	0511	0531 0761 0841 0911
	1061			
PHILCO	0071	0111	0181	0201 0271 0301 0461
	0501 0651			
PHILIPS	0071	0191	0221	0461 0471 0501 0591
	0611 0651			
PIONEER	0381 0431 0501 0831 1051			
PROSCAN-THOMSON	0971 1041 0201 0501			
RCA	0971 1071 1081 1091 0201 1041 0501			
REALISTIC	0631	1001	1011	1021 1031 0851 0201
	0501 0481 0321 0331 0501 0651 0771			

SABA	0281	0351	0381	0421	0431	0471	0541
	0641 0651 0661 0671						
SAISHO	0231 0411 0441 0451 0551						
SALORA	0231 0241 0351						
SAMSUNG	0171	0181	0251	0281	0411	0491	0501
	0631 0661 0791						
SANYO	0021	0041	0081	0121	0171	0181	0201
	0231 0241 0451 0571 0651 0671 0701						
	0711 0721						
SCHNEIDER	0011	0051	0061	0281	0461	0501	0581
	0591						
SEG	0091 0121 0151						
SELECO	0031 0051 0061 0351 0501 0561						
SHARP	0851 0511 0571 0201 0501						
SIEMENS	0071 0321 0331 0571 0631						
SINGER	0091 0471 0651						
SINUDYNE	0001	0091	0101	0131	0191	0231	0361
	0471 0501 0551 0581 0651						
SONY	0441 0451 0571 0681						
TANDBERG	0041 0301 0351 0431 0461 0571 0651						
TATUNG	0091 0141 0171 0441 0451 0501						
TECHNICS	0371	0501	0511	0531	0761	0841	0911
	1061						
TELEFUNKEN	0071	0281	0381	0421	0431	0521	0601
	0621 0671						
TENSAI	0041						
THOMSON	0281	0351	0371	0381	0391	0421	0461
	0521 0541 0641 0971 1041						
THORN	0041	0071	0281	0291	0341	0421	0491
	0601 0671						
UNIVERSUM	0021 0491						
YAMAHA	0201	0501	0321	0331	0451	0511	0571
	0651 0771						
ZANUSSI	0031 0051 0061 0351 0501 0561						
ZENITH	0931						

Result: If your television is compatible with the remote control, it will switch off. It is now programmed to operate with the remote control.



- If several codes are indicated for your television brand, try each one in turn until you find one that works.
- Please note if TV manufacturer may change their remote control code without notice, this function may not work.

You can then control the television using the following buttons.

Button	Function
TV ON/STANDBY	Used to switch the television on and off.
INPUT SEL.	Used to select an external source.
VOL + or -	Used to adjust the volume of the television.
PROG/TRK (^ or v)	Used to select the required channel.



- The various functions will not necessarily work on all televisions. If you encounter problems, operate the television directly.

System Setup

- On-Screen Menu Navigation 26
- Plug & Auto Setup 27
- Setting the Date and Time 28
- Presetting the Stations Automatically 29
- Presetting the Stations Manually 30
- Clearing a Preset Station 31
- Changing the Preset Manual Setup Table 32
- Selecting the RF OUT Sound Mode (B/G-D/K) 33
- Setting the VCR Output Channel 34
- Setting Up the Language Features 35
- Setting Up the Audio Options 39
- Setting Up the Display(Video) Options 40
- Setting Up the Parental Control 41
- VCR Setting 42
- Intelligent Picture Control(IPC) 44
- Selection the Colour Mode 45
- Front Display 46
- NICAM 47
- AV1 Output 47

On-Screen Menu Navigation

The on-screen menus allow you to enable or disable various functions on your DVD Recorder-VCR. Use the following buttons to open and navigate through the on-screen menus.

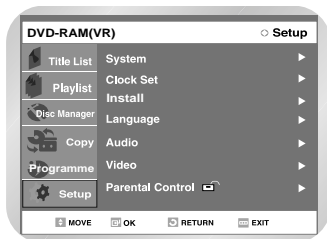

- 1 MENU Button**
Press this button on the remote control while the DVD or VCR is in Stop or Play mode to open the on-screen MAIN MENU.
- 2 Up/Down and Left/Right**
Use these buttons to move the selection bar ▲▼◀▶ to cycle through the menu options.
- 3 OK Button**
Press this button on the remote control to confirm any new settings.
- 4 RETURN Button**
Press this button on the remote control to return to the last MENU screen displayed or to exit the on-screen MENU all together.

Plug & Auto Setup

The DVD Recorder-VCR will automatically set itself up when it is plugged into the mains for the first time. TV stations will be stored in memory. The process takes a few minutes. The DVD Recorder-VCR will then be ready for use.

- 1** Connect the RF cable as indicated on page 18.
 - Connecting Your DVD Recorder-VCR to the TV using the RF Cable.
- 2** Plug the DVD Recorder-VCR into the mains.
 - "Auto" in the front panel display flickers.

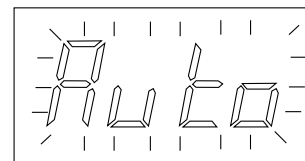

- 3** The Language Set menu is displayed.
 - Using the ▲▼ buttons, move the selection bar to select the desired language then press OK button.



- 4** Start the auto setup.

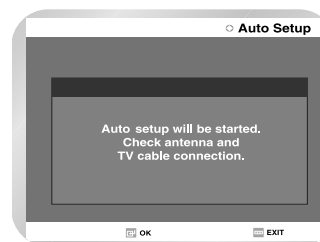

- 5** Select "Contry" using the ▲▼◀▶ buttons to select your country.

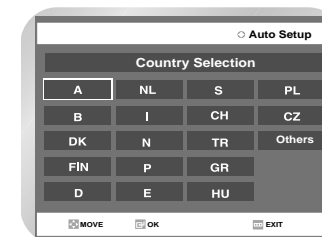

Refer to following abbreviation table when selecting "Country"

A(Austria)	NL(Netherlands)	S(Sweden)	PL(Poland)
B(Belgium)	I(Italy)	CH(Swiss)	CZ(Czech)
DK(Denmark)	N(Norway)	TR(Turkey)	Others
FIN(Finland)	P(Portugal)	GR(Greece)	
D(Deutschland)	E(Spain)	HU(Hungary)	

- 6** Start the auto scanning.

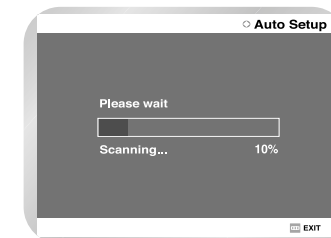

- 7** Check the date and time.
 - if it is: Correct
Press OK button then the data and time will be saved.
 - if it is: Incorrect
Refer to "Setting the Date and Time" menu, when you want to change the date and time.

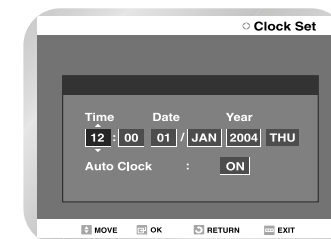

Setting the Date and Time

Your DVD Recorder-VCR contains a 24-hour clock and calendar used to:

- Automatically stop programme recording
- Preset your DVD Recorder-VCR to record a programme automatically. You must set the date and time when you purchase the DVD Recorder-VCR
- Do not forget to reset the time when you change clocks from winter to summer time and vice versa.

- 1 With the unit in Stop mode, press the MENU button.

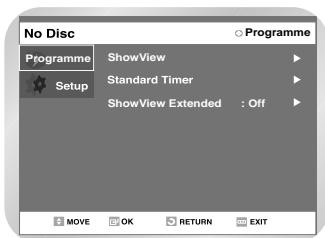

- 2 Using the ▲▼ buttons, move the selection bar to "Setup" then press OK to select.

- 3 Select "Clock Set" using the ▲▼ buttons, then press the ► or OK button.

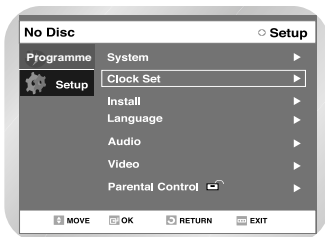

- 4 Press ◀▶ to select the hour, minutes, day, month and year.

- 5 Press the ▲▼ button to increase or decrease the value.
 - The day of the week is displayed automatically.
 - You can hold the ▲▼ buttons down to scroll more quickly through the values.

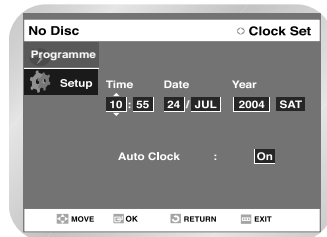

- 6 Press OK button, then the date and time will be saved, if you don't press OK button, it will not be saved.

- 7 On completion, press RETURN to exit the menu.

Note ■ You must have the aerial connected to set the Auto Clock. Connecting the RF Cable On page 18.

Presetting the Stations Automatically

You do not need to preset the stations if you have already set them automatically (see Plug & Auto Set Up on page 27).

Your DVD Recorder-VCR contains a built-in tuner used to receive television broadcasts.

You must preset the stations received through the tuner. This can be done:

- Plug & Auto Set up (see page 27)
- Automatically
- Manually (see page 30)

- 1 Open "MENU"
With the DVD in Stop press the MENU button.

- 2 Select "Setup"
Using the ▲▼ buttons, move the selection bar to "Setup" then press ► or OK to select.

- 3 Select "Install"
Using the ▲▼ buttons, move the selection bar to "Install", then press ► or OK to select.

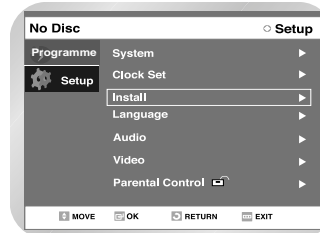

- 4 Select "Auto Setup"
Move the selection ▲▼ buttons to "Auto Setup" then press ► or OK button to select from the following options:

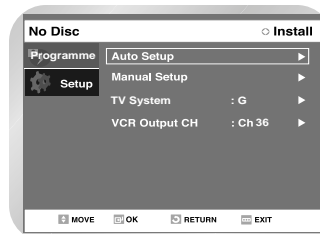

- 5 Select "Country" using the ▲▼◀▶ buttons to select your country.

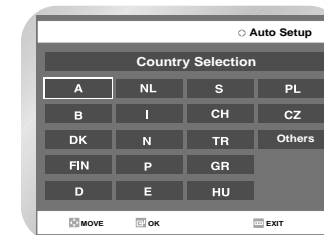

- 6 Press OK button.
A message appears, indicating that any channels already preset on the DVD Recorder-VCR will be deleted.

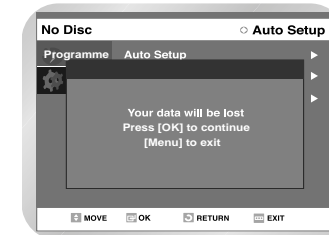

- 7 Press OK to start the auto scanning.

- The first frequency band is scanned and the first station found is displayed and stored. And the DVD Recorder-VCR searches for the second station and so on.
- When the automatic scanning procedure has finished, the DVD Recorder-VCR switches automatically to programme 1.
- The number of stations automatically stored by the DVD Recorder-VCR depends on the number of stations that it has found.

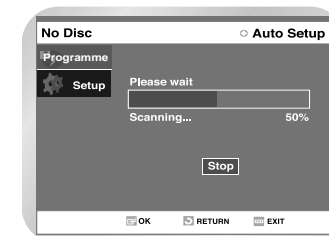

- 8 If you wish to cancel the auto scanning before the end, press the OK button.
- The time and date are set automatically from the broadcast signal. If the signal is weak or ghosting occurs, the time and date may not be set automatically.
 - Once the auto scanning procedure has finished, some stations may have been stored more than once; select the stations with the best reception and delete the ones no longer required.

Presetting the Stations Manually

If you have already set them automatically, you do not need to preset the stations manually.

- 1 Open "MENU"
With the DVD in Stop mode, press the MENU button.
- 2 Select "Setup"
Using the ▲▼ buttons, move the selection bar to "Setup" then press ► or OK button to select.
- 3 Select "Install"
Using the ▲▼ buttons, move the selection bar to "Install", then press ► or OK button to select.

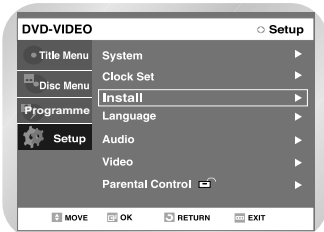

- 4 Select "Manual Setup"
Move the selection bar to "Manual Setup", using the ▲▼ buttons then press ► or OK button to select.

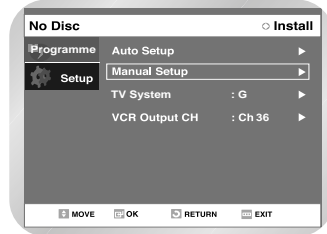

- 5 Press the ▲▼ buttons to select a PR number as required then press ► or OK button to select.

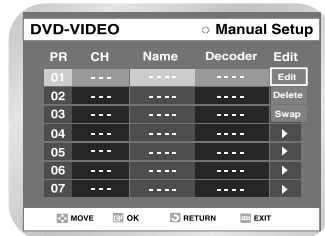

- 6 Press the ▲▼ button to select Edit. Then press ► or OK button to be displayed "Manual Setup" menu.

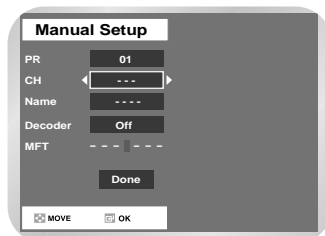

- 7 Press the ◀▶ buttons to start scanning the channels. The frequency band is scanned and the first station found is displayed.
- 8 Press the ▲▼ buttons until the NAME is selected. The station name is set automatically from the broadcast signal.

- 9 To change the programme's name, press the ► button. The first letter of the name flashes.

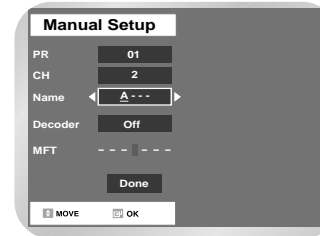

- 10 To... Then...
Select a Character Press the ▲▼ button until the required name character is displayed (letters, numbers or "-" character)
Move to the next or previous character Press the ◀▶ buttons respectively.

- 11 If you.. Then...
Wish to store the station displayed • Press the ▲▼ buttons until the MFT is selected.
• Press the ◀▶ buttons to adjust the picture, if necessary.
• Select Done to store the station.
Do not wish to store the station displayed • Press the ▲▼ buttons until the CH is selected.
• Press the ◀▶ buttons to go on scanning the frequency band and display the next station.
• Go back to the beginning of step.

- 12 Press the ▲▼ buttons to select Done and then press OK button to confirm manual setting.
• Repeat this procedure from step 5 onwards, until all the required stations have been stored.

Clearing a Preset Station

If you have stored a TV station:

- That you do not require
- At the wrong programme position you can cancel it.

- 1 Open "MENU"
With the DVD in Stop mode, press the MENU button.
- 2 Select "Setup"
Using the ▲▼ buttons, move the selection bar to "Setup" then press ► or OK button to select.
- 3 Select "Install"
Using the ▲▼ buttons, move the selection bar to "Install", then press ► or OK button to select.

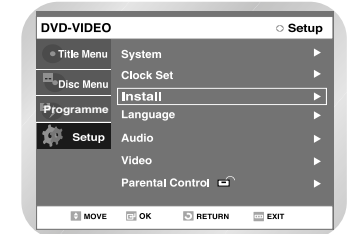

- 4 Select "Manual Setup"
Using the ▲▼ buttons, move the selection bar to "Manual Setup" then press ► or OK button to select.

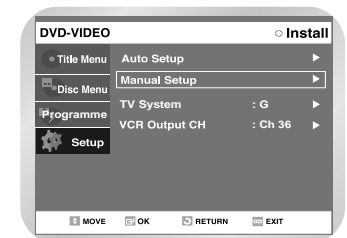

- 5 Press the ▲▼ buttons to select a PR number as required then press ► or OK button to select.

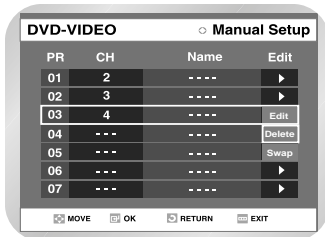

- 6 Press the ▲▼ button to select Delete. Then press OK button to delete.

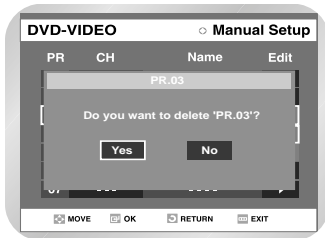

- 7 Press the ◀▶ buttons to select Yes, and then press the OK button.

- 8 Repeat the same procedure from Step 5 onwards until all the required stations have been cleared.

- 9 On completion, press the RETURN button four times to exit the menu.

Changing the Preset Manual Setup Table

You can rearrange the Manual Setup Table and give different programme numbers to the manual setup listed according to your own preferences.

- 1 Open "MENU"
With the DVD in Stop mode, press the MENU button.
- 2 Select "Setup"
Using the ▲▼ buttons, move the selection bar to "Setup" then press ► or OK button to select.
- 3 Select "Install"
Using the ▲▼ buttons, move the selection bar to "Install", then press ► or OK button to select.

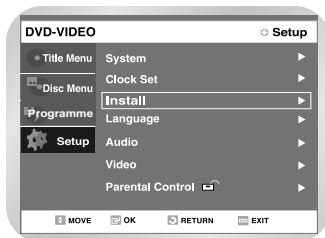

- 4 Select "Manual Setup"
Move the selection bar to "Manual Setup" using the ▲▼ buttons then press ► or OK button to select.

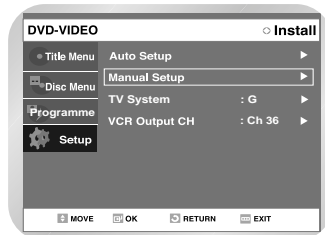

- 5 Press the ▲▼ buttons, until the required preset TV programme is selected then press ► or OK button to select.

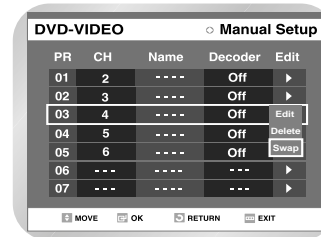

- 6 Press the ▲ or ▼ button to select Swap. To change the programme number assigned to a station press the OK button on the remote control.
 - For example, to move a TV station in programme 1 to programme 3).

- 7 Press the ▲▼ buttons to select required position. And then press OK button again to swap the position.

- 8 On completion, press the RETURN button four times to exit the menu.

Selecting the RF OUT Sound Mode (B/G-D/K)

You can choose the sound mode (B/G or D/K) according to the TV set connected to your VCR.

- 1 Open "MENU"
With the DVD in Stop mode, press the MENU button.
- 2 Select "Setup"
Using the ▲▼ buttons, move the selection bar to "Setup" then press ► or OK button to select.
- 3 Select "Install"
Using the ▲▼ buttons, move the selection bar to "Install", then press ► or OK button to select.
- 4 Select "TV System"
Move the selection bar to "TV System" using the ▲▼ buttons then press ► or OK button to select.

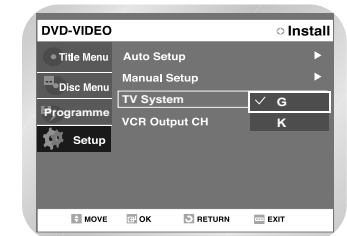

- 5 Press the ▲ or ▼ buttons to select G or K and then press the OK button.

- 6 On completion, press RETURN to exit the menu.

Setting the VCR Output Channel

1 Open "MENU"
With the DVD in Stop press the MENU button.

2 Select "Setup"
Using the ▲▼ buttons, move the selection bar to "Setup" then press OK to select.

3 Select "Install"
Using the ▲▼ buttons, move the selection bar to "Install", then press OK to select.

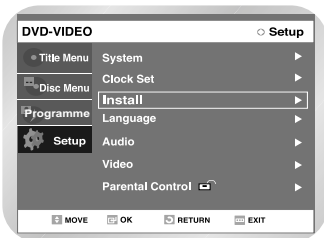

4 Select "VCR Output CH"
Move the selection bar to "VCR Output CH" using the ▲▼ buttons then press OK to select.

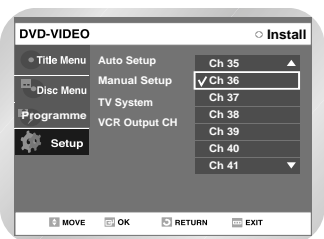

5 Select the required output channel (Ch21~Ch69) by pressing the ▲ or ▼ button then press OK to Select.

→Ch21 → ..Ch36 → ..Ch69

6 On completion, press RETURN button four times to exit the menu. Then tune your television again.

Setting Up the Language Features

If you set the player menu, disc menu, audio and subtitle language in advance, they will come up automatically every time you watch a movie.

Audio

1 With the DVD in Stop mode, press the MENU button on the remote control.

2 Select "Setup" using ▲▼ buttons, then press the ► or OK button.



3 Select "Language" using ▲▼ buttons, then press the ► or OK button.
Language setup menu will be displayed.

4 Use ▲▼ buttons to select the "Audio" and press the ► or OK button.

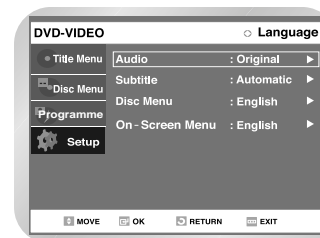

5 Select the desired Language using ▲▼ buttons, then press the ► or OK button.

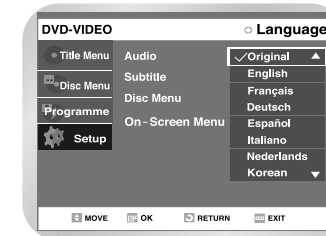

Note
Press the RETURN or ◀ button to return to the previous menu. Press the MENU button to exit the menu.

Subtitle

1 With the DVD in Stop mode, press the MENU button on the remote control.

2 Select "Setup" using ▲▼ buttons, then press the ► or OK button.

3 Select "Language" using ▲▼ buttons, then press the ► or OK button. Language setup menu will be displayed.

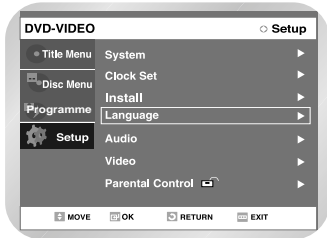

4 Use ▲▼ buttons to select the "Subtitle" and press the ► or OK button.

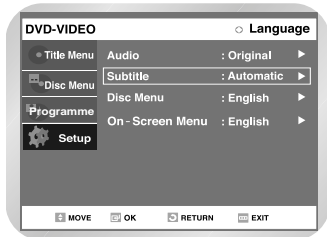

5 Use the ▲▼ buttons to select "Subtitle".

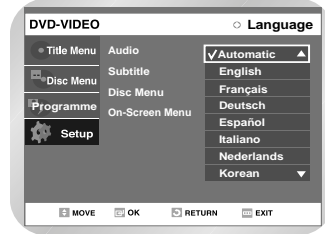

• Some discs may not contain the language you select as your initial language; in that case the disc will use its original language setting.

6 Press the ► or OK button.
• Subtitle is selected and the screen returns to Language Setup menu.

Disc Menu

1 With the DVD in Stop mode, press the MENU button on the remote control.

2 Select "Setup" using ▲▼ buttons, then press the ► or OK button.

3 Select "Language" using ▲▼ buttons, then press the ► or OK button. Language setup menu will be displayed.

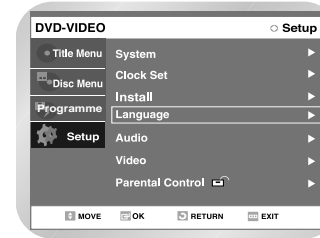

4 Use ▲▼ buttons to select the "Disc Menu" and press the ► or OK button.



5 Use the ▲▼ buttons to select Disc Menu Language.

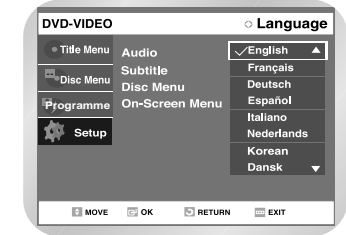

6 Press the ► or OK button.
• Disc Menu language is selected and the screen returns to Language Setup menu.

On-Screen Menu

- 1 With the DVD in Stop mode, press the MENU button on the remote control.

- 2 Select "Setup" using ▲▼ buttons, then press the ► or OK button.

- 3 Select "Language" using ▲▼ buttons, then press the ► or OK button. Language setup menu will be displayed.

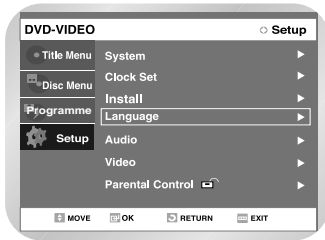

- 4 Use ▲▼ buttons to select the "On-Screen Menu" and press the ► or OK button.

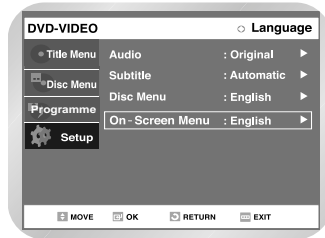

- 5 Use the ▲▼ buttons to select On-Screen Menu Language.



- 6 Press the ► or OK button.
 - On-Screen Menu is selected and the screen returns to Language Setup menu.

Setting Up the Audio Options

Allow you to setup the Audio device and sound status depending on the audio system in use.

- 1 With the DVD in Stop mode, press the MENU button on the remote control.

- 2 Select "Setup" using ▲▼ buttons, then press the ► or OK button.

- 3 Select "Audio" using ▲▼ buttons, then press the ► or OK button. Audio setup menu will be displayed.

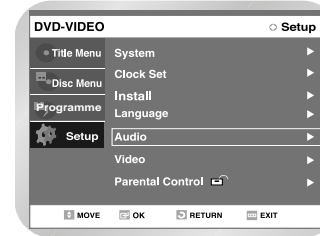

- 4 Use ▲▼ buttons to select the desired sub menu and press the ► or OK button.

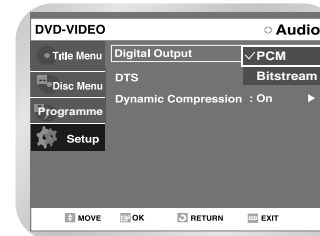

- 5 Use the ▲▼ buttons to select the desired item. Then press the ► or OK button.



Note

- Press the RETURN or ◀ button to return to the previous menu. Press the MENU button to exit the menu.

Digital Output

1. PCM : Converts to PCM(2CH) 48kHz audio. Select PCM when using the Analogue Audio Outputs.
2. Bitstream : Converts to Dolby Digital/MPEG Bitstream (5.1CH). Select Bitstream when using the Digital Audio Output.

DTS

1. Off : Doesn't output digital signal.
2. On : Outputs DTS Bitstream via digital output only. Select DTS when connecting to a DTS Decoder.



Note

- When DTS soundtrack is played, sound does output from Analog Audio Output.

Dynamic Compression

1. On : To select dynamic compression.
2. Off : To select the standard range.

Setting Up the Display(Video) Options

This function allows you to setup the TV screen settings.

- 1 With the DVD in Stop mode, press the MENU button on the remote control. You can't use the Setup functions during playback.
- 2 Select "Setup" using ▲▼ buttons, then press the ► or OK button.
- 3 Select "Video" using ▲▼ buttons, then press the ► or OK button. Video option menu will be displayed.

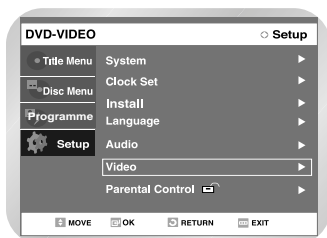

- 4 Select the sub menu using ▲▼ buttons, then press the ► or OK button.

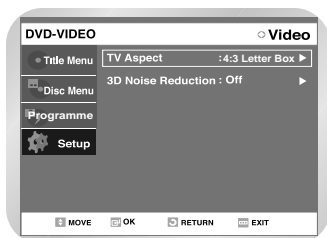

- 5 Use the ▲▼ buttons to select the desired item. Then press the ► or OK button.

Note ■ Press the RETURN or ◀ button to return to the previous menu. Press the MENU button to exit the menu.

Display(Video) Options

This function depends on disc type. It may not work for some disc types.

TV Aspect

Depending on the type of television you have, you may want to adjust the screen setting. (aspect ratio)

- **4:3 Letter Box** : Select when you want to see the total 16:9 ratio screen DVD supplies, even though you have a TV with a 4:3 ratio screen. Black bars will appear at the top and bottom of the screen.
- **4:3 Pan - Scan** : Select this for conventional size TV when you want to see the central portion of the 16:9 screen. (Extreme left and right side of movie picture will be cut off.)
- **16:9 Wide** : You can view the full 16:9 picture on your widescreen TV.

3D Noise Reduction

- **Off** : Normal
- **On** : Select to remove noise from the screen

Setting Up the Parental Control

The Parental Control function works in conjunction with DVDs that have been assigned a rating - which helps you control the types of DVDs that your family watches. There are up to 8 rating levels on a disc.

- 1 With the DVD in Stop mode, press the MENU button on the remote control.
- 2 Select "Setup" using ▲▼ buttons, then press the ► or OK button.
- 3 Select "Parental control" using ▲▼ buttons, then press the ► or OK button.

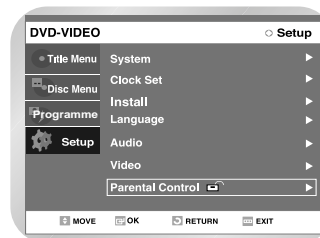

- 4 Enter the 4-digit password using the 0 to 9 buttons on the remote control.
 - The 'Confirm the password.' message will be displayed. Enter your password again.

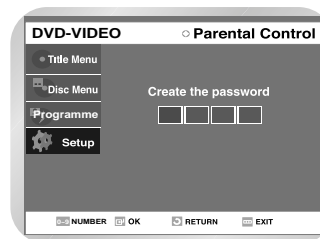

- 5 Select Password On,Off using ▲▼ buttons, then press the ► or OK button.

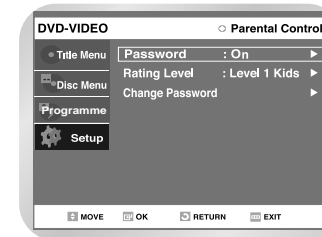
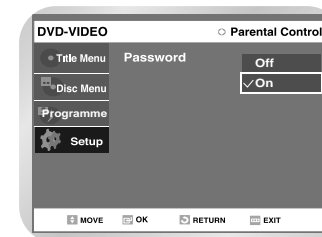

- 6 Select Rating Level you want using ▲▼ buttons, then press the ► or OK button.
 - For example, if you select up to Level 6, discs that contain Level 7, 8 will not play. Higher number indicates the program is more intended to adult use only

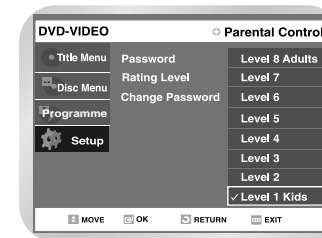

Note ■ Press the RETURN or ◀ button to return to the previous menu. Press the MENU button to exit the menu.
 ■ Refer to Troubleshooting if you forget your password.

About the Change Password;

- 1 Select Change Password using ▲▼ buttons, then press the ► or OK button.
 - The 'Enter the password.' message will be displayed.

- 2 Enter the 4-digit password using the 0 to 9 buttons on the remote control.
 - The 'Confirm the password.' message will be displayed.

- 3 Enter your password again using the 0 to 9 buttons on the remote control.

- Note
- Press the RETURN or ◀ button to return to the previous menu. Press the MENU button to exit the menu.

VCR Setting

If you want your VHS Video tapes to play automatically when you insert them, turn on Auto Play.

- Note
- Only tapes that are missing the Record Safety Tab will play automatically when inserted.

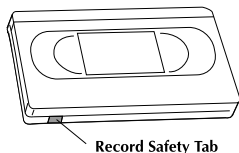

- 1 Open "MENU"
With the VCR in stop mode, Press the MENU button.
- 2 Select "Setup"
Using the ▲▼ buttons, move the selection bar to "Setup" then press ► or OK button to select.
- 3 Select "System"
Use the ▲▼ buttons to highlight "System" then press the OK button.

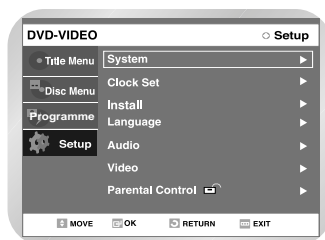

- 4 Select "VCR"
Using the ▲▼ buttons, move the selection bar to "VCR", then press ► or OK to select.

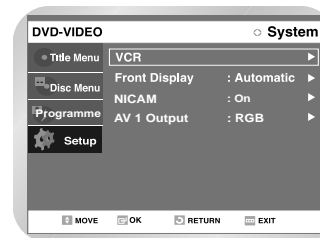

- 5 Select "Tape Length"
Press the ► button to select the Tape Length. This information is usually printed on the tape box. The menu cycles through: E180, E240, E280 or E300.
Once the type of cassette is set, the VCR can display the amount of time remaining on the tape when you press the DISPLAY button.



- 6 Select "Auto Play"
Move the selection bar to "Auto Play," then press ► button to select from the following options:
 - On - The VCR will automatically begin playing a video tape when it is inserted, as long as the safety tab of the cassette has been removed.
 - Off - Auto play is disabled.

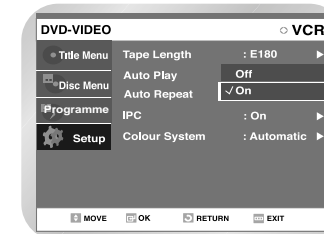

- 7 Select "Auto Repeat"
Move the selection bar to "Auto Repeat". It sets the VCR to play a tape repeatedly [unless a tape control is activated (Stop, Fast Forward or Rewind)].

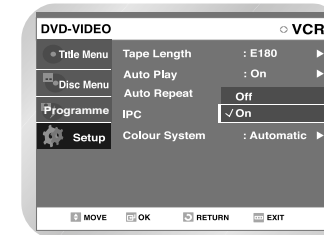

Intelligent Picture Control (IPC)

The intelligent Picture Control Feature allows you to adjust the sharpness of the image automatically, according to your own preferences.

1 Open "MENU"

With the VCR in play mode, Press the MENU button.

2 Select "Setup"

Using the ▲▼ buttons, move the selection bar to "Setup" then press ► or OK button to select.

3 Select "System"

Using the ▲▼ buttons, move the selection bar to "System" then press ► or OK button to select.

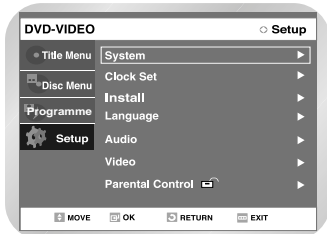

4 Select "VCR"

Move the selection bar to "VCR", then press ► or OK button.

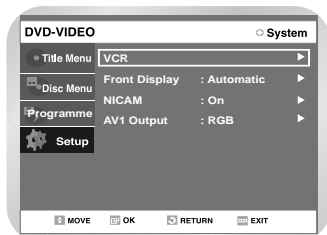

5 Select "IPC"

Using the ▲▼ buttons, move the selection bar to "IPC" then press ► or OK button to select the IPC option.

- When intelligent picture control mode is ON, the sharpness of the image is adjusted automatically.

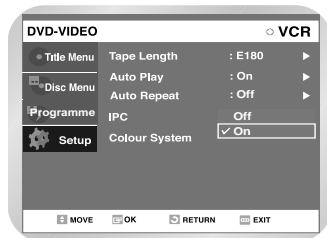

6 To adjust the sharpness manually, press the ▼ button to turn the IPC mode OFF.

7 Press the ◀▶ buttons until the picture is displayed according to your preferences.

- If you do not press a button within ten seconds, the IPC menu disappears automatically.

8 On completion, press RETURN button to exit the menu.

 You also can directly select this function using IPC button on the remote control.

Note

Selection the Colour Mode

Before recording or playing back a tape, you can select the required system standard. Otherwise, the system automatically selects the reception standard when you select Automatic.

- When playing back a tape, the standard is automatically selected by the DVD Recorder-VCR.

1 Open "MENU"

With the VCR in play mode, Press the MENU button.

2 Select "Setup"

Using the ▲▼ buttons, move the selection bar to "Setup" then press ► or OK button to select.

3 Select "System"

Using the ▲▼ buttons, move the selection bar to "System" then press ► or OK button to select.



4 Select "VCR"

Move the selection bar to "VCR", then press ► or OK button.

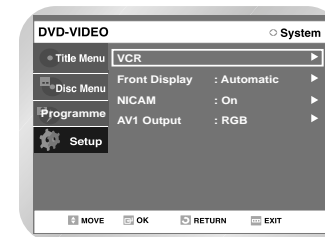

5 Select "Colour System"

Using the ▲▼ buttons, move the selection bar to "Colour System" then press ► or OK button to select Colour System option.
Automatic -> PAL -> B/W.

- Automatic : When playing back a tape, the system standard is automatically selected by the DVD Recorder-VCR.
- B/W : Black and White.

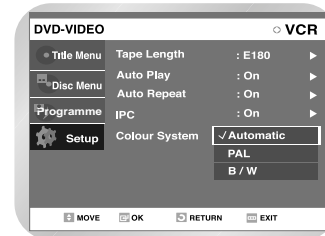

6 On completion, press RETURN three times to exit the menu.

Front Display

You can set the Front Panel Display to be bright all the time, dim all the time, dim during power off.

1 Open "MENU"

With the DVD in Stop mode, press the MENU button.

2 Select "Setup"

Using the ▲▼ buttons, move the selection bar to "Setup" then press ► or OK button to select.

3 Select "System"

Using the ▲▼ buttons, move the selection bar to "System" then press ► or OK button to select.

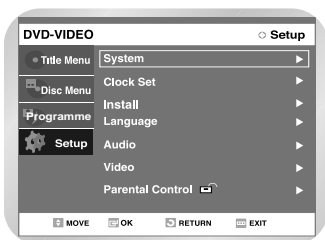

4 Set "Front Display"

Move the selection bar to "Front Display," then press ► or OK button to select from the following options:

- Automatic – Front Panel Display will dim auto- matically during power off.
- Bright – Front Panel Display will be bright all the time.
- Dim – Front Panel Display will be dim all the time.

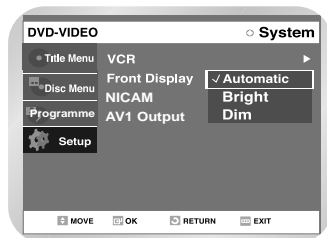

NICAM

NICAM programmes are divided into 3 types. NICAM Stereo, NICAM Mono and Bilingual (transmission in another language). NICAM programmes are always accompanied by a standard mono sound broadcast and you can select the desired sound.

1 Open "MENU"

With the VCR in play mode, Press the MENU button.

2 Select "Setup"

Using the ▲▼ buttons, move the selection bar to "Setup" then press ► or OK button to select.

3 Select "System"

Using the ▲▼ buttons, move the selection bar to "System" then press ► or OK button to select.



4 Select "NICAM"

Using the ▲▼ buttons, move the selection bar to "NICAM" then press ► or OK button until NICAM option is selected.

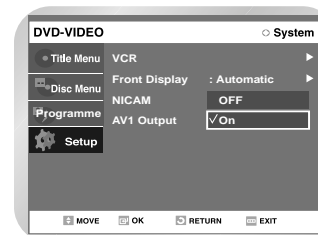

To...	Press ▲ or ▼ , until...
Mono mode	Off is displayed. Off: Only set at this position to record the standard mono sound during a NICAM broadcast if the stereo sound is distorted due to inferior reception conditions.
NICAM mode	On is displayed. On: Normally set at this position.

6 On completion, press RETURN three times to exit the menu.

AV 1 Output

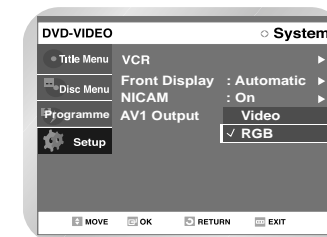

• RGB : Sends RGB signal from the AV JACK (SCART terminal)

• Video : Sends COMPOSITE VIDEO signal from the AV JACK (SCART terminal).

Playback

This section introduces basic functions of playback by disc type.

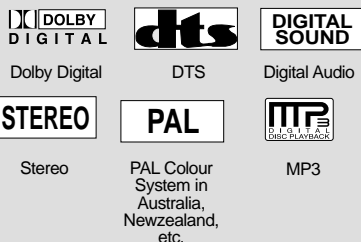

- *Before Playing* 48
- *Playing a Disc* 49
- *Using the Search & Skip Functions* 51
- *Slow Motion Play / Step Motion Play* ... 51
- *About QUICK* 52
- *Repeat Play* 53
- *Using the A-B Repeat Function* 54
- *Moving to a Scene Directly* 54
- *Selecting the Subtitle & Audio Language* 55
- *Changing the Camera Angle* 56
- *Using Bookmarks* 56
- *Zooming-In* 58
- *Check Remaining Time* 59
- *Using the Disc and Top Menu* 59
- *Playing Back an Audio CD (CDDA)* ... 60
- *Play Option Mode* 61
- *To Programme Tracks* 62
- *Photo CD Playback* 63
- *Playing back an MP3 CD* 64
- *Using PIP* 65
- *Playing the VCR* 66
- *Tracking* 66
- *Special VCR Playback Features* 67
- *Variable Search System* 68

Before Playing

Preliminary

Read the following information before playing a disc.

Region code (DVD-Video only)



Both the DVD Recorder-VCR and the discs are coded by region. These regional codes must match in order for the disc to play. If the codes do not match, the disc will not play. The Region Number for this DVD Recorder-VCR is described on the rear panel of the DVD Recorder-VCR.

Disc types that can be played

Disc Types	Disc Logo	Recorded content	Disc Shape	Max. Playing Time
DVD-VIDEO		AUDIO + VIDEO	Single sided(5")	about 240
			Double sided(5")	about 480
AUDIO-CD		AUDIO	Single sided(3.5")	about 80
			Double sided(3.5")	about 160
JPEG CD-R/RW		JPEG Images	Single sided(5")	-
MP3 CD-R/RW			Single sided(3.5")	about 74
DVD-RAM		AUDIO + VIDEO	Single sided(5") (4.7GB)	1(XP: Excellent Quality) 2(SP: Standard Quality) 4(LP: Long Playback) 6(EP: Extended)
			Double sided(5") (9.4GB)	2(XP: Excellent Quality) 4(SP: Standard Quality) 8(LP: Long Playback) 12(EP: Extended)
DVD-RW		AUDIO + VIDEO	5" (4.7GB)	1(XP: Excellent Quality) 2(SP: Standard Quality) 4(LP: Long Playback) 6(EP: Extended)
DVD-R		AUDIO + VIDEO	5" (4.7GB)	1(XP: Excellent Quality) 2(SP: Standard Quality) 4(LP: Long Playback) 6(EP: Extended)

Discs that cannot be played

- DVD-Video with a region number other than "2" or "ALL"
- 3.9 GB DVD-R Disc for Authoring.
- DVD-RAM not recorded following the Video Recording Standard
- Unfinalised DVD-R recorded on other equipment.
- NTSC discs
- DVD-ROM/DVD+RW/PD/MV-Disc/DIVX Video Disc, etc
- CVD/CD-ROM/CDV/CD-G/CD-I



- This DVD Recorder-VCR can only operate with discs that are compatible with DVD-RAM Standard Version 2.0.
- Playback and/or recording may not work for some types of discs, or when specific operations, such as angle change and aspect ratio adjustment, are being performed. Information about the discs is written in detail on the box. Please refer to this if necessary
- Do not allow the disc to become dirty or scratched, Finger prints, dirt, dust, scratches or deposits of cigarette smoke on the recording surface may make it impossible to use the disc for recording.
- To protect a DVD-RAM disc from damage, use a cartridge.
- DVD-RAM/DVD-RW/DVD-R discs may not be able to play on some DVD players, depending on the player, disc and the condition of the recording.
- Discs with NTSC programs recorded on them cannot be recorded using this product.

Playing a Disc

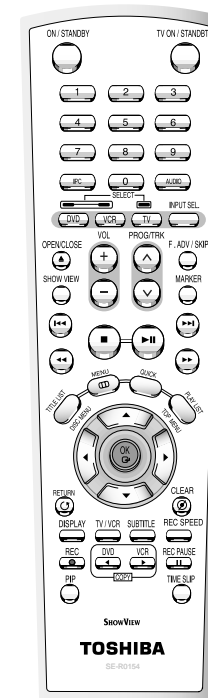

- 1 Press the OPEN/CLOSE button.
- 2 Place a disc gently into the tray with the disc's label facing up.
- 3 **Press OPEN/CLOSE button to close the disc tray.**
 - Your DVD Recorder-VCR closes the disc tray and plays the disc automatically.
 - When a recordable media (DVD-RAM, DVD-RW, DVD-R, etc.) is used, Auto Playback cannot be activated without pressing the Play button. When pressing the ON/STANDBY button while a disc is in the tray, the unit will be activated. Press PLAY to start playback.
 - If you insert MP3 Disc, your DVD Recorder-VCR will display the file list on the screen and start.
 - When a JPEG disc is inserted, folders and a file list are displayed in the Album format.

- 4 Press the STOP button to stop playback.

 **Note** ■ When you stop disc play, the recorder remembers where you stopped, so when you press PLAY button again, it will pick up where you left off. (unless the disc is removed or the recorder is unplugged, or if you press the STOP button twice.) This function is only applicable to DVD-Video, DVD-RAM/ DVD-RW/DVD-R or Audio CDs (CDDA).



- CAUTION**
- Do not move your DVD Recorder-VCR while playing, as this may cause damage to the disc.
 - Make sure to press the OPEN/CLOSE button to open or close the disc tray.
 - Do not push the disc tray while it is being opened or closed, as this may cause a product malfunction.
 - Do not place foreign materials on or in the disc tray.
 - Some functions may perform differently or be disabled depending on the disc type. If this occurs, refer to the instructions written on the disc case.
 - Be especially careful that children's fingers are not caught between the disc tray and the tray chassis when it closes.
 - After turning power on, it will take a few seconds until the DVD operates.

Using the Search & Skip Functions

Searching through a Chapter or Track

During play, press the SEARCH ◀◀ or ▶▶ button on the remote control. The playback speed will change as follows.

DVD-VIDEO	▶▶Fast X2→▶▶Fast X4→
DVD-RAM/DVD-RW	▶▶Fast X8→▶▶Fast X16→
DVD-R	▶▶Fast X32→▶▶Fast X128
AUDIO CD(CDDA)	▶▶Fast X2→▶▶Fast X4→ ▶▶Fast X8

- You can scan the program in reverse order. To return to normal speed playback, press the ▶|| button.

Skipping Chapters or Tracks

During play, press the ◀◀ or ▶▶ button on the remote control.

- **If you press the ◀◀ button**
If you press the ◀◀ button, it moves to the beginning of the chapter or track. Pressing the button once again within 3 seconds returns to the beginning of the previous chapter or track.
- **If you press the ▶▶ button**
If you press the ▶▶ button, it moves to the next chapter or track.

Skipping ahead 30 seconds

In play mode, press F.ADV/SKIP button to cue ahead exactly 30 seconds.

Slow Motion Play/ Step Motion Play

Slow Motion Play (DVD-VIDEO/DVD-RAM/DVD-RW/ DVD-R)

During pause mode, press the SEARCH ◀◀ or ▶▶ button.

- Each time you press the ▶▶ button :
▶ Slow 1/8 →▶▶Slow 1/4 →▶▶Slow 1/2
- Each time you press the ◀◀ button :
◀◀Slow 1/8 →◀◀Slow 1/4 →◀◀Slow 1/2

To return to normal speed playback, press the ▶|| button.

Step Motion Play (DVD-VIDEO/DVD-RAM/DVD-RW/ DVD-R)

During pause mode, press the F.ADV/SKIP button on the remote control.

- Each time the button is pressed, a new frame will appear.

To return to normal speed playback, press the ▶|| button.



- Note** ■ No sound is heard during STEP or SLOW mode.

About QUICK

The QUICK functions allows you to easily search for a desired scene by accessing title, chapter, track and time. You can also change the subtitle and audio settings and set some features including Repeat, Angle and Zoom.

Press the QUICK button on the remote control during playback.

DVD-VIDEO

Title/Chapter/Time/Subtitle/Audio/Repeat/Angle/Zoom



DVD-RAM/DVD-RW

Title/Time/Subtitle/Audio/Repeat/Zoom

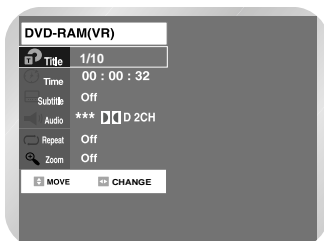

DVD-R

Title/Chapter/Time/Audio/Repeat/Zoom

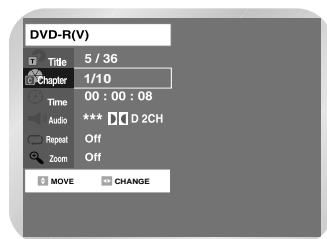

Note

- **What's a track?**
A track is usually a song on a Audio CD (CDDA) or MP3 disc.
- **What's a chapter?**
A title on a DVD disc is usually divided into chapters.
- **What's a title?**
A title means usually a film contained on a DVD disc.
- This may not work for some discs. When an audio CD(CDDA) or a MP3 disc is inserted, depending on the type, the information display may not be appear.
- Regarding the DVD-Video mode, the Time Search function does not operate in some discs.
- To make the screen disappear, press the QUICK again.

Repeat Play

Using Repeat Play (For DVD-VIDEO/DVD-RAM/DVD-RW/DVD-R)

"Chaper repeat" is only available in DVD-Video.

- 1 Press the QUICK button.

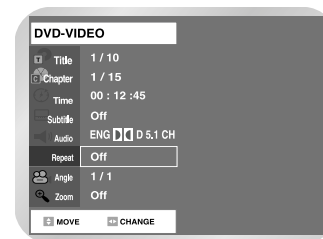

- 2 Use ▲▼ buttons to select Repeat and use ► button to select the A-B, Title or Chapter you want to play repeatedly.
- 3 Press OK button.
Repeat play allows you to repeat title, chapter or A-B.
 - To make the screen disappear, press the QUICK or RETURN button.

Using Repeat Play (For Audio CD/MP3)

- 1 Press the QUICK button during playback. Repeat is highlighted.
- 2 Press OK button.
- 3 Press the ▲▼ buttons to select the Track or Disc you want to playback repeatedly. For MP3 discs, you can select Track, Folder or Disc.
- 4 Press OK button.
Repeat play allows you to repeat a track, folder or the entire disc.

Using the A-B Repeat Function

For DVD-VIDEO/DVD-RAM/ DVD-RW/DVD-R

- 1 Press the QUICK button during playback.

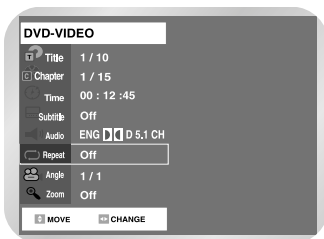

- 2 Use ▲▼ to select Repeat and use ► button to select A-B.

- 3 Press OK button.

- 4 Press the OK button at the point where you want the repeat play to start (A) and then press the OK button at the point where you want the repeat play to Stop (B).
 - The minimum A-B Repeat time is 5 seconds.
 - Your DVD Recorder-VCR will playback the selected section repeatedly.

To return to normal playback

Select Off on the Repeat item or press the CLEAR button on the remote control.

Moving to a Scene Directly

You can find the desired scene easily using the QUICK function.

- 1 Press the QUICK button during playback.

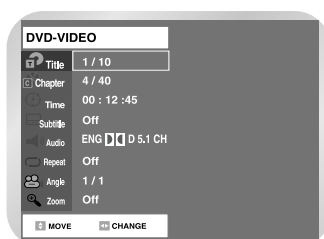

- 2 Use ▲▼ to select the Title, Chapter or time you want to find the desired scene.

- 3 If you want to select a title or chapter, select it using the ◀▶ buttons. Then, press the OK button.
 - You can enter the desired item directly using the number buttons.

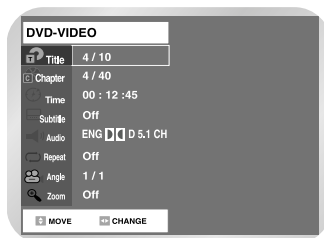

- 4 If you want to move to a desired time, enter the time in the sequence of hour, minute, and second using the number buttons and then press the OK button.

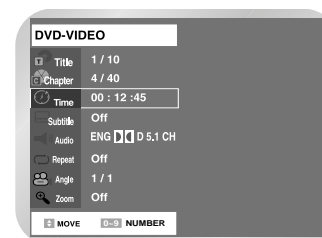

Selecting the Subtitle & Audio Language

Audio languages and subtitle languages may not work depending on disc type. It is available during playback only.

Selecting the subtitle language

- 1 Press the QUICK button during playback.

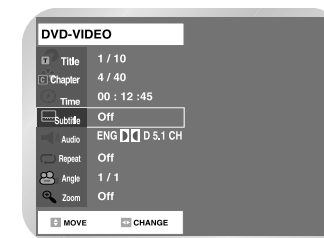

- 2 Use ▲▼ to select Subtitle and use ◀▶ buttons to select the desired subtitle language.
 - If a disc contains subtitles, you can select a desired subtitle language by pressing the ◀▶ buttons.
 - Subtitle display may be different depending on disc type.
 - DVD subtitles may overlap with your TV's subtitles. If this occurs, disable the caption function on your TV.
 - Some discs allow you to select languages from the disc menu only.

Selecting the Audio language

- 1 Press the QUICK button during playback.

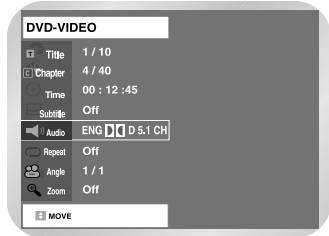

- 2 Use ▲▼ to select Audio and use ◀▶ buttons to select the desired audio language.
 - Audio languages may be different because they are disc-specific.
 - Some discs allow you to select languages from the disc menu only.

Changing the Camera Angle

When a DVD contains multiple angles of a particular scene, you can select the Angle function.

- 1 Press the QUICK button during playback.

- 2 Use ▲▼ to select Angle and use ◀▶ buttons to select the desired angle.

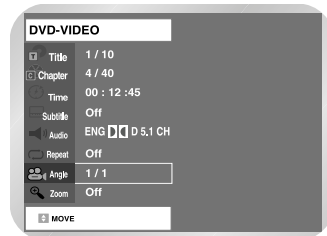

-  **Note** ■ This function is disc-dependent, and may not work with all DVDs. This function does not work when a DVD has not been recorded with a multi-camera angle system.

Using Bookmarks

Set marks at scenes you want to see again so that you can start playback from the marked position.

Setting a book mark

- 1 Press the MARKER button during playback.

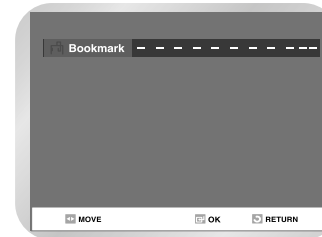

- 2 Press the OK button when the desired scene appears.
 - The number 1 is displayed and the scene is memorized.
- 3 Press ► button to move to the next position.
- 4 Press the OK button again when the desired scene appears.
 - The number 2 is displayed and the scene is memorized. Repeat above to bookmark other positions. You can bookmark up to 10 scenes.

Bookmarking with DVD-RAM/ DVD-RW(VR) disc

- The screen will display "Marker" in place of "Bookmark" if you are playing a DVD-RAM/DVD-RW(VR).
- Up to 99 scenes can be marked.
- If you press the OK button during playback, bookmarks are saved in the order of title.

Playing Back a Bookmark

- 1 Press the MARKER button.
- 2 Press the ◀▶ buttons to select a bookmarked scene.
- 3 Press the OK button to start playing from the selected scene.

Clearing a Bookmark

- 1 Press the MARKER button.

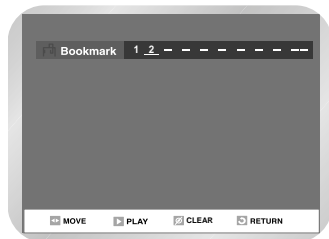

- 2 Press ◀▶ buttons to select a marked scene you want to delete.

- 3 Press CLEAR button to delete the selected bookmark.

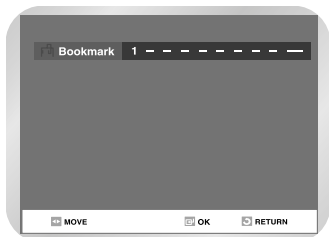

Zooming-In

- 1 Press the QUICK button during playback.

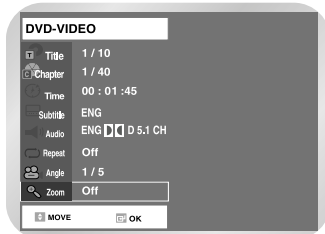

- 2 Use ▲▼ buttons to select Zoom, and then press the OK button.
 - 🔍 will be displayed.

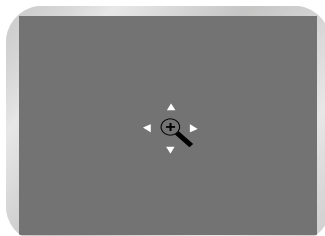

- 3 Press ▲▼◀▶ buttons to move to the area you want to enlarge.

- 4 Press the OK button.
 - The screen will be enlarged to twice the normal size.
 - If you press the OK button again after the screen was enlarged to twice the normal size, the screen size will be enlarged to four times the normal size.

DVD-VIDEO	normal size →2X →4X →2X
DVD-RAM/DVD-RW	→normal size
DVD-R	

- 5 To return to the normal size, press the OK button repeatedly until the screen becomes of normal size.

Check Remaining Time

- 1 Press DISPLAY button on the remote control. Following information will be displayed. (Current deck status, Current counter, recording speed, remaining time, input channel, current time.)



Using the Disc and Top Menu

Some type of discs contains a dedicated menu system that allows you to select special functions for title, chapter, audio track, subtitle, film preview, information on characters, etc.

For DVD-VIDEO disc

- 1 Press the DISC MENU button to enter the disc menu of the disc.
 - Move to the setup menu related to playback operation.
 - You can select audio language and subtitle etc. provided by the disc.

- 2 Press the TOP MENU button to move to the top menu of the disc.
 - Use this button if the disc contains more than one title. Some discs may not support the top menu functionality.

For DVD-RAM/DVD-RW/ DVD-R disc

- 1 Press the TITLE LIST button to display title list.



- **Title List :** Title refers to a recorded video stream. Title List shows list to help you select a title. Since the title list consists of the information on stream that is actually recorded, if one title is deleted, that title cannot be played again.
- **Play List :** This refers to a unit of playback, which is made by selecting a desired scene in the entire Title List. When one playlist is played, only the scene selected by the user will play and then stop. Since only the information necessary for playing a desired scene is included in a playlist, even if that playlist is deleted, the original data will not be deleted.

Playing Back an Audio CD (CDDA)

Each disc has a variety of menu functions available.

- 1 Insert an audio CD (CDDA) into the disc tray.
 - The audio CD menu appears and the tracks (songs) are played back.

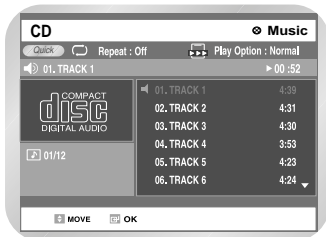

- 2 Press ▲▼ buttons to select the track (song) to start playback from, and then press the OK button.
 - You can also select the track (song) by pressing the number buttons on the remote.

Audio CD(CDDA) Screen Elements

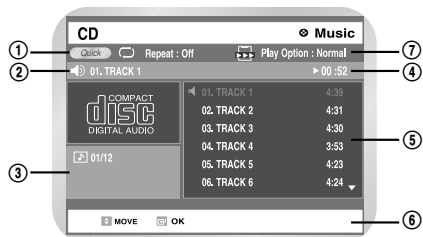

- 1 **Repeat mode:** Repeat off/Repeat Track/Repeat Disc.
- 2 **Current track (song):** Displays the title of the track currently being played.
- 3 Displays the current play index and total track number.
- 4 This shows the operating state of a disc and a playback time corresponding to a portion that is currently played.
- 5 Displays the track list (song list) and the playing time of each track.
- 6 Button display.
- 7 **Play Option:** Normal, Random, Intro or Playlist

Audio CD (CDDA) Screen Elements

- 1 ▲▼ : Select a track (song).
- 2 ► : Playback the selected track (song).
- 3 OK () button: Playback the selected track (song).
- 4 (▶▶) button: Playback the next track.
- 5 (◀◀) button: Returns to the beginning of the current track when pressed during play-back. If you press this button within three seconds after playback starts, the previous track will be played. If you press this button after three seconds, the current track will be replayed from the beginning.

- 6 Press the (◀◀/▶▶) button:
 - ▶▶Fast X2▶▶▶Fast X4▶▶▶Fast X8

Play Option Mode

- 1 Press the QUICK button during playback. Repeat mode will be highlighted.



- During Playback, repeat mode will be highlighted.
- During Stop, Play option will be highlighted.

- 2 Select Play Option Mode using the ◀▶ buttons and press the OK button.
 - The play option screen will appear.

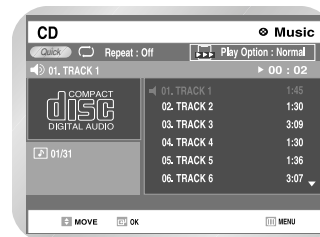

- 3 Select a desired play option using the ▲▼ buttons and press the OK button.

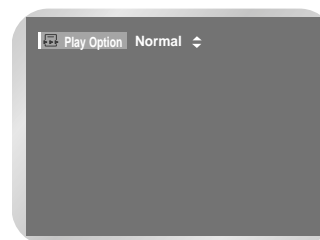

- **Normal :** Tracks on a disc are played in the order in which they were recorded on the disc.
- **Playlist :** The Playlist playback option allows you to select the order in which you want tracks to play.
- **Intro :** The first 10 seconds of each track is played. If you press the ▶▶ button during Intro play, Normal Play will be performed from the track currently playing. When Intro Play is completed, Normal Play is performed.
- **Random :** The Random option plays a disc's tracks in random order. After a random list is generated and played completely, another random list is generated and played. Random Play continues until the play option is changed.



Note

- The same can be used with a Mp3 disc.

To change repeat mode

- 1 Press QUICK during Play to highlight Repeat Mode. Press OK when Repeat Mode is highlighted.

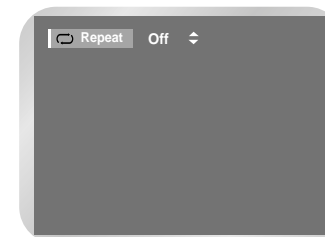

- 2 Select Repeat Mode using the ▲▼ buttons and Press the OK button.
 - A screen allowing you to change the repeat mode (Off, Track, Disc) will appear.

To Program Tracks

You can register a maximum 30 tracks in the playlist.

- 1 During Playback, press the **QUICK button**. Repeat Mode will be highlighted.

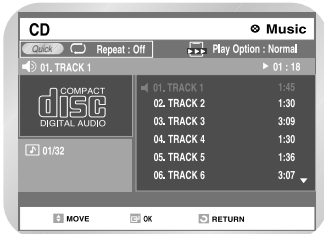

- 2 Select Play Option using the **◀▶** buttons.

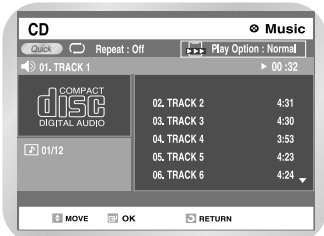

- 3 Press the **OK** button. The play option screen will appear. Select Playlist using the **▲▼** buttons and press the **OK** button.
 - The playlist screen will appear.

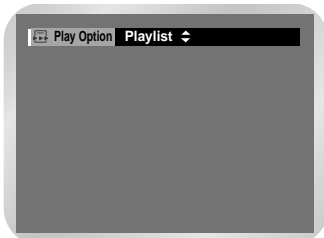

- 4 Select tracks in the order in which you want them to play using the **▲▼** buttons. Press the **OK** button.

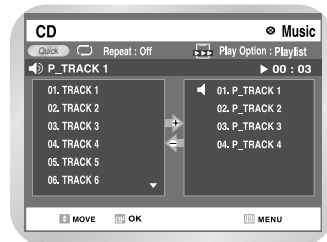

Press the **▶||** (PLAY/PAUSE) button to playback playlist.

- 5 If you playlisted a wrong track, select the wrong track using the **▲▼** buttons and press the **CLEAR** button. The wrong track will be removed.

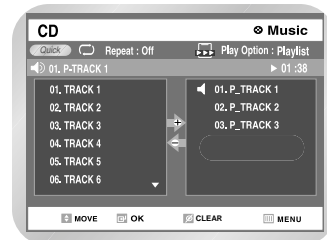
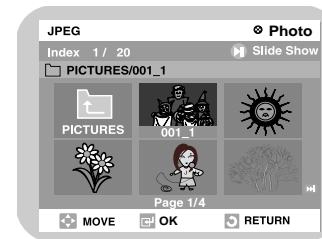

Photo CD Playback

- 1 Insert a photo CD (JPEG) into the disc tray.

- 2 The screen shown below will appear automatically. (Press **▶||** (PLAY/PAUSE) button to switch to slide show mode.)



To see the next 6 pictures, press the **▶||** button. To see the previous 6 pictures, press the **◀◀** button.

- 3 Select Photo using **▲▼** buttons, then press the **OK** button.

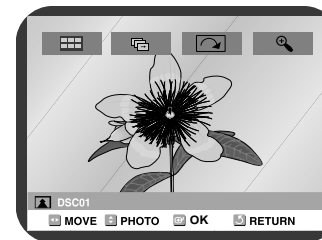

- 4 Use the **◀▶** buttons to select clips menu and then press the **OK** button.

- ☰ : Returns to the Album screen.
- 🖼️ : The unit enters slide show mode. Before the slide show can begin, the photo interval (slide show speed) must be set
- ↻ : Each time the **OK** button is pressed, the picture rotates 90 degrees clockwise.
- 🔍 : Each time **OK** button is pressed, the picture is enlarged up to 4X. (Normal → 2X → 4X → 2X → Normal)

When using a combination MP3/JPEG disc

- 1 If you want to listen to MP3 files, but you're currently in Photo mode, press **■** (STOP) button and then press **MENU** button to bring up the Menu screen.

- 2 Select Music using the **▲▼** buttons then press the **▶** or **OK** button. MP3 screen will be shown.

Playing back an MP3 CD

- 1 Insert an MP3 CD into the disc tray.
 - The MP3 menu is displayed and the tracks (songs) are played back.

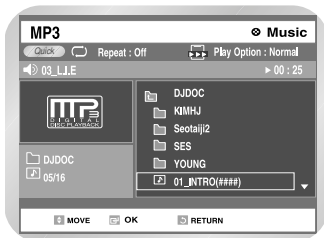

- 2 Press the ▲▼ buttons to select the folder you want to hear, and then press the OK button.
 - Press the ▲▼ buttons to select the track (song) you want to hear, and then press the OK button.
 - You can also select the desired track (song) by pressing the number buttons on the remote.

Buttons on the Remote Control

- 1 ▲▼ : Selects a track (song).
- 2 ► : Playback the selected track (song).
- 3 OK() button:
Plays back the selected track (song) or displays the files in the selected folder.

- 4 RETURN () button:
Moves to the parent of the folder to which the current song belongs.

- 5 (►►) button: Plays back the next track.

- 6 (◀◀) button: Returns to the beginning of the current track when it is pressed during playback. If it is pressed again, your DVD Recorder-VCR plays back the previous track.

When using a combination MP3/JPEG disc

- 1 If you want to watch Photo files, but you're currently in MP3 mode, press STOP button twice and then press MENU button to bring up the Menu screen.
- 2 Select Photo using the ▲▼ buttons then press the ► or OK button. Photo screen will be shown.

Using PIP

The PIP function allows you to view a sub screen together with the main screen in DVD mode. You can watch both DVD and TV together.

- PIP does not work in VCR mode.
- Note

- 1 During Playback, press the PIP button.
 - The current disc is played back on the PIP screen located at the bottom of the screen.



Switching between the PIP and main screens

- 1 Press the PIP button again.
 - The main and PIP screen will be switched.

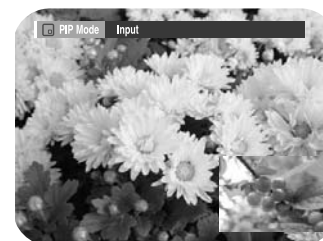

Deactivating PIP

- 1 Press the PIP button again.
 - PIP will be deactivated.



Playing the VCR

To play a standard VHS Video tape, videotape, just insert it into the VCR deck and press the PLAY button. You can turn on the Auto Play to enable the VCR deck to play automatically when you insert a videotape that is missing the Record Safety Tab. See pages 42–43.

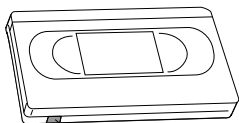

Record Safety Tab

1 Insert VHS Video tape

Insert a standard VHS Video tape into the VCR deck.

- When a videotape is inserted, power will turn on automatically.

2 Play Tape

Press the ►|| (PLAY/PAUSE) button on the remote control or on the front panel of the unit. The videotape will begin to play automatically if it is missing the Record Safety Tab and Auto Play is turned on. See pages 42–43.

3 Stop Playback

Press the ■ (STOP) button on the remote control or on the front panel of the unit.

Tracking

The Tracking adjustment removes the white lines that sometimes appear during playback because of slight differences in recording decks. You may also set tracking manually.

1 Adjust Tracking Manually

During playback, press the PROG/TRK √ / ▲ buttons to remove white lines from the picture.

Special VCR Playback Features

While a videotape is playing, you can enjoy a variety of special playback features, including Still, Frame Advance, Skip, Slow motion, and more. Press the Play button again to resume normal playback.

1 Still

In Play mode, press ►|| (PLAY/PAUSE) to still a single frame.

2 Frame Advance

In the pause mode, press F.ADV/SKIP to advance to the next frame.

3 Cue/Review

In Play mode, press Forward (►►) or Rewind (◄◄) to Cue/review at two speeds:

- Picture Search — Press and release to advance the tape forward or backward at 5 times normal speed.
- Jet Search — Press and hold to advance the tape forward or backward at 7 times normal speed.

4 Skip

In Play mode, press F.ADV/SKIP to cue ahead exactly 30 seconds. Press F.ADV/SKIP repeatedly up to 4 times to cue ahead 2 minutes.

5 Slow motion

In pause mode, press ►► button for slow motion. Press the press ►► button repeatedly to vary slow motion speed from 1/5 to 1/30 of normal playback. Press the ►|| (PLAY/PAUSE) button twice to resume normal viewing.

Variable Search System

Press the QUICK button to display the search screen in the stop mode. When a program is recorded, the starting point is given an Index mark for easy location. However, the VHS Index Search System (VISS) cannot recognize index marks made by old VCRs. If the VCR has trouble finding a mark, it is probably because the cassette was recorded on a VCR without VISS. If you want to index two programs in a row, set your VCR to stop, then start recording each program.

Go to [0:00:00] stop

Use this feature when you want to search for the [0:00:00] counter position on a cassette.

- 1 Press the CLEAR button at the point on the tape where you want to set the counter to [0:00:00].

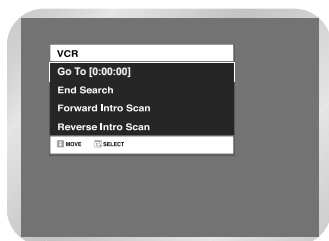

- 2 While a cassette is stopped, press the QUICK button.

- 3 Select "Go To [0:00:00]", and then press the OK button.

Note The VCR will rewind or fast forward, searching for the [0:00:00] counter position, and then automatically stop at that position.

End search

Use this feature when you want to search for a blank position to record a program on a cassette.

- 1 While a cassette is stopped, press the QUICK button.

- 2 Select "End Search", and press the OK button.

Note The VCR will fast forward, searching for a blank position, and then automatically stop at that position. If the VCR reaches the end of the tape during end search, the tape will be ejected.

Scan and play

Use scan and play when you don't know exactly where a program is located on a cassette tape.

- Forward Intro Scan

Highlight "Forward Intro Scan", then press the OK button.

- Reverse Intro Scan

Highlight "Reverse Intro Scan", then press the OK button.

Recording

This section shows various DVD recording methods.

- Before Recording 69
- Recording the current Programme you are watching 71
- Making a One Touch Recording (OTR) 72
- Using the Showview Feature 72
- Modifying Showview Programming 74
- Using the Timer Programming Feature 75
- Editing Timer Programme Feature 76
- Deleting a Timer Programme .. 77
- Showview Extended 78
- Watching the Images Being Recorded (Time Slip) 79
- Recording From External Devices . 79
- Recording through a DV jack 80
- Basic VCR Recording 80
- Special Recording Features 81
- Record Speed 81
- Copy to DVD or VCR 82

Before Recording

Preliminary

This unit can record on various types of discs. Before recording, read the following instructions and select the disc type according to your preference.

Recordable discs

This recorder can record on the following discs.

DVD-RAM	DVD-RW	DVD-R

- DVD-RWs and DVD-RAMs are rewritable.
- DVD-Rs are non-rewritable.

This can be due, among other reasons, to problems and errors that can occur during the creation or recording of DVD and other software and the manufacture of software discs (including blank discs).

Moreover, because of variations in the quality of discs, this recorder may not be able to record on all discs that bear a DVD-RAM, DVD-R or DVD-RW logo, but you should not encounter difficulty if you use only high quality recordable DVD discs.

If you happen to encounter difficulties playing or recording a DVD disc of playing a CD disc, please feel free to call our Customer Service Hotline.

Compatibility between Toshiba Recorder and Other Company's Recorder.

Disc Types	Recording format	Recording Device	Finalising	Additional Recording in the DVD Recorder-VCR
DVD-RAM	VR Mode	Toshiba	X	Recordable
		Other Company	X	Recordable
DVD-RW	VR Mode	Toshiba	finalised not finalised	Not recordable Recordable
		Other Company	finalised not finalised	Not recordable Recordable
	V Mode	Toshiba	finalised not finalised	Not recordable Recordable (D-VR3) Not Recordable (Other Toshiba Models)
		Other Company	finalised not finalised	Not recordable Not recordable
DVD-R	V Mode	Toshiba	finalised not finalised	Not recordable Recordable (D-VR3) Not Recordable (Other Toshiba Models)
		Other Company	finalised not finalised	Not recordable Not recordable



Note

- Finalise
 - This closes the DVD-RW/DVD-R so no additional recording can be done.
- Unfinalise
 - This allows additional recording on a finalised DVD-RW disc.
 - A DVD-RW disc that has been recorded by DAO in a PC cannot be unfinalised.
 - A DVD-RW disc that has been recorded in Video Mode of a different maker's recorder cannot be unfinalised.
 - A DVD-R disc cannot be unfinalised.

Recording Formats

When you insert an unused disc, the following message appears. Since available functions differ depending on the disc type, select a disc that best fits your preferences.

DVD-RAM: Use after formatting the disc.



DVD-RW: When unused DVD-RW disc is first inserted, the message "Do you want to initialize this disc" will be displayed. If you select Yes, the disc will be formatted in VR mode. If you want to change the mode, refer to Formatting a Disc on page 102.

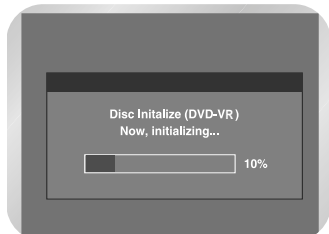

DVD-R: Formatting DVD is unnecessary and only Video Mode Recording is supported.

DVD-RW(Video mode)/DVD-R

- This mode automatically creates chapters at specified intervals during finalisation.
- Simple editing (erasing titles/changing title name).

DVD-RAM/DVD-RW(VR mode)

- This mode involves multiple editing functions (such as deletion of a whole title, partial deletion of a title, etc.).
- Various editing options using a created Playlist.

Unrecordable pictures

Pictures with copy protection cannot be recorded on this DVD Recorder-VCR.

When the DVD Recorder-VCR receives a copy guard signal while recording, recording stops and the following message appears on the screen.

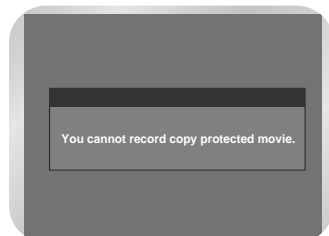

Concerning copy control signals.

Broadcasts that contain copy control signals may have one of the following three signal types, Copy-Free, Copy-Once and Copy-Never. If you want to record a copy-once type program, use DVD-RW with CPRM in VR Mode and DVD-RAM.

	Copy-Free	Copy-Once	Copy-Never
DVD-RW(Ver.1.1)	Yes	No	
DVD-RW(Ver.1.1) with CPRM			
VR mode	Yes	Yes*	
Video mode	Yes	No	
DVD-R	Yes	No	
DVD-RAM (Ver. 2.0)	Yes	Yes*	

Once "Copy Once" has been recorded, additional recording cannot be performed.

This * marked parts are compatible with CPRM.

Recording the current Programme you are watching



Preliminary

1. Check the aerial cable is connected.
2. Check the remaining time of disc.
DVD-RAM/DVD-RW discs should be formatted in advance before beginning recording. Most new discs are sold unformatted. Make sure to format your unformatted discs before recording.
3. Corresponding station should be preset.

1 Press the OPEN/CLOSE button and place a recordable disc on the disc tray.

2 Press the OPEN/CLOSE button to close the disc tray.

3

- Press the PROG/TRK ∇ / \blacktriangle buttons to select the station you want to record.
- The AV1, AV2 or AUX using the INPUT SEL. button for a satellite tuner or external Video source.

4 Press the REC SPEED button on remote control, to select the recording speed (quality).

- XP(High, approx. 1 hour) \rightarrow SP(Standard, approx. 2 hours) \rightarrow LP(Low, approx. 4 hours) \rightarrow EP(Extended Play, approx 6 hours)

5 Press the \bullet (REC) button.

6 Press the \blacksquare (STOP) button to stop or finish a recording in progress.

- The message "Updating the information of disc. Please wait for a moment".

Pausing / Resuming

- Press the REC PAUSE button to pause a recording in progress.
- Press the REC PAUSE button again during pause to resume recording.
- You can switch stations by pressing the PROG/TRK ∇ / \blacktriangle buttons while recording pauses.



Note

- You can't change the recording speed and programme during recording.
- Recording will stop automatically if there is not enough space for recording.
- Up to 99 titles can be recorded onto a disc.
- If the power interrupted due to power failure or other reasons, the title being recorded will not be saved onto the disc.
- Recording will stop automatically if a copy-protected image is input.
- Do not use DVD-R authoring discs with this unit.

Making a One Touch Recording (OTR)



One-Touch Recording (OTR) allows you to add recording time in 30-minute increments up to 9 hours at the touch of a button.

1 Use the PROG/TRK \vee/\wedge buttons or number buttons to select the station to record.

2 Start Recording.
Follow the instructions on page 71 to begin recording.

3 Activate OTR.
While in Record mode, press the REC button again to activate One-Touch Recording (OTR).

- Record length 0:30 appears on the On-Screen Display and the DVD Recorder-VCR will record for exactly 30 minutes.

4 Add Recording Time.
Continue pressing REC to add recording time in 30 minute increments up to 9 hours.

- The DVD Recorder-VCR stops recording automatically when the time has elapsed.

→ REC → 30 → 1'00 → 1'30 → 2' → 2'30 → 3' → 9' ← 8' ← 7' ← 6' ← 5' ← 4' ← 3'30 ←

Using the ShowView Feature

Before presetting your DVD Recorder-VCR:

- Switch on both the television and your DVD Recorder-VCR
- Check that the date and time are correct
- Insert the cassette or Recordable DVD on which the programme is to be recorded (safety tab intact) Up to twelve programmes can be preset.

1 To enter a ShowView, press the SHOW VIEW button. Press the $\blacktriangle/\blacktriangledown$ and \blacktriangleright or OK buttons to select ShowView.

- A message is displayed to allow you to enter the ShowView code.
- If all twelve programmes have been set, the message Timer is full is displayed. Refer to page 77 if you wish to cancel a preset recording.



2 Press the numeric buttons to enter the code opposite the programme that you wish to record in your television magazine.

- If you wish to correct the ShowView code that you are entering:
 - Press the \blacktriangleleft button until the digit to be corrected is cleared
 - Enter the correct digit

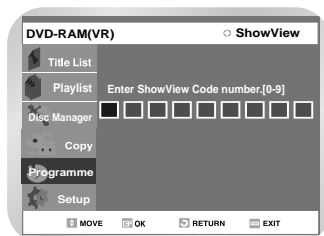

3 Press the OK button.

- The information concerning the programme is displayed.
- When using the ShowView function for the first time with stored stations, the programme number flashes. This one time, you must enter the station number manually by pressing the $\blacktriangle/\blacktriangledown$ buttons.

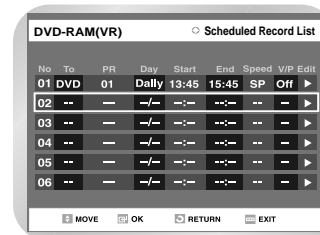
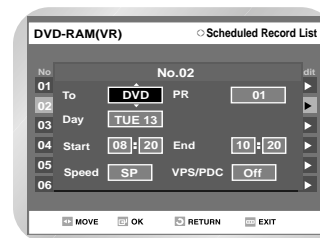

Refer to the following page if:

- The programme number or times flash
- You wish to modify the programme

4 If the programme and times are correct, press the OK button.

5 Press the ON/STANDBY button to activate the timer.

6 Refer to page 77 if you wish to:

- Check that your DVD Recorder-VCR has been programmed correctly
- Cancel a preset recording



Note

- The numbers next to each TV programme listing are ShowView code numbers, which allow you to programme your DVD Recorder-VCR instantly with the remote control. Tap in the ShowView code for the programme you wish to record.
- ShowView is a trademark of Gemstar Development Corporation. The ShowView system is manufactured under licence from Gemstar Development Corporation.

Modifying ShowView Programming



If you wish to correct the programme displayed or modify certain elements, such as the recording speed, refer to following instruction before pressing RETURN button.

If you wish to...	Then...															
Select an input source other than the tuner (AV1, AV2 or AUX)	<ul style="list-style-type: none"> Press the ◀ or ▶ buttons, until the PR selection mode. Press the INPUT SEL. button one or more times to change the input source selection. <p>Result: The programme number is replaced by:</p> <ul style="list-style-type: none"> The AV1, AV2 or AUX source using the INPUT SEL. button for a satellite tuner or external video source <ul style="list-style-type: none"> The input source must be selected before changing any other value. 															
Record a programme every day (Monday to Sunday) at the same time	<ul style="list-style-type: none"> Press the ◀ or ▶ buttons, until the Day selection mode. Press the ▲ or ▼ buttons, until the Daily value is displayed. 															
Record a programme every week on the same day and at the same time	<ul style="list-style-type: none"> Press the ◀ or ▶ buttons, until the Day selection mode. Press the ▲ or ▼ buttons, until the W- (Week) value is displayed, followed by the required day. <p>Example: W-SA (Weekly Saturday)</p>															
Extend the recording time	<ul style="list-style-type: none"> Press the ◀ or ▶ buttons, until the End selection mode. Press the ▲ or ▼ buttons to increase or decrease the stop time. 															
Select the recording speed	<ul style="list-style-type: none"> Press the ◀ or ▶ buttons, until the recording speed selection mode. Press the ▲ or ▼ buttons until the correct indication is displayed: <table border="0" style="margin-left: 20px;"> <tr> <td>• AUTO (Auto tape speed select)</td> <td>VCR</td> <td>• AUTO</td> </tr> <tr> <td>• XP (high quality)</td> <td></td> <td>• SP</td> </tr> <tr> <td>• SP (Standard Play)</td> <td></td> <td>• LP</td> </tr> <tr> <td>• LP (Long Play)</td> <td></td> <td></td> </tr> <tr> <td>• EP (extended mode)</td> <td></td> <td></td> </tr> </table> 	• AUTO (Auto tape speed select)	VCR	• AUTO	• XP (high quality)		• SP	• SP (Standard Play)		• LP	• LP (Long Play)			• EP (extended mode)		
• AUTO (Auto tape speed select)	VCR	• AUTO														
• XP (high quality)		• SP														
• SP (Standard Play)		• LP														
• LP (Long Play)																
• EP (extended mode)																
Select the PDC recording	<ul style="list-style-type: none"> Press the ◀ or ▶ buttons, until the VPS/PDC off mode. Press the ▲ or ▼ buttons until the "On" indication is displayed. Do not select PDC unless you are sure the programme you wish to record is broadcast with PDC. If you do set PDC On (by selecting "On" in the right - hand column on the screen), then you must set up the start-time EXACTLY according to the published TV schedule. Otherwise the timer recording won't take place. 															

Using the Timer Programming Feature

Preliminary

1. Check the antenna cable is connected.
 2. Check the remaining time of the disc.
 3. Check the date and time are correct.
- Make sure the Clock has been set (Setup - Clock Set) before you proceed with a timer recording.

1 Press the SHOW VIEW button.

- Programme menu is displayed.

Using the MENU button:

- ① Press the MENU button.
- ② Press the ▲▼ buttons to select Programme and then press the ▶ or OK button.
- ③ Select Standard Timer.

- If the current time is not set. Set the current time first.



2 Press the ▲▼ buttons to select "Standard Timer" and then press the ▶ or OK button.

3 Press the ▲▼ button to select scheduled Record List, and then press the ▶ or OK button

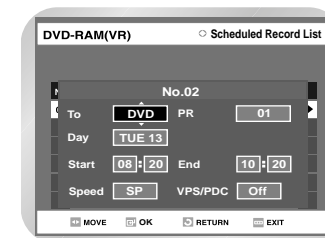
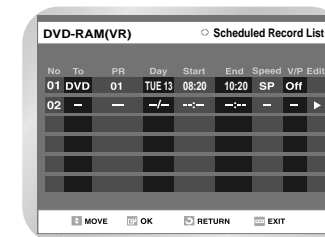

4 Set timer recording option.

- The Timer Recording screen is displayed. Fill the input items using the arrow buttons.

◀▶ : Moves to the previous/next item,
▲▼ : Sets a value.

- **TO** : Select the media to record DVD or VCR.
- **PR** : The video input source (AV1 or AV2), or the broadcasting channel you want to make a timer recording from.
- **Day** : Set the recording day.
- **Start/End Time** : Start and End time of the timer recording.
- **Speed** : See page 76
- **VPS** : Video Programme System
- **PDC** : Programme Delivery Control

DVD

AUTO : Select when you want to set video quality automatically. It depends on the remaining time on the DVD.

XP (high quality) : Select when video quality is important. (Approx. 1 hour)

SP (standard quality) : Select to record in standard quality. (Approx. 2 hours)

LP (low quality) : Select when a long recording time is required. (Approx. 4 hours)

EP (extended mode) : Select when a longer recording time is required. (Approx. 6 hours about 1.2 Mbps)

VCR

AUTO : Select when you want to set video quality automatically. It depends on remaining time of VCR tape.

SP : Standard Play, for best picture quality.

LP : Long Play, for maximum recording time (3 times SP).

5 Press the OK button.

If you make a mistake

Press the ◀▶ buttons to select the item you want to change.

If the timer settings overlap

The programs are recorded in order of priority. If timer recording is set for the first program and then again for the second program and both programs overlap, the first program has priority. After recording of the first program is complete, the second program starts being recorded.

To exit without saving the current setting

Press the MENU or SHOW VIEW button.

To return to the previous menu

Press the RETURN button if you don't want to set a timer recording.

6 Turn the power off to finish the timer recording. Timer Recording will not work when the power is on.

- When power is switched on, program registered for recording in Timer Recording will be automatically cleared after the start time and date have passed.

- ⌚ will appear on the front panel. It means that a timer recording is registered.

- ⌚ will blink if disc or tape is not inserted.



- The Timer Programming time may differ from the set time depending on disc status and overall timer recording status (for example, recording times overlapping, or when the previous recording ends within 2 minutes before the start time of the next recording.)

Editing Timer Programming Feature



Follow these directions to edit the timer record list.

Editing the settings for a timer recording

1 Press the MENU button.

2 Press the ▲▼ buttons to select "Programme" and then press the ▶ or OK button.

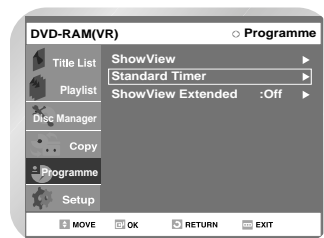

3 Press the ▲▼ buttons to select "Standard Timer" and then press the ▶ or OK button.

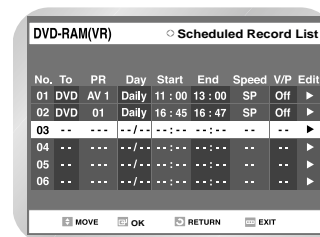

4 Press the ▲▼ buttons to select the number of the timer programming you want to edit, and then press the ▶ or OK button.

- The Edit and Delete items are displayed.

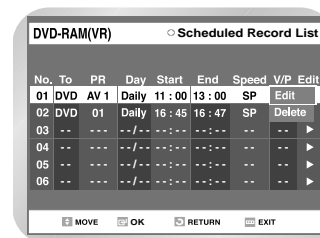

5 Press the ▲▼ buttons to select "Edit", and then press the OK button.

- The timer programming screen is displayed. Edit the items you want to modify. See the timer programming section for more information on timer programming input sources. (75 page)

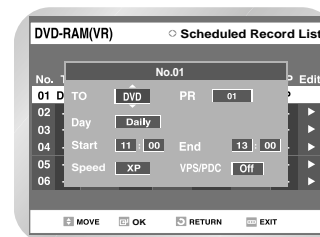

6 Press the OK button to confirm the edited setting.

Deleting a Timer Programming



Follow these directions to delete an entry from the timer record list.

1 Press the MENU button.

2 Press the ▲▼ buttons to select Programme and then press the ▶ or OK button.

3 Press the ▲▼ buttons to Standard Timer, and then press the ▶ or OK button.

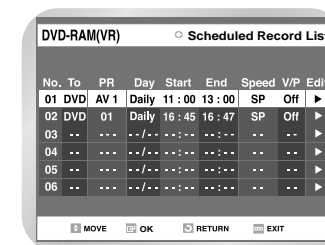

4 Press the ▲▼ buttons to select the number of the timer recording you want to delete, and then press the OK button.

- The "Edit" and "Delete" items are displayed.

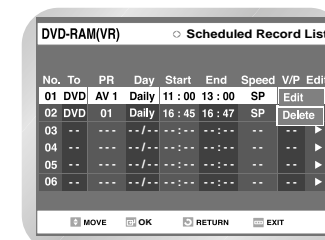

5 Press the ▲▼ buttons to select "Delete", and then press the OK button.

- You will be prompted with the delete confirm message such as 'Do you want to delete 'No.01'?'.

6 Press the ◀▶ buttons to select Yes, and then press the OK button.

- The selected entry will be deleted from the list.

7 Press the MENU button after finishing the operation. The menu screen will disappear.

ShowView Extend

To prevent delays or over-runs the DVD Recorder-VCR has a function called ShowView Extend allowing you to extend the recording time by up to 60 minutes.

- Only use if PDC is not available or set to OFF.

1 Open "MENU"
With the DVD in Stop, press the MENU button.

2 Select "Programme"
Using the ▲▼ buttons, move the selection bar to "Programme" then press ▶ or OK to select.

3 Select "ShowView Extend"
Using the ▲▼ buttons, move the selection bar to "ShowView Extended", then press OK to select.

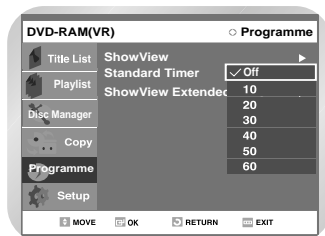

4 Press the corresponding ▲▼ buttons, until the ShowView Extend time, then the press ▶ or OK to select.

5 Press the MENU button after finishing the operation.

Watching the Images Being Recorded (Time Slip)



This function allows you to watch the recently recorded 10-second images on the PIP screen while a recording is in progress.

1 Press the TIME SLIP button on the remote control.

- The recently recorded 10-second images are played back on the PIP screen.
- This function starts to operate 10 seconds from the time you press the ●(REC) button.
- On the TIME SLIP screen, you can playback, scan, or perform other operations for the recorded program using the playback related buttons.
- Press the ◀◀ button to scan the recording in the reverse order, from the end to the start.
- Press the ▶▶ button to scan to the recently recorded 10-second images.

2 Press the ■(STOP) button once to clear the TIME SLIP function.

- To stop a recording while a TIME SLIP function is in progress, press the ■(STOP) button twice.



- Note
- The Time Slip feature only works with DVD-RAM discs.
 - The Time Slip function is not supported in the DV recording mode.

Recording From External Devices

Preliminary

Check the remaining time of disc and tape for the recording. Adjust the recording speed.

1 Connect the Output jack of your External Devices to the SCART input connector or AUX on the front of using Audio/Video Cable.

2 Power on your DVD Recorder-VCR and switch to input source mode by pressing the INPUT SEL on the remote .
The front panel display changes on the following sequence
PR → AV1 → AV2 → AUX → DV

3 When your DVD Recorder-VCR is in the stop state, set the operation mode of your External Devices to play mode.

4 Press the ●(REC) button on your DVD Recorder-VCR when the image from which you want to start recording is displayed.

5 Press the ■(STOP) button on your DVD Recorder-VCR when the recording is finished.

- Note
- Also refer to the user manual for your External Devices when recording through input mode using Audio/Video cable or Scart jack.

Recording through a DV jack



Follow these directions to record onto a disc the outputs of a camcorder that has a DV output jack.

- 1 Connect the DV output jack of your camcorder to the DV input jack on the front of your DVD Recorder-VCR using a DV cable.
- 2 Power on your DVD Recorder-VCR and switch to DV mode by pressing the INPUT SEL. on the remote.
- 3 With your DVD Recorder-VCR stopped, set the operation mode of your camcorder to play mode.
- 4 Press the ●(REC) button on your DVD Recorder-VCR when the image from which you want to start recording is displayed.
- 5 Press the ■(STOP) button on your DVD Recorder-VCR when the recording is finished.

- Note**
- Some camcorders may not work with your DVD Recorder-VCR even if they have a DV output jack.
 - Also refer to the user manual for your camcorder when recording through a DV jack.

Basic VCR Recording

Preliminary

1. Check TV Programme and Antenna connections.
2. Check the remaining time on the tape.

You can record a TV show in progress by inserting a blank tape and pressing the ●(REC) button. You can even add time in 30-minute increments up to 9 hours by pressing the ●(REC) button repeatedly; see page 72.



Note

- Be sure your videotape has a Record Safety Tab. If the tab is missing, you can cover the opening with a small piece of tape. Warning: Do not cover this opening unless you are sure you want to record over the tape.

- 1 **Insert Tape**
Insert a blank Video tape into the VCR deck.
 - Make sure the tape is long enough to record the entire program.
To change the Recording Speed, see page 71.
- 2 **Select a Programme to Record**
Use the 0–9 buttons or the PROG/TRK ∨ / ∧ buttons to select the desired Programme, or press the INPUT SEL. button to select AV1, AV2 or AUX or DV if recording from an external device connected to the front or rear inputs, respectively.

- 3 **Start Recording**
Press the REC button on the remote control or front panel.
For options while recording is in progress, see "Special Recording Features".

- 4 **Pause/Resume Recording**
Press the || (REC PAUSE) button.
Press ●(REC) again to resume.

- 5 **Stop Recording**
Press the ■(STOP) button.

Special Recording Features

While a recording is in progress, you can watch a different Programme, watch a different media, or add recording time in 30-minute increments.

- 1 **Watch a Different Channel**
Press the TV/VCR button on the remote to switch to your TV tuner, then select a different channel on your television.
- 2 **Watch a different media during recording**
You can watch DVD during VCR recording or watch Video tape during DVD recording.
 - During VCR recording, insert a DVD in the DVD deck. The output will automatically change to the DVD and start playback.
 - During DVD recording, insert a Video tape in the VCR deck. The output will automatically change to the VCR and start playback. (Only if tape is missing the safety tab)
- 3 **Add Recording Time**
Refer to the One-Touch Recording (OTR).
- 4 **Recording DVD and VCR at the same time**
You can record DVD and VCR at the same time, but both modes must be set up to record separately.
 - Press the DVD/VCR button to set the unit to DVD or VCR mode.
 - Choose input mode (PR, AV1, AV2 AUX, DV), for DVD or VCR.
 - Choose REC SPEED for DVD or VCR.
 - Press REC button for DVD or VCR.



Note

- When DVD Recorder-VCR is connected to TV using S-Video cable, the playback screen on the video tape will not display during DVD recording.
- You cannot record different channel at the same time.
- The DVD and VCR cannot start recording at the exact same time. You must set one mode to start recording, then the other.

Record Speed

You can slow down the recording speed from SP to LP in order to fit 3 hours of programming on a E-180 tape.

- 1 **Start Recording**
Follow the Basic VCR Recording on page 80.
- 2 **Set Record Speed**
Press the REC SPEED button on the remote control to set the Record Speed to one of the following options:
 - SP – Standard Play, for best picture quality.
 - LP – Long Play, for maximum recording time (3 times SP).



Note

- The selected Record Speed will appear on the front panel display and on-screen display.

Maximum Recording Time

Type	Recording Time (in SP)
E-180	180 mins. or 3 hours
E-240	240 mins. or 4 hours
E-280	280 mins. or 4 hours and 40 mins.
E-300	300 mins. or 5 hours



Note

- When you watch or record on the VCR during DVD Recording, some function buttons may not operate.
The message "This function is not available." will be displayed.

Copy to DVD or VCR



You can copy DVD to VCR or VCR to DVD. Press MENU button and select Copy.



DVD to VCR



VR mode

1 Select DVD --> VCR to copy DVD to VCR.

- Check the remaining time on the tape.

2 If you want to copy from the Copylist, choose "Edit Copylist".

- To copy from "Edit Copylist", you need to make a Copylist. To make and select a "New Copylist" (See pages 92–93).
- If you want to copy directly, choose "Direct Copy".

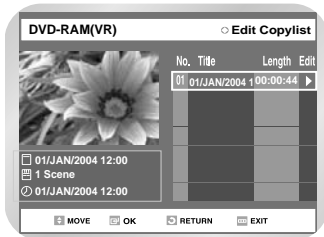
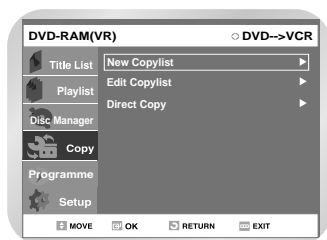

3 Select the Copylist, you want to copy

using the ▲▼ buttons and then press ▶ button. To copy play list, select "Copy".

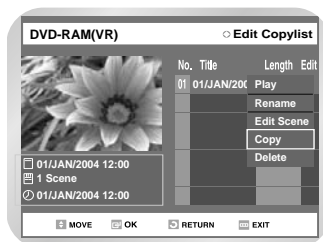

Direct copy DVD to VCR



1 Insert DVD disc you want to copy.

2 Insert VHS tape.

3 Press VCR copy button on front panel or remote control.

4 To stop recording press the STOP button.

VCR to DVD

1 Select VCR --> DVD to copy VCR to DVD.

VCR --> DVD scene will be displayed.

- Check the remaining time on the disc.



2 Press OK button to select the start position.

You can use ►, ◀◀ or ▶▶, ◀◀ or ▶▶ buttons to search for the Start position.

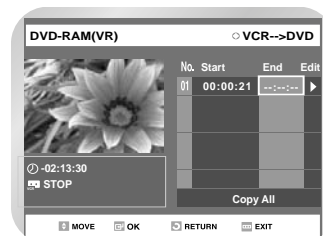

3 Select the End position in the same way.

A copylist will be generated.

- The copylist cannot be saved if you press the RETURN or MENU button to exit the menu.

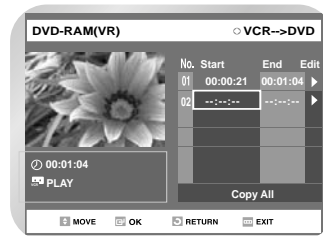

4 Press OK button to choose the list you want to copy.

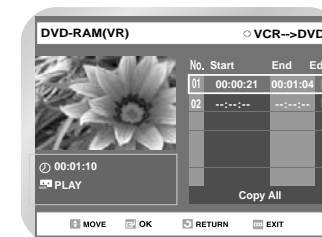

5 To copy Copylist, select "Copy".

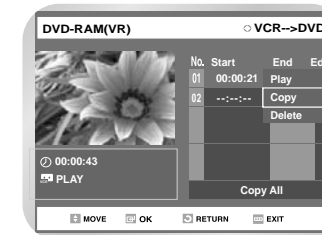

- The VCR will fast forward, searching for a start position and then automatically start a copy.
- It may not be match up with Start and END point exactly.
- If you want to copy all copylist, select "Copy All".

Direct copy VCR to DVD

1 Insert the VHS tape you want to copy.

2 Insert Recordable DVD disc.

3 Press DVD COPY button on front panel or remote control.

4 To stop recording press the STOP button.

Editing

Viewing the Menu Functions for a Disc



There are a variety of menu functions depending on the disc type. Press the MENU button.

No Disc

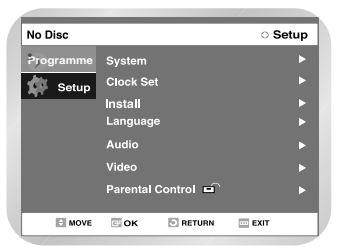

Programme Setup

DVD-VIDEO

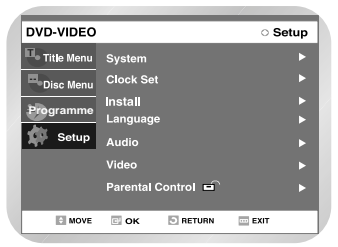

Title Menu
Disc Menu
Programme Setup

CD

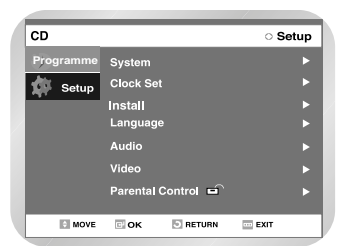

Programme Setup

JPEG+MP3

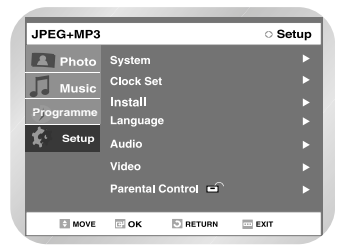
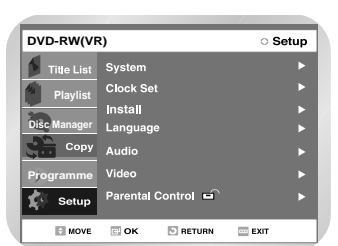

Photo
Music
Programme Setup

DVD-RW(VR)



Title List
Playlist
Disc Manager
Copy
Programme Setup

DVD-R(V)

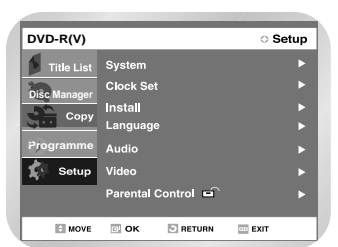

Title List
Disc Manager
Copy
Programme Setup

DVD-RAM(VR)

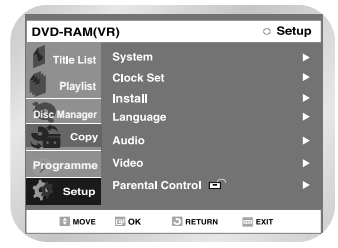

Title List
Playlist
Disc Manager
Copy
Programme Setup



- Note
- Press the MENU button again to hide the menu screen. You can configure the settings on the Setup screen using the arrow and OK buttons.
 - If recording or editing could have been finished properly because of any kinds of error, such as sudden power failure, The recording or editing might have not been done. Please be aware that a material that has been damaged is unable retrieved to its original content.

- Viewing the Menu Functions for a Disc 84
- Viewing Title List 86
- Playing a Title List Entry 87
- Renaming a Title List Entry 88
- Deleting a Title List Entry 89
- Locking a Title List Entry 90
- Deleting a Section from a Title List Entry 91
- Creating a Playlist Entry 92
- Editing a Playlist Entry 94
- Editing Scene for a Playlist Entry . 95
- Copying a Playlist Entry to the VCR . 99
- Deleting a Playlist Entry from the Playlist 99
- Disc Manager 100

Viewing Title List



You can playback the recorded titles, edit a title name, edit record list entries and lock or unlock the record list.

- 1 Insert the recorded disc.
Press the MENU button.



- Note
- Title List : Title refers to a recorded video stream. Title List shows a list to help you select a title. Since the title list consists of the information on data that is actually recorded, if one title is deleted, that title cannot be played again.

- 2 Press the ▲▼ buttons to select Title List, and then press the ► or OK button,
or press the TITLE LIST button on the remote control.
• The Title List screen is displayed.

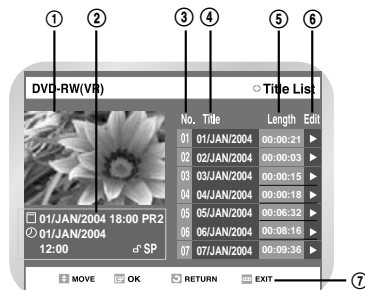

- 1 Playback screen for recorded entry.
- 2 Information window for the selected entry: Title name, recording date, recording time, lock status, recording mode.
- 3 Recorded entry No.
- 4 Recorded entry title.
- 5 Recording duration (i.e., playtime).
- 6 Record list edit items.
- 7 Button display.

Record List edit items

- 1 Press the ▲▼ buttons to select an entry to edit, and then press the ► or OK button.
 - Play : Playbacks the selected entry.
 - Rename : Renames the title of the selected entry.
 - Delete : Deletes the selected entry from the list.
 - Edit : Deletes a desired section. (DVD-RAM/DVD-RW(VR mode))
 - Protection : Locks or unlocks the selected entry.
- 2 Press the MENU button after the operation is finished. The menu screen will disappear.

Playing a Title List Entry



Follow these directions to playback an entry from the Title List.

- 1 Insert the recorded disc.
Press the MENU button.

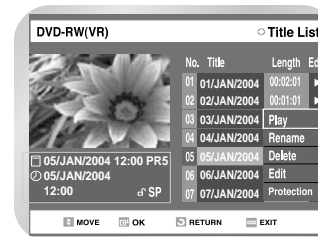

- 2 Press the ▲▼ buttons to select Title List, and then press the ► or OK button,
or press the TITLE LIST button on the remote control.
• The View Title List screen is displayed.
- 3 Press the ▲▼ buttons to select an entry you want to playback from Title List, and then press the ► or OK button.
• The Edit Title List menu is displayed.

- 4 Press the ▲▼ buttons to select Play, and then press the OK button.
 - The selected entry (title) will be played back.

- Note
- You can also playback a recorded program by pressing the QUICK button using the title, chapter or time items.

Renaming a Title List Entry



Follow these directions to rename a title list entry, i.e., to edit the title of a recorded program.

- 1 Insert the recorded disc.
Press the MENU button.
- 2 Press the ▲▼ buttons to select Title List, and then press the ► or OK button,
or press the TITLE LIST button on the remote control.
 - The View Title List screen is displayed.
- 3 Press the ▲▼ buttons to select an entry you want to rename from Title List, and then press the ► or OK button.
 - The Edit Title List menu is displayed.

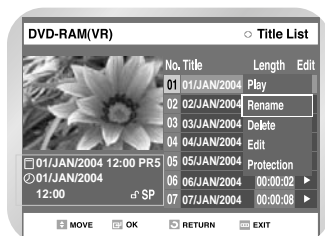

- 4 Press the ▲▼ button to select Rename, and then press the OK button.
 - The Rename screen is displayed.

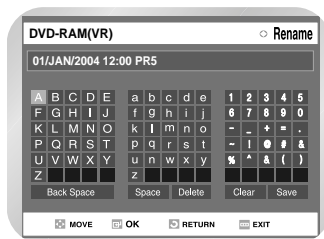

- 5 Enter the desired characters using the arrow (▲▼◀▶) buttons.
 - Back Space: Moves the cursor to the previous character. (Functions the same as CLEAR)
 - Space: Enters a blank and moves the cursor to the right.
 - Delete: Deletes the character at the cursor position.
 - Clear: Deletes all the character inputs.
 - Save: Registers the character inputs.
- 6 Press the arrow buttons to select Save, and then press the OK button.
 - The changed title is displayed on the title item of the selected entry.

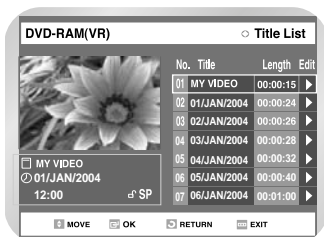

Deleting a Title List Entry



Follow these directions to delete an entry from the Title List.

- 1 Insert the recorded disc.
Press the MENU button.
- 2 Press the ▲▼ buttons to select Title List, and then press the ► or OK button,
or press the TITLE LIST button on the remote control.
 - The View Title List screen is displayed.
- 3 Press the ▲▼ buttons to select an entry you want to delete from Title List, and then press the ► or OK button.
 - The Edit Title List menu is displayed.

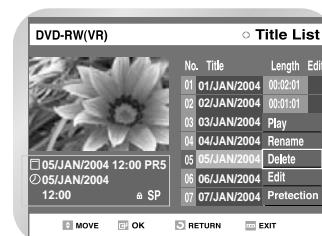

- 4 Press the ▲▼ buttons to select Delete, and then press the OK button.
 - DVD-RAM, DVD-RW(VR mode): Since Playlist is present, the message "Do you want to delete? (Related Playlist may be deleted.)" is displayed.
 - DVD-RW(Video mode), DVD-R: Since Playlist is not present, the message "Do you want to delete?" is displayed.
 - You cannot delete a protected entry. If you want to delete a protected entry, select "OFF" in the protection menu.



Note ■ Be careful, since you cannot recover an entry once it is deleted from Title List.

- 5 Press the ◀▶ buttons to select yes and then press the OK button.

Locking a Title List Entry



Follow these directions to lock an entry if you want to protect it from unexpected deletions.

- 1 Insert the recorded disc.
Press the MENU button.
- 2 Press the ▲▼ buttons to select Title List, and then press the ► or OK button.
 - The View Title List screen is displayed.
- 3 Press the ▲▼ buttons to select an entry you want to protect from Title List, and then press the ► or OK button.
 - The Edit Title List menu is displayed.



- 4 Press the ▲▼ buttons to select Protection, and then press the OK button.

- You will be prompted with the confirmation message 'Title Protection:'.



- 5 Press the ◀▶ buttons to select On, and then press the OK button.
 - The Lock icon (🔒) on the information window for the selected entry changes to the locked status.

Deleting a Section from a Title List Entry



Follow these directions to delete a section from a Title List entry.

- 1 Insert the recorded disc.
Press the MENU button.
 - You cannot recover a section once it is deleted from Title List.
- 2 Press the ▲▼ buttons to select Title List, and then press the ► or OK button,
 - or press the TITLE LIST button on the remote control.
 - The View Title List screen is displayed.
- 3 Press the ▲▼ buttons to select an entry you want to edit from Title List, and then press the ► or OK button.
 - The Edit Title List menu is displayed.

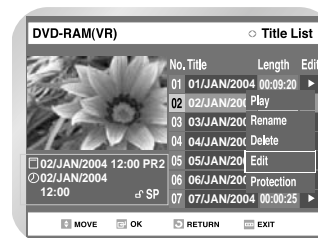

- 4 Press the ▲▼ buttons to select Edit, and then press the OK button. The Edit Program is displayed.

- ① Playback bar
- ② Playtime
- ③ Section deletion start point window and time
- ④ Section deletion end point window and time

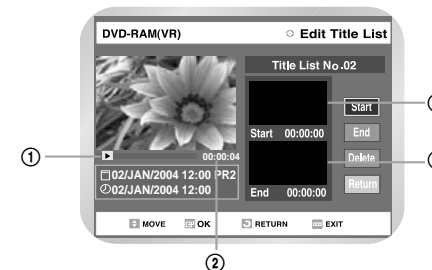

- 5 Search the start points of the section you want to delete using the playback related buttons.
 - Playback related buttons: ►||, ◀◀, ▶▶.

Note Be careful, since you cannot recover a section once it is deleted from Title List.

- 6 Press the ▲▼ buttons to select Start, and then press the OK button.
 - The image and time at the start point are displayed on the start window.

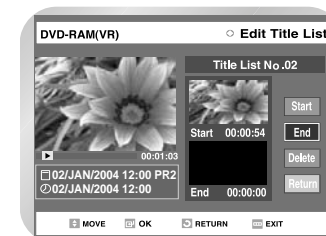

7 Press the OK button at the end point.

8 The image and time at the end point are displayed the end point window.

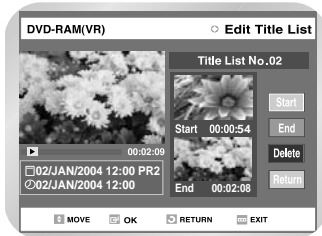

9 Press the ▲▼ buttons to select Delete, and then press the OK button.

- Message "Do you want to delete?" will be displayed.
- If you want to cancel, press RETURN button to return to the Title List screen.



10 Press the ◀▶ buttons to select yes and then press the OK button.

11 Press the MENU button to exit the menu after the operation is finished. The Title List screen will disappear.

- Note
- The length of the selection to delete should be at least 5 seconds long.
 - If the length of the section to delete is less than 5 seconds, you will be prompted with the message "The range is too short".
 - If the end time precedes the start time, you will be prompted with the message "End point cannot be marked earlier than start point".

Creating a Playlist Entry

Follow these directions to create a new playlist entry from a recorded title.

1 Insert the recorded disc. Press the MENU button when the disc is stopped.

2 Press the ▲▼ buttons to select Playlist, and then press the ▶ or OK button.



3 Press the ▲▼ buttons to select New Playlist, and then press the ▶ or OK button.

- The Make Scene screen is displayed.

- Note
- Play List : The Playlist is a unit of playback, that is created by selecting a desired scene in the Title List. Since only the information necessary for playing a desired scene is included in a playlist, even if that playlist is deleted, the original data will not be deleted.

4 Select the start point of the section from which you want to create a new scene using the playback related buttons, and then press the ▶|| button.

- Playback related buttons: ▶||, ▶▶, ◀◀, ◀◀, ▶▶

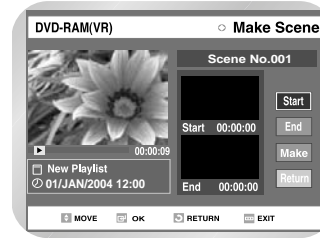

5 Press the ▲▼ buttons to select Start, and then press the OK button.

- The image and time at the start point are displayed on the Start window.
- The yellow-colored selection bar moves to the End item.

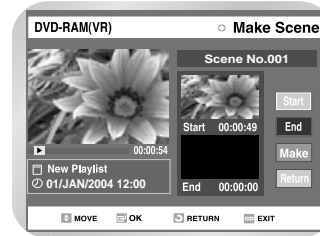

6 Search the end point of the section from which you want to create a new scene using the playback related buttons, and then press the ▶|| button.

7 Press the OK button to select END point.

- The image and time at the end point are displayed on the End window.
- The yellow-colored selection bar moves to the Make item.



8 Press the OK button to confirm.

- A new make scene screen is displayed.
- Scenes to be made will be added to the current playlist.
- Repeat the above steps to make more than one scene.

- Note
- If you want to make a new playlist, go to the beginning of step1.
 - You can check and see all the scenes on Edit scene screen. (see page 95)

9 If you want to cancel, press the ▲▼ buttons to select RETURN, and then select the OK button.

- The Edit Playlist screen is displayed.

10 Press the MENU or RETURN button to exit the menu.

- The Playlist screen will disappear.

- Note
- You can create up to 99 playlist entries.

Editing a Playlist Entry



Follow these directions to playback or edit (rename, edit scene, copy and delete) the newly created playlist entries.

- 1 Insert the recorded disc.
Press the MENU button when the disc is stopped.
- 2 Press the ▲▼ buttons to select Playlist, and then press the ► or OK button.
- 3 Press the ▲▼ buttons to select Edit Playlist, and then press the ► or OK button, or press the **PLAY LIST** button on the remote control.
 - The Edit Playlist screen is displayed.

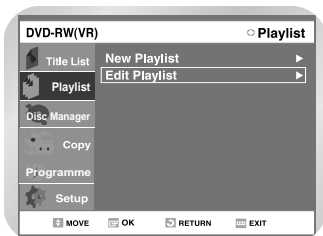

- 4 Press the ▲▼ button to select an entry (title) you want to edit from the Playlist, and then press the ► or OK button.
 - The Edit Playlist menu is displayed.
 - Play, Rename, Edit Scene, Copy, Delete



- 5 Press the ▲▼ buttons to select a function to use, and then press the OK button.
 - **Play**: Playbacks the selected entry.
 - **Rename**: Renames the title of the selected entry. Functionality is the same as the Rename item in the Edit Record List.
 - **Edit Scene**: Edits scenes of the selected entry.
 - **Copy**: Copies the selected entry to the VCR.
 - **Delete**: Deletes the selected entry from the list.



- 6 Press the MENU or PLAY LIST button after the operation is finished. The Playlist screen will disappear.

Playing Playlist Entries

Follow these directions to playback the playlist entries.

- 1 Press the ▲▼ buttons to select Play, and then select the OK button.
 - The playlist entries will be played back.
 - The screen returns to the Edit Playlist screen when the playback is finished.
- 2 Press the ■ (STOP) button to stop the playback in progress.
 - The screen returns to the Edit Playlist screen.

Renaming Playlist Entries

Follow these directions to rename a playlist entry, i.e., edit the title of a playlist entry.

- 1 Press the ▲▼ buttons to select Rename, and then press the OK button.
 - The Rename screen is displayed.
- 2 Select the desired characters using the arrow ▲▼◀▶ buttons.
 - Functionality is the same as the Rename item in the Edit Record List screen.



- 3 Press the arrow buttons to select save, and then press the OK button.
 - The Name you changed is displayed on the title item of the selected playlist entry.

Editing Scene for a Playlist Entry



Follow these directions to edit scenes for a playlist entry.

- 1 Insert the recorded disc.
Press the MENU button when the disc is stopped.
- 2 Press the ▲▼ buttons to select Playlist, and then press the ► or OK button.
- 3 Press the ▲▼ buttons to select Edit Playlist, and then press the ► or OK button, or press **PLAY LIST** button on the remote control.
 - The Edit Playlist screen is displayed.

- 4 Press the ▲▼ buttons to select an entry (title) you want to edit from the Playlist, and then press the ► or OK button.
 - The Edit Playlist menu is displayed.

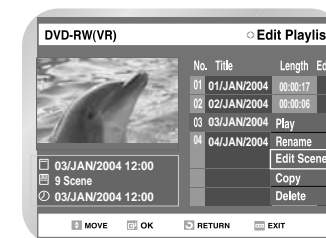

- 5 Press the ▲▼ button to select Edit Scene, and then press the OK button.
- The Edit Scene screen is displayed.

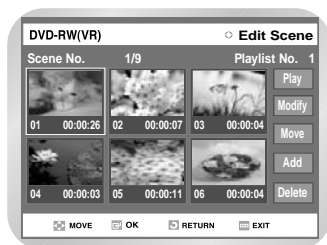

A. Playing a Desired Scene

- 1 Press the ▲▼◀▶ buttons to select the scene you want to playback, and then press the OK button.
- The playlist entry to playback is selected.

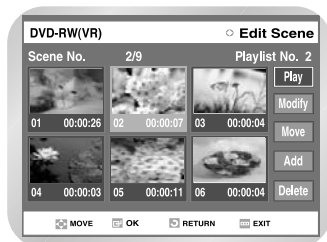

- 2 Press the OK button.
- The selected scene is played back.

B. Modifying a Scene (Replacing a Scene)

- 1 Press the ▲▼◀▶ buttons to select the scene you want to modify, and then press the OK button.
- 2 Press the ▲▼ buttons to select Modify, and then press the OK button.
- The Modify Scene screen is displayed.

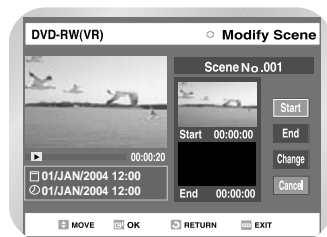

- 3 Select the start point of the section with which you want to modify the selected scene using the playback related buttons.
- Playback related buttons: ▶||, ▶|, ◀◀, ◀, ▶▶.

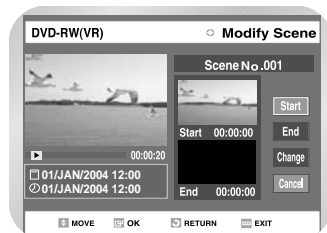

- 4 Press the ▲▼ buttons to select Start, and then press the OK button.
- The image and time at the start point are displayed on the Start window.



- 5 Press the OK button at the end point of the scene.

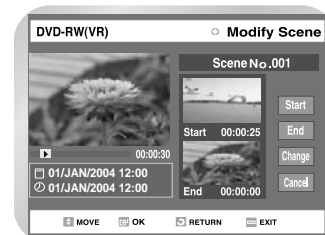

- 6 Press the ▲▼ buttons to select Change, and then press the OK button.
- The scene you wanted to modify is changed with the selected section.
 - If you want to cancel a modification, select cancel and then press the OK button.

- 3 Press the ▲▼◀▶ buttons to select the position where you want to move the selected scene, and then press the OK button.

- The selected scene is moved to the new position.



- Note
- You cannot move the selected scene to the position of the next scene, because the selected scene should be inserted before that position.

C. Moving a Scene (Changing the Position of a Scene)

- 1 Press the ▲▼◀▶ buttons to select the scene you want to move (change the position), and then press the OK button.

- 2 Press the ▲▼ buttons to select Move, and then press the OK button.
- A yellow selection window is displayed on the scene to move.

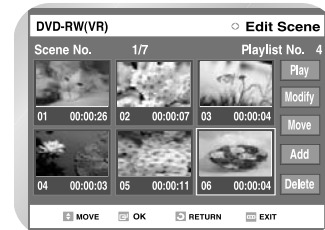

D. Adding a Scene

- 1 Press the ▲▼◀▶ buttons to select the scene before which you want to add a new scene, and then press the OK button.

- A yellow selection window is displayed on the scene to add as a new scene.

- 2 Press the ▲▼ buttons to select Add and then press the OK button.
- The Add Scene screen is displayed.

- 3 Select the start point of the section to which you want to add the scene in step 1 using the playback related buttons.
- Playback related buttons: ▶||, ▶|, ◀◀, ◀, ▶▶.

- 4 Press the ▲▼ buttons to select Start, and then press the OK button.
- The image and time at the start point are displayed on the Start window.

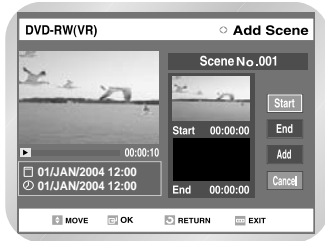

- 5 Select the end point of the section you want to add as a new scene using the playback related buttons.

- 6 Press the ▲▼ buttons to select End, and then press the OK button.
- The image and time at the end point are displayed on the End window.



- 7 Press the ▲▼ buttons to select Add, and then press the OK button.
- The section you wanted to add is added before the scene selected in step 1.



- If you want to cancel select cancel and then press the OK button.

E. Deleting a Scene from the Playlist

- 1 Press ▲▼◀▶ buttons to select the scene you want to delete, and then press the OK button.
- 2 Press the ▲▼ buttons to select delete, and then press the OK button.

Copying a Playlist Entry to the VCR



- 1 Insert the recorded disc and the tape. Press the MENU button when the disc is stopped.
- 2 Press the ▲▼ buttons to select Playlist, and then press the ▶ or OK button.
- 3 Press the ▲▼ buttons to select Edit Playlist, and then press the ▶ or OK button, or press the PLAY LIST button on the remote control.
 - The Edit Playlist screen is displayed.



- 4 Press the ▲▼ buttons to select an entry(title) you want to copy to the VCR, and then press the ▶ or OK button.
 - The Edit Playlist menu is displayed. Play, Rename, Edit Scene, Copy, Delete
- 5 Press the ▲▼ buttons to select Copy, and then press the OK button.
 - The title you choose is played and copied to VCR tape.

Deleting a Playlist Entry from the Playlist



- 1 Insert the recorded disc. Press the MENU button when the disc is stopped.
- 2 Press the ▲▼ buttons to select Playlist, and then press the ▶ or OK button.
- 3 Press the ▲▼ buttons to select Edit Playlist, and then press the ▶ or OK button, or press the PLAY LIST button on the remote control.
 - The Edit Playlist screen is displayed.
- 4 Press the ▲▼ buttons to select an entry (title) you want to delete from the Playlist, and then press the ▶ or OK button.
 - The Edit Playlist menu is displayed. Play, Rename, Edit Scene, Copy, Delete



- 5 Press the ▲▼ buttons to select Delete, and then press the OK button.
- You will be prompted with the delete confirmation message "Do you want to delete?".



- 6 Press the ◀▶ buttons to select Yes, and then press the OK button.
- The screen returns to the Edit Playlist screen automatically after the delete operation finished.

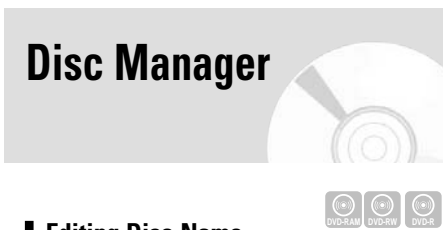
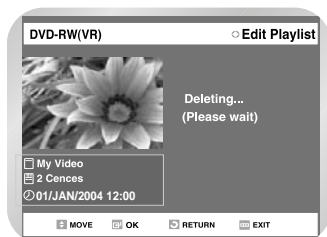

Editing Disc Name

Follow these directions to give a name to a disc

- 1 Insert the disc.
Press the MENU button when the disc is stopped.
- 2 Press the ▲▼ buttons to select Disc Manager, and then press the ▶ or OK button.



- 3 Press the ▲▼ buttons to select Disc Name, and then press the ▶ or OK button.
 - The Edit Name screen is displayed.

- 4 Enter the desired characters using the arrow buttons.

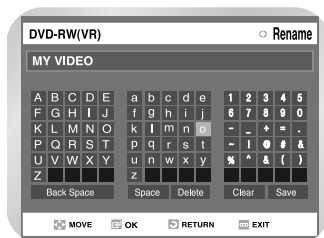

- 5 Press the ▲▼◀▶ buttons to select Save, and then press the OK button.
 - A disc name is given to the disc.

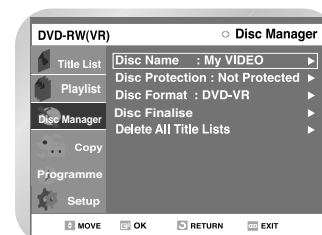

- Note
- You may need to clear cartridge protection or unlock the protect before beginning editing.

Disc Protection

Disc Protection allows you to protect your discs from disc format and program deletion due to unintended operations.

- 1 Press the MENU button when the disc is stopped.

- 2 Press the ▲▼ buttons to select Disc Manager, and then press the ▶ or OK button.



- 3 Press the ▲▼ buttons to select Disc Protection, and then press the ▶ or OK button.



- 4 Press the ▲▼ buttons to select Protected, and then press the OK button.



- Note
- Disc Protection will operate only if cartridge protect is cleared.

Formatting a DVD-RAM/DVD-RW Disc

Use these instructions to format a disc. The cartridge write protect tab should be set to the unprotect position. The disc protection should also be cleared.

- 1 Insert a disc to be formatted.
Press the MENU button with the disc stopped.

- 2 Press the ▲▼ buttons to select Disc Manager, and then press the ► or OK button.



- 3 Press the ▲▼ buttons to select Disc Format, and then press the ► or OK button.

- You will be prompted with the confirmation message 'Do you want to format disc?'.
- If you select "Yes" you will be prompted with the confirmation message 'All data will be deleted. Do you want to continue?'.



- 4 Press the ◀▶ buttons to select Yes, and then press the OK button.

- The disc is formatted.

DVD-RW

You will be prompted with the confirmation message "Choose the recording format for DVD-RW".

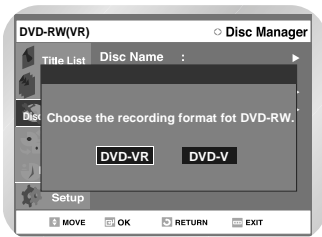

DVD-VR and DVD-V are defined according to their recording format

	DVD-VR	DVD-V
Editing	Possible (Partial editing is possible)	Inconvenience
DISC	DVD-RAM DVD-RW	DVD-RW DVD-R

Delete All Title Lists



Follow these instructions to delete all title lists.

- 1 Insert the recorded disc.
Press the MENU button with the disc stopped.

- 2 Press the ▲▼ buttons to select Disc Manager, and then press the ► or OK the button.



- 3 Press the ▲▼ buttons to select Delete All Title Lists, and then press the ► or OK button.

- You will be prompted with the confirmation message 'Do you want to delete all title lists?'.



- You cannot delete a protected entry. If you want to delete a protected entry, disable Protection for it on the Lock item.
- Disc Protection: When Protected or Cartridge Protection has been set, or when a DVD-RAM is used, data cannot be deleted from a disc.

- 4 Press the ◀▶ buttons to select Yes, and then press the OK button.

- The disc is deleted.

Cartridge Protect Info (DVD-RAM)

Disc Protect allows you to protect discs from disc formatting and program deletion due to unintended operations. The cartridge write protect tab should be set to the unprotect position to be able to make a recording to a DVD-RAM disc.

- 1 Press the MENU button with the disc stopped.

- 2 Press the ▲▼ buttons to select Disc Manager, and then press the ► or OK button.

- 3 Press the ▲▼ buttons to select Cartridge Protection Info, and then press the ► or OK button.

- The cartridge protection info for the disc is displayed.

If the disc cartridge is protected, open the disc tray and check the disc.

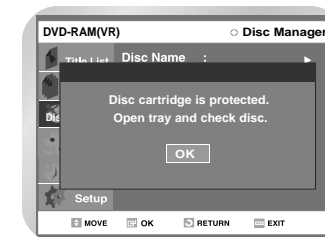

If the disc cartridge is not protected, proceed with recording to the disc.

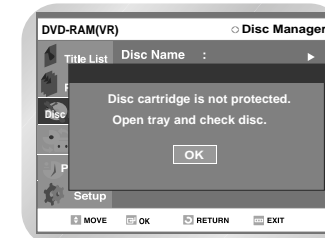

- Disc Protection will operate only if cartridge protect is set to Not Protected.

Finalising a disc



After you record titles onto a DVD-RW/DVD-R disc with your DVD Recorder-VCR, it needs to be finalised before it can be played back on external devices.

- 1 Insert the recorded disc.
Press the MENU button with the disc stopped.

- 2 Press the ▲▼ buttons to select Disc Manager, and then press the ► or OK button.



- 3 Press the ▲▼ buttons to select Disc Finalise, and then press the ► or OK button.

- You will be prompted with the message 'Do you want to finalise disc?'. If you select Yes, you will be prompted again with the message 'Disc will be finalised. Do you want to continue?'



Press the ◀▶ buttons to select Yes, and then press the OK button.

- The disc is finalised.



Note

- Once a disc is finalised, you cannot delete entries from the record list.
- After being finalised, the DVD-R operates in the same manner as a DVD-Video.
- Depending on the kind of disc, the displayed screen may be slightly different.
- Finalising will be taken few minutes. If you turn the unit on/off or open the tray during finalising, you will not be able to use the disc anymore.

Unfinalising a disc (V/VR mode)



- 1 Insert the finalised disc.
Press the MENU button with the disc stopped.

- 2 Press the ▲▼ buttons to select Disc Manager, and then press the ► or OK button.

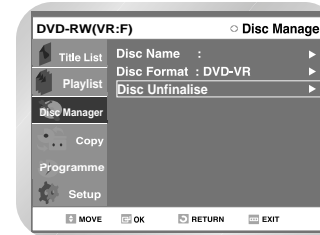

- 3 Press the ▲▼ buttons to select Disc Unfinalise, and then press the ► or OK button.

- You will be prompted with the message 'Do you want to unfinalise disc?'. If you select Yes, you will be prompted again with the message 'Disc will be unfinalised. Do you want to continue?'



Press the ◀▶ buttons to select Yes, and then press the OK button.

- The disc is unfinalised.

- A DVD-RW can be finalised or unfinalised in Video mode.

	Finalise	Unfinalise
Mark	DVD-VIDEO(RW)	DVD-RW(V)
Operation	Same as DVD-Video	Additional recording, protection and deletion are possible.

- A DVD-RW can be finalised or unfinalised in VR mode.

	Finalise	Unfinalise
Mark	DVD-RW(VR:F)	DVD-RW(VR)
Operation	Additional recording, deletion, editing, and protection are impossible.	Additional recording, deletion, editing, and protection are possible.

Reference

- *Troubleshooting (DVD-VIDEO/DVD-RAM/DVD-RW/DVD-R)* 107
- *Troubleshooting* 108
- *Problems and Solutions (VCR)* 109
- *Specifications* 110

Troubleshooting (DVD-VIDEO/DVD-RAM/DVD-RW/DVD-R)



Troubleshooting



Problems and Solutions (VCR)



Specifications



LIMITED WARRANTY TO ORIGINAL PURCHASER

Troubleshooting (DVD-VIDEO/DVD-RAM/DVD-RW/DVD-R)



If your product malfunctions, go through the check points below before contacting a Toshiba authorized service center,

No power.	<ul style="list-style-type: none"> • Check whether the power cord is securely plugged into the power outlet. • Did you press the ON/STANDBY button of your DVD Recorder-VCR.
The input is displayed for a while when the power turns on.	The DVD Recorder-VCR requires some time to initialize after it is turned on.
Cannot record TV programs.	<ul style="list-style-type: none"> • Check whether the power cord is securely plugged into the power outlet. • Did you set the DVD Recorder-VCR channel settings correctly? • Check the free space on your DVD-RAM/DVD-RW/DVD-R disc. • Check the antenna cable is connected.
Timer recording does not work properly.	<ul style="list-style-type: none"> • Check the recording time, end time and current time settings again. • Recording will be cancelled, if the power is removed due to a power failure or other reason during recording.
Cannot record.	<ul style="list-style-type: none"> • Check whether the disc is formatted. This product can record on formatted discs only. (See page 102.) • Is the DVD-RAM cartridge protected? Set the write protect tab to the unprotect position. • Check whether your DVD-RAM/DVD-RW/DVD-R disc has a sufficient free space.
I pressed the REC button but there is no response.	Recording is available on DVD-RAM/DVD-RW/DVD-R discs only. If a program is copy protected, you cannot record it.
I forget the pass word for parental care.	Press the ◀◀ and ▶▶ button of your DVD Recorder-VCR at the same time when the power is on. All settings including password will revert to factory settings. Do not use it if not absolutely required. (Note that this function is available only when there is no disc inserted.)
Cannot playback the disc.	<ul style="list-style-type: none"> • Check whether the disc is inserted correctly with the label facing up. • Check the regional code of your DVD disc. • This DVD Recorder-VCR cannot playback some types of disc. (See page 7.)
No sound.	<ul style="list-style-type: none"> • Are you watching a program in slow or skip mode? If you are playing a program at a speed other than normal speed, sound is not output. • Check the connections and initial settings. • Check whether the disc is damaged. Clean up the disc, if necessary. • Check whether the disc is inserted correctly with the label facing up.

Troubleshooting



⊗ icon appears on the screen.	You cannot use the operation or function due to one of the following reasons: (1) Your DVD disc does not support the feature (for example, angles) (2) You've requested a title, chapter, or scan time that is out of the correct range.
Play mode settings are different from the settings configured with the Setting menu.	The disc does not support all the selected functions. In this case, some settings you configure on the Setting menu may not work properly.
Cannot change the aspect ratio.	Aspect ratio is fixed for DVD disc.
No audio output.	Check whether you selected correct digital output options in the Audio Output Options menu.
No video or audio output. The disc tray is ejected after 2 to 5 seconds.	Did you move your DVD Recorder-VCR suddenly from a cold place to a warm place? In this case, remove discs and wait for one to two hours with the power on, and then, insert the disc and try to playback again. It will work properly when condensation is removed.
Angle operation does not work during playback of a DVD disc.	Angle operation is available only when the disc contains the images captured at different angles.
The disc revolves, but no image or bad quality images are output.	<ul style="list-style-type: none"> • Check whether there is damage or foreign materials on your disc. • Some discs with bad manufacturing quality may not be played back. • If the scene changes from dark to bright suddenly, the screen may jitter temporarily, but it is not a defect.
Desired sound language and subtitle language are not played.	Sound languages and subtitle languages are disc-specific. Only the sound and subtitle languages contained on a DVD disc are available and displayed on the disc menu.
The remote control doesn't work.	<ul style="list-style-type: none"> • Point the remote control at the remote control sensor on your DVD recorder-VCR. Operate within distance. (15ft) Remove obstacles between your DVD Recorder-VCR and remote control. • Check whether the batteries are depleted.
Other problems	<ul style="list-style-type: none"> • Read the table of contents and then find and read the sections describing your problem, and follow the directions given. • Turn the unit off and on. • If your problem still persists, contact your nearest Toshiba service center.

Problems and Solutions (VCR)



Before contacting a Toshiba authorized service center, perform the following simple checks.

Problem	Explanation/Solution
No power	<ul style="list-style-type: none"> ◆ Check that the power plug is connected to a wall outlet. ◆ Have you pressed the ON/STANDBY button?
You cannot insert a video cassette	◆ A video cassette can only be inserted with the window side up and the safety tab facing you.
The television program was not recorded	<ul style="list-style-type: none"> ◆ Check the DVD Recorder-VCR antenna connections. ◆ Is the DVD Recorder-VCR tuner properly set? ◆ Check if the safety tab is intact on the cassette.
Timer recording was unsuccessful	<ul style="list-style-type: none"> ◆ Re-check the recording start/stop time settings and the current time ◆ Check whether you insert a tape which has enough time record
No playback picture or the picture is distorted	◆ Check to see if you are using a prerecorded tape.
You cannot see normal broadcasts	<ul style="list-style-type: none"> ◆ Check the TUNER/EXTERNAL setting. It should be on TUNER. ◆ Check the TV antenna connections.
Noise bars or streaks on playback	◆ Press the PROG/TRK (√ / ∧) buttons to minimize this effect.
When the ► button is pressed during playback, the still picture has severe "noise bar" streaks	◆ A still picture may have "noise bars", depending on the condition of the tape. Press the PROG/TRK (√ / ∧) buttons during SLOW motion to minimize this effect.
Video Head Cleaning	◆ If poor pictures appear on a variety of cassettes, the video heads may need cleaning. This is not a common problem and unless it appears, the heads should not be cleaned. When cleaning the video heads, read all instructions provided with the head cleaning cassette. Incorrect head cleaning can permanently damage the video heads.

If you are unable to solve the problem after reading the above instructions, note:

- ◆ The model and serial number on the rear of your DVD Recorder-VCR
- ◆ The warranty information
- ◆ A clear description of the problem

Then contact your nearest TOSHIBA authorized service center.

Specifications



General	Power requirements	AC 220 - 240V, 50Hz
	Power consumption	45 Watts
	Weight	5,3 Kg
	Dimensions	430(W) x 321(D) x 84(H)
	Operating temp.	+5°C to +35°C
	Other conditions	Keep level when operating. Less than 75% operating humidity
Input	Video input (Rear)	Euro Scart socket : 1.0Vp-p(unbalanced) 75Ω
	Audio input (Rear)	Euro Scart socket : -8dBm, 47Kohm unbalanced
	Front input	RCA jack, DV, S-Video
Output	RF out	UHF 21-69 (Initial CH36)
	Audio (DVD, VCR)	RCA jack, Euro Scart socket
	Audio (DVD Only)	Digital audio out OPTICAL COAXIAL
	Video (DVD, VCR)	RCA jack, Euro Scart socket (Composite,RGB),S-Video Out
VCR	Tape format	VHS type video tape
	Colour system	PAL
	Tuning system	G/K
	Video S/N	Above 43dB (standard recording)
	Resolution	Above 240 lines (standard recording)
	Audio S/N	Above 68dB (Hi-Fi), 39dB(Mono)
	Audio frequency characteristics	20Hz-20KHz (Hi-Fi)
DVD	Picture Compression format	MPEG-II
	Audio Compression format	Dolby AC-3 256kbps
	Recording Quality	XP (8 Mbps), SP (4 Mbps), LP (2 Mbps), EP (1,2 Mbps)
	Video S/N Ratio	Min. 50dB at standard recording
	Audio S/N Ratio	Min. 75dB
	Audio frequency characteristics	20 Hz ~ 20 KHz

Audio Output

For DVD discs, audio signals recorded at 96kHz sampling frequency are converted into and output at 48kHz digital output.

Disc Type	DVD	AUDIO CD(CDDA)
Analog Audio Output	48 / 96KHz	44,1KHz
Digital Audio Output	48KHz	44,1KHz

TOSHIBA

Printed in Korea
BY 731673(Rev. 02)

Free Manuals Download Website

<http://myh66.com>

<http://usermanuals.us>

<http://www.somanuals.com>

<http://www.4manuals.cc>

<http://www.manual-lib.com>

<http://www.404manual.com>

<http://www.luxmanual.com>

<http://aubethermostatmanual.com>

Golf course search by state

<http://golfingnear.com>

Email search by domain

<http://emailbydomain.com>

Auto manuals search

<http://auto.somanuals.com>

TV manuals search

<http://tv.somanuals.com>