

TOSHIBA



HDMI

Hi-Fi VCR & DVD VIDEO RECORDER D-VR5SU

OWNER'S MANUAL

VHS Hi-Fi SQPB

Introduction	2
Various settings	24
Disc playback	34
Tape playback	49
Recording	53
Editing the disc	63
Dubbing	78
Additional information	82



©2006 Toshiba Corporation
This device does not tape-record copy protected DVD Video Discs.

SAFTY PRECAUTIONS



The lightning flash with arrowhead symbol, within an equilateral triangle is intended to alert the user to the presence of uninsulated dangerous voltage within the product's enclosure that may be of sufficient magnitude to constitute a risk of electric shock to persons.



The exclamation point within an equilateral triangle is intended to alert the user to the presence of important operating and maintenance (servicing) instructions in the literature accompanying the appliance.

WARNING: TO REDUCE THE RISK OF FIRE OR ELECTRIC SHOCK, do not expose this appliance to rain or moisture.

CAUTION: TO PREVENT ELECTRIC SHOCK DO NOT USE THIS POLARIZED PLUG WITH AN EXTENSION CORD, RECEPTACLE OR OTHER OUTLET UNLESS THE BLADES CAN BE FULLY INSERTED TO PREVENT BLADE EXPOSURE.

FCC NOTICE: This equipment has been tested and found to comply with the limits for a Class B digital device, pursuant to Part 15 of the FCC Rules. These limits are designed to provide reasonable protection against harmful interference in a residential installation. This equipment generates, uses and can radiate radio frequency energy and, if not installed and used in accordance with the instructions, may cause harmful interference to radio communications.

However, there is no guarantee that interference will not occur in a particular installation. If this equipment does cause harmful interference to radio or television reception, which can be determined by turning the equipment off and on, the user is encouraged to try to correct the interference by one or more of the following measures:

- Reorient or relocate the receiving antenna.
- Increase the separation between the equipment and receiver.
- Connect the equipment into an outlet on a circuit different from that to which the receiver is connected.
- Consult the dealer or an experienced radio/TV technician for help.

CAUTION: Changes or modifications not expressly approved by the party responsible for compliance with the FCC Rules could void the user's authority to operate this equipment.

CAUTION: THIS DIGITAL VIDEO PLAYER EMPLOYS A LASER SYSTEM.

TO ENSURE PROPER USE OF THIS PRODUCT, PLEASE READ THIS USER'S GUIDE CAREFULLY AND RETAIN FOR FUTURE REFERENCE. SHOULD THE UNIT REQUIRE MAINTENANCE, CONTACT AN AUTHORIZED SERVICE LOCATION.

USE OF CONTROLS, ADJUSTMENTS OR THE PERFORMANCE OF PROCEDURES OTHER THAN THOSE SPECIFIED HEREIN MAY RESULT IN HAZARDOUS RADIATION EXPOSURE.

TO PREVENT DIRECT EXPOSURE TO LASER BEAM, DO NOT TRY TO OPEN THE ENCLOSURE. VISIBLE LASER RADIATION MAY BE PRESENT WHEN THE ENCLOSURE IS OPENED. DO NOT STARE INTO BEAM.

Location of the required Marking

The rating sheet and the safety caution are on the rear of the unit.

CERTIFICATION: COMPLIES WITH FDA RADIATION PERFORMANCE STANDARDS, 21 CFR SUBCHAPTER J.

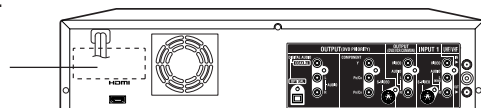

IMPORTANT SAFEGUARDS

1. READ INSTRUCTIONS

All the safety and operating instructions should be read before the unit is operated.

2. RETAIN INSTRUCTIONS

The safety and operating instructions should be retained for future reference.

3. HEED WARNINGS

All warnings on the unit and in the operating instructions should be adhered to.

4. FOLLOW INSTRUCTIONS

All operating and use instructions should be followed.

5. CLEANING

Unplug this unit from the wall outlet before cleaning. Do not use liquid cleaners or aerosol cleaners.

Use a soft dry cloth for cleaning the exterior cabinet only.

6. ATTACHMENTS

The manufacturer of this unit does not make any recommendations for attachments, as they may cause hazards.

7. WATER AND MOISTURE

Do not use this unit near water. For example, near a bathtub, washbowl, kitchen sink, laundry tub, in a wet basement, or near a swimming pool.

8. ACCESSORIES

Do not place this unit on an unstable cart, stand, tripod, bracket, or table.

The unit may fall, causing serious injury, and serious damage to the unit.

- 8A.** An appliance and cart combination should be moved with care. Quick stops, excessive force, and uneven surfaces may cause the appliance and cart combination to overturn.

9. VENTILATION

Slots and openings in the cabinet back or bottom are provided for ventilation, to ensure reliable operation of the unit, and to protect it from overheating.

These openings must not be blocked or covered. The openings should never be blocked by placing the unit on a bed, sofa, rug, or other similar surface. This unit should never be placed near or over a radiator or heat source. This unit should not be placed in a built-in installation such as a bookcase or rack unless proper ventilation is provided and/or the manufacturer's instructions have been adhered to.

10. POWER SOURCE

This unit should be operated only from the type of power source indicated on the rating plate. If you are not sure of the type of power supply to your home, consult your appliance dealer or local power company.

11. GROUNDING OR POLARIZATION

This unit is equipped with a polarized alternating-current line plug (a plug having one blade wider than the other). This plug will fit into the power outlet only one way. This is a safety feature. If you are unable to insert the plug fully into the outlet, try reversing the plug. If the plug should still fail to fit, contact your electrician to replace your obsolete outlet. Do not defeat the safety purpose of the grounding-type plug.

12. POWER-CORD PROTECTION

Power-supply cords should be routed so that they are not likely to be walked on or pinched by items placed upon or against them, paying particular attention to cords at plugs, convenience receptacles, and the point where they exit from the appliance.

PORTABLE CART WARNING
(symbol provided by RETAC)



S3125A

IMPORTANT SAFEGUARDS

13. LIGHTNING

To protect your unit from a lightning storm, or when it is left unattended and unused for long periods of time, unplug it from the wall outlet and disconnect the antenna or cable system. This will prevent damage to the unit due to lightning and power line surges.

14. POWER LINES

An outside antenna system should not be located in the vicinity of overhead power lines or other electric light or power circuits, or where it can fall onto or against such power lines or circuits. When installing an outside antenna system, extreme care should be taken to keep from touching such power lines or circuits, as contact with them might be fatal.

15. OVERLOADING

Do not overload wall outlets and extension cords, as this can result in a risk of fire or electric shock.

16. OBJECT AND LIQUID ENTRY

Do not push objects through any openings in this unit, as they may touch dangerous voltage points or short out parts that could result in fire or electric shock. Never spill or spray any type of liquid into the unit.

17. OUTDOOR ANTENNA GROUNDING

If an outside antenna or cable system is connected to the unit, be sure the antenna or cable system is grounded to provide some protection against voltage surges and built-up static charges, Section 810 of the National Electrical Code, ANSI/NFPA 70, provides information with respect to proper grounding of the mast and supporting structure, grounding of the lead-in wire to an antenna discharge unit, size of grounding conductors, location of antenna discharge unit, connection to grounding electrodes, and requirements for the grounding electrode.

EXAMPLE OF ANTENNA GROUNDING AS PER THE NATIONAL ELECTRICAL CODE

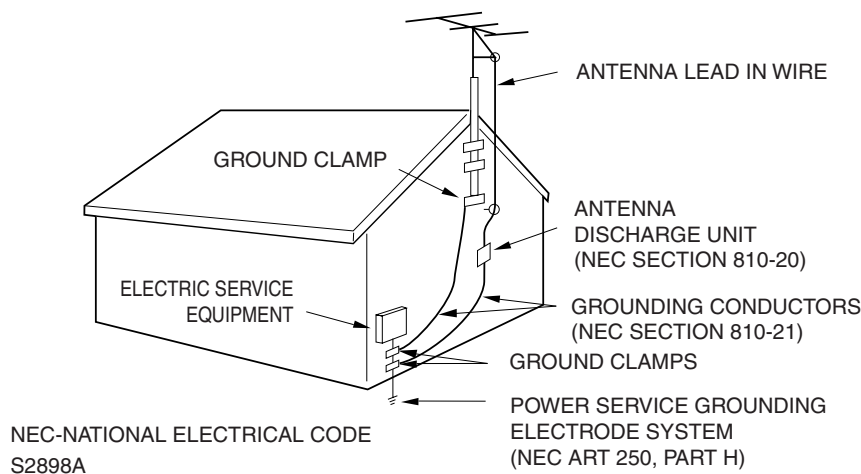

18. SERVICING

Do not attempt to service this unit yourself as opening or removing covers may expose you to dangerous voltage or other hazards. Refer all servicing to qualified service personnel.

For example:

- a. When the power-supply cord or plug is damaged.
- b. If liquid has been spilled, or objects have fallen into the unit.
- c. If the unit has been exposed to rain or water.
- d. If the unit does not operate normally by following the operating instructions. Adjust only those controls that are covered by the operating instructions, as an improper adjustment of other controls may result in damage and will often require extensive work by a qualified technician to restore the unit to its normal operation.
- e. If the unit has been dropped or the cabinet has been damaged.
- f. When the unit exhibits a distinct change in performance, this indicates a need for service.

IMPORTANT SAFEGUARDS

19. REPLACEMENT PARTS

When replacement parts are required, be sure the service technician uses replacement parts specified by the manufacturer or those that have the same characteristics as the original part.

Unauthorized substitutions may result in fire, electric shock or other hazards.

20. SAFETY CHECK

Upon completion of any service or repairs to this unit, ask the service technician to perform safety checks to determine that the unit is in proper operating condition.

21. HEAT

The product should be situated away from heat sources such as radiators, heat registers, stoves, or other products (including amplifiers) that produce heat.

22. DISC TRAY

Keep your fingers well clear of the disc tray as it is closing. It may cause serious personal injury.

23. CONNECTING

When you connect the product to other equipment, turn off the power and unplug all of the equipment from the wall outlet. Failure to do so may cause a product damage. Read the owner's manual of the other equipment carefully and follow the instructions when making any connections.

24. LASER BEAM

Do not look into the opening of the disc tray or ventilation opening of the product to see the source of the laser beam. It may cause sight damage.

25. DISC

Do not use a cracked, deformed, or repaired disc. These discs are easily broken and may cause serious personal injury and product malfunction.

26. NOTE TO CABLE TV SYSTEM INSTALLER

This reminder is provided to call the Cable TV system installer's attention to Article 820-40 of the NEC that provides guidelines for proper grounding and, in particular, specifies that the cable ground shall be connected to the grounding system of the building, as close to the point of cable entry as practical.

CONDENSATION

Moisture will form in the operating section of the DVD/VCR if the unit is brought from cool surroundings into a warm room or if the temperature of the room rises suddenly. When this happens, the DVD/VCR's performance will be impaired.

To prevent this, let the DVD/VCR stand in its new surroundings for about an hour before switching it on, or make sure that the room temperature rises gradually.

Condensation may also form during the summer if the DVD/VCR is exposed to the breeze from an air conditioner. In such cases, change the location of the DVD/VCR.

* This product incorporates copyright protection technology that is protected by method claims of certain U.S. patents and other intellectual property rights owned by Macrovision Corporation and other rights owners. Use of this copyright protection technology must be authorized by Macrovision Corporation, and is intended for home and other limited viewing uses only unless otherwise authorized by Macrovision Corporation. Reverse engineering or disassembly is prohibited.

Consumers should note that not all high definition television sets are fully compatible with this product and may cause artifacts to be displayed in the picture. In case of 525 progressive scan picture problems, it is recommended that the user switch the connection to the "STANDARD DEFINITION" output. If there are questions regarding our TV set compatibility with this model 525p DVD player, please contact our customer service center.

* **DVD** is a trademark of DVD Format/Logo Licensing Corporation.

* DivX, DivX Certified, and associated logos are trademarks of DivX, Inc. and are used under license.

* HDMI, the HDMI logo and High-Definition Multimedia Interface are trademarks or registered trademarks of HDMI licensing LLC.

* Manufactured under license from Dolby Laboratories. "Dolby" and the double-D symbol are trademarks of Dolby Laboratories.

* "DTS" and "DTS Digital Out" are trademarks of Digital Theater Systems, Inc.

* Unauthorized recording of copyrighted television programs, films, video cassettes and other materials may infringe the rights of copyright owners and be contrary to copyright laws.

* Certain audio features of this product manufactured under a license from Desper Products, Inc. Spatializer®, N-2-2™ and the circle-in-square device are trademarks owned by Desper Products, Inc.

* Microsoft, Windows Media, and the Windows logo are either registered trademarks or trademarks of Microsoft Corporation in the United States and/or other countries.

Contents

Introduction

● SAFTY PRECAUTIONS	2
● IMPORTANT SAFEGUARDS	3
● Contents	6
● Features	8
● Disc	9
Handling discs	9
Discs which can be played back	9
Discs on which video can be recorded	10
DVD-RAM	10
DVD-RW	10
DVD-R	10
Recording format	10
Disc playback in other players	11
On Video CDs	11
● Parts and functions	12
Front	12
Rear	12
Display window	13
Remote control	14
Power Source	15
● Antenna connections	16
● Cable TV connections	18
● Connections with the TV or audio component	20
● Auto clock setting	23
● Setting the video channel	23

Various settings

● SETUP MENU	24
Using the SETUP MENU	24
● Setting the language	25
OSD LANGUAGE	25
DVD MENU	25
AUDIO	25
SUBTITLE	25
● Setting the parental control	26
Selecting parental control	26
Temporarily cancelling parental control	26
● Setting the clock	27
CLOCK (manually)	27
AUTO CLOCK	27
STANDARD TIME (Time zone)	27
DAYLIGHT SAVING TIME	27
● Setting the disc	28
REFORMAT	28
NEW DISC FORMAT	28
FINALIZE	28
PROTECT DISC	29
UNDO FINALIZE	29
DVD-RAM Physical Format	29
● Other (SYSTEM SETUP)	29
DIMMER (Brightness of the display window)	29
DISPLAY/CALL (Turning the screen display "ON" or "OFF")	29

● Setting the screen	30
TV SCREEN	30
STILL MODE	30
LINE1 INPUT/LINE2 INPUT	30
● Setting the image quality	31
BRIGHTNESS	31
E.B.L.	31
● Setting the audio	31
DRC	31
VIRTUAL SURROUND (Spatializer N-2-2™) ...	31
EXTERNAL AUDIO INPUT	31
SAP (Second Audio Program)	32
DOLBY DIGITAL OUTPUT	32
● Setting the recording	32
INITIAL REC TO	32
INITIAL REC MODE	32
AUTO CHAPTER	32
INDEX PICTURE	32
BLACK LEVEL (REC)	32
● Setting the channel	33
TV/CABLE SELECT	33
AUTO CH MEMORY	33
ADD/DELETE (channels)	33
● Setting other items	33
JPEG INTERVAL	33
DivX® VOD	33

Disc playback

● Playback procedure	34
● Playback by selecting a title	35
● Checking media information	36
● Special playback	37
Fast forward playback	37
Review playback	37
Still playback	37
Frame advance	37
Slow motion playback	37
Locating a chapter or track	37
● Instant skip	38
● Locating a specific scene	38
● Repeat playback	39
Instant replay	39
A-B repeat playback	39
Title, Chapter repeat playback	39
● Title selection	40
● DVD menu	40
● Changing angles	41
● Zooming	41
● Karaoke playback	41
● Changing soundtrack language	42
● Subtitles	42
Turning the subtitles On and Off	42
Changing the subtitles language	42
● To turn off the PBC (VIDEO CD Version 2.0) ...	42
● Various operations on CD	43
● MP3/WMA/JPEG/DivX® playback	45

Contents

Tape playback

- **Loading and unloading a cassette tape** 49
- **Cassette tape playback** 50
- **Special playback** 51
 - Picture search 51
 - Still picture 51
 - Slow motion 51
 - Frame by frame picture 51
 - Adjusting tracking condition 51
 - Repeat playback 51
 - Instant skip 51
 - To display VCR operation status 51
- **ZERO RETURN function** 52
- **Video index search system** 52

Recording

- **Read this before recording on disc** 53
 - Types of disc 53
 - Recording modes 53
 - Disc remaining time 53
 - Images that cannot be recorded 54
- **Recording a TV program** 55
- **One-touch Timer Recording (OTR)** 57
- **Timer recording** 58
- **Chase playback** 61
- **Stereo recording and playback** 62

Editing the disc

- **Editing the disc** 63
- **Editing a playlist** 64
 - Creating a playlist 64
 - Changing a title name 65
 - Erasing a scene (Edit title) 66
 - Combining the title 68
 - Erasing a playlist 69

- **Editing an original title** 70
 - Adding a chapter mark 70
 - Combining chapters 71
 - Changing an original title name 72
 - Erasing a scene (Edit title) 73
 - Erasing an original title 74
- **Changing a disc name** 75
 - Changing a disc name 75
 - Using the keyboard screen 76

Dubbing

- **Dubbing a tape onto a disc** 78
- **Dubbing a disc onto a tape** 79
- **Dubbing using other equipment** 80







Additional information

- **Glossary** 82
- **Language code list** 84
- **Problems and troubleshooting** 85
- **Video head cleaning** 86
- **Error/Warning message list** 87
- **Specifications** 88
- **Limited Warranty** 89

Introduction

Media mark

Each applicable media are indicated using the symbol shown below.

 : DVD-Video	 : DVD-R
 : DVD-RW in VR mode	 : Audio/Video CD and CD-R/CD-RW
 : DVD-RW in Video mode	 : Video tape
 : DVD-RAM	

Features

Not only can you playback and record video tapes, but you can also playback DVD discs or make recordings using DVD-RAM, DVD-RW or DVD-R discs with this unit. In addition, you can enjoy editing the programs you record.

Playback function

A realistic, powerful, Movie Theater sound



When connected to Dolby Digital and DTS compliant devices, you can enjoy realistic, powerful surround sound.

Playback the scene you want to see immediately



As DVD's do not require rewinding like video tapes, you can get to the scene you wish to watch immediately. A variety of search functions allow you to find the scene you wish to watch.

Title menu



As thumbnail images are displayed in the title menu, you can find the title you want to play back quickly.

- Thumbnail image will not appear after finalizing in Video mode.

Video CD/SVCD/MP3/WMA/JPEG/DivX® playback



Video CD/SVCD/MP3/WMA/DivX® files can be played back. Also, you can display JPEG files on the TV screen and enjoy them as a slide show.

Progressive scan



This unit supports the progressive scanning system. If your TV is equipped with component video input jacks which support the progressive video input, you can enjoy high quality picture.

Chase Playback



You can begin playback from the beginning of a program currently being recorded. You will find this function of great advantage on long programs, as you do not have to wait for the end of recording to begin playback.

Recording function

Timer recording



The timer recording system allows you to select the date, time and channel and record the desired programs. Up to 12 timer programs within a month can be stored in this unit.

One-touch Timer Recording (OTR)



The One-touch Timer Recording feature provides a simple and convenient way to make a timed recording.

Edit function

Editing recorded material without changing the original titles



You can create a playlist based on the original titles. The playlist won't affect the original titles. If you erase the playlist, the original titles remain. It is recommended to create and edit the playlist to prevent important titles from being erased accidentally.

Chapter mark



You can add (or delete) a chapter mark to (from) the original title. This function is useful when searching for the scene you wish to watch that you have marked with the Chapter mark function.

Erasing scenes



You can erase an unnecessary scene from the created playlist or the original titles.

Combining titles



You can combine several original titles or playlists to a separate playlist.

Dubbing function

Dubbing a tape onto a disc or a disc onto a tape



With just this one unit, you can dub whatever you like, from video tape to disc, or from disc to video tape.

- Dubbing cannot be carried out when attempting to copy a "copy guarded" video tape or disc.



Disc

Handling discs

Removing the Disc from its case

Be sure to hold the disc by its edges. Do not touch the surface of the disc. Take the disc carefully from its case.



- Do not scratch the disc.
- Do not get dirt on the surface of the disc.
- Do not stick labels or adhesive tapes on the disc.
- Do not drop or bend the disc.

Storing discs

- Store the disc in the case to avoid any risk of scratches, dirt or damage.
- Do not leave the disc exposed to direct sunlight or in hot or humid places.

Cleaning discs

Wipe the disc with a clean, dry cloth from the center outward toward the edges.

- Do not wipe the disc in a circular motion around the center.
- Do not use liquid or aerosol cleaners.



Discs which can be played back

In this unit, use only discs that meet the standard, such as those bearing the below logo marks on the disc label surface. If you use a non-standard disc, we cannot guarantee playback. Even if such a disc can be played back, we cannot guarantee the image or sound quality. The DVD logo is a registered trademark.

Media type	Logo mark
DVD-Video	
DVD-RAM*1 Ver.2.0 Ver.2.1	
DVD-RW Ver.1.0, Ver.1.1, Ver.1.2 Ver.1.1 CPRM support Ver.1.2 CPRM support	
DVD-R Ver.2.0, Ver.2.1	
Audio CD*2	
Video CD SVCD	
CD-R/CD-RW	

*1 When using cartridge-type DVD-RAM discs, it will be necessary to remove the disc from the cartridge.

*2 This unit is designed to playback music Compact Discs (CD) that conform to the CD standard. CDs that contain (copy-restriction) signals to protect copyrights cannot be played back.

Notes on DVDs and CDs

Because of problems and errors that can occur during the creation of DVD and CD Software and/or the manufacture of DVD and CD discs, Toshiba cannot assure that the DVD player will successfully play every disc bearing DVD and CD logos. If you happen to experience any difficulty playing a DVD and/or CD disc on this DVD player, please contact Toshiba Customer Service.

Region management information

This unit is designed and manufactured to support the region management information that is recorded on a DVD disc. If the region number written on the DVD disc does not correspond to the region number of this unit, this unit cannot play that disc.

- The region number of this unit is "1".
- The unit will play DVD-Video discs marked with labels containing "1" or "ALL".

Example:

Operating DVD-Video

- Some operations of DVD-Video may be prohibited by the manufacturer, or some operation methods or functions of the DVD-Video may be different from the description in this manual.
- If you attempt an operation that is prohibited by either the disc or the unit, a "⚡" mark will appear on the TV monitor. For operations prohibited by the disc, see the information that came with the disc.
- When the menu screen or the operation guide appears during disc playback, follow the displayed information.

Discs which cannot be played back

The discs listed below cannot be played back in general. Even if one of these can be played back, it may not be played back correctly. If a disc is played back by mistake, extensively loud sounds may blow the speakers or may damage the hearing of those in hearing range. Do not playback the discs listed below.

CDG, Photo-CD, CD-ROM, CD-TEXT, CD-EXTRA, SACD, PD, CDV, DVD-ROM, DVD+R/RW, DVD audio, etc.

The below DVD-Video may not be played back.

- DVD-Video that do not have the region number "1" or "ALL".
- PAL or SECAM DVD-Video.
- Prohibited or business-use DVD-Video.

CD-R/CD-RWs cannot be played back for the following reasons.

- Compatibility of the disc and this unit.
- Compatibility of the disc and the recorder used.
- Unfinalized discs.





Do not playback the following discs. Playback of these discs may cause a failure.

- Discs on which paper, labels or stickers are affixed.
- Discs that have sticky areas left by adhesive tape.
- Special-shaped discs.

Disc

Discs on which video can be recorded

To record video with this unit, use the discs below:

Media type	Logo mark
DVD-RAM Ver.2.0 Ver.2.1	
DVD-RW Ver.1.0, Ver.1.1, Ver.1.2 Ver.1.1 CPRM support Ver.1.2 CPRM support (1~6x SPEED)	  
DVD-R Ver.2.0, Ver.2.1 (1~16x SPEED)	

DVD-RAM

- When using cartridge-type DVD-RAM discs, it will be necessary to remove the disc from the cartridge.
- Use only DVD-RAM discs that comply with DVD-RAM standard Version 2.0 or 2.1.
The recorder cannot record on a disc formatted in any other standard. When using such a disc, initialize it by using the disc-format function of this recorder.
- The recorder may not record, dub, or edit some DVD-RAM discs, because they are edited/recorded with another manufacturer's equipment or PC, contain a large number of titles, or have little remaining capacity. Also, a DVD-RAM disc may not be edited or recorded if its title contains still pictures.
- When you load a DVD-RAM disc for PC, "INCORRECT DISC" may appear on screen. In this case please format the disc to use with this recorder.
- DVD-RAM discs formatted in UDF2.0 on a PC are not compatible with this recorder. Before using these discs, initialize them on this recorder.
- This recorder complies with current copyright protection technology and can copy a disc only when the disc permits copying once. When there is no indication on the disc, copying will not be allowed. Such an indication on a disc is required also for the Library Management database.

DVD-RW

- The disc can be erased and used again about 1,000 times.
- Only the VR mode can be used for Ver.1.0 discs.
- With Ver.1.1/1.2 discs, you can record by selecting the VR mode or Video mode.
- When you record in the VR mode, you can repeatedly record and erase. By erasing unnecessary titles, you effectively increase remaining time.
- When you record in the Video mode, you can record until the disc becomes full.
- When you use the Video mode, you can newly record on the disc by formatting the disc. However, if the disc is formatted, all the recorded contents will be erased.

DVD-R

- You can record on the disc only in the Video mode.
- You can record until the disc becomes full.
- Finalizing the discs allows playback on other DVD players. However, the finalized discs can no longer be recorded.
- Discs can be recorded to repeatedly until they are finalized.

NOTES:

- There are some players that cannot playback discs that were recorded with this unit. We cannot guarantee the playback with other units.
- This unit can record on DVD-RAM/RW/R discs that are 8 cm in diameter.
- This unit cannot record on CD-RW/R.

Recording format

This unit has two modes for formatting discs for recording: VR mode and Video mode.

When a blank, new disc is loaded into this unit, the automatic format function starts to format the disc. (For the disc format setting in this step, see page 28).

VR mode

- This mode can be used for DVD-RAM/-RW.
- In this mode, the discs can be recorded and edited repeatedly.
- The disc recorded in this mode can be played back with other DVD-RW-compatible players.
- When a Ver.1.1 CPRM or Ver. 1.2 disc is used, you can record a "Copy Once" program (see page 54).

Video mode

- This mode can be used for DVD-R and DVD-RW (Ver.1.1/1.2).
- When you finalize the disc after recording, the disc recorded with this unit can be played back with other DVD players.
- Recording, editing or playback of an unfinalized disc can be done only with this unit. However, there are some limitation to editing operations.
- In this mode, you cannot record a "Copy Once" program (see page 54).
- When you record a TV program of a bilingual broadcast, only one of the audio modes can be recorded. You have to select it.

Format modes that can be used with each disc

The usable format depends on the media type as shown in the below table.

Media type	Format	Available functions
DVD-RAM (Ver.2.0/2.1)	VR mode	Playback, recording and editing (Original/playlist)
DVD-RW (Ver.1.0)	VR mode	Playback, recording and editing (Original/playlist)
DVD-RW (Ver.1.1/1.2)	VR mode	Playback, recording and editing (Original/playlist)
	Video mode	Playback and recording Editing (with limitation)
DVD-R (Ver.2.0/2.1)	Video mode	Playback and recording Editing (with limitation)



Disc

Title/Chapter/Track

A DVD-Video has large partitions called "Titles", and smaller partitions within them called "Chapters".

A music CD has other partitions called "Tracks". A number is allotted to each partition and these numbers are called "title numbers", "chapter numbers" or "track numbers".

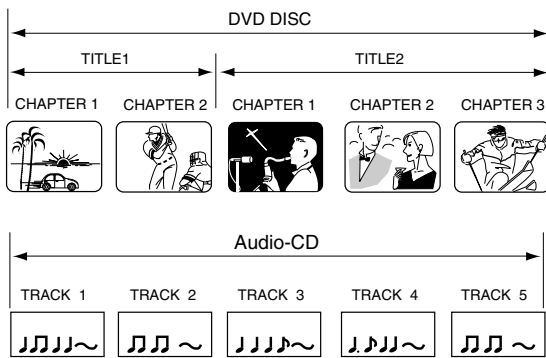

When recording in the VR mode

One-time recording is set to 1 title (1 chapter). However, if you stop recording temporarily or erase scenes by editing, the chapter will automatically be partitioned. The interval between chapters can be specified. (See page 32).

When recording in the Video mode

One-time recording is set to 1 title. In recording, chapters are set automatically. The interval between chapters can be specified. (See page 32).

NOTES:

- The title, chapter and track are numbered, but some discs may not record the numbers.
- Recording on DVD-R/RW in the Video mode is a new standard approved at the 2000 DVD forum. Conformity to this standard varies with each DVD player manufacturer. Some models of DVD player or DVD-ROM drive, therefore, will not playback recorded videos.

Disc playback in other players

DVD-RW/R recorded in this unit can be finalized. The disc can be played back in other players that can playback DVD-RW and DVD-R.

For more information on finalization, see "FINALIZE" in "Setting the disc" (page 28).

When recording in the VR mode

Even if a DVD-RW disc recorded in the VR mode is finalized, you can record or edit by cancelling the finalization. (See "UNDO FINALIZE" on page 29).

When you playback the disc with another player, make sure that the DVD player supports DVD-RW.

When recording in the Video mode

When a disc recorded in the Video mode is finalized, it cannot be recorded onto any more. Therefore, before finalization, be sure to perform all desired recording. After finalization, a title list that can be used by the DVD player is automatically created.

NOTES:

- The finalization process may require from a few minutes up to 1 hour depending on the disc type and the amount of free space on the disc.
- A DVD-RW Ver.1.1/1.2 recorded in the Video mode cannot be recorded or edited after finalization, but if you format the disc by erasing all the content, you can again record on this disc.
- A finalized disc may not play because of the condition of the DVD or the compatibility with the player used for playback.
- Some players may not playback the discs recorded with this unit. We cannot guarantee the playback using other players.

On Video CDs

This DVD supports Video CDs equipped with the PBC (Version 2.0) function. (PBC is the abbreviation of Playback Control.) You can enjoy two playback variations depending on types of discs.

• Video CD not equipped with PBC function (Version 1.1)

Sound and movie can be played on this DVD/VCR in the same way as an audio CD.

• Video CD equipped with PBC function (Version 2.0)

In addition to operation of a Video CD not equipped with the PBC function, you can enjoy playback of interactive software with search function by using the menu displayed on the TV screen (Menu Playback). Some of the functions described in this owner's manual may not work with some discs.

- Toshiba is not liable for any damage or loss caused directly or indirectly by the malfunction of this DVD/VCR, including, without limitation, any one of the following:
 - Failure to record contents intended to be recorded by the consumer.
 - Failure to edit contents as intended by the consumer.
 - When a DVD-RAM disc or a DVD-R disc created on this recorder is used (e.g., insertion, playback, recording or editing) in another DVD player, recorder or personal computer drive.
 - When a DVD-RAM disc or a DVD-R disc that is used in the manner described in the immediately preceding bullet point is used again in this recorder.
 - When a DVD-RAM disc or a DVD-R disc that was recorded in another DVD recorder, or in a personal computer drive is used in this recorder.
 - Discs recorded in this recorder may not operate as expected on other DVD players, recorders or personal computer drives.

Parts and functions

Front

* This unit has a door on the front panel.

Please open it to access the S-VIDEO jack and the AUDIO (L/R)/VIDEO IN (INPUT 2) jacks.

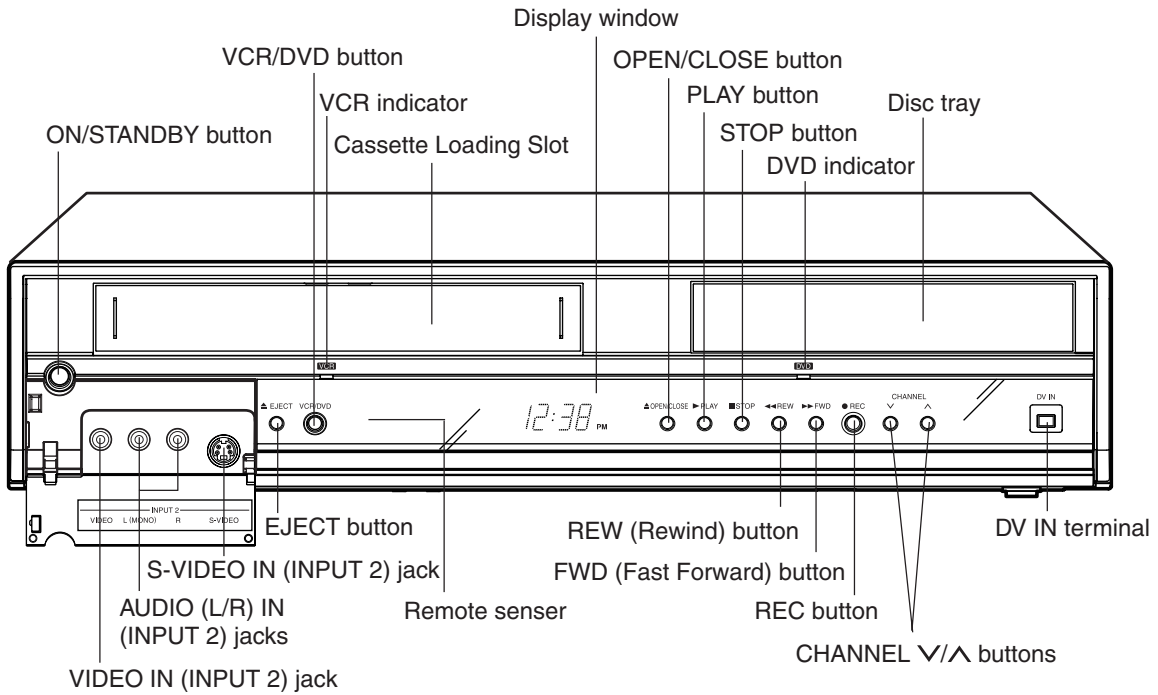

Rear

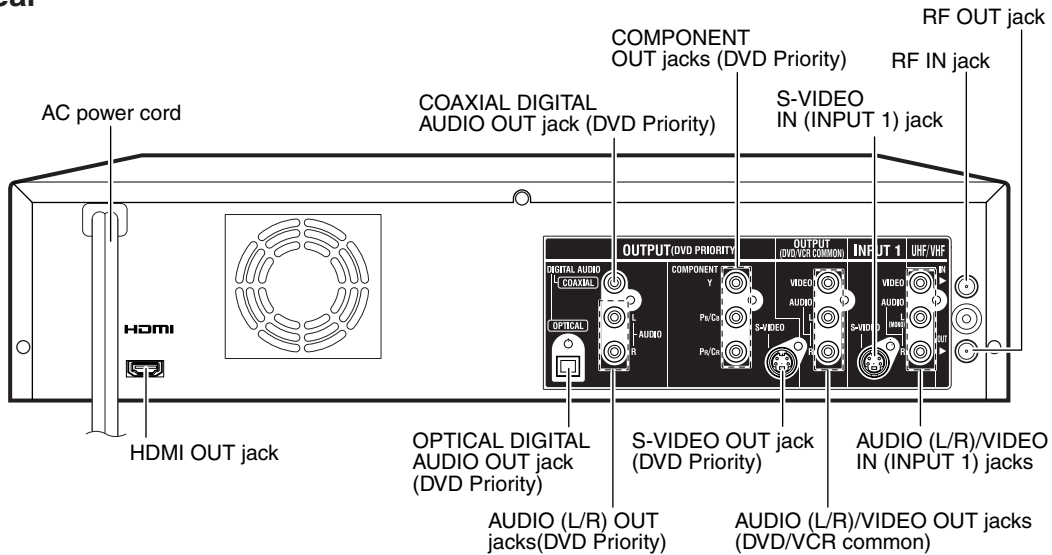



Parts and functions

Display window

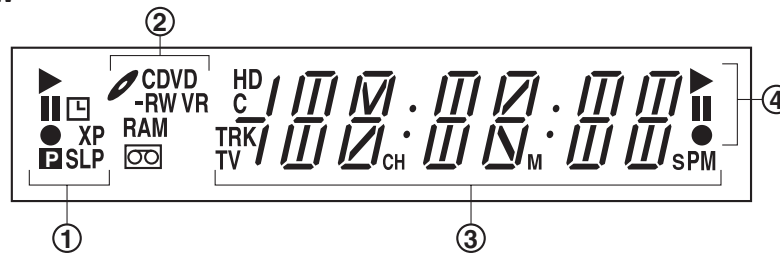

No.	Display	Description
①		Lights during video tape playback.
		Video tape is temporarily stopped.
		Lights during video tape recording.
		Progressive scanning mode.
		Timer recording display.
	XP/SP/LP/SLP	4 DVD recording modes. XP, SP, LP or SLP can be selected in turn by pressing the REC MODE/SPEED repeatedly.
	SP/SLP	2 VCR recording modes. SP or SLP can be selected in turn by pressing the REC MODE/SPEED repeatedly.
②		Appears when a CD is inserted.
		Appears when a CD-R is inserted.
		Appears when a CD-RW is inserted.
		Appears when a DVD-Video is inserted.
		Appears when a DVD-R is inserted.
		Appears when a DVD-RW is inserted.
		Appears when a DVD-RAM is inserted.
	VR	Appears when a DVD-RW in VR mode is inserted. When the disc is set to video mode, VR does not appear.
		Video tape is in the unit.
③	10:00	Clock display (Colon [:] flashes).
	01H00M00s	Counter display in hour/minute/second.
	HD	Appears when HDMI output is active.
	C 36CH	Cable TV channel display.
	2CH	TV channel display.
	TRK 002	Track number display for CD.
	TV	Appears when the tuner built into this unit is not selected. When you press TV/VIDEO, it disappears.
	PM	Display for afternoon (out in the morning).
	L1/L2	The external input channel (L1 or L2) display.
	Err	Error display.
	④	
		DVD or CD is temporarily stopped.
		Lights during DVD recording.

NOTE:

Some discs may not playback correctly, or chapter number, playback time, etc may not be displayed.

Parts and functions

Remote control

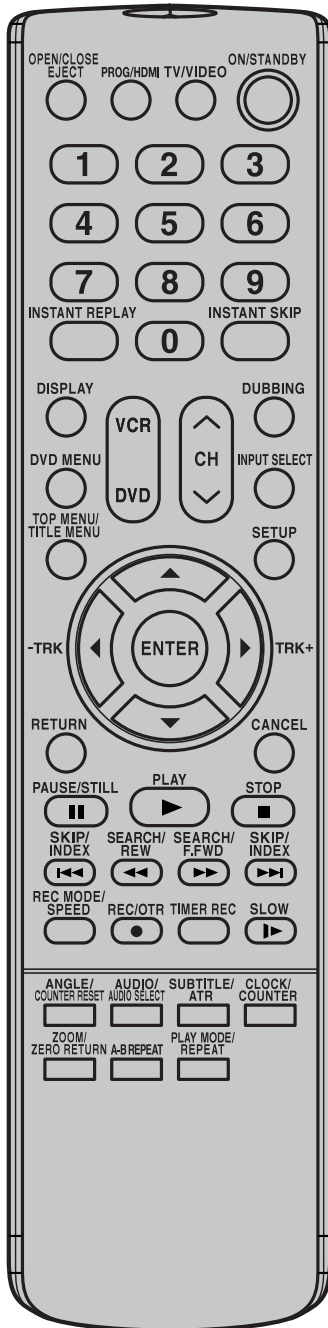

		Page
OPEN/CLOSE	Opens or Closes the tray.	34
EJECT	Ejects the cassette tapes	49
PROG	Activates the progressive scanning mode.	21
HDMI	HDMI output on/off.	21
TV/VIDEO	Select to operate TV/VIDEO	23, 56
ON/STANDBY	Turns power on/off.	23
0-9	Direct channel selection of TV Setting input Entering a password	55 38, 76 26
INSTANT REPLAY	Repeats playback between the section played 10 seconds before and present section.	39
INSTANT SKIP	Skips commercial breaks.	38, 51
DISPLAY	Displays VCR or DVD operation status.	36, 52
VCR	Switches to operation between VCR and DVD.	34, 50, 78
DVD		
CH ^/v	Channel selection for the connected TV or VCR	55
DUBBING	Copies VCR to DVD or DVD to VCR.	78, 79
DVD MENU	Displays the menu of the DVD disc.	40
INPUT SELECT	Switches the connected TV to external inputs.	80
TOP MENU/TITLE MENU	Selects titles of a DVD disc.	35, 40, 43, 64
SETUP	Display the setup menu	24, 58
▲ / ▼	Cursor buttons	24, 34, 38, 58
TRK +/-	Manual tracking in the playback mode for VCR	51
◀ / ▶	Cursor buttons	34, 38
ENTER	Option selection in the menu	24, 34, 38, 58
RETURN	Close the menu window.	24, 26
CANCEL	Deletes the Timer recording program. Cancels input data in the setting mode.	60 26
PAUSE/STILL	Still picture/Recording pause on/off	37, 51
PLAY	Playback	34, 50
STOP	Stop	34, 50, 56
SKIP ◀▶	Skips chapters in the forward or reverse direction	37
INDEX ◀▶	Searches for the INDEX mark of a tape	52
SEARCH ◀◀/REW	Rewind/Review playback	37, 50, 51
SEARCH ▶▶/F.FWD	Fast Forward/Forward search playback	37, 50, 51
REC MODE/SPEED	Selects the recording mode.	55, 57
REC/OTR	Recording	55, 57, 80
TIMER REC	Sets the unit to start recording at a preset time.	60
SLOW	Slow motion playback	37, 51
ANGLE	Changes playback angle.	41
COUNTER RESET	Resets the counter to 00H 00M 00S .	52
AUDIO	Changes the language of the DVD.	42
AUDIO SELECT	Switches sound between mono and stereo.	62
SUBTITLE	Selects subtitles of the DVD disc.	42
ATR	Digital AUTO TRACKING	51
CLOCK/COUNTER	Changes the front panel display mode.	52
ZOOM	Zoom (for DVD/Video CD)	41
ZERO RETURN	Stops the tape when the counter reaches 00H 00M 00S.	52
A-B REPEAT	Repeats playback between A and B.	39
PLAY MODE	Selects the playback mode.	38
REPEAT	Repeats playback.	39, 51



Parts and functions

Inserting Batteries into the Remote Control:

1 Open the battery compartment cover in the direction of the arrow.

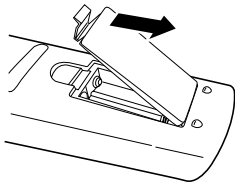

2 Install two "AAA" batteries, paying attention to the polarity diagram in the battery compartment.

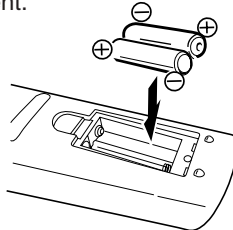

3 Replace the compartment cover.

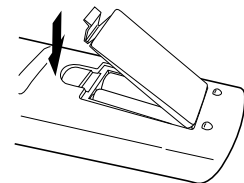

Introduction

Caution:

Never throw batteries into a fire.

Notes:

- Be sure to use AAA size batteries.
- Dispose of batteries in a designated disposal area.
- Batteries should always be disposed of with the environment in mind. Always dispose of batteries in accordance with applicable laws and regulations.
- If the remote control does not operate correctly, or if the operating range becomes reduced, replace batteries with new ones.
- When necessary to replace batteries in the remote control, always replace both batteries with new ones. Never mix battery types or use new and used batteries in combination.
- Always remove batteries from remote control if they are dead or if the remote control is not to be used for an extended period of time. This will prevent battery acid from leaking into the battery compartment.

Remote control basics

- Press **ON/STANDBY** to turn the DVD/VCR on or off.
- Press **CH ^** or **CH v** to move through the channels one channel at a time.
- The **▲/▼/◀/▶** are also used to navigate on-screen menu system.
- You can directly access specific channels using **numeric keys**.
- Each press of **DVD** or **VCR**, switches the screen between the DVD screen (DVD mode) and the VCR screen (VCR mode).

Operation

- Aim the remote control at the remote sensor and press control buttons to operate.
- Operate the remote control within 30° angle on either side of the remote sensor, up to a distance of approximately 7 meters (23 feet).

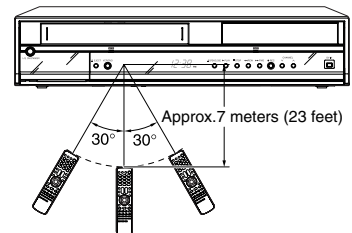

Power Source

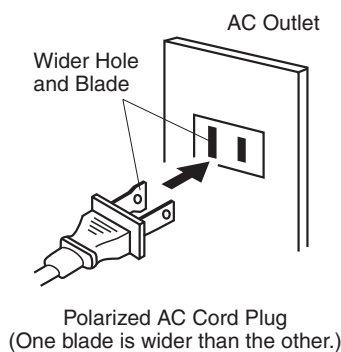

TO USE AC POWER SOURCE

Use the AC polarized line cord provided for operation on AC. Insert the AC cord plug into a standard 120V 60Hz polarized AC outlet.

NOTES:

- Never connect the AC line cord plug to other than the specified voltage (120V 60Hz). Use the attached power cord only.
- If the polarized AC cord does not fit into a non-polarized AC outlet, do not attempt to file or cut the blade. It is the user's responsibility to have an electrician replace the obsolete outlet.
- If you cause a static discharge when touching the unit and the unit fails to function, simply unplug the unit from the AC outlet and plug it back in. The unit should return to normal operation.
- If the AC cord plug is plugged in for the first time, wait for approximate 3 minutes before operating the unit.



Antenna connections

If you are using an antenna system, follow these instructions. If you are using a Cable TV subscriber, skip ahead to page 18 for the proper connections.

ANTENNA TO DVD/VCR CONNECTION

The DVD/VCR must be connected "between" the antenna and the TV. First, disconnect the antenna from the TV and connect it to the DVD/VCR. Then connect the DVD/VCR to the TV. Below are 3 common methods of connecting an antenna system to a DVD/VCR. Find the type of antenna system you are using and follow the connection diagram.

1

Combination UHF/VHF antenna with 75 ohm coaxial cable

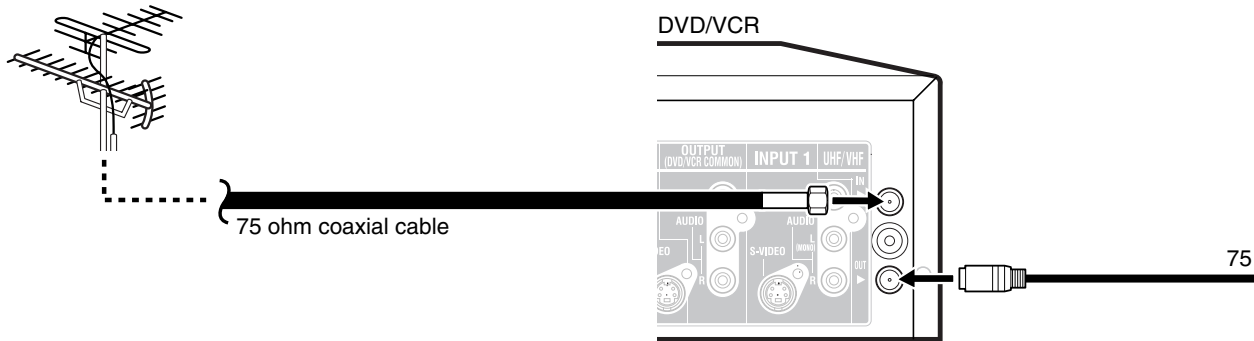

2

Combination UHF/VHF antenna with 300 ohm twin lead (flat) wire

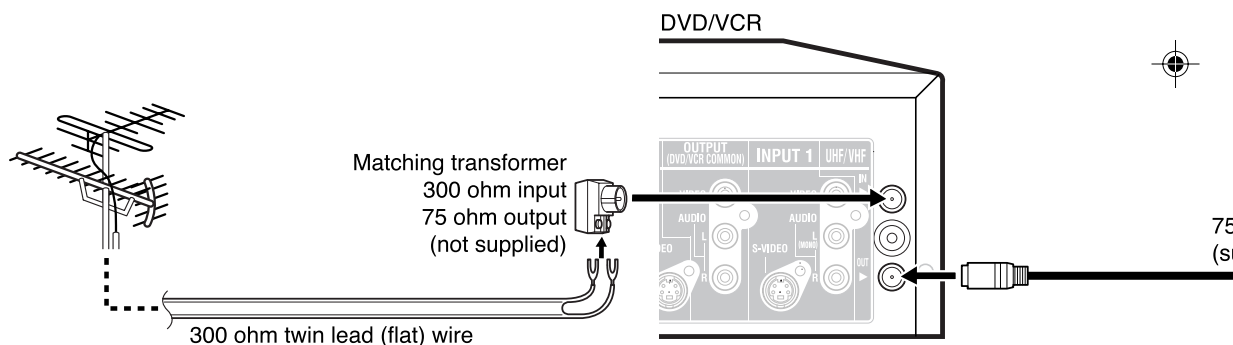

3

Separate UHF and VHF antennas

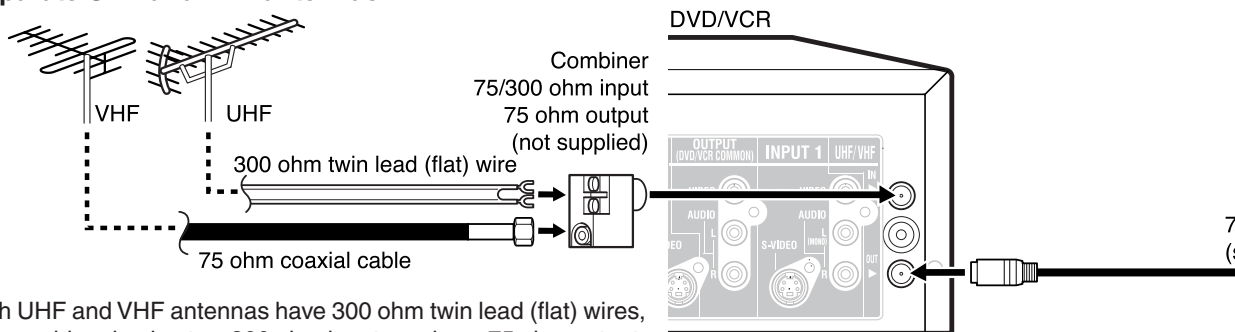

NOTE: If both UHF and VHF antennas have 300 ohm twin lead (flat) wires, use a combiner having two 300 ohm inputs and one 75 ohm output.

- NOTES:**
- A clear picture will not be obtained by the DVD/VCR unless the antenna signal is good. Connect the antenna to the DVD/VCR properly.
 - For better quality recording, an indoor antenna or a telescopic antenna is not recommended. The use of an outdoor type antenna is required.
 - If you are not sure about the connection, please refer to qualified service personnel.



Antenna connections

DVD/VCR TO TV CONNECTION

After you have connected the antenna to the DVD/VCR, you must connect the DVD/VCR to the TV. Below are 3 common methods of connecting your DVD/VCR to a TV. Find the type of TV you are using and follow the connection diagram.

This DVD/VCR has a single 75 ohm output for connection to a TV. If your TV has separate UHF and VHF antenna inputs (numbers 2 and 3 below), use a splitter to connect the DVD/VCR to the TV for UHF and VHF reception.

Introduction

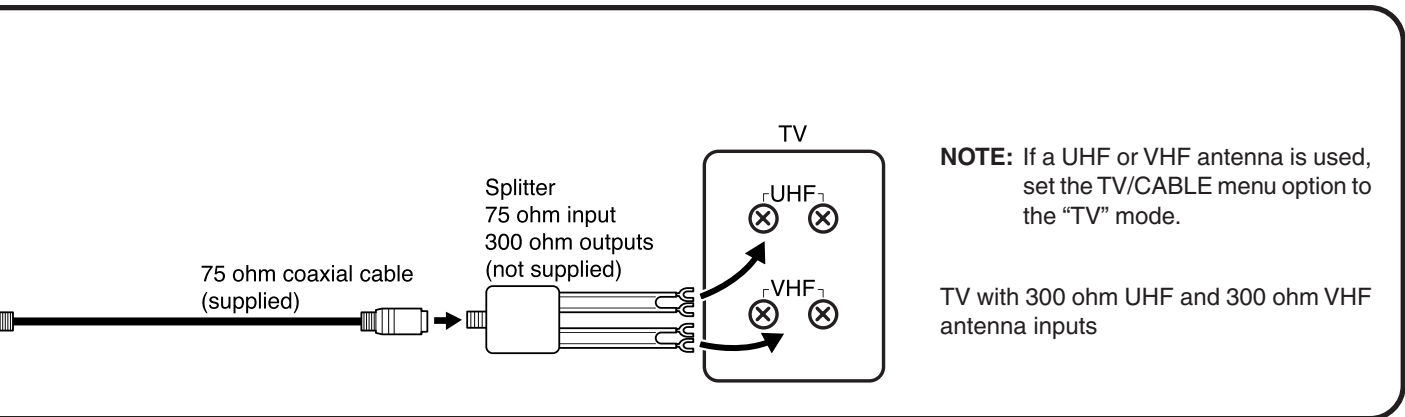
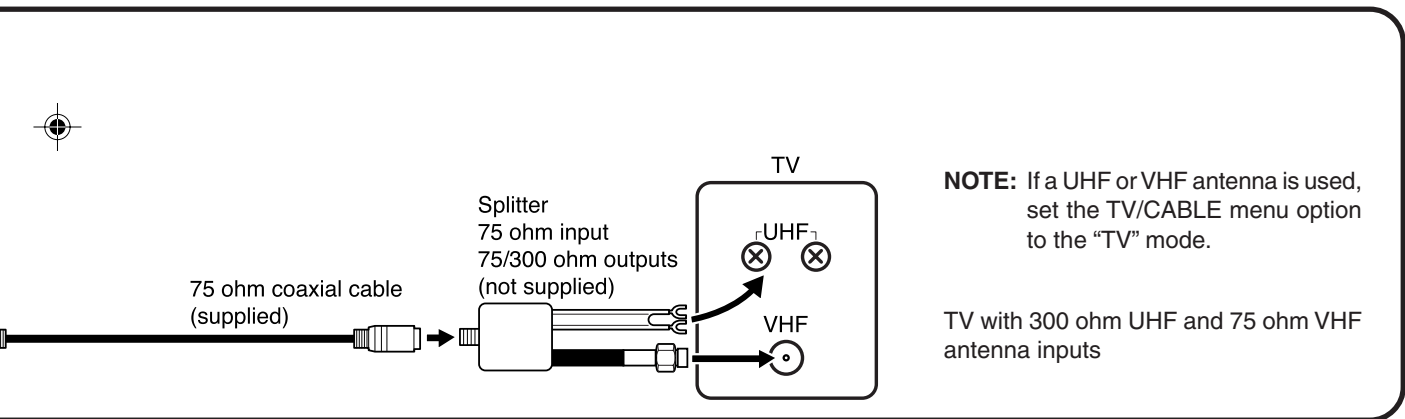
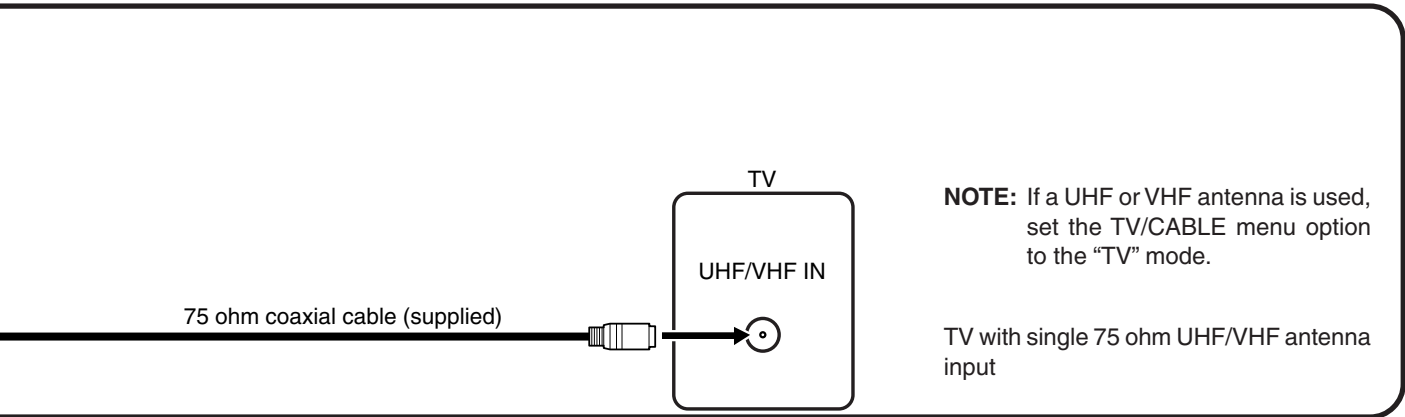

The unauthorized recording, use, distribution, or revision of television programs, videotapes, DVDs and other materials, is prohibited under the Copyright Laws of the United States and other countries, and may subject you to civil and/or criminal liability.



Cable TV connections

Many cable companies offer services permitting reception of extra channels including pay or subscription channels. This DVD/VCR has an extended tuning range and can be tuned to most cable channels without using a cable company supplied converter box, except for those channels which are intentionally scrambled. If you subscribe to a special channel which is scrambled, you must have a descrambler box for proper reception.

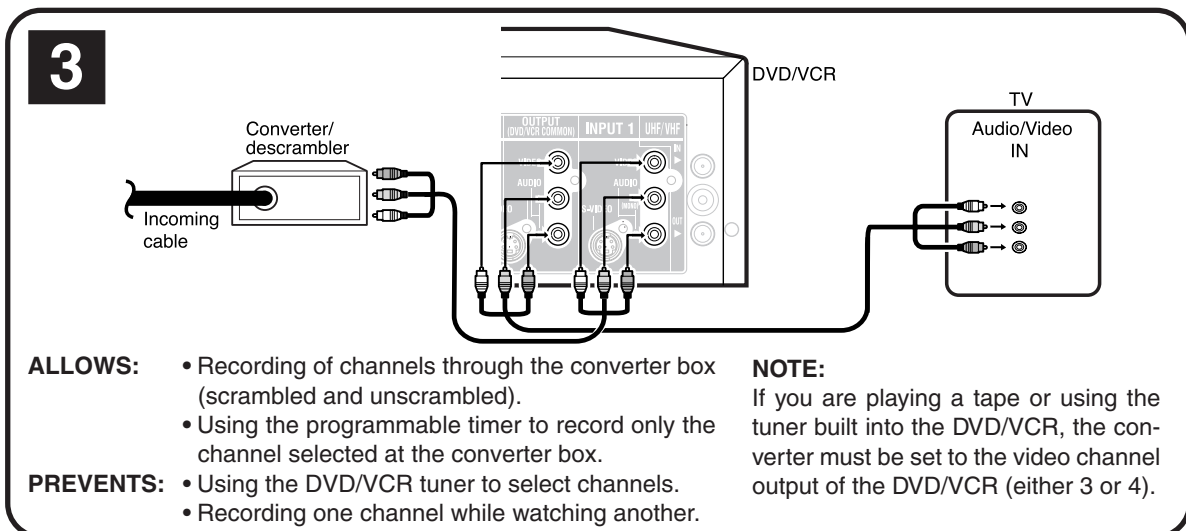
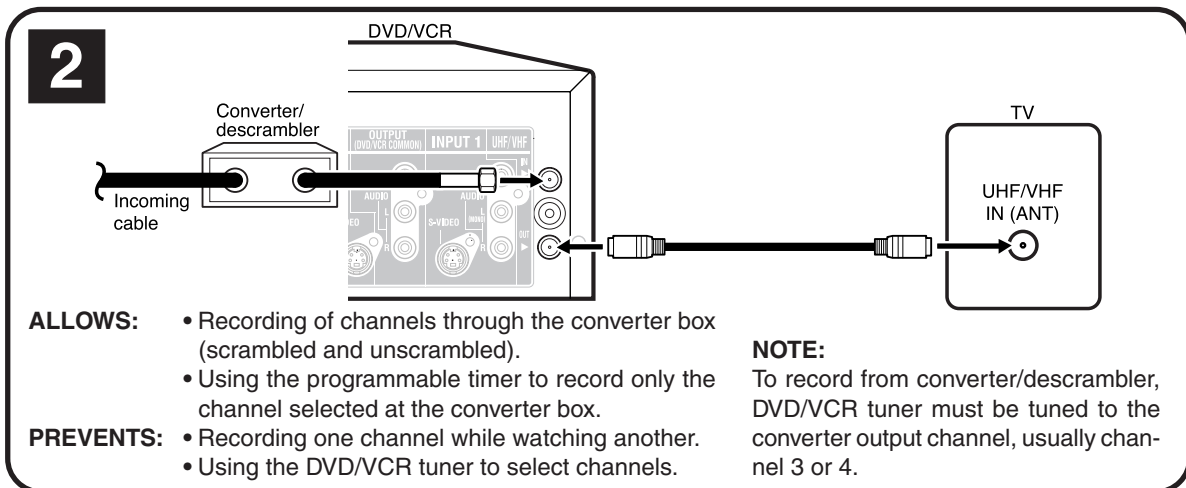
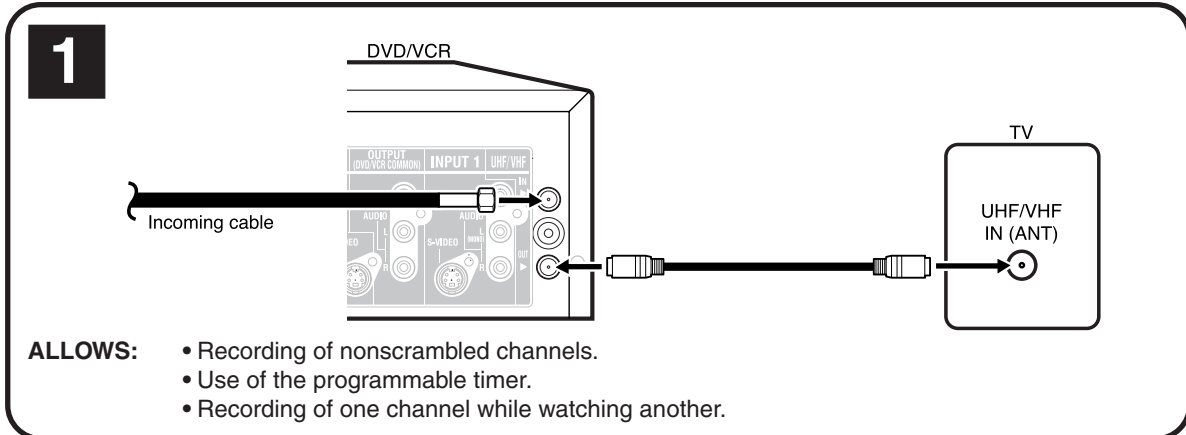

NOTE: Whenever a converter/descrambler box is placed before the DVD/VCR, you must tune the DVD/VCR to the output of the converter/descrambler box, usually channel 3 or 4.

Cable TV connections

IMPORTANT: Make sure the TV/CABLE menu option is set to the "CABLE" mode.

This DVD/VCR cannot receive scrambled programs since it does not contain a descrambler. In order to receive scrambled programs, your existing descrambler must be used. Descrambler boxes are available from cable companies. Consult your local cable company for more information concerning connection to their descrambler equipment. There are many ways to connect your DVD/VCR to a cable system. Below are six common methods of connection.

Introduction

4

ALLOWS:

- Recording of one channel while watching another.
- Using the programmable timer to record only the channel selected at the converter box.
- Recording of all channels through the converter box.

PREVENTS:

- Watching scrambled channels while recording another channel.
- Using the DVD/VCR tuner to select channels.

5

ALLOWS:

- Recording of nonscrambled channels.
- Recording of one channel while watching another.
- Watching premium channels through the converter while recording nonscrambled channels.
- Using the programmable timer.

PREVENTS: Recording scrambled channels.

6

ALLOWS:

- Recording of all channels through the converter box.
- Recording a scrambled or unscrambled channel while watching another (scrambled or unscrambled) channel.
- Using the programmable timer to record only the channel selected at the converter box.

PREVENTS: Using the DVD/VCR tuner to select channels.

The unauthorized recording, use, distribution, or revision of television programs, videotapes, DVDs and other materials, is prohibited under the Copyright Laws of the United States and other countries, and may subject you to civil and/or criminal liability.

Connections with the TV or audio component

The exact arrangement you use to interconnect various video and audio components to the DVD/VCR is dependent on the model and features of each component. Check the Owner's Manual provided with each component for the location of video and audio inputs and outputs.

The unauthorized recording, use, distribution, or revision of television programs, videotapes, DVDs and other materials, is prohibited under the Copyright Laws of the United States and other countries, and may subject you to civil and/or criminal liability.

Connect to a TV with Audio/Video output

You can enjoy playback by connecting the unit to a TV.

Connect the unit to a TV equipped with audio input (L/R) and video input jacks using the supplied audio/video cable.

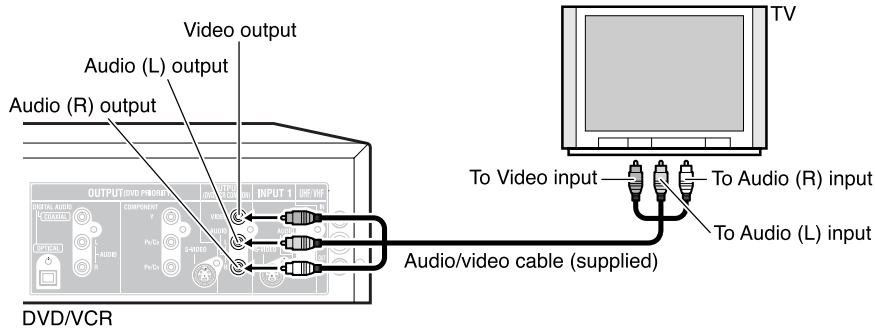

Connect to a TV with S-Video output

If your TV has an S-Video input, you can get higher quality by connecting it with the S-Video output of the unit using the S-Video cable instead of connecting the video input of the TV to the video output jack of the unit.

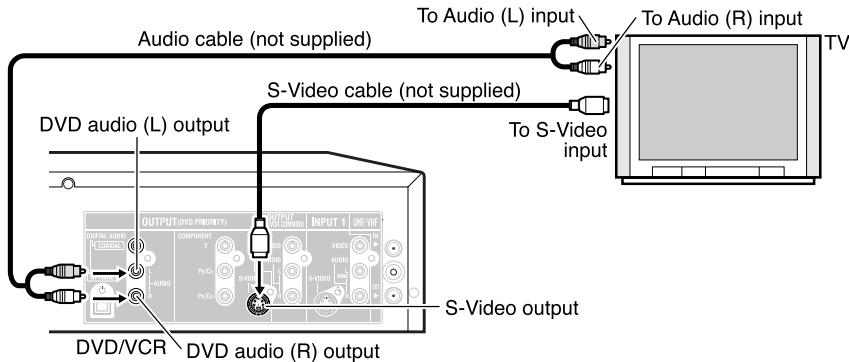

Connect to a TV with Component video output

You can enjoy the highest quality picture by connecting the unit's component video out jacks to the component video input jacks of your TV, with component video cables (not supplied).

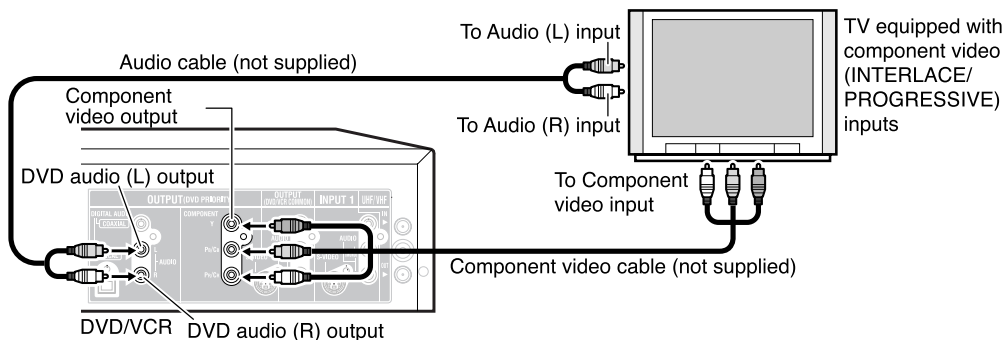

To switch the output signals (Progressive/Interlace):

Press **PROG/HDMI** to change the video output signals (progressive and interlace) from Component video output jacks (see page 21).



Connections with the TV or audio component

Connect to a TV with HDMI output

HDMI stands for High Definition Multimedia Interface. HDMI transfers digital audio and uncompressed digital video on a single cable. As a result, audio cables and video cables don't need to be connected separately to a device. In addition, HDMI is compatible with HDCP (High Bandwidth Digital Content Protection).

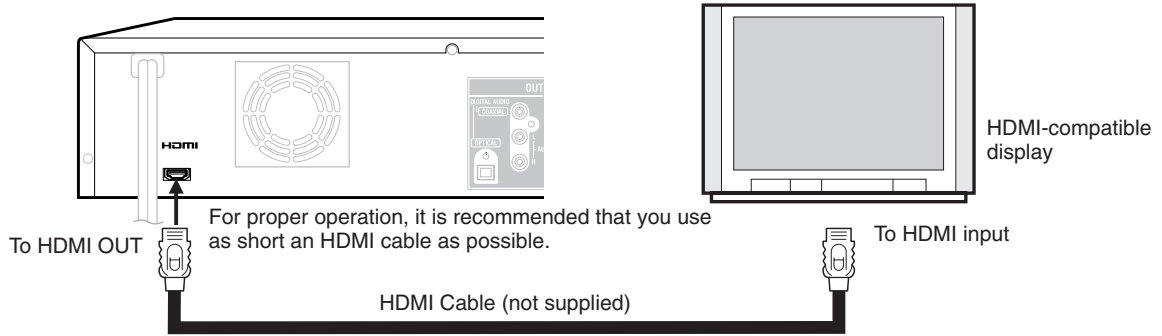

Notes:

- Refer to the owner's manual for the TV to be connected to this recorder for more information concerning HDMI connections.
- HDMI is an evolving technology, so it is possible that some devices may not operate properly with this recorder.
- No sound will be output from the HDMI OUT jack if the "DOLBY DIGITAL OUTPUT" is not set to "PCM" (see page 32).

Switching the output signals (HDMI/Progressive)



1. Turn ON the TV and set to the appropriate input mode (HDMI or Component).
2. Press **PROG/HDMI** on the remote control to change the video output signals (HDMI/Progressive) as below.

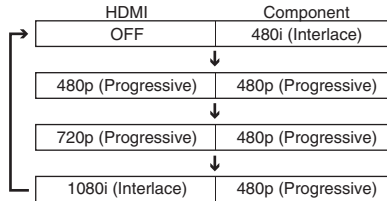

The content of the output for each output jacks are as shown in the following table and differ depending on output setting.

Mode VCR/DVD	HDMI/Progressive Output setting	Content of output for each output jack			
		HDMI	Video	S-Video	Component
DVD	OFF	-	480i	480i	480i
	480p	480p	- *	- *	480p
	720p	720p	- *	- *	480p
	1080i	1080i	- *	- *	480p
VCR	OFF	-	480i	480i	480i
	480p	480p	480i	-	480p
	720p	720p	480i	-	480p
	1080i	1080i	480i	-	480p

* When the HDMI/Progressive is active, it is impossible to output any video images from the Video out jack and S-Video out jack. In this case, press **PROG/HDMI** repeatedly to switch the HDMI/Progressive output setting to "OFF" or set the TV to Component input mode/HDMI input mode.

Notes:

- **PROG/HDMI** button is not available during VCR mode.
- 720p and 1080i are available when the unit is connected to the HDMI-compatible display.
- When the HDMI mode is active, the HDMI indicator "HD" on the display window will light up.
- If the HDMI cable is disconnected when the HDMI mode is active, the HDMI indicator "HD" on the display window will flash. In this case, press **PROG/HDMI** repeatedly to switch the HDMI output setting to "OFF", or connect the HDMI cable again.
- When the progressive mode is active, the Progressive indicator "P" on the display window will light up.
- When the HDMI mode is active, you cannot use Dubbing function (see pages 78 and 79).
- If your TV is not compatible with progressive scan, press and hold the **STOP** button on the front panel for about 3 seconds to return to normal picture.

Connections with the TV or audio component

Connect to a stereo amplifier with audio output

You can enjoy high quality audio by connecting the audio output to your amplifier.

Connect the audio output jacks to any line-level inputs (such as AUX, DVD, CD, etc.) of an audio amplifier.

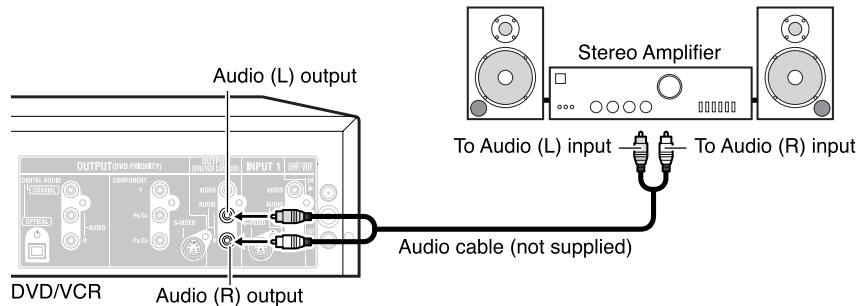

Connect to an AV Amplifier with built-in digital surround

If you are using an Amplifier with a built-in digital surround as follows, you can enjoy the various audio systems such as Dolby Digital and DTS by using the optical or coaxial digital output.

Use this connection to connect an:

- AV amplifier with built-in *Dolby Digital decoder
- AV amplifier with built-in *DTS decoder

NOTE:

You may connect to a TV with a component video cable (not supplied) or S-Video cable (not supplied) instead of a video cable (not supplied).

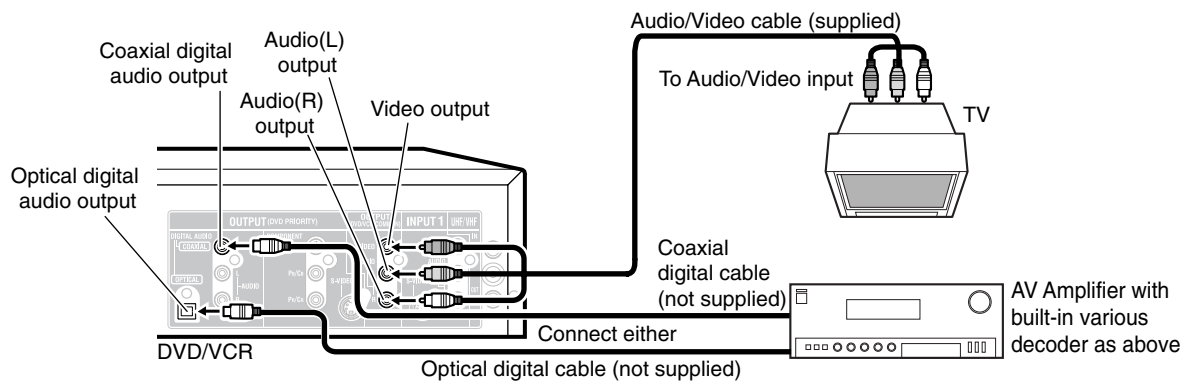

Connecting the optical digital cable

You may connect to an AV Amplifier with an optical digital cable (not supplied) instead of a coaxial digital cable.

When you connect the optical digital cable (not supplied), remove the dust protection cap from the rear panel. When not using the optical digital cable, attach the dust protection cap to protect against dust.

NOTES:

- When you make the connections above, do not set DOLBY DIGITAL to DOLBY DIGITAL or DTS to ON on the AV amplifier. If you do, a loud noise will suddenly come out from the speakers, affecting your ears or causing the speakers to be damaged.
- Caution for the optical digital audio output connector: Do not connect to an amplifier (with an optical digital input connector) which does not contain a Dolby Digital or DTS decoder. Otherwise, any attempt to play DVDs may cause such a high level of noise that it may be harmful to your ears and damage your speakers.
- DTS audio will be output only from the COAXIAL or OPTICAL output. To hear DTS audio, DTS-Decoder is necessary.
- When playing DTS-encoded CDs, only noise will be heard from the speakers or analog stereo outputs.
- Some DTS decoders which do not support DVD-DTS interface may not work properly with the unit.
- The optical or coaxial digital output jack output sounds in the bitstream.

Auto clock setting / Setting the video channel

Auto clock setting

Preparation:

You must connect the antenna or cable before connecting the AC cord to the power source.

After the antenna or cable is connected, wait for at least 3 minutes with the power turned off for the auto clock feature to activate.

After the clock is set automatically, you may have to set the Standard Time (time zone) and Daylight Saving Time. (See 27.)

Press **ON/STANDBY** to turn on the DVD/VCR after the auto clock operation completed.

- When shipped from factory, the "AUTO CLOCK" option is set to "ON" position.
- If you turn the DVD/VCR on during auto clock setting, the clock is not set.
- Depending on the reception condition, auto clock setting may take approx. 30 minutes.
- After a power failure or disconnection of the power plug, the clock will be lost. In this case, wait 3 minutes before turning the DVD/VCR on.
- With cable box connection, if the auto clock setting is unsuccessful, select the PBS channel carrying the XDS information, then turn the DVD/VCR off. After 3 minutes, turn the DVD/VCR on.
- If the clock is not set automatically, set the clock manually. (See page 27.)

Setting the video channel

To view playback of a recorded tape or DVD disc, or to watch a program selected by the VCR's channel selector, the TV must be set to channel 3 or 4 (video channel).

When a TV is connected with the 75 ohm coaxial cable only:

- 1 Press and hold **3** or **4** on the remote control for 3 seconds **in the standby mode** to select CH **3** or **4**. The selected channel number will flash on the display for about 4 seconds.
- 2 Turn **ON** the TV and set to CH **3** or **4** to correspond with the channel selected in step 1.
- 3 Press **ON/STANDBY** to turn on the DVD/VCR.
- 4 Press **TV/VIDEO** to select the VIDEO position. The TV indicator will disappear in the display.
- 5 Select any channel to receive a TV station in your area. The channel number will appear on the screen for about 4 seconds.

For a push-button TV tuner

If CH **3** or **4** corresponding to the video channel cannot be tuned on your TV, proceed as follows: set the VCR 3/4 channel selector and the TV to CH **3** or **4**, playback a prerecorded tape and tune the TV to receive a sharp color picture from the video cassette recorder. Refer to your TV owner's manual for details.

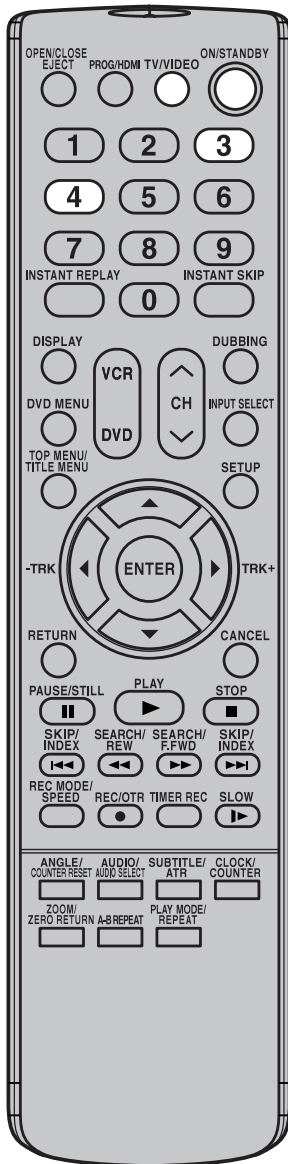

NOTES:

- When shipped from factory, the video channel is set to CH 3.
- If the unit does not operate properly, or there is no key operation from the unit and/or the remote control: Static electricity, etc., may affect the operation. Disconnect the AC power cord once, then connect it again.

SETUP MENU

The **SETUP MENU** consists of several menus where you can make various settings concerning language, audio functions, and images. In addition, this menu includes a clock, channel and other things that require setting just after purchase. For details of each menu, see the corresponding section in this chapter.

Using the SETUP MENU

The following example shows the basic setting procedure of the **SETUP MENU**. The remote control keys that operate the **SETUP MENU** are displayed at the bottom of the screen.

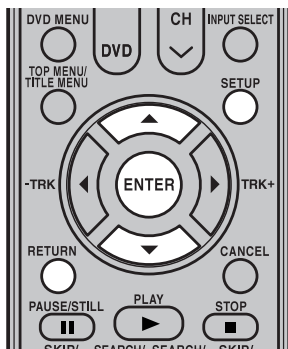

- 1 Press **SETUP** while the DVD or video tape is stopped. The **SETUP MENU** screen will appear.

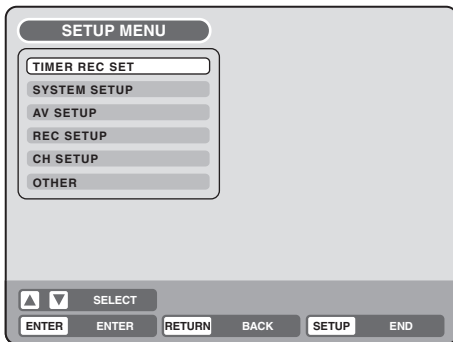

- 2 Press **▲** or **▼** to select the desired menu and press **ENTER**. The submenu screen of the selected menu will appear.

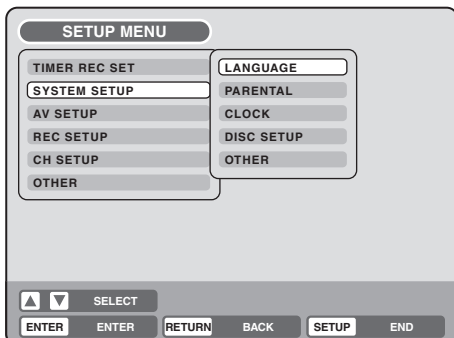

24

- 3 Press **▲** or **▼** to select the desired submenu and press **ENTER**. The screen for the selected submenu will appear.

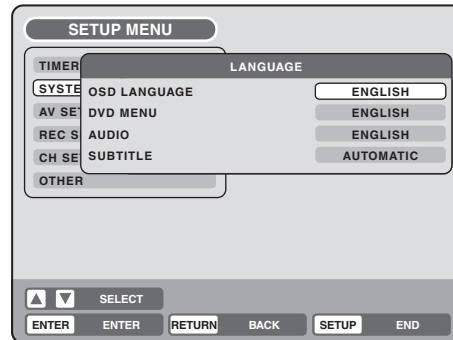

- 4 Press **▲** or **▼** to select the desired item you want and press **ENTER**. Selectable items will be listed.

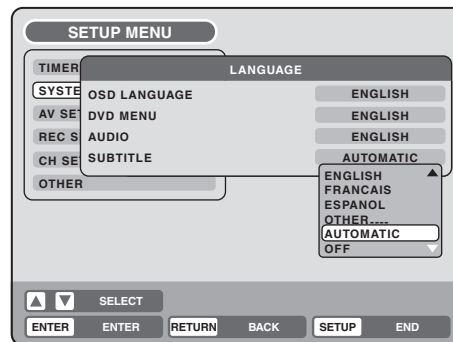

- 5 Press **▲** or **▼** to select the desired item and press **ENTER**. This completes the setting procedure.
 - To return to the previous screen, press **RETURN**.
 - To close the **SETUP MENU**, press **SETUP**.

NOTES:

- For items that require different operations from the basic setting procedure, the setting procedure is described in each individual section.
- The item which is indicated by blue color cannot be selected.
- "TIMER REC SET" cannot be selected when the clock is not set.



Setting the language

You can choose the language of the menu screen, DVD menu, DVD audio and subtitles.

Preparation:

- Turn ON the TV and set it to the video input mode.
- Select “LANGUAGE” from “SYSTEM SETUP”. For the procedure, see steps 1 to 3 in “Using the SETUP MENU” on page 24.

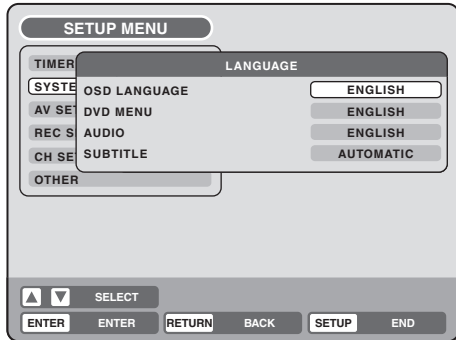

OSD LANGUAGE

You can set the language for on screen display. Select “OSD LANGUAGE” and select the language from the below.

Selectable languages:

ENGLISH, FRANCAIS, ESPANOL

DVD MENU

When several menu languages are recorded on a DVD, you can select the language to be used for the DVD menu.

Select “DVD MENU” and select the language from the below.

Selectable languages:

ENGLISH, FRANCAIS, ESPANOL

The selected language is the first priority menu language.

OTHER

If you want to select another language, before pressing **ENTER**, input the language code by using the **numeric keys**. (See the Language code list on page 84). Then press **ENTER**.

- If you input a wrong number, press **CANCEL**.

AUDIO

When several audio languages are recorded on a DVD, you can select the audio language to be played back. The selected language remains in effect after the power is turned off or the disc is replaced.

Select “AUDIO” and select the audio language from the below.

Selectable languages:

ENGLISH, FRANCAIS, ESPANOL

The language you have selected will play if it is recorded on the disc.

ORIGINAL

The unit will select the first priority language of each disc.

OTHER

If you want to select another language, before pressing **ENTER**, input the language code by using the **numeric keys**. (See the Language code list on page 84). Then press **ENTER**.

- If you input a wrong number, press **CANCEL**.

NOTE:

If the selected language is not recorded on the disc, the first priority language is selected.

SUBTITLE

When several subtitles languages are recorded on DVD, you can select the language to be used for the subtitles. The selected language remains in effect after the power is turned off or the disc is replaced.

Select “SUBTITLE” and select the menu language from the below.

Selectable languages:

ENGLISH, FRANCAIS, ESPANOL

The subtitle is displayed with the selected language if it is recorded on the disc.

OTHER

If you want to select another language, before pressing **ENTER**, input the language code by using the **numeric keys**. (See the Language code list on page 84). Then press **ENTER**.

- If you input a wrong number, press **CANCEL**.

AUTOMATIC

- The unit will automatically select the same language in the AUDIO setting.
- When the unit selects the same language as the AUDIO setting, the subtitles will not appear during playback.
- When you do not use the same language as the AUDIO setting, the subtitles will appear during playback.

OFF

Subtitles do not appear.

NOTE:

If the selected language is not recorded on the disc, the first priority language is selected.

Various settings

Setting the parental control

Some discs are specified as not suitable for children. This unit can prevent playback of such discs.

Preparation:

- Turn ON the TV and set it to the video input mode.
- Select "PARENTAL" from "SYSTEM SETUP". For the procedure, see steps 1 to 3 in "Using the SETUP MENU" on page 24.

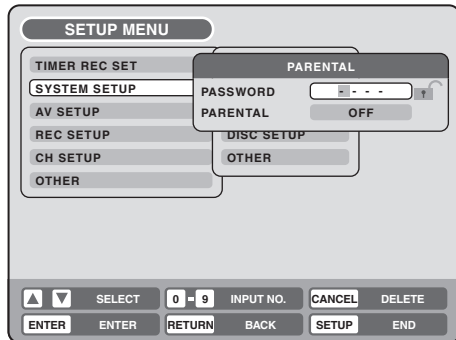

Selecting parental control

Select "PARENTAL" and select the parental control level from the below.

- Level Off:** Parental control is turned off.
- Level 1:** Adult discs and general discs (R-rated discs included) cannot be played back.
- Level 2 to 3:** Adult discs and R-rated discs cannot be played back.
- Level 4 to 7:** Adult discs cannot be played back. (Level 4 to 7 discs contain content children age 15 and younger may not see.)
- Level 8:** Virtually all discs can be played back without restriction.

Select from level 1 to level 8. On a scale of 1- 8, "1" is the most restrictive.

To lock the selected parental control level

- 1 To lock the selected parental control level, press ▲ or ▼ to select "PASSWORD".
- 2 Use the **numeric keys** to input a 4-digit password.
 - If you input a wrong number, press **CANCEL**.
 - Be sure to remember this number!
- 3 Press **ENTER**.



To cancel the locked parental control level

- 1 Select "PASSWORD" shown in step 1 of the above section and use the **numeric keys** to input the password.
- 2 Press **ENTER**. The locked mark "🔒" will change to an unlocked mark "🔓". Then, you can change the parental control level, or enter a new password.

26

NOTES:

- The selected level will apply to operations executed after this.
- The unit cannot restrict playback of some discs.
- Some discs may not be encoded with specific rating level information though its disc jacket says "adult". Parental control will not work with those discs.
- If you forget your password, open the disc tray; if there is a disc inside then remove it and close the tray. To reset the code, press and hold **number 7** on the remote control, then press and hold **STOP** on the front panel at the same time. The On-Screen Display will show "PARENTAL UNLOCK". You can now set a new password.

Temporarily cancelling parental control

Parental control can temporarily be canceled with some DVDs.

- 1 Playback a DVD. (See page 34.)
- 2 If the DVD disc has been designed to temporarily cancel the rating level, the screen that follows the "READING" screen will change. If you select "YES" with the **ENTER**, the message "YOUR DISC EXCEEDS THE PARENTAL CONTROL LEVEL 1." (e.g.) will then appear.

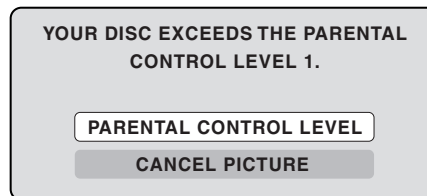

- 3 If you wish to cancel the set rating level temporarily, select "PARENTAL CONTROL LEVEL" with ▲ or ▼, then press **ENTER**. If the password has been selected, the password input screen will appear. Alternatively, if the password has not been set, playback will commence. If you don't know (or have forgotten) the password, select "CANCEL PICTURE". The setting screen will disappear. Press **OPEN/CLOSE** to remove the disc.
- 4 Use the **numeric keys** to input the password.
 - To interrupt the input process, press **RETURN**.
- 5 Press **ENTER**.
- 6 Playback will commence if the entered password was correct.

NOTE:

This temporary cancellation of the rating level will remain active until the disc is ejected. When the disc is ejected, the original rating level will be set again automatically.



Setting the clock

The clock is set to the correct time automatically, but it can also be set manually. The clock can be set for daylight saving time and time zone.

Preparation:

- Turn ON the TV and set it to the video input mode.
- Select "CLOCK" from "SYSTEM SETUP". For the procedure, see steps 1 to 3 in "Using the SETUP MENU" on page 24.

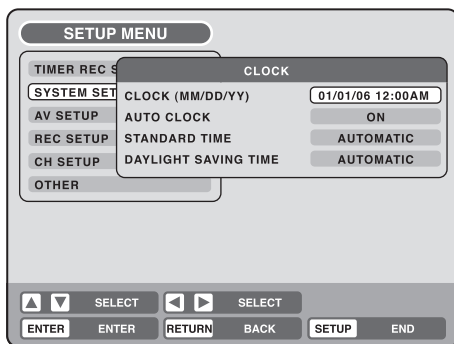

CLOCK (manually)

You can manually set the date, year and present time with the remote control.

Ex.: Setting the clock to "10:20AM" March, 25th, 2006.

- 1 Select "CLOCK" and press **ENTER**.

01/01/06 12:00AM

- 2 Select the desired items using ◀ or ▶ (month, date, year, hour, minute and AM/PM), then press **ENTER**.

- 3 Press ▲ or ▼ to set the value of the selected item.

03/25/06 10:20AM

- 4 Repeat steps 2 and 3 to set the date, year and present time, and press **ENTER**. The SETUP MENU will close.

This completes clock time setting.

AUTO CLOCK

You can automatically set the clock by turning "ON" the AUTO CLOCK function.

When you want to set the auto clock function to "OFF", select "AUTO CLOCK", press **ENTER** and select "OFF". For more information see page 23.

STANDARD TIME (Time zone)

In the rare event that you live within the broadcast range of two stations in two different time zones, the DVD/VCR may recognize the wrong station for the auto clock set. To correct the situation:

Select "STANDARD TIME" and select the time zone from the below.

Selectable time zones and correction times

- ATLANTIC:** GMT – 4 hours
(GMT: Greenwich Mean Time)
- EASTERN:** GMT – 5 hours
- CENTRAL:** GMT – 6 hours
- MOUNTAIN:** GMT – 7 hours
- PACIFIC:** GMT – 8 hours
- ALASKA:** GMT – 9 hours
- HAWAII:** GMT – 10 hours
- AUTOMATIC:** AUTO SET

NOTES:

- When shipped from the factory, the "STANDARD TIME" is set to "AUTOMATIC".
- After making the auto clock setting, in some cases the clock may display another time zone. You can correct the clock by selecting your time zone setting above.
- When the clock is not set or you set the clock manually, the time zone setting is not available.

DAYLIGHT SAVING TIME

You can set the clock to daylight saving time automatically or manually.

To select daylight saving time, select "DAYLIGHT SAVING TIME" and select "ON", while to cancel the daylight saving time, select "OFF".

- ON:** For manual setting (forward 1 hour)
- OFF:** For manual setting (back 1 hour)
- AUTOMATIC:** For automatic setting (read XDS in the signal)

NOTES:

- When you want to set daylight saving time, on the first Sunday in April you set it to "ON", and on the last Sunday in October you set it to "OFF".
- When shipped from the factory, the "DAYLIGHT SAVING TIME" option is set to "AUTOMATIC".
- When the clock is not set, the daylight saving time setting is not available.
- When there is no daylight saving time in your area, always select "OFF".

Setting the disc

You can format, protect, or finalize a disc.

Preparation:

- Turn ON the TV and set it to the video input mode.
- Select “**DISC SETUP**” from “**SYSTEM SETUP**”. For the procedure, see steps 1 to 3 in “Using the SETUP MENU” on page 24.

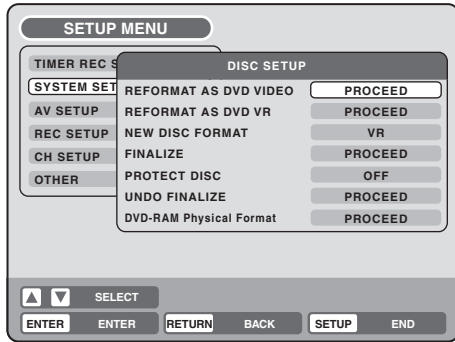

REFORMAT

You can format a recorded DVD-RAM/RW. Check the content of the disc before format. If you format the disc, the recorded content of the disc will be erased.

To format a disc in the Video mode, select “REFORMAT AS DVD VIDEO”, and to format it in the VR mode, select “REFORMAT AS DVD VR”. You cannot select “REFORMAT AS DVD VIDEO” when DVD-RAM inserted. The screen below will appear.

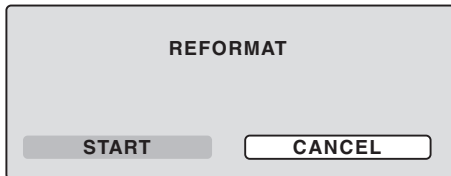

- When you select “START” and press **ENTER**, format will start. The screen below will appear.

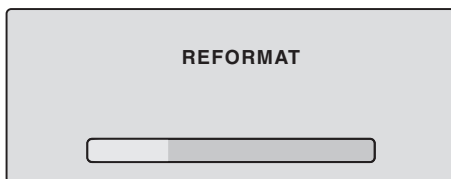

- When you select “CANCEL” and press **ENTER**, the DISC SETUP screen will appear.

NOTES:

- When the format finished, “REFORMATING COMPLETED PRESS ENTER.” will appear. Press **ENTER** to clear the screen.
- You cannot format Ver. 1.0 DVD-RW and DVD-R.
- You cannot format a disc if the disc protection is “ON”. In such a case, be sure to cancel the disc protection (see page 29) before format.
- You cannot format a DVD-RAM in the Video mode.

NEW DISC FORMAT

If you insert an unused DVD-RW disc, the disc is automatically formatted.

If you use the DVD-RW (Ver.1.1/1.2), you can select the mode to be used for automatic format.

Select “NEW DISC FORMAT” and select the mode from the list below.

- VR:** Format the disc in the VR mode.
- VIDEO:** Format the disc in the Video mode.

When you insert an unused disc, the following message screen will appear.

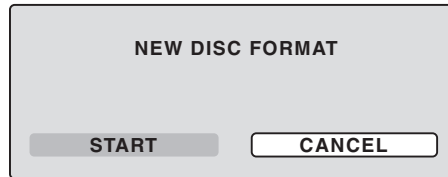

- When you select “START” and press **ENTER**, format will start. The screen below will appear.

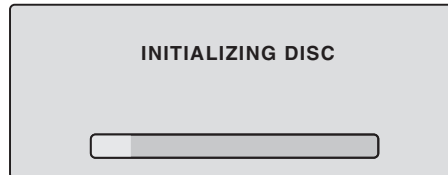

- When you select “CANCEL” and press **ENTER**, the normal TV screen will appear.

NOTES:

- When the Initialization finished, “INITIALIZING COMPLETED PRESS ENTER” will appear. Press **ENTER** to clear the screen.
- If a recorded disc has scratches or contamination on it, the “NEW DISC FORMAT” screen may appear. If this happens, select “CANCEL”.

FINALIZE

To play a DVD disc recorded on this unit you must finalize the disc to insure compatibility with other DVD players. In addition, if you are using a DVD-RW disc you must record in Video mode.

When “FINALIZE” is selected, the screen below will appear.

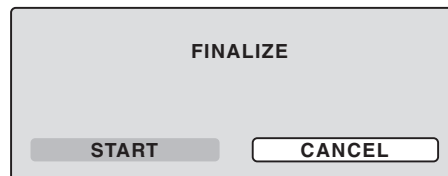

- When you select “START” and press **ENTER**, finalization will start. The screen below will appear.

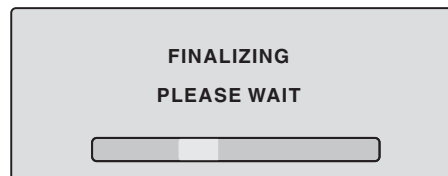

- When you select “CANCEL” and press **ENTER**, the DISC SETUP screen will appear.

Setting the disc / Other (SYSTEM SETUP)

NOTES:

- During finalizing, the cursor will move repeatedly. When the finalization finished, "FINALISING COMPLETED PRESS ENTER" will appear. Press **ENTER** to clear the screen.
- The finalization process may require a few minutes to about 1 hour according to disc type or the amount of free space on the disc.
- You can record or edit a finalized DVD-RW (in VR mode) by cancelling the finalizing, but you cannot do these operations with a DVD-RW (Video mode), or with a DVD-R.
- You cannot playback a disc recorded on VR mode on a unit that does not support DVD-RW.
- Even if you finalize a disc in the Video mode, the disc cannot be played back in some DVD players.
- A DVD-R disc cannot be named after it is finalized.

PROTECT DISC



You can protect a disc to prevent the content recorded on it from being erased, edited or re-recorded. Only DVD-RAM and DVD-RW (in VR mode) can be protected.

Select "PROTECT DISC" and select "ON" to protect the disc.

To cancel the disc protection, select "OFF".

UNDO FINALIZE



You can cancel the finalization of a finalized DVD-RW (in VR mode).

You cannot cancel the finalization for discs other than above. You can record or edit on a disc whose finalization has been canceled.

Select "UNDO FINALIZE", and the screen below will appear.

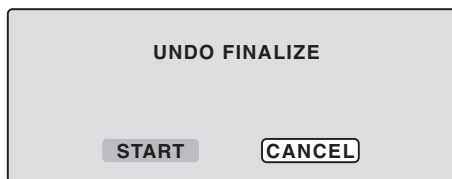

- When you select "START" and press **ENTER**, the cancelling finalization will start. The screen below will appear.

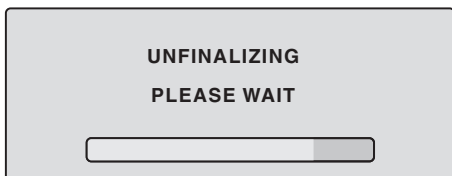

- When you select "CANCEL" and press **ENTER**, the DISC SETUP screen will appear.

NOTES:

- During unfinalizing, the cursor will move repeatedly. When cancelling finalization is complete, "UNDO FINALISING COMPLETED PRESS ENTER" will appear. Press **ENTER** to clear the screen.
- The cancelling finalization process may require a few minutes to about 1 hour according to disc type or the amount of free space on the disc.
- When the disc's finalization cannot be canceled, you cannot select "UNDO FINALIZE".

DVD-RAM Physical Format



Physically formats a DVD-RAM disc. Whenever you use a new disc for the first time, be sure to format it.

NOTE:

The physical format process may require about 1 hour according to disc condition.

This section describes the other setting in SYSTEM SETUP

Preparation:

- Turn ON the TV and set it to the video input mode.
- Select "OTHER" from "SYSTEM SETUP". For the procedure, see steps 1 to 3 in "Using the SETUP MENU" on page 24.

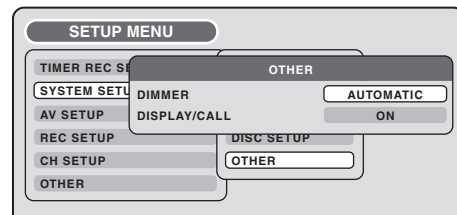

DIMMER (Brightness of the display window)

You may adjust the brightness or turn off the display on the front panel of the unit. Select "DIMMER" and select the display window status from the below.

AUTOMATIC: When the power is on, the display window appears bright. When the power is off, it appears dark.

DIM: The window display always appears dark.

OFF: When the power is on, the display window appears dark. When the power is off, it is turned off.

DISPLAY/CALL (Turning the screen display "ON" or "OFF")

You can turn off the screen display that is output to the TV screen by this unit. Select "DISPLAY/CALL", and select "ON" or "OFF".

ON: The screen display appears.

OFF: Nothing but the SETUP MENU and error messages appear.

Setting the screen

This section describes settings about the screen.

Preparation:

- Turn ON the TV and set it to the video input mode.
- Select “AV SETUP 1” from “AV SETUP”. For the procedure, see steps 1 to 3 in “Using the SETUP MENU” on page 24.

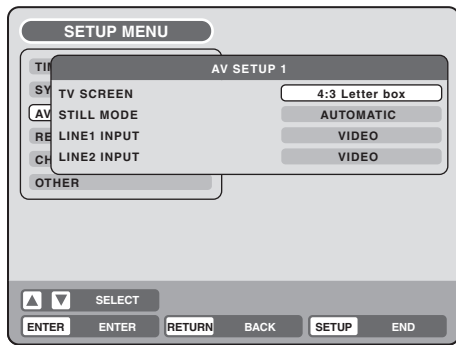

TV SCREEN

You can select the TV screen size to suit the screen image. Select “TV SCREEN” and select screen size from the below.

4:3 Pan scan

It displays a wide picture across the whole screen with left and right edges automatically cut off.

4:3 Letter box

Select this mode when connecting to a conventional TV. When playing back a wide screen DVD disc, it displays a wide picture with black bands at the top and bottom of screen.

16:9

Select this mode when connecting to a wide-screen TV. A wide-screen picture is displayed in full size.

NOTE:

If the DVD disc is not formatted in the pan scan format, it displays a 4:3 aspect ratio.

STILL MODE

You can set the type of image displayed on the TV screen when the playback of the DVD is stilled. Select “STILL MODE” and select the image to be displayed from the below.

AUTOMATIC

The field still or frame still is automatically selected. (For normal use.)

STILL BY FRAME

The frame still is set.

Note for the field still and frame still:

(with 480i interlaced scanning mode)

- **Field* still (240 lines)**
Since only one field (half of the video information) is shown on the TV screen, the picture appears rough but does not shake.
- **Frame* still (480 lines)**
Two fields are alternatively shown on the TV screen. The picture shakes but the resulting picture quality is superior to the field still pictures.

Field*: A field refers to the video information in one-half of a frame. 1 frame (screen) consists of 2 fields.

Frame*: A frame refers to the total area occupied by each picture on the TV screen.

LINE1 INPUT/LINE2 INPUT

This unit comes with an S-Video input jack and Video input jack. When you use an S-Video or Video input jack, you must select the input mode.

Select “LINE1 INPUT” (“LINE2 INPUT”) and select the mode from the below.

S-VIDEO

The video signal is input to the S-Video input jack as priority.

VIDEO

The video signal is input only to the video input jack.



Setting the image quality / Setting the audio

This section describes image quality settings.

Preparation:

- Turn ON the TV and set it to the video input mode.
- Select "AV SETUP 2" in "AV SETUP". For the procedure, see steps 1 to 3 in "Using the SETUP MENU" on page 24.

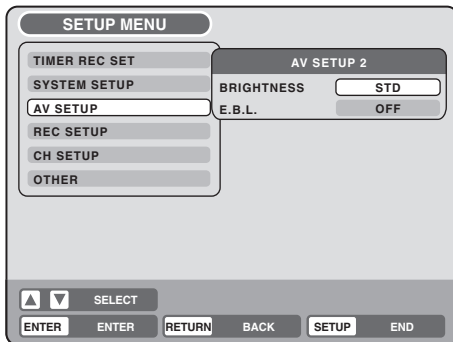

BRIGHTNESS

You can control the brightness level of the image. Select "BRIGHTNESS" and select the level from the below.

- MAX:** The image becomes brighter.
- STD:** The image is of standard brightness.
- MIN:** The image becomes darker.

E.B.L.

To select the black level of playback pictures, set your preference and monitor's ability.

- ON:** Enhanced grey scale (0 IRE cut off)
- OFF:** Standard grey scale (7.5 IRE cut off)

NOTE:

The E.B.L. function only works when playing back DVD-Video, DVD-RAM/RW/R or Video-CDs.

This section describes audio settings.

Preparation:

- Turn ON the TV and set it to the video input mode.
- Select "AUDIO" from "AV SETUP". For the procedure, see steps 1 to 3 in "Using the SETUP MENU" on page 24.

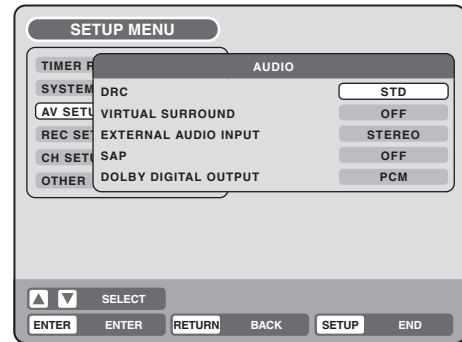

Various settings

DRC

DRC (Dynamic Range Control) enables you to control the dynamic range so as to achieve a suitable sound for your equipment.

Select "DRC" and select the level from the below.

- MAX:** Full dynamic range is maintained.
- STD:** Full dynamic range is reduced.
- TV:** Dynamic range is reduced.

NOTES:

- This function works only during playback of Dolby Digital recorded discs.
- When you listen to the sound from TV's speaker, we recommend that you select "TV".
- The level of Dynamic Range Reduction may differ depending on the DVD.

VIRTUAL SURROUND (Spatializer N-2-2™)

Sound that is not recorded in the surround mode will be changed to artificial surround sound and output. Select "VIRTUAL SURROUND" and select "ON" to activate the virtual surround function. Select "OFF" to cancel the virtual surround function.

NOTE:

This function does not work with a video tape.

EXTERNAL AUDIO INPUT

The audio mode for the audio input jack can be selected, choosing either stereo or monaural. Select "EXTERNAL AUDIO INPUT" and select from the below.

- STEREO:** The sound is treated as stereo sound.
- L CH:** The sound is treated as the monaural sound of the left channel.
- R CH:** The sound is treated as the monaural sound of the right channel.

Setting the audio / Setting the recording

SAP (Second Audio Program)

This unit is fitted with an SAP broadcast system that enables you to switch to a second audio program while viewing a selected channel.

This function applies only when the program is broadcast in multiple languages through the SAP broadcast system.

Select "SAP" and select "ON" to activate SAP. Select "OFF" to cancel.

Listening to SAP

When the unit is turned on or a channel selection is made, make certain the letters "SAP" appear on the screen. This means that "Second Audio Program" broadcasting is available.

DOLBY DIGITAL OUTPUT

Select from the following methods of outputting the audio of discs that were recorded with Dolby Digital.

- DOLBY DIGITAL:** Outputs in Dolby Digital sound.
- PCM:** Converts the sound to PCM and outputs it.

NOTE:

Select PCM if you are connected to an audio amplifier and the amplifier is not Dolby Digital compatible.

This section describes recording settings.

Preparation:

- Turn ON the TV and set it to the video input mode.
- Select "REC SETUP". For the procedure, see steps 1 to 3 in "Using the SETUP MENU" on page 24.

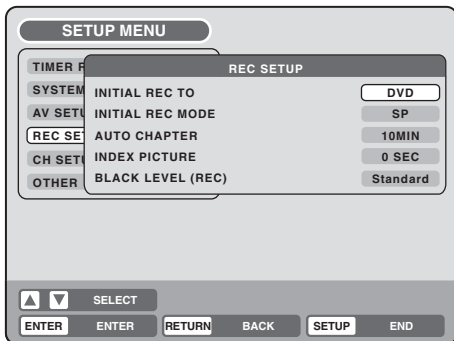

INITIAL REC TO

You can select the recording media that is first displayed in the item "REC TO" on the timer recording screen. Select "INITIAL REC TO" and select "DVD" or "VCR".

INITIAL REC MODE

You can select the recording mode that is first displayed in the item "REC MODE" on the timer recording screen. Select "INITIAL REC MODE" and select XP, SP, LP, or SLP.

NOTES:

- For the DVD recording mode, see page 53. And for the VCR recording mode, see page 49.
- Even if you select the recording mode by "INITIAL REC MODE", the recording mode on the display window does not change. If you want to change the recording mode, press **REC MODE/SPEED** on the remote control.

AUTO CHAPTER

You can automatically make chapter marks on the DVD to be recorded.

Select "AUTO CHAPTER" and select the interval between chapter marks from the below.

- OFF:** The automatic chapter is not used.
- 5 MIN:** The interval is set to 5 minutes.
- 10 MIN:** The interval is set to 10 minutes.
- 15 MIN:** The interval is set to 15 minutes.
- 30 MIN:** The interval is set to 30 minutes.

INDEX PICTURE

You can set the time that the thumbnail image is registered in the title menu of DVD-RW (VR mode).

Select "INDEX PICTURE" and select from the below.

- 0 SEC:** The image of a recording start point is registered.
- 1 MIN:** The image of a recording at 1 minute start point will be registered.
- 3 MIN:** The image of a recording at 3 minutes start point will be registered.

NOTE:

You cannot select the thumbnail image for Video mode.

BLACK LEVEL (REC)

You can set the black level for when you record.

- Standard :** Records at the level of the input source.
- Enhanced :** Lowers the level 7.5IRE and records.

The unauthorized recording, use, distribution, or revision of television programs, videotapes, DVDs and other materials, is prohibited under the Copyright Laws of the United States and other countries, and may subject you to civil and/or criminal liability.

Setting the channel / Setting other items

This DVD/VCR is equipped with a channel memory feature that allows you to skip channels up or down to the next channel set in memory, hence skip over unwanted channels.

Before selecting channels, they must be programmed into the DVD/VCR's memory. In addition to normal VHF and UHF channels, this DVD/VCR can receive up to 113 Cable TV channels. To use this DVD/VCR with an antenna, set the TV/CABLE menu option to the TV mode. When shipped from the factory, this menu option is in the CABLE mode.

Preparation:

- Turn ON the TV and set it to the video input mode.
- Select "CH SETUP". For the procedure, see steps 1 to 3 in "Using the SETUP MENU" on page 24.

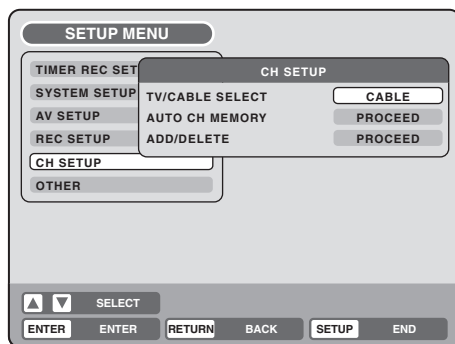

TV/CABLE SELECT

Select "TV/CABLE SELECT" and select "TV" or "CABLE".

- TV:** VHF/UHF channels
- CABLE:** CABLE TV channels

AUTO CH MEMORY

The VCR can receive a maximum of 181 channels by presetting the channels into memory. When you select "AUTO CH MEMORY" and press **ENTER**, the AUTO CH MEMORY function will be activated. The channel display will count up and, when finished, the screen returns to normal.

ADD/DELETE (channels)

You can add the channels you want or delete the channels you do not want manually. Select "ADD/DELETE" and select "ADD" or "DEL" for each channel.

- Press **CH** \wedge/\vee to select the channel. The **numeric keys** can also be used for selection.
- When you want to delete the selected channel, press \blacktriangleright to select "DEL" and press **ENTER**.
- When you want to use the selected channel, press \blacktriangleleft to select "ADD" and press **ENTER**.

You can set the switching interval between played back images in the slide show mode. And, you can display the registration code of DivX® VOD.

Preparation:

- Turn ON the TV and set it to the video input mode.
- Select "OTHER". For the procedure, see steps 1 to 3 in "Using the SETUP MENU" on page 24.

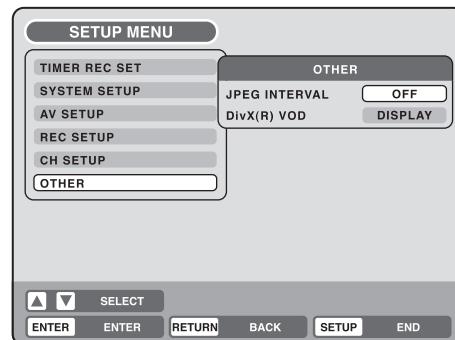

Various settings

JPEG INTERVAL

You can select the interval time for JPEG slide show (page 47).

Select "JPEG INTERVAL" and select the switching interval between images from the below.

- OFF:** The slide show mode is not used.
- 5 SEC:** The interval is set to 5 seconds.
- 10 SEC:** The interval is set to 10 seconds.
- 15 SEC:** The interval is set to 15 seconds.

DivX® VOD

This unit is designed and manufactured to support the DivX® VOD (Video On Demand) DRM (Digital Rights Management). You can display the registration code of VOD.

Playback procedure

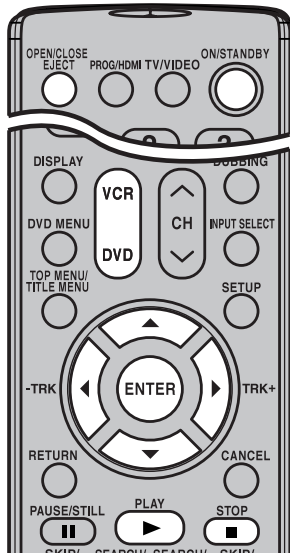

NOTES:

- If a non-compatible disc is loaded, "INCORRECT DISC", "REGION CODE ERROR" or "PARENTAL ERROR" will appear on the TV screen according to the type of loaded disc. In this case, check your disc again (See pages 9 and 26).
- Some discs may take a minute or so to start playback.
- A prohibition symbol "⊘" may appear at the upper right of the screen. This symbol means either the feature you tried is not available on the disc, or the DVD/VCR can not access the feature at this time. This does not indicate a problem with the DVD/VCR.
- When you set a single-faced disc label downwards (ie. the wrong way up) and press **PLAY** or **OPEN/CLOSE**, "READING" will appear and then it will change to "NO DISC".
- Some playback operations of DVDs may be intentionally fixed by software producers. Since this DVD/VCR plays DVDs according to the disc contents the software producers designed, some playback features may not be available. Also refer to the instructions supplied with the DVDs.
- When playing DTS-encoded Audio CDs, excessive noise will be heard from the analog stereo outputs. To avoid possible damage to the audio system, the consumer should take proper precautions when the analog stereo outputs of the DVD/VCR are connected to an amplification system.

Preparation:

- Turn ON the TV and set to the video input mode.
- Press **DVD** to select the DVD mode. (The DVD indicator will light.)

NOTE: It is impossible to switch to the VCR mode while DVD is played back.

- 1 Press **OPEN/CLOSE**.
The disc tray will open.
- 2 Place a disc onto the tray.
Hold the disc, position it with the printed label side up, align it with the guide and place it in its proper position.
- 3 Press **OPEN/CLOSE** to close the disc tray.
"READING" appears on the screen and some discs start playback automatically.
 - A menu screen may appear on the TV screen if the disc has a menu feature. In this case, press **▲**, **▼**, **◀**, **▶** or **ENTER** to operate a menu feature.
- 4 Press **PLAY** to start playback.
- 5 Press **STOP** to end playback.
 - The DVD/VCR memorizes the stopped point, depending on the disc. "⏏" appears on the screen for approx. 4 seconds. "▶" keeps blinking in the display window until the playback is stopped completely. Press **PLAY** to resume playback (from the scene point).
 - If you press **STOP** again ("■" appears on the screen), the DVD/VCR will clear the stopped point.
- 6 Then press **OPEN/CLOSE**.
The disc tray opens.
Remove the disc and press **ON/STANDBY**.
The disc tray closes automatically and DVD/VCR turns off.

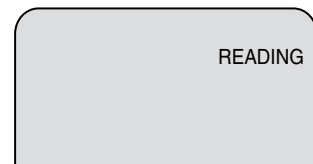
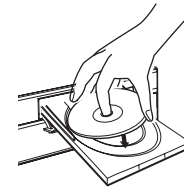

Playback by selecting a title



When playing back a recorded disc, you can display the title menu and select the title to be played back.

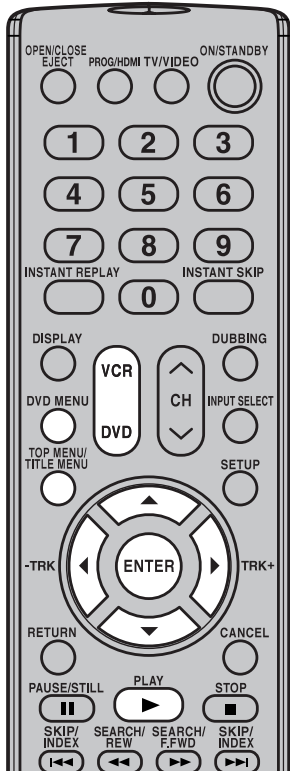

NOTE:

When a disc that has been recorded in the Video mode is finalized, the title menu is automatically changed that can be played back even with other DVD players. Thumbnail image and recording information will not appear in the title menu after finalizing

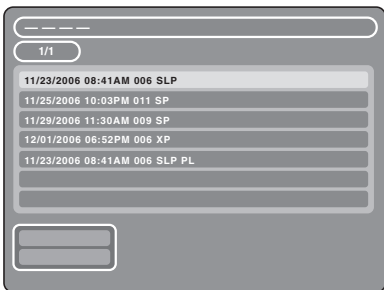

Preparation:

- Turn ON the TV and set to the video input mode.
- Load a recorded DVD.
- Press **DVD** to select the DVD mode. (The DVD indicator will light.)

- 1 Press **TITLE MENU**.
The title menu will appear.

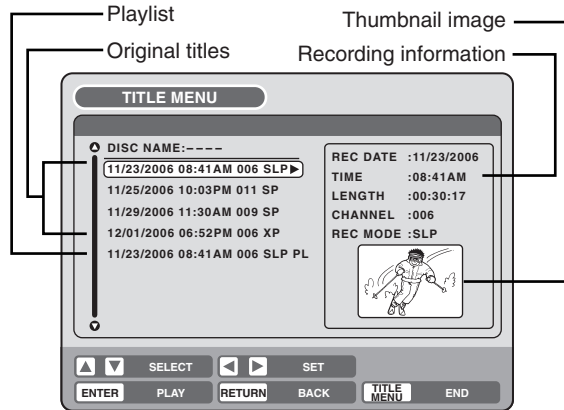

Disc playback

If there are many original titles and playlists...

Before pressing **TITLE MENU**, press **DVD MENU** until "VR ORG" or "VR PL" appear on the upper right of the TV screen, then press **TITLE MENU**.

The first original title or playlist will be highlighted.

- 2 Press **▲** or **▼** to select the title you want to playback.

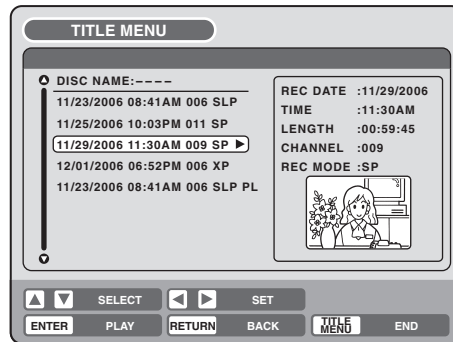

- 3 Press **ENTER**.
The selected title is played back.

NOTES:

- If you don't display the title menu and press **PLAY**, the first title is played back.
- The title menu is used not only for playing back titles but also for editing various discs and titles. For details of editing operation, see page 63.
- If you create a playlist, an original title and playlist appear in the title menu. For creating a playlist, see page 64.
- In case the disc includes more than 9 titles, you can turn to the next or the previous page. Press **◀**, then press **▼** or **▲** to display next/previous page. To return to normal use, press **▶**.
- You cannot switch to the VCR mode when the title menu is showing. Press **TITLE MENU** to clear the title menu, then press **VCR** to switch to the VCR mode.

Checking media information



Various information on the loaded disc can be displayed on the TV screen.

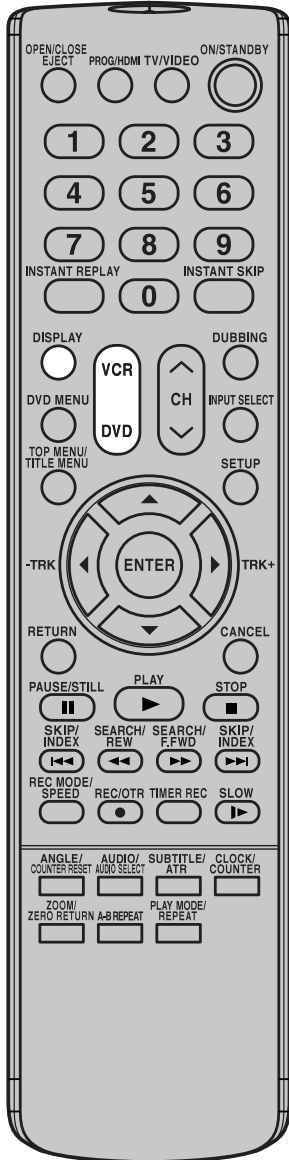

Preparation:

- Turn ON the TV and set it to the video input mode.
- Load the disc.
- Press **DVD** to select the DVD mode. (The DVD indicator will light.)

1 Press **DISPLAY**.
Media information will appear.

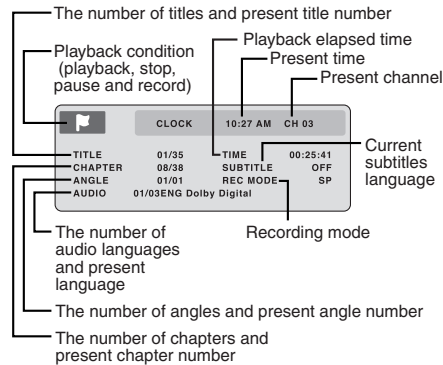

2 Press **DISPLAY** while the media information above is displayed.
The next media information will appear.

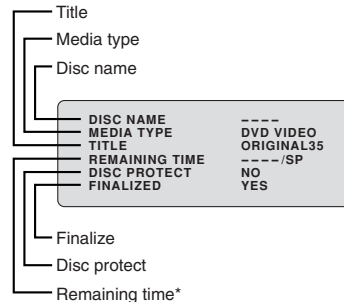

*The remaining time displayed during recording may be different from the actual remaining time. When you want to check the correct remaining time, stop recording and display the media information again.

3 Press **DISPLAY** again while the media information above is displayed. The media information will disappear.

*If you press **DISPLAY** during chase playback, the information screen is displayed.

The symbols indicate that the player is in chase playback. The progress bar shows the current position of playback and the position of recording. Normally the recording position is shown as being at 100%. Items other than these appear the same as on a normal information screen.

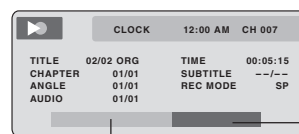

Current Playback position

Current recording position (Fixed at 100%)

NOTES:

- The displayed information varies with the type of media.
- Some information may not appear due to media type or operating conditions.
- In stop mode, some information does not appear.

Special playback



NOTE: There may be a slight delay between pressing the button and the function activation.

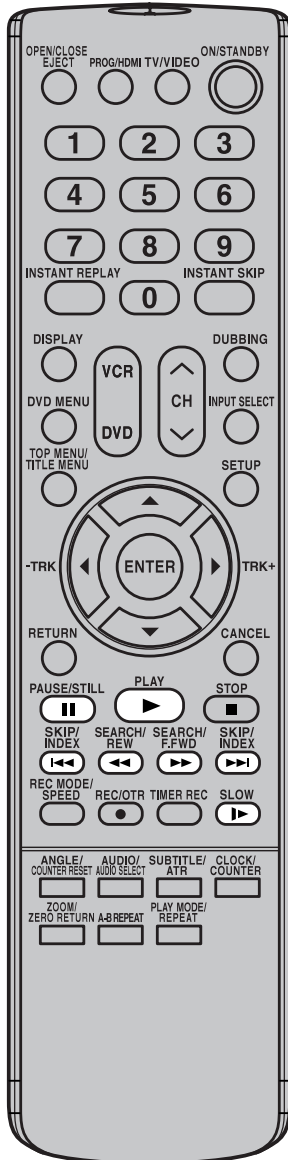

Fast forward playback

Press **SEARCH** **▶▶** during normal playback. Each press of **SEARCH** **▶▶** will increase the speed of the search **▶▶** (x2), **▶▶▶▶** (x12), **▶▶▶▶▶▶** (x24), **▶▶▶▶▶▶▶▶** (x100). (The speed of the search is increased up to only 2 steps in Audio CD.)

- To resume normal playback, press **PLAY**.

Review playback

Press **SEARCH** **◀◀** during normal playback. Each press of **SEARCH** **◀◀** will increase the speed of the search **◀◀** (x2), **◀◀◀◀** (x12), **◀◀◀◀◀◀** (x24), **◀◀◀◀◀◀◀◀** (x100). (The speed of the search is increased up to only 2 steps in Audio CD.)

- To resume normal playback, press **PLAY**.

Still playback

Press **PAUSE/STILL** during normal playback.

- To resume normal playback, press **PLAY**.

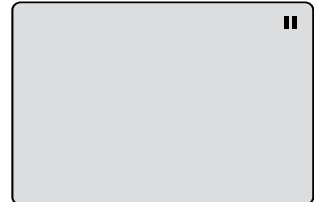

Disc playback

Frame advance

Press **PAUSE/STILL** during still playback. One frame is advanced each time you press **PAUSE/STILL**.

- To resume normal playback, press **PLAY**.

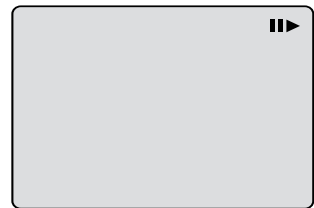

Slow motion playback

Press **SLOW** during normal playback or still playback. Each press of **SLOW** will change the speed of the slow "▶▶ 1/2", "▶▶ 1/4" and "▶▶ 1/8".

- To resume normal playback, press **PLAY**.
- To resume the still playback, press **PAUSE/STILL**.

Locating a chapter or track

Press **SKIP** **▶▶** or **SKIP** **◀◀** during playback to locate a chapter that you want to watch. Each time you press the button, a chapter or track is skipped.

- When you press **SKIP** **◀◀** once, playback starts from the beginning of the current chapter or track. If you want to play the preceding chapter or track, press **SKIP** **◀◀** twice in quick successions.

NOTES:

- The unit is capable of holding a still video image or On screen display image on your television screen indefinitely. If you leave the still video image or On screen display image displayed on your TV for an extended period of time, you risk permanent damage to your television screen. Projection televisions are very susceptible.
- Fast forward and review playback does not work with a MP3/WMA/JPEG CD.
- Frame advance and slow motion does not work with a MP3/WMA/JPEG CD.

Instant skip / Locating a specific scene

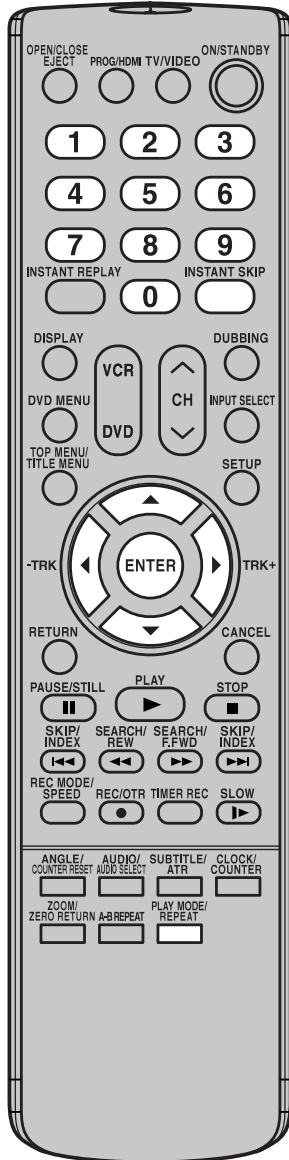

Instant skip

Use this function to skip commercials while you playback.

Press **INSTANT SKIP** during playback.

The time jumps to a point approx. 30 seconds later and playback resumes.

NOTE:

With some DVD-Video, the Commercial skip operation may not work.

Locating a specific scene

Specify the time recorded on the disc, chapter or title to playback.

- 1 Press **PLAY MODE**.
The play mode screen will appear.

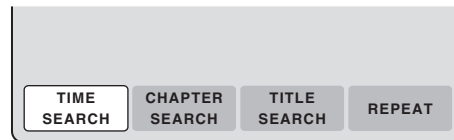

- 2 Press **◀** or **▶** to select "TIME SEARCH", "CHAPTER SEARCH" or "TITLE SEARCH", and press **ENTER**.

TIME SEARCH: Input the time to be played back.

CHAPTER SEARCH: Select the chapter number to be played back.

TITLE SEARCH: Select the title number to be played back.

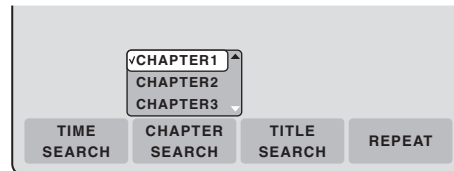

The screen above shows the display when "CHAPTER SEARCH" is selected.

- 3 When selecting "TIME SEARCH", input the time to be played back with the **numeric keys**. When selecting "CHAPTER SEARCH" or "TITLE SEARCH", press **▲** or **▼** to select the chapter number or title number.

- 4 Press **ENTER**.
The playback starts at the point you selected.

NOTE:

For "REPEAT", see "Title, Chapter repeat playback" (page 39).



Repeat playback

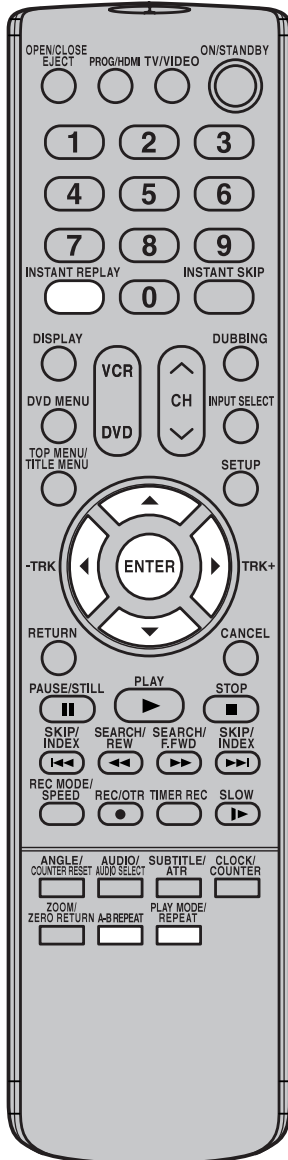

NOTES:

- Some discs may not work with the repeat operation.
- In A-B repeat mode, subtitles near point A or B may not appear.
- A-B repeat does not work during the Title and the Chapter repeat playback.
- You may not be able to set A-B repeat, depending on the scenes of the DVD.
- A-B repeat, Title repeat and Chapter repeat will not work with a MP3/WMA/JPEG-CD and Video CD.
- Chapter repeat will not work with a DivX® CD.

Instant replay

This feature can be used to repeat the last 10 seconds of viewed material, and continues to play as normal.

Press **INSTANT REPLAY** during playback.

The video returns to a point 10 seconds before and playback resumes.

NOTES:

- If the time from the title top is less than 10 seconds when **INSTANT REPLAY** is pressed, the title top is repeated and then the video is played back.
- With some DVD-Video, the one touch repeat operation may not work.

A-B repeat playback

A-B repeat playback allows you to repeat material between two selected points.

1 Press **A-B REPEAT** during playback.

The start point is selected.



2 Press **A-B REPEAT** again.

The end point is selected. Playback starts at the point that you selected. Playback stops at the end point, returns to point A automatically, then starts again.

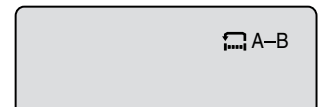

To resume normal playback press **A-B REPEAT** again.

“OFF” appears on the screen.

Title, Chapter repeat playback

1 Press **REPEAT** during playback.

The play mode screen will appear.

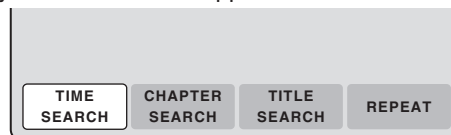

2 Press **◀** or **▶** to select “REPEAT” and press **ENTER**.



3 Press **▲** or **▼** to select “OFF”, “CHAPTER” or “TITLE”.

OFF: Playback is not repeated.

CHAPTER: The chapter is played back repeatedly.

TITLE: The title is played back repeatedly.

4 Press **ENTER**.

To cancel the repeat playback, select “OFF” in step 3.

Disc playback

Title selection / DVD menu

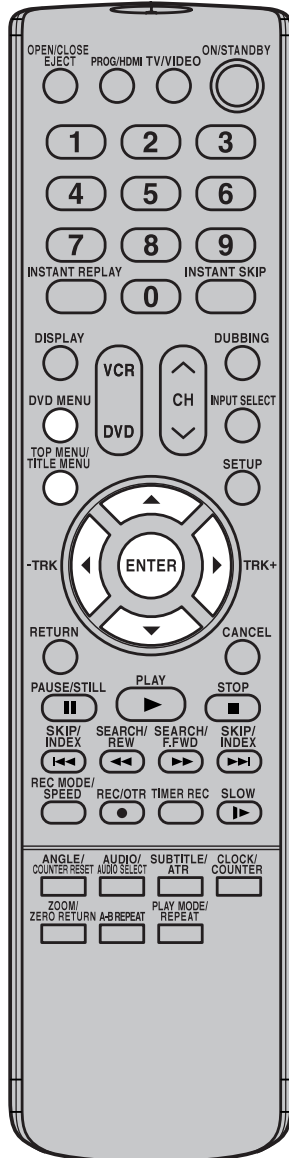

Title selection

Two or more titles are recorded on some discs. If the title menu is recorded on the disc, you can select the desired title.

- 1 Press **TOP MENU/TITLE MENU** during playback. The title menu appears on the screen.
 - Press **TOP MENU/TITLE MENU** again to resume playback at the scene where you pressed **TOP MENU/TITLE MENU**.
- 2 Press **▲/▼** or **◀/▶** to select the desired title.
- 3 Press **ENTER**. The playback of the selected title will start.

DVD menu

Some DVDs allow you to select the disc contents using the menu. When you playback these DVDs, you can select the subtitles language and soundtrack language, etc. using the DVD menu.

- 1 Press **DVD MENU** during playback. The DVD menu appears on the screen.
 - Press **DVD MENU** again to resume playback at the scene where you pressed **DVD MENU**.
- 2 Press **▲/▼** or **◀/▶** to select the desired item.
- 3 Press **ENTER**. The menu continues to another screen. Repeat steps 2 and 3 to set the item completely.

NOTES:

- Depending on the DVD, you may not be able to select the title, and a "title menu" may simply be called a "menu" or "title" in the instructions supplied with the disc.
- Depending on the DVD, you may not be able to resume playback at the scene where you pressed **TOP MENU/TITLE MENU** or **DVD MENU**.

Changing angles / Zooming / Karaoke playback

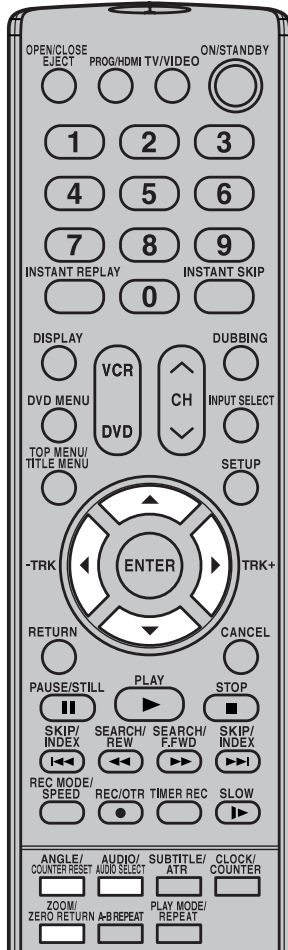

Changing angles

When playing back a disc recorded with multi-angle facility, you can change the angle that you are viewing the scene from.

- 1 Press **ANGLE** during playback. The current angle will appear.

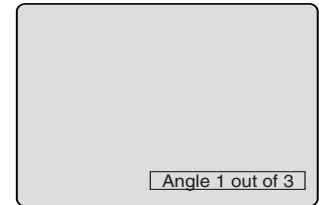

- 2 Press **ANGLE** repeatedly until the desired angle is selected.

Disc playback

Zooming

This unit will allow you to zoom in on the frame image. You can then make selections by switching the position of the frame.

- 1 Press **ZOOM** during playback. The center part of the image will be zoomed in. Each press of **ZOOM** will change the ZOOM "x2", "x3" and "x4".

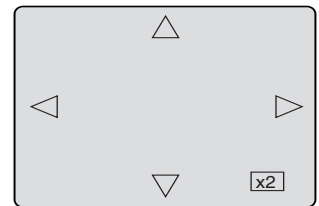

- 2 Press **▲/▼** or **◀/▶** to view a different part of the frame. You may move the frame from the center position to UP, DOWN, LEFT or RIGHT direction.

- 3 In the zoom mode press **ZOOM** repeatedly to return to a 1:1 view "x1".

NOTES:

- Depending on the DVD, you may not be able to change the angles even if multi-angles are recorded on the disc.
- You can use the Pause, Slow, Search or Skip feature in the zoom mode.
- Zoom function does not work with a DivX® CD and Video CD.
- The vocal output feature is used during playback of Dolby Digital (multi-channel) recorded DVD KARAOKE discs. This feature allows you to turn off vocal audio tracks, or restore them for background accompaniment.
- When playing Karaoke, connect appropriate audio equipment such as an amplifier to this unit.

Karaoke playback

You can turn the vocal on or off recorded on the DVD KARAOKE.

During DVD KARAOKE disc playback, press **AUDIO** repeatedly until the desired setting is selected.

- Vo. ON** : The primary vocal is output when it is recorded on the disc.
- Vo. OFF** : The primary vocal is not output.

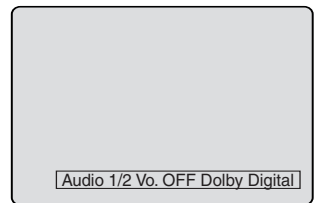

NOTES :

- Some Karaoke discs may not have the vocal on/off function.
- The on screen display will disappear after a few seconds.

Changing soundtrack language / Subtitles / To turn off the PBC (VIDEO CD Version 2.0)

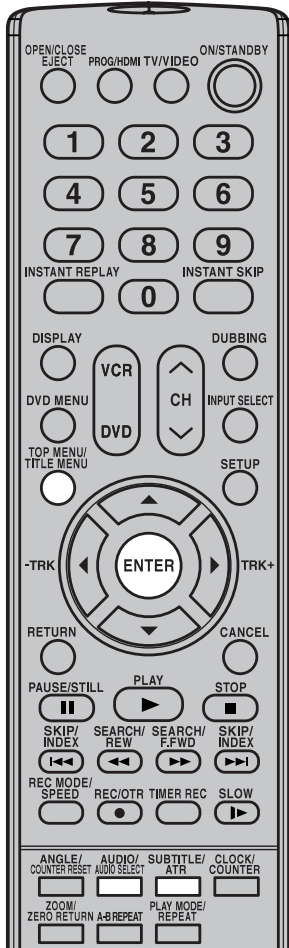

Changing soundtrack language

You can select the language when you play a multilingual disc.

1 Press **AUDIO** during playback.
The current soundtrack language will appear.

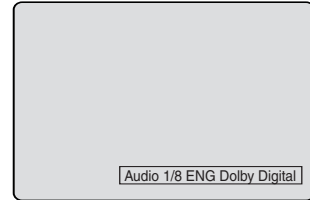

2 Press **AUDIO** repeatedly until the desired language is selected.
The on-screen display will disappear after a few seconds.

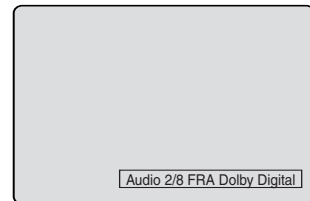

■ In case of VIDEO CD playback

Each time you press the **AUDIO** button, the audio type will change as follows:

VIDEO CD

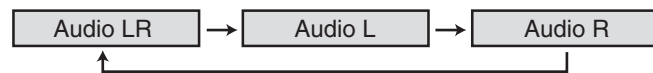

S-VCD

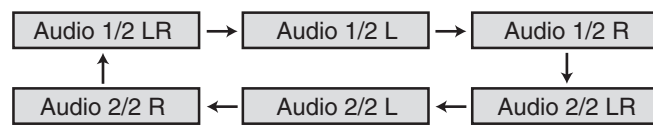

Subtitles

Turning the subtitles On and Off

When playing back a disc recorded with subtitles, you can turn the subtitles on or off.

Press **SUBTITLE** during playback until "Subtitle OFF" appears.

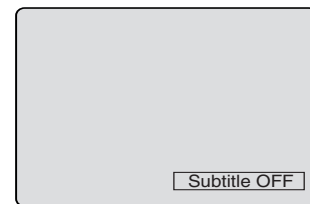

Changing the subtitles language

You can select the language when playing back a disc recorded with multilingual subtitles.

Press **SUBTITLE** repeatedly during playback until your desired language appears.
The on screen display will disappear after a few seconds.

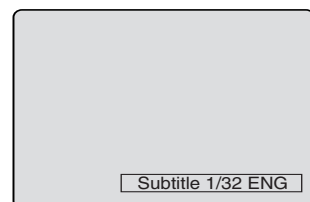

To turn off the PBC (VIDEO CD Version 2.0)

Press **TITLE MENU** in the stop mode, then press **ENTER**.

NOTES:

- If the desired language is not heard after pressing the button several times, the language is not recorded on the disc.
- Changing soundtrack or subtitles language is canceled when you open the disc tray. The initial default language or available language will be heard and seen if the disc is played back again.
- Depending on the DVD you may be unable to turn on, turn off, or change the subtitles, even if they are recorded on the disc. While playing the DVD, the subtitles may change while opening or closing the disc tray, or while changing the title.
- In some cases, the subtitles language is not changed to the selected one immediately.

Various operations on CD



This section describes the **TRACK INFO** screen where music CDs or Video CDs can be played back using the various operations.

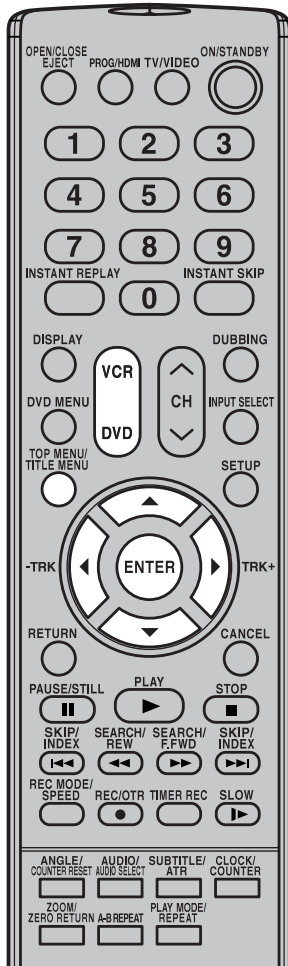

Preparation:

- Turn ON the TV and set to the video input mode.
- Load the music CD or Video CD.
- Press **DVD** to select the DVD mode. (The DVD indicator will light.)

Press **TOP MENU/TITLE MENU**. The **TRACK INFO** screen will appear.

The elapsed time and total time of the music data (during playback)

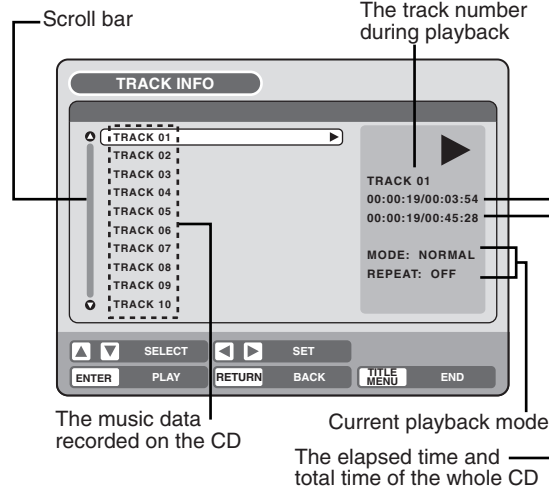

Disc playback

Press **▶**. The menu list will appear.

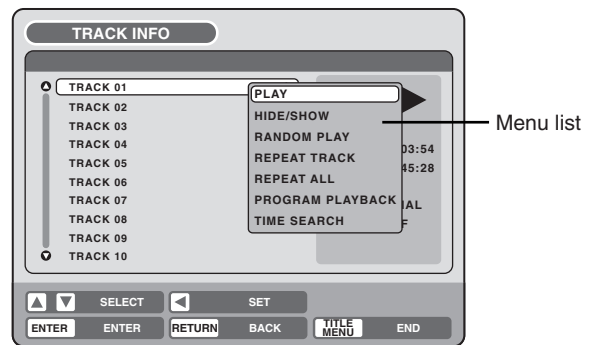

NOTES:

- In case the disc includes more than 10 tracks, you can turn to the next or the previous page. Press **◀**, then press **▼** or **▲** to display next/previous page. To return to normal use, press **▶**.
- In case of VCD and SVCD playback, "HIDE/SHOW", "RANDOM PLAY", "PROGRAM PLAYBACK" and "TIME SEARCH" will not appear in the menu list.

Playing back a selected track

- 1 Press **▲** or **▼** to select the track number you want to playback and press **▶**.
- 2 Press **▲** or **▼** to select "PLAY" from the menu list and press **ENTER**. The selected track will be played back.

Excluding specified track

- 1 During stop, press **▲** or **▼** to select the track number you do not want to playback and press **▶**.
- 2 Press **▲** or **▼** to select "HIDE/SHOW" from the menu list and press **ENTER**. The selected track will not be played back. ("H" appears at the side of the track number.)

When you want to cancel the exclusion, press **▲** or **▼** to select the track number with "H" and press **▶**. Press **▲** or **▼** to select "HIDE/SHOW" from the menu list and press **ENTER**, "HIDE" will be canceled.

Various operations on CD

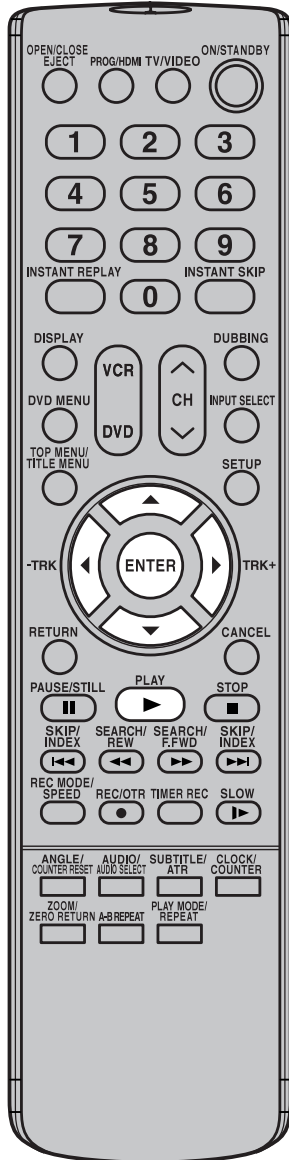

NOTE:

When recording on a CD-R/CD-RW in the MP3 or WMA modes, "RANDOM PLAY" and "TIME SEARCH" will not appear in the menu list.

Random playback

- 1 Press **▲** or **▼** to select "RANDOM PLAY" from the menu list and press **ENTER**.
The order of music tracks is randomly changed.
- 2 Press **PLAY**.
Music is played back in random order.

To cancel random playback, select "RANDOM PLAY" from the menu list again, and press **ENTER**.

Repeat playback of selected track

- 1 Press **▲** or **▼** to select the track number you want to repeat playback and press **▶**.
- 2 Press **▲** or **▼** to select "REPEAT TRACK" from the menu list and press **ENTER**.
- 3 Press **PLAY**.
The selected track will be played back repeatedly.

To cancel repeat track playback, select "REPEAT TRACK" from the menu list again, and press **ENTER**.

Repeat playback of all tracks

- 1 Press **▲** or **▼** to select "REPEAT ALL" from the menu list and press **ENTER**.
- 2 Press **PLAY**.
All tracks on CD will be played back repeatedly.

To cancel the repeat all playback, select "REPEAT ALL" from the menu list again, and press **ENTER**.

Playing back programs

You can specify the playback order yourself.

- 1 Press **▲** or **▼** to select "PROGRAM PLAYBACK" from the menu list and press **ENTER**.
- 2 Press **▲** or **▼** to select the track number that you want to change the order of and press **ENTER**.
The "▶" mark will appear at the right side of the track number.
- 3 Press **▲** or **▼** to select to the track number that you want to specify and press **ENTER**.
The track number that you select in step 2 moves to the position that you specified.
- 4 Repeat steps 2 and 3 to change the playback order.
- 5 Press **PLAY**.
The tracks will be played back in the changed order.

To cancel program playback, select "EXIT PROGRAM MODE" from the menu list and press **ENTER**.

Playing back track by specifying the time

- 1 Press **▲** or **▼** to select "TIME SEARCH" from the menu list during playback and press **ENTER**.
- 2 Press **▲/▼** or **◀/▶** to specify the elapsed time of the track (this will be the starting point of playback) and press **ENTER**.
Playback will start from the specified elapsed time.



MP3/WMA/JPEG/DivX® playback



MP3 and WMA files can be played back. You can also display JPEG/DivX® files on the TV screen and enjoy them. Some discs may not play due to the condition of the recording.

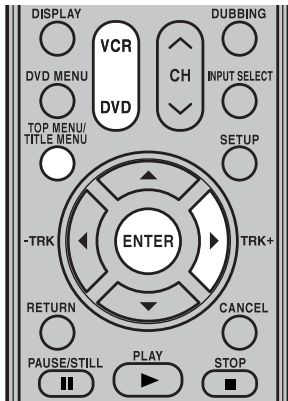

Preparation:

- Turn ON the TV and set to the video input mode.
- Load the disc storing MP3, WMA, JPEG or DivX®.
- Press **DVD** to select the DVD mode. (The DVD indicator will light.)

Using the BROWSER screen

- 1 Press **TITLE MENU**.
The BROWSER screen will appear.

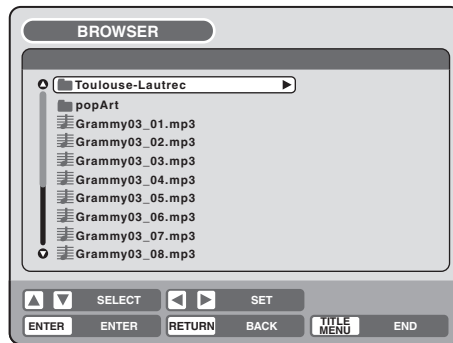

Disc playback

Limitations on MP3/WMA/JPEG/DivX® CD playback:

- MP3/WMA/JPEG/DivX® CD is a disc that is standardized by ISO9660.
- The folder and file names of the MP3/WMA/JPEG/DivX® CD must correspond to the ISO standardized file names.
- This unit can read 200 files per folder. If one folder has more than 200 files, it reads up to 200 files, the remaining files will be omitted.
- If the CD has both audio tracks and MP3/WMA/JPEG/DivX® files, only audio tracks are played.
- It may take more than one minute for this unit to read MP3/WMA/JPEG/DivX® files depending on its structure.
- Music recorded by "Joliet Recording Specification" can be played back. Long file names will be cut.
- The music files recorded by "Hierarchical File System" (HFS) cannot be played.
- The MP3/WMA/JPEG/DivX® files recorded on DVD disc cannot be playback.

- 2 The MP3, WMA, JPEG and DivX® files and folders stored in the disc are displayed on the BROWSER screen.
 - Select a folder and press **ENTER**. The files in the folder appear.

When the file to be displayed is selected

You can select the file types to be displayed on the BROWSER screen.

- 1 Press **▶** to select "SELECT FILES" and press **ENTER**.
The following list will appear.

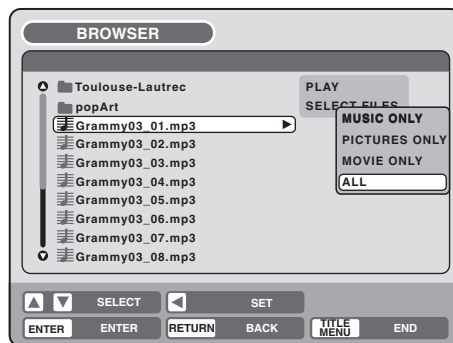

- MUSIC ONLY:** Only MP3 and WMA files appear.
- PICTURES ONLY:** Only JPEG files appear.
- MOVIE ONLY:** Only DivX® files appear.
- ALL:** All files and folders appear.

- 2 Select one item in the above list and press **ENTER**.
The display will be changed to the selected display type.

MP3/WMA/JPEG/DivX® playback

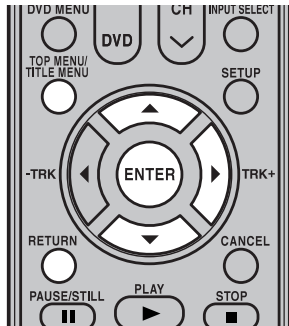

MP3 CD

- MP3 files must have the extension letters “.mp3”.
- Standard, sampling frequency, and the bit rate:
MPEG-1 Audio
32kHz, 44.1kHz, 48kHz
32kbps to 320kbps (constant bit rate or variable bit rate)
- The recommend recording setting for a high quality sound is 44.1kHz of sampling frequency and 128kbps of constant bit rate.

WMA CD

- When creating a WMA disc, make sure that the copyright function is off. DRM (Digital Rights Management) files cannot be played back.
- WMA files must have the extension letters “.wma”.
- Standard, sampling frequency, and the bit rate:
WMA version 7 and 8
32kHz, 48kbps
44.1kHz, 48kbps to 192kbps
48kHz, 128kbps to 192kbps
- Music files recorded as mono, 48kHz, 48kbps cannot be played back by this unit.

Playing back MP3/WMA files

- 1 Press ▲ or ▼ to select MP3 or WMA file.
 - In case the disc includes more than 10 files, you can turn to the next or the previous page. (See page 43.)

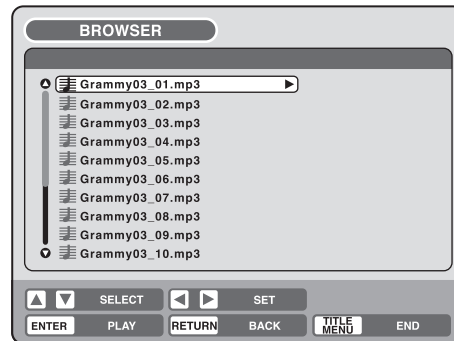

- 2 Carry out either of the item **a** or **b** below.
 - a: Press **ENTER**.
 - b: Press ► to select “PLAY” and press **ENTER**.
 The TRACK INFO screen appears to playback the selected file. For the details of the TRACK INFO screen, see “Various operations on CD” on page 43.

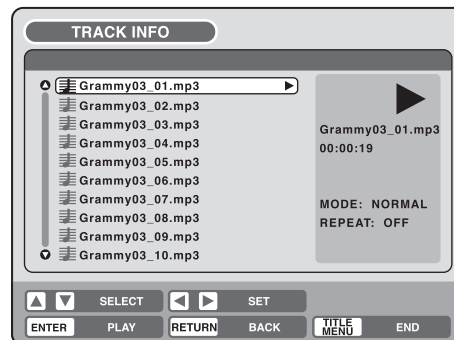

- 3 To return to the BROWSER screen, press **RETURN**.
 - To stop playback of the MP3 or WMA files, press **TITLE MENU**.

This DVD/VCR requires discs and recordings to meet certain technical standards in order to achieve optimal playback quality. Pre-recorded DVDs are automatically set to these standards. There are many different types of recordable disc formats (including CD-R containing MP3 or WMA files) and these require certain pre-existing conditions (see above) to ensure compatible playback. Because this area of technology is still evolving, Toshiba cannot guarantee that all recordable discs will produce optimal playback quality. The technical criteria set forth in this owner's manual are meant only as a guide.

Please be advised that you must obtain permission from the applicable copyright owners to download copyrighted content, including music files, in any format, including the MP3 and WMA formats, prior to the downloading thereof. Toshiba has no right to grant and does not grant permission to download any copyrighted content.

MP3/WMA/JPEG/DivX® playback

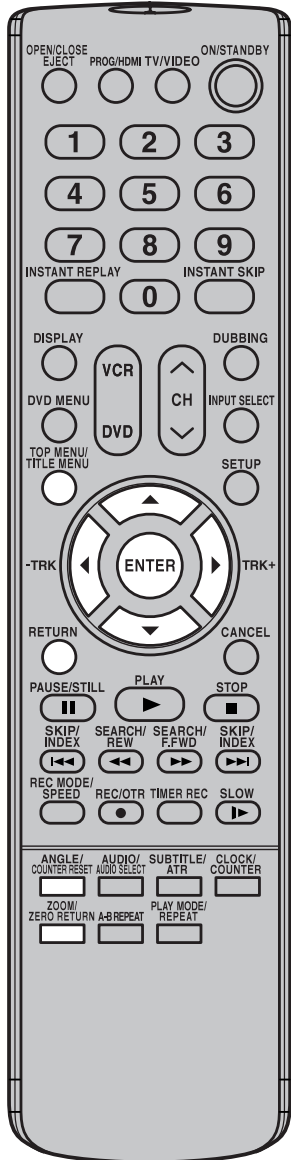

Playing back JPEG files

- 1 Press **▲** or **▼** to select JPEG file.
 - In case the disc includes more than 10 files, you can turn to the next or the previous page. (See page 43.)

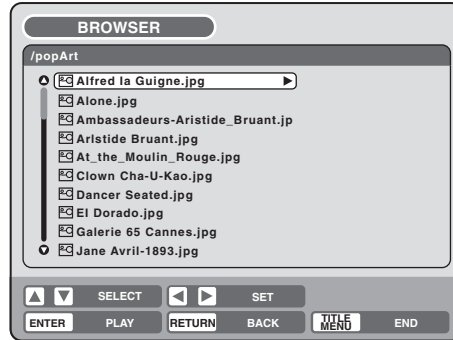

Disc playback

- 2 Carry out either of the item **a** or **b** below.
 - a: Press **ENTER**.
 - b: Press **▶** to select "PLAY" and press **ENTER**.

The thumbnail images of the JPEG files stored in the route directory or the folder appear.

Press **▲**, **▼**, **◀** or **▶** to select the pages of the thumbnail images, or select the JPEG file to be displayed at first for the slide show.

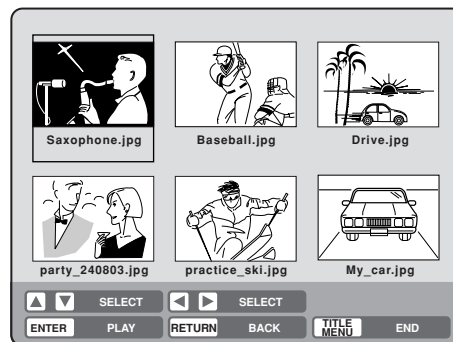

- 3 Press **ENTER** to play the selected picture.
 - If you have set the interval time for JPEG slide show, the pictures will be played back one after another automatically. (See page 33.)
 - Press **ZOOM** to enlarge the displayed image.
 - Press **ANGLE** to rotate the image by 90 degrees each time.

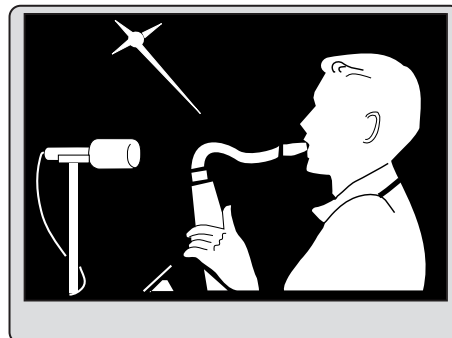

JPEG CD

JPEG files must have the extension letters ".jpe", ".jpeg" or ".jpg".

- 4 To return to the thumbnail screen, press **RETURN**.
 - To stop the slide show, press **TITLE MENU**.

MP3/WMA/JPEG/DivX[®] playback

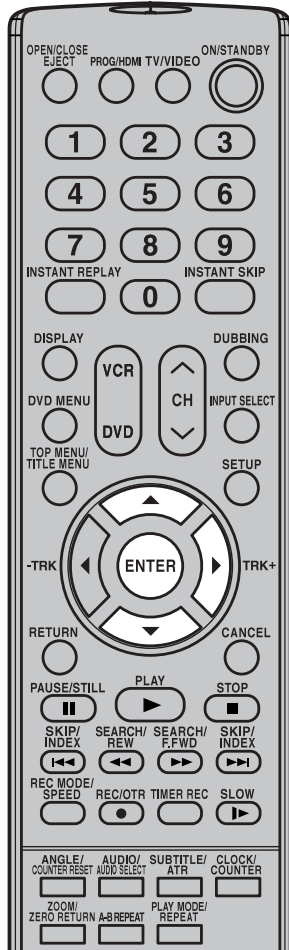

Playing back DivX[®] video files

- 1 Press **▲** or **▼** to select DivX[®] file.
 - If the disc includes more than 10 files, you can move to the next or previous page. (See page 43.)

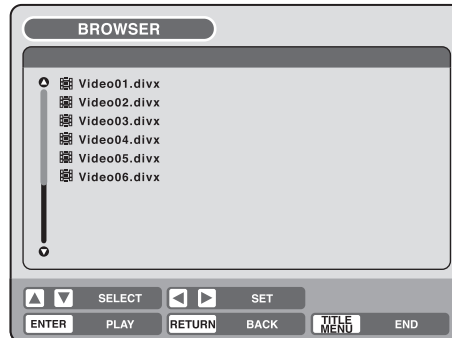

- 2 Carry out the item **a** or **b** listed below.
 - a: Press **ENTER**.
 - b: Press **▶** and then press **▲** or **▼** to select "PLAY" and press **ENTER**.
 The selected title is played back.
 - You can use Fast forward, Review, Still, Frame advance, SKIP **◀◀/▶▶**, and Slow motion playback (See page 37).

If the incorrect DRM file is loaded, "Authorization Error This player is not authorized to play this video." will appear on the screen. When you attempt to play DivX[®] VOD, the number of plays is limited and the following message will appear on the screen. If you wish to play it, select "YES".

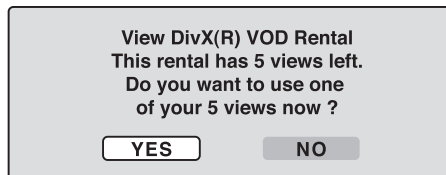

DivX[®] video specifications

- DivX[®] file must have the extension letters ".avi" ".div" or ".divx"
- DivX[®] version: DivX[®] 3, 4, 5, and 6 (specifically 3.1.1, 4.1.2, 5.0.2, 5.0.5, 5.1.1, 5.2.1, 6.0 at Home Theater profile).
Audio format:
MPEG1 Layer2 (MP2), MPEG1 Layer3(MP3)
Bit rate: 8kbps - 320kbps
Sampling frequencies: 32kHz, 44.1kHz, 48kHz
Resolution: Max 720 x 576 (at 25fps)
Max 720 x 480 (at 30fps)

NOTE:

It may take a while to start to play DivX[®] video. Please wait until picture appears on screen.

- If the number of plays goes over the limit, then "Rental Expired" will be displayed, in which case the file will not be played.

Loading and unloading a cassette tape



Use only video cassette tapes marked **VHS** and **S-VHS**.

SQPB

- Cassettes marked "VHS" (or "S-VHS") can be used with this video cassette recorder. However, S-VHS recording is not possible with this model.
- This model is equipped with SQPB (S-VHS QUASI PLAYBACK) that makes it possible to playback S-VHS recordings with regular VHS resolution.
- HQ VHS is compatible with existing VHS equipment.

Loading

Push the center of the tape until it is automatically inserted.



Insert the cassette tape with its labeled side facing up and the erase prevention tab positioned at your left. An inverted cassette tape cannot be inserted.

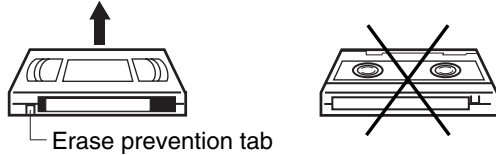

Tape playback

Automatic power ON

When you insert a cassette tape the VCR power will turn ON automatically.

Automatic playback

When loading a cassette tape without an erase prevention tab, playback will start automatically.

Unloading

You can eject the video tape while the unit is turned off.

1 Press **EJECT** on the unit or the remote control.



2 Remove the cassette tape.

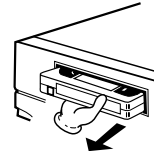

Automatic tape eject

This VCR will automatically rewind the tape when the tape has ended. And when the tape is rewound to its beginning, the cassette tape will be ejected automatically.

To prevent accidental erasure

Remove the erase prevention tab with a screwdriver.

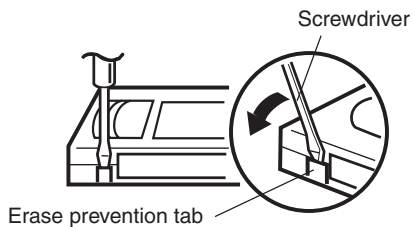

To record again

Cover the hole with a piece of adhesive tape.

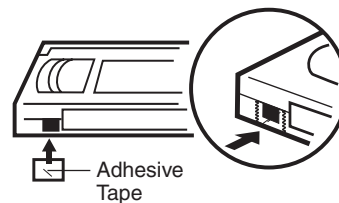

Tape speed and maximum recording time

Tape Speed	Video cassette tape				
	T-160	T-120	T-90	T-60	T-30
SP (Standard Play)	2-2/3 hours	2 hours	1-1/2 hours	1 hour	30 minutes
SLP (Super Long Play)	8 hours	6 hours	4-1/2 hours	3 hours	1-1/2 hours

Cassette tape playback

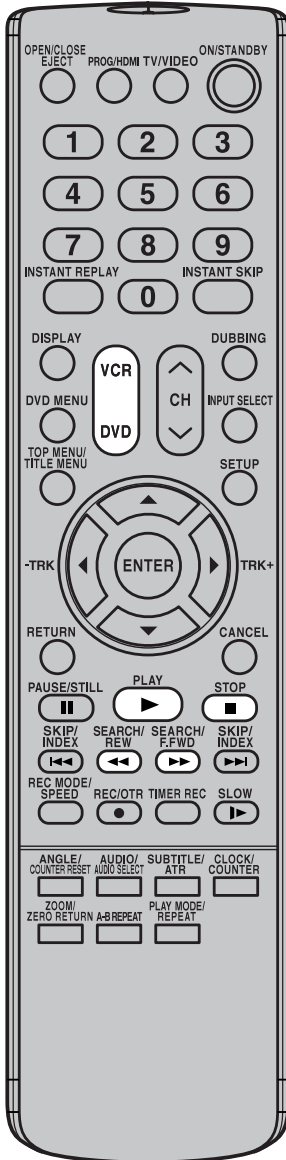

NOTES:

- This VCR selects the playback tape speed SP, LP or SLP automatically.
- It is impossible to switch to the VCR mode during DVD playback.

Preparation:

- Turn ON the TV and set to the video input mode.
- Press **VCR** to select the VCR mode. (The VCR indicator will light.)

- 1 Load a prerecorded tape
(When loading a cassette tape without the erase prevention tab, playback will start automatically).

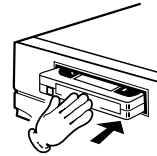

- 2 To start playback
Press **PLAY**.
Playback will start.
“▶” will appear on the screen for about 4 seconds.

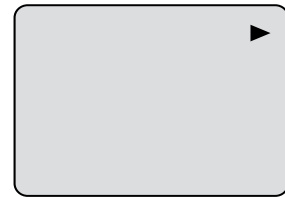

- To stop playback**
Press **STOP** once.
The tape will stop but remain fully loaded and ready to play.
“■” will appear on the screen for about 4 seconds.



- To rewind the tape or forward it rapidly**
Press **STOP**.

To rewind the tape:

Press **REW**.

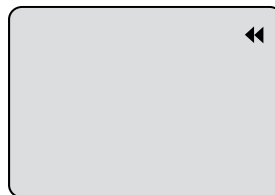

To forward the tape:

Press **F.FWD**.



To stop the tape-winding, press **STOP**. To switch to playback directly (without **STOP**), press **PLAY**.

Forward/Reverse picture search mode

When the tape is being wound, you can switch to picture search mode (see next page). To do this, press **REW** or **F.FWD** and hold it down. The unit will resume the tape winding as soon as the button is released.



Special playback



Picture search

Reverse picture search function
Press **REW** x 1 or x 2 during the playback.
Forward picture search function
Press **F.FWD** x 1 or x 2 during the playback.
To return to playback: Press **PLAY**.

SPEED SEARCH TIMES

TAPE SPEED	PICTURE SEARCH SPEED	
	PRESS ONCE	PRESS TWICE
SP (Standard Play)	3 X	5 X
LP (Long Play)	7 X	9 X
SLP (Super Long Play)	9 X	15 X

Still picture

Press **PAUSE** during playback.
To resume normal playback: Press **PLAY** or **PAUSE**.

Slow motion

During playback press **SLOW**.
To return to playback: Press **PLAY** or **SLOW**.

Slow tracking and vertical lock adjustment

If noise bars appear in the picture during slow motion, press the **TRK +** or **-** to reduce the noise bars. If the still picture jitters excessively, press **TRK +** or **-** to stabilize the still picture.

Frame by frame picture

Press **PAUSE** during playback.
Each time you press **SLOW**, the picture advances frame by frame.
To return to playback: Press **PLAY** or **PAUSE**.

Adjusting tracking condition

Automatic tracking adjustment

Whenever you insert a tape and start playback, automatic tracking starts working and continuously analyzes the signal to enable optimum picture quality during playback.

Manual tracking adjustment

If automatic tracking cannot eliminate noises well during playback, press **TRK +/-** to eliminate the noises. "MANUAL TR." will appear. Press it briefly for a fine adjustment, or press and hold for a coarse adjustment.

- Press **ATR** to reactivate automatic tracking again. "AUTO TR." will appear.

NOTES:

- The audio output is muted during SPEED SEARCH, STILL, FRAME ADVANCE and SLOW MOTION.
- During picture search mode there will be noise bars which are caused by the system.
- The Special Playback will automatically change to playback after approx. 5 minutes to protect the video tape against excessive wear.

Repeat playback

The entire video tape will be played until its end. The tape will then automatically rewind to the beginning and the playback will be repeated.

1 Press **REPEAT** while the VCR is playing back.

2 By pressing **REPEAT** each time, "REPEAT ON" or "REPEAT OFF" is selected in turn.

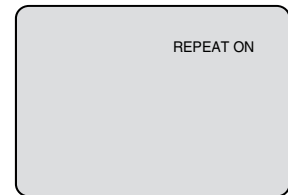

3 When "REPEAT ON" is selected, the tape is played back to the end, and then, it is automatically re-wound to the starting point and played back again. The display "REPEAT ON" goes out in about 3 seconds.

To cancel repeat playback: Press **REPEAT** to select "REPEAT OFF".

Tape playback

Instant skip

Press **INSTANT SKIP** during playback.
The video is rapidly forwarded for approx. 30 seconds and playback resumes.
You may press the button up to six times in a row to move 180 seconds ahead.

To display VCR operation status

Press **DISPLAY**. The clock, day of the week and more information will be indicated.

While watching TV

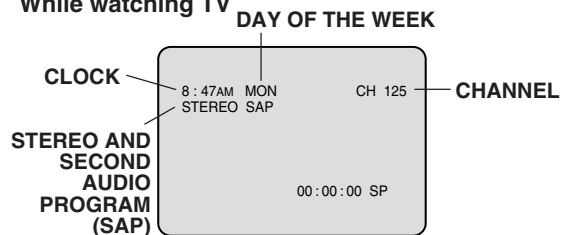

While operating a tape

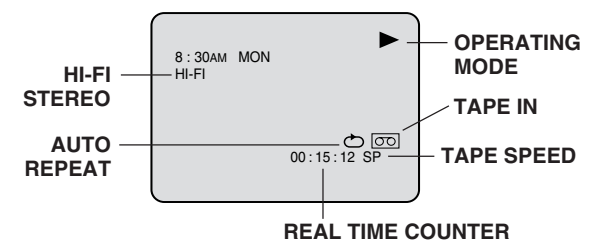

To cancel the display: Press **DISPLAY** until all indicators disappear.

ZERO RETURN function / Video index search system



ZERO RETURN function
This function makes tape rewinding stop at the counter "00:00:00" position automatically.

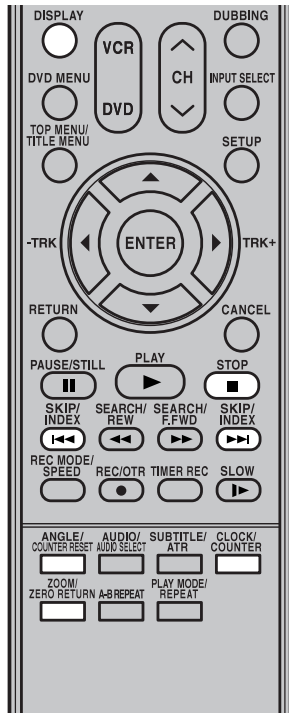

NOTES for Counter Display:

- If you rewind the tape beyond "00:00:00", a minus sign ("–") will be displayed in front of the time.
- When you load a tape, the counter will reset to "00:00:00".
- The counter does not function on nonrecorded (blank) sections of the tape. When you rewind, fast forward or play tapes through blank sections, the counter stops.

NOTES for Video index search system:

- When you record an INDEX mark at the very beginning of the tape, the mark may not be found.
- During INDEX search, the tape may stop and begin to play at a slightly different location.
- INDEX may not function properly with old or worn out video tapes.
- INDEX marks may not be found if it is extremely close to the point where the search began.
- In recording, if you stop recording temporarily, the INDEX mark is not recorded on the tape.

1 Press **DISPLAY**.
The counter display shows the tape running time during playback or recording.

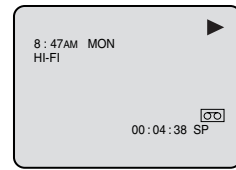

2 Press **COUNTER RESET** at the desired tape position. The counter display will be reset to the "00:00:00" position (e.g. the beginning of recording).

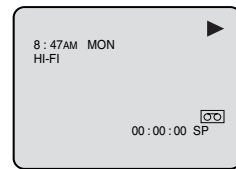

3 Press **STOP** when playback or recording is finished. Press **ZERO RETURN**. The tape will be rewound or fast forwarded and automatically stop at the "00:00:00" position.

Switching the display between clock and counter

Press **CLOCK/COUNTER**. The clock and tape counter alternate with each other in the display.

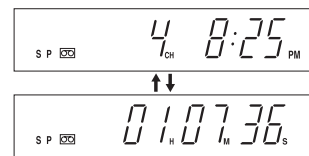

Video index search system

This function enables you to locate the beginning of any recording made on the VCR.

Recording an INDEX MARK

The Index search function automatically records an INDEX mark on the tape whenever a recording is initiated.

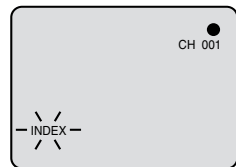

Index search

Press **INDEX** **▶▶** or **◀◀** during stop or play mode.

For Succeeding programs: Press **INDEX** **▶▶**.
For Preceding programs: Press **INDEX** **◀◀**.
(Additional press increases the INDEX NO. up to 9.)

When the **INDEX** **▶▶** or **◀◀** is pressed, the unit starts searching the INDEX NO. selected and finds the portion, then playback starts automatically.

To stop the Index Search, press **STOP**.



▶▶ or ◀◀ is displayed

INDEX NO. (up to 9)

Read this before recording on disc

This section explains what you must know to record onto a disc. Read it before attempting to record.

NOTE:

Should a power failure occur or the AC cord plug be disconnected while recording, editing, initializing, finalizing or any other function, the program being recorded will be lost or the disc may not be playable. Manufacturer cannot guarantee against loss of program or disc should this occur. To start recording again, re-format the disc or use a new disc and follow the instruction on recording.

NOTES:

Recording time can change for the following reasons.

- When image quality is poor as during poor TV reception.
- When recording on a disc that has been edited before.
- When the video is followed with recordings of still images or just audio.

NOTE:

Because of characteristics peculiar to digital video compression technology, scenes with fast motion may appear as a matrix of larger blocks.

The unauthorized recording, use, distribution, or revision of television programs, videotapes, DVDs and other materials, is prohibited under the Copyright Laws of the United States and other countries, and may subject you to civil and/or criminal liability.

Types of disc

You can use DVD-RAM, DVD-RW and DVD-R discs to record video.

DVD-RAM/-RW (VR mode)

- This mode involves multiple editing functions.
- Various editing options using a created Playlist.

DVD-RW/-R (Video mode)

- Simple editing (renaming titles).

For more information on recording format, see “Recording format” (page 10).

Recording modes

There are 4 modes for recording on disc. Recording time and quality vary according to mode.

Recording mode	Recording time	Quality
XP	Approx. 60 min	Can record high quality images.
SP	Approx. 120 min	Can record normal quality images.
LP	Approx. 240 min	Quality deteriorates slightly, but recording time is longer.
SLP	Approx. 360 min	Recording time is prioritized over quality.

- Recording time above is based on a 4.7GB disc.

Since DVD recording is performed using VBR (Variable Bit Rate), recording time varies according to the recorded content.

To know the correct recording time, stop recording and check the media information. (See page 36.)

Disc remaining time

VR mode

- Recording is possible as long as there is available space on the disc. (Finalized discs can be recorded by cancelling the finalization, see “UNDO FINALIZE” on page 29.)
- Erasing unnecessary title frees up available space on the disc. (Titles can be erased from finalized discs by first undoing the finalization. See “UNDO FINALIZE” on page 29.)

Video mode

- Up until the disc is finalized, recording is possible as long as there is available space on the disc. (Once the disc has been finalized, additional recording and erasing are not possible.)
- The remaining time cannot be increased, nor can recorded title be overwritten.
- Titles cannot be erased nor can recorded titles be overwritten.

Read this before recording on disc

The unauthorized recording, use, distribution, or revision of television programs, videotapes, DVDs and other materials, is prohibited under the Copyright Laws of the United States and other countries, and may subject you to civil and/or criminal liability.

Images that cannot be recorded

Some DVD-Video and broadcasts contain copy-restriction signals to protect copyrights. There are 3 types of copy-restriction signals: "Copy Free", "Copy Never" and "Copy Once".

"Copy Free" (unrestricted recording)

Land-based TV broadcasts and images you record yourself with a video camera allow unrestricted recording. There are no restrictions on re-recording.

"Copy Never" (recording prohibited)

- Images that contain the recording prohibited signal cannot be recorded.
- If the recording prohibited signal appears halfway through an image you are recording, recording is paused at that instant. When the recording prohibited signal ends, recording resumes.
- This unit incorporates a built-in copy guard. It cannot record software or broadcasted programs that contain copy restriction signals designed to protect copyright, etc.

"Copy Once" (one-time recordable)

Programs (images) that contain the one-time recordable signal can be recorded only in the VR mode using a DVD-RW disc that supports CPRM Ver. 1.1 and Ver 1.2.



Recording a TV program



You can record programs you watch on TV onto video tapes or DVDs.

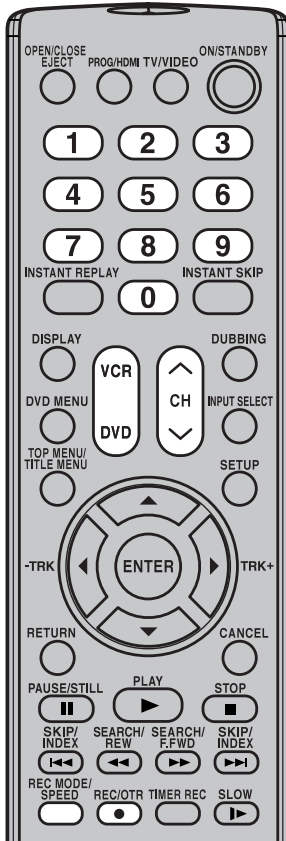

Preparation:

- Turn ON the TV and set it to the video input mode.
- Load a recordable DVD or video tape into the unit.
- Press **DVD** or **VCR** to select the appropriate mode.

1 Press **REC MODE/SPEED** to select the recording mode.

The recording mode will appear on the TV monitor and change every time **REC MODE/SPEED** is pressed.

VCR recording modes: SP/SLP

DVD recording modes: XP/SP/LP/SLP

VCR mode

00:00:00 SP

DVD mode

SP

SP is the normal recording mode for video tapes. SLP offers 3 times the recording time as SP. For more information on DVD recording modes, see page 53.

2 Set the TV/CABLE option to the appropriate position (page 33).

TV - VHF/UHF channels
CABLE - CABLE TV channels

3 Press the **numeric keys** or **CH ^/v** to select the channel to be recorded.

TO SELECT Cable TV CHANNELS:

1-9 Press **0** twice and then **1-9** as required.

Example: To select 2, Press "**002**".

10-12 Press **0** first and then the remaining 2 digits in order from left to right.

Example: Press **012** for "12".

13-99 Press 2 digits in order.

Example: Press **22** for "22".

100-125 Press the 3 digits in order.

Example: Press **110** for "110".

CH 110

TO SELECT TV CHANNELS 1-12:

If only 1 or 2 buttons are pressed, the corresponding channel will be selected in 2 seconds.

VHF/UHF/CABLE CHANNELS

TV	CABLE
VHF	VHF
2-13	2-13
UHF	STD/HRC/IRC
14-69	14-36 (A) (W)
	37-59 (AA) (WW)
	60-85 (AAA) (ZZZ)
	86-94 (86) (94)
	95-99 (A-5) (A-1)
	100-125 (100)(125)
	01 (5A)

4 Press **REC/OTR**.

"●" appears on the screen for about 4 seconds and recording will start.

VCR mode

CH 110

DVD mode

NOTES:

- When recording onto a DVD, it takes some time from when you press **REC/OTR** until recording actually starts.

Press **REC/OTR** slightly earlier before the preferred starting point. With a video tape, recording starts almost at the same time as you press **REC/OTR**.

- If the erase prevention tab of video tapes is removed, the tape will eject when **REC/OTR** is pressed for recording.

The unauthorized recording, use, distribution, or revision of television programs, videotapes, DVDs and other materials, is prohibited under the Copyright Laws of the United States and other countries, and may subject you to civil and/or criminal liability.

Recording a TV program

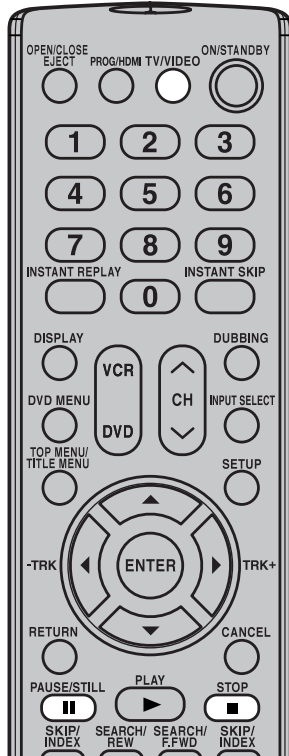

Auto Rewind feature

This VCR will automatically rewind the tape when the tape has ended (except during OTR and TIMER REC). It will also eject the tape.

NOTES:

- If the disc space become full, the recording is stopped and "Disc is full" will appear on the screen.
- In the event of a power failure during DVD recording including OTR and TIMER REC, the program can not be recorded on the disc.
When the power resumes, after the VCR/DVD is turned on, the set checks the disc to repair the error which is caused by a power failure. This checking process may require a few minutes to about 1 hour according to disc condition. In this process "SYSTEM ERROR PLEASE WAIT DISC CHECKING" will appear on the screen.

The unauthorized recording, use, distribution, or revision of television programs, videotapes, DVDs and other materials, is prohibited under the Copyright Laws of the United States and other countries, and may subject you to civil and/or criminal liability.

To stop recording

Press **STOP** to stop recording.
"■" will appear on the screen for about 4 seconds.



NOTE:

When recording onto a DVD, even if **STOP** is pressed during recording, recording does not stop instantly. Recording may continue for as long as 1 minute maximum.

To stop recording temporarily

Press **PAUSE/STILL** to avoid recording unwanted material.
"●||" will appear on screen for about 4 seconds.
Press again to resume recording.

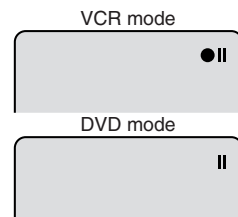

NOTES:

- In video recording, the pause function will be released after 5 minutes to prevent damaging the video tape. The unit will change to the STOP mode.
- When recording onto a video tape, you can select a recording channel in the recording pause mode. (You cannot change a recording channel in the DVD recording pause mode.)

Recording one program while watching another

While the unit is recording, press **TV/VIDEO** to select the TV position. The "TV" will light up on the display window and recording will continue. Select the TV channel you want to watch by using the TV channel selector.

NOTE:

Some CABLE hookups do not permit viewing one channel while recording another. See pages 18, 19.

One-touch Timer Recording (OTR)



The One-touch Timer Recording feature provides a simple and convenient way to make a timed recording.

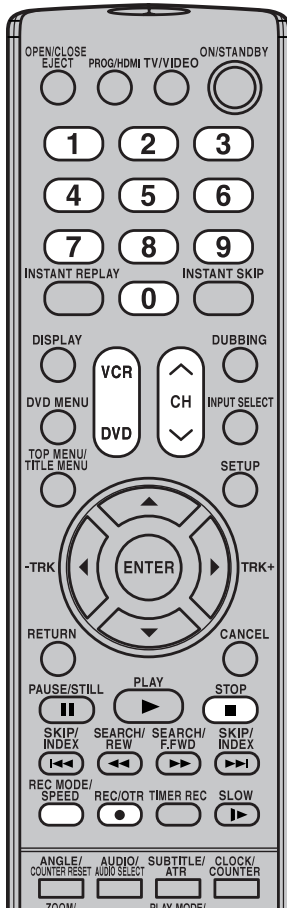

NOTE:

If you wish to watch the DVD playback during the VCR OTR, press **DVD** to change to DVD mode and perform the DVD playback. You can also playback the VCR during DVD OTR.

The unauthorized recording, use, distribution, or revision of television programs, videotapes, DVDs and other materials, is prohibited under the Copyright Laws of the United States and other countries, and may subject you to civil and/or criminal liability.

Preparation:

- Turn ON the TV and set to the video input mode.
- Load a recordable DVD or video tape into the unit.
- Press **DVD** or **VCR** to select the appropriate mode.

Example: One-touch Timer Recording for 30 minutes.

- 1 Press **REC MODE/SPEED** to select the recording mode.
For the recording mode, see step 1 on page 55.

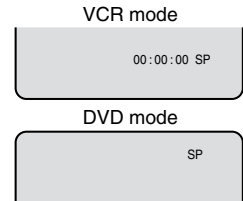

- 2 Set the TV/CABLE option to the appropriate position (See page 33).

TV - VHF/UHF channels
CABLE - CABLE TV channels

- 3 Press **numeric keys** or **CH** ^/∇ to select the channel to be recorded.

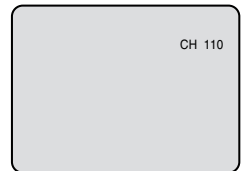

Recording

- 4 Press **REC/OTR**. Each additional press of **REC/OTR** will increase recording time as shown in the chart below, up to a maximum of 6 hours. The OTR and recording time will appear on the screen for about 4 seconds.

Press	Recording time	Press	Recording time
once	NORMAL REC	7 times	OTR 3:00
twice	OTR - : - -	8 times	OTR 4:00
3 times	OTR 0:30	9 times	OTR 5:00
4 times	OTR 1:00	10 times	OTR 6:00
5 times	OTR 1:30	11 times	NORMAL REC
6 times	OTR 2:00		

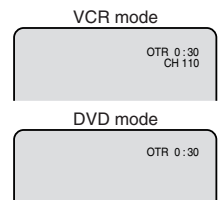

To cancel OTR

Press **STOP** or turn off the power.
“■” will appear on screen for about 4 seconds.



Timer recording



The timer recording system allows you to select the date, time and channel and record the desired programs. Up to 12 timer programs within a month can be stored in this unit.

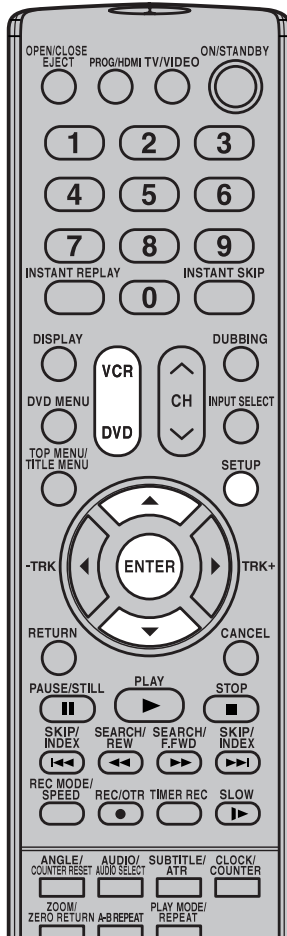

NOTE:

If a recordable tape is not inserted or no disc space is available, the timer record indicator "□" flashes. Replace the tape or disc to allow recording.

The unauthorized recording, use, distribution, or revision of television programs, videotapes, DVDs and other materials, is prohibited under the Copyright Laws of the United States and other countries, and may subject you to civil and/or criminal liability.

Setting timer recording

Preparation:

- Turn ON the TV and set to the video input mode.
- Load a recordable DVD or video tape.
- Press **DVD** or **VCR** to select the appropriate mode.
- Confirm that the clock is indicating the correct time.

Example: Set the recording mode to LP; the TV program is on channel 12 starting at 8:00 PM and stopping at 9:30 PM on a date of 20th.

- 1 Press **SETUP**.
The **SETUP MENU** screen appears.

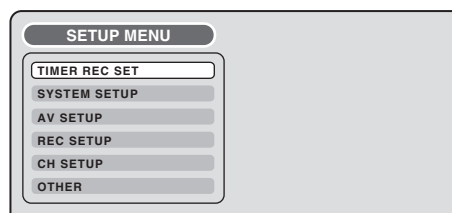

- 2 Press **▲** or **▼** to select "TIMER REC SET" and press **ENTER**.
The **TIMER REC SET** screen will appear.

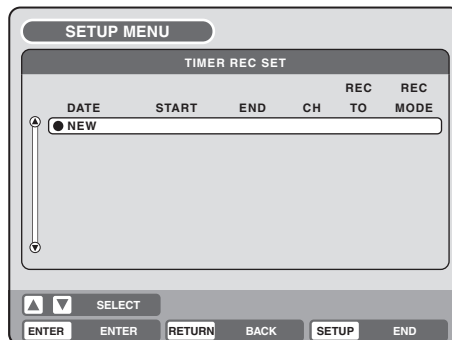

- 3 Press **▲** or **▼** to select "NEW" and press **ENTER**.
The program screen will appear.

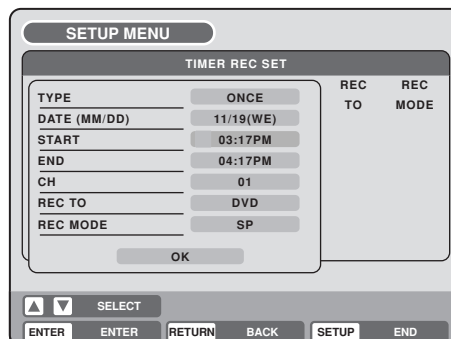

Timer recording

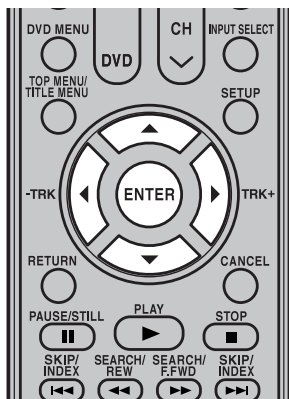

NOTES:

- If you select timer recording on a specified date only one time, select "ONCE" in the "TYPE" for recording. You can record same days of every week or from Monday to Friday using the item "TYPE". The items you can select are as follows:
ONCE: Recording on the selected "DATE"

EVERY SUN: Recording every Sun.

EVERY MON: Recording every Mon.

EVERY TUE: Recording every Tue.

EVERY WED: Recording every Wed.

EVERY THU: Recording every Thu.

EVERY FRI: Recording every Fri.

EVERY SAT: Recording every Sat.

MON-FRI: Recording from Mon. to Fri.

MON-SAT: Recording from Mon. to Sat.

EVERYDAY: Recording everyday.

- The starting and stopping times for the recording are displayed on the 12-hour (am/pm) clock. Twelve o'clock midnight is displayed as "12:00AM", whereas twelve o'clock noon is displayed as "12:00PM".
- The initial setting of "REC TO" and "REC MODE" can be changed using "Setting the recording". (See page 32.)

The unauthorized recording, use, distribution, or revision of television programs, videotapes, DVDs and other materials, is prohibited under the Copyright Laws of the United States and other countries, and may subject you to civil and/or criminal liability.

- Press **▲** or **▼** to select "TYPE" and press **ENTER**. Press **▲** or **▼** to select "ONCE" from the list and press **ENTER**.

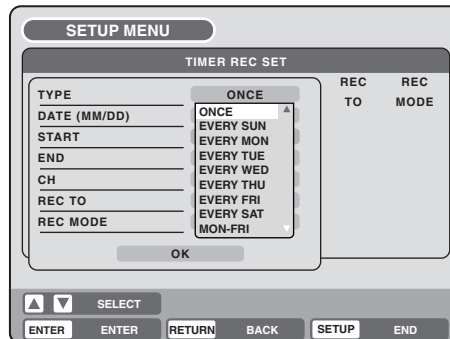

- Press **▲** or **▼** to select "DATE" and press **ENTER**. Press **▲** or **▼** to select the date to be recorded from the list and press **ENTER**.

- Press **▲** or **▼** to select "START" and press **ENTER**. Set the recording start time.

- To switch over the selection item (hour or minute), press **◀** or **▶**, then press **ENTER**.
- Press **▲** or **▼** to adjust the time.
- After setting the time, press **ENTER**.

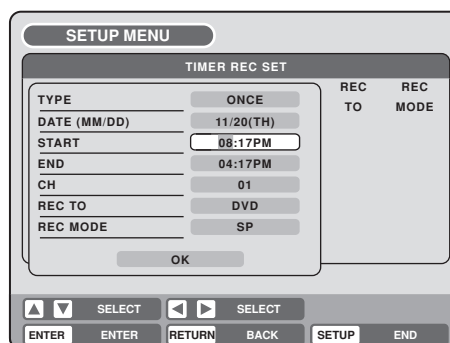

- Press **▲** or **▼** to select "END" and press **ENTER**. Set the recording end time and time in the same manner as in step 6.

- Press **▲** or **▼** to select "CH" and press **ENTER**.
 - Press **▲** or **▼** to select the channel to be recorded.
 - You can select the external input (L1 or L2) by pressing **◀** or **▶**.

- Press **▲** or **▼** to select "REC TO" and press **ENTER**. Select the media (DVD or VCR) to be recorded from the list and press **ENTER**.

- Press **▲** or **▼** to select "REC MODE" and press **ENTER**. The recording modes for the media selected in "REC TO" item are listed up. Select the recording mode and press **ENTER**. For the recording modes in VCR, see page 49. For the recording modes in DVD, see page 53.

Recording

Timer recording

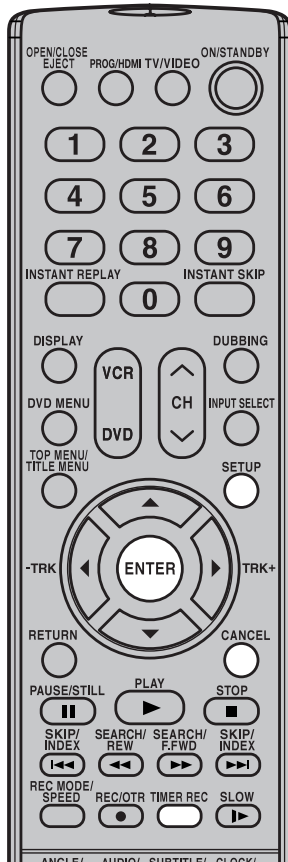

NOTES:

- Recording starts a few seconds before the preset starting time.
- You cannot use the timer recording for the both DVD and VCR at the same time.
- You can playback the DVD during the VCR timer recording, and you can playback the VCR during the DVD timer recording.
- The timer recording program is stopped during timer recording, the stopped program is not erased from the timer recording list. In this case, please cancel the program, otherwise the stopped program will be activated if the unit returns to timer recording standby mode.

The unauthorized recording, use, distribution, or revision of television programs, videotapes, DVDs and other materials, is prohibited under the Copyright Laws of the United States and other countries, and may subject you to civil and/or criminal liability.

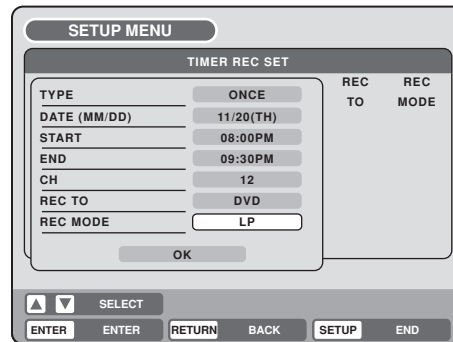

- Select "OK" and press **ENTER**. The timer program is determined and the **TIMER REC SET** screen appears again.
- When you enter the other program for the timer recording, repeat the steps **3** to **11**.
- Press **SETUP**. The **TIMER REC SET** screen disappears and the display will return to the normal screen.
- Press **TIMER REC**. The timer indicator "□" will appear on the display and the unit stands by for recording.

Stopping the timer recording

After the timer recording has started, you can cancel the timer recording (but continue recording), or stop recording completely if you want. To cancel the timer recording, press and hold **TIMER REC** for more than 2 seconds. The timer indicator "□" disappears from the display and recording continues. Press **STOP** to stop recording completely.

Checking or changing the timer recording

When you want to check the selected timer recording, follow the steps **1** and **2** of "Setting timer recording" and display the **TIMER REC SET** screen. To change the timer recording, select the program to be changed and press **ENTER**. The changing method is the same as that for the recording a program for the first time.

Cancelling the timer recording

Display the **TIMER REC SET** screen. Select the program you want to cancel and press **CANCEL**, then the selected program will be erased from the timer recording list.

In case Timer programs-overlap

Do not overlap timer programs as portions of the conflicting programs will be lost. The first recording time has priority over the next recording time as shown in the diagram below.

In this case, the next recording time is delayed a maximum of about 1 minute.

If you set up many timer recording programs at the same start time, the priority will be the top program in the timer recording list.

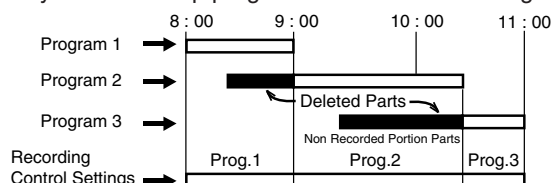



Chase Playback



You can begin playback from the beginning of a program currently being recorded. You will find this function of great advantage on long programs, as you do not have to wait for the end of recording to begin playback.

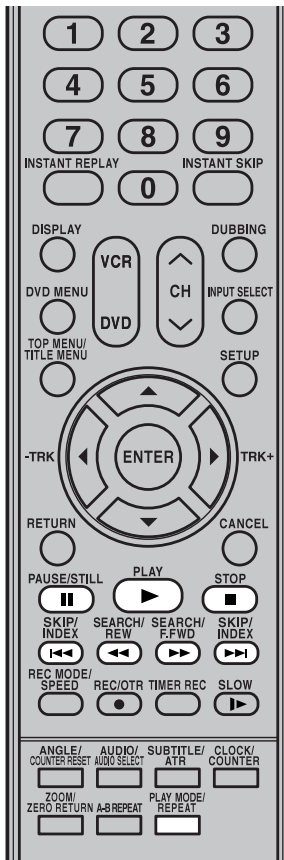

- 1 While recording a TV program onto the DVD-RAM disc, press **PLAY** to start chase playback. The TV program as it is being recorded will played back.
- 2 Locate a scene you want through the following operations if necessary.

Still playback:

Press **PAUSE**.

- To resume chase playback, press **PLAY**.

Fast forward/Review playback:

Press **SEARCH** **◀/▶**. Every press **SEARCH**, it switches the speed of the search.

- To resume chase playback, press **PLAY**.
- If the playback position catches up to within about 60 seconds, chase playback resumes. It may differ depending on the recording condition and search speed.

Locating a chapter:

Press **SKIP** **◀/▶** to locate a chapter that you want to watch.

- If you press **SKIP** **▶▶** while playing back the newest chapter, it starts playing back from about 15 seconds before the recording position.

Locating a specific scene:

Press **PLAY MODE** enables you to do a Time Search or a Chapter Search. (See page 38.)

- 3 Press **STOP** to end chase playback. If you press **STOP** again, the recording stops.

Recording

NOTES:

- Chase playback is not available when recording a DVD-RW/R disc and video tape.
- Chase playback is not available when recording in XP mode.
- Slow, Instant skip, Instant replay, A-B repeat, and Frame advance will not work during chase playback.
- Chase playback does not work until 30 seconds of recording have elapsed.
- If you press **DISPLAY** during chase playback, the information screen is displayed (see page 36).

Stereo recording and playback

The VHS Hi-Fi audio system permits high fidelity recording of MTS STEREO TV broadcasts.

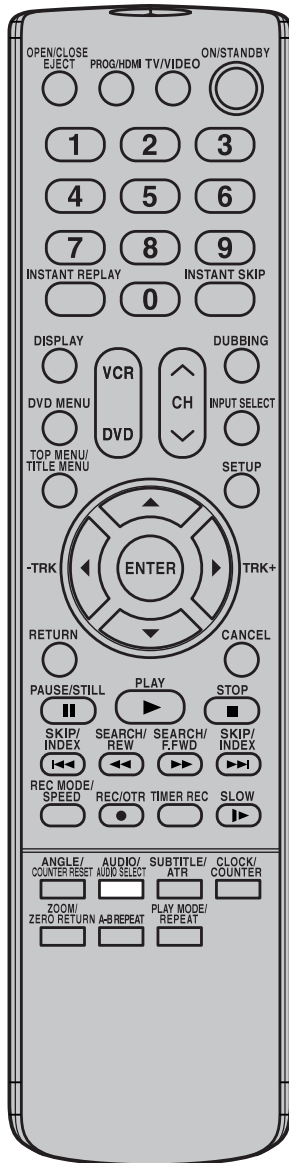

When a MTS STEREO broadcast is received, the word "STEREO" will appear on the screen and the program can be viewed or recorded in stereo.

The Hi-Fi STEREO recording procedure is the same as for normal recordings.

STEREO

NOTE:

When using a Cable TV system, stereo TV programs may be transmitted over a mono cable channel. In this case the word "STEREO" will not appear and the sound will be in mono.

Output selection

When viewing an MTS STEREO TV program, or playing a prerecorded Hi-Fi STEREO on video tape, press **AUDIO SELECT** to select how the audio will be heard through the speakers. Normally set to the Hi-Fi STEREO position, this button can be set to the MONO position if the stereo audio is of poor quality. The "R" and "L" positions allow the audio from the Right or Left Hi-Fi channel to be heard over both TV speakers. This button has no effect when viewing a monaural audio program. Each time when you press the button, output selection display appears on the screen for several seconds. Refer to the chart below.

OUTPUT SELECTION	SOUND HEARD ON BOTH SPEAKERS
STEREO	STEREO
L ch	LEFT CHANNEL AUDIO
R ch	RIGHT CHANNEL AUDIO
MONO	MONO

Output selection for DVD

You can switch between the left or right channel and stereo only when playing a disc on which a bilingual broadcast was recorded in the DVD-RW VR mode. It is not possible to switch between channels otherwise as only the channel selected in the setting of SAP (Second Audio Program; ON or OFF) is recorded in the DVD-RW Video mode or DVD-R (see page 32).

NOTE:

When a stereo or monaural broadcast is recorded, either stereo or monaural, respectively, is played back and it is not possible to switch between channels.

NOTES:

- When playing back a video tape or disc that is not recorded in Hi-Fi stereo mode, the audio will automatically be monaural.
- When listening to a Hi-Fi video tape, disc or MTS broadcast through the RF OUT (UHF/VHF) jack (Audio/Video cord not connected), the sound will be monaural.

Editing the disc

This section explains how to edit the recorded contents on DVD-RWs. However, the items that you can edit vary with the recording formats. In VR mode, you can edit various title menus, whereas in Video mode, you can edit only a few items.

Title menu

When the content is recorded, a title name that includes the date, time, channel number and other information is created automatically. The title menu can be used when you playback after confirming the contents (see page 35), or when you check the contents recorded on the disc.

Original title

The titles explained above are called original titles; these will be added with every recording. In VR mode you can do various editing operations i.e., you can rename the titles or add the chapter marks. In addition, you can erase the unnecessary titles to increase the disc space.

Playlist

You can create a playlist based on the original titles. You can combine or erase undesired scenes.

If you create a playlist, it will become the primary list used by the disc. If you create a playlist to customize your viewing preferences, and choose to delete it, the original titles will not be affected. It is recommended to create and edit the playlist to prevent important titles from being erased accidentally.

If you create a playlist, both the original title and playlist will be displayed on the title menu.

Editable items

The items that can be edited are different between original title and playlist. For the disc in Video mode, only the title name can be edited. The items can be edited in each are as follows:

Editing items	VR mode		Video mode
	Original	Playlist	Original
Playback	Y	Y	Y
Adding chapter mark	Y	N	N
Combining chapters	Y	N	N
Erasing scenes	Y	Y	N
Erasing titles	Y	Y	N
Renaming titles	Y	Y	Y
Creating playlist	Y	N	N
Combining titles	N	Y	N

If you finalize the disc in Video mode, the title menu is automatically changed. Thumbnail image and recording information will not appear in the title menu after finalizing.

Using these editing functions to modify copyrighted content for any purpose other than your private viewing may be prohibited under the Copyright Laws of the United States and other countries, and may subject you to civil and criminal liability.

NOTES:

- This unit cannot record or edit a disc which was recorded or edited using another DVD recorder.
- You cannot edit or record the disc on which disc protection is set. In such a case, be sure to cancel the disc protection before starting the operation.
- When a scene has been erased, the selected position for erasing may vary slightly from the actual erased position.

Editing a playlist

You can create and edit the playlist based on the original title.

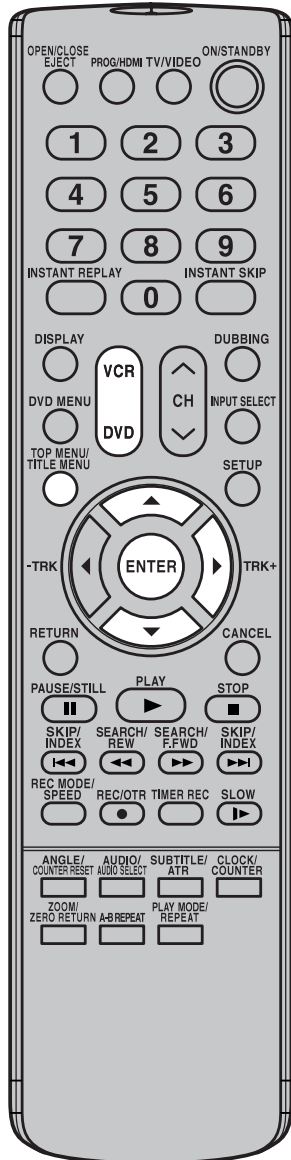

NOTES:

- A playlist can only be created with a DVD-RAM or a DVD-RW in VR mode. You cannot create a playlist with a DVD-RW in Video mode, nor with a DVD-R.
- In case the disc includes more than 9 titles, you can turn to the next or the previous page. (See page 35.)

Preparation:

- Turn ON the TV and set to the video input mode.
- Load the recorded DVD-RAM/RW (VR).
- Press DVD to select the DVD mode. (The DVD indicator will light.)

Creating a playlist



- 1 Press **TITLE MENU**.
The title menu will appear.

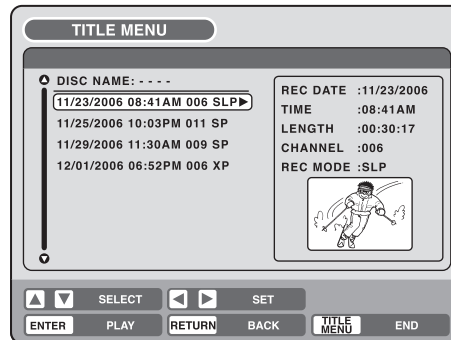

- 2 Press ▲ or ▼ to select the original title which will be used as the base of a playlist.
- 3 Press ▶.
The editing menu of original title will appear.
- 4 Press ▲ or ▼ to select "NEW PLAYLIST".

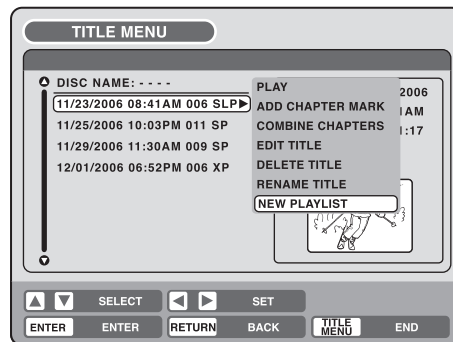

- 5 Press **ENTER**.
The editing menu closes and the created playlist appears at the bottom of the list.

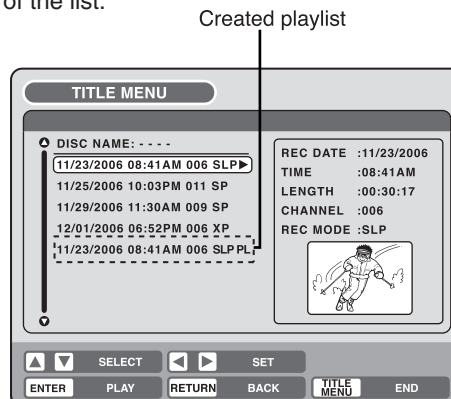

Editing a playlist

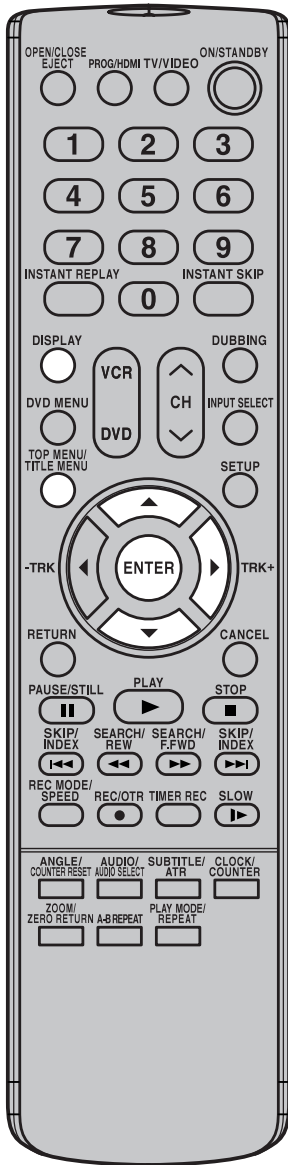

Changing a title name



- 1 Press **TITLE MENU** to display the title menu.
- 2 Select the playlist where you want to change the title name.
 - Press **▲** or **▼** to select the playlist.
 - Press **▶** to display the editing menu of the playlist.
 - Press **▲** or **▼** to select "RENAME TITLE".

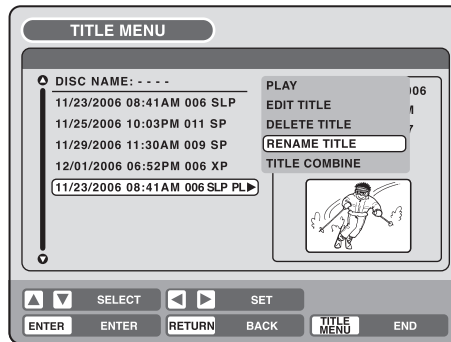

- 3 Press **ENTER**.
The keyboard screen will appear.

- 4 Use the keyboard screen to enter the title name.

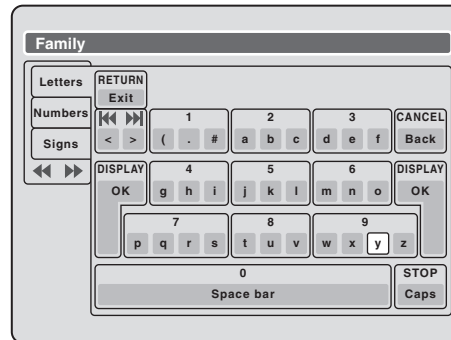

- 5 Press **DISPLAY** to return to the title menu.

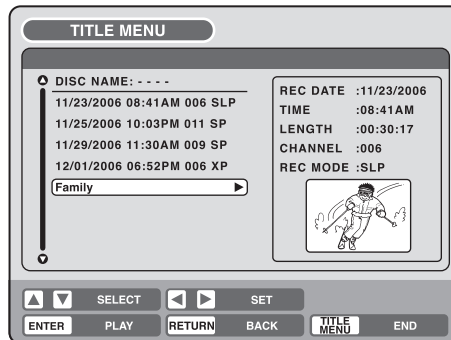

NOTES:

- The title name can be a maximum of 64 characters. Long names will be shortened in the title menu.
- For using the keyboard screen, see "Changing a disc name" (page 76).

Editing the disc

Editing a playlist

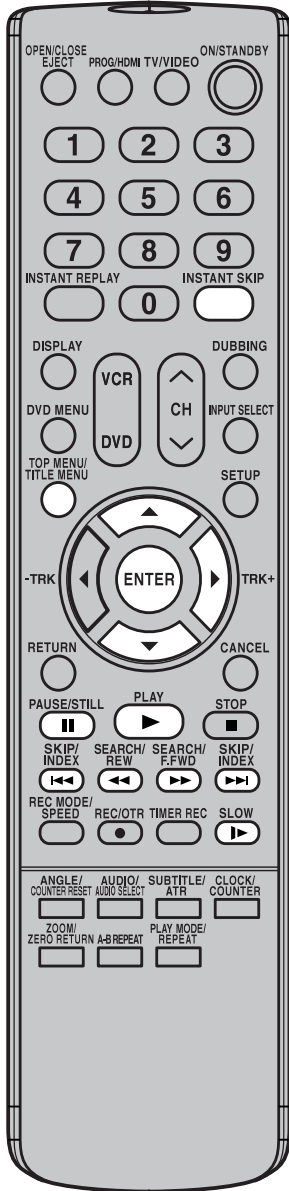

Erasing a scene (Edit title)



You can erase an unnecessary scene from the created playlist. When you erase the scene from the playlist, the scene is not erased from the original title.

- 1 Press **TITLE MENU** to display the title menu.
- 2 Select the playlist where a scene you want to erase is included.
 - Press **▲** or **▼** to select the playlist.
 - Press **▶** to display the editing menu of the playlist.
 - Press **▲** or **▼** to select "EDIT TITLE".

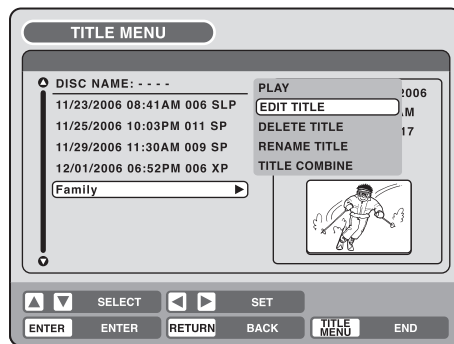

- 3 Press **ENTER**.
The EDIT TITLE screen will appear.

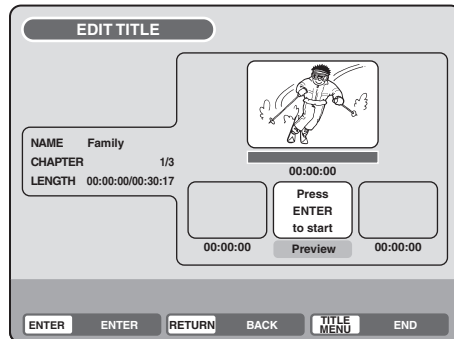

- 4 Press **ENTER** to playback the playlist on the EDIT TITLE screen.
 - Use each operation button (**F.FWD**, **REW**, **SKIP▶▶**, **SKIP◀◀**, **PLAY**, **PAUSE/STILL**, **SLOW**, **INSTANT SKIP**) for the playback to search the starting point of the scene you want to erase.

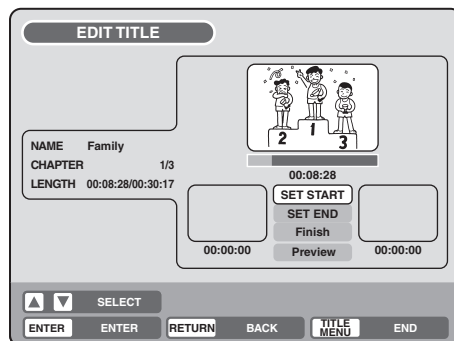

Editing a playlist

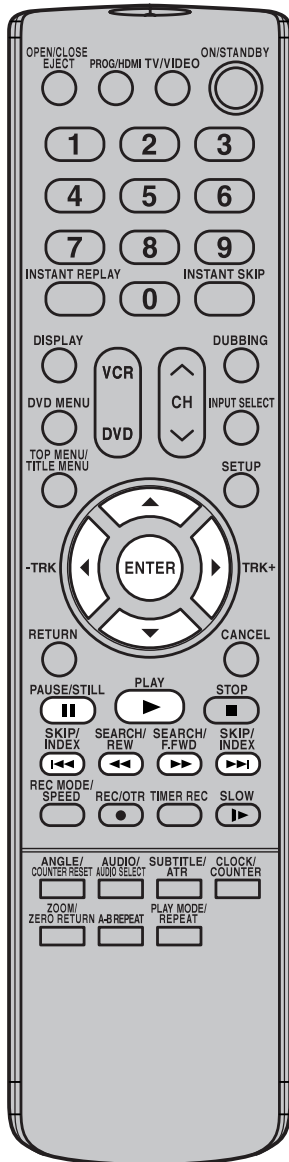

NOTE:

It is no problem to omit the procedures for confirming the scene or adjusting start and end points.

- Press **▲** or **▼** to select "SET START" at the start point of the scene that you want to erase and press **ENTER**. (To set the start point easily, search the start point while "SET START" is selected) The still image at the start point appears at the left small screen.

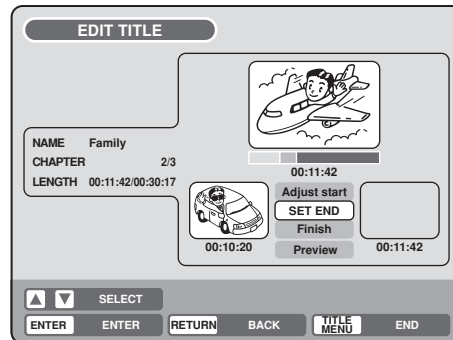

- Press **▲** or **▼** to select "SET END" at the end point of the scene you want to erase and press **ENTER**. The still image at the end point appears at the right small screen.

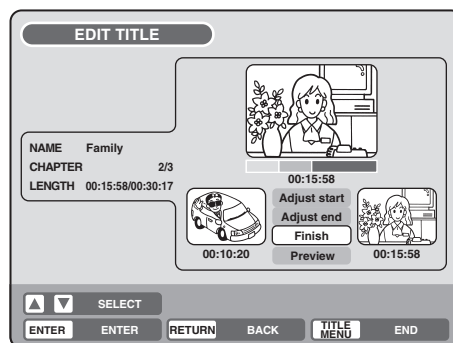

- Check the erased scenes.
 - Select "Preview" and press **ENTER**. Then the video where the scenes between the start and end points are erased is played back.
 - Each operation button (**F.FWD**, **REW**, **SKIP▶▶**, **SKIP◀◀**, **PLAY**, **PAUSE/STILL**) for playback also can be used.
- Adjust the start and end points.
 - To adjust the start point, select "Adjust start" and press **ENTER**. You can change the start point by pressing **◀** or **▶**.
 - To adjust the end point, select "Adjust end" and press **ENTER**. You can change the end point in the same way as the start point.
- If you determine the scene to be erased, press **▲** or **▼** to select "Finish" and press **ENTER**.
 - A chapter mark is automatically added at the location of the erased scene.

Editing the disc

Editing a playlist

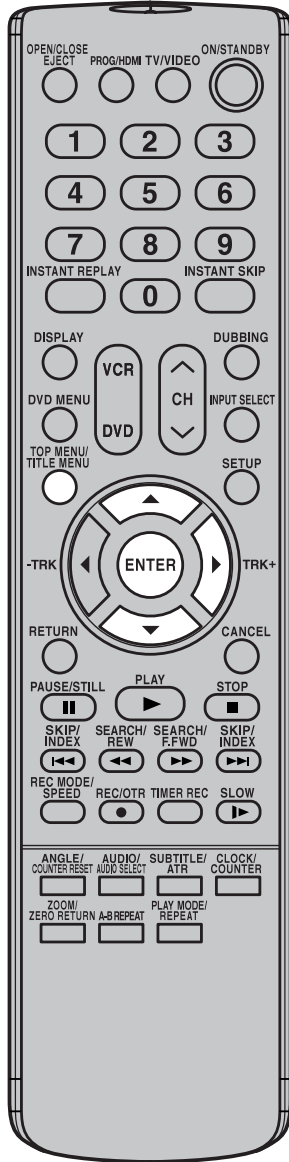

Combining the title

You can create a playlist by combining the several original titles or playlists. To combine the titles, it is necessary to create a playlist at first. By combining the titles in the playlist, a playlist where several titles are combined is created.

- 1 Press **TITLE MENU** to display the title menu.
- 2 Select the playlist where you want to combine the titles.
 - Press ▲ or ▼ to select the playlist.
 - Press ► to display the editing menu of the playlist.
 - Press ▲ or ▼ to select "TITLE COMBINE".

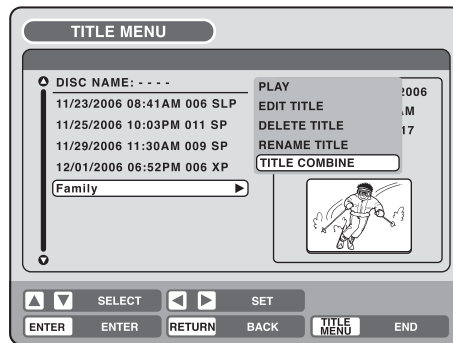

- 3 Press **ENTER**.
Select the title that you want to combine from the title menu.

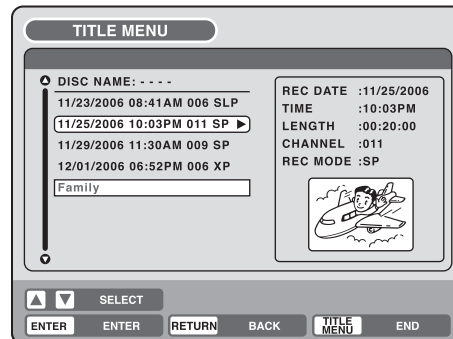

- 4 Press **ENTER**.
Following the playlist, the selected title is combined. The several titles were combined so that the total recording time is displayed.

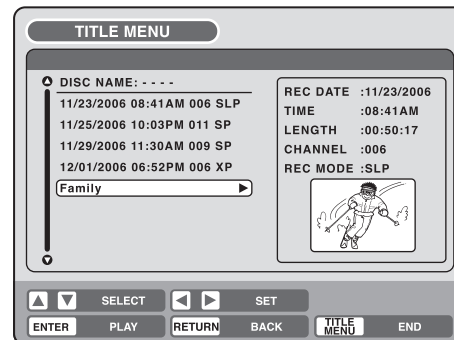

Editing a playlist

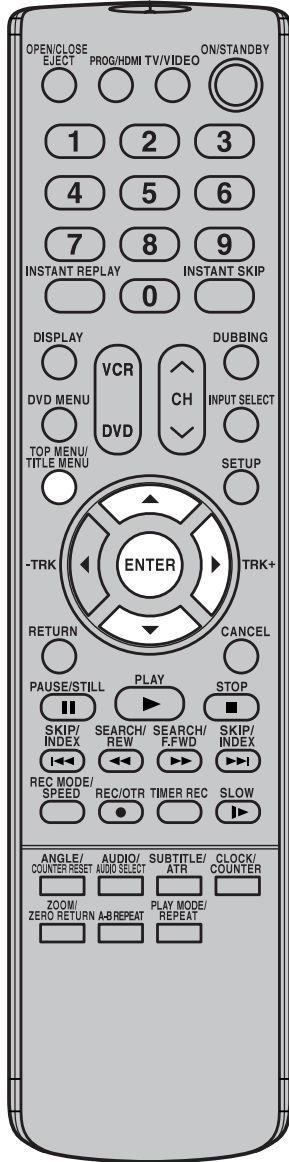

Erasing a playlist

You can erase the created playlist. Even if you erase the playlist, the original title will not be erased.

- 1 Press **TITLE MENU** to display the title menu.
- 2 Select the playlist that you want to erase.
 - Press **▲** or **▼** to select the playlist.
 - Press **▶** to display the editing menu of the playlist.
 - Press **▲** or **▼** to select "DELETE TITLE".

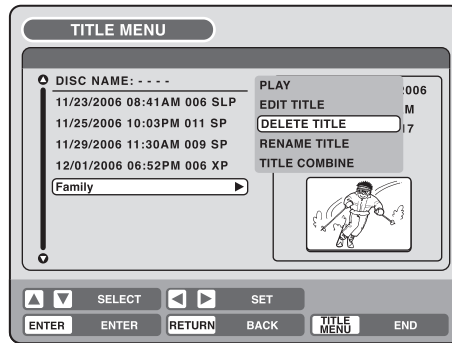

- 3 Press **ENTER**.
The selected playlist will be erased.

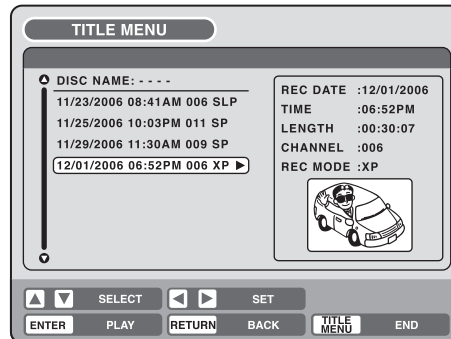

Editing the disc

Editing an original title

In VR mode, you can edit various items, whereas in Video mode, you can only edit the title names.

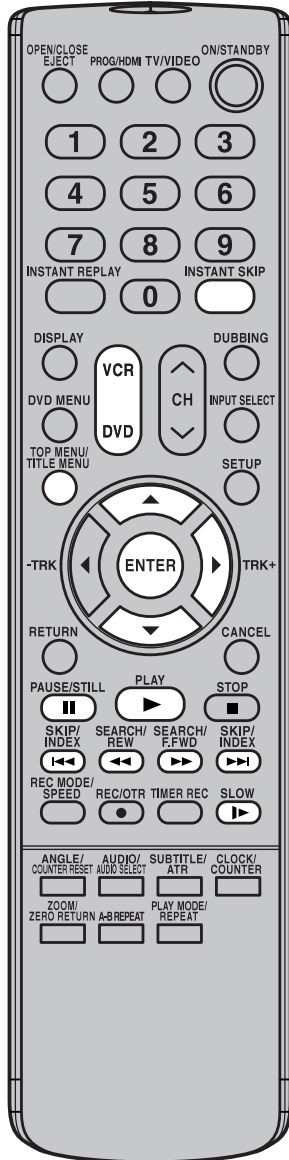

Preparation:

- Turn ON the TV and set to the video input mode.
- Load the recorded disc.
- Press **DVD** to select the DVD mode. (The DVD indicator will light.)

Adding a chapter mark



You can add a chapter mark to the original title. You can add up to 999 chapter marks to one disc.

- 1 Press **TITLE MENU** to display the title menu.
- 2 Select the original title where a chapter mark is added.
 - Press **▲** or **▼** to select the original title.
 - Press **▶** to display the editing menu of the original title.
 - Press **▲** or **▼** to select "ADD CHAPTER MARK".

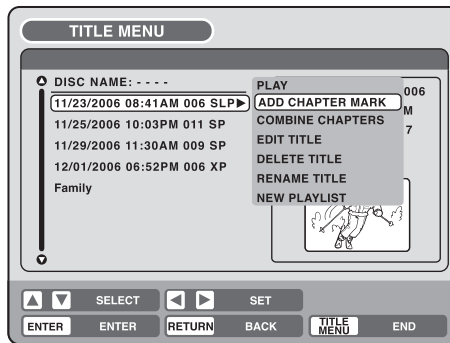

- 3 Press **ENTER**.
The ADD CHAPTER MARK screen will appear.

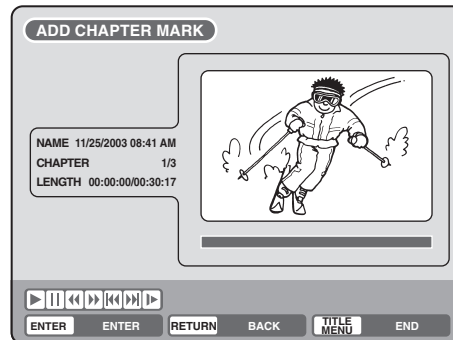

- 4 Press **PLAY** to search a scene where you want to add the chapter mark.
 - Search the scene by using each operation button (**F.FWD**, **REW**, **SKIP▶▶**, **SKIPL◀◀**, **PAUSE/STILL**, **SLOW**, **INSTANT SKIP**) for the playback.

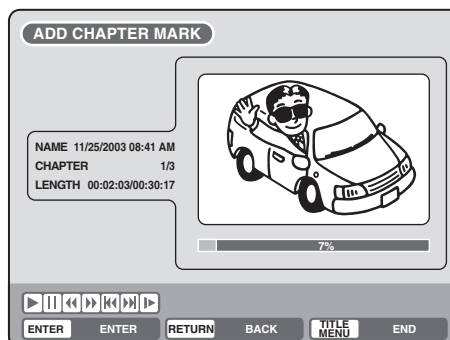

NOTES:

- You can automatically add a chapter mark in recording. For more information, see page 32.
- In case the disc includes more than 9 titles, you can turn to the next or the previous page. (See page 35.)

Editing an original title

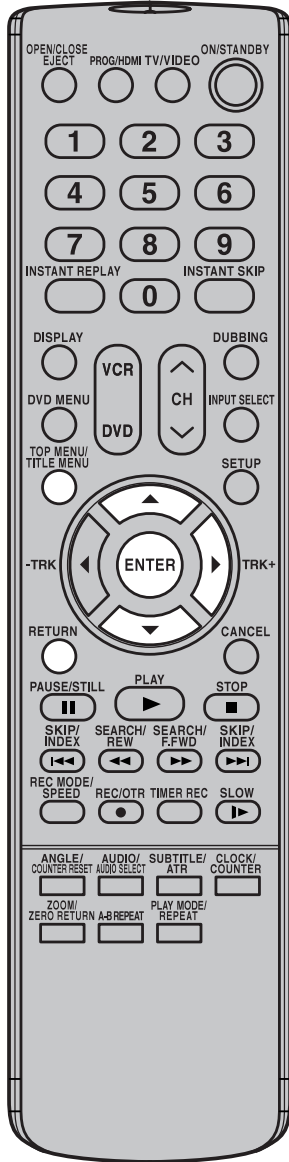

- When the scene you want to add a chapter mark, press **ENTER**. The playback is paused and the position of the added chapter mark appears green.

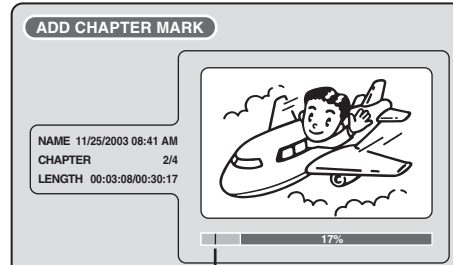

The added chapter mark

- If you want to continue to add chapter mark, repeat step 5.
- Adding chapter marks is finished.
 - To display the title menu, press **RETURN**.
 - To return to the normal screen, press **TITLE MENU**.

Combining chapters

By erasing the added chapter marks, the chapters can be combined.

- Press **TITLE MENU** to display the title menu.
- Select the original titles where you want to combine the chapters.
 - Press **▲** or **▼** to select the original title.
 - Press **▶** to display the editing menu of original title.
 - Press **▲** or **▼** to select "COMBINE CHAPTERS".

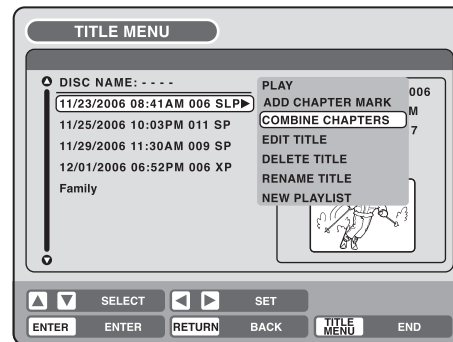

- Press **ENTER**. The COMBINE CHAPTERS screen will appear. At the beginning, the top still image in the chapter 2 is displayed.

NOTE:

Chapter marks that have been added automatically in the erasing of a scene procedure (page 73) cannot be erased.

Editing the disc

Editing an original title

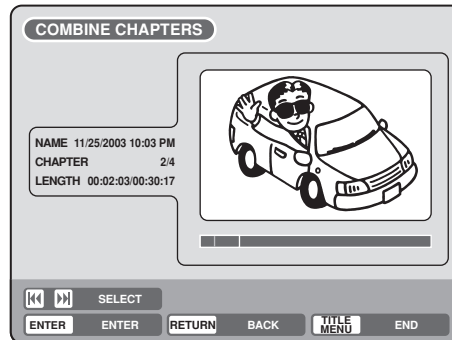
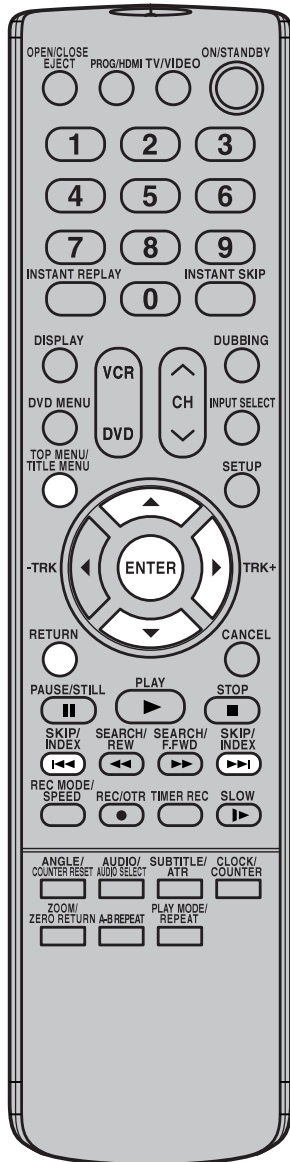

- 4 Press **SKIP▶▶** or **SKIPL◀◀** to select the chapter marks to be erased.
- 5 Press **ENTER**.
The chapter marks are erased and 2 chapters are combined into 1 chapter.
- 6 To continue erasing the chapter marks, repeat steps 4 and 5.
- 7 The combining chapters will completed.
 - To display the title menu, press **RETURN**.
 - To return to the normal screen, press **TITLE MENU**.

Changing an original title name



- 1 Press **TITLE MENU** to display the title menu.
- 2 Select the original title that you want to rename.
 - Press **▲** or **▼** to select the original title.
 - Press **▶** to display the editing menu of original title.
 - Press **▲** or **▼** to select "RENAME TITLE".

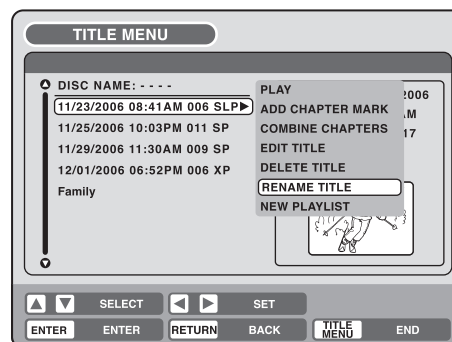

- 3 Press **ENTER**.
The keyboard screen will appear.
The entering method of the title name is the same as for the playlist. See the steps 4 and 5 of "Changing a title name" in "Editing a playlist" (page 65) and enter the title name.

NOTE:

The title name can be a maximum of 64 characters in VR mode and a maximum of 30 characters in Video mode.
Long names will be shortened in the title menu.

Editing an original title

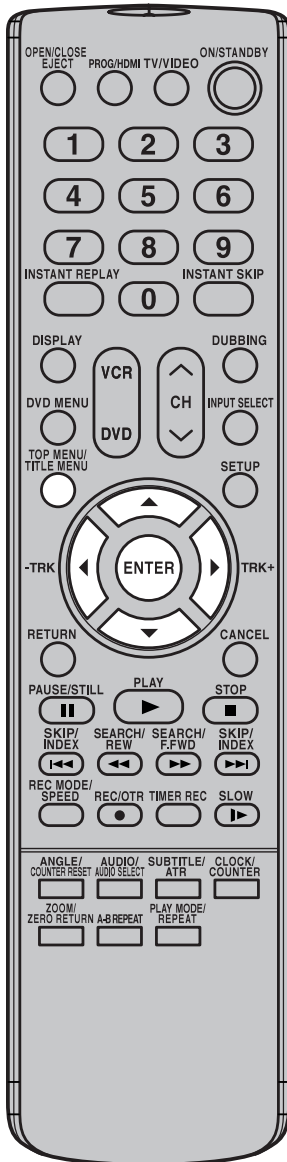

Erasing a scene (Edit title)

You can erase an unnecessary scene from the original title. Erase the scene after checking the title. You cannot restore the erased scene.

When you erase the scene, you can increase the disc space.

- 1 Press **TITLE MENU** to display the title menu.
- 2 Select the original title where a scene you want to erase is included.
 - Press **▲** or **▼** to select the original title.
 - Press **▶** to display the editing menu of original title.
 - Press **▲** or **▼** to select "EDIT TITLE".

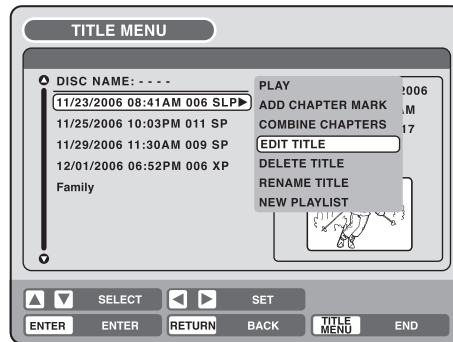

- 3 By pressing **ENTER**, the following message screen will appear.

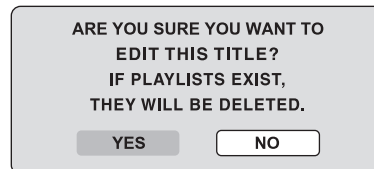

- 4 Press **◀** or **▶** to select "YES" and press **ENTER**, then the EDIT TITLE screen will appear.
 - By selecting "NO", the title menu appears.
- 5 The method for erasing a scene is the same as for the playlist. See the steps 4 to 9 of "Erasing scenes (Edit title)" in "Editing a playlist" (page 66).

NOTES:

- If the scene is erased from the original title, the created playlist is erased.
- Disc space will only be freed up if scenes lasting several minutes are deleted.
- A chapter mark is automatically added at the location of the erased scene.

Editing the disc

Editing an original title

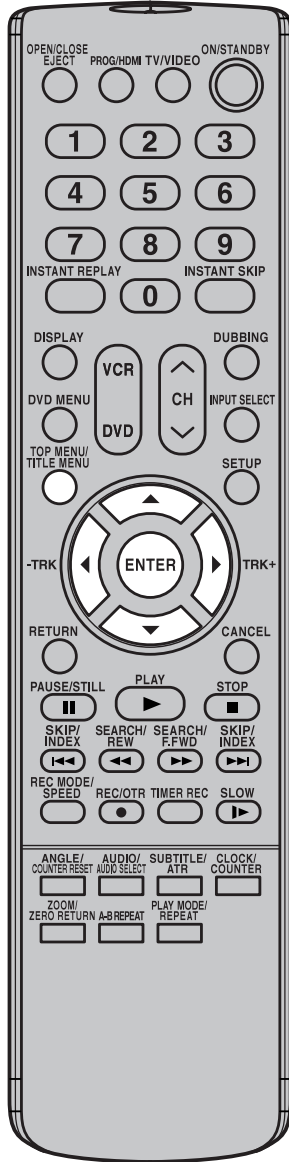

Erasing an original title

You can erase an original title. Erasing the title deletes both the title and the recording saved under that title name. Erase the original title after checking its title. The erased title cannot be restored. When you erase the title, you can increase the disc space.

- 1 Press **TITLE MENU** to display the title menu.
- 2 Select the original title you want to erase.
 - Press **▲** or **▼** to select the original title.
 - Press **▶** to display the editing menu of original title.
 - Press **▲** or **▼** to select "DELETE TITLE".

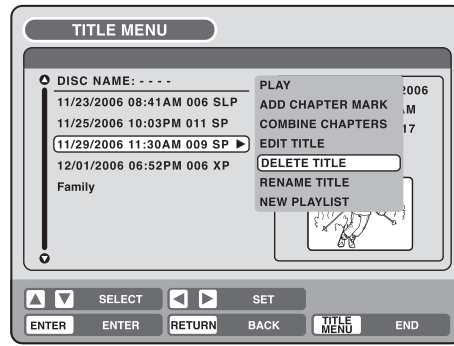

- 3 By pressing **ENTER**, the following message screen will appear.

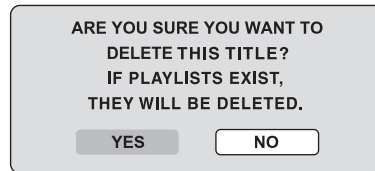

- 4 Press **◀** or **▶** to select "YES" and press **ENTER**, then the original title will be erased.
 - Erasing the title will be canceled by selecting "NO".

NOTE:

If the original title is erased the created playlist is also erased.

Changing a disc name

You can change a disc name from the title menu.

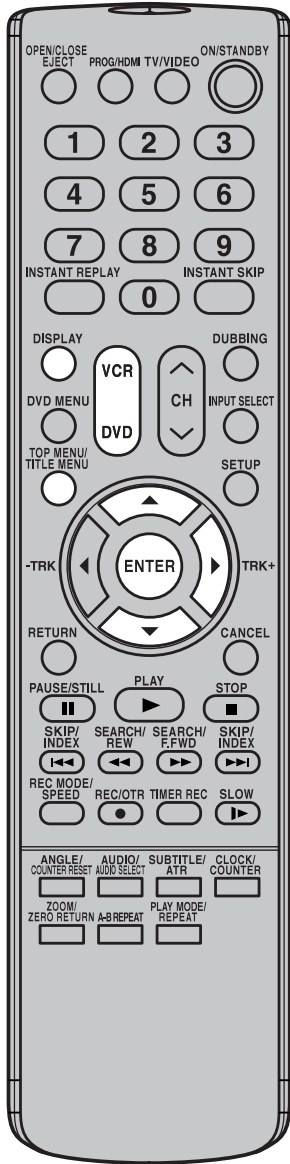

Preparation:

- Turn ON the TV and set to the video input mode.
- Load the recorded DVD disc.
- Press **DVD** to select the DVD mode. (The DVD indicator will light.)

Changing a disc name



- 1 Press **TITLE MENU** to display the title menu.
- 2 • Press **▲** or **▼** to select "DISC NAME".
• Press **▶** to display the editing menu.
• Press **▲** or **▼** to select "RENAME DISC".

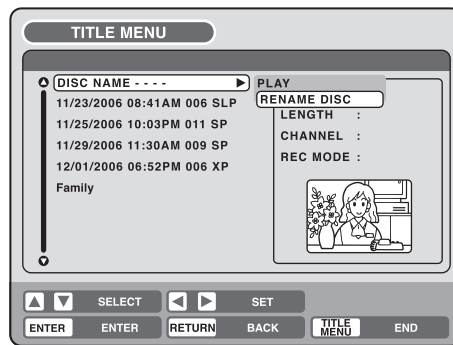

- 3 Press **ENTER**.
The keyboard screen will appear.

- 4 Use the keyboard screen to enter the disc name.

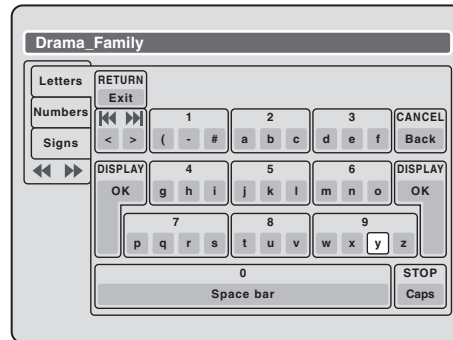

- 5 Press **DISPLAY** to return the title menu.

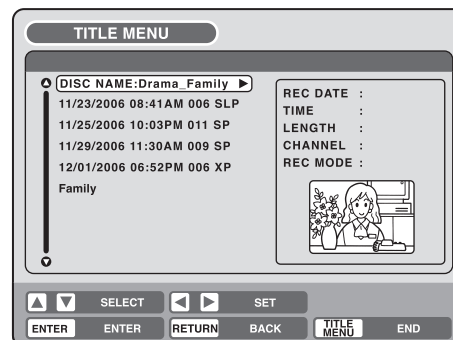

NOTES:

- The disc name can be a maximum of 30 characters. Long names will be shortened in the title menu.
- For using the keyboard screen, see "Using the keyboard screen" (page 76).
- A DVD-R disc cannot be named after it is finalized.

Editing the disc

Changing a disc name

Using the keyboard screen

This section explains the function of the keyboard screen and how to input characters. The disc name and the title name can be changed using the keyboard screen.

Keyboard screen types

The keyboard screen has three types of "Letters", "Numbers" and "Signs". The type can be switched over by pressing **REW** or **F.FWD**.

Letters: This is mainly used for inputting alphabetical letters.

For the keyboard screen of Letters, see the previous page.

Numbers: This is used for inputting numbers.

Signs:

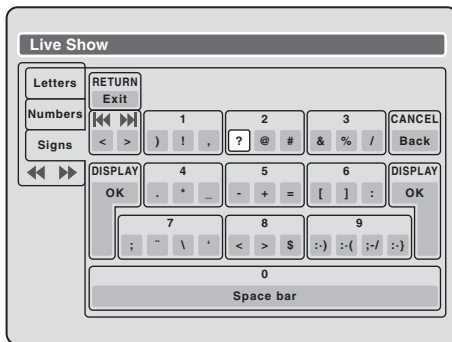
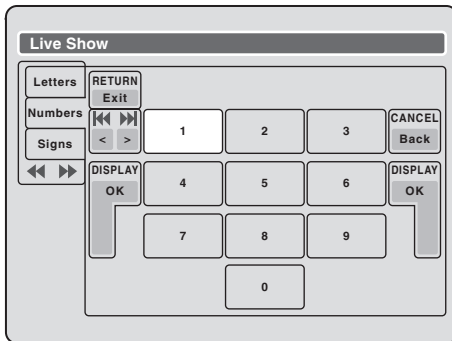

Inputting characters

There are two methods for inputting characters.

Character input 1

1 Press **▲**, **▼**, **◀** or **▶** to select the character to be input.

2 Press **ENTER**.
The selected character will be input.

Character input 2

Example: Explained here is the procedure when you input "F" and "J".

1 Press the **numeric keys** continuously and select the character to be input.

To input F, press **3** three times.



NOTE:

When the interval between the pressing of the **numeric keys** is 2 seconds or more in selecting the input character, the selected character will automatically be input.

2 Stop the key operation when you select the character to be input.

The selected character will automatically be input.

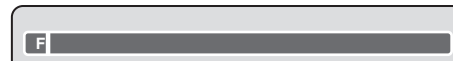

3 Press the **numeric keys** where the following character is assigned.



4 When the character to be input is selected, stop the key operation.

The selected character is automatically input.





Changing a disc name

Erasing a character

You can erase the input character.

Erasing method 1

- 1 Press **▲**, **▼**, **◀** or **▶** to select "Back".
- 2 Press **ENTER**.
The last input character will be erased.
- 3 To erase the characters continuously, press **ENTER** repeatedly.
The input characters will be erased from the last to the top one by one.

Erasing method 2

- 1 Press **CANCEL**.
The last input character is erased.
- 2 To erase the characters continuously, press **CANCEL** repeatedly.
The input characters will be erased from the last to the top one by one.

Erasing method 3

Use the cursor to select the character and erase it.

- 1 Press **SKIPL◀◀** or **SKIP▶▶** to move the cursor after the character you want to erase.
- 2 Press **CANCEL**.
The character before the cursor position will be erased.

Selecting between uppercase and lowercase letters

You can select either uppercase or lowercase letters when modifying your titles, using the keyboard screen with the "Letters" tab.

- 1 Press **STOP**.
(Or, press **▲**, **▼**, **◀** or **▶** to select "Caps", then press **ENTER**.)

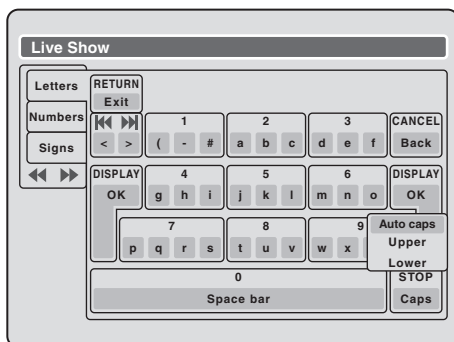

- 2 Press **▲** or **▼** to select the type of letters in the list below and press **ENTER**.

Auto caps: Determines uppercase and lowercase automatically.

Upper: Inputs all with uppercase letters.

Lower: Inputs all with lowercase letters.

Determining a name

To determine the entered disc name and title name, press **DISPLAY**. Or, press **▲**, **▼**, **◀** or **▶** to select "OK", then press **ENTER**.

The keyboard screen disappears and the display will return to the title menu.

The entered disc name and title name are displayed in the title menu.

Cancelling character input function

When you want to cancel the input and changed characters function, press **RETURN**. Or, press **▲**, **▼**, **◀** or **▶** to select "Exit", then press **ENTER**.

The input and changed characters function are canceled and the title menu will appear.

Editing the disc

Dubbing a tape onto a disc



You can record video or audio on a video tape onto a disc.

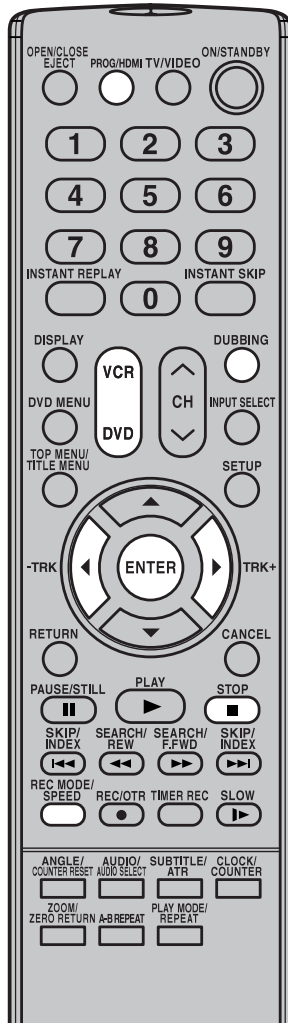

NOTES:

- Dubbing cannot be accomplished when
 - a copy protected tape is used.
 - disc protection is set.
 - disc has no recording space.
 - HDMI mode is active.
- Dubbing stops when
 - the video tape is played back to the end and stops.
 - recording space becomes full.
- The videos recorded from TV programs or movies can be used only for your personal enjoyment without permission of the copyright holder.

Preparation:

- Turn ON the TV and set to the video input mode.
- Load a source video tape and a disc for recording.
- Remove the erase protection tab of the source video tape to prevent the data from accidentally being erased.
- Confirm the disc space before operation.
- Press **PROG/HDMI** repeatedly to turn OFF HDMI mode.

- 1 Press **DVD** to set this unit to DVD mode. The DVD indicator will light.
- 2 Press **REC MODE/SPEED** and select the recording mode.
 - When **REC MODE/SPEED** is pressed each time, “SP”, “LP”, “SLP” or “XP” is selected in this order.
 - The recording mode is indicated on both the TV screen and the display window.
 - For the details of the recording mode, see page 55.
- 3 Press **VCR** and set the unit to VCR mode.

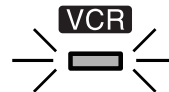

NOTE:

Confirm that the VCR indicator lights.

- 4 Press **DUBBING**.
 - The unit is changed to DVD mode automatically.
 - The VCR is waiting for playback and the DVD is waiting for recording. Then the following message will appear.
- 5 Press **DUBBING**, or press ◀ or ▶ to select “YES” and press **ENTER**. Dubbing starts.
 - To cancel dubbing, press **STOP**, or select “NO” and press **ENTER**.

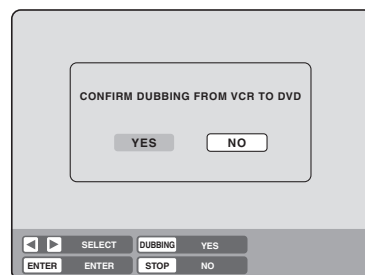

In dubbing, VCR playback, DVD recording and “dub” (dubbing) indicator appear on the display window.

- 6 To stop dubbing, press **STOP**.

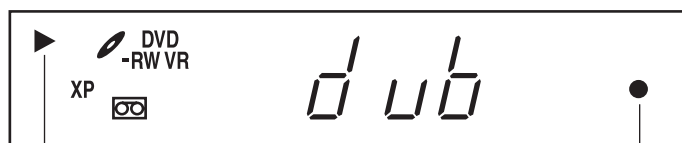

Video playback

DVD recording

Dubbing a disc onto a tape



You can record both video and audio from a disc to a video tape. When a disc with a copy guard is used, a distorted image is recorded onto the video tape.

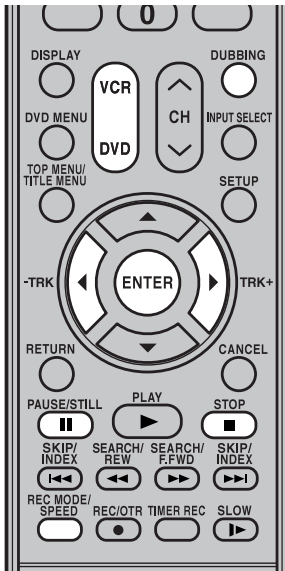

NOTES:

- Dubbing cannot be accomplished when
 - a copy protected disc is used.
 - the erase prevention tab of video tape is removed.
 - HDMI mode is active.
- Dubbing stops when
 - the disc is played back to the end and stops.
 - no recording space on the Video tape remains
- During dubbing, the unit is changed to interlaced scan mode automatically, if it has been previously set to progressive scan mode.
- If no special permission is obtained from the copyright owner, videos recorded from TV programs or movies can only be used for your own personal enjoyment.

Preparation:

- Turn ON the TV and set to the video input mode.
- Load a source disc and a video tape for recording.
- Confirm the remaining tape for recording before operation.
- Press **PROG/HDMI** repeatedly to turn OFF HDMI mode.

- 1 Press **VCR** to set this unit to VCR mode. The VCR indicator will light.
- 2 Press **REC MODE/SPEED** and select the recording mode.
 - When **REC MODE/SPEED** is pressed each time, "SP" or "SLP" is selected.
 - The recording mode is indicated on both the TV screen and the display window.
 - For the details of the recording mode, see page 49.
- 3 Press **DVD** and set the unit to DVD mode.

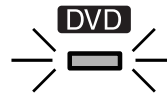

NOTE:

Confirm that the DVD indicator lights.

- 4 Press **DUBBING**.
 - The DVD is waiting for playback and the VCR is waiting for recording. Then the following message appears.
- 5 Press **DUBBING**, or press **◀** or **▶** to select "YES" and press **ENTER**. Dubbing starts.
 - To cancel dubbing, press **STOP**, or select "NO" and press **ENTER**.

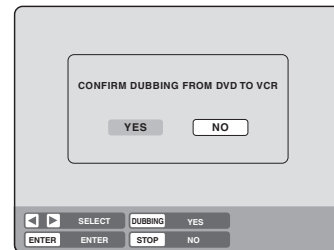

In dubbing, DVD playback, VCR recording and "dub" (dubbing) indicator appear on the display window.

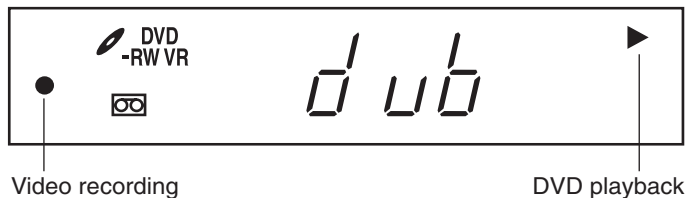

- 6 To stop dubbing, press **STOP**.

Dubbing only the specified titles or the playlist

When you want to dub only specific titles or playlists recorded on the disc, start the playback of the desired title or playlist, and then immediately press **DUBBING**, **STOP** or **PAUSE/STILL**. If you press **DUBBING**, proceed from step 5 above. If you press **STOP** or **PAUSE/STILL**, proceed from step 4 above. The first few seconds of the title or playlist may not be recorded. When playback of the title or playlist is completed, the dubbing stops.



Dubbing

Dubbing using other equipment



You can connect another VCR or camcorder to dubbing.

Typical connection: When using this unit as a recording device

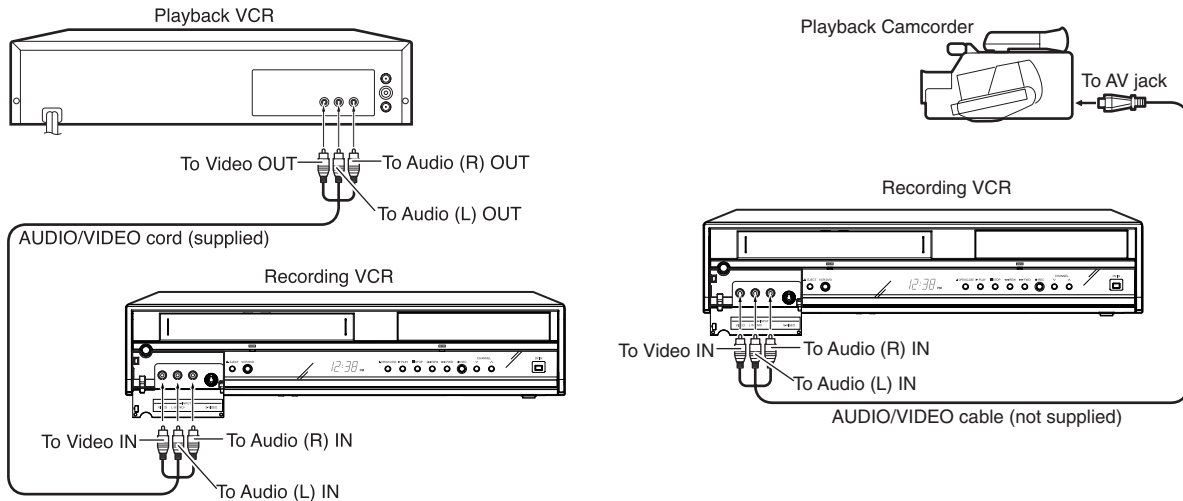

You can also connect to the audio/video input jack (L1) at the rear side of this unit. In addition, each S-Video input jack at the front and rear sides can be used for recording on the disc. (The S-Video input jack cannot be used for recording on the video tape.)

When a video is recorded using this unit

Preparation:

- Turn ON the TV and set the unit to the video input mode.
- Load a video tape where the erase-protection tab is not activated or a disc with enough recording space.
- To record onto a video tape, set the unit to VCR mode, whereas to record onto a disc, set it to DVD mode.

- 1 Press **INPUT SELECT** and set the channel to L2 (or L1).
L1 (LINE 1): on the rear panel
L2 (LINE 2): on the front panel
Confirm that L2 (or L1) appears on the display window.

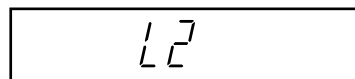

- 2 Press **REC MODE/SPEED** and select the recording mode.
VCR: SP or SLP (See page 49)
DVD: SP, LP, SLP or XP (See page 53)
- 3 Press **REC/OTR** on this unit, then press **PAUSE/STILL**.
- 4 Press the **PLAY** button on the playback device, then press the **PAUSE/STILL** button.
- 5 Release the recording pause and the playback still simultaneously to begin the duplicating process.
- 6 To stop dubbing, press **STOP**.

NOTES:

- If using a monaural VCR or other equipment, connect Audio (L) IN jack to Audio OUT using only one audio cable.
- When this unit is used as a playback device, a mark or a character displayed on the screen is also dubbed as an image. When the screen display is set to OFF, see "DISPLAY" on page 29.
- If no special permission is obtained from the copyright owner, videos recorded from TV programs or movies can only be used for your own personal enjoyment.
- You may not dub a copy protected video or DVD disc.





Dubbing using other equipment



You can connect a DV format digital video camera to the DV IN terminal to record from it.

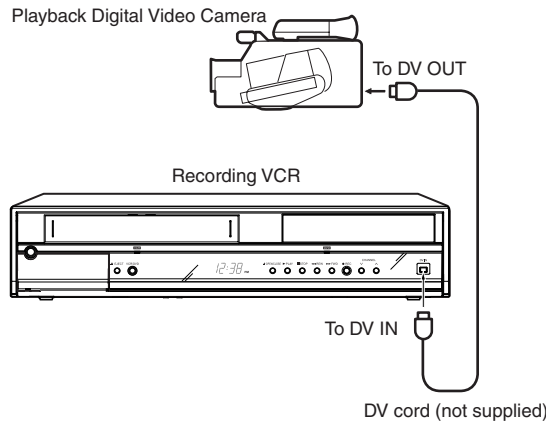

NOTES:

- The DV terminal of this recorder supports only input from a DV format digital video camera. It cannot output to a connected device. Some models of DV format digital video cameras may be not compatible.
- DV recording does not start in the following cases:
 - While recording or in the Chase playback mode
 - While timer recording standby mode
- DV recording does not work if the DV terminal is connected to equipment other than DV format digital video camera, such as a PC.
- Do not keep the DV terminal connected unless you record from a DV format digital video camera, as it may give influence on the recorder if operated.
- When you want to record both stereo 1 and stereo 2 sounds from a DV format digital video camera, additionally make a connection to the audio input jacks on this recorder using cables such as audio/video cables supplied with the DV format digital video camera.
- If a DV format digital video camera is not recognized, pull out the plug and connect it again.
- Some models of DV format digital video cameras may support a different compression format. From such equipment, recording is not possible.
- Depending on the models of DV format digital video cameras, recording may not work properly or some functions may be disabled.
- On an input source from a DV tape which is partly recorded over, chapters may not be made properly.

Preparation:

- Turn ON the TV and set to the video input mode.
- Set the digital video camera to the Playback mode.
- Connect a DV format digital video camera to the DV IN terminal on the front panel.
- Load a disc with enough recording space.

- 1 Press **DVD** to set this unit to DVD mode. The DVD indicator will light.
- 2 Press **INPUT SELECT** and set the channel to DV. DV control menu appears on screen.
 - To clear the DV control menu, press **DISPLAY** repeatedly.

- ▶ : PLAY
- : STOP
- || : PAUSE
- ▶▶ : F.FWD
- ◀◀ : REW

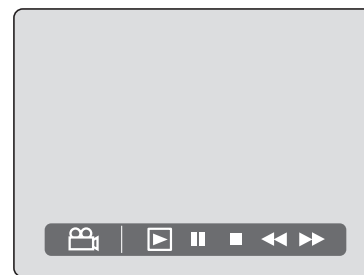

- 3 Press ◀ or ▶ to select "▶", then press **ENTER**. The digital video camera starts playback. To stop the playback at a desired scene, press ◀ or ▶ to select "■" then press **ENTER**
- 4 Press **DUBBING**. The digital video camera starts playback and this unit starts recording.
- 5 To stop dubbing, press **STOP**. If the playback finished, the recording stops automatically.



Glossary

A-B Repeat Playback

Playback that repeats between two set points, A and B.

angle

Recorded onto some DVD discs are scenes which have been simultaneously shot from a number of different angles (the same scene is shot from the front, from the left side, from the right side, etc.). With such discs you can select the angle from which to view the scene.

auto chapter

Feature that automatically makes chapter marks on a DVD disc during recording.

auto clock

Feature that automatically sets the internal clock.

blue background

Feature that automatically changes unpleasant noise images to a blue screen when a channel without a broadcast or a channel on which the broadcast has ended has been selected.

BROWSER screen

Screen that appears when TITLE MENU is pressed during MP3, WMA, JPEG or DivX® CD is inserted.

CABLE

Cable television.

chapter

A section within a title is called a "chapter".

Chase playback

Feature that playback from the beginning of a program currently being recorded.

copy guard

Copyright protection signal. Software and broadcasts that contain this signal cannot be recorded.

Dolby Digital

Dolby® Digital Recording enables consumers to record high-quality video with stereo sound on recordable DVD discs. The technology, when utilized instead of PCM recording, also saves recordable disc space, allowing for higher video resolution or extended recording time on each DVD. DVDs created using Dolby Digital Recording will play back on all DVD-Video players.

Manufactured under license from Dolby Laboratories. "Dolby" and the double-D symbol are trademarks of Dolby Laboratories.

DTS

This is a digital sound system developed by Digital Theater Systems for use in cinemas. This system uses 6 audio channels and provides accurate sound field positioning and realistic acoustics. (By connecting a DTS Digital Surround decoder, you can also listen to DTS Digital Surround sound.)

DVD menu

Menu recorded on a DVD-Video that enables the user to select subtitles language, dubbing, etc.

finalize

Operation that enables discs recorded or edited with this unit to be played back on other DVD players.

Instant replay

If INSTANT REPLAY is pressed during playback, playback returns to a point 10 sec earlier and resumes.

Instant Skip

When pressed during playback, playback jumps 30 sec ahead and resumes.

interlaced scanning

Technology that alternately displays odd-numbered scanning lines and even-numbered scanning lines. Also called "480i", "i" meaning "interlace".

letter box

Feature that displays black bands above and below the playback images during playback of a disc recorded in wide (16:9) format on a 4:3 TV connected to this unit.

MP3

One type of audio compression that uses MPEG1. This format compresses the sound to use up about 1/10 of the original file space, without impairing the original sound quality.

original title

The file created by recording something is called an "original title".

OTR

One-touch Timer Recording. Start a timed recording by pushing just one button (up to 6 hours).

pan scan

Feature that cuts the left and right edges of playback images to a 4:3 size during playback of a disc recorded in wide (16:9) format on a 4:3 TV connected to this unit.

parental control

Some discs control viewing according to the age of the viewer. A control level can be set for those types of discs.



Glossary

parental control settings

- Level 1: Adult discs and general discs (R-rated discs included) cannot be played back.
- Level 2 to 3: Adult discs and R-rated discs cannot be played back.
- Level 4 to 7: Adult discs cannot be played back. (Level 4 to 7 discs contain content children age 15 and younger may not see.)
- Level 8: Virtually all discs can be played back without restriction.

PBS

Acronym for Public Broadcast System. The PBS channel transmits data for auto clock setting.

playlist

User-created titles based on each original title.

Progressive scan

Technology that simultaneously displays odd-numbered scanning lines and even-numbered scanning lines from top to bottom. Also called "480p", "p" meaning "progressive".

region number

There is software that enables DVD playback in differing countries. The number of that kind of disc is called the "region number".

SETUP MENU

Menu that contains settings for various features of this unit, such as recording and playback. Timer recording is also set from the SETUP MENU.

slide show

Technique for flipping through and viewing many images (JPEG files).

subtitle language

Language used for subtitles of movies, etc. Viewers can watch in a language of their choosing.

title

A program recorded on a disc is called a "title".

title menu

Menu that lists titles and tracks recorded on the disc. It is used for playback and disc editing.

top menu

Menu on a DVD-Video for selecting chapters for playback, subtitle language, etc. Some DVD-Video call this top menu "Title".

track

A song on an Audio CD is called a "track".

TRACK INFO screen

The screen that appears when TITLE MENU is pressed, if an Audio CD or Video CD disc is in the unit.

Video mode

This recording format is compatible with commercially available DVD players.

virtual surround

Technology that converts audio that is not recorded in surround sound into audio that assimilates surround sound.

VR mode

This recording format is the basic DVD-RW recording format, and lets you enjoy the various editing functions available with this unit.

Language code list

Enter the appropriate code number for the initial settings "DVD MENU", "AUDIO" and/or "SUBTITLE" (see page 25).

Language Name	Code	Language Name	Code	Language Name	Code	Language Name	Code
Abkhazian	1112	Fiji	1620	Lingala	2224	Singhalese	2919
Afar	1111	Finnish	1619	Lithuanian	2230	Slovak	2921
Afrikaans	1116	French	1628	Macedonian	2321	Slovenian	2922
Albanian	2927	Frisian	1635	Malagasy	2317	Somali	2925
Amharic	1123	Galician	1722	Malay	2329	Spanish	1529
Arabic	1128	Georgian	2111	Malayalam	2322	Sundanese	2931
Armenian	1835	German	1415	Maltese	2330	Swahili	2933
Assamese	1129	Greek	1522	Maori	2319	Swedish	2932
Aymara	1135	Greenlandic	2122	Marathi	2328	Tagalog	3022
Azerbaijani	1136	Guarani	1724	Moldavian	2325	Tajik	3017
Bashkir	1211	Gujarati	1731	Mongolian	2324	Tamil	3011
Basque	1531	Hausa	1811	Nauru	2411	Tatar	3030
Bengali; Bangla	1224	Hebrew	1933	Nepali	2415	Telugu	3015
Bhutani	1436	Hindi	1819	Norwegian	2425	Thai	3018
Bihari	1218	Hungarian	1831	Oriya	2528	Tibetan	1225
Breton	1228	Icelandic	1929	Panjabi	2611	Tigrinya	3019
Bulgarian	1217	Indonesian	1924	Pashto, Pushto	2629	Tonga	3025
Burmese	2335	Interlingua	1911	Persian	1611	Turkish	3028
Byelorussian	1215	Irish	1711	Polish	2622	Turkmen	3021
Cambodian	2123	Italian	1930	Portuguese	2630	Twi	3033
Catalan	1311	Japanese	2011	Quechua	2731	Ukrainian	3121
Chinese	3618	Javanese	2033	Rhaeto-Romance	2823	Urdu	3128
Corsican	1325	Kannada	2124	Romanian	2825	Uzbek	3136
Croatian	1828	Kashmiri	2129	Russian	2831	Vietnamese	3219
Czech	1329	Kazakh	2121	Samoan	2923	Volapük	3225
Danish	1411	Kirghiz	2135	Sanskrit	2911	Welsh	1335
Dutch	2422	Korean	2125	Scots Gaelic	1714	Wolof	3325
English	1524	Kurdish	2131	Serbian	2928	Xhosa	3418
Esperanto	1525	Laothian	2225	Serbo-Croatian	2918	Yiddish	2019
Estonian	1530	Latin	2211	Shona	2924	Yoruba	3525
Faroese	1625	Latvian, Lettish	2232	Sindhi	2914	Zulu	3631

Problems and troubleshooting

Use the following check list for troubleshooting when you have problems with your unit. Consult your local dealer or service outlet if problems persist.

Be sure all connections are properly made when using with other units.

SYMPTOMS	POSSIBLE SOLUTIONS	PAGE
DVD/VCR		
DVD/VCR does not operate.	<ul style="list-style-type: none"> • Make sure the power cord is plugged in. • Try another AC outlet. • Power is off, check fuse or circuit breaker. • Unplug unit, then plug it back in. • Select the DVD or VCR mode before operating. 	15 – – 15 35, 50
No picture.	<ul style="list-style-type: none"> • Antenna connection is not correct or antenna cable is disconnected. • The video channel is not in the correct position or the TV is not set to the video channel 3 or 4. • Check the unit is connected correctly. • The video input selector of the TV is not set to VIDEO. Set to VIDEO (or equivalent). • Channel is set to the external mode. 	16~19 23 16~22 – –
No sound.	<ul style="list-style-type: none"> • Check the unit is connected correctly. • Check the input selector of the amplifier is set properly. • The unit is in the Special playback mode. 	16~22 – 37, 51
The remote control does not function.	<ul style="list-style-type: none"> • Aim at the remote control at the remote sensor. • Operate within Approx. 7 meters or reduce the light in the room. • Clear the path of the beam. • The batteries are weak. Replace the batteries. • Check the batteries are inserted correctly. 	15
No Cable TV reception	<ul style="list-style-type: none"> • Check all Cable TV connections. • Station or Cable TV system problems, try another station. 	18, 19
DVD		
Display is not shown in your language.	<ul style="list-style-type: none"> • Select proper language in the SETUP MENU. 	25
Playback doesn't start.	<ul style="list-style-type: none"> • No disc is inserted. • The disc may be dirty. Clean up the disc. • The unit cannot play DVD-ROMs, etc. 	34 9 9
Stopping playback, search, slow-motion play, repeat play, or program play, etc. cannot be performed.	<ul style="list-style-type: none"> • Some discs may not do some of the functions. 	–
Recording Does not work.	<ul style="list-style-type: none"> • Check the disc space, using the disc information. • Check the disc for protection. • Check if the video to be recorded is not "copy-guarded". • Check that the number of recorded titles is 99 or less, using the disc information. • Check the number of the total chapters for the recorded titles is 999, using the disc information. • In a DVD-RW of Ver. 1.0, recording in Video mode does not work. Check the disc type. 	36 29 54 36 36, 70 10
A Disc recorded using this recorder cannot be played back in other players.	<ul style="list-style-type: none"> • Check that the disc is finalized. • Some DVD players will not play even if the disc has been finalized. • If the disc was recorded in VR mode, the other player must be RW compatible in order to play the disc. 	28 11, 28 11, 28

Additional information

Problems and troubleshooting / Video head cleaning

SYMPTOMS	POSSIBLE SOLUTIONS	PAGE
VCR		
TV recording does not work.	<ul style="list-style-type: none"> The erase prevention tab of the video cassette is broken off. The unit is in the external input mode. 	49, 55
Timer recording does not work.	<ul style="list-style-type: none"> The time is not set correctly. The recording start/end time is not set correctly. TIMER REC has not been pressed (⏻ is not lit). 	27 59 60
Noise bars on screen.	<ul style="list-style-type: none"> Tracking adjustment beyond range of automatic tracking circuit. Try Manual tracking adjustment. Video heads are dirty. The tape is worn or damaged. 	51 86 –
OTHER		
No picture, or screen is blurred or divided into two parts.	<ul style="list-style-type: none"> The progressive scan mode is active though the unit is connected to a TV via the VIDEO OUT jack. 	21
No 4:3 (16:9) picture	<ul style="list-style-type: none"> The setup does not match your TV. 	30
No on-screen display	<ul style="list-style-type: none"> Select DISPLAY/CALL “ON”. 	29
Nothing appears in the display window	<ul style="list-style-type: none"> Check the DIMMER setting for SETUP. 	29
No surround sound	<ul style="list-style-type: none"> The setup does not match your stereo system. 	31
The unit or remote operation key is not functioning.	<ul style="list-style-type: none"> Turn off the unit and unplug the AC power cord for several minutes, then replug it. 	–
Playback does not start when the title is selected.	<ul style="list-style-type: none"> Check the Parental setup. 	26
Audio soundtrack and/or subtitle language is not changed when you playback a DVD.	<ul style="list-style-type: none"> Multilingual language is not recorded on the DVD disc. 	25
No subtitles	<ul style="list-style-type: none"> Some discs have no subtitles. Subtitles are cleared. Press SUBTITLE. 	25, 42
Angle cannot be changed.	<ul style="list-style-type: none"> Multi-angles are not recorded on the DVD disc. 	–
“⏻” appears on the screen.	<ul style="list-style-type: none"> The function is prohibited with the unit or the disc. 	–

Video head cleaning

Video head clogging

The video heads are the means by which the DVD/VCR reads the picture from the tape during playback. In the unlikely event that the heads become dirty enough to be clogged, no picture will be played back. This can easily be determined if, during playback of a known good tape, there is good sound, but no picture (picture is extremely snowy). If this is the case, have the DVD/VCR checked by qualified service personnel.

- NOTES:**
- DO NOT ATTEMPT TO CLEAN THE VIDEO HEADS OR SERVICE THE UNIT BY REMOVING THE REAR COVER.
 - Video heads may eventually wear out and should be replaced when they fail to produce clear pictures.
 - To help prevent video head clogging, use only good quality VHS tapes. Discard worn out tapes.

Error/Warning message list

	ERROR/WARNING MESSAGE	CAUSE	POSSIBLE SOLUTIONS	PAGE
Power ON	SYSTEM ERROR PLEASE WAIT	The power was shut down without completing the termination process due to a power failure or disconnection of the AC cord plug. (Abnormal termination)	Wait until the message disappears.	--
	SYSTEM ERROR PLEASE WAIT DISC CHECKING	The power was abruptly turned off before writing to the disc was completed.	The data is now restoring.	--
	SYSTEM ERROR DISC MIGHT BE FAILED PRESS ENTER/SELECT	The data restoration was completed.	Press ENTER , then the screen returns to the normal display. The data may not be restored even if the restoration process is performed.	--
Playback	NO DISC	When a disc was not loaded in the unit, PLAY was pressed.	Load a disc.	34
	REGION CODE ERROR	A disc specified other than "Region 1" or "Region ALL" was loaded.	A disc specified other than "Region 1" or "Region ALL" cannot be played back.	9
	INCORRECT DISC - C104, C105, C106, C107	The disc cannot be identified.	Check the disc and load a proper disc.	9
Recording	NO DISC	When a disc was not loaded into the unit, REC/OTR was pressed.	Load a disc.	55
	PROCESSING PLEASE WAIT	The recording termination is processing.	Wait until the process is completed.	--
	RECORDING INTERRUPTED - C204	Disc became full during recording.	Erase unnecessary titles or load another disc and restart recording.	74
	CANNOT RECORD - C203	Recording was tried onto the disc having no space.	Check the disc space.	36
	CANNOT RECORD - C206	Recording was tried onto the disc which does not support recording.	Load a recordable disc.	10
	CANNOT RECORD - C208	Recording was tried onto the finalized disc.	Undo finalization or load another disc for recording.	29
	CANNOT RECORD - C209	Adding data was tried onto the disc recorded in the other unit.	Load another disc for recording.	--
	CANNOT RECORD - C210	Adding data was tried to the disc where PC data was recorded.	Load another disc for recording.	--
	DISC ERROR - C205, C211, C212, C213	A scratch or contamination was found on the disc.	Check the disc and reload it, or use another disc for recording.	--
	CANNOT RECORD, EXCEEDS LIMITED NUMBER OF TITLES	99 titles were recorded on the disc.	Erase unnecessary titles or load another disc.	74
	CANNOT RECORD, EXCEEDS LIMITED NUMBER OF CHAPTERS	999 chapters exist on the disc.	Erase unnecessary chapters or load another disc.	71
	CANNOT RECORD PROTECTED IMAGE	Recording was attempted on a copy protected video.	You cannot record a copy protected video.	54
	RECORDING INTERRUPTED PROTECTED IMAGE	The video was changed to a copy-guard format in recording.	You cannot record a copy protected video.	54
	CANNOT RECORD IN VIDEO MODE. COPY IMAGE ONCE ONLY.	Recording was attempted of a "Copy Once" program onto a disc (Video mode).	Load a DVD-RW Ver. 1.1 or later (VR mode) with CPRM.	54
CANNOT RECORD ON DISC. THIS IS NOT CPRM DISC.	Recording was attempted of a "Copy Once" program onto a disc without CPRM.	Load a DVD-RW Ver. 1.1 or later (VR mode) with CPRM.	54	
Dubbing	SWITCHING TO INTERLACE OUTPUT FOR COPYING	Dubbing was initiated from a disc to a video tape in the progressive scan mode.	The mode is automatically changed to interlaced mode if dubbing from a disc to a video tape.	79
	CANNOT COPY DATA - C251	No video tape or disc is inserted as a source for the recording.	Load a video tape or disc into the source drive.	78 , 79
	CANNOT COPY DATA - C254, C255	The source video or disc to be copied is copy-guarded.	You cannot dub a video containing copy-guarded material.	54
	COPYING INTERRUPTED	The video tape or disc became full during dubbing.	Load another video tape or disc for recording and restart.	78 , 79
Disc setup	DISC ERROR - C302, C303	Cannot Format disc due to a scratch or contamination on the disc.	Check the disc and reload it, or use another disc for recording.	--
	DISC ERROR - C304, C305	Cannot Finalize disc due to a scratch or contamination on the disc.	Check the disc and reload it, or use another disc for recording.	--
	DISC ERROR - C306	Cannot Undo Finalize disc due to a scratch or contamination on the disc.	Check the disc and reload it, or use another disc for recording.	--
	DISC ERROR - C307, C308	Cannot Protect disc ON/OFF due to a scratch or contamination on the disc.	Check the disc and reload it, or use another disc for recording.	--
Title Menu	CANNOT EDIT	Editing cannot be performed due to a scratch or contamination on the disc.	Check the disc and reload it, or use another disc for recording.	--
	CANNOT EDIT - C408	Combining chapters cannot be performed.	Chapter marks that have been added automatically in the erasing of a scene procedure cannot be erased.	71
	PROCESSING PLEASE WAIT	A process requiring a longer time such as editing is being performed.	Wait until the process is complete.	--

Additional information

NOTE: Any error/warning message other than those above might appear. Take measures against such a message by seeing the possible solutions above.

Specifications

GENERAL

Power supply:	AC 120V 60Hz
Power consumption:	Operation: 29W Standby: 2.5W (if display window is off.)
Weight:	11.0 lbs (5.0 kg)
Dimensions:	Width : 16-15/16 inches (430 mm) Height : 3-5/8 inches (91.5 mm) Depth : 13-3/16 inches (335.5 mm)
Operating temperature:	41°F to 95°F (5°C to 35°C)
Operating humidity:	Less than 80% RH
Inputs/Outputs:	
Video:	In: 1Vp-p/75 ohm Out: 1Vp-p/75 ohm
Audio:	In: -8dBm/50k ohm Out: -8dBm/1k ohm
Antenna:	UHF/VHF IN/OUT: 75 ohm coaxial

VCR section

Video head:	4 Rotary Heads
Audio track:	Hi-Fi Sound - 2 Tracks / MONO Sound - 1 Track
Tuner:	181 Channel Freq. Synthesized
	VHF 2-13
	UHF 14-69
	Cable TV 14-36 (A)-(W) 37-59 (AA)-(WW)
	60-85 (AAA)-(ZZZ) 86-94 (86)-(94)
	95-99 (A-5)-(A-1) 100-125 (100)-(125)
	01 (5A)
RF channel output:	Channel 3 or 4, Switchable
F.FWD/REW Time:	Approx. 1minute and 48 seconds (with T-120 Cassette Tape)(at+25°C)
Hi-Fi frequency response:	20Hz to 20,000Hz
Hi-Fi dynamic range:	More than 90dB

DVD section

Signal system:	NTSC
Applicable disc:	DVD (12cm, 8 cm [Self Recording/Playback only]), CD (12cm, 8cm)
Recording format:	DVD-Video Recording (VR mode) DVD-VIDEO (Video mode)
Recording discs:	DVD-RAM, DVD-RW, DVD-R
Recording time: (based on a 4.7GB disc)	XP: Approx. 60 min SP: Approx. 120 min LP: Approx. 240 min SLP: Approx. 360 min
Audio characteristics frequency response:	DVD: 4Hz - 22kHz CD: 4Hz - 20kHz
S/N Ratio:	90dB
Harmonic distortion:	Less than 1%
Wow and flutter:	Less than 0.01% Wrms
Dynamic range:	More than 90dB
Output:	Video : (RCA) 1 Vp-p/75 ohm Audio : (RCA) -12 dBm/1k ohm Digital Audio : 0.5Vp-p/75 ohm
Pickup:	CD : Wavelength: 780 nm Maximum output power: 8.5 mW DVD : Wavelength: 660 nm Maximum output power: 120 mW

ACCESSORIES:

Remote control (SE-R0227) x 1
75 ohm Coaxial Cable x 1
AUDIO/VIDEO Cable x 1
Battery R03/AAA x 2

- This model complies with the above specifications.
- Designs and specifications are subject to change without notice.
- This model may not be compatible with features and/or specifications that may be added in the future.



Limited warranty

Limited United States Warranty Digital Audio Video ("DAV") Product - Depot Repair Warranty

Toshiba America Consumer Products, L.L.C. ("TACP") makes the following limited warranties to original consumers in the United States. THESE LIMITED WARRANTIES EXTEND TO THE ORIGINAL CONSUMER PURCHASER OR ANY PERSON RECEIVING THIS DAV PRODUCT AS A GIFT FROM THE ORIGINAL CONSUMER PURCHASER AND TO NO OTHER PURCHASER OR TRANSFEREE.

DAV PRODUCTS PURCHASED IN THE U.S.A. AND USED ANYWHERE OUTSIDE OF THE U.S.A., INCLUDING, WITHOUT LIMITATION, CANADA AND MEXICO, ARE NOT COVERED BY THESE WARRANTIES.

DAV PRODUCTS PURCHASED ANYWHERE OUTSIDE OF THE U.S.A., INCLUDING, WITHOUT LIMITATION, CANADA AND MEXICO, AND USED IN THE U.S.A., ARE NOT COVERED BY THESE WARRANTIES.

Limited Ninety (90) Day Warranty on Labor

TACP warrants this DAV Product and its parts against defects in materials or workmanship for a period of ninety (90) days after the date of original retail purchase. DURING THIS PERIOD, TACP WILL, AT TACP'S OPTION, REPAIR OR REPLACE A DEFECTIVE PART WITH A NEW OR REFURBISHED PART WITHOUT CHARGE TO YOU FOR PARTS OR LABOR.

Limited One (1) Year Warranty on Parts

TACP further warrants the parts in this DAV Product against defects in materials or workmanship for a period of one (1) year after the date of original retail purchase. DURING THIS PERIOD, TACP WILL, AT TACP'S OPTION, REPAIR OR REPLACE A DEFECTIVE PART WITH A NEW OR REFURBISHED PART WITHOUT CHARGE TO YOU FOR THE PART, PROVIDED THAT IF A DEFECTIVE PART IS REPAIRED OR REPLACED AFTER NINETY (90) DAYS AFTER THE DATE OF ORIGINAL RETAIL PURCHASE, THE CONSUMER SHALL PAY ALL LABOR CHARGES INVOLVED IN THE REPAIR OR REPLACEMENT THEREOF.

Rental Units

The warranty for DAV Product rental units begins on the date of the first rental or thirty (30) days after the date of shipment to the rental firm, whichever comes first.

Commercial Units

DAV Products sold and used for commercial purposes have a limited warranty for all parts and labor, which warranty begins on the date of original retail purchase and ends on the date that is ninety (90) days thereafter.

Owner's Manual and Product Registration Card

Read this owner's manual thoroughly before operating this DAV Product.

Complete and mail the enclosed product registration card or register your DAV Product on-line at www.tacp.toshiba.com/service as soon as possible. By registering your DAV Product you will enable TACP to bring you new products specifically designed to meet your needs and help us to contact you in the unlikely event a safety notification is required under the U.S. Consumer Product Safety Act. Failure to complete and return the product registration card does not diminish your warranty rights.

Your Responsibility

THE ABOVE WARRANTIES ARE SUBJECT TO THE FOLLOWING CONDITIONS:

- (1) You must retain your bill of sale or provide other proof of purchase.
- (2) All warranty servicing of this DAV Product must be made by the Depot Warranty Repair Center specified by the TACP Consumer Solutions Center.
- (3) The warranties from TACP are effective only if the DAV Product is purchased and operated in the Continental U.S.A. or Puerto Rico.
- (4) Labor service charges for set installation, setup, adjustment of customer controls, and installation or repair of antenna systems are not covered by this warranty. Reception problems caused by inadequate antenna systems are your responsibility.
- (5) Warranties extend only to defects in materials or workmanship as limited above, and do not extend to any DAV Product or parts that have been lost or discarded by you or to damage to the DAV Product or parts caused by fires, misuse, accident, Acts of God (such as lightning or fluctuations in electric power), improper installation, improper maintenance, or use in violation of instructions furnished by TACP; use or malfunction through simultaneous use of this DAV Product and connected equipment; or to units that have been modified or had the serial number removed, altered, defaced, or rendered illegible.

Additional information



Limited warranty

How to Obtain Warranty Services

If, after following all of the operating instructions in this manual and checking the section "Troubleshooting," you find that service is needed:

- (1) For instructions on how to obtain warranty service for your DAV Product, contact TACP's Consumer Solution Center toll free at 1-800-631-3811.
- (2) You must include a copy or original bill of sale or other proof of purchase along with the entire DAV Product to the Depot Warranty Repair Center specified by the TACP Consumer Solutions Center. You are responsible for all inbound transportation and insurance charges for the DAV Product to the Depot Warranty Repair Center specified by the TACP Consumer Solutions Center.

For additional information, visit TACP's website:
www.tacp.toshiba.com

ALL WARRANTIES IMPLIED BY THE LAW OF ANY STATE OF THE U.S.A., INCLUDING THE IMPLIED WARRANTIES OF MERCHANTABILITY AND FITNESS FOR A PARTICULAR PURPOSE, ARE EXPRESSLY LIMITED TO THE DURATION OF THE LIMITED WARRANTIES SET FORTH ABOVE. WITH THE EXCEPTION OF ANY WARRANTIES IMPLIED BY THE LAW OF ANY STATE OF THE U.S.A. AS HEREBY LIMITED, THE FOREGOING WARRANTY IS EXCLUSIVE AND IN LIEU OF ALL OTHER WARRANTIES, GUARANTEES, AGREEMENTS, AND SIMILAR OBLIGATIONS OF TACP WITH RESPECT TO THE REPAIR OR REPLACEMENT OF ANY PARTS. IN NO EVENT SHALL TACP BE LIABLE FOR CONSEQUENTIAL OR INCIDENTAL DAMAGES (INCLUDING, BUT NOT LIMITED TO, LOST PROFITS, BUSINESS INTERRUPTION, OR MODIFICATION OR ERASURE OF RECORDED DATA CAUSED BY USE, MISUSE OR INABILITY TO USE THIS DAV PRODUCT).

No person, agent, distributor, dealer, or company is authorized to change, modify, or extend the terms of these warranties in any manner whatsoever. The time within which an action must be commenced to enforce any obligation of TACP arising under the warranty or under any statute or law of the United States or any state thereof is hereby limited to ninety (90) days from the date you discover, or should have discovered, the defect. This limitation does not apply to implied warranties arising under state law.

THIS WARRANTY GIVES YOU SPECIFIC LEGAL RIGHTS AND YOU MAY ALSO HAVE OTHER RIGHTS WHICH MAY VARY FROM STATE TO STATE IN THE U.S.A. SOME STATES OF THE U.S.A. DO NOT ALLOW LIMITATIONS ON HOW LONG AN IMPLIED WARRANTY LASTS, WHEN AN ACTION MAY BE BROUGHT, OR THE EXCLUSION OR LIMITATION OF INCIDENTAL OR CONSEQUENTIAL DAMAGES, SO THE ABOVE PROVISIONS MAY NOT APPLY TO YOU UNDER SUCH CIRCUMSTANCES.



TOSHIBA

TOSHIBA AMERICA CONSUMER PRODUCTS, L.L.C.



Printed in Thailand

Free Manuals Download Website

<http://myh66.com>

<http://usermanuals.us>

<http://www.somanuals.com>

<http://www.4manuals.cc>

<http://www.manual-lib.com>

<http://www.404manual.com>

<http://www.luxmanual.com>

<http://aubethermostatmanual.com>

Golf course search by state

<http://golfingnear.com>

Email search by domain

<http://emailbydomain.com>

Auto manuals search

<http://auto.somanuals.com>

TV manuals search

<http://tv.somanuals.com>