

ClimaDry Whole House
Dehumidification Option

Tranquility 27
Tranquility 20

Applications Guide
97B0051N01
Revision: 18 April, 2008B

Table of Contents

Model Nomenclature Example	2	ClimaDry Schematic	7
ClimaDry Overview	3	TT Blower Data	8
ClimaDry Benefits	3	TS ECM Blower Data	9
ClimaDry Features	3	TS PSC Blower Data	10
ClimaDry Applications	3	Reheat Coil Pressure Drop Table	11
ClimaDry Sequence of Operation	5	TS Air Coil Face Area Table	11
ClimaDry Component Functions	6	Wiring Diagram	12
ClimaDry Application Considerations	6	Flushing/Purging Units	13
		Revision History	14

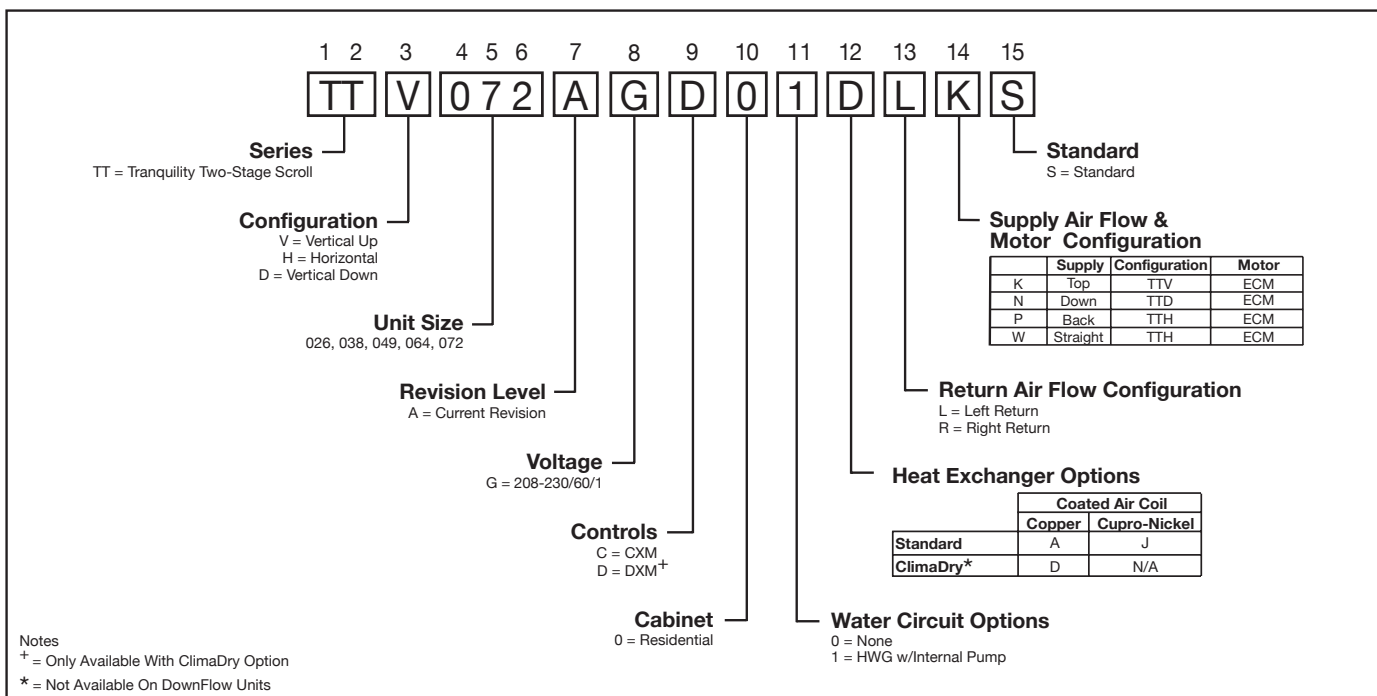

Rev.: 18 April, 2008B

⚠ CAUTION! ⚠

Water Source Heat Pump systems (including Water Loop Heat Pump systems) must have antifreeze protection to 20°F [-6.7°C] for ClimaDry applications. The ClimaDry option MUST NOT be used on open water loop systems, or any system without antifreeze protection.

Notes:

1. ClimaDry reheat option must be ordered with original equipment (cannot be field added). Unit must have DXM control. Not available for units with internal water valve, or flow regulator options. Check unit product catalog for limitations and specific requirements.
2. ClimaDry cannot be used on open loop systems, only closed loop systems.
3. ClimaDry systems must use appropriate antifreeze solutions.
4. ClimaDry is not recommended for applications with poor water quality (see water quality guidelines in unit IOM). The copper heat exchanger with cast iron pump (standard ClimaDry option) are designed for closed loop systems.
5. Max working water pressure for the ClimaDry option is 145psig.
6. Available with TT, TS models. Check unit product catalog data nomenclature for models with ClimaDry reheat option.
7. Thermostat must be either:
 1. Thermostat with dehumidification mode (similar to ATA32U02)
 2. Thermostat and separate humidistat or dehumidistat controller (see Table 3 for DXM DIP settings).
8. ClimaDry units must have minimum entering air temperature of 70°F DB / 61°F WB

Overview

ClimaDry™ Whole House Dehumidification Overview

Indoor Air Quality (IAQ) and Relative Humidity (RH) are increasingly becoming design issues that must be addressed by selecting heating and cooling equipment with advanced capabilities. The ClimateMaster ClimaDry™ reheat option (patent pending) offers unique features unlike anything currently available today.

ClimateMaster's ClimaDry reheat option is an innovative means of providing modulating reheat without the complication of refrigeration controls. ClimaDry is Hot Gas Generated Reheat, which utilizes one of the biggest advantages of a water source heat pump (WSHP), the transfer of energy through the loop piping system. ClimaDry simply diverts condenser water through a water-to-air coil that is placed after the evaporator coil. If condenser water is not warm enough, the internal "run-around" loop increases the water temperature with each pass through the condenser coil.

ClimaDry Benefits

ClimaDry is like no other reheat option on the market. Proportional reheat is controlled to the desired leaving air temperature set point (factory set point of 72°F, [22°C]), no matter what the loop temperature is. Since dehumidification operation will occur under less than full load cooling conditions a good percentage of the time, it is important to have a reheat function that provides 100% reheat in the spring and fall when the loop is cool. Supply air temperature is field adjustable to +/- 3°F [+/- 1.7°C] for even greater flexibility with an optional potentiometer.

Competitors without ClimaDry typically use an on/off (non-modulating) refrigeration based reheat circuit, typically referred to as "Hot gas reheat" (HGR). HGR needs higher condensing temperatures to work well, typically 85°F [29°C] entering water temperature (EWT). With HGR, cooler water temperatures produce cooler supply air temperatures, which could overcool the space, requiring additional space heating from another source or a special auto-change-over relay to allow the unit to switch back and forth between reheat and heating. Rarely does HGR provide 100% reheat, like ClimaDry.

A key benefit to ClimaDry is a simple and easy to troubleshoot refrigerant circuit. No switching valves or hard to diagnose leaky check valves are utilized. No unusual refrigerant pressures occur during the reheat mode. The ClimaDry refrigerant circuit is like every other ClimateMaster unit (without reheat), so everything the technician already knows applies to troubleshooting the ClimaDry refrigeration circuit. Plus, the water loop portion of the ClimaDry option is easy to understand and diagnose.

Features Include:

- Modulating reheat for precise control of supply air temperatures
- 100% reheat (operates as a whole house dehumidifier)
- "Neutral" supply air temperature even at part load (non-design) conditions
- Supply air temperature adjustment, +/- 3°F [+/-1.7°C] from 72°F [22°C] factory setpoint with optional potentiometer
- Integrated factory supplied reheat controls – simply attach a humidistat or dehumidistat
- Microprocessor (DXM) controls standard
- Ultra simple refrigeration circuit
- All water system eliminates refrigeration circuit modifications (same refrigeration circuit as units without ClimaDry)
- Stable refrigeration pressures, even at low EWTs
- All components located inside the cabinet
- Moves heat of rejection from ground loop to supply air stream

Availability

ClimaDry is currently available on ClimateMaster residential Tranquility27™ (TT) and Tranquility20™ (TS) series units (vertical and horizontal units only).

ClimaDry Applications

With the ClimaDry option, return air from the space is conditioned by the air-to-refrigerant (evaporator) coil, then reheated by the water-to-air (reheat) coil to dehumidify the air, but maintain the same space temperature (thus operating as a whole house dehumidifier). The moisture removal capability of the heat pump is determined by the unit's latent capacity rating. Latent Capacity (LC) equals Total Capacity (TC) minus Sensible Capacity (SC). For example, at 85°F [29°C] EWT, the moisture removal capability (latent capacity) of a ClimateMaster size 036 heat pump is 9.6 MBtuh [2.8kW] as shown in figure 1.

Dividing the latent capacity by 1,069 BTU/LB of water vapor at 80°F DB and 67°F WB [26.7°C DB and 19.4°C WB] moist air enthalpy, converts the amount of moisture removal to pounds per hour (multiply pounds per hour by 0.4536 to obtain kg/hr). Calculations are shown in figure 1. Most ClimateMaster heat pumps have a sensible-to-total (S/T) ratio of 0.72 to 0.76. Therefore, approximately, 25% of the cooling capacity is dedicated to latent cooling capacity (moisture removal). When selecting a unit with ClimaDry, the space sensible and latent loads should be calculated. If the unit will be used for space cooling, a unit with at least enough capacity to satisfy the building sensible load should be selected. If the latent cooling load is not satisfied by the selection, a larger unit with enough latent capacity will be required. The ClimaDry Option can be used for the additional moisture load. If the unit will be used for dehumidification purposes only, the latent capacity is

the only consideration necessary. In this case, sensible load is immaterial. Example latent capacities for a typical ClimateMaster heat pump are shown in table 1. ClimaDry is especially useful in Northern Climates, where the heat pump may be oversized in the cooling mode to provide enough heating capacity. Units with ClimaDry will compensate for these applications by operating as a whole house dehumidifier when necessary to maintain space Relative Humidity (RH).

Since the ClimaDry option is internal to the unit, installation is much easier than a separate whole house dehumidifier. Plus, an additional compressor and controls can be eliminated, simplifying the system and lowering operating and installation costs.

Table 1: Typical Unit Latent capacity

Latent Capacity at 85°F [29.4°C] EWT				
Size	MBtuh	lbs/hr	kW	kg/hr
18	4.7	4.4	1.4	2.0
24	6.1	5.7	1.8	2.6
30	6.8	6.4	2.0	2.9
36	9.6	9.0	2.8	4.1
42	11.0	10.3	3.2	4.7
48	12.7	11.9	3.7	5.4
60	15.2	14.2	4.5	6.4
70	16.9	15.8	5.0	7.2

Figure 1: Example Size 036 Performance

Performance Data
Model 036

$$LC = TC - SC = 35.6 - 26.0 = 9.6 \text{ MBtuh}$$

$$9600 \text{ Btuh} \div 1069 = 8.9 \text{ lbs/hr (4.0 kg/hr)}$$

1200 CFM Nominal Airflow

Performance capacities shown in thousands of Btuh

EWT °F	GPM	WPD			COOLING - EAT 80/67 °F						HEATING - EAT 70 °F				
		PSI	FT	TC	SC	Sens/Tot Ratio	KW	HR	EER	HC	KW	HE	LAT	COP	
60	4.5	1.8	4.1	38.2	28.8	0.70	2.74	47.6	14.0	39.0	2.94	28.9	100.1	3.88	
	6.8	3.2	7.4	39.1	28.9	0.89	2.58	47.8	15.1	41.4	3.03	31.0	101.9	4.00	
	9.0	5.1	11.8	39.8	27.1	0.89	2.50	47.8	15.7	42.6	3.07	32.1	102.9	4.06	
70	4.5	1.7	3.9	38.8	28.3	0.72	2.95	48.6	12.4	43.9	3.12	33.3	103.9	4.12	
	6.8	3.1	7.2	37.8	28.7	0.71	2.80	47.3	13.5	46.2	3.21	35.2	105.6	4.22	
	9.0	4.9	11.3	38.3	28.8	0.70	2.72	47.6	14.1	47.2	3.25	36.1	106.4	4.26	
80	4.5	1.7	3.8	38.4	25.6	0.74	3.15	45.1	10.9	47.9	3.28	36.7	107.0	4.28	
	6.8	3.0	7.0	35.9	25.2	0.73	3.01	46.2	11.9	49.7	3.36	38.2	108.3	4.34	
	9.0	4.8	11.0	36.7	26.4	0.72	2.94	46.7	12.5	50.5	3.40	38.9	108.9	4.35	
85	4.5	1.6	3.8	33.1	25.0	0.76	3.24	44.1	10.2	49.5	3.35	38.1	108.2	4.33	
	6.8	3.0	6.9	34.8	25.3	0.74	3.11	45.4	11.2	50.9	3.42	39.3	109.3	4.36	
	9.0	4.7	10.9	35.6	26.0	0.73	3.05	46.0	11.7	51.5	3.45	39.7	109.7	4.37	
90	4.5	1.6	3.7	31.6	24.3	0.77	3.34	43.0	9.5	50.8	3.41	39.1	109.2	4.36	
	6.8	2.9	6.8	33.5	25.2	0.75	3.21	44.5	10.4	51.8	3.47	39.9	110.0	4.37	
	9.0	4.6	10.7	34.4	25.6	0.74	3.15	45.1	10.9	52.1	3.50	40.2	110.2	4.38	
95	4.5	1.6	3.7	30.1	23.5	0.78	3.43	41.8	8.8	Operation Not Recommended					
	6.8	2.9	6.7	32.0	24.6	0.77	3.31	43.3	9.7						
	9.0	4.6	10.6	33.0	25.0	0.76	3.25	44.1	10.2						

Dividing the latent capacity by 1,069 BTU/LB of water vapor at 80°F DB and 67°F WB [26.7°C DB and 19.4°C WB] moist air enthalpy, converts the amount of moisture removal to pounds per hour (multiply pounds per hour by 0.4536 to obtain kg/hr). Calculations are shown in figure 1.

ClimaDry Sequence Of Operation

A heat pump equipped with ClimaDry can operate in three modes; cooling, cooling with reheat, and heating. The cooling/heating modes are like any other ClimateMaster WSHP. The reversing valve (“O” signal) is energized in cooling, along with the compressor contactor(s) and blower relay. In the heating mode the reversing valve is de-energized. Almost any thermostat will activate the heat pump in heating or cooling modes. The DXM microprocessor board, which is standard with the ClimaDry option, will accept either heat pump (Y,O) thermostats or non-heat pump (Y,W) thermostats (see CXM/DXM AOM for detailed DXM information).

The reheat mode requires either a separate humidistat/dehumidistat or a thermostat that has an integrated dehumidification function for activation. The DXM board is configured to work with either a humidistat or dehumidistat input to terminal “H” (DIP switch settings for the DXM board are shown below in table 2). Upon receiving an “H” input, the DXM board will activate the cooling mode and engage reheat. Table 3 shows the relationship between thermostat input signals to the DXM board and unit operation.

There are five operational inputs for single stage units and seven operational inputs for two stage units:

- Fan Only
- 1st Stage Cooling
- 2nd Stage Cooling
- 1st Stage Heating
- 2nd Stage Heating
- 3rd Stage Heating (If applicable)
- Reheat Mode

- Fan Only: A (G) call from the thermostat to the (G) terminal of the DXM control board will bring the unit on in fan only mode.
- 1st Stage Cooling: A simultaneous call from (G), (Y1), and (O) to the (G), (Y1), (O/W2) terminals of the DXM control board will bring the unit on in 1st Stage Cooling.

Table 2: Humidistat/Dehumidistat Logic and DXM 2.1, 2.2., 2.3 DIP settings

Sensor	2.1	2.2	2.3	Logic	Reheat (ON) - H	Reheat (OFF) - H
Humidistat	OFF	OFF	OFF	Reverse	0 VAC	24 VAC
Dehumidistat	OFF	ON	OFF	Standard	24 VAC	0 VAC

Table 3: ClimaDry Operating Modes

Mode	Input						Output					
	O	G	Y1	Y2 ³	W	H	O	G	Y1	Y2 ³	Backup Elec Heat	Reheat
No Demand	ON/OFF ⁵	OFF	OFF	OFF	OFF	OFF	ON/OFF ⁵	OFF	OFF	OFF	OFF	OFF
Fan Only	ON/OFF ⁵	ON	OFF	OFF	OFF	OFF	ON/OFF ⁵	ON	OFF	OFF	OFF	OFF
Cooling 1st Stage	ON	ON	ON	OFF	OFF	OFF	ON	ON	ON	OFF	OFF	OFF
Cooling 2nd Stage	ON	ON	ON	ON	OFF	OFF	ON	ON	ON	ON	OFF	OFF
Cooling & Dehumidistat ¹	ON	ON	ON	ON/OFF ⁵	OFF	ON	ON	ON	ON	ON/OFF ⁵	OFF	OFF
Dehumidistat Only	ON/OFF ⁵	OFF	OFF	OFF	OFF	ON	ON	ON	ON	ON	OFF	ON
Heating 1st Stage	OFF	ON	ON	OFF	OFF	OFF	OFF	ON	ON	OFF	OFF	OFF
Heating 2nd Stage	OFF	ON	ON	ON	ON/OFF ⁵	OFF	OFF	ON	ON	ON	ON/OFF ⁵	OFF
Heating 3rd Stage ⁴	OFF	ON	ON	ON	ON ⁴	OFF	OFF	ON	ON	ON	ON ⁴	OFF
Heating & Dehumidistat ²	OFF	ON	ON	ON/OFF ⁵	ON/OFF ⁵	ON	OFF	ON	ON	ON/OFF ⁵	ON/OFF ⁵	OFF

¹Cooling input takes priority over dehumidify input.

²DXM is programmed to ignore the H demand when the unit is in heating mode.

³N/A for single stage units; Full load operation for dual capacity units.

⁴Single stage unit: W = 2nd Stage backup elec. heat; Two-Stage units: W = 3rd stage backup elec. heat.

⁵ON/OFF = Either ON or OFF.

- 2nd Stage Cooling: A simultaneous call from (G), (Y1), (Y2), and (O) to the (G), (Y1), (Y2), and (O/W2) terminals of the DXM control board will bring the unit on in 2nd Stage Cooling. When the call is satisfied at the thermostat the unit will continue to run in 1st Stage Cooling until the 1st Stage Cooling call is removed or satisfied, shutting down the unit.

NOTE: Not all units have two-stage cooling functionality.

- 1st Stage Heating: A simultaneous call from (G) and (Y1) to the (G) and (Y1) terminals of the DXM control board will bring the unit on in 1st Stage Heating.
- 2nd Stage Heating: A simultaneous call from (G), (Y1), and (Y2) to the (G), (Y1), and (Y2) terminals of the DXM control board will bring the unit on in 2nd Stage Heating. When the call is satisfied at the thermostat the unit will continue to run in 1st Stage Heating until the call is removed or satisfied, shutting down the unit.

NOTE: Not all units have two-stage heating functionality. 2nd stage heating for units with PSC fan and single stage compressor is auxiliary electric heat (Y, W1, G).

- 3rd Stage Heating (ECM fan models only): A simultaneous call from (G), (Y1), (Y2), and (W) terminals to the (G), (Y1), (Y2), and (W1) terminals of the DXM board will bring the unit on in 3rd Stage Heating (compressor plus auxiliary electric heat).
- Reheat Mode: A call from the Humidistat/ Dehumidistat to the (H) terminal of the DXM control board will bring the unit on in Reheat Mode if there is no call for cooling. When the Humidistat/ Dehumidification call is removed or satisfied the unit will shut down.

NOTE: Cooling always overrides Reheat Mode. In the Cooling mode, the unit cools and dehumidifies. If the cooling thermostat is satisfied but there is still a call for dehumidification, the unit will continue to operate in Reheat Mode.

ClimaDry Component Functions

The ClimaDry option consists of the following components:

- Proportional Controller
- Supply Air Sensor
- Motorized Valve
- Internal Loop Pump
- Hydronic Reheat Coil

The Proportional Controller operates on a 24 VAC power supply and automatically adjusts the water valve based upon the Supply Air Sensor. The Supply Air Sensor senses supply air temperature at the blower inlet providing the input signal necessary for the proportional control to drive the motorized valve during the reheat mode of operation. The Motorized Valve is a proportional actuator/three-way valve combination used to divert the condenser water from the coax to the hydronic

reheat coil during the reheat mode of operation. The proportional controller sends a signal to the motorized valve based on the supply air temperature. The internal loop pump circulates condenser water through the hydronic reheat coil during the reheat mode of operation. In this application, the internal loop pump is only energized during the reheat mode. The Hydronic Coil is utilized to reheat the air to the setpoint of the proportional controller. Condenser water is diverted by the motorized valve and pumped through the hydronic reheat coil by the internal loop pump in proportion to the control setpoint. The amount of reheating is dependent on the setpoint and how far from setpoint the supply air temperature is. The factory setpoint is 72°F [22°C], generally considered “neutral” air.

ClimaDry Application Considerations

The reheat coil adds a small amount of resistance to the air stream. Consult the correction tables on page 8 of this manual for details.

Unlike most hot gas reheat options, the ClimaDry option will operate over a wide range of EWTs. Special flow regulation (water regulating valve) is not required for low EWT conditions. Temporary, slight overcooling of the space may result on rare occasions with ground loop (geothermal) systems during extremely low EWT conditions. Since dehumidification is generally only required in cooling, most ground loop systems will not experience these conditions.

Water-Source Heat Pumps with ClimaDry should not be used as make-up air units. These applications require equipment specifically designed for make-up air.

⚠ CAUTION! ⚠

Water Source Heat Pump systems (including Water Loop Heat Pump systems) must have antifreeze protection to 20°F [-6.7°C] for ClimaDry applications. The ClimaDry option MUST NOT be used on open water loop systems, or any system without antifreeze protection.

Figure 2: ClimaDry Schematic

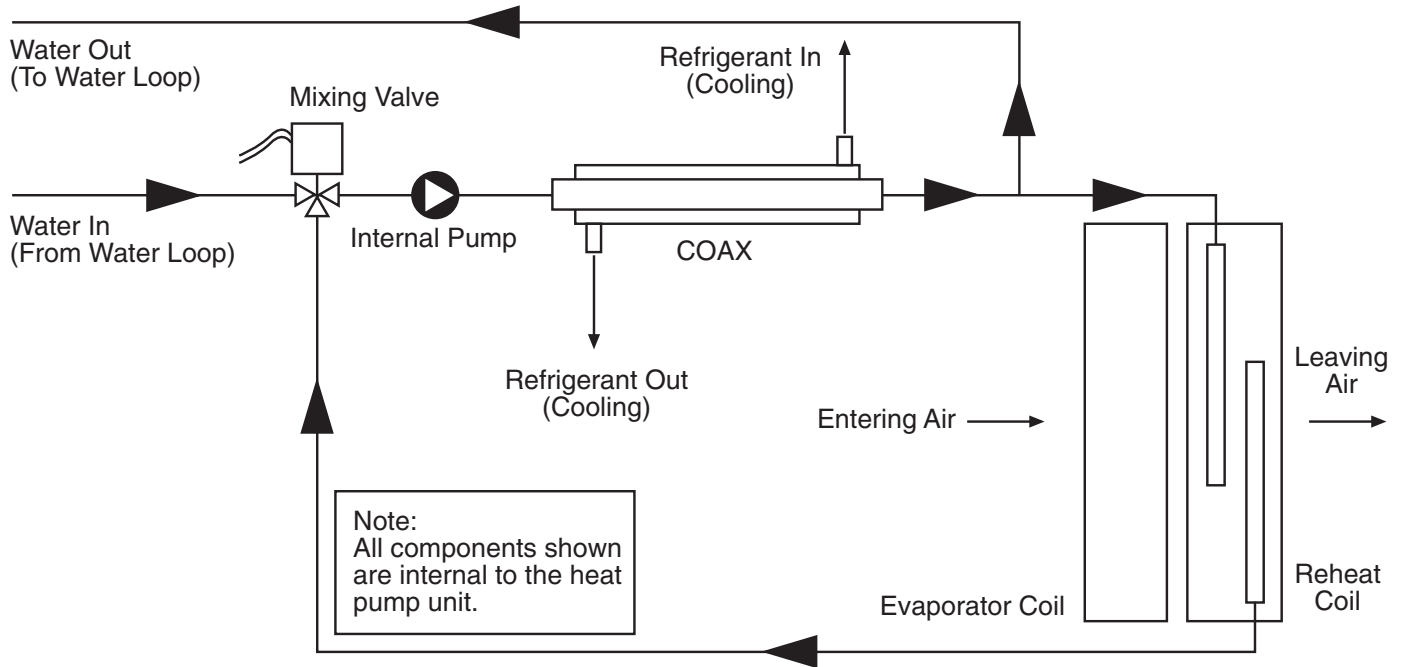

Table 4: Tranquility 27™ Blower Performance Data

Airflow in CFM with wet coil and clean air filter													Residential Units Only	
Model	Max ESP (in. wg)	Fan Motor (hp)	Tap Setting	Cooling Mode			Dehumid Mode			Heating Mode			AUX CFM	Aux/ Emerg Mode
				Stg 1	Stg 2	Fan	Stg 1	Stg 2	Fan	Stg 1	Stg 2	Fan		
026	0.50	1/2	4	810	950	475	630	740	475	920	1060	475	4	1060
	0.50	1/2	3	725	850	425	560	660	425	825	950	425	3	950
	0.50	1/2	2	620	730	370	490	570	370	710	820	370	2	820
	0.50	1/2	1	520	610	300				600	690	300	1	690
038	0.50	1/2	4	1120	1400	700	870	1090	700	1120	1400	700	4	1400
	0.50	1/2	3	1000	1250	630	780	980	630	1000	1250	630	3	1350
	0.50	1/2	2	860	1080	540	670	840	540	860	1080	540	2	1350
	0.50	1/2	1	730	900	450				730	900	450	1	1350
049	0.75	1	4	1460	1730	870	1140	1350	870	1560	1850	870	4	1850
	0.75	1	3	1300	1550	780	1020	1210	780	1400	1650	780	3	1660
	0.75	1	2	1120	1330	670	870	1040	670	1200	1430	670	2	1430
	0.75	1	1	940	1120	560				1010	1200	560	1	1350
064	0.75	1	4	1670	2050	1020	1300	1600	1020	1860	2280	1020	4	2280
	0.75	1	3	1500	1825	920	1160	1430	920	1650	2050	920	3	2040
	0.75	1	2	1280	1580	790	1000	1230	790	1430	1750	790	2	1750
	0.75	1	1	1080	1320	660				1200	1470	660	1	1470

Factory shipped on Tap Setting 2
 During Auxiliary operation (residential units only) the CFM will run at the higher of the heating or AUX settings
 Airflow is controlled within +/- 5% up to Max ESP shown with wet coil and standard filter

Tranquility 27™ (TT) Series with ClimaDry Reheat Option

All Tranquility 27™ (TT) units have an ECM fan motor as a standard feature. The small additional pressure drop of the reheat coil causes the ECM motor to slightly increase RPM to overcome the added pressure drop, and maintain selected CFM up to the maximum ESP.

Table 5: Tranquility 20™ ECM Blower Performance Data

Airflow in CFM with wet coil and clean air filter

Model	Max ESP (in. wg)	Fan Motor (hp)	Tap Setting	Cooling Mode			Dehumid Mode			Heating Mode			Residential Units Only	
				Stg 1	Stg 2	Fan	Stg 1	Stg 2	Fan	Stg 1	Stg 2	Fan	AUX CFM	Aux/ Emerg Mode
				018	0.50	1/2	4	620	750	380	480	590	380	620
			3	570	700	350	450	550	350	570	700	350	3	700
			2	510	620	310	400	480	310	510	620	310	2	650
			1	430	530	270				430	530	270	1	650
024	0.50	1/2	4	780	950	470	610	740	470	870	1060	470	4	1060
			3	700	850	420	540	660	420	780	950	420	3	950
			2	630	770	360	490	600	360	670	820	390	2	820
			1	550	670	300				570	690	340	1	690
030	0.50	1/2	4	920	1130	560	720	880	560	1000	1230	560	4	1230
			3	820	1000	500	640	780	500	900	1100	500	3	1100
			2	740	900	450	580	700	450	800	980	450	2	980
			1	660	800	400				700	850	400	1	850
036	0.50	1/2	4	1150	1400	700	900	1090	700	1150	1400	700	4	1400
			3	1020	1250	630	800	980	630	1020	1250	630	3	1350
			2	890	1080	540	690	840	540	890	1080	540	2	1350
			1	740	900	450				750	920	450	1	1350
042	0.50	1/2	4	1290	1580	790	1010	1230	790	1290	1580	790	4	1580
			3	1150	1400	700	900	1090	700	1150	1400	700	3	1400
			2	1050	1280	640	820	1000	640	1020	1240	640	2	1350
			1	920	1120	560				900	1080	560	1	1350
048	0.75	1	4	1420	1730	870	1110	1350	870	1520	1850	865	4	1850
			3	1270	1550	780	990	1210	780	1350	1650	775	3	1650
			2	1180	1440	720	920	1120	720	1190	1450	720	2	1450
			1	1050	1280	640				1020	1250	640	1	1350
060	0.75	1	4	1680	2050	1030	1310	1600	1030	1870	2280	1030	4	2280
			3	1500	1830	910	1170	1420	910	1680	2050	910	3	2050
			2	1400	1700	850	1090	1330	850	1480	1800	850	2	1800
			1	1300	1580	790				1270	1550	790	1	1550
070	0.75	1	4	1830	2230	1100	1420	1740	1100	1830	2230	1100	4	2230
			3	1600	1950	980	1250	1520	980	1720	2100	980	3	2100
			2	1440	1750	880	1120	1360	880	1670	1950	880	2	1950
			1	1200	1580	790				1460	1780	790	1	1780

See ECM control section for details on setting taps.

Tranquility 20™ (TS) Series with ClimaDry Reheat Option (ECM Motor)

All Tranquility 20™ (TS) units with optional ECM fan motor automatically adjust for the reheat coil. The small additional pressure drop of the reheat coil causes the ECM motor to slightly increase RPM to overcome the added pressure drop, and maintain selected CFM up to the maximum ESP.

Table 6: Tranquility 20™ (TS) Series PSC Blower Performance Data (Without ClimaDry)

Model	Fan Speed	Rated Airflow	Min CFM	Airflow (cfm) at External Static Pressure (in. wg)															
				0.00	0.05	0.10	0.15	0.20	0.25	0.30	0.35	0.40	0.45	0.50	0.60	0.70	0.80	0.90	1.00
018	HI	600	450	704	708	711	702	693	692	690	683	675	658	640	598	515			
	MED	600	450	602	601	599	590	581	583	585	579	573	560	547	492				
	LOW	600	450	531	529	527	522	517	512	506	501	495	479	462					
024	HI	850	600	965	960	954	943	931	923	914	898	882	862	842	794	725	635		
	MED	850	600	841	833	825	817	809	800	790	777	763	747	731	686	623			
	LOW	850	600	723	715	707	703	698	689	680	668	656	642	627					
030	HI	950	750	1271	1250	1229	1207	1185	1164	1143	1118	1093	1061	1029	953	875	753		
	MED	950	750	1048	1037	1025	1016	1007	994	981	962	943	915	886	822				
	LOW	950	750	890	887	884	879	874	865	855	842	829	809	789					
036	HI	1250	900	1411	1407	1402	1390	1378	1370	1361	1326	1290	1248	1205	1083	942			
	MED	1250	900	1171	1164	1156	1145	1133	1113	1092	1064	1035	997	958					
	LOW	1250	900	983	967	950	943	936	936										
042	HI	1400	1050	1634	1626	1618	1606	1594	1583	1571	1539	1507	1464	1420	1265	1078			
	MED	1400	1050	1332	1323	1314	1298	1282	1263	1243	1206	1169	1115	1060					
	LOW	1400	1050	1130	1109	1088	1086	1084	1066	1048	1052	1055							
048	HI	1600	1200	1798	1781	1764	1738	1711	1688	1665	1630	1595	1555	1514	1420	1239			
	MED	1600	1200	1384	1382	1379	1375	1371	1356	1341	1318	1294	1261	1227					
	LOW	1600	1200																
060	HI	1950	1500	2311	2306	2300	2290	2279	2268	2257	2233	2209	2175	2140	2088	1990	1901	1856	1752
	MED	1950	1500	2058	2049	2039	2028	2016	2000	1983	1966	1949	1935	1920	1874	1807	1750	1670	1582
	LOW	1950	1500	1868	1863	1858	1858	1858	1848	1838	1822	1806	1799	1792	1749	1699	1636	1570	
070	HI	2100	1800	2510	2498	2486	2471	2455	2440	2424	2401	2377	2348	2318	2247	2161	2078	1986	1855
	MED	2100	1800	2171	2167	2162	2162	2162	2158	2153	2135	2117	2101	2085	2024	1971	1891	1823	
	LOW	2100	1800	2010	2008	2006	2006	2006	2006	2006	2006	1992	1977	1962	1947	1892	1851		

Black areas denote ESP where operation is not recommended.
 Units factory shipped on medium speed. Other speeds require field selection.
 All airflow is rated and shown above at the lower voltage if unit is dual voltage rated, e.g. 208V for 208-230V units.

Table 7: ClimaDry Reheat Coil Pressure Drop - TS Units (PSC Motor)

Coil Face Velocity FPM	TSH/V/D with Reheat ESP Loss				
	TSH/V/D 018 In. of Water	TSH/V/D 024, 030 In. of Water	TSH/V/D 036 In. of Water	TSH/V/D 042, 048 In. of Water	TSH/V/D 060, 070 In. of Water
200	0.037	0.033	0.031	0.028	0.026
250	0.052	0.046	0.042	0.038	0.034
300	0.077	0.066	0.059	0.051	0.044
350	0.113	0.096	0.085	0.073	0.061
400	0.181	0.160	0.145	0.131	0.117
450	0.242	0.226	0.215	0.205	0.194
500	0.360	0.345	0.335	0.326	0.316

For TS units with ClimaDry Reheat coil applications, calculate face velocity of the entering air. From the table above, find ESP for Reheat application. The loss includes wet coil loss.

Example:

Reheat coil pressure drop can be determined from the above table. Coil velocity (FPM) = Airflow (CFM) / Face Area (sq. ft.).

- 1) TSH036 has a face area of 4.86 sq. ft. (see physical data table in I.O.M.).
- 2) At 1,100 cfm, coil velocity (FPM) = 1,100 / 4.86 = 226 FPM.
- 3) From above table, it will be necessary to subtract 0.037 from the blower performance ESP.
- 4) On medium speed, the TSH036 (without reheat - see blower table) can deliver 1,100 CFM at 0.28 in. wg. with the standard PSC motor; with the reheat coil, it now delivers 1,085 CFM at 0.28 in. wg. or 1,100 CFM at 0.24 in. wg.
- 5) If the decrease in airflow is acceptable, no changes are necessary. Otherwise, high speed fan should be used to overcome the pressure drop of the reheat coil.

Table 8: TS Air Coil Face Area

Model	018		024		030		036		042		048		060		070	
	Horiz.	Vert.	Horiz.	Vert.	Horiz.	Vert.	Horiz.	Vert.	Horiz.	Vert.	Horiz.	Vert.	Horiz.	Vert.	Horiz.	Vert.
Coil Face Area, sq. ft. (sq. m)	3.38 (0.3135)	3.33 (0.3097)	3.88 (0.3600)	3.89 (0.3613)	3.88 (0.3600)	3.89 (0.3613)	4.86 (0.4516)	4.86 (0.4516)	5.56 (0.5161)	5.56 (0.5161)	5.56 (0.5161)	5.56 (0.5161)	6.25 (0.5806)	6.25 (0.5806)	6.25 (0.5806)	6.25 (0.5806)

Flushing/Purging Units with ClimaDry

Units equipped with ClimaDry must be flushed/purged with a flush cart. Detailed general flushing /purging instruction can be found in the Flow Controller III IOM. **The unit must be powered (but not operating) during flushing/purging. Unit power is required to operate the three-way modulating valve during flushing.**

When flushing/purging units equipped with ClimaDry the earth loop should be fully flushed/purged before attempting to flush/purge the heat pump. Once the earth loop is flushed, position the flushing valves to flush the heat pump. Then with flushing flow re-directed through the unit, energize the modulating three-way dehumidification valve to allow flow through the dehumidification hydronic circuit.

Energize the modulating three-way dehumidification valve by removing the red wire from the ACC1 'N.O.' terminal on the DXM board. Connect this wire to the ACC1 'NC' terminal of the DXM controller, as shown in figure 1, to energize the modulating three-way dehumidification valve. Once energized, the valve will take 45 – 75 seconds to fully shift. Continue flushing during this time. After the valve has completed its shift, use the air bleed from the top of the reheat coil to purge air from the coil.

Note, if the ClimaDry sensor, located in the supply air stream is above 70°F it must be disabled to allow the modulating valve to shift. Disable this sensor by removing the white wire from the Low Voltage Terminal Block (LVTB) shown in figure 1.

Under extreme circumstances this procedure may be required multiple times to purge all air from the circuit. After completing the flushing/purging procedure, restore the red wire to the ACC1 'N.O.' terminal on the DXM for normal operation. Return the white sensor wire to the LVTB, if it was removed, as shown in figure 2.

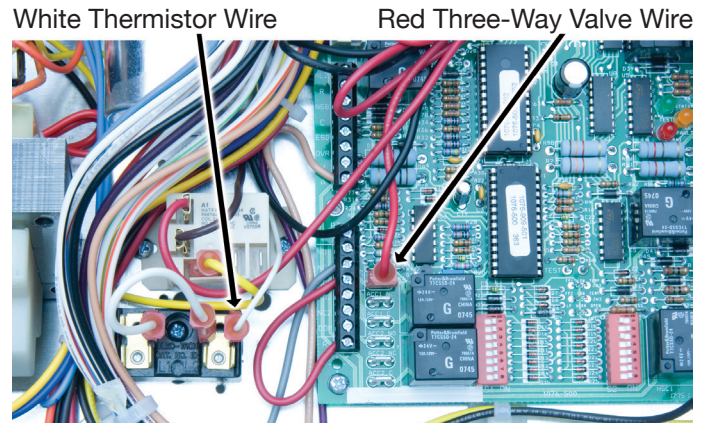
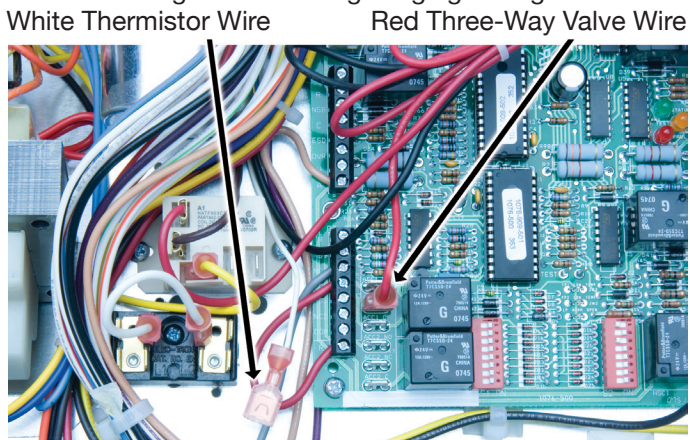

Figure 2. Normal Unit Wiring

Extra care must be taken when using non-pressurized flow centers to ensure all air is removed from the unit and no additional air is allowed into the system. If air is allowed to collect in the ClimaDry piping, nuisance trips may occur. Additional flush/purge cycles may be used when required.

Figure 1. Flushing/Purging Wiring



De-energize the valve by removing the red wire from the ACC1 'NC' terminal on the DXM board. The valve will spring return to its normal position in just a few seconds. After the valve has fully returned, repeat the process of running the valve through its cycle and purging air from the reheat coil.

Revision Log:

Date	Page #	Description
18 April, 2008	All	First Published



97B0051N01

97B0051N01



35 Earl Martin Dr.
Elmira, ON N3B 3L4
Phone: 800-367-9810
Fax: 877-684-3112
www.nextenergy.ca

ClimateMaster works continually to improve its products. As a result, the design and specifications of each product at the time for order may be changed without notice and may not be as described herein. Please contact ClimateMaster's Customer Service Department at 1-405-745-6000 for specific information on the current design and specifications. Statements and other information contained herein are not express warranties and do not form the basis of any bargain between the parties, but are merely ClimateMaster's opinion or commendation of its products.

The management system governing the manufacture of ClimateMaster's products is ISO 9001:2000 certified.

Free Manuals Download Website

<http://myh66.com>

<http://usermanuals.us>

<http://www.somanuals.com>

<http://www.4manuals.cc>

<http://www.manual-lib.com>

<http://www.404manual.com>

<http://www.luxmanual.com>

<http://aubethermostatmanual.com>

Golf course search by state

<http://golfingnear.com>

Email search by domain

<http://emailbydomain.com>

Auto manuals search

<http://auto.somanuals.com>

TV manuals search

<http://tv.somanuals.com>