



TOSHIBA



19-inch* Diagonal LCD TV/DVD COMBINATION

19HLV87

OWNER'S MANUAL

- Introduction **2**
- Connections **14**
- Basic setup **22**
- TV operation **25**
- Basic playback **47**
- Advanced playback **50**
- Function setup **63**
- Others **71**



Owner's Record

The model number and serial number are on the back of your TV. Record these numbers in the spaces below. Refer to these numbers whenever you communicate with your Toshiba dealer about this TV.

Model Number:

Serial Number:

©2007 Toshiba Corporation
Before operating the unit, please read this manual thoroughly.
*Screen size is approximate.

Dear Customer,

Thank you for purchasing this Toshiba LCD TV.
This manual will help you use many exciting features of your new LCD TV. **Before operating your LCD TV, please read this manual completely,** and keep it nearby for future reference.

Safety Precautions

WARNING: TO REDUCE THE RISK OF FIRE OR ELECTRIC SHOCK, DO NOT EXPOSE THIS APPLIANCE TO RAIN OR MOISTURE.



WARNING
RISK OF ELECTRIC SHOCK
DO NOT OPEN

WARNING: TO REDUCE THE RISK OF ELECTRIC SHOCK, DO NOT REMOVE COVER (OR BACK.)
NO USER-SERVICEABLE PARTS INSIDE. REFER SERVICING TO QUALIFIED SERVICE PERSONNEL.



The lightning flash with arrowhead symbol, within an equilateral triangle, is intended to alert the user to the presence of uninsulated "dangerous voltage" within the product's enclosure that may be of sufficient magnitude to constitute a risk of electric shock to persons.



The exclamation point within an equilateral triangle, is intended to alert the user to the presence of important operating and maintenance (servicing) instructions in the literature accompanying the appliance.

WARNING

To prevent injury, this apparatus must be securely attached to the floor/wall in accordance with the installation instructions. See item 20 on page 4.

WARNING: If you decide to wall mount this television, always use a UL Listed wall bracket appropriate for the size and weight of this television. The use of any wall bracket other than a UL Listed wall bracket appropriate for the size and weight of this television for wall mounting this television could result in serious bodily injury and/or property damage.
See "Removing the Pefestal Stand" (See page 6).

NOTE TO CATV INSTALLERS

This is a reminder to call the CATV system installer to Article 820-40 of the NEC, which provides guidelines for proper grounding and, in particular, specifies that the cable ground shall be connected to grounding system of the building, as close to the point of able entry as practical. For additional antenna grounding information, see item 27 and 28 on page 5.

Child Safety

It Makes A Difference Where Your TV Stands



Congratulations on your purchase!

As you enjoy your new TV, keep these safety tips in mind:

The Issue

- If you are like most consumers, you have a TV in your home. Many homes, in fact, have more than one TV.
- The home theater entertainment experience is a growing trend, and larger TVs are popular purchases; however, they are not always supported on the proper TV stands.
- Sometimes TVs are improperly secured or inappropriately situated on dressers, bookcases, shelves, desks, audio speakers, chests, or carts. As a result, TVs may fall over, causing unnecessary injury.

**Toshiba Cares!**

- The consumer electronics industry is committed to making home entertainment enjoyable and safe.
- The Consumer Electronics Association formed the Home Entertainment Support Safety Committee, comprised of TV and consumer electronics furniture manufacturers, to advocate children's safety and educate consumers and their families about television safety.

Tune Into Safety

- One size does NOT fit all! Use appropriate furniture large enough to support the weight of your TV (and other electronic components).
- Use appropriate angle braces, straps, and anchors to secure your furniture to the wall (but never screw anything directly into the TV).
- Carefully read and understand the other enclosed instructions for proper use of this product.
- Do not allow children to climb on or play with furniture and TVs.
- Avoid placing any item on top of your TV (such as a VCR, remote control, or toy) that a curious child may reach for.
- Remember that children can become excited while watching a program and can potentially push or pull a TV over.
- Share our safety message about this hidden hazard of the home with your family and friends. Thank you!



2500 Wilson Blvd.
Arlington, VA 22201 U.S.A.
www.CE.org

*CEA is the Sponsor, Producer and
Manager of the International CES®*

FCC Declaration of Conformity Compliance Statement (Part 15):

The **Toshiba 19HLV87 Television** complies with Part 15 of the FCC rules.

Operation is subject to the following two conditions: (1) this device may not cause harmful interference, and (2) this device must accept any interference received, including interference that may cause undesired operation.

The party responsible for compliance to these rules is:
Toshiba America Consumer Products, L.L.C.
82 Totowa Rd. Wayne, NJ 07470.
Ph: 1-800-631-3811

Note: This equipment has been tested and found to comply with the limits for a Class B digital device, pursuant to Part 15 of the FCC rules. These limits are designed to provide reasonable protection against harmful interference in a residential installation. This equipment generates, uses, and can radiate radio frequency energy and, if not installed and used in accordance with the instructions, may cause harmful interference to radio communications. However, there is no guarantee that interference will not occur in a particular installation. If this equipment does cause harmful interference to radio or television reception, which can be determined by removing and applying power to the equipment, the user is encouraged to try to correct the interference by one or more of the following measures:

- Reorient or relocate the receiving antenna.
- Increase the separation between the equipment and the receiver.
- Connect the equipment into an outlet on a circuit different from that to which the receiver is connected.
- Consult the dealer or an experienced radio/TV technician for help.

Caution: Changes or modifications to this equipment not expressly approved by Toshiba could void the user's authority to operate this equipment.

WARNING: Handling the cord on this product or cords associated with accessories sold with this product will expose you to lead, a chemical known to the State of California to cause birth defects or other reproductive harm.
Wash hands after handling.

CAUTION:

THIS DIGITAL VIDEO PLAYER EMPLOYS A LASER SYSTEM. TO ENSURE PROPER USE OF THIS PRODUCT, PLEASE READ THIS OWNER'S MANUAL CAREFULLY AND RETAIN FOR FUTURE REFERENCE. SHOULD THE UNIT REQUIRE MAINTENANCE, CONTACT AN AUTHORIZED SERVICE LOCATION.

USE OF CONTROLS, ADJUSTMENTS OR THE PERFORMANCE OF PROCEDURES OTHER THAN THOSE SPECIFIED HEREIN MAY RESULT IN HAZARDOUS RADIATION EXPOSURE.

TO PREVENT DIRECT EXPOSURE TO LASER BEAM, DO NOT TRY TO OPEN THE ENCLOSURE. VISIBLE LASER RADIATION MAY BE PRESENT WHEN THE ENCLOSURE IS OPENED. DO NOT STARE INTO BEAM.

ON DISPOSAL

This product contains mercury. Disposal of mercury may be regulated due to environmental considerations. For disposal or recycling information, please contact your local authorities or the Electronic Industrial Alliance: www.eiae.org.

CAUTION:

The mains plug is used as the disconnect device, it shall remain readily operable during its normal use.

Location of the required Marking

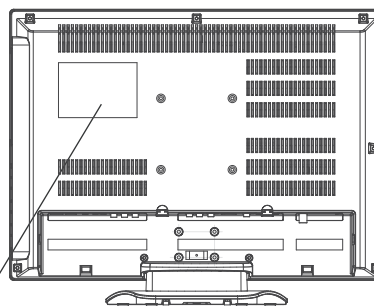

The rating sheet and the safety caution



CERTIFICATION: COMPLIES WITH
FDA RADIATION PERFORMANCE
STANDARDS, 21 CFR SUBCHAPTER J.

IMPORTANT SAFEGUARDS

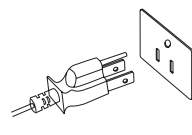
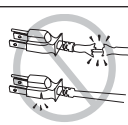
Important Safety Instructions

- 1) **Read these instructions.**
 - 2) **Keep these instructions.**
 - 3) **Heed all warnings.**
 - 4) **Follow all instructions.**
- 
-
- 5) **Do not use this apparatus near water.**
-
- 6) **Clean only with dry cloth.**
-
- 7) **Do not block any ventilation openings.**
Install in accordance with the manufacturer's instructions.
-
- 8) **Do not install near any heat sources** such as radiators, heat registers, stoves, or other apparatus (including amplifiers) that produce heat.
-
- 9) **Do not defeat the safety purpose of the grounding type plug.** A grounding type plug has two blades and a third grounding prong. The wide blade or the third prong are provided for your safety. If the provided plug does not fit into your outlet, consult an electrician for replacement of the obsolete outlet.
 
-
- 10) **Protect the power cord** from being walked on or pinched, particularly at plugs, convenience receptacles, and the point where they exit from the apparatus.
 
-
- 11) **Only use attachments/accessories specified by the manufacturer.**
-
- 12) **Use only with the cart, stand, tripod, bracket, or table specified by the manufacturer, or sold with the apparatus.** When a cart is used, use caution when moving the cart/apparatus combination to avoid injury from tip-over.
 
-
- 13) **Unplug this apparatus during lightning storms or when unused for long periods of time.**
-
- 14) **Refer all servicing to qualified service personnel.** Servicing is required when the apparatus has been damaged in any way, such as power-supply cord or plug is damaged, liquid has been spilled or objects have fallen into the apparatus, the apparatus has been exposed to rain or moisture, does not operate normally, or has been dropped.

ADDITIONAL SAFEGUARDS



- 14a) **CAUTION:** If the TV is dropped and the cabinet or enclosure surface has been damaged or the TV does not operate normally, take the following precautions:
 - ALWAYS turn off the TV and unplug the power cord to avoid possible electric shock or fire.
 - To prevent personal injury, never handle the damaged television.
 - ALWAYS contact a service technician to inspect the TV any time it has been damaged or dropped.
- 15) To avoid damage to this product, never place or store the TV in direct sunlight; hot, humid areas; or areas subject to excessive dust or vibration.

Installation, Care, and Service

Installation

Follow these recommendations and precautions and heed all warnings when installing your TV:

- 16) **WARNING:** To prevent the spread of fire, keep candles or other open flames away from this product at all times.
- 17) Never modify this equipment. Changes or modifications may void: a) the warranty, and b) the user's authority to operate this equipment under the rules of the Federal Communications Commission.

- 18)  **DANGER: RISK OF SERIOUS PERSONAL INJURY, DEATH, OR EQUIPMENT DAMAGE!** Never place the TV on an unstable cart, stand, or table. The TV may fall, causing serious personal injury, death, or serious damage to the TV.
 

- 19) Never place items such as vases, aquariums, or candles on top of the TV.

- 20) **WARNING:** To prevent injury, this apparatus must be securely attached to the floor/wall in accordance with the installation instructions.

Always place the TV on the floor or a sturdy, level, stable surface that can support the weight of the unit. Use a sturdy tie between the TV's rear hook and the rear wall, pillar, etc., to secure the TV.

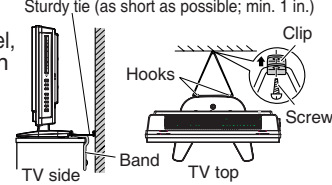

If you use a TV stand, fasten the TV to the stand using the attached band (under the TV pedestal).

- 21) Never expose the apparatus to dripping or splashing liquid or place items such as vases, aquariums, any other item filled with liquid, or candles on top of the TV.
- 22) Never block or cover the slots or openings in the TV cabinet back, bottom, and sides. Never place the TV:
 - on a bed, sofa, rug, or similar surface;
 - too close to drapes, curtains, or walls; or
 - in a confined space such as a bookcase, built-in cabinet, or any other place with poor ventilation.

The slots and openings are provided to protect the TV from overheating and to help maintain reliable operation of the TV. Leave a space of at least 4 inches around the TV.

- 23) Always place the back of the television at least one (1) inch away from any vertical surface (such as a wall) to allow proper ventilation.
- 24) Never allow anything to rest on or roll over the power cord, and never place the TV where the power cord is subject to wear or abuse.
- 25) Never overload wall outlets and extension cords.
- 26) Always operate the TV with a 120V AC, 60Hz power source only.



CAUTION: To reduce the risk of electric shock, do not use the polarized plug with an extension cord, receptacle, or other outlet unless the blades can be inserted completely with three-wire grounding type to prevent blade exposure.

IMPORTANT SAFEGUARDS (Continued)

Installation (cont. from previous page)

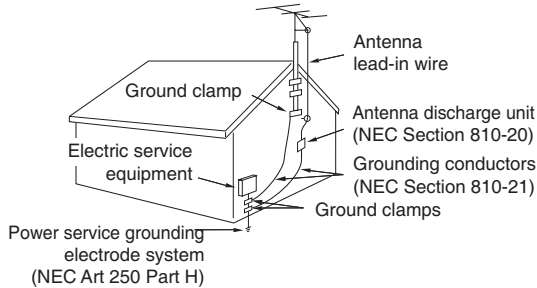

- 27) Always make sure the antenna system is properly grounded to provide adequate protection against voltage surges and built-up static charges (see Section 810 of the National Electric Code.)



- 28)  **DANGER: RISK OF SERIOUS PERSONAL INJURY OR DEATH!**
- Use extreme care to make sure you are never in a position where your body (or any item you are in contact with, such as a ladder or screwdriver) can accidentally touch overhead power lines. Never locate the antenna near overhead power lines or other electrical circuits.
 - Never attempt to install any of the following during lightning activity: a) an antenna system; or b) cables, wires, or any home theater component connected to an antenna or phone system.
- 

Care

For better performance and safer operation of your TOSHIBA TV, follow these recommendations and precautions:

- 29) Always unplug the TV before cleaning. Wipe the display panel surface gently using only the supplied wiping cloth or a soft cloth (cotton, flannel, etc.) A hard cloth may damage the surface of the panel. Avoid contact with alcohol, thinner, benzene, acidic or and alkaline solvent cleaners, abrasive cleaners, or chemical cloths, as the surface may be impaired.
- 
- 30)  **WARNING: RISK OF ELECTRIC SHOCK!** Never spill liquids or push objects of any kind into the TV cabinet slots.
- 31) While it is thundering, do not touch the connecting cables or apparatus.
- 32) For added protection of your TV from lightning and power surges, always unplug the power cord and disconnect the antenna from the TV if you leave the TV unattended or unused for long periods of time.
- 33) During normal use, the TV may make occasional snapping or popping sounds. This is normal, especially when the unit is being turned on or off. If these sounds become frequent or continuous, unplug the power cord and contact a Toshiba Authorized Service Center.

Care (cont. from previous column)

- 34) Keep your fingers well clear of the disc slot as it is closing. Failure to do so may cause serious personal injury.
- 35) When you use headphones, keep the volume at a moderate level. Using headphones continuously at a high volume may cause hearing damage.
- 36) NEVER look directly into the disc slot or ventilation slots at the source of the laser beam. Doing so may cause sight damage.
- 37) NEVER use a cracked, deformed, or repaired disc. Such discs are easily broken and may cause serious personal injury or product damage. SUCH DAMAGE IS NOT COVERED UNDER YOUR WARRANTY.
- 38) **WARNING: RISK OF SERIOUS PERSONAL INJURY OR EQUIPMENT DAMAGE!**
- Never strike the screen with a sharp or heavy object.
 - Never touch, press, or place anything on the LCD screen. These actions will damage the LCD screen. If you need to clean the LCD screen, follow the instructions in item 29 on this page.

Service

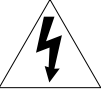
- 39)  **WARNING: RISK OF ELECTRIC SHOCK!** Never attempt to service the TV yourself. Opening and removing the covers may expose you to dangerous voltage or other hazards. Refer all servicing to a Toshiba Authorized Service Center.
- 40) If you have the TV serviced:
- Ask the service technician to use only replacement parts specified by the manufacturer.
 - Upon completion of service, ask the service technician to perform routine safety checks to determine that the TV is in safe operating condition.
- 41) When the TV reaches the end of its useful life, ask a qualified service technician to properly dispose of the TV.

Precautions

Choosing a location for your LCD TV

■ To Display your LCD TV on the included Pedestal Stand:

Observe the following safety precautions:

- 1) Place the TV on a sturdy, level surface that can support the weight of the TV.
- 2) Be sure to secure the TV to a wall, pillar, surface, or other immovable structure. To secure the TV in this manner, use the included strap located at the rear of pedestal stand. (see item 20, page 4).

■ To Display your LCD TV using a Wall Bracket:

If you decide to wall mount your LCD TV, always use a UL Listed wall bracket appropriate for the size and weight of the LCD TV (see page 3):

- 1) **CAUTION:** Two people are required for installation.
- 2) Unplug and remove any cables and/or other component connectors from the rear of the TV.
- 3) **Follow the instructions** provided with your wall bracket. Before proceeding, make sure the appropriate bracket(s) are attached to the wall and the back of the TV as described in the instructions provided with the wall bracket.
- 4) After attaching the appropriate bracket(s) to the wall and the back of the TV, remove the pedestal stand from the TV as described below.

■ Removing the Pedestal Stand

- 1) Carefully lay the front of the unit face down on a flat, cushioned surface such as a quilt or blanket. Leave the stand protruding over the edge of the surface.

NOTE: Extreme care should always be used when removing the pedestal stand to avoid damage to the LCD panel.

- 2) Remove the four screws shown in the diagram below. This will allow removal of the pedestal stand.
- 3) Once you have removed all four screws holding the pedestal stand in place, remove the pedestal stand from the TV by sliding the pedestal stand away from the TV.

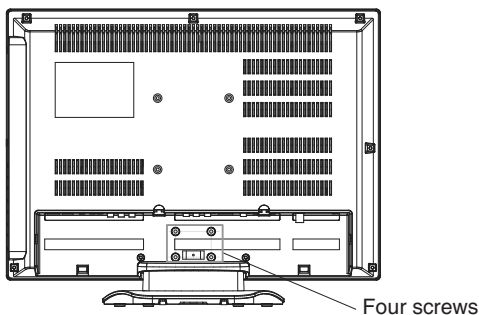

Important notes about your LCD TV

The following symptoms are technical limitations of LCD Display technology and are not an indication of malfunction; therefore, Toshiba is not responsible for perceived defects resulting from these symptoms.

- 1) An after image (ghost) may appear on the screen if a fixed, non-moving image is displayed for a long period of time. The after image is not permanent and will disappear in a short period of time.
- 2) The LCD panel contained in this TV is manufactured using an extremely high level of precision technology; however, there may be an occasional pixel (dot of light) that does not operate properly (does not light, remains constantly lit, etc.). This is a structural property of LCD technology, is not a sign of malfunction, and is not covered under your warranty. Such pixels are not visible when the picture is viewed from a normal viewing distance.

Note: Interactive video games that involve shooting a "gun" type of joystick at an on-screen target may not work on this TV.

Notes on handling

- Do not subject the LCD panel to physical shock, such as dropping it. It may cause unit damage and malfunction.
- When shipping the unit, the original shipping carton and packing materials come in handy. For fully protection, repack the unit as it was originally packed at the factory.
- Do not use volatile liquids, such as insecticide, near the unit. Do not leave rubber or plastic products in contact with the unit for prolonged periods of time. Doing so will leave marks on the finish.
- The top and rear panels of the unit may become warm after a long period of use. This is not a malfunction.
- When the unit is not in use, always remove the disc and turn off the power.

Notes on locating the unit

- When you place this unit near a TV, radio, or VCR, the playback picture may become poor and the sound may be distorted. In this case, place the unit away from the TV, radio, or VCR.
- To avoid damage to this product, never place or store the TV/DVD in direct sunlight; hot, humid areas; or areas subject to excessive dust or vibration.

Precautions (Continued)/Notes on discs

Notes on moisture condensation

Moisture condensation damages the unit. Please read the following carefully. Moisture condensation occurs, for example, when you pour a cold drink into a glass on a warm day and drops of water form on the outside of the glass. In the same way, moisture may condense on this unit's internal optical pick-up lens, one of the most crucial internal parts of the unit.

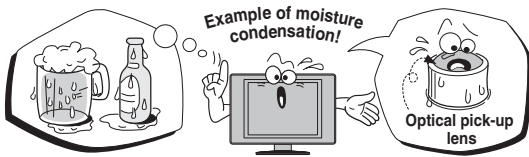

Moisture condensation may occur in the following situations:

- When you move the unit from a cold area to a warm area.
- When you use the unit in a room in which the heat was just turned on.
- When you use the unit in an area where cold air from an air conditioner directly hits the unit.
- When you use the unit in a humid area.



Never use the unit when moisture condensation may occur

Using the unit when moisture condensation exists may damage discs and internal parts. Connect the power cord of the unit to the wall outlet, turn on the unit, remove the disc, and leave it for two or three hours. After two or three hours, the unit will have warmed up and evaporated any moisture. Leaving the TV connected to the wall outlet will help prevent moisture condensation in the TV or DVD Player.

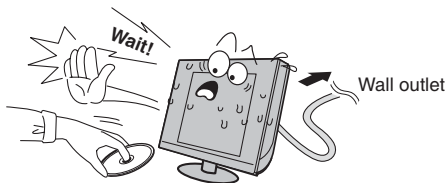

On handling discs

- Do not touch the playback side of the disc. For example, handle the disc so that it is shown in figure below.

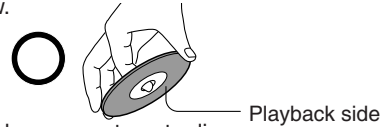

- Do not attach paper or tape to discs.



On cleaning discs

- Fingerprints and dust on the disc cause picture and sound deterioration. Wipe the disc from the center outwards with a soft cloth. Always keep the disc clean.



- Do not use any type of solvent such as thinner, benzene, commercially available cleaners or antistatic spray for vinyl LPs. It may damage the disc.

On storing discs

- Do not store discs in a place subject to direct sunlight or near heat sources.
- Do not store discs in places subject to moisture and dust such as a bathroom or near a humidifier.
- Store discs vertically in a case. Stacking or placing objects on discs outside of their case may cause warping.

Structure of disc contents

Normally, DVD video discs are divided into titles, and the titles are sub-divided into chapters. Video CDs and Audio CDs are divided into tracks.

DVD video disc

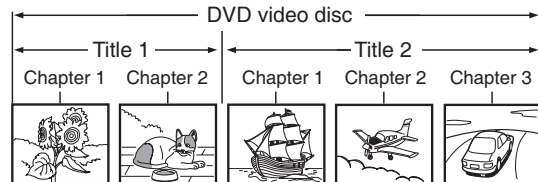

Video CD/Audio CD

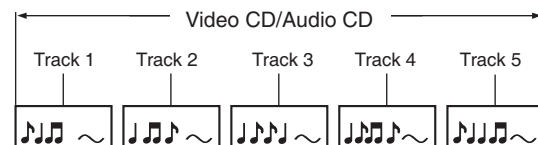

Each title, chapter or track is assigned a number, which is called "title number", "chapter number" or "track number" respectively.

There may be discs that do not have these numbers.

Notes on copyright

The unauthorized recording, use, distribution, or revision of copyrighted materials including, without limitation, television programs, videotapes, and DVDs, is prohibited under the Copyright Laws of the United States and other countries, and may subject you to civil and criminal liability.

This product incorporates copyright protection technology that is protected by method claims of certain U.S. patents and other intellectual property rights owned by Macrovision Corporation and other rights owners. Use of this copyright protection technology must be authorized by Macrovision Corporation, and is intended for home and other limited viewing uses only unless otherwise authorized by Macrovision Corporation.

Reverse engineering or disassembly is prohibited.

About this owner's manual

This owner's manual explains the basic instructions of this unit. Some DVD video discs are produced in a manner that allows specific or limited operation during playback. As such, the unit may not respond to all operating command. This is not a defect in the unit. Refer to instruction notes of discs.



The following symbol may appear on the TV screen during operation.



It means that the operation is not permitted by the TV/DVD or the disc.

For example, sometimes it is unable to stop the playback of copyright message of the disc when the STOP (■) button is pressed. Alternatively, this symbol may also indicate that the feature is not available for the disc.

Notes on region numbers

The region number of this unit is 1. If region numbers, which stand for their playable area, are printed on your DVD video disc and you do not find  or , disc playback will not be allowed by the player. (In this case, the unit will display a message on-screen.)

Some DVDs that have no region code label may still be subject to area restrictions and therefore not playable.



On Video CDs

This unit supports Video CDs equipped with the PBC (Version 2.0) function. (PBC is the abbreviation of Playback Control.) You can enjoy two playback variations depending on types of discs.

- **Video CD not equipped with PBC function (Version 1.1)**
Sound and movie can be played on this unit in the same way as a DVD.
- **Video CD equipped with PBC function (Version 2.0)**
In addition to operation of a Video CD not equipped with the PBC function, you can enjoy playback of interactive software with search function by using the menu displayed on the TV screen (Menu Playback). Some of the functions described in this owner's manual may not work with some discs.

Playable discs

This unit can play the following discs.

	Disc Mark	Contents	Disc Size	Maximum playback time
DVD video discs		Audio + Video (moving pictures)	12 cm	Approx. 4 hours (single sided disc) Approx. 8 hours (double sided disc)
Video CDs		Audio + Video (moving pictures)	12 cm	Approx. 74 minutes (single sided disc)
Audio CDs		Audio	12 cm	Approx. 74 minutes (single sided disc)

The following discs are also available.

- DVD-R/RW discs of DVD video format.
- CD-R/CD-RW discs of CD-DA, Video CD, MP3, WMA, JPEG or DivX® format
- Kodak Picture CD and FUJICOLOR CD format.

Some of these discs may be incompatible.

- You cannot play discs other than those listed above.
- You cannot play discs of DVD-RAM, DVD-ROM, CD-ROM, Photo CD, etc., or non standardized discs even if they may be labeled as above.
- Some CD-R/RWs cannot be played back depending on the recording conditions.
- This unit uses the NTSC color system, and cannot play DVD video discs recorded in any other color system (PAL, SECAM, etc.).
- This unit cannot play an 8cm disc. Please do not use a disc adapter. It may cause trouble.
- Please do not insert any disc of an irregular shape into the unit, as it may interfere with the function of the unit. You may not be able to remove it.
- Please do not use after market accessories, such as a ring protector, as this may cause trouble with the operation of the unit.

Because of problems and errors that can occur during the creation of DVD and CD Software and/or the manufacture of DVD and CD discs, Toshiba cannot assure that the DVD player contained in this TV will successfully play every disc bearing the DVD and CD logos.

If you happen to experience any difficulty playing a DVD and/or CD disc on the DVD player contained in this TV, please contact Toshiba Customer Service.

DVD is a trademark of DVD Format/Logo Licensing Corporation.

Contents

Introduction

IMPORTANT SAFEGUARDS	4
Precautions.....	6
Notes on discs.....	7
Contents	9
Identification of controls.....	10

Connections

Antenna connections	14
Cable TV connections	15
Connecting to optional equipment.....	16
Power source.....	19
Connecting to an HDMI™ or DVI device.....	20
Connecting to a PC(personal computer).....	21

Basic setup

Setting the language.....	22
Setting the system clock	23
To set the On timer.....	23
To memorize channels.....	24

TV operation

TV operation.....	25
Progammring your favorite channels.....	27
Setting the closed captions (analog caption/ digital caption).....	28
Setting the CC advanced.....	29
Setting the V-Chip.....	30
Locking channels.....	33
Labeling channels and video input source.....	35
Setting the GameTimer™.....	36
Using the panel lock feature.....	36
Viewing the wide-screen picture formats.....	37
Using the ASPECT feature.....	39
Picture control adjustment	40
Adjusting the picture mode	40
Selecting the color temperature.....	41
Adjusting the back lighting.....	41
Sound control adjustment	42
Stereo and Second Audio Program (SAP)	42
Selecting the HDMI™ audio source.....	43
Checking the signal meter	44
Using the auto shut off feature	44
Picture control adjusting in PC mode.....	45
Sound control adjusting in PC mode.....	46

Basic playback

Playing a disc	47
----------------------	----

Advanced playback

Zooming.....	50
Locating desired scene.....	50
Marking desired scenes.....	51
Repeat playback.....	52
A-B Repeat playback.....	52
Program playback.....	53
Shuffle playback.....	53
Changing angles.....	54
Title selection.....	54
DVD menu	54
Changing soundtrack language.....	55
Subtitles.....	55
Disc status	56
To turn off the PBC	56
MP3/WMA/JPEG/DivX® and Audio CD operation	57
Repeat, Shuffle and program playback using file browser.....	61

Function setup

Customizing the function settings.....	63
Temporary cancel the rating level by DVD disc.....	70

Others

Troubleshooting	71
Reception disturbances	73
Specifications	74
Limited United States Warranty	75
Limited Canadian Warranty	77

Identification of controls

Top

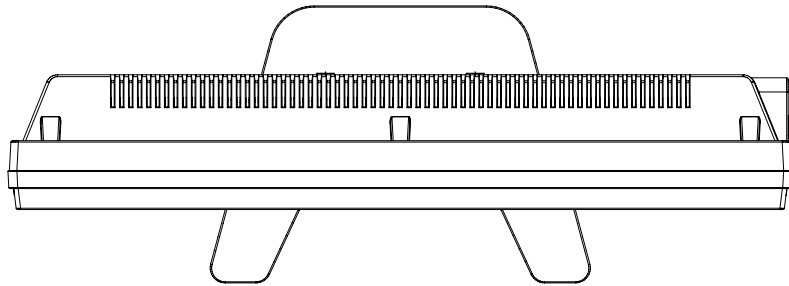

Front

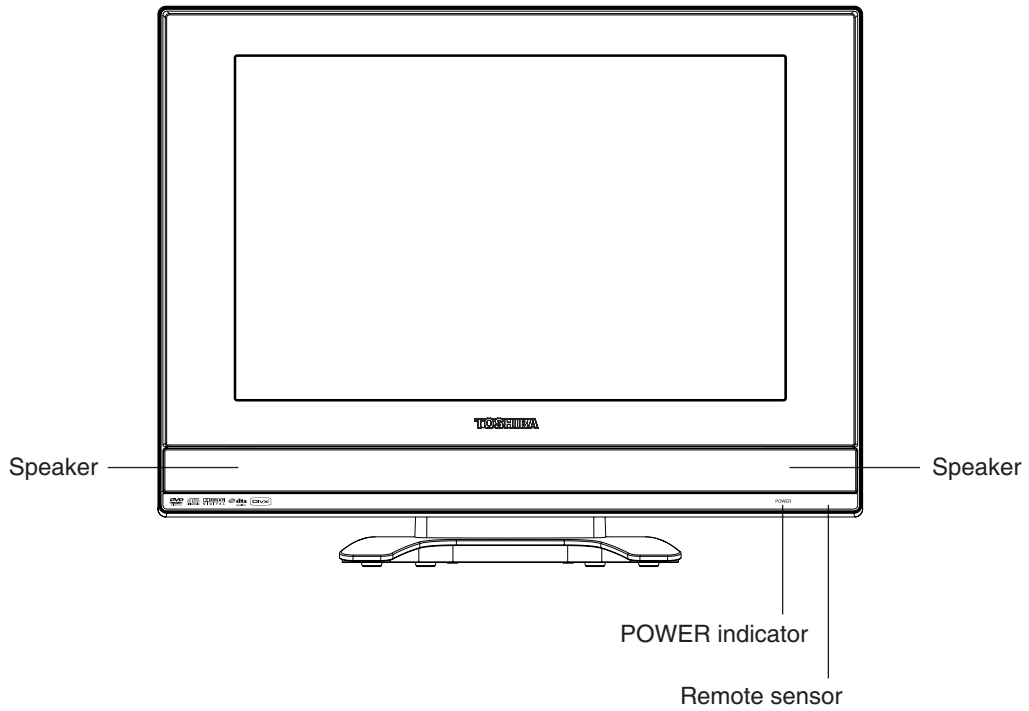

Identification of controls (Continued)

Side

Right Side

Disc slot

CHANNEL (▲ / ▼) buttons
VOLUME (+/-) buttons
POWER (⏻) button

EJECT (▲) button
PLAY (▶) button
STOP (■) button

Adjusting the angle of the base

Approx 5° Approx 10°

You can adjust the angle of the TV screen 5° forward or 10° backward from vertical. Hold the base of the TV/ DVD while adjusting the angle.

Rear

Back

Back panel

For Service Only OPTICAL PHONES VIDEO-1 IN VIDEO-2 IN HEADPHONE jack OPTICAL DIGITAL AUDIO OUT

ColorStream (Y, Pb, Pr) HD IN HDMI IN PC IN Antenna jack Power jack

Remote control

The instructions in this manual describe the function on the remote control. See the page in for details.

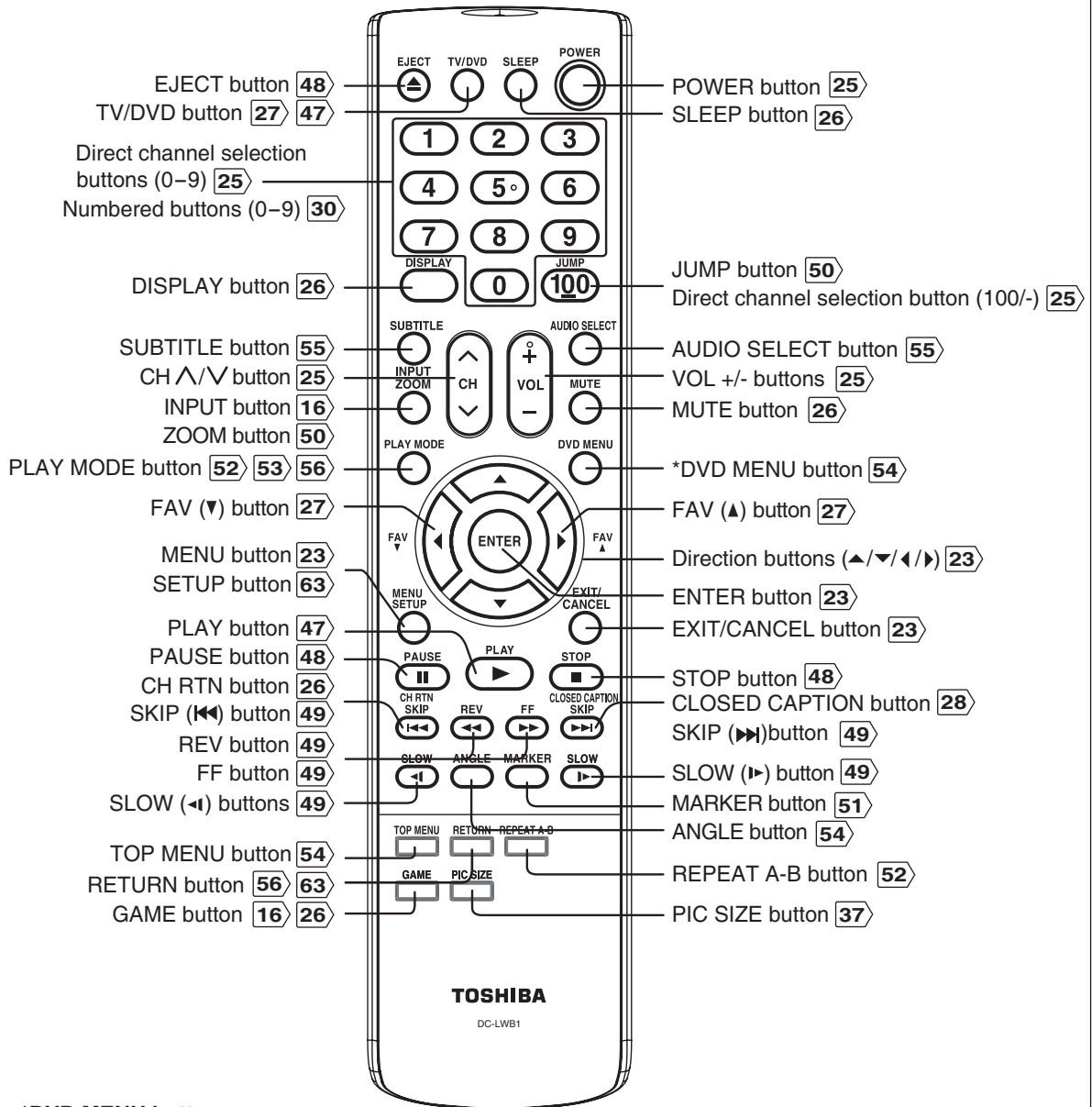

*DVD MENU button

Use the DVD MENU button to display the menu included on many DVD video discs.

To operate a menu, follow the instructions in "DVD menu." 54

Identification of controls (Continued)

Inserting batteries

- 1 Open the battery cover on the back of the remote control.
- 2 Install two "AAA" size batteries (supplied), Match the + and - signs on the batteries to the signs on the battery compartment.
- 3 Close the battery cover on the remote control until the lock snaps.

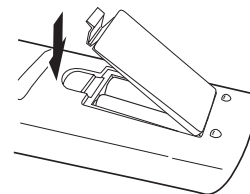
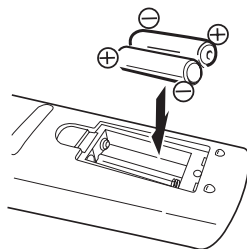
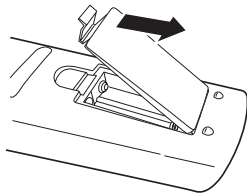

Operation

- Aim the remote control at the remote sensor and press control buttons to operate.
- Operate the remote control within 30° angle on either side of the remote sensor, up to a distance of approx. 5 meters.

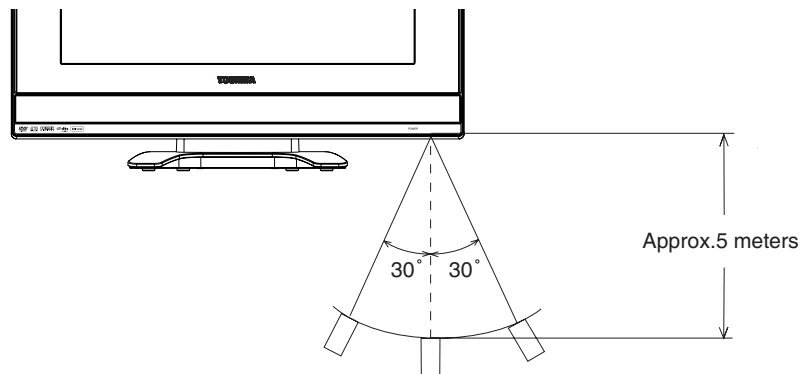

Caution:

- Never throw batteries into a fire.

Notes:

- Be sure to use AAA size batteries.
- Dispose of batteries in a designated disposal area.
- Batteries should always be disposed of with the environment in mind. Always dispose of batteries in accordance with applicable laws and regulations.
- If the remote control does not operate correctly, or if the operating range becomes reduced, replace batteries with new ones.
- When necessary to replace batteries in the remote control, always replace both batteries with new ones. Never mix battery types or use new and used batteries in combination.
- Always remove batteries from remote control if they are dead or if the remote control is not to be used for an extended period of time. This will prevent battery acid from leaking into the battery compartment.

Antenna connections

If you are using an indoor or outdoor antenna, follow the instructions below that correspond to your antenna system.
If you are using a cable TV service (CABLE), see page 15 for Cable TV connections.

Combination VHF/UHF antenna (Single 75 ohm cable or 300 ohm twin-lead wire)

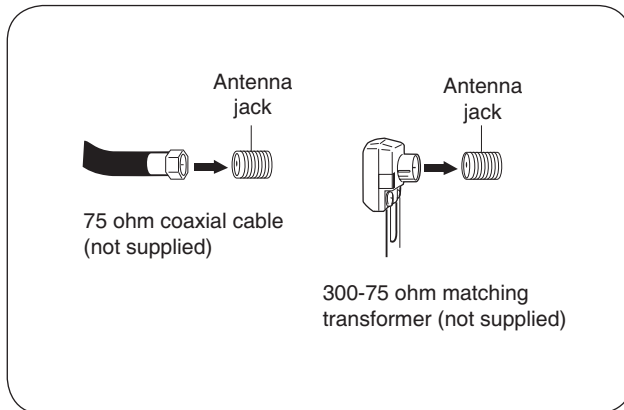

Connect the 75 ohm cable from the combination VHF/UHF antenna to the antenna jack on the back of the TV/DVD.

If your combination VHF/UHF antenna has a 300 ohm twin-lead wire, use the 300-75 ohm matching transformer (not supplied).

Combination VHF/UHF antenna (Separate VHF and UHF 300 ohm twin-lead wires)

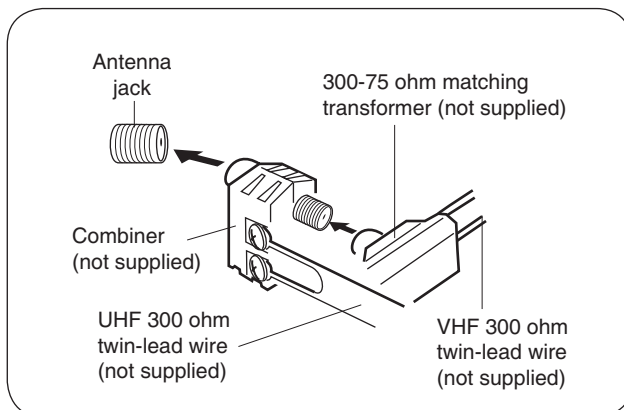

Connect the UHF 300 ohm twin-lead wire to the combiner (not supplied). Connect the VHF 300 ohm twin-lead wire to the 300-75 ohm matching transformer (not supplied). Attach the transformer to the combiner, then attach the combiner to the antenna jack on the back of the TV/DVD.

Separate VHF/UHF antennas (75 ohm VHF cable and 300 ohm UHF twin-lead wires)

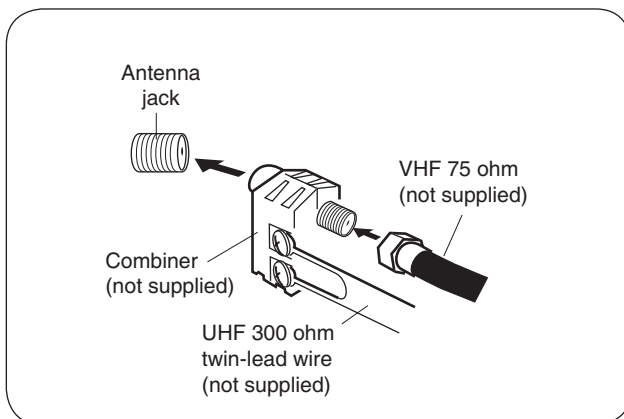

Connect the VHF 75 ohm cable and UHF 300 ohm twin-lead wire to the combiner (not supplied). Attach the combiner to the antenna jack on the back of the TV/DVD.

Cable TV connections

This TV/DVD has an extended tuning range and can tune most cable channels without using a Cable TV converter box. Some cable companies offer "premium pay channels" in which the signal is scrambled. Descrambling these signals for normal viewing requires the use of a descrambler device which is generally provided by the cable company.

For subscribers to basic cable TV service

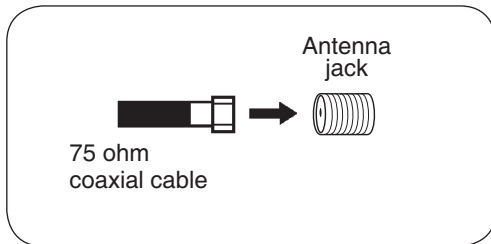

For basic cable service not requiring a converter/descrambler box, connect the Cable TV 75 ohm coaxial cable directly to the Antenna jack on the back of the TV/DVD.

For subscribers to scrambled cable TV service

If you subscribe to a cable TV service which requires the use of a converter/descrambler box, connect the incoming 75 ohm coaxial cable to the converter/descrambler box. Using another 75 ohm coaxial cable, connect the output jack of the converter/descrambler box to the antenna jack on the TV/DVD. Follow the connections shown below. Set the TV/DVD to the output channel of the converter/descrambler box (usually channel 3 or 4) and use the converter/descrambler box to select channels.

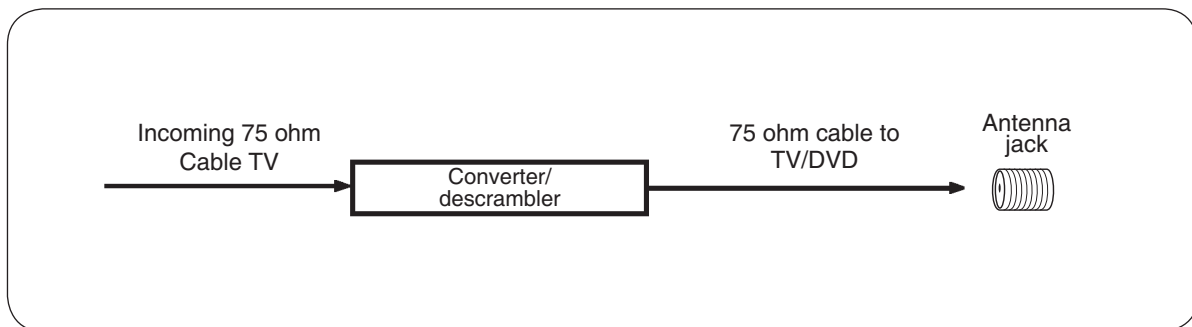

For subscribers to unscrambled basic cable TV service with scrambled premium channels

If you subscribe to a cable TV service in which basic channels are unscrambled and premium channels require the use of a converter/descrambler box, you may wish to use a signal splitter and an A/B Switch box (available from the cable company or an electronics supply store). Follow the connections shown below. With the switch in the "B" position, you can directly tune any unscrambled channels on your TV/DVD. With the switch in the "A" position, tune your TV/DVD to the output of the converter/descrambler box (usually channel 3 or 4) and use the converter/descrambler box to tune scrambled channels.

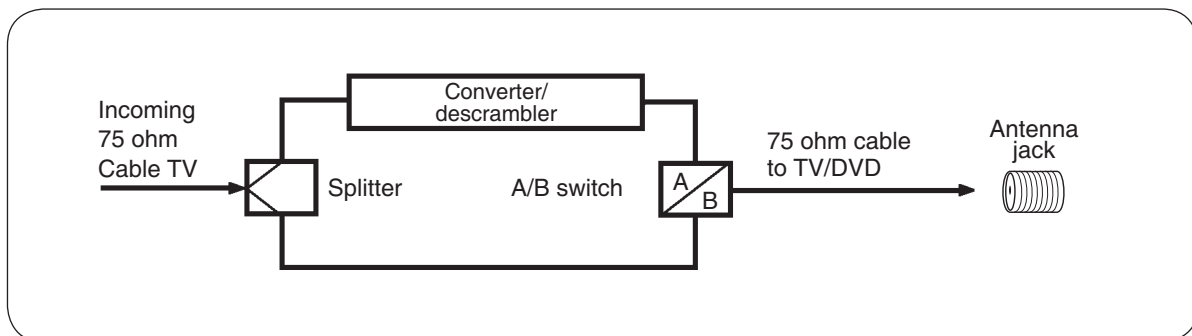

Connecting to optional equipment

You can enjoy VCR, camcorder or TV game with connection to external input.

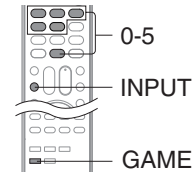

Selecting the video input source

Press **INPUT** to view a signal from another device connected to your TV, such as a VCR or DVD player. You can select ANT, VIDEO1, VIDEO2, ColorStream HD, HDMI or PC on the back panel, depending on which input jacks you used to connect your devices.

Press **INPUT** on the remote control to display the current signal source. To change the input source, press **INPUT** again or press **0-5**.

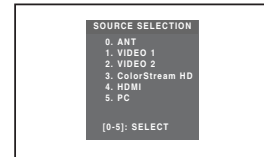

Connecting to a VCR

To playback from the VCR, connect the VCR to the TV/DVD as shown. Select the "VIDEO1" by pressing **INPUT** repeatedly.

↓ : Signal flow

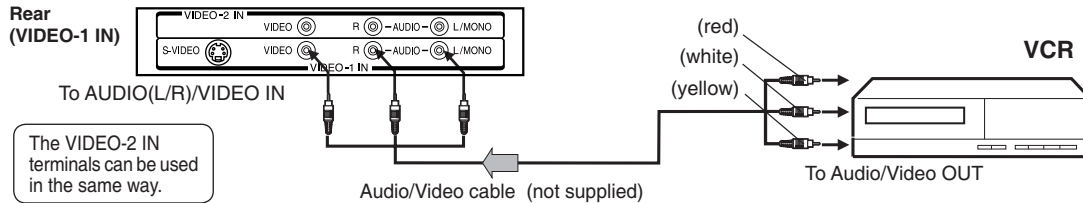

Connecting to a camcorder

To playback from the camcorder, connect the camcorder to the TV/DVD as shown. Select the "VIDEO1" by pressing **INPUT** repeatedly.

↓ : Signal flow

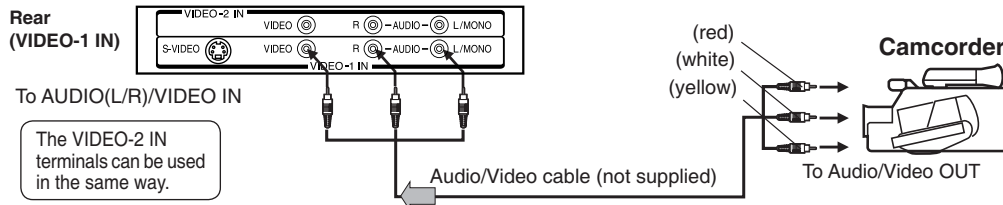

Connecting to a TV Game

You can enjoy playing a TV game on the screen by adjusting to the suitable brightness for your eyes.

1. Connect a TV Game to the TV/DVD.
 2. Select the "GAME" by pressing **GAME**.
The GAME mode screen appears.
- This TV/DVD has the GAME mode function (see page 26).

↓ : Signal flow

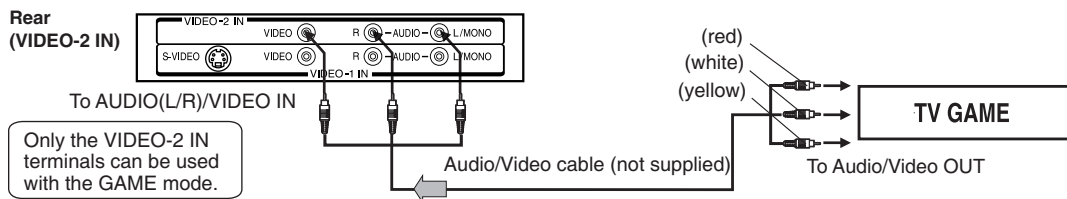

Notes:

- You can also change the TV screen to the desired mode by pressing the CH \wedge / \vee buttons.
- The TV/DVD can also be used as a display device for many video games. However, due to the wide variety of different types of signal generated by these devices and subsequent hook-up variations required, they have not all been included in the suggested connection diagrams. You'll need to consult each component's Owner's Manual for additional information.
- Interactive video games that involve shooting a "gun" type of joystick at on-screen target may not work on this TV/DVD.

Connecting to optional equipment (Continued)

Connecting to an optional equipment with S-video output

If you connect a VCR with an S-VIDEO cable to the S-VIDEO IN jack at the back of the TV/DVD, you must also connect the audio cables to the AUDIO IN (VIDEO-1 IN) jacks at the back of the TV/DVD. The S-VIDEO cable only carries the video signal. The audio signal is separated. Select the "VIDEO1" by pressing **INPUT** repeatedly.

➡ : Signal flow

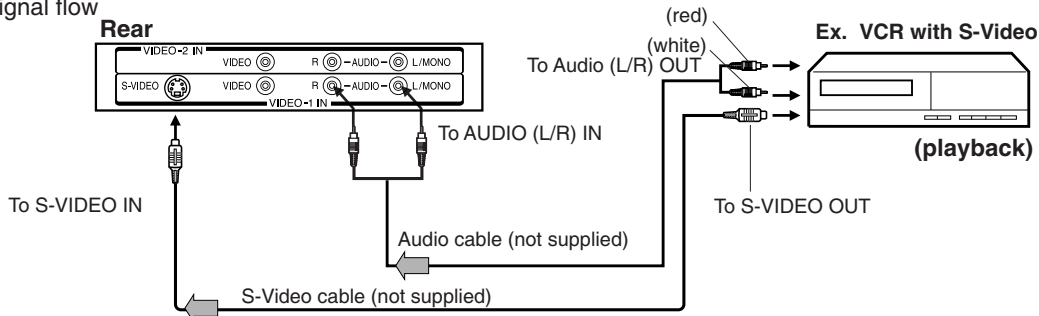

Note: When the S-VIDEO cable and the standard video cable are connected at the same time, the S-video cable takes precedence.

Connecting an optional equipment with ColorStream® (Component video) output

Your TV/DVD is capable of using ColorStream® (component video). Connecting your TV/DVD to a component video compatible DVD player, such as a Toshiba DVD player with ColorStream® can greatly enhance picture quality and performance.

Select the "ColorStream HD" by pressing **INPUT** repeatedly.

➡ : Signal flow

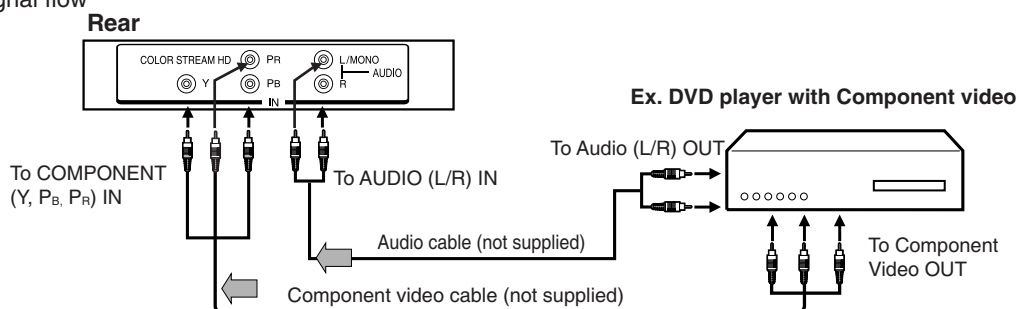

When using the Component video cable, an Audio cable must be connected to AUDIO IN (L/R) (COLOR STREAM HD IN) jacks.

Notes:

- Refer to the owner's manual of the connected equipment as well.
- When you connect the unit to other equipment, be sure to turn off the power and unplug all of the equipment from the wall outlet before making any connections.
- If you place the unit near a tuner or radio, the radio broadcast sound might be distorted. In this case, place the unit away from the tuner and radio.

You can enjoy high quality dynamic sounds by connecting the TV/DVD to optional audio equipment.

* This section uses the following reference mark.

- : Front speaker
- : Rear speaker
- : Sub woofer
- : Center speaker
- ⇒ : Signal flow

Connecting to an amplifier equipped with a Dolby® Digital decoder

Dolby Digital

Dolby Digital is the surround sound technology used in theaters showing the latest movies, and is now available to reproduce this realistic effect in the home. You can enjoy motion picture and live concert DVD video discs encoded via the Dolby Digital recording system with this dynamic realistic sound by connecting the TV/DVD to a 6 channel amplifier equipped with a Dolby Digital decoder or Dolby Digital processor. If you have a Dolby Surround Pro Logic decoder, you will obtain the full benefit of Pro Logic from the same DVD movies that provide full 5.1-channel Dolby Digital soundtracks, as well as from titles with the Dolby Surround mark.

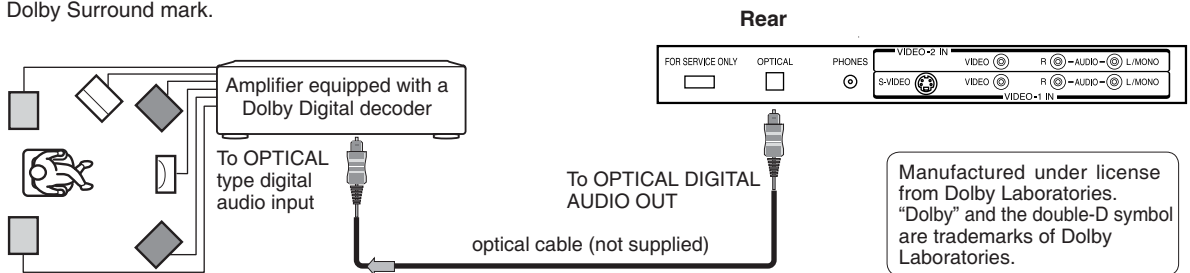

Connecting to an amplifier equipped with a DTS® decoder



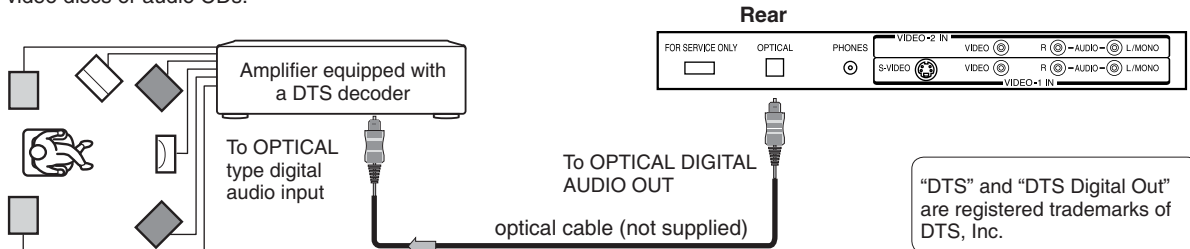

Digital Theater Systems (DTS)

DTS is a high quality surround technology used in theaters and now available for home use, on DVD video discs or audio CDs. If you have a DTS decoder or processor, you can obtain the full benefit of 5.1 channel DTS encoded sound tracks on DVD video discs or audio CDs.



Connecting to optional equipment (Continued)/Power source

* This section uses the following reference mark.

	: Front speaker		: Center speaker
	: Rear speaker		: Signal flow
	: Sub woofer		

Connecting to an amplifier equipped with an MPEG audio decoder

MPEG2 sound

You can enjoy motion picture and live concert DVD video discs encoded via the MPEG2 recording system with dynamic realistic sound by connecting an amplifier equipped with an MPEG2 audio decoder or MPEG2 audio processor.

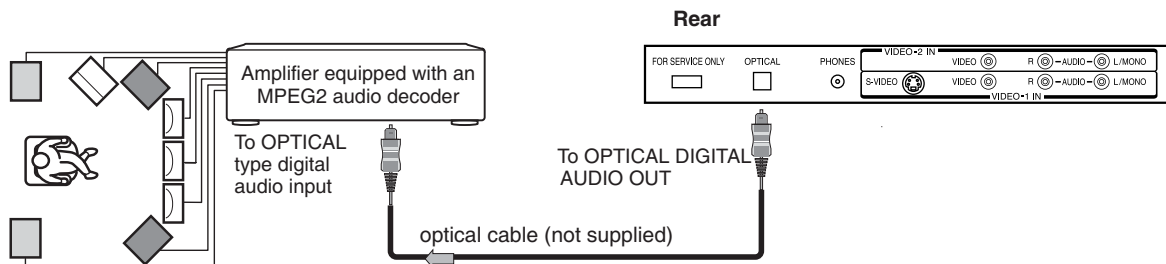

Connecting to an amplifier equipped with a digital audio input

2 channel digital stereo

You can enjoy the dynamic sound of 2 channel digital stereo by connecting an amplifier equipped with a digital audio input and speaker system (right and left front speakers).

Note: PCM audio is limited to DVD or CD playback.

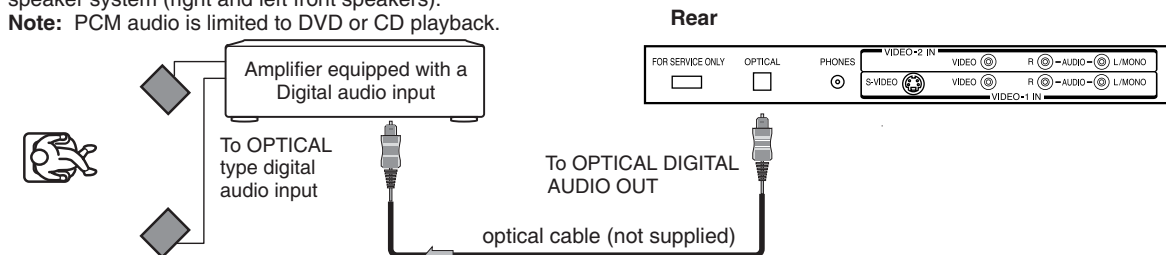

Notes:

- DO NOT connect the OPTICAL DIGITAL AUDIO OUT jack of the TV/DVD to the AC-3 RF input of a Dolby Digital Receiver. This input on your A/V Receiver is reserved for Laserdisc use only and is incompatible with the OPTICAL DIGITAL AUDIO OUT jack of the TV/DVD.
- Connect the OPTICAL DIGITAL AUDIO OUT jack of the TV/DVD to the "OPTICAL" input of a Receiver or Processor.
- Refer to the owner's manual of the connected equipment as well.
- When you connect the TV/DVD to other equipment, be sure to turn off the power and unplug all of the equipment from the wall outlet before making any connections.
- The output sound of the TV/DVD has a wide dynamic range. Be sure to adjust the receiver's volume to a moderate listening level. Otherwise, the speakers and your hearing may be damaged by a sudden high volume sound.
- Turn off the amplifier before you connect or disconnect the TV/DVD's power cord. If you leave the amplifier's power on, the speakers may be damaged.

Power source

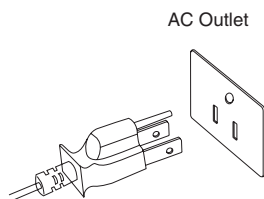

TO USE AC POWER SOURCE

Use the power cord provided for operation on AC. Insert the power cord into a standard 120V 60Hz AC outlet.

Notes:

- Never connect the power cord plug to other than the specified voltage (120V 60Hz). Use the attached power cord only.
- If you cause a static discharge when touching the unit and the unit fails to function, simply unplug the unit from the AC outlet and plug it back in. The unit should return to normal operation.
- If the power cord plug is plugged in for the first time, wait for approx. 5 seconds before pressing the POWER button.

Connecting to an HDMI™ or DVI device

The HDMI input on your TV receives digital audio and uncompressed digital video from an HDMI source device, or uncompressed digital video from a DVI(Digital Video Interface) source device.

This input is designed to accept HDCP (High-Bandwidth Digital Content Protection) program material in digital form from EIA/CEA-861/861B-compliant^[1] consumer electronic devices (such as a set-top box or DVD player with HDMI or DVI output).

The HDMI input is designed for best performance with high definition video signals. It will accept and display 480i, 480p,720p and 1080i signals.

[1] EIA/CEA-861/861B compliance covers the transmission of uncompressed digital video with high-bandwidth digital content protection, which is being standardized for reception of high-definition video signals. Because this is an evolving technology, it is possible that some devices may not operate properly with the TV.

Connecting to an HDMI™ device

HDMI cable transfers both video and audio. Separate analog audio cables are not required. You must set the HDMI audio input setting to "HDMI" in the AUDIO menu(see page 43). Select the "HDMI" by pressing **INPUT** repeatedly.

HDMI, the HDMI logo, and High-Definition Multimedia Interface are trademarks or registered trademarks of HDMI Licensing, LLC.

➡ : Signal flow

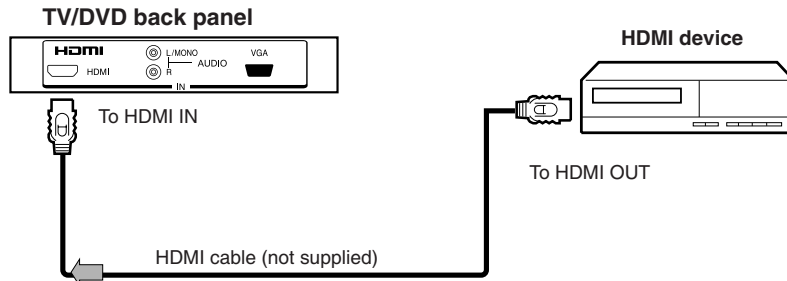

Some CDVs(Video CDs) may not output digital audio signals. In that case, you may hear sound by connecting analog audio cables. If you do use analog audio cables for this reason, you will need to set the HDMI audio input setting to "DVI" to hear the analog audio(see page 43).

Note:

If you connect an HDMI device and analog audio cables and play media with digital audio output, to hear digital audio you must set the HDMI audio input setting to "HDMI"(see page 43).

Connecting to a DVI device

To ensure that the HDMI or DVI device is reset properly, it is recommended that you follow these procedures:

- When turning on your electronic components, turn on the TV/DVD first, and then the HDMI or DVI device.
- When turning off your electronic components, turn off the HDMI or DVI device first, and then the TV/DVD.

To connect a DVI device, you will need one HDMI-to-DVI adapter cable(HDMI type A connector). An HDMI-to-DVI adapter cable transfers only video. Separate analog audio cables are required(see illustration below.)

Select the "HDMI" by pressing **INPUT** repeatedly.

➡ : Signal flow

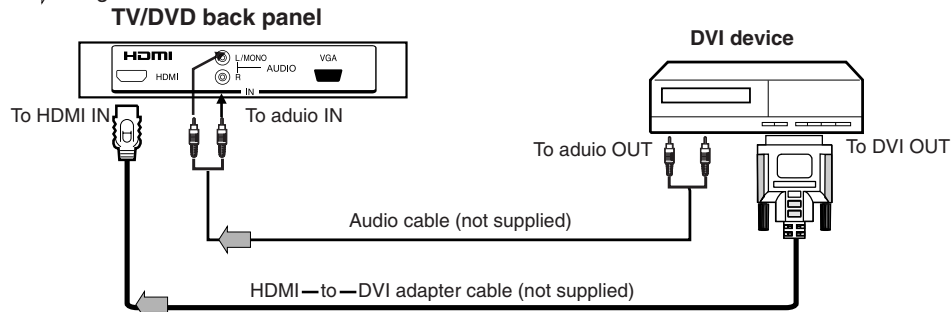

Note:

You must set the HDMI audio input setting to "DVI" in the AUDIO menu(see page 43).

Connecting to a PC (personal computer)

Connecting to a PC

Before you connect this TV/DVD to your PC, change the adjustment of your PC's Resolution and Refresh rate. See "Monitor" display modes" below.

Mode	Resolution	Refresh rate
VGA	640x480	60Hz
VGA	720x400	70Hz
SVGA	800x600	60Hz
XGA	1024x768	60Hz
WXGA	1280x720	60Hz
WXGA	1280x768	60Hz

Connect one end of a (male to male) VGA cable to the video card of the computer and the other end to the VGA connector PC at the side of the TV/DVD. Fix the connectors firmly with the screws on the plug. In case of a Multimedia computer, connect the audio cables to the audio outputs of your Multimedia computer and to the AUDIO L and R connectors of the PC IN jacks of the TV/DVD.

Set the video input source to PC mode. (See "Selecting the video input source" on page16 and "Picture/Sound control adjustments in PC mode" on pages 45 and 46.) The TV/DVD can be used as a computer monitor.

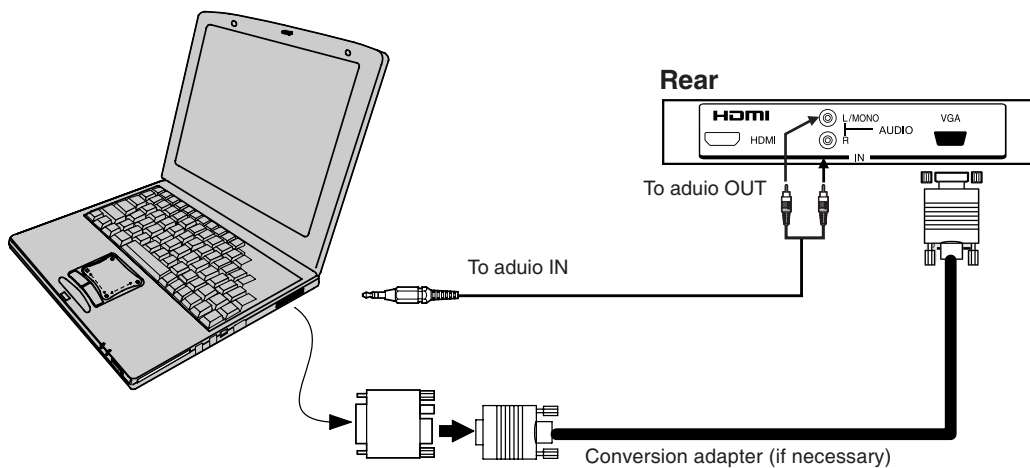

Notes:

- Some PC models cannot be connected to this TV.
- The on-screen displays will have a different appearance in PC mode than in TV mode.

Setting the language

This TV/DVD can display the on screen language in English, Spanish or French in the TV mode. Select the language you prefer first, then proceed with the other menu options.

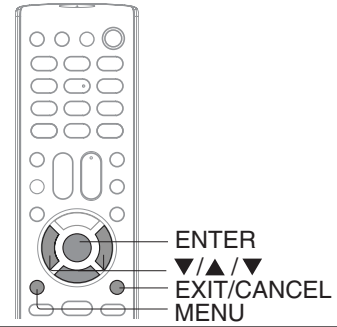

Setting language

- 1** Press **MENU** in the TV mode, then press **◀** or **▶** to display the “**SETUP**” menu.

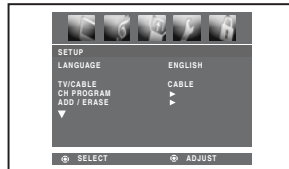
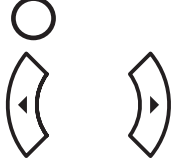
MENU
SETUP

- 2** Press **▼** to select “**LANGUAGE**”, then press **◀** or **▶** to select the desired language: English (**ENGLISH**), Spanish (**ESPAÑOL**) or French (**FRANÇAIS**), then press **ENTER**.

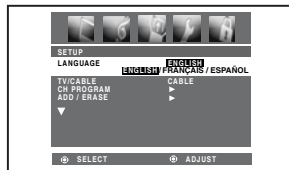
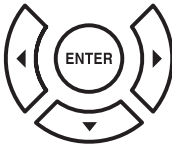

- 3** Press **EXIT/CANCEL** to clear the menu screen.

EXIT/
CANCEL

Notes:

- If the unit does not operate properly, or No key operation (by the unit and/or the remote control): Static electricity, etc., may affect the TV/DVD's operation. In such case, disconnect the AC cord once, then connect it again.
- The TV section has its own menu and DVD section also has its own menu [63](#).

Setting the system clock/To set the On timer

On timer feature allows you to program the TV/DVD to turn on automatically at a set time. You must set the clock before you can program the ON timer.

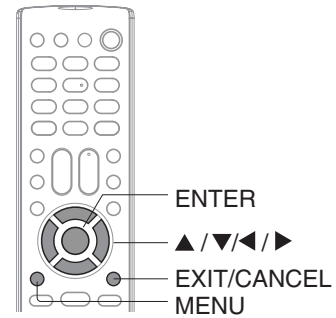

Setting the system clock

- 1 Press MENU in the TV mode, then press ◀ or ▶ to display the "SETUP" menu.

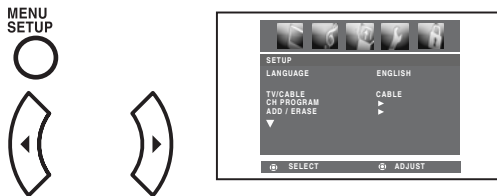

- 2 Press ▼ to select "SYSTEM CLOCK", press ◀ or ▶ to set the hour. Then press ENTER.

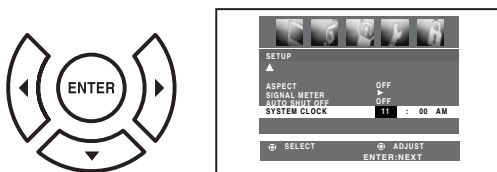

- 3 Press ◀ or ▶ to set the minute, then press ENTER.

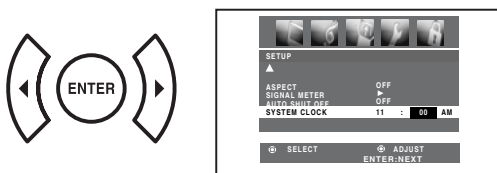

- 4 Press EXIT/CANCEL to clear the menu screen.



Note:

If the power source for the TV/DVD is interrupted (for example, the power cord is unplugged or a power failure occurs), you will need to reset the clock.

To set the On timer

- 1 Press MENU in the TV mode, then press ◀ or ▶ to display the "OPTION" menu.

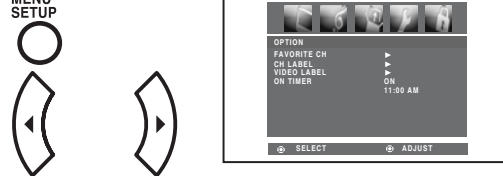

- 2 Press ▼ to highlight the "ON TIMER", then press ◀ or ▶ to select "ON", then press ▼.

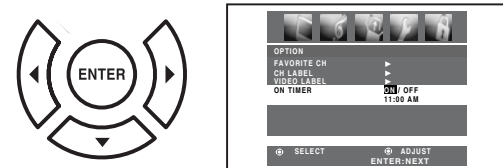

- 3 Press ◀ or ▶ to set the hour. Then press ENTER.

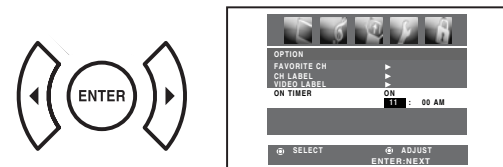

- 4 Press ◀ or ▶ to set the minute. Then press ENTER.

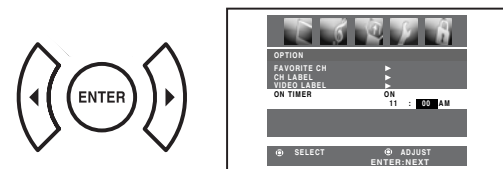

To cancel the on timer

Select OFF in step 2 above.

- 5 Press EXIT/CANCEL to clear the menu screen.



To memorize channels

This TV/DVD is equipped with a channel memory feature which allows channels to skip up or down to the next channel set into memory, skipping over unwanted channels. Before selecting channels, they must be programmed into the TV/DVD's memory. In addition to normal VHF and UHF channels, this TV/DVD can receive up to 125 Cable TV channels. To use this TV/DVD with an antenna, set the TV/CABLE selection to the TV position. When shipped from the factory, this selection is in the CABLE position.

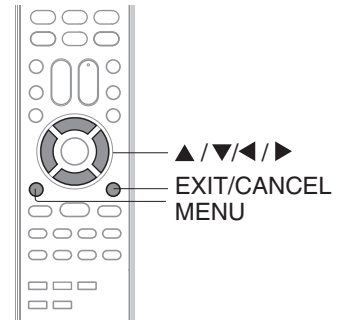

TV/CABLE selection

- 1 Press MENU in the TV mode, then press ◀ or ▶ to display the "SETUP" menu.

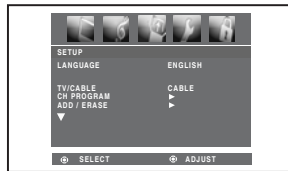
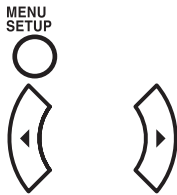

- 2 Press ▼ to select "TV/CABLE".

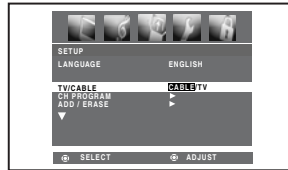

- 3 Press ◀ or ▶ to select "TV" or "CABLE".

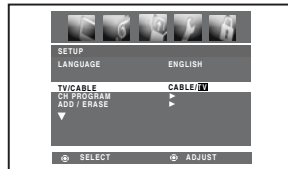
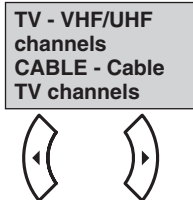

- 4 Press EXIT/CANCEL to clear the menu screen.



Automatic memory tuning

Press MENU in the TV mode, then press ◀ or ▶ to display the "SETUP" menu. Press ▼ to select the "CH PROGRAM", then press ▶.

The TV will begin memorizing all the channels available in your area.

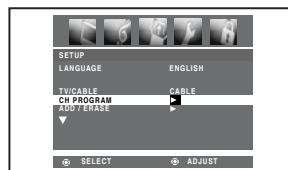

To ADD/ERASE channels

- 1 Press MENU in the TV mode, then press ◀ or ▶ to display the "SETUP" menu. Press ▼ to select "ADD/ERASE".

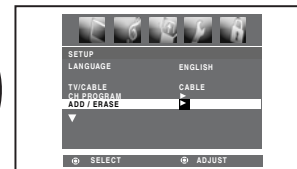
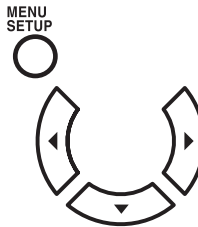

- 2 Press ◀ or ▶. The "ADD/ERASE" menu will appear. Press ▲ or ▼ to select "ADD/ERASE", then press ◀ or ▶.

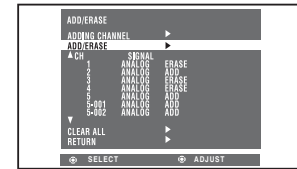
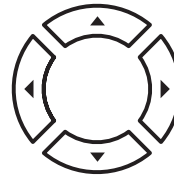

- 3 Press ▲ or ▼ to select the channel you want and then press ◀ or ▶ to select "ADD" or "ERASE".

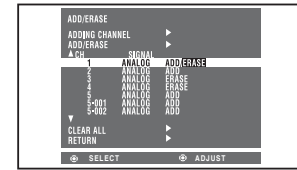
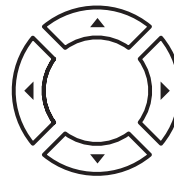

- 4 Repeat steps 3 for other channel you want to add or erase.

- 5 Press EXIT/CANCEL to clear the menu screen.



To add a digital channel you are watching: Select a channel you want to add. Then select "ADDING CHANNEL" in step 2, then press ◀ or ▶.

TV operation

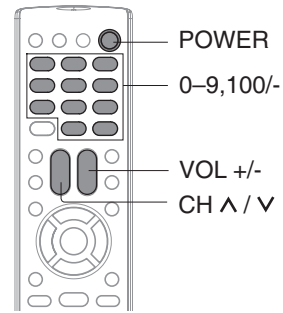

TV operation

1 To turn on the TV/DVD, press POWER.
The power indicator on the front of the main unit will change from red to green.

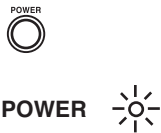

2 Adjust the volume level by pressing VOL +/-.
The volume level will be indicated on the screen by black bars. As the volume level increases, so do the number of bars. If the volume decreases, the number of black bars also decreases.

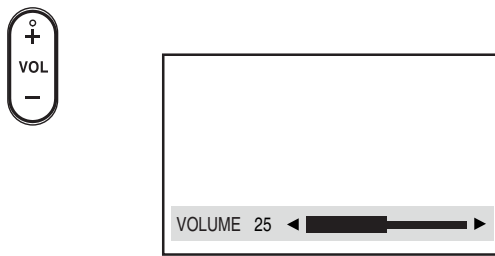

3 Set the TV/CABLE selection to the appropriate position [24].

TV - VHF/UHF channels
CABLE - Cable TV channels

4 Press direct channel selection (0-9, 100/-) or CH ^ or V to select the channel.

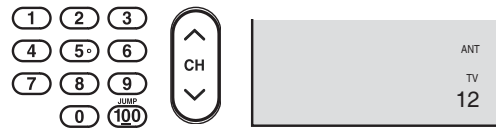

TO SELECT ANALOG CHANNELS

When the TV/CABLE selection is in the CABLE position, channels can be selected as follows:

TO SELECT CABLE TV CHANNELS:

- 1-9: Press **0** twice, then 1-9 as needed.
Example, to select channel 2, press **002**.
- 10-99: Press **0**, then the remaining 2 digits.
Example, to select channel 12, press **012**.
- 100-125: Press the 3 digits in order. Example, to select channel 120, press **120**.

TO SELECT DIGITAL CHANNELS

Press the first 3 digits, then press the "100/-" button, followed by the remaining 3 digits.
Example, to select channel 015-001, press **015 - 001**.

TV	CATV
VHF 2-13	VHF 2-13
UHF 14-69	STD/HRC/IRC 14-36 (A) (W) 37-59 (AA) (WW) 60-85 (AAA) (ZZZ) 86-94 (86) (94) 95-99 (A-5) (A-1) 100-125 (100) (125) 01 (5A)

Notes:

- If a channel with no broadcast is selected, the sound will automatically be muted.
- Digital channels may be represented by channel numbers that include a "dash" (e.g., 85-002). These digital channel numbers may not match the numbers in the channel line-up provided by your cable company. This is not a malfunction.

TV operation

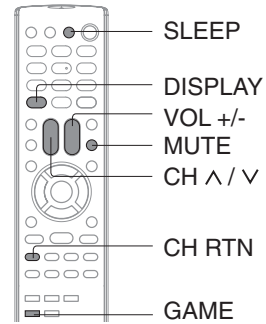

TV operation

■ DISPLAY

Press **DISPLAY** to display the information on the TV screen.

To cancel the display, press **DISPLAY** again.

When the TV receives a digital signal, press once, the digital information will appear.

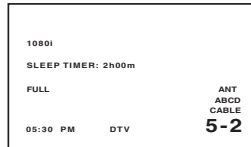

Press **DISPLAY** again, the analog information will appear.

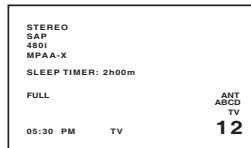

Press **DISPLAY** again to clear the display.

■ CH RETURN

This button allows you to go back to the last channel selected by pressing **CH RTN**. Press **CH RTN** again to return to the last channel you were watching.



■ MUTE

Press **MUTE** to switch off the sound. The TV/DVD's sound will be silenced and "MUTE" will appear briefly on the screen. The sound can be switched back on by pressing this button again or one of **VOL +/-**.



■ SLEEP

To set the TV/DVD to turn off after a preset amount of time, press **SLEEP** on the remote control. The clock will count up in following sequence for each press of **SLEEP**. (0h00m, 0h15m, 0h30m, 1h00m, 1h30m, 2h00m). After the sleep time is programmed, the display will appear briefly every minutes to remind you that the sleep timer is operating. To confirm the sleep timer setting, press **SLEEP** and the remaining time will be displayed for a few seconds. To cancel the sleep timer, press few seconds. To cancel the sleep timer, press **SLEEP** repeatedly until the display turns to 0h00m.

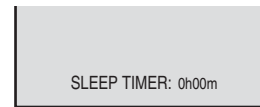

■ GAME MODE

After connecting a TV Game to the unit (see page 16), press **GAME**. The TV screen changes to the Game mode.

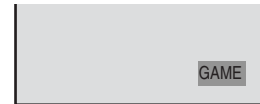

- The Game mode screen is adjusted to the suitable brightness for your eyes.
- If **GAME** is pressed during standby mode, the unit turns on automatically and the Game mode screen appears on the screen.
- Interactive video games that involve shooting a "gun" type of joy-stick at an on-screen target may not work on this TV/DVD.

■ HEADPHONES

Insert a stereo headphones (not supplied) with a 1/8" mini plug into the HEADPHONE jack on the back panel. If you connect headphones, the sound from TV speakers is muted.

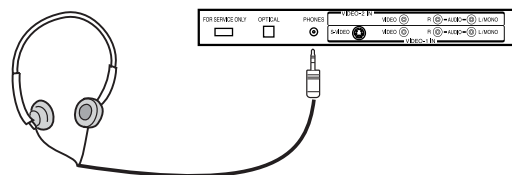

Programming your favorite channels

You can preset up to 12 of your favorite channels using the Favorite Channel Programming feature. Because this feature scans through only your favorite channels, it allows you to skip other channels you do not normally watch.

You can still use CH \wedge / \vee to scan through all the channels you programmed in the TV's memory or the Channel Numbers to directly tune a channel.

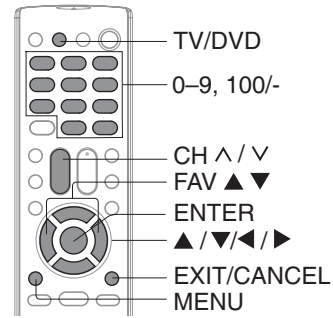

To program your favorite channels

- 1 Press TV/DVD to select the TV mode, then select a channel you want to program.



- 2 Press MENU, then press \leftarrow or \rightarrow to display the "OPTION" menu.

MENU SETUP



- 3 Press \vee to highlight the "FAVORITE CH", then press \rightarrow to display the "FAVORITE CH" menu. SET/CLEAR will be highlighted.

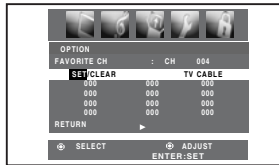

- 4 Press \leftarrow or \rightarrow to highlight "SET" and press ENTER.

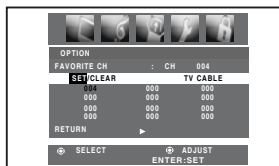

- 5 Press EXIT/CANCEL to return to normal viewing.



Note:

Repeat steps 1-5 for up to 12 channels.

To select your favorite channels

Press the FAV \blacktriangle / \blacktriangledown buttons on the remote control to select your favorite channels.

The FAV \blacktriangle / \blacktriangledown buttons will not work until you have programmed your favorite channels.



To clear your favorite channels

- 1 Press TV/DVD to select the TV mode, then select a channel you want to clear.



- 2 Press MENU, then press \leftarrow or \rightarrow to display the "OPTION" menu.

MENU SETUP

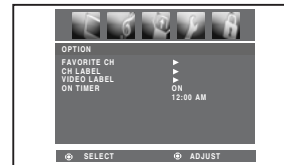

- 3 Press \vee to highlight the "FAVORITE CH", then press \rightarrow to display the "FAVORITE CH" menu. SET/CLEAR will be highlighted.

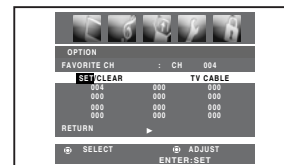

- 4 Press \leftarrow or \rightarrow to highlight "CLEAR".

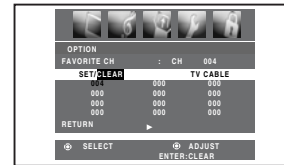

- 5 Press ENTER until "000" replaces the channel number you want to erase.



- 6 Press EXIT/CANCEL to return to normal viewing.



Note:

Repeat steps 1-6 for the other channels.

TV operation

Setting the closed captions (analog caption/ digital caption)

WHAT IS CLOSED CAPTIONING?

This television has the capability to decode and display closed captioned television programs. Closed captioning will display text on the screen for hearing impaired viewers or it will translate and display text in another language.

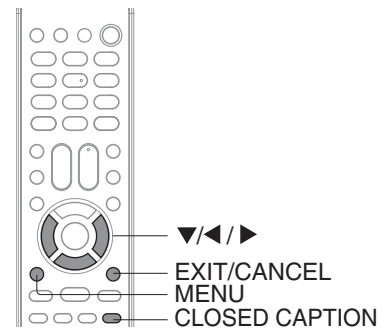

To set the analog caption

- 1** Press **MENU** in the TV mode, then press **◀** or **▶** to display the "SETUP" menu.



- 2** Press **▼** to highlight "ANALOG CAPTION".

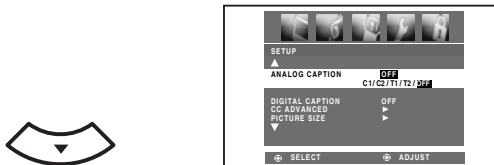

- 3** Press **◀** or **▶** to select the desired Closed Caption mode.

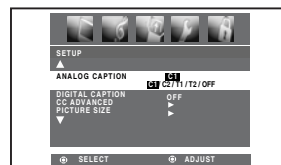

- To view captions, select C1 or C2 (C1 displays translation of the primary language in your area.)
Note: If the program or video you selected is not closed captioned, no captions will display on-screen.
- To view text, select T1 or T2.

- 4** Press **EXIT/CANCEL** to return to normal viewing.



To set the digital caption

- 1** Press **MENU** in the TV mode, then press **◀** or **▶** to display the "SETUP" menu.



- 2** Press **▼** to highlight "DIGITAL CAPTION".

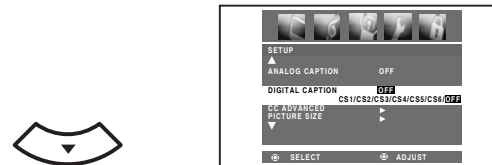

- 3** Press **◀** or **▶** to select the desired Closed Caption mode.

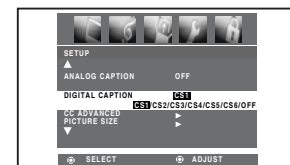

You can choose from CS1, CS2, CS3, CS4, CS5, CS6 and OFF.

- 4** Press **EXIT/CANCEL** to return to normal viewing.



Note:

You also can display the CLOSED CAPTION menu screen by pressing **CLOSED CAPTION** on the remote control.

Important Note:

If text is not available in your viewing area, a black rectangle may appear on-screen. If this happens, set the Closed Caption feature to OFF.

Setting the CC advanced

This feature is designed to customize digital captions only.

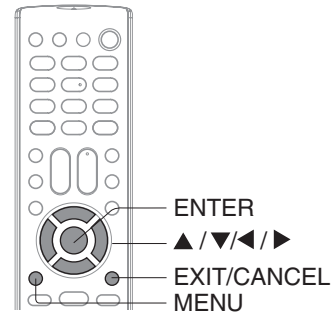

To set the CC advanced feature

- 1** Press **MENU** in the TV mode, then press **◀** or **▶** to display the “SETUP” menu.



* Press **MENU** to go to previous menu to change another parameter.

- 2** Press **▼** to highlight “CC ADVANCED”, then press **◀** or **▶**.

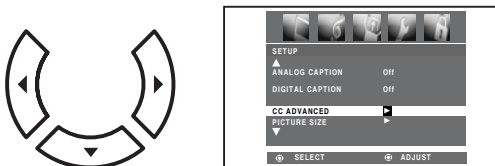

- 3** Press **▲** or **▼** to select the desired item to adjust, then press **◀** or **▶**.

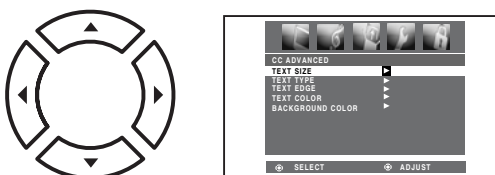

- 4** Press **▲** or **▼** to select the desired setting, then press **ENTER**.



You can select from among the following items and parameters.

TEXT SIZE: AUTO, SMALL, STANDARD, LARGE
TEXT TYPE: AUTO, DEFAULT, MONO W. SERIF, MONO W/O SERIF, PROP. W. SERIF, PROP. W/O SERIF, CASUAL, CURSIVE, SMALL CAPITAL
TEXT EDGE: AUTO, NONE, RAISED, DEPRESSED, UNIFORM, LEFT DROP SHADOW, RIGHT DROP SHADOW
TEXT COLOR: AUTO, BLACK, WHITE, RED, GREEN, BLUE, YELLOW, MAGENTA, CYAN
BACKGROUND COLOR: AUTO, BLACK, WHITE, RED, GREEN, BLUE, YELLOW, MAGENTA, CYAN

- 5** Press **EXIT/CANCEL** to return to normal viewing.



TV operation

Setting the V-Chip

An age limitation can be set to forbid children to see and hear violent scenes or pictures for adults, etc. The TV/DVD corresponds to "TV RATING" and "MOVIE RATING". To use the V-Chip function, you must register a password.

Note:

If you forget the password, press DISPLAY four times during "ERROR" is blinking after the wrong password is entered. This allow you to reset your password.

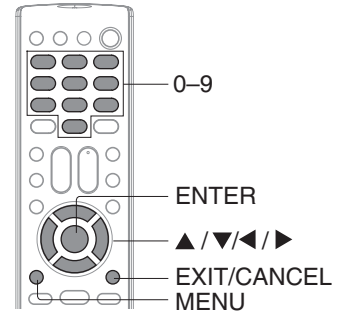

To register password

1 Press MENU in the TV mode, then press ◀ or ▶ to display the "LOCKS" menu.

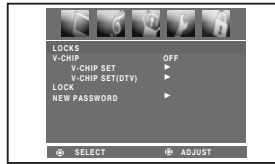
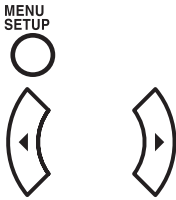

2 Press ▼. New password entering screen appears.

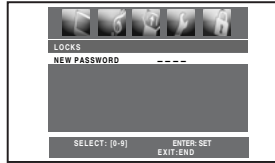

3 Enter the password (4 digits) using Number buttons (0-9), then press ENTER.

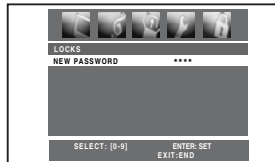
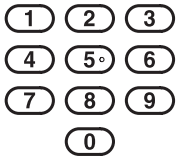

"*" appears instead of the number.

4 Enter the password (4 digits) using Number buttons (0-9) again for the safety, then press ENTER.

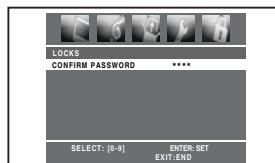
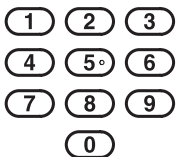

If wrong password is entered, "ERROR" blinks about four seconds.

To change password

1 Repeat steps 1 ~ 3 in "To register password" on left, then press ▲ or ▼ to select "NEW PASSWORD", then press ▶. Enter the current password using Number buttons (0-9), then press ENTER.

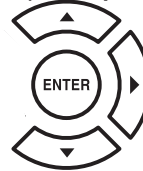

2 Enter the new password using Number buttons (0-9), then press ENTER.

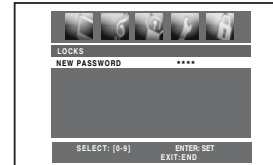
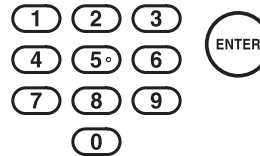

3 Enter the same password again using Number buttons (0-9) for safety, then press ENTER.

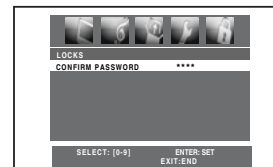
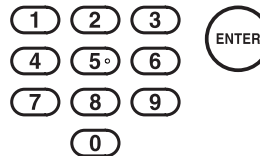

4 Press EXIT/CANCEL to clear the menu screen.



Note:

The V-Chip feature is available only for the U.S. V-Chip system. The Canadian V-Chip system is not supported.

Setting the V-Chip (Continued)

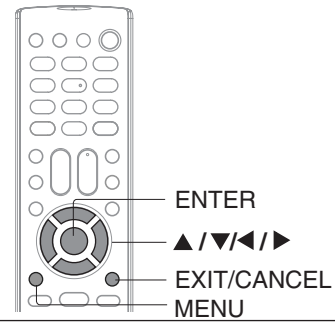

To set the V-Chip

- 1** Repeat steps 1 ~ 3 in “To register password” on page 30, then press ▲ or ▼ to highlight “V-CHIP SET”.

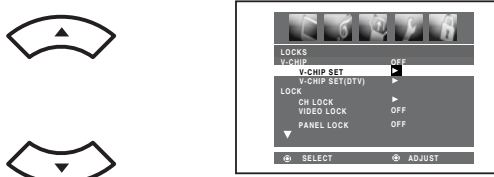

- 2** Press ▶ to display “V-CHIP SET” menu. Press ▶ to select “TV Rating”.



- 3** Press ▲▼◀▶ to select the desired rating and press ENTER to block or unblock the setting.

- TV-Y : All children
- TV-Y7 : 7 years old and above
- TV-G : General audience
- TV-PG : Parental guidance
- TV-14 : 14 years old and above
- TV-MA : 17 years old and above

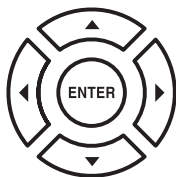

- ALL: All levels allowed
- FV: Fantasy violence
- V: Violence
- S: Sexual situations
- L: Coarse language
- D: Suggestive dialog

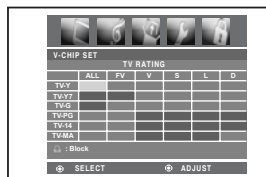

- 4** Press MENU to go back to V-CHIP SET menu. In V-CHIP SET menu, press ▲ or ▼ to select “MOVIE RATING”, then press ▶.

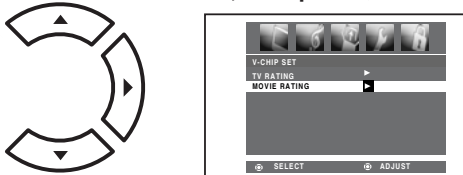

- 5** Press ▲ or ▼ to select the desired rating, then press ◀ or ▶ to select “ON” or “OFF”.

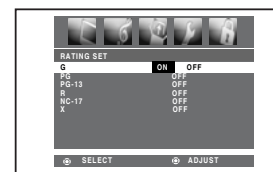
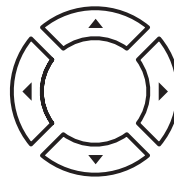

- ON : MOVIE RATING is set
- OFF : MOVIE RATING is not set

- G : All ages
- PG : Parental guidance
- PG-13 : Parental guidance less than 13 years old
- R : Under 17 years old Parental guidance suggested
- NC-17 : 17 years old and above
- X : Adult only

- 6** Press MENU repeatedly to go back to LOCKS menu. Press ▲ or ▼ to select “V-CHIP”.

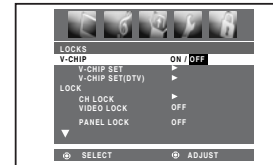

- 7** Press ◀ or ▶ to display “ON”.
- Now your settings in TV RATING and MOVIE RATING were blocked from viewing.

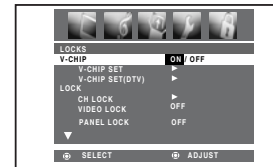
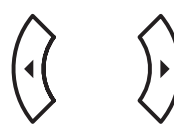

- 8** Press EXIT/CANCEL to clear the menu screen.



To use after the TV is protected

When you try to view a program with a ratings block, a message will appear listing the program's ratings. The program can still be viewed if you enter your password to temporarily bypass the block.

Note:

The V-Chip function is activated only on programs that have the rating signal.

TV operation

As a supplement to the standard V-Chip rating system, your Toshiba Television will be able to download an additional rating system, if such a system becomes available in the future.

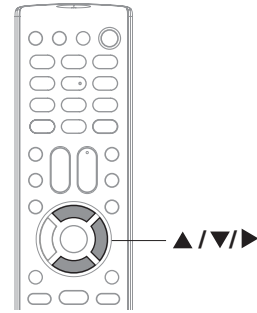

To download the additional V-Chip rating system (when available)

- 1** Repeat steps 1~3 in “To register password” on page 30, then press ▲ or ▼ to highlight “V-CHIP SET (DTV)”, then press ▶.
(You cannot select this feature if the TV is not receiving a digital signal for the current station.)

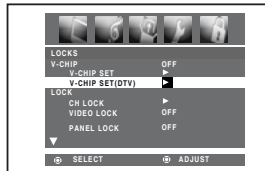

- 2** The TV will begin downloading the additional rating system, which may take some time to be completed.

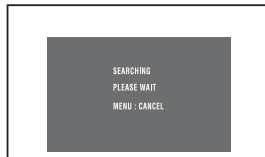

- 3** Set your preferred content rating limits for the additional rating system.

PLEASE NOTE THE FOLLOWING:

- You can only download the additional V-Chip rating system when your TV is receiving a digital signal.
- When you download the additional rating system, it may take some time for the download to occur.
- The V-Chip rating information and system are not determined or controlled by the TV or Toshiba.
- The standard V-Chip rating system is available whether your TV is receiving a digital signal or not, and will block both analog and digital programs. To set program blocking using the standard V-Chip rating system, select V-CHIP SET in step 1 on the left (see page 31 for details).

The downloadable V-Chip rating system is an evolving technology, and availability, content, and format may vary.

Locking Channels

With the CH LOCK feature, you can lock specific channels. You will not be able to tune locked channels unless you clear the setting. You can choose to lock up to 12 TV channels and 12 cable channels.

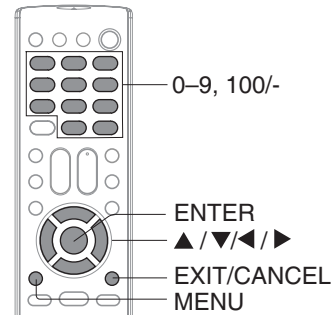

To lock channels

1 Use the Number buttons (0-9,100) to display the television channel you wish to lock.

2 Press MENU, then press ◀ or ▶ to display the "LOCKS" menu.

MENU
SETUP

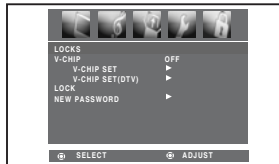

3 Press ▼ to display the password entering mode. Use the Number buttons (0-9) to enter your password, then press ENTER. The LOCKS menu appears.

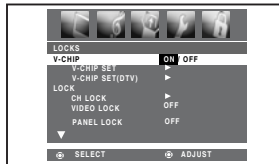
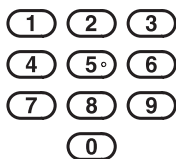

4 Press ▲ or ▼ to highlight CH LOCK and press ▶ to display the CH LOCK menu. SET/CLEAR will be highlighted.

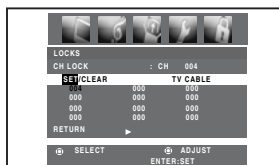

5 Press ◀ or ▶ to select the following:

SET- to set the channel as one to be locked. Then press ENTER.
CLEAR- to clear all channels from the list of locked channels. Then press ENTER.



6 Press EXIT/CANCEL to return to normal viewing.



Notes:

- Repeat steps 1 through 6 to lock other channels. When you have finished locking channels, press EXIT/CANCEL to return to normal viewing.
- If you try to tune a locked channel, the TV/DVD will not display it, but will display the nearest unlocked channel.
- After programming CH LOCK, change channels before turning off the television.

TV operation

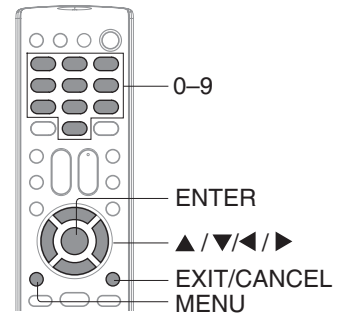

To unlock channels

1 Press MENU, then press ◀ or ▶ to display the “LOCKS” menu.

MENU
SETUP

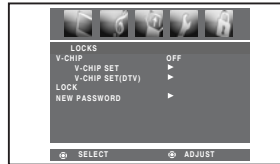

5 Press ◀ or ▶ to select CLEAR.

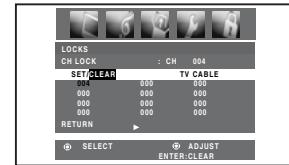
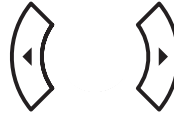

2 Press ▼ to display the password entering mode.



6 Press ENTER until “000” replaces the channel number you want to erase.



7 Press EXIT/CANCEL to return to normal viewing.



3 Use the Number buttons (0-9) to enter your password, then press ENTER. The LOCKS menu appears.

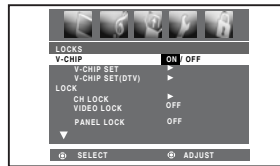
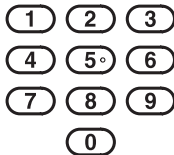

4 Press ▲ or ▼ to highlight “CH LOCK” and press ▶ to display the CH LOCK menu.

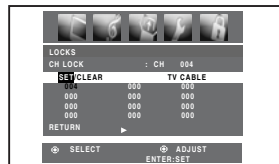

Labeling channels and video input source

Channels labels appear above the channel number display each time you turn on the TV/DVD, select a channel or press the DISPLAY button. You can choose any four characters to identify a channel. The video label feature allows you to label each input source for your TV/DVD.

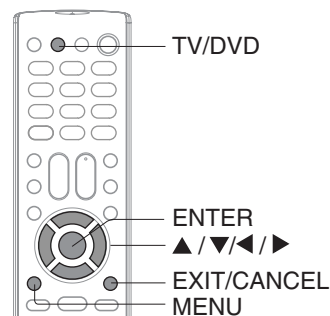

To create channel labels

- 1 Press TV/DVD to select the TV mode, then select a channel you want to program.



- 2 Press MENU, then press ◀ or ▶ to display the "OPTION" menu.

MENU
SETUP

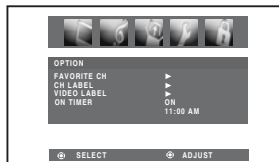

- 3 Press ▼ to highlight the "CH LABEL", then press ▶ to display the "CH LABEL" menu. SET/CLEAR will be highlighted.



- 4 Press ◀ or ▶ to highlight "SET" and press ENTER.



- 5 Press ◀ or ▶ to enter a character in the first space. Press the button repeatedly until the character you want appears on the screen. Then press ENTER.



Repeat step 5 to enter the rest of the characters. Repeat steps 1-5 for other channels.

To erase channel labels:
Select "CLEAR" in step 4 above.

- 6 Press EXIT/CANCEL to return to normal viewing.



To label the video input source

- 1 Press MENU, then press ◀ or ▶ to display the "OPTION" menu.

MENU
SETUP

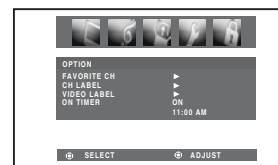

- 2 Press ▼ to highlight the "VIDEO LABEL", then press ▶ to display the "VIDEO LABEL" menu.

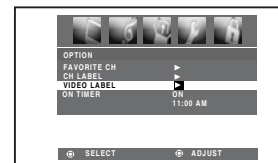

- 3 Press ▲ or ▼ to highlight the video source you want to label, then press ◀ or ▶ to select the desired label for the input source.

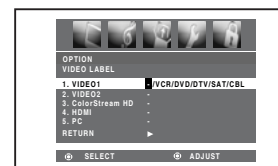
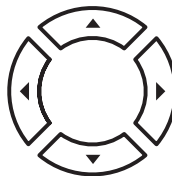

- 4 Press EXIT/CANCEL to return to normal viewing.



TV operation

Setting the GameTimer™ /Using the panel lock feature

With the GameTimer™ feature, you can automatically activate the VIDEO LOCK feature (VIDEO setting) to set a time limit for playing a video game(30,60, 90, 120 minutes).

You can lock the side panel controls to prevent your settings from being changed accidentally (by children, for example). When the panel lock is in ON, all control buttons on the TV/DVD side panel (except POWER) will not operate.

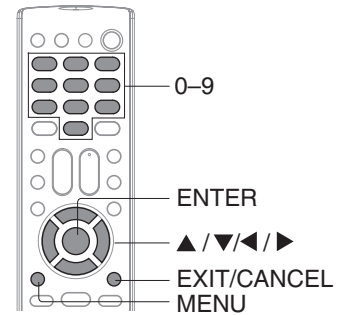

To set up the GameTimer™

- 1** Press MENU, then press ◀ or ▶ to display the "LOCKS" menu.

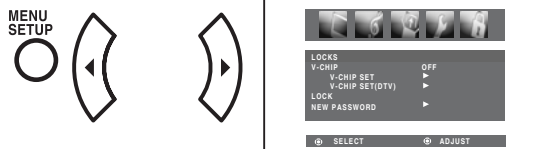

- 2** Press ▼ to display the password entering mode.



- 3** Use the Number buttons (0-9) to enter your password, then press ENTER. The LOCKS menu appears.

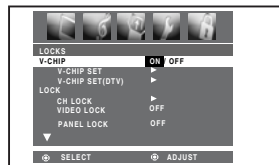
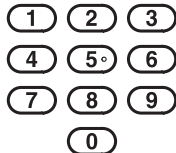

- 4** Press ▲ or ▼ to highlight "GAME TIMER" and press ◀ or ▶ to select a time limit (OFF,30, 60,90,120 minutes or LOCK).

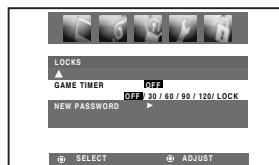
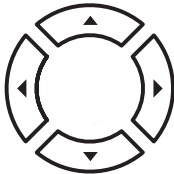

The Game channel cannot be selected and the TV screen will display "Game channel is locked" when GAME button is pressed while "LOCK" is selected.

- 5** Press EXIT/CANCEL to return to normal viewing.



To lock the panel

- 1** Press MENU, then press ◀ or ▶ to display the "LOCKS" menu.

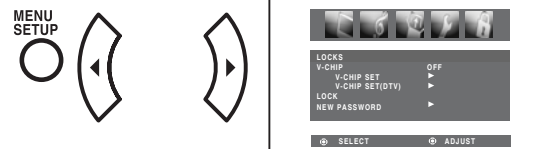

- 2** Press ▼ to display the password entering mode.



- 3** Use the Number buttons (0-9) to enter your password, then press ENTER. The LOCKS menu appears.

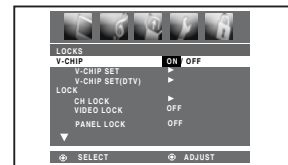
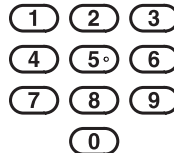

- 4** Press ▲ or ▼ to highlight "PANEL LOCK" and press ◀ or ▶ to highlight ON.

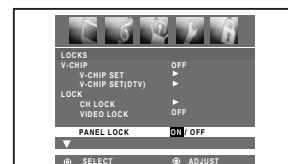
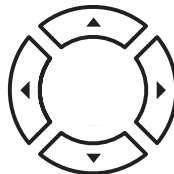

If a button on the side panel is pressed, the message "NOT AVAILABLE" will appear.

- 5** Press EXIT/CANCEL to return to normal viewing.



Note:

After the GameTimer is programmed, the display will appear briefly every ten minutes to remind you that the GameTimer is operating. When the programmed time is reached, the TV/DVD will change channels automatically and enter VIDEO LOCK mode.

To cancel the panel lock

- Select "OFF" in step 4 above.

Viewing the wide-screen picture formats

You can view programs in a variety of picture sizes—NATURAL, THEATER WIDE 1, THEATER WIDE 2, THEATER WIDE 3 and FULL. The way the image displays in any of the picture sizes will vary depending on the format of the program you are viewing.

Select the picture size that displays the current program the way that looks best to you.

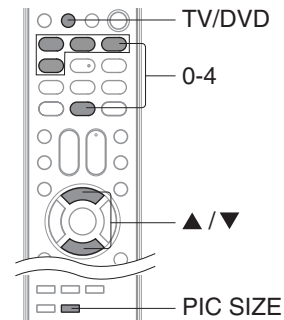

To select the picture size

1 Press TV/DVD to select the TV mode.



2 Press PIC SIZE on the remote control.



3 Press the corresponding number button (0-4) or ▲ / ▼ button to select the desired picture size, as described on the right and on page 38.

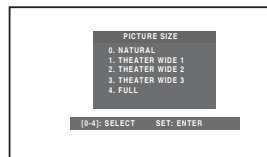
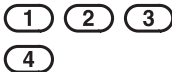

Note:

You can also change the picture size by selecting PICTURE SIZE in the SETUP menu.

About the picture size

NATURAL picture size

- The image is displayed close to its originally formatted proportion. Some program formats will display with side bars and/or bars at the top and bottom.

Natural picture size example: The way the image displays will vary depending on the format of the program you are currently watching.

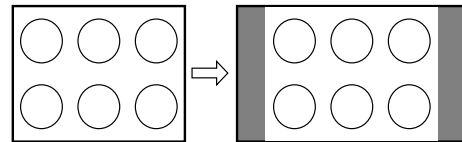

Conventional (4:3) picture on a conventional TV screen

Conventional (4:3) picture in Natural size on your wide-screen TV

THEATER WIDE 1 picture size (for 4:3 format programs)

- The center of the picture remains close to its original proportion, but the left and right edges are stretched wider to fill the screen.
- The top and bottom edges of the picture may be hidden; however, this mode cannot be scrolled.

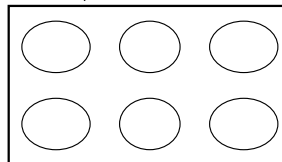
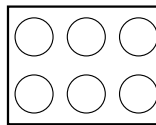

THEATER WIDE 1 picture size example



TV operation

About the picture size

THEATER WIDE 2 picture size (for letter box programs)

- The picture is stretched the same amount both wider and taller (retains its original proportion.)
- The top and bottom edges of the picture may be hidden.

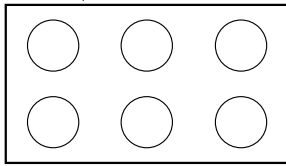
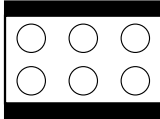

THEATER WIDE 2 picture size example

THEATER WIDE 3 picture size (for letter box programs with subtitles)

- The picture is stretched wider to fill the width of the screen, but only slightly stretched taller.
- The top and bottom edges of the picture may be hidden.

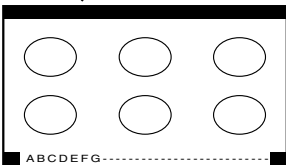
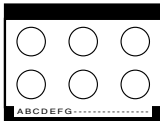

THEATER WIDE 3 picture size example

Note:

If you select THEATER WIDE 2 or 3, the top and bottom edges of the picture may be hidden. To see the hidden edges, try viewing the program in Full picture size.

Full picture size (for 16:9 source programs)

- If receiving a 16:9 format program, the picture is displayed in its original proportion.
- If receiving a 4:3 format program, the picture is stretched wider to fill the width of the screen, but not stretched taller.
- None of the picture is hidden.

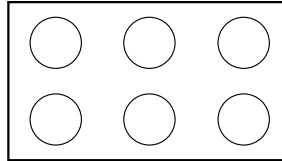
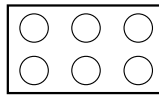

Full picture size example

Using the ASPECT feature

When the ASPECT feature is set to ON and the TV/DVD receives a 480i signal, the picture size is automatically selected.

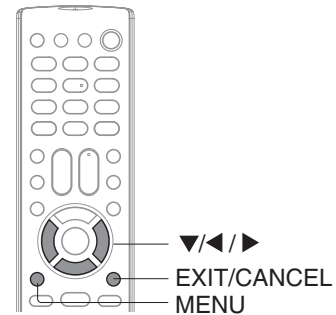

To turn on the ASPECT feature

- 1** Press MENU in the TV mode, then press ◀ or ▶ until the “SETUP” menu appears.

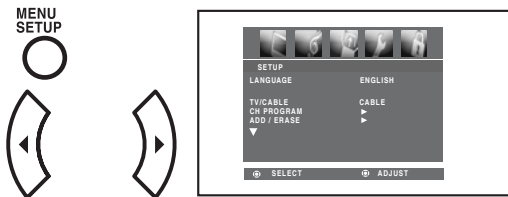

- 2** Press ▼ to highlight “ASPECT”.

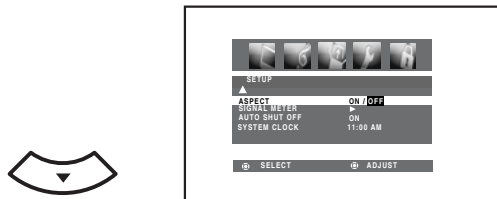

- 3** Press ◀ or ▶ to highlight “ON” or “OFF”.

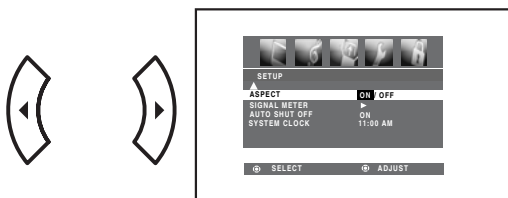

- 4** Press EXIT/CANCEL to return to normal viewing.



When the ASPECT feature is set to ON and the TV/DVD receives a 480i signal, the picture size is automatically selected (as described in the following table).

Aspect ratio of signal source	Automatic aspect size (automatically selected when ASPECT is ON)
4:3 Normal	Natural
16:9 Full	Full
4:3 Letter box	TheaterWide
Not defined	User-set mode

If the signal does not include aspect information, the picture size you selected on page 37 is displayed.

TV operation

Picture control adjustment/ Adjusting the picture mode

Picture controls are factory preset but you can adjust them individually as follows: You can also select four picture modes—Sports, Standard, Movie, and Memory—as described in the following table.

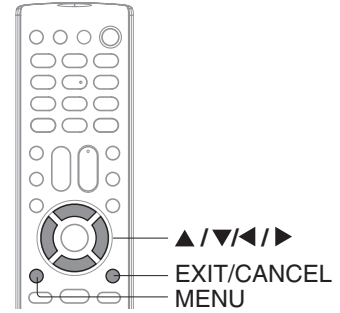

Picture control adjustment

1 Press MENU in the TV mode, then press ◀ or ▶ to display the “PICTURE” menu.

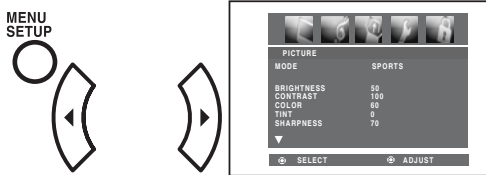

2 Press ▼ to select the item you want to adjust, then press ◀ or ▶ to adjust the setting.

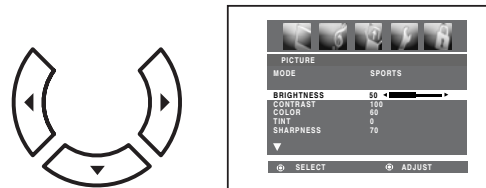

Selection	◀ Pressing ▶	
BRIGHTNESS	darker	lighter
CONTRAST	lower	higher
COLOR	paler	deeper
TINT	reddish	greenish
SHARPNESS	softer	sharper

Note:
The CONTRAST default setting is set to maximum (100) at the factory.

3 Press EXIT/CANCEL to clear the menu screen.



To adjust the picture mode

1 Press MENU in the TV mode, then press ◀ or ▶ to display the “PICTURE” menu.

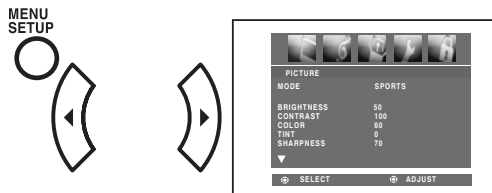

2 Press ▼ to select “MODE”, then press ◀ or ▶ to select the desired picture mode.

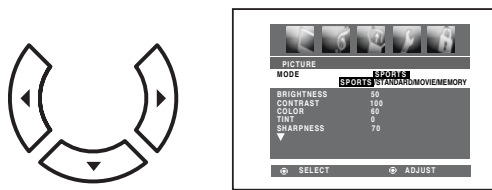

Mode	Picture quality
SPORTS	Bright and dynamic picture (factory-set)
STANDARD	Standard picture quality (factory-set)
MOVIE	Movie-like picture setting (factory-set)
MEMORY	Your personal preferences (set by you; see “Picture control adjustment” as left)

3 Press EXIT/CANCEL to clear the menu screen.



■ **To return your picture adjustments to the factory preset levels**

Press ▲ or ▼ to select “RESET”, then press ◀ or ▶.
The RESET function returns your picture quality adjustments to the following factory settings:

Mode	sports	Tint	center (0)
Brightness	center (50)	Sharpness	center (70)
Contrast	max (100)	Color temperature	cool
Color	center (60)		

Selecting the color temperature/ Adjusting the back lighting

Change the picture quality by selecting from three preset color temperatures-cool, medium and warm.

If your TV/DVD is in a bright room, the screen image may be difficult to see. You can use the BACK LIGHTING feature to adjust the screen brightness for improved picture clarity

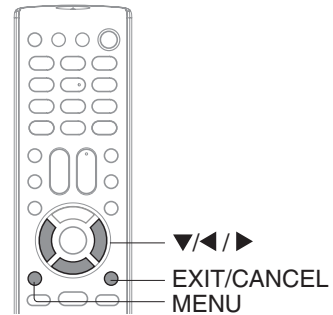

To use the color temperature

- 1 Press MENU in the TV mode, then press ◀ or ▶ to display the "PICTURE" menu.

MENU
SETUP

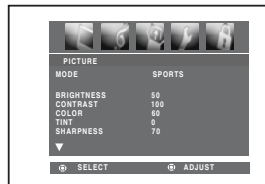
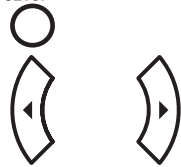

- 2 Press ▼ to select "COLOR TEMPERATURE".

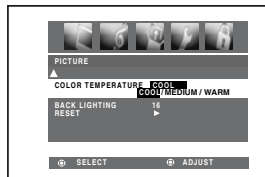

- 3 Press ◀ or ▶ to select the desired color mode.

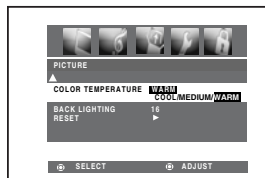

Mode	Picture quality
COOL	Bluish
MEDIUM	Neutral
WARM	Reddish

- 4 Press EXIT/CANCEL to clear the menu screen.



Back Lighting control adjustment

- 1 Press MENU in the TV mode, then press ◀ or ▶ to display the "PICTURE" menu.

MENU
SETUP

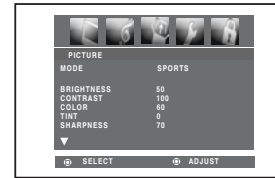
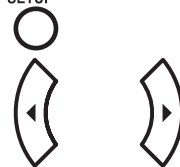

- 2 Press ▼ to highlight "BACK LIGHTING".

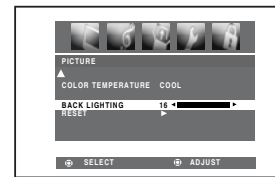

- 3 Press ◀ or ▶ to adjust the "BACK LIGHTING".

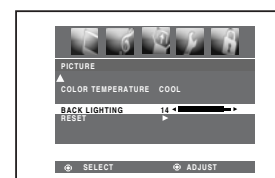

- 4 Press EXIT/CANCEL to return to normal viewing.



TV operation

Sound control adjustment/ Stereo and Second Audio Program (SAP)

Sound controls are factory preset but you can adjust them individually as follows:
The TV/DVD is equipped with a feature known as multi-channel TV sound or MTS.
MTS broadcasts greatly enhance TV viewing by bringing you programs with high fidelity stereo sound.
MTS also provides an extra channel called the Second Audio Program or SAP which broadcasters can use to transmit a second language for bilingual transmission or for other purposes.

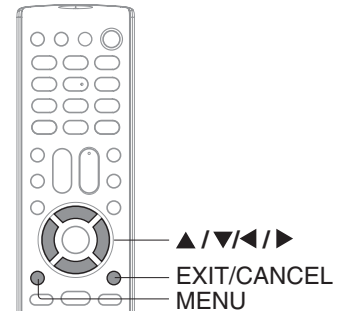

Sound control adjustment

- 1** Press MENU in the TV mode, then press ◀ or ▶ to display the "AUDIO" menu.

MENU

SETUP

◀ ▶

◀ ▶

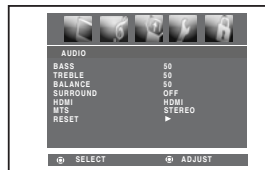

- 2** Press ▼ to select the item you want to adjust, then press ◀ or ▶ to adjust the setting.

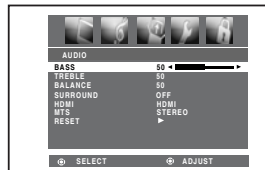
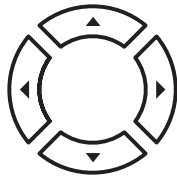
**BASS:**

Press ◀ or ▶ to adjust the bass sound.

TREBLE:

Press ◀ or ▶ to adjust the treble sound.

BALANCE:

Press ◀ or ▶ to obtain an equal sound level from both speakers.

SURROUND:

Press ◀ or ▶ to select "ON" or "OFF".

ON: The dynamic presence and sound created offers a thoroughly enjoyable listening experience.**OFF:** Normal sound.**HDMI**

Press ◀ or ▶ to select "HDMI" or "DVI".

MTS(Analog TV signal)

Press ◀ or ▶ to select "STEREO", "SAP" or "MONO".

AUDIO LANGUAGE(digital TV signal)

Press ▶ to enter the audio language menu, then press ▲ or ▼ to select your desired items. and press ENTER.

- 3** Press EXIT/CANCEL to clear the menu screen.

EXIT/

CANCEL

○

Note:

You also can display the "MTS" menu screen by pressing AUDIO SELECT on the remote control.

■ **To return BASS/TREBLE/BALANCE control adjustments to the factory preset levels**

Press ▲ or ▼ to select "RESET", then press ◀ or ▶.

The RESET function returns your audio adjustments to the following factory settings:

Bass center (50) Treble center (50)

Balancecenter (50)

Listening to stereo sound

Repeat step 1 in "Sound control adjustment" on left, then press ▼ to select "MTS". Then press ◀ or ▶ to select "STR". When the TV is turned on or a channel selection is made, the "STEREO" will appear on the screen when you press DISPLAY.

This means that Stereo broadcasting is available. You can enjoy stereo sound from the left and right speakers.

- When mono broadcasting is received, no indication is displayed.
- If the broadcast signal is not strong enough or clear stereo sound is not available, press select "MONO". The noise should be eliminated. Press it again to return to the stereo sound.



STEREO

Listening to SAP (Second Audio Program)

Repeat step 1 in "Sound control adjustment" on left, then press ▼ to select "MTS". Then press ◀ or ▶ to select "SAP". When the TV is turned on or a channel selection is made, the "SAP" will appear on the screen when you press DISPLAY.

This means that the Second Audio Program broadcasting is available.

STEREO
SAP

Selecting the HDMI™ audio source

See "Connecting to an HDMI or DVI device" on page 20 for connection information.

If you connect a DVI device, you must also connect the analog audio cables to the HDMI audio IN jacks to hear audio. Set the HDMI audio input setting to "DVI" with this connection.

If you connect an HDMI device and play media with digital audio output, set the HDMI audio input setting to "HDMI" with this connection to hear digital audio.

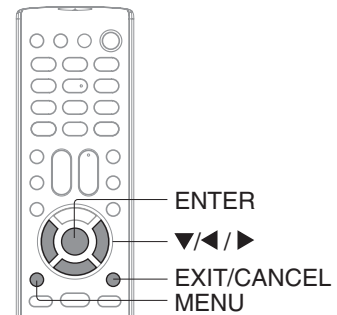

To set the HDMI™ audio input source

If you connect an HDMI device but play media with analog audio output (for example, certain DVDs do not output digital audio), you must also connect the analog audio cables to the HDMI audio IN jacks to hear audio. Set the HDMI audio input setting to "DVI" with this connection.

- 1 Press MENU in the TV mode, then press ◀ or ▶ to display the "AUDIO" menu.

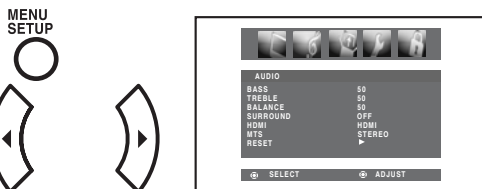

- 2 Press ▼ to select "HDMI" in AUDIO menu.

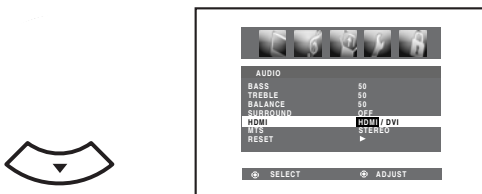

- 3 Press ◀ or ▶ to select "HDMI" or "DVI".

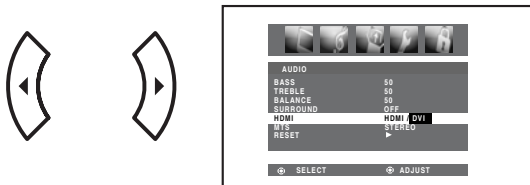

- 4 Press EXIT/CANCEL to clear the menu screen.



Checking the signal meter/ Using the auto shut off feature

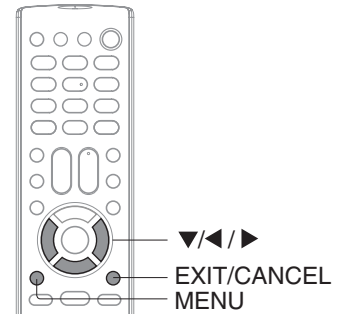

To check the signal meter

You can check the strength of the digital signal by viewing the digital signal meter.

- 1** Press MENU in the TV mode, then press ◀ or ▶ to display the "SETUP" menu.
- 2** Press ▼ to highlight "SIGNAL METER".
- 3** Press ▶ to check the digital signal strength.
- 4** Press EXIT/CANCEL to return to the normal screen.

To use the auto shut off feature

In case of "AUTO SHUT OFF" is "ON", if a station being viewed stops broadcasting, the TV will automatically shut itself off after 15 minutes.

- 1** Press MENU in the TV mode, then press ◀ or ▶ to display the "SETUP" menu.
- 2** Press ▼ to highlight "AUTO SHUT OFF".
- 3** Press ◀ or ▶ to highlight "ON".
- 4** Press EXIT/CANCEL to return to the normal screen.

Notes:

- Signal meter feature is not available for analog channels.
- After approximately 4 minutes, SIGNAL METER screen will return to normal TV-operation automatically.
- When you select a vacant channel, the signal meter may react.

Picture control adjustment in PC mode

There are a number of picture settings you can adjust to optimize the performance of the TV/DVD in PC mode.

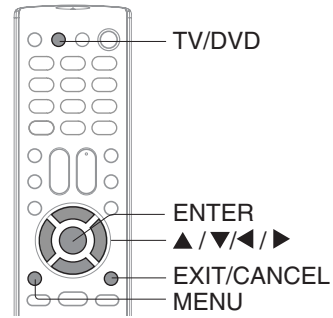

Picture control adjustment

- 1** Press MENU in the PC mode, then press ◀ or ▶ to select "PICTURE".

MENU
SETUP

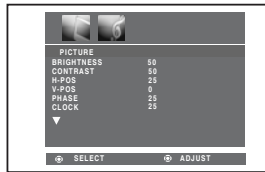

- 2** Press ▼ to select the item you want to adjust, then press ◀ or ▶ to adjust the setting.

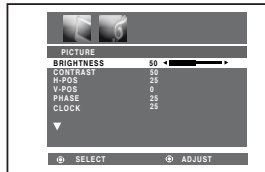

BRIGHTNESS:

Press ◀ or ▶ to adjust the brightness of PC Monitor screen.

CONTRAST

Press ◀ or ▶ to adjust the contrast of PC Monitor screen.

H-POS

Press ◀ or ▶ to adjust the horizontal position of the image on the PC Monitor screen. Each video standard will require a different value for this setting.

V-POS

Press ◀ or ▶ to adjust the vertical position of the image on the PC Monitor screen. Each video standard will require a different value for this setting.

PHASE

Press ◀ or ▶ to adjust after the frequency has been set to optimize picture quality.

CLOCK

Press ◀ or ▶ to adjust to minimize any vertical bars or stripes visible on the screen background.

RED/GREEN/BLUE

Press ◀ or ▶ to adjust the color temperature of the PC Monitor Screen.

BACKLIGHTING

Press ◀ or ▶ to adjust the backlighting of the PC Monitor Screen.

- 3** Press EXIT/CANCEL to clear the menu screen.



- **Resetting your picture adjustments in PC mode**
Press ▲ or ▼ to select "RESET", then press ◀ or ▶. The RESET function returns your picture/audio adjustments to the following factory settings:

Brightness.....	(47)
Contrast.....	(60)
Red.....	(37)
Green.....	(39)
Blue.....	(45)
Backlighting.....	(16)

TV operation

Sound control adjustment in PC mode

There are a number of audio settings you can adjust to optimize the performance of the TV/DVD in PC mode.

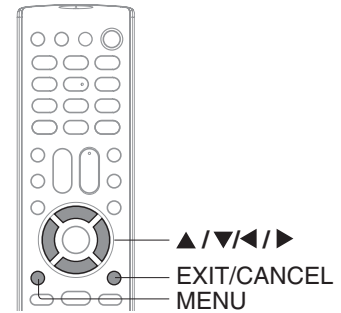

Sound control adjustment

- 1** Press MENU in the PC mode, then press ◀ or ▶ to select "AUDIO"

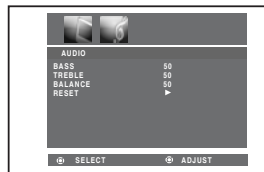
MENU
SETUP

- 2** Press ▼ to select the item you want to adjust, then press ◀ or ▶ to adjust the setting.

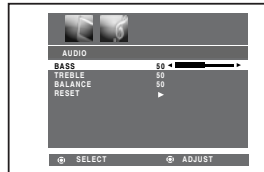
**BASS:**

Press ◀ or ▶ to adjust the bass sound.

TREBLE:

Press ◀ or ▶ to adjust the treble sound.

BALANCE:

Press ◀ or ▶ to obtain an equal sound level from both speakers.

- 3** Press EXIT/CANCEL to clear the menu screen.



■ Resetting your audio adjustments in PC mode

Press ▲ or ▼ to select "RESET", then press ◀ or ▶.

The RESET function returns your picture/audio adjustments to the following factory settings:

Bass center (50)

Treble..... center (50)

Balance.....center (50)

Playing a disc

This section shows you the basics on how to play a disc.

CAUTION

Keep your fingers well clear of the disc slot when disc is loading or unloading. Neglecting to do so may cause serious personal injury.

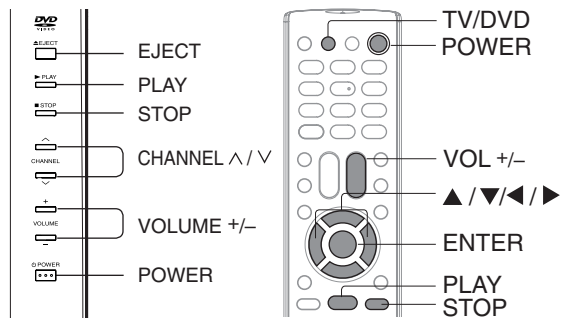

Basic playback

Preparations:

- When connecting to other equipment, turn the power off.

1 Press POWER on the unit or on the remote control to turn on the unit.

The Power indicator on the front of the main unit will change from red to green.

- Every time you press **POWER**, the TV/DVD starts from TV mode.
- When using an amplifier, switch on the amplifier.

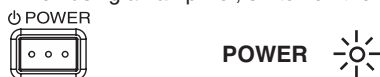

2 Press TV/DVD on the remote control to select DVD mode.

The DVD startup screen will appear on the TV screen.



3 Load a disc in the disc slot.

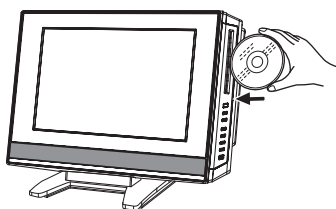

Load the disc in the disc slot with the label side facing forward. (If the disc has a label.) Hold the disc without touching either of its surfaces, align it with the guides, and place it in position.

4 On the TV screen, "▲" changes to "Loading" and then playback commences.



A menu screen will appear on the TV screen if the disc has a menu feature. Press ▲/▼ or ◀/▶ on the remote control to select title, then press **ENTER**. Title is selected and play commences.

5 Press VOLUME + or - to adjust the volume.

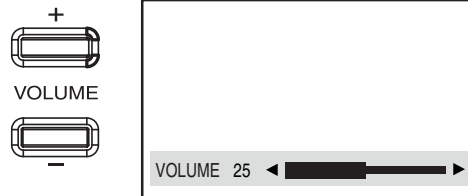

6 Press STOP to end playback.



Resuming facility

- The unit records the stopped point, depending on the disc. "■ STOP" appears on the screen. Press **PLAY** to resume playback (from the scene point).
- If you press **STOP** again ("■ STOP" appears on the TV screen.), the unit will clear the stopped point.

To start playback in the stop mode

Press **PLAY**.



Note:

If the unit does not operate properly:

Static electricity, etc., may affect the TV/DVD's operation. In such case, disconnect the AC cord, then connect it again.



Basic playback

Basic playback

■ To obtain a higher quality picture

Occasionally, some picture noise may appear on the TV screen while playing a DVD video disc because the high resolution pictures on these discs include a lot of information. In such case, you may reduce the SHARPNESS with the Picture control adjustment menu (see page 40).

■ About

The    icons on the heading bar show the playable discs for the function described under that heading.

 : You can use this function with DVD video discs.

 : You can use this function with Video CDs.

 : You can use this function with Audio CDs and CD-R/RW CDs.

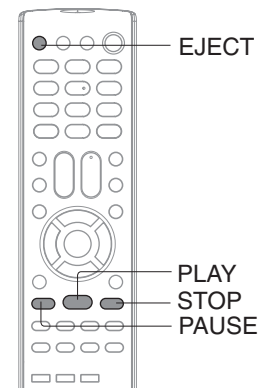

Basic playback

■ To pause playback (still mode)

Press **PAUSE** during playback.



To resume normal playback, press **PLAY**.



- The sound is muted during still mode.

■ To stop playback

Press **STOP**.



■ To remove the disc

Press **EJECT**.



Remove the disc after the disc comes out.

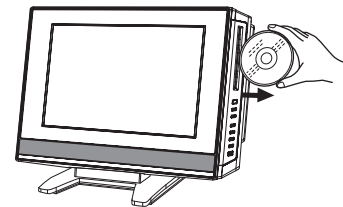

Notes:

- If a non-compatible disc is loaded, "No Valid Disc" or "Disc region incorrect" will appear on the TV screen according to the type of loaded disc. In this case, check your disc again (see pages 8 and 68).
- Some discs may take a minute or so to start playback.
- When you set a single-faced disc label backwards (ie. the wrong way up), "Loading" will appear on the display for a few minutes and then "No Valid Disc" will continue to be displayed.
- Some discs may not work the resuming facility.
- Some playback operations of DVDs may be intentionally fixed by software producers. Since this unit plays DVDs according to the disc contents the software producers designed, some playback features may not be available. Also refer to the instructions supplied with the DVDs.
- Do not move the unit during playback. Doing so may damage the disc.
- Use the EJECT button to unload and eject the disc.
- Do not put any objects other than discs on the disc slot. Doing so may cause the unit to malfunction.
- There may be a slight delay between the button is pressed and the function activates.

Playing a disc (Continued)

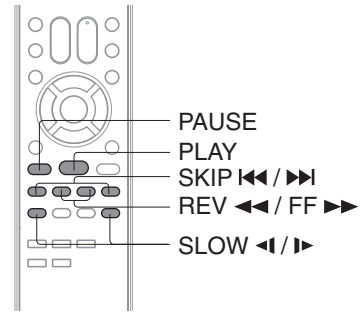

DVD VCD CD Playing in fast reverse or fast forward directions

Press **REV** or **FF** during playback.



REV: Fast reverse playback
FF: Fast forward playback

Each time you press **REV** or **FF** button, the playback speed changes.

■ To resume normal playback

Press **PLAY**.



Notes:

- The TV/DVD mutes sound during reverse and forward scan of DVD and Video CD discs. However, the TV/DVD plays sound during fast forward or fast reverse play of audio CDs.
- The playback speed may differ depending on the disc.

DVD VCD Playing frame by frame

Press **PAUSE** during still playback.



Each time you press **PAUSE**, the picture advances one frame.

■ To resume normal playback

Press **PLAY**.



Note:

The sound is muted during frame by frame playback.

DVD VCD Playing in slow-motion

Press **SLOW ◀** (REVERSE) or **SLOW ▶** (FORWARD) during playback.



Each time you press the button, the slow-motion speed changes.

■ To resume normal playback

Press **PLAY**.



Note:

The sound is muted during slow-motion playback.

DVD VCD CD Locating a chapter or track

Press **SKIP ◀◀** or **▶▶** repeatedly to display the chapter or track number you want.

Playback starts from the selected chapter or track.



To locate succeeding chapters or tracks.



Playback starts from the beginning of the preceding chapter or track.

Note:

A "Prohibition" symbol "⊘ Invalid operation" or "⊘ not allowed at the moment" may appear at the upper right of the screen. This symbol means either the feature you tried is not available on the disc, or the TV/DVD cannot access the feature at this time. This does not indicate a problem with the TV/DVD.

Zooming/Locating desired scene

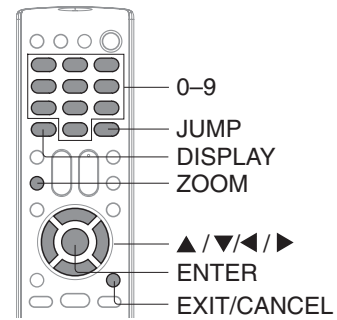

Zooming

This unit will allow you to zoom in on the frame image. You can then make selections by switching the position of the frame.

- 1 Press ZOOM during playback.**

INPUT ZOOM

The center part of the image will be zoomed in. Each press of **ZOOM** will change the ZOOM $\times 2$, $\times 3$ and $\times 4$.
- 2 Press $\uparrow/\downarrow/\leftarrow/\rightarrow$ to view a different part of the frame.**

You may move the frame from the center position to UP, DOWN, LEFT or RIGHT direction.
- 3 In the zoom mode, press ZOOM repeatedly to return to a 1:1 view (Off).**

INPUT ZOOM

Notes:

- You can select the Pause, Slow or Search playback in the zoom mode.
- Some discs may not respond to zoom feature.

Locating desired scene

Use the title, chapter and time recorded on the DVD disc to locate the desired point to playback. In the case of VCD/Audio CD discs, time and track are used to locate the desired point to playback.

To check the title, chapter/track and time, press **DISPLAY**.

- 1 Press JUMP during playback or resume stop mode.**

JUMP
- 2 Press \uparrow or \downarrow to select the "Time", "Title/Track" or "Chapter".**
- 3 Press Number buttons (0-9) to input the number.**

 - If you input a wrong number, press **EXIT/CANCEL**.
 - Refer to the package supplied with the disc to check the numbers.
- 4 Press ENTER. Playback starts.**

ENTER

 - When you change the title, playback starts from Chapter 1 of the selected title.
 - Some discs may not work in the above operation.

Marking desired scenes

The unit stores the points that you want to watch again up to 3 points. You can resume playback for each scene.

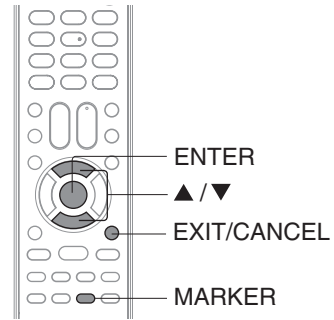

DVD VCD Marking the scenes

1 Press **MARKER** during playback.



Bookmark 1	---	---	---
Bookmark 2	---	---	---
Bookmark 3	---	---	---

2 Select the blank Marker using **▲** or **▼**. Then press **ENTER** to mark the desired scene.



- Repeat this procedure to mark the other 2 scenes.

Bookmark 1	00	: 27	: 54
Bookmark 2	---	---	---
Bookmark 3	---	---	---

3 Press **MARKER** to clear the display.



DVD VCD Returning to the scenes

1 Press **MARKER** during playback.



Bookmark 1	00	: 27	: 54
Bookmark 2	01	: 16	: 25
Bookmark 3	02	: 08	: 31

2 Press **▲** or **▼** to select the Marker 1-3.



Bookmark 1	00	: 27	: 54
Bookmark 2	01	: 16	: 25
Bookmark 3	02	: 08	: 31

3 Press **ENTER**.



Playback starts from the marked scene.

Advanced playback

Notes:

- Some discs may not work with the marking operation.
- The marking is canceled when you eject the disc or turn the power off.
- Some subtitles recorded around the marker may fail to appear.

■ To cancel the Marker

Follow the above steps 1~2, then press **EXIT/CANCEL**.

Repeat playback/A-B Repeat playback

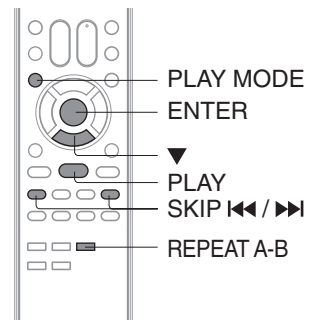

DVD VCD Repeat playback

1 Press **PLAY MODE** during playback.



2 [DVD]
Press **▼** to select "Repeat".
Press **ENTER** repeatedly to select "Single" or "All".



The unit automatically starts repeat playback after finishing the current title or chapter.

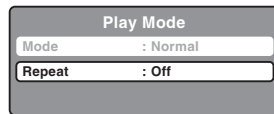

[Video CD]
Press **▼** to select "Repeat".
Press **ENTER** repeatedly to select "Single" or "All".



The unit automatically starts repeat playback after finishing the current track.

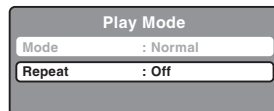

[Audio CD and MP3/WMA CD]
Please see "Repeat playback (CD)" **61**.

3 Press **PLAY MODE** again to clear the screen.

■ To resume normal playback

Select Repeat : "Off" in step 2.

Notes:

- Some discs may not work with the repeat operation.
- **SKIP I◀◀ or ▶▶I** function is not available whenever Chapter/Track repeat function is on ("Single" selected).

DVD VCD A-B Repeat playback

A-B repeat playback allows you to repeat a section between two selected points.

1 Press **REPEAT A-B** during playback.



The start point is selected.

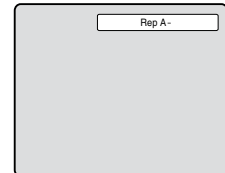

2 Press **REPEAT A-B** again.



The end point is selected. Playback starts at the point that you selected. Playback stops at the end point and returns to Point A automatically, then starts again.

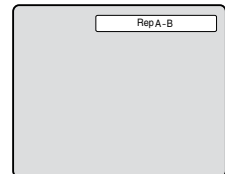

■ To resume normal playback

Press **REPEAT A-B** again.



"Rep AB Off" appears on the screen.

Notes:

- In A-B Repeat mode, subtitles near the A or B locations may not be displayed.
- You may not be able to set A-B Repeat during certain scenes of the DVD.

Program playback/Shuffle playback

You can arrange the playback order of titles, chapters or tracks on the disc.

You can program up to 12 titles (chapters) or tracks.

For Audio CD and MP3/WMA CD, please see "Random playback (CD)" [61](#) and "Program playback (CD)" [62](#).

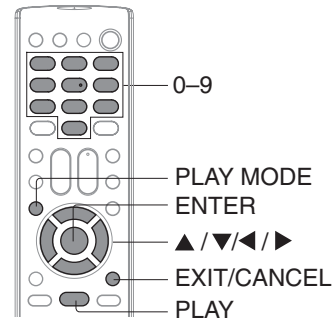

DVD VCD Program playback

1 Press **PLAY MODE** in the stop mode.



2 Press **▲** or **▼** to select "Mode", then press **ENTER** repeatedly to select "Program".

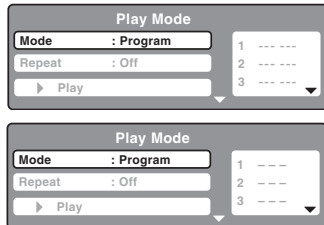

3 Press **◀/▶** to select the programming position. Press **▲/▼** and then use **Number buttons (0-9)** to input the title/chapter or track.

- To program others, repeat this step.
- If you input a wrong number, press **EXIT/CANCEL**.

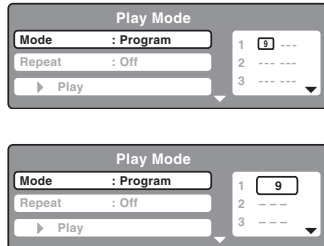
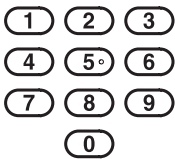

4 Press **◀/▶** to return to the left column, then press **▲/▼** to select the "▶ **PLAY**" and press **ENTER**.

- The programs you selected will start to playback in order.
- To resume normal playback, select Mode: "Normal" in step 2.

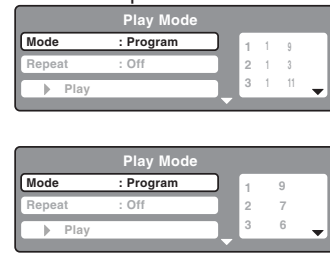
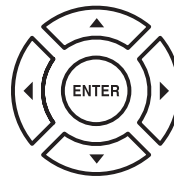

To change the program

- Select Mode to "Program" (as step 2), press **▲/▼/◀/▶** to select the track number you want to change.
- Press **Number buttons (0-9)** to input the new track number.

To clear the program one by one

Select Mode to "Program", press **▲/▼/◀/▶** to select the track number you want to cancel. Then press **EXIT/CANCEL**.

To clear all the programs

At the left column, press **▲/▼** to select "Clear Program". Then press **ENTER**.

Notes:

- In playing back the Video CD with PBC, you cannot set Program playback.
- The program is canceled when you eject the disc or turn the power off.

DVD VCD Shuffle playback

1 Press **PLAY MODE** in the stop mode.



2 Press **▲/▼** to select "Mode", then press **ENTER** repeatedly to select "Shuffle".



3 Press **PLAY**.



The Shuffle Playback will start.

- If you set "Shuffle" during playback mode, Shuffle playback will begin after the track that is currently being played has ended.
- To resume normal playback, select Mode: "Normal" in step 2.

Note:

In case of Video CD with PBC, you cannot set Shuffle function during playback.

Changing angles/Title selection/DVD menu

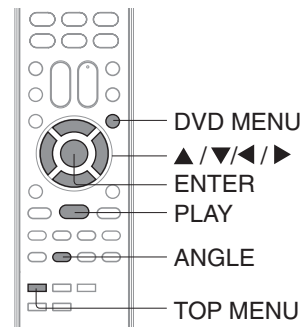

DVD Changing angles

When playing back a disc recorded with multi-angle facility, you can change the angle that you are viewing the scene from.

- 1 Press ANGLE during playback.**
The current angle will appear.

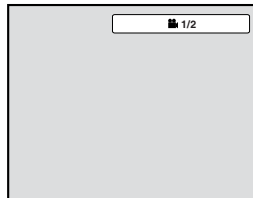

- 2 Press ANGLE repeatedly until the desired angle is selected.**



Note:

Depending on the DVD, you may not be able to change the angles even if multi-angles are recorded on the DVD.

DVD Title selection

Two or more titles are recorded on some discs. If the title menu is recorded on the disc, you can select the desired title.

- 1 Press TOP MENU during playback.**
Title menu appears on the screen.



- 2 Press ▲/▼/◀/▶ to select the desired title.**



- 3 Press ENTER or PLAY.**



The playback of the selected title will start.



Notes:

- Depending on the DVD, you may not be able to select the title.
- Depending on the DVD, a "title menu" may simply be called a "menu" or "title" in the instructions supplied with the disc.

DVD DVD menu

Some DVDs allow you to select the disc contents using the menu.

When you playback these DVDs, you can select the subtitle language and soundtrack language, etc. using the menu.

- 1 Press DVD MENU during playback.**
The DVD menu appears on the TV screen.
- Press **DVD MENU** again to resume playback at the scene when you pressed **DVD MENU**.



- 2 Press ▲/▼/◀/▶ to select the desired item.**



- 3 Press ENTER.**



The menu continues to another screen. Repeat steps 2 and 3 to set the item completely.

Note:

Depending on the DVD, you may not be able to resume playback from the scene point when you press the DVD MENU button.

Changing soundtrack language/Subtitles

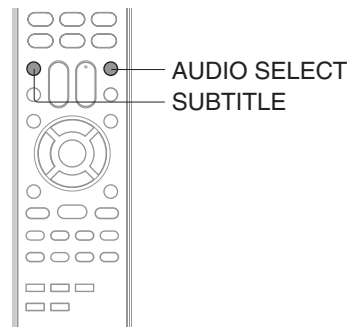

DVD VCD Changing soundtrack language

You can select the language when you play a multilingual disc.

1 Press AUDIO SELECT during playback.
 AUDIO SELECT The current soundtrack language will appear.

2 Press AUDIO SELECT repeatedly until the desired language is selected.

- The on screen display will disappear after a few seconds.

In case of Video CD playback

Audio type changes as follows each time you press **AUDIO SELECT**.

Left → Right → Mix → Stereo

Notes:

- If the desired language is not heard after pressing the button several times, the language is not recorded on the disc.
- The selected soundtrack language is canceled when you eject the disc. The initial default language or available language will be heard if the disc is played back again.
- If you select DTS in playing DTS-encoded disc, no sound will be heard from the TV/DVD's speakers.

DVD Subtitles

When playing back a disc recorded with subtitles, you can select the subtitle language or turn the subtitle off.

1 Press SUBTITLE repeatedly during playback until the desired language is selected.

2 To turn off the subtitle, press SUBTITLE until "Off" appears.

- The on screen display will disappear after a few seconds.

Notes:

- Depending on the DVD, you may not be able to change subtitles, or to turn subtitles on or off.
- While playing a DVD, the subtitle may change when you loaded or eject the disc.
- In some cases, a selected subtitle language may not be changed immediately.

Advanced playback

Disc status/To turn off the PBC

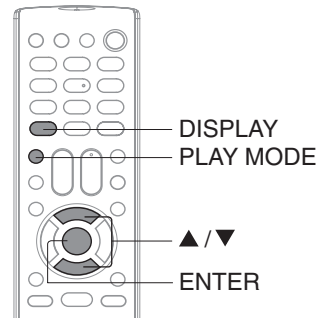

Disc status

1 Press **DISPLAY** to display the status of the disc on the screen as follows.

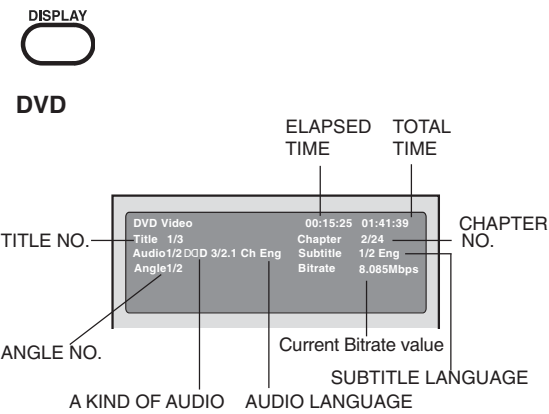

Video CD

2 To cancel the display, press **DISPLAY** again.



To turn off the PBC (see page 8)

1 Press **PLAY MODE** in the stop mode.



2 Press **▲/▼** to select "Mode", then press **ENTER** repeatedly until "Normal" appear.



3 Press **PLAY MODE** again to clear the screen.



■ To turn on the PBC

Follow the above steps 1~2, then press **ENTER** repeatedly until "PBC" appear. Press **RETURN** to return to the PBC menu during playback.

MP3/WMA/JPEG/DivX® and Audio CD operation

This player can playback the MP3/WMA/JPEG/DivX®-data which has been recorded on CD-R or CD-RW. To produce the MP3/WMA/JPEG/DivX®-data, you need a Windows-PC with CD-RW drive and a MP3/WMA/JPEG/DivX®-encoding Software (not supplied). The Apple-HFS-System cannot be played.

This player requires discs/recordings to meet certain technical standards in order to achieve optimal playback quality. There are many different types of recordable disc formats (including CD-R containing MP3/WMA files). Not all recordable discs will produce optimal playback quality. The technical criteria set forth in this owner's manual are meant only as a guide. Use of CD-RW for MP3 files is not recommended.

You must obtain any required permission from copyright owners to download or use copyrighted content. Toshiba cannot and does not grant such permission.

CD Audio CD/MP3/WMA/JPEG/DivX® CD information

Limitations on MP3/WMA/JPEG/DivX® CD playback

- MP3/WMA/JPEG/DivX® CD is the disc that is standardized by ISO9660, its file name must include 3-digits extension letters, ".mp3", ".wma", ".jpg", ".div", ".divx", ".avi".
- MP3/WMA/JPEG/DivX® CD must be corresponded to the ISO standardized files.
- This unit can read 600 files per directory. If one directory has more than 600 files, it reads up to 600 files, the remaining files will be omitted.
- The unit is able to recognize up to a maximum of 50 directories per disc.
- MP3/WMA/JPEG/DivX® CDs cannot be used for the purpose of recording.
- If the CD has both CDA audio tracks and MP3/WMA/JPEG/DivX® files, only the CDA audio tracks will be played.
- It may take more than one minute for this unit to read MP3/WMA/JPEG/DivX® files depending on its structure.
- Music recorded by "Joliet Recording Specification" can be played back, the file name is displayed (within 15 letters) on the screen. Long file names will be condensed.
- The music files recorded by "Hierarchical File System" (HFS) cannot be played.

Limitations on display

- The maximum number for display is 15 letters.
Available letters for display are the following:
capital or small alphabets of A through Z, numbers of 0 through 9, and _ (under score).
- Other letters than those above are replaced in hyphen.

Notes on MP3/WMA/JPEG/DivX® files

To playback MP3/WMA/JPEG/DivX® CD in the recorded order,

1. Use MP3/WMA/JPEG/DivX® software that records data alphabetically or numerically.
2. Name each file including two-digit or three-digit number (ex. "01" "02" or "001" "002").
3. Refrain from making too many sub-folders.

CAUTION:

- Some MP3/WMA/JPEG/DivX® CDs cannot be played back depending on the recording conditions.
- The CD-R/RW that has no music data or non MP3/WMA/JPEG/DivX® files cannot be played back.

Standard, sampling frequency and the bit rate:

MP3 CD

MPEG-1 Audio

32kHz, 44.1kHz, 48kHz

32kbps ~ 320kbps (constant bit rate or variable bit rate)

The recommend recording setting for a high-quality sound is 44.1kHz of sampling frequency and 128kbps of constant bit rate.

WMA CD

WMA version 7 and 8

32kHz/48kbps, 44.1kHz/48kbps~192kbps, 48kHz/128kbps~192kbps

The file recorded by mono, 48kHz, 48 kbps is not available to this unit.

DivX® video

DivX® version: DivX® 3, 4, 5, and 6 (specifically 3.1.1, 4.1.2, 5.0.2, 5.0.5, 5.1.1, 5.2.1, 6.0 at Home Theater profile).

Audio format: MPEG1 Layer2 (MP2), MPEG1 Layer3 (MP3)

Sampling frequencies: 32kHz, 44.1kHz, 48kHz

Bit rate: 32kbps ~ 320kbps

Resolution: Max 720 x 576 (at 25fps), Max 720 x 480 (at 30fps)

Microsoft, Windows Media, and Windows Logo are either registered trademarks or trademarks of Microsoft Corporation in the United States and/or other countries.

DivX, DivX Certified, and associated logos are trademarks of DivX, Inc. and are used under license.

Advanced playback

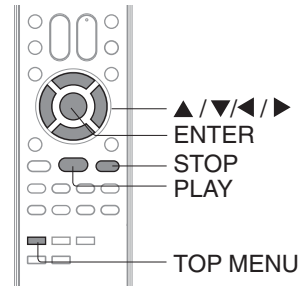

MP3/WMA CD playback

1 Load a disc on which MP3 or WMA files have been recorded in the disc slot.

2 A file browser screen will appear on the screen.

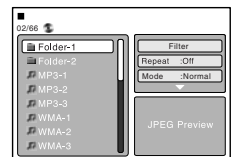

3 Press ▲/▼ to select file.

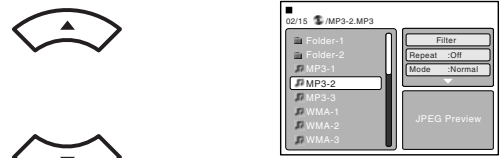

- In case the current directory includes more than 8 files, press ▲ or ▼ to scroll in the file list.
- To see contents in folder, select the folder and then press **ENTER**. To return to the parent directory, select “**⋮**” then press **ENTER**.
- When **PLAY** is pressed after the file browser displayed, playback begins automatically starting from the first file. In this case, if the first file is an MP3/WMA file, only MP3/WMA files are played back in order. If the first file is a JPEG file, the first JPEG file is played back. If the first file is a DivX® file, the first DivX® file is played back. If there is no file at a root directory, playback does not begin automatically.

4 Press **ENTER**.
The selected file starts playing back.



5 Press **STOP** to end playback.



- The unit records the stopped point. “**■ STOP**” appears on the TV screen. Press **PLAY** to resume playback (from the scene point).
- If you press **STOP** again or unload the disc, the unit will clear the stopped point.

About file menu

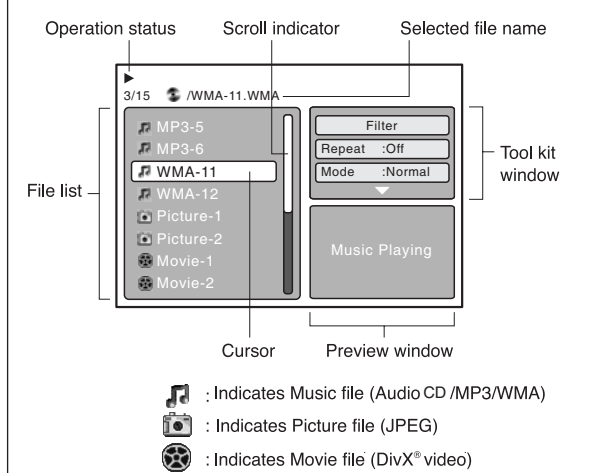

- : Indicates Music file (Audio CD /MP3/WMA)
 - : Indicates Picture file (JPEG)
 - : Indicates Movie file (DivX® video)
- Notes:**
- The thumbnail list is displayed when the FUJICOLOR CD or the Kodak Picture CD are played. To display the file browser, press **TOP MENU**.
 - In the case of a CD containing a mixture of MP3, WMA, JPEG and DivX® files, the files are played back by selecting them from the file browser.
 - MP3 or WMA file on the Kodak Picture CD is not recognized on this unit.

- Notes:**
- During MP3/WMA/JPEG DivX® Playback, you can use JUMP and A-B Repeat functions.
 - You can use Repeat (Track or All), Shuffle functions and Program playback for Audio CD/MP3/WMA/JPEG/DivX® CD Playback **[53]**, **[54]**.

- Select Files**
- The file type to make it display in the file browser can be chosen.
1. Press ◀ or ▶ to highlight “Filter” at right column in the file browser.
 2. Press **ENTER**, then press ▲ or ▼ to select file type from the list (Audio, Photo or Video).
 3. Press **ENTER** to add/remove check mark.
Checked file type will be displayed in the file browser.
 4. Press ◀ to save the setting.

MP3/WMA/JPEG/DivX® and Audio CD operation (Continued)

You can select your desired JPEG file on the file menu and picture menu. The selected JPEG file is automatically adjusted to the TV screen. (When the aspect ratio of the JPEG file is different to the TV screen, the black bar will appear at the top and bottom, or the both sides of the TV screen.)

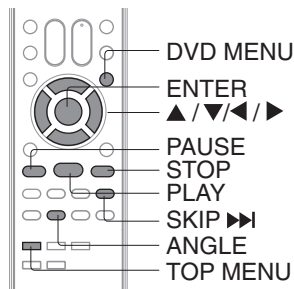

CD JPEG CD playback

1 Load a JPEG disc in the disc slot.

2 A file browser screen will appear on the screen.

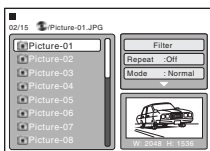

3 Press ▲/▼ to select the file. To display a thumbnail list, press **TOP MENU**. Press ◀/▶/▲/▼ to select the desired file. (To return to the file browser, press **DVD MENU**.)



- When **PLAY** is pressed after displaying the file browser, playback begins automatically starting from the first file. In this case, if the first file is a JPEG file, the first JPEG file is played back. If the first file is a DivX® file, the first DivX® file is played back. If the first file is an MP3/WMA file, only MP3/WMA files are played back in order. If there is no file at a root directory, playback does not begin automatically.

4 Press **ENTER** or **PLAY**. The selected picture appears on the screen.



Rotating an image

Press ▶/▼/◀/▲ during playback of the image. "90°", "180°", "270°" or "No rotation" appears on the screen.

5 Press **STOP** to end playback. The file browser appears on the screen. If you want to watch the other file, repeat steps 3 ~ 4.



CD Slide show playback

The slide show enables you to view pictures (files) one after another automatically.

Preparation:

- Set "JPEG Interval" setting to "5 Seconds", "10 Seconds" or "15 Seconds" [66].

1 Select your desired starting file for the slide show in the step 3 on left.

2 Press **ENTER** or **PLAY** to start slide show from the selected file.



- If you press **PAUSE** during the slide show, the slide show stops temporary. "II PAUSE" appears briefly on the TV screen. Press **PLAY** or **SKIP ►►** again to resume the slide show.
- When the slide show playback finished, the file list appears.
- To stop the slide show, press **STOP**. The file list appears.

Notes:

- Zoom function also can be used in viewing JPEG files. See "Zooming" [50].
- During JPEG playback, you cannot use Jump and A-B Repeat functions.

Advanced playback

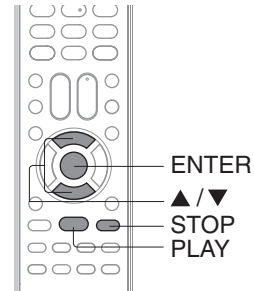

CD DivX® CD playback

1 Load a disc on which DivX® files have been recorded in the disc slot.

2 A file browser screen will appear on the TV screen.

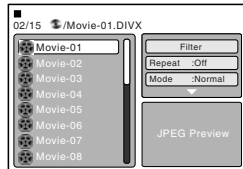

3 Press ▲ / ▼ to select file.



- When **PLAY** has been pressed after displaying the file browser, playback begins automatically starting from the first file. In this case, if the first file is a JPEG file, the first JPEG file is played back. If the first file is a DivX® file, the first DivX® file is played back. If the first file is an MP3/WMA file, only MP3/WMA file are played back in order. If there is no file at a root directory, playback does not begin automatically.

4 Press **ENTER** or **PLAY**. The selected DivX® movie will be played back on the TV screen.

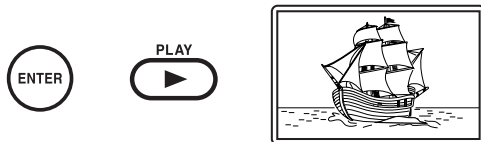

5 Press **STOP** to end playback.



The file browser appears on the TV screen. If you want to watch the other file, repeat steps 3 ~ 4.

CD Playing DivX® VOD content

DivX® VOD content is protected by DRM (Digital Rights Management) system. This restricts playback of content to specific registered devices.

If the incorrect DRM file is loaded, “Authorization Error This player is not authorized to play this video.” will appear on the TV screen. When you attempt to play DivX® VOD, the number of plays is limited and the right message will appear on the TV screen. If you wish to play it, select “Yes”.

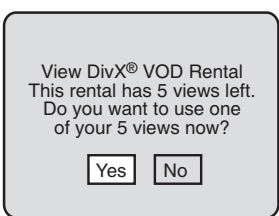

- If the number of plays goes over the limit, then “Rental Expired” will be displayed. In this case the file will not be played.

Note:

In order to play DivX® VOD content on this unit, you first need to register the unit with registration code. See page [69](#).

Repeat, Shuffle and program playback using the browser

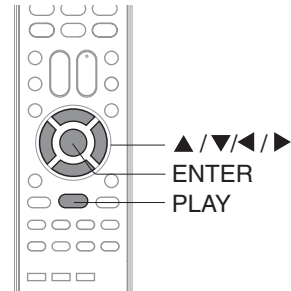

CD Repeat playback (CD)

1 In the file browser, press ◀/▶/▲/▼ to select "Repeat" during stop mode.

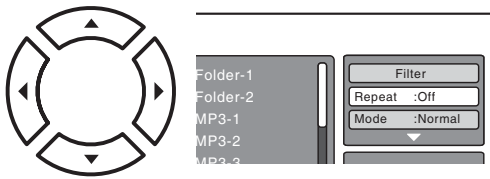

2 Press ENTER repeatedly to select "Single" or "Folder".

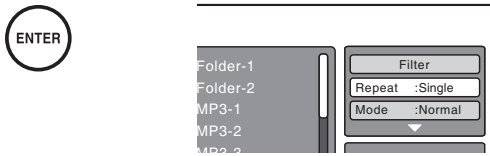

3 Press PLAY. The unit automatically starts repeat playback after finishing the current track.



CD Shuffle playback (CD)

1 In the file browser, press ◀/▶/▲/▼ to select "Mode" during stop mode.

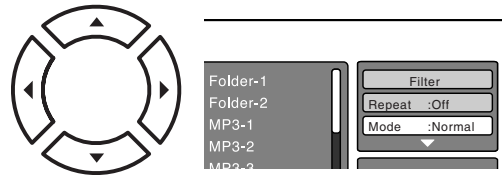

2 Press ENTER to select "Shuffle".

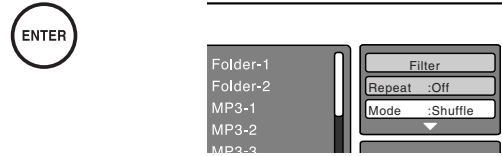

3 Press PLAY. The Shuffle playback will start.



Advanced playback

■ **To resume normal playback**
Select Repeat : "Off" in step 2.

■ **To resume normal playback**
Select Mode : "Normal" in step 2.

Notes:

- The program is canceled when you eject the disc or turn the power off.
- In case of Audio CD, the function of A-B Repeat can be used. See "A-B Repeat playback" (52).

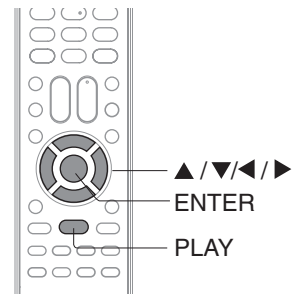

CD Program playback (CD)

1 In the file browser, press **◀/▶/▲/▼** to select “Edit mode”, then press **ENTER**.

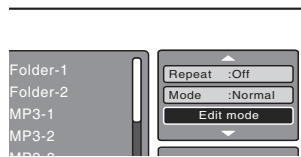
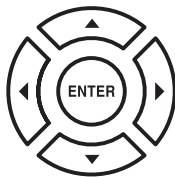

When “Edit mode” is black color, you can mark the files which you want to add into Program list.

2 Press **◀/▶/▲/▼** to select file you want to add into the program list.

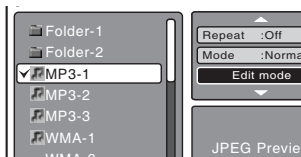
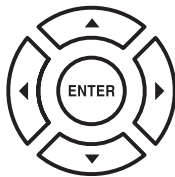

Press **ENTER**. Selected file was marked. Repeat this procedure to select the other files.

3 Press **◀/▶/▲/▼** to select “Add to program”. Then press **ENTER**. All marked files are added into the program list.

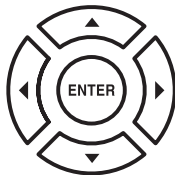

- When you finish storing the files which you want into the Program list, select “Edit mode” and press **ENTER** to release edit mode.

4 Press **◀/▶/▲/▼** to select “Program view”, then press **ENTER**. Program view shows only the programmed files that you have added in step 2.

Browser view

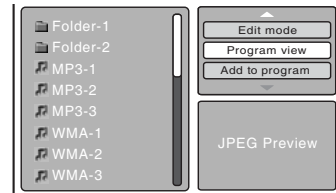

Program view



5 In the Program view, press **PLAY**. The files start to playback in programmed order that were added by you.

■ **To remove file from program list in stop mode**
In the Edit mode, switch to Program view. Select file you want to remove, then press **ENTER**. Select “Clear program” and press **ENTER**. Marked file is removed from program list.

Customizing the function settings

You can change the default settings of the DVD mode to customize performance to your preference.

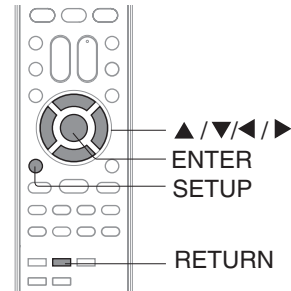

DVD VCD CD Setting procedure

1 Press SETUP during stop mode.
 The following on-screen display appears.

MENU SETUP

4 Then press ► or ENTER. The selectable settings will appear.

2 Press ▲ or ▼ to select the desired section, then press ►.

5 Change the selection using ▲ or ▼, by referring to the corresponding pages 65 ~ 69. Press ENTER to save the setting.





- Repeat steps 3 and 5 to change other option.
- To select another section, go back to step 2 by pressing ◀ repeatedly.

3 First option will be highlighted. Press ▲ or ▼ to select the desired option.

6 To clear SETUP screen, press SETUP or RETURN.

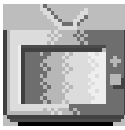
Function setup

Setting details

Section	Option	Details	Page
 Language	OSD menu	To select a preferred language for the setup menus.	65
	Subtitle Audio DVD Menu	To select the language of "Subtitle", "Audio" and "DVD Menu" if more than one languages are available on the disc.	
 Video	Aspect Ratio	To select a picture size according to the aspect ratio of your TV.	65
	View Mode	To select a preferred picture mode from "Fill", "Original", "Auto Fit" or "Pan Scan".	66
	JPEG Interval	To select a preferred setting for the slide show playback.	
 Audio	E.A.M.	To select a preferred audio enhancement.	67
	D.R.C.	To select On or Off for DRC (Dynamic Range Control).	67
	Digital Out	To select an output sound format corresponding to your system connection.	67
 Rating	Parental Control	To select a preferred parental level for the parental setting.	68
	Set Password	Input 4-digit password to set the parental level.	68
	PBC	To use the menu screen when playing a PBC-controllable VIDEO CD	68
 Default	Default	To restore all settings to the factory set.	69
	DivX Registration	To display your 8-character registration code.	69

Customizing the function settings (Continued)

Setting details



Language

Language	OSD Menu	: English
Video	Subtitle	: English
Audio	Audio	: English
Rating	DVD menu	: English
Default		

OSD Menu

You can change the on-screen language in English, French or Spanish.

Subtitle, Audio, DVD menu

You can select the language of "Subtitle", "Audio", and "DVD menu" if more than one languages are recorded onto the disc.

English, French, Spanish:

The selected language will be heard or seen.

Off (Subtitle):

Subtitles do not appear.

Notes:

- If the selected language is not recorded on the disc, the first-priority language is selected.
- If you want to change the on screen display language, you can perform it by TV SETUP MENU **22**.



Video

Language	Aspect Ratio	: 4:3
Video	View Mode	: Auto Fit
Audio	JPEG Interval	: 5 seconds
Rating		
Default		

Aspect Ratio

You have the following screen sizes to choose from:

4:3

Select this mode when connecting to a conventional TV. When playing back a wide screen-DVD disc, it displays the wide picture with black bands at the top and bottom of screen.

16:9

Select when a 16:9 wide TV is connected. Use this setting when using a LCD monitor.

Notes:

- The displayable picture size is preset on the DVD video disc. Therefore, the playback picture of some DVD video discs may not conform to the picture size you select.
- When you play DVD video discs recorded in the 4:3 picture size only, the playback picture always appears in the 4:3 picture size regardless of the TV shape setting.
- If you select "16:9" and you own a 4:3 TV set, the DVD playback picture will be horizontally distorted during playback. Images will appear to be horizontally compressed. Always be sure that your TV shape conforms to the actual TV in use.

Setting details

■ View Mode

The user may select one of the following options:

Fill: Fill the screen with decoded image.

Original: Display image as its original size.

Auto Fit: Automatically fit the decoded image on screen without distortion.

Pan Scan:Automatically display decoded image on full screen without distortion.

■ JPEG Interval

You can continuously playback all JPEG files automatically.

After the selection below, the disc will start playback on JPEG files which have been recorded

Off

Plays back one file at a time.

5 Seconds:

Plays back images in the form of a slide show at 5 second intervals.

10 Seconds:

Plays back images in the form of a slide show at 10 second intervals.

15 Seconds:

Plays back images in the form of a slide show at 15 second intervals.

Customizing the function settings (Continued)

Setting details



Audio

Language	E.A.M.	: Normal
Video	D.R.C.	: Off
Audio	Digital Out	: Bitstream
Rating		
Default		

■ E.A.M.

You can obtain expansive virtual surround sound effects from just two speakers.

Normal:

Normal sound.

3D:

To obtain expansive virtual surround sound effects from just two speakers.

■ D.R.C.

D.R.C. (Dynamic Range Control) enables you to control the dynamic range so as to achieve a suitable sound for your equipment.

Off:

It plays back at the recording level on the disc.

On:

Loud sound such as explosion is toned down slightly when played back. This is suitable when it is connected to a stereo.

Notes:

- This function works only during playback of Dolby Digital recorded discs.
- The level of Dynamic Range Reduction may differ depending on DVD video disc.

■ Digital Out

Select the output sound format corresponding to your system connection.

Bitstream: Select when connected to an amplifier equipped with a Dolby Digital, DTS, MPEG1 or MPEG2 decoder. The player outputs digital audio signal in the bitstream format when you play a DVD video disc recorded in the Dolby Digital, DTS, MPEG1 or MPEG2 recording system.

Analog 2ch: Select when connected to a TV or stereo system via the analog audio jacks.

PCM: Select when connected a 2 channel digital stereo amplifier. The player outputs sounds in the PCM 2ch format when you play a DVD video disc recorded on the Dolby Digital, MPEG1 or MPEG2 recording system.

Note:

During playback of VCD, the Optical output is MPEG data when Digital Out is set to "Bitstream" or "Analog 2ch".

Setting details



Rating

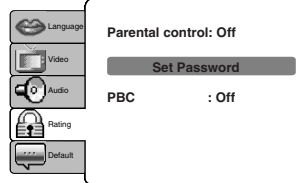

■ Parental control setting

Some discs are specified as not suitable for children. Such discs can be limited not to playback with the unit.

- 1) Press **▲** or **▼** to select "Parental Control", then press **ENTER**. "Enter Password" screen will appear.
- 2) Press "99999" using **Number buttons (0–9)**. (Please note, this is pre-setting password of this unit). Then press **ENTER**. Press **ENTER** again to list the parental level.

Level 1 : Kid Safe

Level 2 : G

Level 3 : PG

Level 4 : PG-13

Level 5 : PG-R

Level 6 : R

Level 7 : NC-17

Level 8 : Adult

- 3) Press **▲** or **▼** to select from the level 1 to level 8. The limitation will be more severe as the level number is lower. Then press **ENTER**.

Notes:

- The parental control levels for other countries/area than U.S. are included for future use. Check the appropriate parental control level when you buy a DVD video disc equipped with the parental control feature in the future.
Depending on the discs, the unit cannot limit playback.
- Some discs may not be encoded with specific rating level information though its disc jacket says "adult." For those discs, the age restriction will not work.
- The password is required every time when you change the parental level.
- If you input a wrong number, press **EXIT/CANCEL**.

■ Set the new password

- 1) Press **▲** or **▼** to select "Set Password", then press **ENTER**. "Enter Password" screen will appear.
- 2) Press **Number buttons (0–9)** to input the current password (If the password has not been set yet after you purchase this unit, it is "99999"). Then press **ENTER**.
- 3) Press **ENTER** again. "Enter New Password" screen will appear. Press **Number buttons (0–9)** to input the new password.
- 4) Press **ENTER**. Now your new password has been set. Be sure to remember this number!

Notes:

- 1) Both the factory password and user password can be used.
- 2) If you forget you password, you can enter the factory password.
- 3) If you input wrong number, press **EXIT/CANCEL**.

■ PBC

For details of PBC, see **8**

On

To use the menu when playing a PBC-featured VIDEO CD

Off

When playing a VIDEO CD without using the menu.

Customizing the function settings (Continued)

Setting details



Default

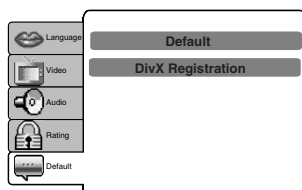

■ Default

Yes:

To restore the function settings to their default settings.

No:

No restoration of the default settings.

■ DivX® Registration

In order to play DivX® VOD (Video On Demand) content on this unit, you first need to register the unit with your DivX® VOD content provider. You do this by generating a DivX® VOD registration code, which you submit to your provider.

Press ▲ or ▼ to select “DivX Registration”. Then press **ENTER**. Your 8-character registration code is displayed. Make a note of the code as you will need it when you register with a DivX® VOD provider. Then press **ENTER** to select OK.

Note:

If each setup (pages 65 ~ 66) has completed, the unit can always work under the same condition (especially with DVD discs).

Each setup will be retained in the memory even if you turn the power off.

Function setup

Temporary cancel the rating level by DVD disc

Depending on the DVD disc, the disc may try to temporarily cancel the rating level that you have set.

It is up to you to decide whether to cancel the rating level or not.

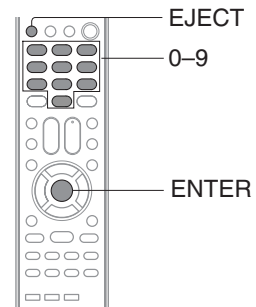

Temporary cancel the rating level by DVD disc

1 Load a DVD disc.

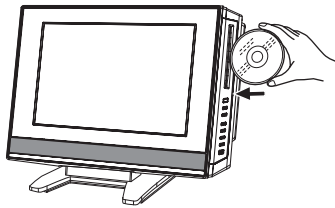

- 2** If the DVD disc has been designed to temporarily cancel the Rating level, the screen which follows the "Loading" screen will change, depending on which disc is played. If you select "YES" with the ENTER key, password input screen will then appear.
- If "NO" is selected, press EJECT to remove the disc.

3 Enter the password with Number buttons (0-9). Then press ENTER.

Enter Password

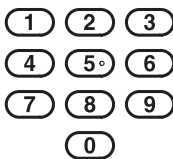

4 Playback will commence if the entered password is correct.

Note:

This temporary cancellation of rating level will be kept until the disc is ejected.

When the disc is ejected, the original rating level will be set again automatically.

Troubleshooting

Use the following check list for troubleshooting when you have problems with your unit. Consult your local dealer or service outlet if problems persist.

Be sure all connections are properly made when using with other units.

SYMPTOMS	POSSIBLE SOLUTIONS	PAGE
POWER		
TV/DVD does not operate.	<ul style="list-style-type: none"> • Make sure the connection of the AC adapter and AC cord is secured. • Try another AC outlet. • Unplug unit, then plug it back in. 	19
TV BROADCAST RECEPTION		
Poor sound or No sound.	<ul style="list-style-type: none"> • Station or Cable TV may have problems, try another station. • Check Volume adjustments. • Check for sources of possible interference. 	25 25 73
Poor picture or No picture.	<ul style="list-style-type: none"> • Station or Cable TV may have problems, try another station. • Check antenna or Cable TV connections, reorient antenna. • Check for sources of possible interference. • Check picture control adjustments. 	25 14,15 73 40
Poor reception on some channels.	<ul style="list-style-type: none"> • Station or Cable TV may have problems, try another station. • Station signal is weak, reorient antenna to receive weaker station. • Check for sources of possible interference. 	25 14 73
Poor color or no color.	<ul style="list-style-type: none"> • Station or Cable TV may have problems, try another station. • Make sure channels are set into memory. • Check picture control adjustments. • Check antenna or Cable TV connections, reorient antenna. • Check for sources of possible interference. 	25 24 40 14,15 73
Picture wobbles or drifts.	<ul style="list-style-type: none"> • Station or Cable TV may have problems, try another station. • Make sure channels are set into memory. • Cable TV company is scrambling signal. • Check antenna or Cable TV connections, reorient antenna. 	25 24 - 14,15
No CATV reception.	<ul style="list-style-type: none"> • Check all Cable TV connections. • Set TV/CABLE selection to the CABLE position. • Station or Cable TV system problems, try another station. 	15 24 25
Horizontal or diagonal bars on screen.	<ul style="list-style-type: none"> • Check antenna or Cable TV connections, reorient antenna. • Check for sources of possible interference. 	14,15 73
No reception above channel 13.	<ul style="list-style-type: none"> • Make sure TV/CABLE selection is in the appropriate position. • If antenna is used, check UHF antenna connections. 	24 14
TV shuts off.	<ul style="list-style-type: none"> • No broadcast on station tuned. • Auto shut off feature worked. • Sleep Timer is set. • Power interrupted. 	25 44 26 -
Closed - Caption is not activated.	<ul style="list-style-type: none"> • TV station experiencing problems or program tuned is not closed captioned. Try another channel. • Check Cable TV connection or VHF/UHF antenna, reposition or rotate antenna. • Press CLOSED CAPTION button to turn on the closed caption decoder. 	25 14,15 28
Display is not shown in your language.	<ul style="list-style-type: none"> • Select proper language in the menu options. 	22

SYMPTOMS	POSSIBLE SOLUTIONS	PAGE
DVD		
Playback doesn't start.	<ul style="list-style-type: none"> No disc is loaded. The disc may be dirty. Clean up the disc. The unit cannot play CD-ROMs, etc. 	47 7 8
No picture.	<ul style="list-style-type: none"> TV/DVD selector is not set correctly. 	47
No sound.	<ul style="list-style-type: none"> Check the input selector of the amplifier is set properly. The unit is in the special playback mode. Select the correct Audio Input/Output position on AV amplifier. 	- 49 18
Picture is distorted during fast reverse/forward playback.	<ul style="list-style-type: none"> The picture will be distorted occasionally. 	-
Stopping playback, search, slowmotion play, repeat play, or program play, etc. cannot be performed.	<ul style="list-style-type: none"> Some discs may not do some of the functions. 	-
The unit or remote operation key is not functioning.	<ul style="list-style-type: none"> Turn off the unit and unplug the AC power cord for several minutes, then replug it. 	-
Playback does not start when the title is selected.	<ul style="list-style-type: none"> Check the RATING LEVEL setup. 	68
Audio soundtrack and/or subtitle language is not changed when you playback a DVD.	<ul style="list-style-type: none"> Multilingual language is not recorded on the DVD disc. 	65
No subtitle.	<ul style="list-style-type: none"> Some discs have no subtitles. Subtitles are cleared. Press the SUBTITLE button. 	55
Angle cannot be changed.	<ul style="list-style-type: none"> Multi-angles are not recorded on the DVD disc. 	54
"⊘" appears on the screen.	<ul style="list-style-type: none"> The function is prohibited with the unit or the disc. 	49
REMOTE CONTROL		
The remote control does not function.	<ul style="list-style-type: none"> Aim the remote control at the remote sensor. Operate within approx. 5 meters or reduce the light in the room. Clear the path of the beam. The batteries are weak. Replace the batteries. Check the batteries are inserted correctly. 	13

Reception disturbances

Most types of television interference can be remedied by adjusting the height and position of the VHF/UHF antenna. Outdoor antennas are recommended for best results. The most common types of television interference are shown below. If one of these symptoms appear when the TV/DVD is connected to a Cable TV system, the disturbance may be caused by the local Cable TV company broadcast.

IGNITION

Black spots or horizontal streaks may appear, the picture may flutter or drift. Usually caused by interference from automobile ignition systems, neon lamps or AC powered tools and appliances such as drills or hair dryers.



GHOSTS

Ghosts are caused by the television signal following two paths. One is the direct path and the other is reflected by tall buildings, hills or other large objects. Changing the direction or position of the antenna may improve the reception.

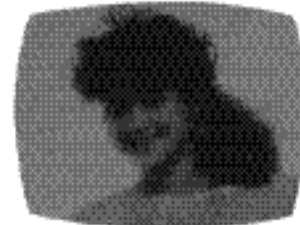

SNOW

If the TV/DVD is located far from the TV station, in a fringe reception area where the signal is weak, small dots may appear in the picture. If the signal is extremely weak, the installation of a larger external antenna may be necessary.



RADIO FREQUENCY INTERFERENCE (RFI)

Caused by two-way radios, this type of interference produces moving ripples or diagonal streaks in the picture. Some cases may cause a loss of contrast in the picture. Changing the direction and position of the antenna or installing an RFI filter may improve the picture.

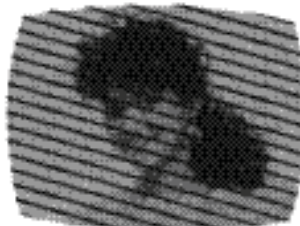

Others

CARE AND MAINTENANCE

To prevent fire or shock hazard, disconnect the TV/DVD from the power source before cleaning. Use caution when cleaning or wiping the plastic parts.

Specifications

General

Power supply	AC 120V 60Hz
Power consumption	Operation: 55 W, Stand by: 1 W
Weight	20.3 lbs (9.2kg)
Dimensions	Width: 20.6 inches (524mm) Height: 16.3 inches (414mm) Depth: 3.5 inches (90 mm)
Operating temperature	5°C-35°C (41°F-95°F)
Operating humidity	Less than 80% RH (No condensation)

Television

LCD panel	19-inch diagonal (Screen size is approximate.)
Display method	Color TFT LCD
Number of pixels	1440 (Horizontal) x 900(Vertical)
Television system	NTSC standard, ATSC standard (8VSB), QAM
Receiving channels	VHF: 2-13 UHF: 14-69 CATV: 1-125 (4A, A5~A1, A~I, J~W, W+1~W+84)
Antenna input	VHF/UHF/CABLE
Speaker	1.6 x 2.8 inches (40 x 70 mm), 8 Ω x 2
Audio output power	2.5W + 2.5W

DVD/CD Player

Signal system	NTSC
Applicable disc	1. DVD (12cm) 2. CD (12cm)
Pickup	1-Lens, 2-Beams System

Input/Output

S-Video input	(Y) 1.0 V (p-p), 75 Ω, negative sync., Mini DIN 4-pin x 1 (C) 1.0 V (p-p), 75 Ω
Component video input	(Y) 1.0 V (p-p), 75 Ω, negative sync., pin jack x 1 (Pb, Pr) 0.7V (p-p), 75 Ω, pin jack x 2
Video input	1.0 V (p-p), 75 Ω, negative sync., pin jack x 2
Audio input	-8dBm, 50 kΩ, negative sync., pin jack (L/R) x 4
Digital audio output (Optical)	Optical connector x 1
Headphone	ø3.5mm stereo mini jack x 1
HDMI INPUT	HDMI compliant (type A connector), HDCP compliant, E-EDID* compliant Suggested scan rates: 1080i, 480p, 480i, 720p. HDMI Audio: 2-channel PCM, 32/44.1/48kHz sampling frequency, 16/22/24 bits per sample
PC Monitor Input	Mini-Dsub 15pin x 1

* E-EDID = Enhanced-Extended Display Identification.

Accessories

Remote control (DC-LWB1)	1
Batteries (R03/AAA)	2
Owner's manual (this booklet)	1

- This model complies with the above specifications.
- Designs and specifications are subject to change without notice.
- This model may not be compatible with features and/or specifications that may be added in the future.

Limited United States Warranty LCD TV/DVD Combination - Depot Repair Warranty

Toshiba America Consumer Products, L.L.C. ("TACP") makes the following limited warranties to original consumers in the United States. THESE LIMITED WARRANTIES EXTEND TO THE ORIGINAL CONSUMER PURCHASER OR ANY PERSON RECEIVING THIS LCD TV/DVD COMBINATION AS A GIFT FROM THE ORIGINAL CONSUMER PURCHASER AND TO NO OTHER PURCHASER OR TRANSFEREE.

LCD TV/DVD COMBINATIONS PURCHASED IN THE U.S.A. AND USED ANYWHERE OUTSIDE OF THE U.S.A., INCLUDING, WITHOUT LIMITATION, CANADA AND MEXICO, ARE NOT COVERED BY THESE WARRANTIES.

LCD TV/DVD COMBINATIONS PURCHASED ANYWHERE OUTSIDE OF THE U.S.A., INCLUDING, WITHOUT LIMITATION, CANADA AND MEXICO, AND USED IN THE U.S.A., ARE NOT COVERED BY THESE WARRANTIES.

Limited One (1) Year Warranty on Parts and Labor

TACP warrants this LCD TV/DVD Combination and its parts against defects in materials or workmanship for a period of one (1) year after the date of original retail purchase. DURING THIS PERIOD, TACP WILL, AT TACP'S OPTION, REPAIR OR REPLACE A DEFECTIVE PART WITH A NEW OR REFURBISHED PART WITHOUT CHARGE TO YOU.

Rental Units

The warranty for LCD TV/DVD Combination rental units begins on the date of the first rental or thirty (30) days after the date of shipment to the rental firm, whichever comes first.

Commercial Units

LCD TV/DVD Combinations sold and used for commercial purposes have a limited warranty for all parts and labor, which warranty begins on the date of original retail purchase and ends on the date that is ninety (90) days thereafter.

Owner's Manual and Product Registration Card

Read this owner's manual thoroughly before operating this LCD TV/DVD Combination.

Complete and mail the enclosed product registration card or register your LCD TV/DVD Combination on line at www.tacp.toshiba.com/service as soon as possible. By registering your LCD TV/DVD Combination you will enable TACP to bring you new products specifically designed to meet your needs and help us to contact you in the unlikely event a safety notification is required under the U.S. Consumer Product Safety Act. Failure to complete and return the product registration card does not diminish your warranty rights.

Your Responsibility

THE ABOVE WARRANTIES ARE SUBJECT TO THE FOLLOWING CONDITIONS:

- (1) You must retain your bill of sale or provide other proof of purchase.
- (2) All warranty servicing of this LCD TV/DVD Combination must be made by the Depot Warranty Repair Center specified by the TACP Consumer Solutions Center.
- (3) The warranties from TACP are effective only if the LCD TV/DVD Combination is purchased and operated in the Continental U.S.A. or Puerto Rico.
- (4) Labor service charges for set installation, setup, adjustment of customer controls, and installation or repair of antenna systems are not covered by this warranty. Reception problems caused by inadequate antenna systems are your responsibility.
- (5) Warranties extend only to defects in materials or workmanship as limited above, and do not extend to any LCD TV/DVD Combination or parts that have been lost or discarded by you or to damage to the LCD TV/DVD Combination or parts caused by fires, misuse, accident, Acts of God (such as lightning or fluctuations in electric power), improper installation, improper maintenance, or use in violation of instructions furnished by TACP; use or malfunction through simultaneous use of this LCD TV/DVD Combination and connected equipment; or to units that have been modified or had the serial number removed, altered, defaced, or rendered illegible.

Others

How to Obtain Warranty Services

If, after following all of the operating instructions in this manual and checking the section "Troubleshooting," you find that service is needed:

- (1) For instructions on how to obtain warranty service for your LCD TV/DVD Combination, contact TACP's Consumer Solution Center toll free at 1-800-631-3811.
- (2) You must include a copy or original bill of sale or other proof of purchase along with the entire LCD TV/DVD Combination to the Depot Warranty Repair Center specified by the TACP Consumer Solutions Center. You are responsible for all inbound transportation and insurance charges for the LCD TV/DVD Combination to the Depot Warranty Repair Center specified by the TACP Consumer Solutions Center.

For additional information, visit TACP's website:
www.tacp.toshiba.com

ALL WARRANTIES IMPLIED BY THE LAW OF ANY STATE OF THE U.S.A., INCLUDING THE IMPLIED WARRANTIES OF MERCHANTABILITY AND FITNESS FOR A PARTICULAR PURPOSE, ARE EXPRESSLY LIMITED TO THE DURATION OF THE LIMITED WARRANTIES SET FORTH ABOVE. WITH THE EXCEPTION OF ANY WARRANTIES IMPLIED BY THE LAW OF ANY STATE OF THE U.S.A. AS HEREBY LIMITED, THE FOREGOING WARRANTY IS EXCLUSIVE AND IN LIEU OF ALL OTHER WARRANTIES, GUARANTEES, AGREEMENTS, AND SIMILAR OBLIGATIONS OF TACP WITH RESPECT TO THE REPAIR OR REPLACEMENT OF ANY PARTS. IN NO EVENT SHALL TACP BE LIABLE FOR CONSEQUENTIAL OR INCIDENTAL DAMAGES (INCLUDING, BUT NOT LIMITED TO, LOST PROFITS, BUSINESS INTERRUPTION, OR MODIFICATION OR ERASURE OF RECORDED DATA CAUSED BY USE, MISUSE OR INABILITY TO USE THIS LCD TV/DVD COMBINATION).

No person, agent, distributor, dealer, or company is authorized to change, modify, or extend the terms of these warranties in any manner whatsoever. The time within which an action must be commenced to enforce any obligation of TACP arising under the warranty or under any statute or law of the United States or any state thereof is hereby limited to ninety (90) days from the date you discover, or should have discovered, the defect. This limitation does not apply to implied warranties arising under state law.

THIS WARRANTY GIVES YOU SPECIFIC LEGAL RIGHTS AND YOU MAY ALSO HAVE OTHER RIGHTS WHICH MAY VARY FROM STATE TO STATE IN THE U.S.A. SOME STATES OF THE U.S.A. DO NOT ALLOW LIMITATIONS ON HOW LONG AN IMPLIED WARRANTY LASTS, WHEN AN ACTION MAY BE BROUGHT, OR THE EXCLUSION OR LIMITATION OF INCIDENTAL OR CONSEQUENTIAL DAMAGES, SO THE ABOVE PROVISIONS MAY NOT APPLY TO YOU UNDER SUCH CIRCUMSTANCES.

Limited Canadian Warranty for Toshiba Brand 32" and Smaller LCD Television Models

Toshiba of Canada Limited ("TCL") makes the following limited warranties to original consumers in Canada. **THESE LIMITED WARRANTIES EXTEND TO THE ORIGINAL CONSUMER PURCHASER OR ANY PERSON RECEIVING THIS TOSHIBA BRAND LCD TELEVISION MODEL (the "TELEVISION(S)" or "Television(s)") AS A GIFT FROM THE ORIGINAL CONSUMER PURCHASER AND TO NO OTHER PURCHASER OR TRANSFEREE.**

TELEVISIONS PURCHASED IN CANADA, AND USED ANYWHERE OUTSIDE OF CANADA INCLUDING, WITHOUT LIMITATION, THE UNITED STATES AND MEXICO, ARE NOT COVERED BY THESE WARRANTIES.

TELEVISIONS PURCHASED ANYWHERE OUTSIDE OF CANADA, INCLUDING, WITHOUT LIMITATION, THE UNITED STATES AND MEXICO, AND USED IN CANADA, ARE NOT COVERED BY THESE WARRANTIES.

Limited One (1) Year Warranty on Parts and Labour

TCL warrants the Television and its parts against material defects in materials or workmanship that result in the Television failing for a period of one (1) year after the date of original retail purchase. **DURING THIS PERIOD, TCL WILL, AT TCL'S OPTION, REPAIR OR REPLACE A DEFECTIVE PART WITH A NEW OR REFURBISHED PART WITHOUT CHARGE TO YOU FOR PARTS OR LABOUR. YOU MUST DELIVER THE ENTIRE TELEVISION TO AN AUTHORIZED TCL SERVICE DEPOT ("ASD"). YOU MUST PAY FOR ALL TRANSPORTATION AND INSURANCE CHARGES FOR THE TELEVISION TO AND FROM THE ASD.**

Limited Warranty for Commercial Units

TCL warrants Televisions that are used for any commercial or business purposes as follows: all parts are warranted against material defects in materials or workmanship that result in the Television failing for a period of ninety (90) days after the date of original retail purchase. **DURING THIS PERIOD, TCL WILL, AT TCL'S OPTION, REPAIR OR REPLACE A DEFECTIVE PART WITH A NEW OR REFURBISHED PART WITHOUT CHARGE TO YOU FOR PARTS OR LABOUR. YOU MUST DELIVER THE ENTIRE TELEVISION TO AN ASD. YOU MUST PAY FOR ALL TRANSPORTATION AND INSURANCE CHARGES FOR THE TELEVISION TO AND FROM THE ASD.**

Rental Units

The warranty for Television rental units begins with the date of first rental or thirty (30) days from the date of shipment to the rental firm, whichever comes first.

Your Responsibility

THE ABOVE WARRANTIES ARE SUBJECT TO THE FOLLOWING CONDITIONS:

- (1) You must provide your bill of sale or other proof of purchase.
- (2) All warranty servicing of this Television must be performed by an Authorized Service Depot.
- (3) The warranties from TCL are effective only if the Television is (i) purchased as new and unopened from TCL or from TCL's authorized distributors, dealers or resellers ("**ADR's**") and (ii) located/operated in Canada.
- (4) Labour charges for set installation, setup, adjustment of customer controls, and installation or repair of antenna systems are not covered by these warranties. Reception problems caused by inadequate antenna systems are your responsibility.
- (5) Warranties extend only to material defects in materials or workmanship as limited above, and do not extend to:
 - a. Service, repairs or replacement made necessary by accident, misuse, abuse, moisture, liquids, dust, dirt, neglect, accident, damage, 24/7 applications, improper installation, improper operation, improper cleaning, improper maintenance, normal wear and tear, or any other external cause or event, act or omission outside the control of TCL, including fire, theft, acts of God, alteration, power failures, power surges or power shortages, lightning, other electrical faults, or repairs, modifications or replacements by persons other than those authorized by TCL to service the Television;
 - b. Replacement of missing, discarded or lost parts, the provision of retrofits, or preventive maintenance;
 - c. Repair of damage that is cosmetic only or does not affect the Television functionality, such as wear and tear, scratches and dents;
 - d. Service on Toshiba-branded accessory items (such as accessory items may be covered by their own warranty);
 - e. Service on third party products or service made necessary by use of incompatible third party products;
 - f. Service made necessary by the simultaneous use of this Television and connected equipment;
 - g. Modifications to the Television not approved in writing by TCL, and service made necessary by the use or installation of non-Toshiba modifications to the Television;
 - h. Service of a Television on which the TOSHIBA label or logo, rating label or serial number have been defaced or removed;
 - i. On-site service and repair of the Television; and
 - j. Damage to the Television caused by failure to follow the specifications, User manuals or guides as to usage and/or storage.

Others

Disclaimer and Limitation of Remedy
TO THE EXTENT NOT PRECLUDED BY LAW, ALL OTHER EXPRESS AND IMPLIED WARRANTIES, CONDITIONS AND REPRESENTATIONS FOR THIS TELEVISION, INCLUDING THE IMPLIED WARRANTIES AND CONDITIONS OF MERCHANTABILITY AND FITNESS FOR A PARTICULAR PURPOSE, ARE HEREBY DISCLAIMED AND EXCLUDED. IF THE APPLICABLE LAW, STATUTORY OR OTHERWISE, PRECLUDES THE EXCLUSION OF ANY IMPLIED WARRANTIES, CONDITIONS AND REPRESENTATIONS THEN SUCH IMPLIED WARRANTIES, CONDITIONS AND REPRESENTATIONS ARE OTHERWISE LIMITED IN DURATION TO THE TERM OF THIS EXPRESS WRITTEN LIMITED WARRANTY. TO THE EXTENT NOT PRECLUDED BY LAW, THIS WRITTEN WARRANTY SUPERCEDES AND SPECIFICALLY DISCLAIMS ANY OTHER WARRANTY, CONDITION OR REPRESENTATION NOT STATED IN THIS WARRANTY, WHETHER MADE BY TCL, TOSHIBA CORPORATION, THEIR AFFILIATES, ADRs AND ASDs AND WHETHER MADE ORALLY OR IN WRITING (INCLUDING ANY STATEMENT IN ANY BROCHURE, PRESS RELEASE, ANNOUNCEMENT, ADVERTISEMENT, POINT OF SALE DISPLAY, ETC.).

YOU MUST READ AND FOLLOW ALL SET-UP AND USAGE INSTRUCTIONS IN THE APPLICABLE USER GUIDES AND/OR MANUALS. IF YOU FAIL TO DO SO, THIS TELEVISION MAY NOT FUNCTION PROPERLY AND YOU MAY SUFFER DAMAGE. THIS WARRANTY WILL NOT COVER ANY SERVICE THAT IS REQUIRED, IN PART OR IN WHOLE, AS A RESULT OF ANY FAILURE TO FOLLOW THE SET-UP AND USAGE INSTRUCTIONS. THIS WARRANTY DOES NOT APPLY AND SHALL BE VOID AND UNENFORCEABLE IF THE TELEVISION IS OPENED, SERVICED, OR REPAIRED BY PERSONS OTHER THAN THOSE AUTHORIZED BY TCL TO SERVICE OR REPAIR THE TELEVISION.

IF THE TELEVISION FAILS TO WORK AS WARRANTED ABOVE, YOUR SOLE AND EXCLUSIVE REMEDY SHALL BE REPAIR OR REPLACEMENT OF THE DEFECTIVE PART. IN NO EVENT WILL TCL, TOSHIBA CORPORATION, THEIR AFFILIATES, ADRs OR ASDs (THE "RELATED PARTIES") BE LIABLE TO YOU OR ANY THIRD PARTY FOR ANY DAMAGES, MONEY, REIMBURSEMENT, COSTS OR EXPENSES. THIS LIMITATION APPLIES TO DAMAGES, MONEY, REIMBURSEMENT, COSTS OR EXPENSES OF ANY KIND WHATSOEVER INCLUDING ANY DIRECT OR INDIRECT DAMAGES, DAMAGE TO PROPERTY OR PERSON, LOST PROFITS, LOST SAVINGS, INCONVENIENCE OR OTHER SPECIAL, INCIDENTAL, EXEMPLARY OR CONSEQUENTIAL DAMAGES, WHETHER FOR BREACH OF WARRANTY, BREACH OF CONTRACT, TORT (INCLUDING NEGLIGENCE), UNDER A STATUTE OR UNDER ANY OTHER LAW OR FORM OR ACTION, OR WHETHER ARISING OUT OF THE USE OF OR INABILITY TO USE THE TELEVISION, EVEN IF ANY OF THE RELATED PARTIES HAS BEEN ADVISED OF THE POSSIBILITY OF SUCH DAMAGES OR OF ANY CLAIM BY ANY OTHER PARTY.

No person, agent, distributor, dealer or company is authorized to change, modify or extend the terms of these warranties in any manner whatsoever.

Arbitration and Dispute Resolution

To the extent not precluded by law, any claim, dispute, controversy or disagreement (whether for breach of warranty, breach of contract, tort (including negligence), under a statute or under any other law or form of action) against any of the Related Parties arising out of, or otherwise relating to: (i) this warranty; (ii) the Television; (iii) any oral or written representations, statements, brochures, press releases, advertising, announcement, point of sale display, or promotional material relating to the Television; (iv) the relationships that result from this warranty, (the foregoing claims, disputes controversies and disagreements are collectively referred to as the "Dispute"), shall be referred to and resolved by final and binding arbitration (to the exclusion of the courts). To the extent not precluded by law, you agree to waive any right that you may have to commence or participate in any representative or class proceeding against the Related Parties relating to any Dispute. If and where applicable and to the extent not precluded by law, you further agree to opt out of any such representative or class proceedings. Arbitration of any Dispute will be conducted in the forum and in the manner as agreed to between you and TCL. Failing such agreement, the arbitration will be conducted by one arbitrator pursuant to the laws and rules relating to arbitration generally in force in the jurisdiction in which you reside at the time that the Dispute arises. To the extent not precluded by law, no claim, dispute, controversy or disagreement of any other person may be joined or combined with any Dispute by you, without the prior written consent of TCL.

Critical Applications

The Television you have purchased is not designed for any "critical applications." "Critical applications" means life support systems, medical applications, connections to implanted medical devices, commercial transportation, nuclear facilities or systems or any other applications where Television failure could lead to injury to persons or loss of life or catastrophic property damage.

IF THE CUSTOMER USES THE TELEVISION IN ANY CRITICAL APPLICATION, THE CUSTOMER – AND NOT TCL, ITS AFFILIATES, ADRs OR ASDs – ASSUME SOLE AND FULL RESPONSIBILITY FOR SUCH USE. TCL RESERVES THE RIGHT TO REFUSE TO SERVICE ANY TELEVISION USED IN A CRITICAL APPLICATION. TCL, ITS AFFILIATES, ADRs AND ASDs HEREBY DISCLAIM ANY AND ALL LIABILITY, DAMAGES AND CONSEQUENCES ARISING OUT OF THE SERVICE OR REFUSAL TO SERVICE SUCH TELEVISION AND FURTHER DISCLAIM ANY AND ALL LIABILITY, CONSEQUENCES AND DAMAGES THAT MAY ARISE OR RESULT FROM THE USE OF THE TELEVISION IN ANY CRITICAL APPLICATIONS.

General Provisions

If and to the extent that any provision of this limited warranty should generally be found to be unenforceable, the unenforceable provision shall be severed from the warranty and deemed not to form part of the warranty. The remaining provisions of this warranty shall be and remain valid and enforceable. If and to the extent that any provision of this limited warranty as it relates to any of the Related Parties is found to be invalid or unenforceable in respect of that party (the "Excluded Party"), the Excluded Party shall be deemed to be severed or excluded from the provision, and the provision shall remain valid, enforceable and applicable in respect of the other or remaining Related Parties.

To the extent permitted by law, this limited warranty shall be governed and construed in accordance with the laws of Ontario.

If there is any inconsistency between this limited warranty, on the one hand, and any statement in the packaging of the Television or in any other document enclosed with, or used in the context of the promotion or sale of, the Television, on the other hand, the provisions of this limited warranty shall prevail.

How to Obtain Warranty Services

If, after following all of the operating instructions in this manual and checking the "Troubleshooting" section, you find that service is needed:

- (1) To find the nearest TCL Authorized Service Depot, visit TCL's web site at www.toshiba.ca, or call toll free 1-800-268-3404
- (2) Present your bill of sale or other proof of purchase to the Authorized Service Depot.

For additional information, visit TCL's website:
www.toshiba.ca

Others



TOSHIBA

ColorStream and TheaterWide are registered trademarks of Toshiba America Consumer Products, L.L.C.
LCDDVD and GameTimer are trademarks of Toshiba America Consumer Products, L.L.C.

Printed in China



Free Manuals Download Website

<http://myh66.com>

<http://usermanuals.us>

<http://www.somanuals.com>

<http://www.4manuals.cc>

<http://www.manual-lib.com>

<http://www.404manual.com>

<http://www.luxmanual.com>

<http://aubethermostatmanual.com>

Golf course search by state

<http://golfingnear.com>

Email search by domain

<http://emailbydomain.com>

Auto manuals search

<http://auto.somanuals.com>

TV manuals search

<http://tv.somanuals.com>