

TOSHIBA

Leading Innovation >>>

PORTABLE TV/DVD PLAYER

SD-P120DTKE

OWNER'S MANUAL



Introduction

Preparations

TV viewing

Playback

Function Settings

Connections

Others

© PX1D00002741

SAFETY PRECAUTIONS

Introduction

WARNING: TO REDUCE THE RISK OF FIRE OR ELECTRIC SHOCK, DO NOT EXPOSE THIS APPLIANCE TO RAIN OR MOISTURE. DANGEROUS HIGH VOLTAGES ARE PRESENT INSIDE THE ENCLOSURE. DO NOT OPEN THE CABINET. REFER SERVICING TO QUALIFIED PERSONNEL ONLY.

CAUTION: This equipment employs a Laser System.

To ensure proper use of this product, please read this owner's manual carefully and retain for future reference. Should the unit require maintenance, contact an authorised service location - see service procedure.

Use of controls or adjustments or performance of procedures other than those specified herein may result in hazardous radiation exposure.

To prevent direct exposure to laser beam, do not try to open the enclosure.

Visible and invisible laser radiation when open and interlocks defeated.

DO NOT STARE INTO BEAM.

This equipment is categorized as "Class 1 Laser Product" in EN60825, the European common laser standard.

CLASS 1 LASER PRODUCT

In the spaces provided below, record the Model and Serial No. located on the back of your player.

Model No. _____ Serial No. _____

Retain this information for future reference.

About disposal

The cold cathode fluorescent lamp in the LCD panel contains a small amount of mercury. Please follow local ordinances or regulations when you dispose of the product.

EU Conformity Statement



"This product is marked with "CE" and complies therefore with the applicable harmonized European standards listed under the Low Voltage Directive **2006/95/EC** and the EMC Directive **2004/108/EC**."

Responsible for CE-marking is TOSHIBA INFORMATION SYSTEMS (U.K.) LTD,
Toshiba Court, Weybridge Business Park, Addlestone Road
Weybridge, Surrey, KT15 2UL U.K.

Manufacturer:
Toshiba Corporation, 1-1 Shibaura 1-chome, Minato-ku, Tokyo, 105-8001, Japan



Introduction

SAFETY PRECAUTIONS

Introduction

Location of the required label

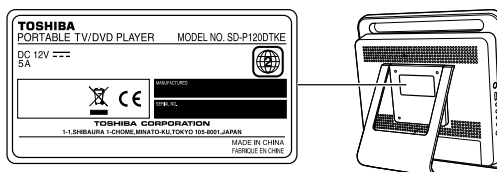

Following information is only for EU-member states:



The use of the symbol indicates that this product may not be treated as household waste. By ensuring this product is disposed of correctly, you will help prevent potential negative consequences for the environment and human health, which could otherwise be caused by inappropriate waste handling of this product. For more detailed information about recycling of this product, please contact your local city office, your household waste disposal service or the shop where you purchased the product.

Disposal of batteries and/or accumulators

Following information is only valid for EU-member States:



Hg Cd Pb

The crossed out wheeled dust bin symbol indicates that batteries and/or accumulators must be collected and disposed of separately from household waste.

If the battery or accumulator contains more than the specified values of lead (Pb), mercury (Hg), and/or cadmium (Cd) defined in the Battery Directive (2006/66/EC), then the chemical symbols for lead (Pb), mercury (Hg) and/or cadmium (Cd) will appear below the crossed out wheeled dust bin symbol.



Pb

By participating in separate collection of batteries, you will help to assure the proper disposal of products and batteries and thus help to prevent potential negative consequences for the environment and human health.

For more detailed information about the collection and recycling programmes available in your country, please contact your local city office or the shop where you purchased the product.

IMPORTANT SAFETY INSTRUCTIONS

CAUTION: PLEASE READ AND OBSERVE ALL WARNINGS AND INSTRUCTIONS GIVEN IN THIS OWNER'S MANUAL AND THOSE MARKED ON THE UNIT. RETAIN THIS BOOKLET FOR FUTURE REFERENCE.

This unit is fully transistorized and does not contain any parts that can be repaired by the user.
DO NOT REMOVE THE CABINET COVER, OR YOU MAY BE EXPOSED TO DANGEROUS VOLTAGE. REFER SERVICING TO QUALIFIED SERVICE PERSONNEL ONLY.

1. Read these instructions.
2. Keep these instructions.
3. Heed all warnings.
4. Follow all instructions.
5. Do not use this apparatus near water.
6. Clean only with dry cloth.
7. Do not install near any heat sources such as radiators, heat registers, stoves, or other apparatus (including amplifiers) that produce heat.
8. Do not insert any foreign objects into the memory card slot. Heat build-up or fire may result.
9. Protect the power cord from being walked on or pinched particularly at plugs, convenience receptacles, and the point where they exit from the apparatus.
10. Only use attachments/accessories specified by the manufacturer.
11. Unplug this apparatus during lightning storms or when unused for long periods of time. However, while it is thundering or lightning, do not touch the apparatus and any connected cable and/or equipment. This will prevent you from receiving the electric shock by an electric surge.
12. Refer all servicing to qualified service personnel. Servicing is required when the apparatus has been damaged in any way, such as power-supply cord or plug is damaged, liquid has been spilled or objects have fallen into the apparatus, the apparatus has been exposed to rain or moisture, does not operate normally, or has been dropped.

IMPORTANT SAFETY INSTRUCTIONS

Introduction

ADDITIONAL SAFETY INSTRUCTIONS

13. When you use headphones, keep the volume at a moderate level. If you use the headphones continuously with high volume sound, it may cause hearing damage.
14. Do not overload wall outlets; extension cords, or integral convenience receptacles as this can result in a risk of fire or electric shock.
15. Apparatus shall not be exposed to dripping or splashing and no objects filled with liquids, such as vases, shall be placed on the apparatus and/or around it.
16. Do not insert any objects other than 12cm discs into the disc slot. Doing so may cause the player to malfunction.
17. Do not put a vessel containing liquid such as a vase, or a metal object on the apparatus. If liquid or a foreign metal object is let into the apparatus, it may cause fires or electric shock.
18. Do not use a cracked, deformed, or repaired disc. These discs are easily broken and may cause serious personal injury and apparatus malfunction.
19. Do not rest the product on your lap or other parts of body. The product may become warm during use. Even low temperatures may cause personal injury when exposed to your skin for prolonged periods.
20. Use the supplied AC adapter to operate the product. Substitute devices not specified by the manufacturer may result in fire or product malfunction. Do not cover the AC adapter with a blanket or place it near heating or on electric carpet when it is in use.
21. When you use this product in an airplane, follow the instructions of the airline. Disregarding them may cause harmful interference to radio communication.
22. Do not stare at the pick-up lens or look at the laser beam. Doing so may cause damage to eyesight.
23. Do not use this product while walking or driving. Neglecting this may cause a traffic accident.



24. CAUTION: If the player is dropped and the cabinet or enclosure surface has been damaged or the player does not operate normally, take the following precautions:
- ALWAYS turn off the player and unplug the power cord to avoid possible electric shock or fire.
 - NEVER allow your body to come in contact with any broken glass or liquid from the damaged player. The LCD panel inside the player contains glass and a toxic liquid. If the liquid comes in contact with your mouth or eyes, or your skin is cut by broken glass, rinse the affected area thoroughly with water and consult your doctor.
 - ALWAYS contact a service technician to inspect the player any time it has been damaged or dropped.
25. Use the player in a location that facilitates the immediate removal of the plug if there is a malfunction or failure.
26. Do not allow children to scratch, lick or put the memory card into their mouth. Keep the memory card out of the reach of children. Injury to the child or malfunction may result.
27. Battery Pack (Lithium ion battery pack)
- a) Never throw the battery pack into a fire, as that could cause the battery pack to explode. Never heat the battery pack, as that could cause leakage of alkaline solution or other electrolytic substance.
 - b) Never disassemble the battery pack, as that could cause leakage of alkaline solution or other electrolytic substance.
 - c) Never short-circuit the battery pack by either accidentally or intentionally bringing the terminals in contact with another metal object. This could cause personal injury or a fire, and could also damage the battery pack.
 - d) Never drive a nail into the battery pack. Never strike the battery pack with a hammer. Never step or tread on the battery pack.
 - e) If you ever smell an unusual odor, excessive heat, discoloration, or deformation of the battery pack, remove it from the player after confirming safety and discontinue use of it. Take the battery pack to an authorized Toshiba service provider.
 - f) Keep the battery pack away from heat or fire.

IMPORTANT SAFETY INSTRUCTIONS

Introduction

- g) Never dispose of used battery packs with other ordinary solid wastes, since they contain toxic substances. Always dispose of used battery packs in accordance with community regulations that apply to the disposal of batteries. Cover the metal terminals with insulating tape, in order to prevent accidental short-circuiting.
 - h) Always confirm that the battery pack is compatible with your player, before attaching the battery pack to the player.
 - i) Never expose the terminals of the battery pack to any other metal object. Wrap the battery or place it in a protective plastic bag, whenever transporting it.
 - j) Always confirm that the temperature is between 5 and 35°C (41°F and 95°F) before you charge the battery. Leakage, excessive heat, or deterioration of the battery pack may occur if this caution is not heeded.
 - k) Never immerse the battery pack in any liquid.
 - l) Never expose the battery pack to direct sunlight. Never store or use the battery pack in a locked and unventilated vehicle. (where excessive internal temperatures may be encountered.)
 - m) Always keep the battery pack out of reach of infants or small children.
 - n) Never shock the battery pack by dropping or throwing it.
 - o) If the liquid contained within the battery pack leaks, use a large amount of water and immediately wash off any liquid which may accidentally contact any part of the body. Remove any liquid that has contacted your clothing by washing it immediately with a detergent.
 - p) Always confirm that a “click” sound has resulted, when attaching the battery pack to the player. This sound confirms that the battery pack has been properly attached.
- ## 28. Coin-shaped Battery
- a) Keep coin-shaped batteries out of children’s reach. Be careful not to ingest internally, especially by children, as doing so may cause poisoning.
 - b) Do not load a battery into the remote control with the wrong side out.
 - c) Do not charge, heat, open, or short-circuit the batteries. Do not throw the batteries into a fire.
 - d) Do not leave a dead or exhausted battery in the remote control.
 - e) If you do not use the remote control for a long period of time, remove the battery to avoid possible damage from battery corrosion.

29. After unpacking coin-shaped batteries, store them in poly bags, etc. separately one by one when unused. If you leave them unwrapped, they may be short-circuited by contact with metal objects, resulting in battery leakage, heat or bursting. This may cause burns or injury.

The batteries must be completely discharged when they are deposited in collection containers for old batteries. If a charge remains, countermeasures to prevent short circuits must be taken.

30. To reduce the risk of fire or electric shock, do not expose this apparatus to rain or moisture.

31. Following mark means "CAUTION - RISK OF ELECTRIC SHOCK - DO NOT OPEN".



32. The mains plug of the AC adapter is used as the disconnect device. Therefore use the AC adapter near the wall outlet so that the mains plug can be access easily at all times.

Precautions

Introduction

Notes on handling

- Do not shock the LCD monitor. It may cause unit damage and malfunction.
- Do not use the player in a place subject to vibration. Neglecting this may cause malfunction of the player or damage to the disc.
- Do not leave the player in a vehicle. Rise or drop in temperature may result in malfunction of the player.
- When transporting the player, the original shipping carton and packing materials come in handy. For maximum protection, repack the unit as it was originally packaged at the factory.
- Do not use volatile liquids, such as insect spray, near the player. Do not leave rubber or plastic products in contact with the player for a long time. They will leave marks on the finish.
- The player may become warm after a long period of use. This is not a malfunction.
- When the player is not in use, be sure to remove the disc and turn off the power.
- If you do not use the player for a long period, the unit may not function properly in the future. Turn on and use the player occasionally.

10

Notes on locating

- When you place this player near a TV, radio, or VTR, the playback picture may become poor and the sound may be distorted. In this case, move the player away from the TV, radio, or VTR.

Notes on cleaning

- Use a soft, dry cloth for cleaning. Do not use any type of solvent, such as thinners and benzene, as they may damage the surface of the player.
- When cleaning the LCD monitor, use a soft, dry cloth.

Notes on moisture condensation

Moisture condensation damages the player. Please read the following carefully.

Moisture condensation occurs, for example, when you pour a cold drink into a glass on a warm day. Drops of water form on the outside of the glass. In the same way, moisture may condense on the optical pick-up lens inside this unit, one of the most crucial internal parts of the player.

■ Moisture condensation occurs during the following cases.

- When you transport the player directly from a cold place to a warm place.
- When you use the player in a room where you just turned on the heater, or a place where the cold air from the air conditioner directly hits the unit.
- In summer, when you use the player in a hot and humid place just after you move the unit from an air conditioned room.
- When you use the player in a humid place.

■ Do not use the player when moisture condensation may occur.

If you use the player in such a situation, it may damage discs and internal parts. Remove the disc, connect the AC adapter, turn on the player, and leave it for two or three hours. After two or three hours, the player will have warmed up and evaporated any moisture.



Precautions (Continued)

Introduction

Notes on products incorporated laser system



- This product incorporates laser system. For proper and safe use of this product, read this owner's manual carefully, and keep near at hand for future reference.
When you need any repair of this product, consult the dealer where you purchased this product.
- Never disassemble or modify this product. Changes or modifications may result in exposure to laser radiation.

Notes on region numbers

The region number of this player is 2. Region numbers, corresponding to specific geographical playback area, are printed on your DVD video disc. If you do not find  or , disc playback will not be allowed by the player. (In this case, the player will display a message on-screen.)

About this owner's manual

This owner's manual explains the basic instructions of this player. Some DVD video discs are produced in a manner that allows specific or limited operation during playback. As such, the player may not respond to all operating commands. This is not a defect in the player. Refer to instruction notes of discs.

“” may appear on the screen during operation.
A “” means that the operation is not permitted by the player or the disc.

Exemptions

- Toshiba is not liable for any damage caused by fires, earthquake, etc., uses by a third person, accidents, owner's intentional or unintentional misuse, or uses in other improper conditions.
- Toshiba is not liable for incidental damages (such as profit loss or interruption in business, modification or erasure of record data, etc.) caused by use or inability to use of this product.
- Toshiba is not liable for any damage caused by neglect of the instructions described in the owner's manual.
- Toshiba is not liable for any damage caused by misuse or malfunction through simultaneous use of this product and the connected equipment or software that Toshiba is not concerned with.

Table of contents

Introduction

Introduction

SAFETY PRECAUTIONS	2
IMPORTANT SAFETY INSTRUCTIONS	5
Precautions	10
Identification of Controls	16
Accessories	19
Notes and Information	20
Playable discs	20

Preparations

Preparation of the remote control	26
Installation	27
Antenna connection	28
Power connection	29
Using the battery pack	30
Powering on/off	33
Changing the mode	34
14 Using “Quick Menu”	35

TV viewing

Preparation for TV viewing	38
TV view operations	40
System settings	45

Playback

Loading a disc	48
Connecting to headphones	49
Playing a disc	50
Pausing playback (Still mode)	51
Adjusting the volume of the speakers or the connected headphones	51
Using the top menu.....	51
Changing a playback speed	53
Playing in fast reverse or fast forward	53
Playing frame by frame.....	53
Playing in slow-motion	53

Playing a desired scene	54
Skipping chapters or tracks	54
Locating by entering numbers	54
Marking the desired position to locate (Bookmark function).....	55
Playing in random order	56
Playing repeatedly	56
Repeating a specific segment.....	56
Repeating a title, chapter or track.....	57
Playing in a favourite order	58
Zooming a picture	59
Changing the camera angle	60
Selecting subtitles	60
Selecting a playback sound	61
Playing audio/video/picture files	62
Adjusting the picture	66
Selecting the sound enhancement	67
On-screen Display mode	67

Function Settings

Customizing the function settings	70
--	-----------

Connections

Viewing on a connected TV	78
Connecting to a device equipped with HDMI input	79
Viewing pictures from connected video equipment	80
Connecting to audio equipment	81
Connecting to an AV amplifier (via digital audio input).....	81
Connecting to an audio system equipped with analog audio inputs.....	82

Others

Output sound conversion table	84
Before calling service personnel	85
Specifications	88

Identification of Controls

Main Unit See page in  for details.

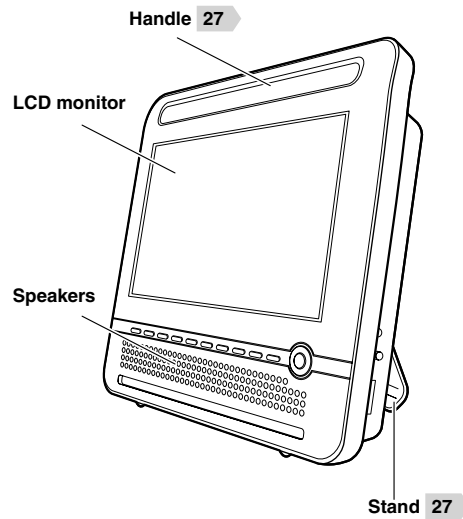

Instructions and actual buttons

Most instructions are based on remote control operation, unless otherwise noted. You can use the buttons on the remote control and those on the main unit as well when they have the same function. Some functions are available only from the remote control.

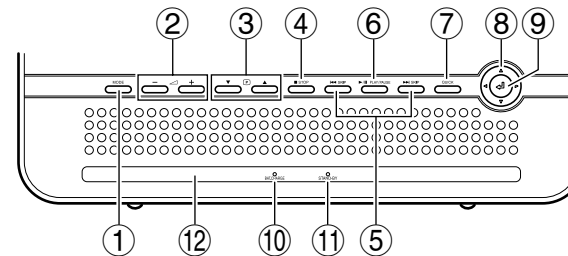

- | | |
|---|--|
| ① MODE button 34
To select the mode | ⑦ QUICK button 35
To display Quick Menu |
| ② - + buttons 40 51
To adjust the volume | ⑧ Direction button 38 51
To select a content or position to enter |
| ③ ▼ P ▲ buttons 40
To change TV channels | ⑨ ENTER button 38 51
To enter a selected content |
| ④ ■ STOP button 50
To stop playback | ⑩ BAT.CHARGE indicator 31
To display condition of the battery charge |
| ⑤ SKIP buttons (◀▶) 54
To locate a title, chapter or track | ⑪ STAND-BY indicator 33
To display condition of the power |
| ⑥ ▶ PLAY/PAUSE button
To switch between playback and pause (PLAY ↔ PAUSE) | ⑫ Remote sensor 26
Point the remote control here |

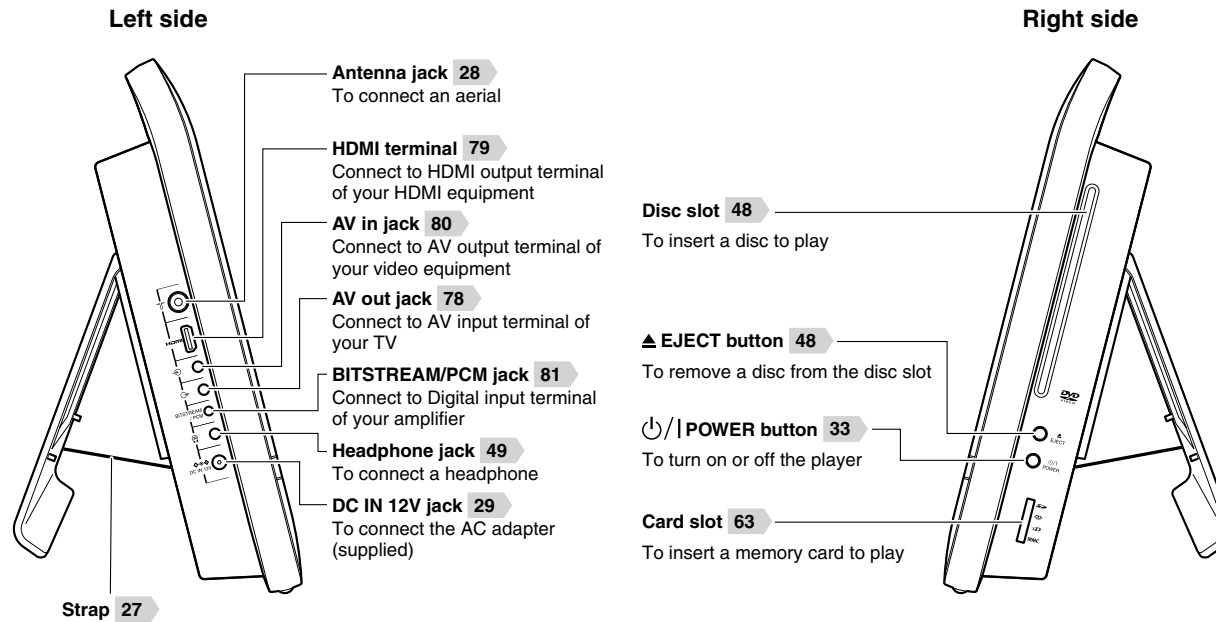

Identification of Controls (Continued)

Remote control

See page in  for details.

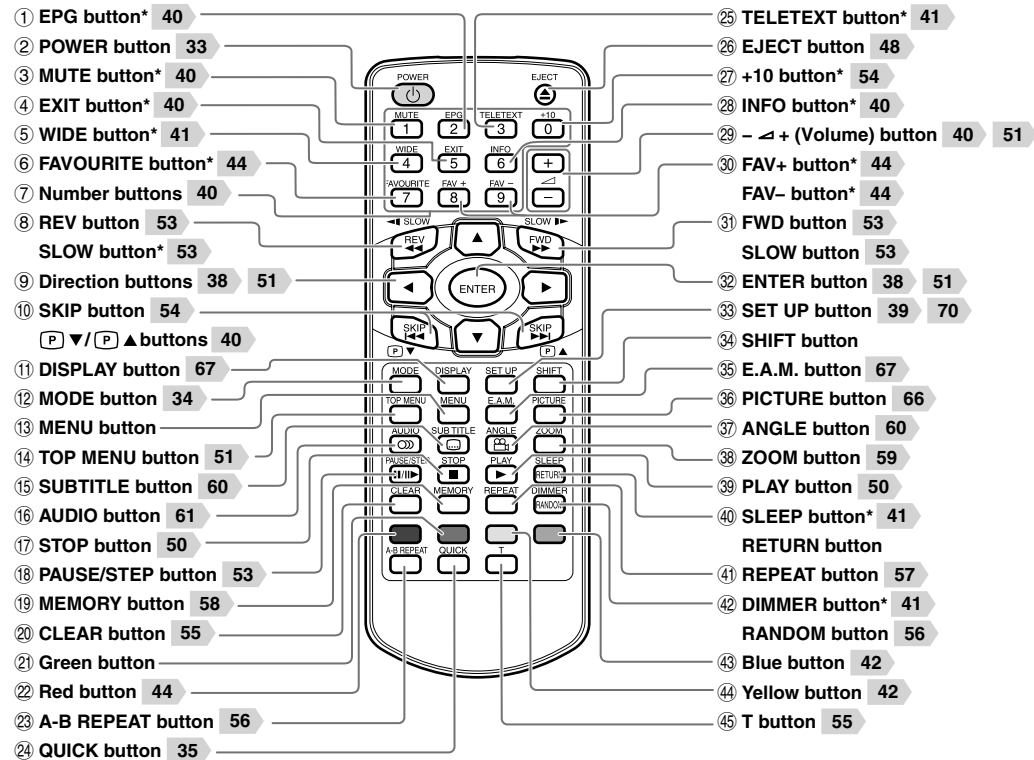





MENU button: Use the MENU button to display the menu included on many DVD video discs. To operate a menu, follow the instructions in "Using the top Menu" 51 .

***** buttons:** Operate these buttons while simultaneously pressing the SHIFT button.

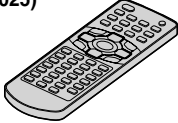
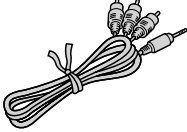
Accessories

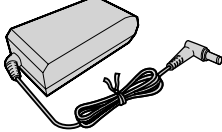
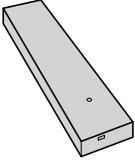
Check that the following accessories are supplied.

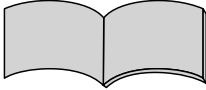
Remote control (MEDR120BX) Coin-shaped battery (CR2025) 	Audio/video cable 	Power cord* 	AC adapter (EADP-60EB A)* 
Battery pack* (SD-PBP120E) 	Headphones 	Outdoor aerial 	Owner's manual 







* Do not use an AC adapter, a power cord, and a battery pack other than one specified.
Also, do not use these supplied accessories with any device other than this player.

Notes and Information

Introduction

Playable discs

This player can play the following discs.

Disc	Disc Mark	Disc Size	Contents
DVD Video disc		12cm	<ul style="list-style-type: none"> • Video (moving pictures)+Audio
DVD-RW		12cm	<ul style="list-style-type: none"> • Video+Audio (DVD VR format (compatible with CPRM)/DVD video format)* *Finalized discs only. • Movie (DivX)
DVD-R		12cm	<ul style="list-style-type: none"> • Video+Audio (DVD VR format (compatible with CPRM)/DVD video format)* *Finalized discs only. • Movie (DivX)
Video CDs		12cm	<ul style="list-style-type: none"> • Video (moving pictures)+Audio
Audio CDs		12cm	<ul style="list-style-type: none"> • Audio
CD-ROM		12cm	<ul style="list-style-type: none"> • Audio (MP3 files) • Movie (DivX) • Photograph (JPEG files)
CD-R/RW		12cm	<ul style="list-style-type: none"> • Audio (CD-DA, MP3 files) • Movie (DivX) • Photograph (JPEG files) <p>* CD-R/RW discs of VIDEO CD format can also be played. Some of these discs may be incompatible.</p>

 is a trademark of DVD Format/Logo Licensing Corporation.

Notes

- You cannot play discs other than those listed on the previous page.
- You cannot play discs of DVD-RAM or non-standardized discs, etc., even if they may be labeled as those on the previous page.
- This player uses the PAL/NTSC colour system, and cannot play DVD video discs recorded in any other colour system (SECAM, etc.).
- Depending on the data recording method or the disc status, playback on this player may not be possible, even if the disc is labeled as those on the previous page. Toshiba cannot assure that all discs bearing the DVD or CD logos will operate as expected.
- Because of problems and errors that can occur during the creation of DVD and CD software and/or the manufacture of DVD and CD discs, Toshiba cannot assure that this player will successfully play every disc bearing the DVD and CD logos. If you happen to experience any difficulty playing a DVD and/or CD disc on this player, please contact Toshiba Customer Service.

■ On VIDEO CDs

This player supports VIDEO CDs equipped with the PBC (Version 2.0) function. (PBC is an abbreviation for Playback Control.)

You can enjoy two playback variations depending on types of discs.

- VIDEO CD not equipped with PBC function (Version 1.1)
Sound and movie can be played on this player in the same way as an audio CD.
- VIDEO CD equipped with PBC function (Version 2.0)
In addition to operation of a VIDEO CD not equipped with the PBC function, you can enjoy playback of interactive software with search function by using the menu displayed on the screen (Menu Playback). Some functions described in this owner's manual may not work with all discs.

Notes and Information (Continued)

Introduction

On handling discs

- Do not touch the playback side of the disc.

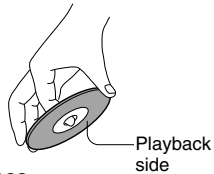

- Do not attach paper or tape to discs.

On cleaning discs

- Fingerprints and dust on the disc may cause picture and sound deterioration. Wipe the disc from the centre outwards with a soft cloth. Always keep the disc clean.
- Do not use any type of solvent such as thinners, benzene, commercially available cleaners or antistatic spray for vinyl LPs. It may damage the disc.

On storing discs

- Do not store discs in a place subject to direct sunlight or near heat sources.
- Do not store discs in places subject to moisture and dust such as a bathroom or near a humidifier.

- Store discs vertically in a case. Stacking or placing objects on discs outside of their case may cause warping.

Notes on copyright

The unauthorized recording, use, distribution, or revision of copyrighted materials including, without limitation, television programs, videotapes, and DVDs, is prohibited under the Copyright Laws of the United States and other countries, and may subject you to civil and criminal liability.

This product incorporates copyright protection technology that is protected by method claims of certain U.S. patents and other intellectual property rights owned by Macrovision Corporation and other rights owners.

Use of this copyright protection technology must be authorized by Macrovision Corporation, and is intended for home and other limited viewing uses only unless otherwise authorized by Macrovision Corporation. Reverse engineering or disassembly is prohibited.



Playable memory cards

Playable memory cards

Card	Card Mark	Contents
SD Memory Card		<ul style="list-style-type: none"> • Audio (MP3) • Photograph (JPEG)
Multi Media Card		<ul style="list-style-type: none"> • Audio (MP3) • Photograph (JPEG)
Memory Stick		<ul style="list-style-type: none"> • Audio (MP3) • Photograph (JPEG)
xD-Picture Card		<ul style="list-style-type: none"> • Audio (MP3) • Photograph (JPEG)

- SD is a trademark.
- MMC and MultiMediaCard are trademarks of Infineon Technologies AG and licensed to MMCA (MultiMediaCard Association).
- "Memory Stick" and are trademarks of Sony Corporation.
- or xD-Picture Card™ is a trademark of Fuji Photo Film Co. Ltd.
- You cannot play back DivX DRM written to a memory card.

Notes on memory cards

Some memory cards may not be played back due to its capacity and/or manufacturer, etc.

Do not insert any memory card other than those memory cards referred to left. Failure to follow this instruction may cause a malfunction of the player and/or card.

■ Saving data

- It is recommended that you back up your memory card data. Toshiba is not liable for any damage caused by the use of any memory card with this player. Toshiba will not compensate for any lost data or recording(s) caused by the use of such cards.
- For instructions on using your memory card, refer to the owner's manual for your memory card.
- Failure to take proper care of a memory card may prevent the display of pictures from the card. Such damage is not covered by your Toshiba Warranty.

Notes and Information (Continued)

Introduction

■ Notices for use

- Ensure that you insert the memory card correctly into this player.
- Do not eject the memory card while it is in use. If ejected while in use information on the memory card may be lost.
- This memory card is a precision electrical instrument. Do not bend, drop or apply strong force to it.
- Do not use or store the memory card in an environment of high static electricity or electrical interference.
- Avoid using or storing in areas of high temperature and humidity.
- Be careful not to touch with your fingers, nor allow foreign objects to come in contact with nor dirt to accumulate on the metal area (gold-coloured area) of the memory card. Wipe off any dirt with a soft, dry cloth.
- When carrying or storing the memory card always place it inside of its antistatic case to avoid any effects from static electricity. If there is a storage case, place the memory card in the antistatic area of the storage case.
- If you place a memory card that has been exposed to static electricity in this player, there is a chance that this player could malfunction.

24

- Do not place the memory card in your trouser pocket. The memory card may break if any strong force is applied, such as when sitting.
- When ejecting the memory card after extended use it may feel warm to the touch. This is normal. The memory card is not malfunctioning.
- The memory card is designed to have a long life but after extended use you will not be able to delete from or write to it. Please purchase another.

■ Write Protection of SD Memory Card

- Switch the write protect tab at the side of the SD card to "LOCK".

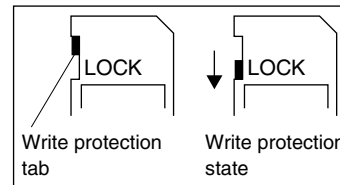

■ About Memory Stick

Magic Gate and high speed data transmission are not available on this player.

Preparations

Preparations before using.

- **Preparation of the remote control**
- **Installation**
- **Antenna connection**
- **Power connection**
- **Using the battery pack**
- **Powering on/off**
- **Changing the mode**
- **Using “Quick Menu”**

Preparation of the remote control

Insert the specified battery in the remote control. See page 8, 9 for safe use of coin-shaped batteries.

Preparations

- 1 Gently insert a fingernail in groove ① and pull out the holder in direction ②.

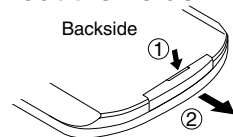

Take care not to break your fingernail.

- 2 Place a coin-shaped battery (CR2025) with the + side up on the holder.

Keep the holder horizontal so that the battery does not fall through.

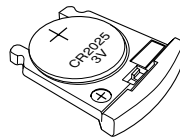

CAUTION: Danger of explosion if battery is incorrectly replaced. Replace only with the same or equivalent type.

- 3 Insert the holder into the remote control.

The remote control battery contains Perchlorate Material - special handling may apply.

Operating with the remote control

Point the remote control at the remote sensor at a right angle to the LCD and press the buttons.

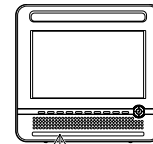

Within about 3 m (9.9 feet)



Distance: About 3 m (9.9 feet) from the front of the remote sensor

Angle: About 30° in each direction of the front of the remote sensor

Do not expose the remote sensor of the player to a strong light source such as direct sunlight or other illumination. If you do so, you may not be able to operate the player via the remote control.

- Aim the remote control at the remote sensor of the player.
- Do not drop or give the remote control a shock.
- Do not leave the remote control near an extremely hot or humid place.
- Do not spill water or put anything wet on the remote control.
- Do not disassemble the remote control.
- If the remote control does not function correctly or if the operating range becomes reduced, replace the battery with new one.
- Inserting a battery other than the specified one or an object may damage the remote control.

Installation

Read page **5** - **10** to secure a safe position.

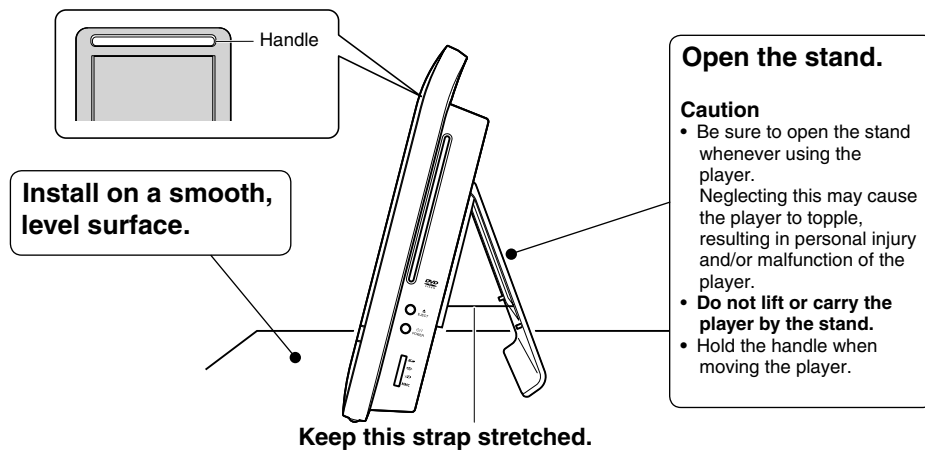

Notes

- Be careful not to damage the LCD when moving the player.
- Do not hang or suspend the player.

Antenna connection

Preparations

The tip of the outdoor aerial is sharp and can inflict injury such as puncture wounds. Be careful when handling it.

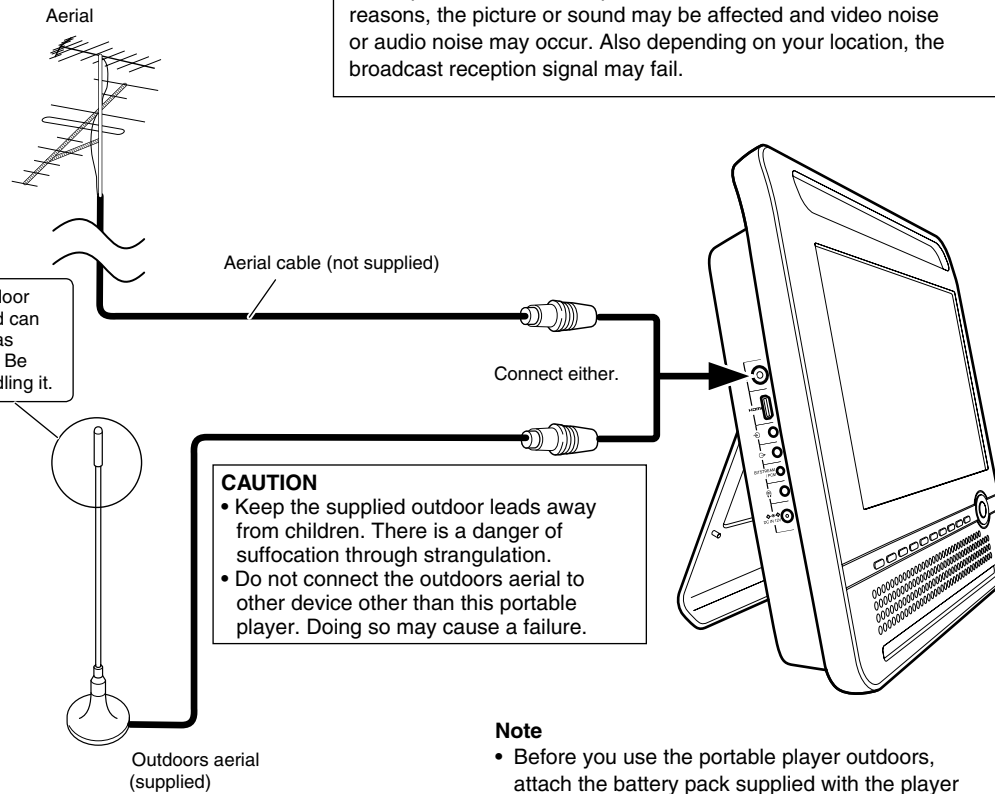

Power connection

Connect the supplied AC adapter to wall outlet as below.

CAUTION

- Do not connect the power plug to a power outlet other than that indicated on the label, as this can result in a risk of fire or electric shock.
- Do not connect or disconnect the power plug with wet hands. Doing so may cause electric shock.
- Do not use an AC adapter other than one specified, as it can cause a fire or damage to the player.
- When the AC adapter is in use, its temperature may increase. However, it is not a malfunction. Make sure that the power cord is disconnected and the temperature decreases before carrying it.

Preparations

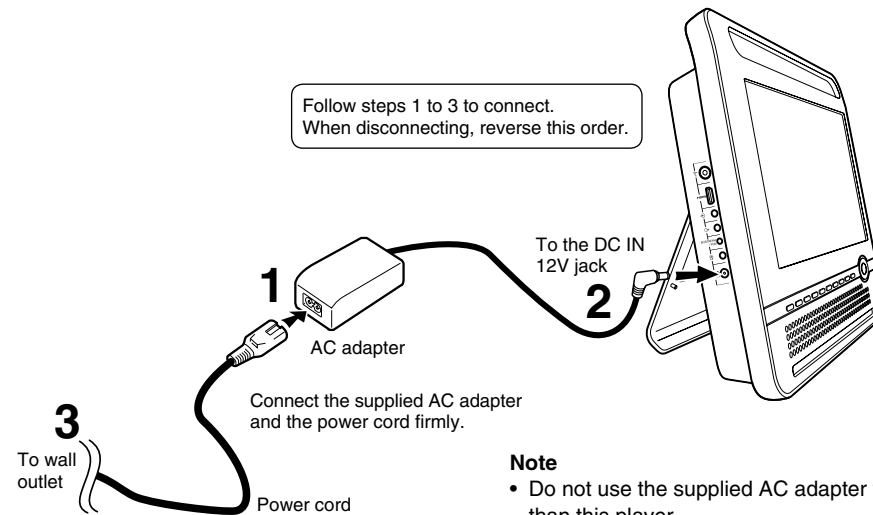

29

Using the battery pack

The supplied battery pack (lithium ion battery pack) can power the player for operation outdoors or in a place with no outlets.

Preparations

WARNING

- Do not use a battery pack other than one specified as it can result in a fire or damage to the unit.
- Do not heat, open, or short-circuit the battery pack. Do not throw the battery pack into a fire. Doing so may cause an explosion or a fire.
- Attach the battery pack properly following the explanation below. Make sure that the battery pack is attached firmly to the player when using it. Otherwise, the battery pack may become detached and cause personal injury.

■ Attaching the battery pack

- 1 Turn the player off.
- 2 Disconnect all cables and cords from the player.
- 3 Turn the player upside down and lift the stand.

- 4 Open the connector cover on the back of the player.

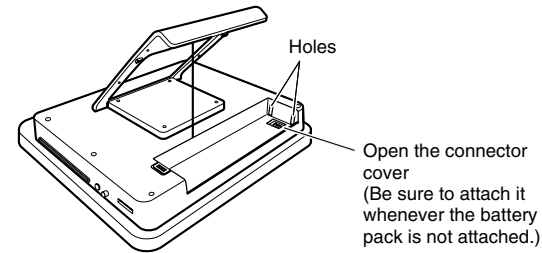

- 5 Insert the battery pack's catches into the player's corresponding holes. Then attach the battery pack in the direction of the arrow until a "click" is heard.

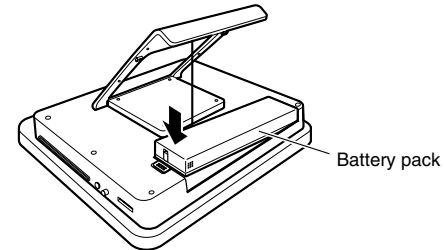

Important

- Detach the battery pack from the player if not used for prolonged periods.

■ Charging the battery pack

The battery pack needs to be charged before use. (The battery indicator is shown in the upper left corner of the screen when the power in the battery pack is running low.) Perform a full charge before the first use.

1 Turn off the player.

The battery pack cannot be charged when the player is on. Be sure to turn off the player before charging the battery pack.

2 Attach the battery pack to the player.

3 Connect the supplied AC adapter and the power cord only to the player.

Charging starts, and the BAT.CHARGE indicator illuminates in orange.

When the charging is completed, the BAT.CHARGE indicator turns off.

Charging time of a battery pack	Approximately 4.5 hours
---------------------------------	-------------------------

- This value is for reference only. Charging time may vary depending on battery pack status and environment.

Continuous playback time while using the battery pack	Up to approximately 3 hours
---	-----------------------------

- This value is for reference purpose only, it is not guaranteed. (Conditions: 25°C, output from the headphones, DVD playback, new battery pack in use.)
- Continuous playback time may vary depending on battery pack status, operational status and environment conditions.
- Low temperature will shorten the playback time.

Notes

- Charge the battery pack with a surrounding temperature of +10°C to +30°C (+50°F to +86°F).
- While the charge is in progress, do not disconnect the AC adapter and the power cord until the BAT.CHARGE indicator turns off.
- The attached battery pack may get warm when you are charging it or operating the player. This is not a defect.

Using the battery pack (Continued)

Preparations

■ Detaching the battery pack

- 1 Turn the player off.
- 2 Disconnect the AC adapter and the power cord from the player.
- 3 Turn the player upside down and lift the stand.
- 4 Slide the battery pack's lock switch in the direction of the arrow ①, then detach the battery pack in the direction of the arrow ②.

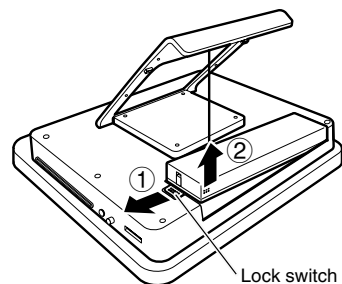

- 5 Close the connector cover on the back of the player.

Important

- After detaching the battery pack, be sure to close the connector cover in order to avoid a short-circuiting which may be caused by contact with metal objects to the connector.
- Do not detach the battery pack while the STAND-BY indicator is illuminated in red or green.

■ About battery pack life

Battery pack has a limited service life. The length of service life varies depending on product use and user settings. If you use the battery pack beyond its service life, you may notice that playback time becomes remarkably shorter, even if the battery pack is fully charged. If you notice that playback time has become remarkably shorter, even when the battery pack is fully charged, it is recommended that you replace the battery pack with battery pack model number SD-PBP120E.

Powering on/off

Turning the power on/off

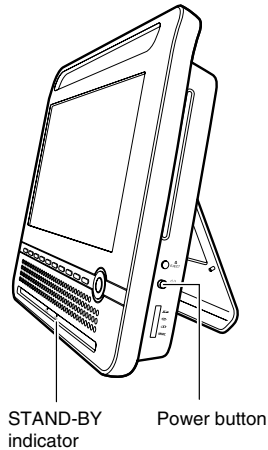

Press  / **POWER** on the main unit.



When the power turns on, STAND-BY indicator turns green.

To turn the power off, press  / **POWER** on the main unit.

Note

- Turning on by  / **POWER** always sets the player in DTV mode. Turnig on by  / **POWER** on the remote control always resumes the last mode. For details on modes of this player, see page **34**.

Turning the power on/off in standby mode

Press  **POWER** on the remote control.



The power turns on and STAND-BY indicator changes colour from red to green.

If you press  **POWER** on the remote control again, the power turns off and STAND-BY indicator turns red.

Condition	STAND-BY indicator
On	Green
Standby	Red
Off	Off

Changing the mode

You can enjoy various contents of discs, the digital TV and other external equipment by changing the mode. Change it depending on your needs.

Preparations

Press **MODE** repeatedly to select the mode.

Each time you press **MODE**, the mode changes on the screen as below.

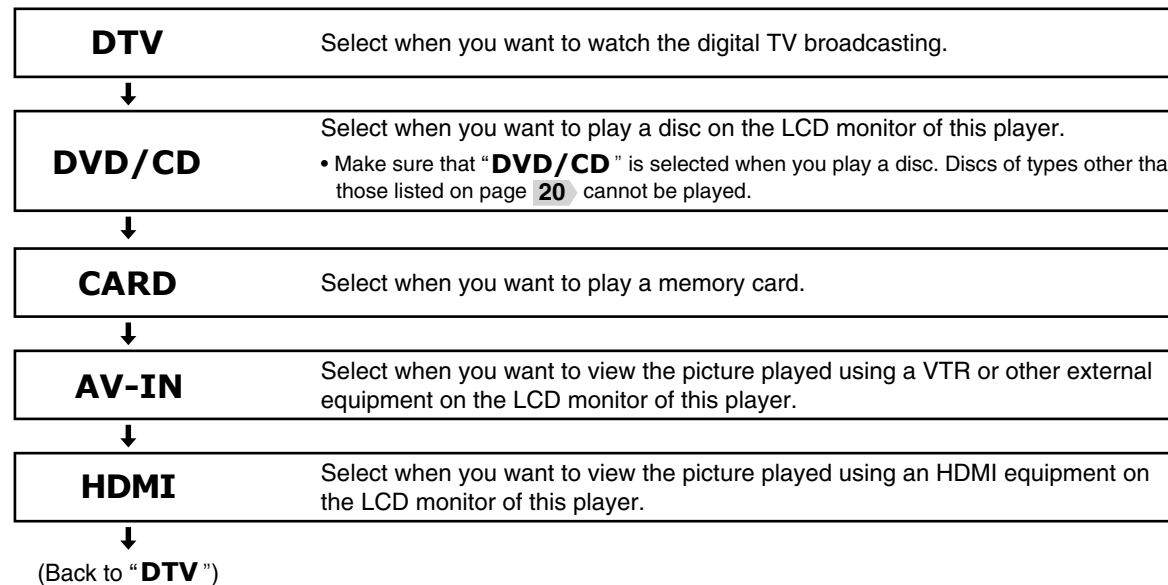

Using “Quick Menu”

When you want to change settings, open “Quick Menu”, a list of functions which are available in the current mode. It can be operated in the same manner in any mode.

1 Press QUICK.

“Quick Menu” appears.
The contents may vary depending on the mode.

e.g.



2 Press ▲ / ▼ to select an item, then press ENTER.

3 Set the details.



TV viewing

- Preparation for TV viewing
- TV view operations
- System settings

Preparation for TV viewing

Initial setup

When you first use the DTV, the unit shows the language menu for initial setting. Follow through this process to search channels available in your area.

1 Turn the power on.

The language menu will appear in a few seconds.

2 Press ▲ / ▼ to select the desired language listed in the menu, and then press ENTER.

The country setting menu will appear.

3 Select the country then press ENTER.

The confirmation message will display to start search.

4 Select “Confirm” using ◀ / ▶ then press ENTER.

The search progress display appears and scanning of available channels will start.

After completing the search, the unit displays the first TV program on the list.

■ To change the language or country setting

If you want to change the language or country setting, perform the initial setting steps again. You need to reset to the factory default setting before changing the settings. See page 39.

Channel scanning

■ Automatic channel scan

If any menu screen doesn't show up at the first use of this unit (see "Initial setup"), you can search channels by automatic channel scan. Also, you can add new channels to the channel list.

- 1 Press **SET UP** to display the main menu.
- 2 Press **▲ / ▼** to select "Channel Search" then press **ENTER**.
- 3 Press **◀ / ▶** to select "Auto Scan" then press **ENTER**.

The channel scan will start.

■ Manual channel scan

This scan can search channels by specifying frequency.

- 1 Press **SET UP** to display the main menu.
- 2 Press **▲ / ▼** to select "Channel Search" then press **ENTER**.
- 3 Press **◀ / ▶** to select "Manual Scan".

- 4 Select "Channel No" using **▲ / ▼** and enter the desired channel, then press **ENTER**.

Scanning will start.

To cancel the search, press **EXIT** while pressing **SHIFT**.

■ To reset to the factory default setting

- 1 Press **SET UP** to display the main menu.
- 2 Select "System Setting" using **▲ / ▼**, then press **ENTER**.
- 3 Press **▲ / ▼** to select "First Time Installation" then press **ENTER**.
The confirm window appears.
- 4 Press **◀ / ▶** to select "Confirm" then press **ENTER**.

To cancel the default setting, select "Exit" on confirmation window, then press **ENTER**.

When the default setting is complete, the Language setting menu appears in the display.

TV view operations

TV viewing

Channel selection

You can select channels by the following ways:

- 1 Press **P** ▼ / **P** ▲.
- 2 Press number buttons on the remote control.
 - e.g. To select 2 channel
Press 2
 - e.g. To select 56 channel
Press 5 → 6 (Within about 1 second)

To adjust the volume

Press **+/-** (Volume button).
The volume indicator will appear in the display.
+ : Increases the volume
- : Decreases the volume
The volume indicator will disappear if neither button is pressed for a few seconds.

To mute the sound

Press **MUTE** while pressing **SHIFT**.
The sound is silenced.

- 40 To restore the sound, do this operation again.

To display EPG (Electronic Programme Guide)

You can do the following operations on EPG.

■ To view current program information

Press **EPG** while pressing **SHIFT** then press **P** ▼ / **P** ▲ to select a channel.

The current program information of selected channel will be displayed.

■ To view selected channel schedule for a week

(Where available)

After selecting a channel, press **◀** / **▶** to select a day of a week.

■ To reserve the program

Press **▲** / **▼** to select the desired program then press **ENTER**.

A mark will appear next to the selected channel and the program is reserved.

When the reserved program starts, the information display will appear to remind.

Press **EXIT** while pressing **SHIFT** to exit.

To display current channel information

Press **INFO** while pressing **SHIFT**.

The current channel information display will appear on the screen.

To adjust brightness of the LCD

You can adjust the brightness of the LCD.

Press **DIMMER** while pressing **SHIFT**.

Each time you press **DIMMER**, the brightness level changes from 1 (dark) to 4 (bright).

To set sleep timer

This unit can be turned off automatically by setting a sleep time.

Press **SLEEP** while pressing **SHIFT** repeatedly until the desired sleep time appears in the display.

Each time you press **SLEEP**, the setting time changes as follows:

0h00m → 0h15m → 0h30m → 1h00m → 1h30m → 2h00m

To cancel the sleep setting, press **SLEEP** repeatedly until "0h00m" appears.

To change the screen size

You can select the screen size to your preference.

Press **WIDE** while pressing **SHIFT**.

Each time you press **WIDE**, the screen size changes. (depending on the broadcast)

Using the teletext

If the selected TV channel has teletext features, you can access them.

■ To display teletext

Press the **TELETEXT** while pressing **SHIFT**.

The teletext display will be displayed.

■ To select a teletext page

Press **▲** / **▼** to select a desired teletext page, press **ENTER**.

To close, press **TELETEXT** while pressing **SHIFT**.

TV view operations (Continued)

TV viewing

Using the channel list

■ To display the channel list

You can view the channel list previously stored by scanning.

Press **SET UP** to display the main menu and select "Channel List" using ▲ / ▼ then press **ENTER**.

The channel list will appear.

To preview the program, select a channel using ▲ / ▼ then press **ENTER**.

You can preview the selected channel.

Press **EXIT** while pressing **SHIFT** to exit.

■ About mini channel list

If you press **ENTER**, the mini channel list will appear in the display. You can also change channels using this list.

■ To delete a channel

Select "Channel List" in the main menu, press ▲ / ▼ to select a channel you want to delete from the channel list.

Then press the yellow button on the remote control to delete the selected channel.

■ To lock channels

The pin code is required to lock channels, see page 45 .

1 Select "Channel List" in the main menu, press ▲ / ▼ to select a channel you wish to lock, then press the blue button.

The enter pin code display will appear.

2 Enter a correct pin code using the number buttons then press **ENTER**.
(The default pin code is 888888).

The symbol appears next to the selected channel.

To cancel the channel lock, repeat step 1 to 3 to remove the symbol.

Press **EXIT** while pressing **SHIFT** to exit from the channel list.

■ **“Quick Menu” in TV mode**

See page **35** on how to operate “Quick Menu”.

e.g.



① **PICTURE**

A picture adjustment menu **66** appears.

② **SETUP**

A setting menu **70** appears.

TV view operations (Continued)

Customizing channel lineup

You can store lists of your favourite channels.

■ To add channels to the favourite list

- 1 Press **SET UP** to display the main menu.
- 2 Press **▲ / ▼** to select "Favourite List" and then press **ENTER**.
- 3 Press the red button repeatedly to select the available list.
- 4 Press **▲ / ▼** to select desired channel in the selected favourite list then press **ENTER**.

The selected channel stored to the list and a symbol will appear next to the program name.

Press **EXIT** while pressing **SHIFT** to exit.

■ To delete favourite channels

- 1 In the favourite list, press the red button repeatedly until the required list is displayed.

- 2 Press **▲ / ▼** to select the channel you want to delete from the favourite list and then press **ENTER**.

The symbol will disappear and the channel is deleted.

Press **EXIT** while pressing **SHIFT** to exit.

■ To view the favourite channel

- 1 Press **FAVOURITE** while pressing **SHIFT** to display the favourite list.
- 2 Press the red button repeatedly to select the available favourite list.
- 3 Press **▲ / ▼** to select the favourite channel in the selected favourite list and then press **ENTER**.

You can view the channel on full screen.

Press **EXIT** while pressing **SHIFT** to exit.

You can also select channels by **FAV+** or **FAV-** on the remote control.

System settings

■ To display system information

You can view the software version and hardware version of this unit.

- 1 Press **SET UP** to display main menu.
- 2 Press **▲ / ▼** to select "System Setting" then press **ENTER**.
- 3 Press **▲ / ▼** to select "System Info" then press **ENTER**.

The system information will display.

The display will disappear in a few seconds.

■ To change the pin code

- 1 Perform steps 1 to 2 above, press **▲ / ▼** to select "Parental Setting" then press **ENTER**.
- 2 Enter the pin code using the number buttons. (Default pin code is 888888)
- 3 Press **▲ / ▼** to select "Pin Code", then press **ENTER**.
- 4 Enter the old pin code using the number buttons.

- 5 Press **▲ / ▼** to select "New Pin Code" and enter a new pin code using the number buttons. (6-digit pin code)
- 6 Press **▲ / ▼** to select "Enter Again" and enter the new pin code again then press **ENTER**.

■ To set the parental level

- 1 Perform steps 1 to 2 above, press **▲ / ▼** to select "Parental Setting", then press **ENTER**.
- 2 Enter the pin code using the number buttons.
- 3 Press **▲ / ▼** to select "Parental Setting".
- 4 Press **▶** to display parental level.
- 5 Press **▲ / ▼** to select the parental level to set, and then press **ENTER**.

The display will disappear in a few seconds.



Playback

Play your favourite disc.

- Loading a disc
- Connecting to headphones
- Playing a disc
- Changing a playback speed
- Playing a desired scene
- Playing in random order
- Playing repeatedly
- Playing in a favourite order
- Zooming a picture
- Changing the camera angle
- Selecting subtitles
- Selecting a playback sound
- Playing audio/video/picture files
- Adjusting the picture
- Selecting the sound enhancement
- On-screen Display mode

Loading a disc

For disc compatibility information, see page 20 .

Load a disc in the disc slot.

Do not insert an 8cm disc.
Never use incompatible discs.
Neglecting this may cause
malfunction.

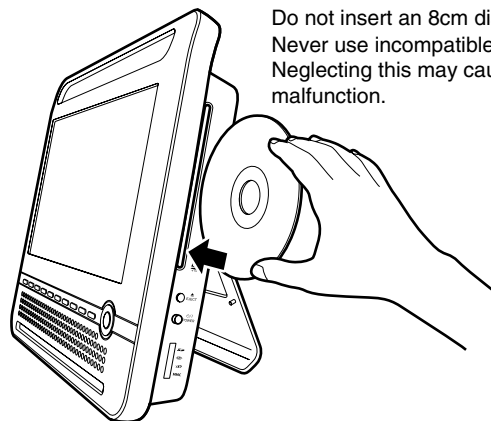

Insert a disc into the disc slot with the label side facing forward. (If the disc has a label.) Hold the disc without touching either of its surfaces, align it with the guides, and place it in position.

To remove the disc

 Press **EJECT** then remove the disc after the disc comes out.

CAUTION

- Keep your fingers clear of the disc slot when disc is loading or unloading. Neglecting to may cause serious personal injury.
- Do not use a cracked, deformed, or repaired disc.
- Do not tilt, shake or move the main unit while playing. It may damage the disc.
- Do not put any discs or any objects into the disc slot other than those disc types listed on page 20 .

Connecting to headphones

You can connect headphones to the headphone jack using a stereo mini plug.

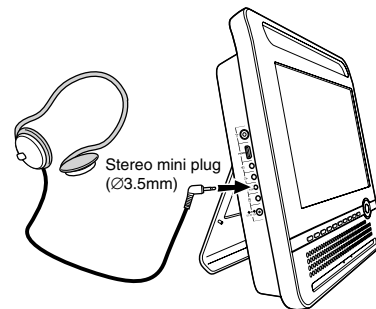

- Before connecting, temporarily turn down the volume with the volume button. Readjust to your preference when playback starts.
- Turn off the player before you connect or disconnect the headphone cable. Possible shakes produced by plug connecting/disconnecting may cause damage to the disc.

CAUTION

When you use headphones, keep the volume at a moderate level. If you use the headphones continuously with high volume sound, it may cause hearing damage.

Playing a disc

DVD-V **VCD** **CD**

The following icons are used in this manual to indicate features and/or functions that are applicable to each disc.

DVD-V : DVD Video disc **VCD** : Video CD **CD** : Audio CD

■ Preparations

- Turn on the power of the player.
- Select “**DVD/CD**” by pressing **MODE**.

Caution

Never operate the player in a moving vehicle. Vibration may prevent proper playback of the player or cause damage to the disc.

Note

- In many instances, a menu screen will appear after playback of a movie is completed. If you have connected the player to a television, and depending on the type of television that you have, prolonged display of an on-screen menu may result in the on-screen menu becoming permanently ingrained in the screen. This type of damage is not covered by your Toshiba Warranty. To avoid this, be sure to press the STOP button once the movie is completed.

1 Insert a disc into the disc slot.

Playback starts.

If playback does not start automatically, press **PLAY**.

- If you select a DVD video disc that contains a top menu, or select a PBC (Playback Control)-featured VIDEO CD, a menu may appear. See “Using the top menu” **51**.
- You may need to press the TOP MENU or MENU button to display the disc menu depending on the DVD video disc.
- When you play an audio CD, “menu” screen appears. See “Playing audio/video/picture files” **62** about the operation.

2 Press STOP to stop playback.

About Resume playback function

The player memorizes the location where playback is stopped and resumes playback from the location where you stopped.

If you press PLAY after stopping playback, playback starts from the location where you stopped.

- The player memorizes the information for resume playback up to 3 discs. The oldest memory is deleted if 4th disc is inserted.
- If you want to return to the beginning of a DVD video disc, press STOP twice.

Notes

- The player’s memory is cleared when you use a PBC-featured VIDEO CD while “PBC” is set to “On”. (Refer to “Function Settings”.)
- There may be a difference in the location where playback resumes depending on the disc.

Pausing playback (Still mode)

Press **PAUSE/STEP** during playback.
The picture gets still and sound is muted.
To resume normal playback, press **PLAY**.

Adjusting the volume of the speakers or the connected headphones

Press **+/-** (Volume button).
The volume indicator will appear in the display.
VOL+: Increases the volume.
VOL-: Decreases the volume.
The volume indicator will disappear if neither button is pressed for a few seconds.

Using the top menu

DVD-V **VCD** **CD**

1 Press **TOP MENU**.

The top menu appears.

2 Press **▲ / ▼ / ◀ / ▶** to select the title you want.

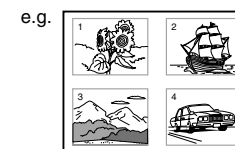

3 Press **ENTER**.

Playback starts from chapter 1 of the selected title.

Notes

- This method of locating a title is available only on a disc that contains a top menu.
- Instruction notes of discs may refer to the button that displays the top menu as **TITLE** button.
- The instructions above describe basic procedures which may vary depending on the contents of the DVD video disc. If different instructions appear on the screen, follow those instructions.

Playing a disc (Continued)

■ About the screen saver

If 20 minutes elapse while the power is on and there is no disc in the player or while the disc is stopped, the screen saver is automatically displayed (when "Screen saver" (refer to "Function Settings") is set to "On"). To turn off the screen saver, press any button on the main unit or remote control.

■ Automatic power off function

If the player is stopped or the screen saver is engaged for approximately 20 minutes, the LCD power automatically turned to standby mode. To turn on the LCD monitor, press the power button on the remote control.

■ About the LCD

- The LCD panel contained in this product is manufactured using an extremely high level of precision technology; however, there may be an occasional pixel (dot of light) that does not operate properly (does not light, remains constantly lit, etc.).

This is a structural property of LCD technology, is not a sign of malfunction, and is not covered under your warranty. Such pixels are not visible when the picture is viewed from a normal viewing distance.

- The cold cathode fluorescent lamp in the LCD panel of this product, which illuminates the LCD panel from the inside, will deteriorate with use (standard length of life is approximately 10,000 hours of continuous use at normal temperature). When the LCD panel becomes dim, flickers, or does not illuminate, contact your consumer electronics dealer for replacement. The length of LCD panel life mentioned above is for reference purposes only; actual length of life of the LCD panel may vary.
- The brightness of the LCD monitor differs slightly depending on the viewing angles. Adjust the LCD monitor angle to obtain the best viewing. (The recommended viewing angle is 90 degrees to the monitor.)

Changing a playback speed

Playing in fast reverse or fast forward

DVD-V VCD CD

Press **REV** or **FWD** during playback.

◀◀ : Fast reverse playback

▶▶ : Fast forward playback

Each time you press the REV or FWD button, the playback speed changes.

Press **PLAY** to resume normal playback.

- Also, playback changes to fast reverse or fast forward when you press and hold SKIP on the main unit.

Notes

- The player mutes sound and omits subtitles during reverse and forward scan of DVD video discs.
- The playback speed may differ depending on the disc.
- This equipment supports playback of DVD-RW (VR mode) discs. However, playback or fast-forward/rewind may not function properly depending how the disc was created, the status of titles on the disc or the condition of the disc itself.

Playing frame by frame

DVD-V VCD CD

During playback, press **PAUSE/STEP** to pause playback.

Press **PAUSE/STEP** repeatedly to play frame by frame.

Press **PLAY** to resume normal playback.

Note

- The sound is muted during frame by frame playback.

Playing in slow-motion

DVD-V VCD CD

Press **SLOW** (◀◄ / ▶▶) while pressing **SHIFT** during playback.

If you press the **SLOW** (◀◄) during playback, you can view the picture in reverse slow-motion. (Only when using a DVD video disc.)

Each time you press the **SLOW** (◀◄ / ▶▶) button, the slow-motion speed changes.

Press **PLAY** to resume normal playback.

Notes

- The sound is muted during slow-motion playback.
- The playback speed may differ depending on the disc.

Playing a desired scene

DVD-V VCD CD

Skipping chapters or tracks

- 1 Press SKIP (◀◀ / ▶▶) repeatedly to locate the chapter or track you want.

Playback starts from the selected chapter or track.

▶▶: Playback starts from the beginning of the next chapter or track.

◀◀: Playback starts from the beginning of the current chapter or track.

When you press twice, playback starts from the beginning of the preceding chapter or track.

Locating by entering numbers

- 1 Press T several times to display "Search".

The display changes each time this button is pressed.

e.g. DVD-V

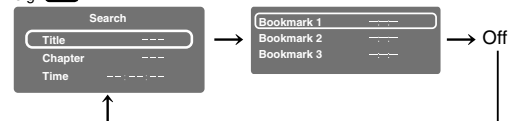

54

- 2 Press ▲ / ▼ to select the category you want to search.

Category	To search by specifying:
Title*	Title number
Chapter*	Chapter number
Track	Track number
Time	Elapsed time of the current track
Disc Time	Elapsed time in the entire disc

*: Not available in CD playback.

- 3 Press the number buttons to enter a number.

• e.g. To enter 25:

2 → 5
or
+10 → +10 → 5

• e.g. To enter the time 1 hour 25 minutes 30 seconds:

1 → 2 → 5 → 3 → 0

- 4 Press PLAY or ENTER.

Playback starts from the selected section.

Notes

- Pressing the CLEAR button while pressing the SHIFT button resets the numbers.
- Some discs may not respond to this process.
- Some scenes may not be located precisely as you specified.

Marking the desired position to locate (Bookmark function)

First register a bookmark referring to “To register a bookmark” of the next paragraph, then operate these steps below.

1 During playback, press T repeatedly to display “Bookmark”.

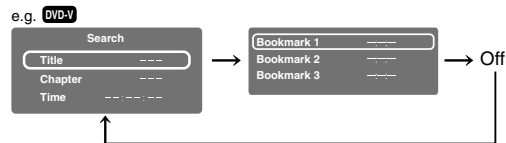

2 Press ▲ / ▼ to select a number (1, 2, 3) of “Bookmark”, then press ENTER.

Playback starts from the selected point.

■ To register a bookmark

You can register up to 3 bookmarks.

- 1 At a scene where you want to register a bookmark, press **PAUSE/STEP** to pause.
- 2 Press **T** repeatedly to display “Bookmark”.
- 3 Press **▲ / ▼** to select a number (1, 2, 3) of “Bookmark”, then press **ENTER**.

Select a vacant (“-- : -- : --”) number.

To cancel the procedure, press **T** to turn the display off.

To cancel your entry, press **CLEAR** while pressing **SHIFT** to erase the digits to return to “-- : -- : --”.

- 4 Press **ENTER**.

The scene is registered to the bookmark.
(A registered bookmark information is cleared if another disc is inserted or the power of the player is turned off.)

Note

- Bookmarks may not be able to be registered for some discs or scenes.

Playing in random order

DVD-V VCD CD

- 1 During playback, press **RANDOM** to display “Shuffle On” on the screen.

Each time you press the button, the random mode “Shuffle On” and “Shuffle off” alternate.

The mode on the screen will disappear in a few seconds if not operated.

If you display “Shuffle On”, random playback starts after finishing the current chapter or track.

When playing an audio CD, see page 64 .

■ To resume normal playback

Press **RANDOM** repeatedly until “Shuffle off” appears.

Notes

- Some discs may permit random playback.
- The random mode will be canceled when you turn off the power.
- If you press **STOP** twice, the random mode ends and playback stops.

56

Playing repeatedly

DVD-V VCD CD

Repeating a specific segment

- 1 Press **A-B REPEAT** at the beginning of the segment (point A) you want to play repeatedly.

“Rep A-” appears.

- 2 Press **A-B REPEAT** again at the end of the segment (point B).

“Rep A-B” appears and the player automatically returns to point A and starts playback of the selected segment (A-B).

■ To resume normal playback

Press **A-B REPEAT** repeatedly until “RepAB Off” appears.

Notes

- If you press **STOP** twice, the A-B repeat function ends and playback stops.
- You can specify a segment only within the current title or track.
- There may be a slight difference between point A and the location where playback starts actually resumes depending on the disc.
- Functions other than **STOP** and **A-B REPEAT** may not be available during A-B repeat playback.

Repeating a title, chapter or track

1 During playback, press REPEAT repeatedly to select the repeat mode.

Each time you press the button, the repeat mode changes on the screen.

Repeat playback starts after finishing the current chapter or track.

Disc	Mode	Repeating range
DVD-V	Repeat Chapter	Current chapter
DVD-V	Repeat Title	Current title
VCD CD	Repeat single	Current track
VCD CD	Repeat all	Whole disc
DVD-V VCD CD	Repeat off	Returns to normal playback.

Notes

- Some discs may not permit repeat playback.
- The repeat mode will be canceled when you turn off the power.
- If you press STOP twice, the repeat mode ends and playback stops.

Playing in a favourite order

DVD-V VCD CD

1 During stop, press MEMORY.

The programming display appears.

e.g. DVD-V

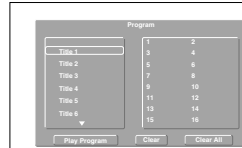

Enter a track number when using a video CD.

2 Setting the title, chapter or track in the order you wish to play.

- 1) Select the number of title you want to set using ▲ / ▼ then press **ENTER**.
 - 2) Select the number of chapter you want to set using ▲ / ▼ then press **ENTER**.
 - 3) Setting another memory, select [...] then press **ENTER**. After that the programming display appears.
Follow steps 1 to 2 for the setting.
- Some discs may not contain chapter or track numbers. If so chapter or track number cannot be entered.

3 Press ► to select “Play Program” then press ENTER.

The player starts memory playback.

■ To cancel the programmed selections

- Select “Clear” on the screen and press **ENTER** to clear the programmed selection.
- Select “Clear All” on the screen and press **ENTER**. All of the programmed selections are cleared.

■ To stop memory playback

Press **STOP** twice.

The repeat mode ends and playback stops.

Notes

- Some discs may not permit memory playback operation.
- The programmed selection will be cleared when you turn off the power.
- Memory playback pauses if you press MEMORY while being executed.

Zooming a picture

DVD-V

VCD

CD

1 Press ZOOM during playback.

The zoom icon appears.

This operation is available also during slow, still, fast forward or fast reverse playback.

A rectangular button with a magnifying glass icon and the text 'x2'.

2 Select the zoom point and magnification level.

- **Magnification level:**
Press ZOOM repeatedly.

The magnification level changes as follows:

“Q X2” (Twice the size)

“Q X3” (Three times the size)

“Q X4” (Four times the size)

“Off” (Normal size)

Zoom point:

Press ▲ / ▼ / ◀ / ▶ repeatedly.

■ To resume normal playback

Press **ZOOM** repeatedly until “Off” appears.

Notes

- Some discs may not respond to zoom feature.
- Depending on scenes, the buttons may not work as described.
- Zooming does not work on characters selected on menus.
- Zoom playback will be canceled when you turn off the power.

Playback

Changing the camera angle

DVD-V VCD CD

1 Press ANGLE while playing a scene recorded with multiple camera angles.

The angle icon (📐) appears on the screen.

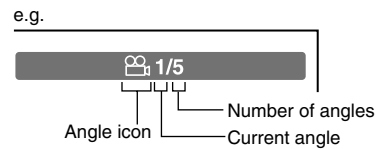

This display does not appear if the disc includes no scenes recorded with multiple angles.

If you press ANGLE while playing a scene not recorded with multiple angles, the angle selection is not possible.

2 Press ANGLE to select the camera angle.

Each time you press the button, the camera angle changes.

Notes

- After selecting angle, it will take a few moments to change the camera angle of the scene you are viewing.
- If you pause a picture immediately after changing a camera angle, the resumed playback picture may not display the new camera angle.

60

Selecting subtitles

DVD-V VCD CD

1 Press SUBTITLE during playback.

The current subtitle setting is displayed.

2 Press SUBTITLE while the subtitle setting is displayed on the screen.

Each time you press the SUBTITLE button, you can select a subtitle language from those included on the DVD video disc.

Notes

- When you select a subtitle language which is not included on the disc, the player plays a prior language programmed on the disc.
- Depending on scenes, the subtitles may not appear immediately after you change the subtitle language.
- Some discs may not include any subtitle languages.

■ To turn subtitles on or off

Press **SUBTITLE** several times during playback until "Off" is displayed.

Notes

- Some discs display subtitles automatically, and you cannot turn them off even if you set the subtitle function to off.
- Some discs will allow you to make subtitle selections and turn subtitles on or off only via the disc menu.

Selecting a playback sound

DVD-V VCD CD



1 Press AUDIO during playback.

The current audio setting is displayed.

e.g.



Sound recording system Audio language

2 Press AUDIO while the audio setting is displayed on the screen.

Each time you press the button, you can select a preferred sound from those included on the DVD video disc.

■ Selecting sound channels of VIDEO CDs

During playback, press **AUDIO** repeatedly to select the sound channel.

Notes

- Some discs allow you to change audio selections only via the disc menu. In such a case, press MENU and choose the appropriate language from the selections on the disc menu.
- If you select a sound track which is not included on the disc, the player plays a prior sound track programmed on the disc.

Playing audio/video/picture files

DVD-V VCD **CD**

You can play audio CDs, MP3 (audio), DivX[®] (video) or JPEG (picture) files on this player.

■ MP3 or DivX[®] media compatibility with this player

Playable media (MP3)	CD-ROM, CD-R, CD-RW, DVD-R, DVD-RW, SD Memory Card*, MultiMediaCard*, Memory Stick*, xD-Picture Card*
Playable media (Divx)	CD-ROM, CD-R, CD-RW, DVD-R, DVD-RW
Sampling Frequency	32 kHz, 44.1 kHz, 48 kHz
Bit rate	MP3: 32 kbps - 320 kbps (CBR) DivX: Less than 8 Mbps
CD physical format	Mode 1
File system	MP3: ISO9660, UDF without interleave DivX: ISO14496
File name	File names are limited to eight characters or less and must incorporate "MP3" or "DivX" extension. e.g. "*****.MP3" "*****.avi", "*****.Divx" File names cannot contain special characters such as "?!><+*}{[@];:¥ /.," etc.
Total number of files	Less than 650
DivX codec version	3, 4, 5, 6 (Plays all versions of DivX [®] video (including DivX [®] 6) with standard playback of DivX [®] media files)
DivX resolution	720 x 576 (Less or equal)

*: DivX[®] files can not be played.

This player requires discs/recordings to meet certain technical standards in order to achieve optimal playback quality. There are many different types of recordable disc formats (including CD-R containing MP3 files). Not all recordable discs will operate or produce optimal playback quality. The technical criteria set forth in this owner's manual are meant only as a guide. Use of CD-RW for MP3 files is not recommended. You must obtain any required permission from copyright owners to download or use copyrighted content. Toshiba cannot and does not grant such permission.

■ JPEG media compatibility with this player

Playable media	CD-ROM, CD-R, CD-RW, SD Memory Card, MultiMediaCard, Memory Stick, xD-picture Card
File system	ISO9660, UDF without interleave
File name	File names are limited to eight characters or less and must incorporate "JPG" extension. e.g. "*****.JPG" File names cannot contain special characters such as "?!><+*}{[@];:¥ /.," etc.
Total number of files	Less than 650
File size	Unrestricted
File format	BASELINE, PROGRESSIVE
Resolution	Baseline JPG: 5760 x 4320 Progressive JPG 5760 x 4320

DivX, DivX Certified, and associated logos are trademarks of DivX, Inc. and are used under license.

Note

- Some discs may not be played back due to its capacity and/or manufacturer, etc.

When using a memory card

- 1 Press **MODE** repeatedly until **"CARD"** appears.
- 2 Insert a memory card into the slot.

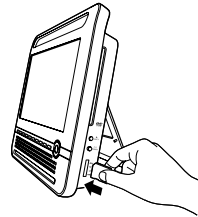

How to eject the memory card

Press on the centre of the memory card and then, pull the memory card straight and slowly out.

Note

- Do not eject the memory card while it is in use. If ejected while in use, information on the memory card may be lost.

1 Insert a media you want to play.

The menu appears.

e.g.

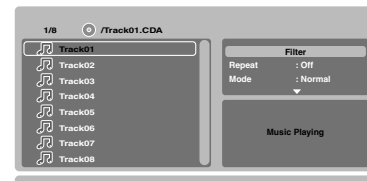

2 Select the track/file you want to play using ▲ / ▼ then press ENTER.

Playback starts.

A slide show begins when playing JPEG file.

3 Press STOP to stop playback.

■ To select the category of file

- 1 Select **"Filter"** on the settings screen using ▲ / ▼ / ◀ / ▶ then press **ENTER**.

The screen appears as below.

The check mark (✓) appears next to the category currently selected.

- e.g.
- | | | |
|---|---|------------------|
| <input checked="" type="checkbox"/> Audio | — | Select MP3 file |
| <input checked="" type="checkbox"/> Photo | — | Select JPEG file |
| <input checked="" type="checkbox"/> Video | — | Select DivX file |

- 2 Select the category using ▲ / ▼ then press **ENTER** to add/remove the check mark.

- 3 When complete, press ◀ to return to the previous screen.

The setting will be saved.

Note

- When using a commercially available audio CD, this function cannot be used.

Playing audio/video/picture files (Continued)

■ Playing repeatedly (Audio CD/MP3)

Select "Repeat" on the settings screen using ▲ / ▼ / ◀ / ▶ during playback then press **ENTER**.

Each time you press ENTER, the repeat mode changes.

→ Off:	Resume to normal playback.
↓	
Single:	Repeat current track.
↓	
All:	Repeats all tracks in order. (Audio CD)
Folder:	Repeats current folder. (MP3)

■ Playing in Random/Intro order (Audio CD/MP3)

Select "Mode" on the settings screen using ▲ / ▼ / ◀ / ▶ during playback then press **ENTER**.

Each time you press ENTER, the playback mode changes.

→ Normal:	Resume to normal playback.
↓	
Shuffle On:	Play in random order.
↓	
Music Intro:	Play only music intro in order.

Notes

- Some discs may not permit repeat, or random playback.
- Some functions such as REPEAT, RANDOM and SKIP (◀◀ / ▶▶) can be operated from the remote control directly.

Notes on audio file playback

- The BITSTREAM/PCM jack outputs MP3 or DivX® sounds in the linear PCM format regardless of the current "Digital Out" selection. (Refer to "Function Settings")

■ Rotating a picture (JPEG files)

Press ◀ / ▶ while a picture is played.

The picture will be rotated toward the designated direction.

Note

- Rotation does not start immediately after a direction button is pressed.

■ Playing in a favourite order (Audio CD/MP3)

You can combine your favourite tracks/files and play in the order you determine.

- 1 Select "Edit mode" on the settings screen using ▲ / ▼ / ◀ / ▶ then press **ENTER**.
- 2 Position the cursor using ◀ to the track/file list.
- 3 Select tracks/files you want to play using ▲ / ▼ then press **ENTER**.

The check mark (✓) appears next to the selected track/file.

- 4 Select "Add to Program" on the settings screen using ▲ / ▼ / ◀ / ▶ then press **ENTER**.

The check mark (✓) disappears and the player memorizes the selected tracks/files.

- 5 Select "Program view" on the settings screen using ▲ / ▼ / ◀ / ▶ then press **ENTER**.

Programmed selections appear.

- 6 Press **ENTER**.

Playback starts in the order you programmed.

■ To display recorded track/file (Audio CD/MP3)

Select "Browser view" on the settings screen then press **ENTER**.

The track/file list of the disc appears.

■ To cancel the programmed selections (Audio CD/MP3)

- 1 Press **STOP** twice to stop playback.

- 2 Position the cursor using ◀ to the programmed selections.

- 3 Select tracks/files you want to cancel then press **ENTER**.

The check mark (✓) appears next to the selected track/file.

- 4 Select "Clear program" using ▲ / ▼ / ◀ / ▶ then press **ENTER**.

Programmed selections are cleared.

Note

- Some media may not permit this function.

Adjusting the picture

DVD-V VCD CD

These adjustments are effective only on the LCD of this player. When using a connected monitor, make picture adjustment on the monitor.

1 Press PICTURE.

A picture adjustment menu appears.

e.g.



2 Set the details.

Refer to the table on the right.

3 When complete, press PICTURE to turn off the menu.

▲ / ▼ to select	Parameter	◀ / ▶ to change
BRIGHTNESS	0 – 100	Darker ↔ Lighter
CONTRAST	0 – 100	Lower ↔ Higher
COLOR	-50 – +50	Paler ↔ Deeper
TINT	-50 – +50	Reddish ↔ Greenish
SHARPNESS	-50 – +50	Softer ↔ Sharper
PICTURE SIZE	AUTO	Displays its originally formatted proportion.
	4:3	Displays in 4:3 picture size. 4:3 pictures keep their proportion, with black bars at the left and right. 16:9 pictures keep their proportion, with black bars at the top and bottom.
	16:9	Displays in full screen. 16:9 pictures keep their proportion. 4:3 pictures are expanded horizontally.
RESET	To reset all adjustment items to the factory settings, press ▶.	

Selecting the sound enhancement

DVD-V VCD CD

1 Press E.A.M.*

The current sound enhancement setting appears.

* E.A.M. = Enhanced Audio Mode

2 Press E.A.M. repeatedly.

- [3D Off]
Normal sound.
- [3D On]
To obtain expansive virtual surround sound effects from just two speakers.

Notes

- Actual effects to sounds may vary depending on the speaker system. Make the selection to your preference.
- Actual effects to sounds may vary depending on the disc.

On-screen Display mode

DVD-V VCD CD

1 Press DISPLAY during playback.

The current instructional information appears.

e.g.: DVD video disc

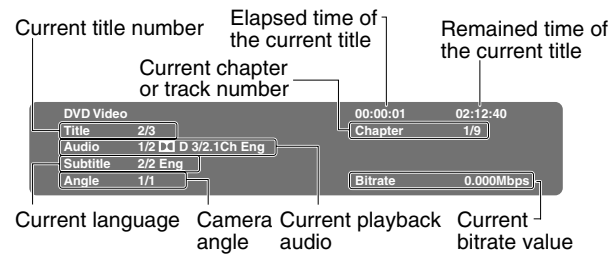

Press **DISPLAY** to turn off the display.



Function Settings

You can change the default settings to customize performance to your preference.

● Customizing the function settings

Customizing the function settings

DVD-V VCD CD

You can change the default settings to customize performance to your preference.

1 Press SET UP during stop.

The setting menu appears.

2 Press ▲ / ▼ to select the icon of the setting (listed below) to change, then press ►.

3 Press ▲ / ▼ to select the setting you want to change, then press ENTER.

4 Change the selection by ▲ / ▼ or other buttons, by referring to the corresponding page (72 -), then press ENTER.

To change other settings, press ◀, then repeat steps 2 to 4.





5 Press SET UP.

The setting menu disappears, and the procedure finishes.

Function Settings

Icon	Setting	Disc	Details
	OSD Menu	DVD-V VCD CD	To select a preferred language for on-screen displays.
	Subtitle	DVD-V VCD CD	To select a preferred language for subtitles.
	Audio	DVD-V VCD CD	To select a preferred language for the sound track.
	DVD menu	DVD-V VCD CD	To select a preferred language for disc menus.
	DivX subtitle	—	To select the font for subtitles of the DivX file.

70

Video 	Aspect Ratio	DVD-V VCD CD	To select a picture size according to the aspect ratio of your TV, when connected to this player to monitor playback picture.
	View Mode	DVD-V VCD CD	To select a playback picture size.
Audio 	E.A.M.	DVD-V VCD CD	You can easily switch to a preferred audio enhancement. (E.A.M. = Enhanced Audio Mode)
	D.R.C.	DVD-V VCD CD	To turn on or off a function that makes faint sounds easier to hear even if you lower the volume during late hours playback. (D.R.C. = Dynamic Range Control)
	Digital Out	DVD-V VCD CD	To select an output sound format corresponding to your system connection.
Rating 	Parental control	DVD-V VCD CD	To turn the parental lock function on or off.
	PBC	DVD-V VCD CD	To use the menu screen when playing a PBC-controllable VIDEO CD.
	Screen saver	DVD-V VCD CD	To turn the screen saver on or off.
Default 	Default	—	To restore all settings to the factory set.
	DivX® Registration	—	To display information about DivX.

Customizing the function settings (Continued)

■ Language

OSD Menu **DVD-V** **VCD** **CD**

- English:** To view on-screen displays in English.
Français: To view on-screen displays in French.
Español: To view on-screen displays in Spanish.
Deutsch: To view on-screen displays in German.
Nederlands: To view on-screen displays in Dutch.
Svenska: To view on-screen displays in Swedish.
Türkçe: To view on-screen displays in Turkish.

Subtitle **DVD-V** **VCD** **CD**

- English:** To display subtitles in English.
French: To display subtitles in French.
Spanish: To display subtitles in Spanish.
Off: To display no subtitles.

Notes

- Some DVD video discs may be set to display subtitles in a different language than you selected. A prior subtitle language may be programmed on the disc.
- Some DVD video discs allow you to change subtitle selections only via the disc menu. If this is the case, press the MENU button and choose the appropriate subtitle language from the selection on the disc menu.

Audio **DVD-V** **VCD** **CD**

- English:** To play sound tracks in English.
French: To play sound tracks in French.
Spanish: To play sound tracks in Spanish.

Note

- Some DVD video discs may be played in a different language than you selected. A prior language may be programmed on the disc.

DVD menu **DVD-V** **VCD** **CD**

- English:** To display disc menus in English.
French: To display disc menus in French.
Spanish: To display disc menus in Spanish.

Note

- Some DVD video discs may not include your preselected language. In this case, the player automatically displays disc menus consistent with the disc's initial language setting.

DivX subtitle

Western European: To display subtitles in west European language.

Central European: To display subtitles in Central European language.

Cyrillic: To display subtitles in Slavonic Cyrillic language.

Notes

- Some DVD video discs may be set to display subtitles in a different language than you selected. A prior subtitle language may be programmed on the disc.
- Some DVD video discs allow you to change subtitle selections only via the disc menu. If this is the case, press the MENU button and choose the appropriate subtitle language from the selection on the disc menu.

Video

Aspect Ratio **DVD-V** **VCD** **CD**

4:3 : Select when a standard 4:3 TV is connected.

16:9 : Select when a 16:9 wide TV is connected.

Notes

- The displayable picture size is preset on the DVD video disc. Therefore, the playback picture of some DVD video discs may not conform to the picture size you select.
- When you play DVD video discs recorded in the 4:3 picture size only, the playback picture always appears in the 4:3 picture size regardless of the TV shape setting.
- If you select "16:9" and you own a 4:3 TV set, the DVD playback picture will be horizontally distorted during playback. Images will appear to be vertically compressed. Always be sure that your TV shape conforms to the actual TV in use.

View Mode **DVD-V** **VCD** **CD**

Fill: Pictures are expanded horizontally and vertically to fit the shape of the screen. No picture cropping.

Original: Pictures are displayed in their original aspect ratios.

Auto Fit: Aspect ratios are automatically adjusted. Masking bars may appear on the top and bottom or left and right of picture.

Pan Scan: Pictures are cropped horizontally or vertically to fit the shape of the screen.

Note

- Actual views may depend on disc content or the TV. You may occasionally change the setting to your preference. **73**

Customizing the function settings (Continued)

■ Audio

E.A.M. DVD-V VCD CD

Normal:

Normal sound.

3D:

To obtain expansive virtual surround sound effects from just two speakers.

Note

- Pressing the E.A.M. button on the remote control also allows you to achieve the same setup.

D.R.C. DVD-V VCD CD

On :

Dynamic range is reduced.

Off :

Full dynamic range is maintained.

Notes

- This function works only during playback of Dolby Digital recorded discs.
- The level of Dynamic Range Control may differ depending on the DVD disc.

74

Digital Out DVD-V VCD CD

Bitstream:

Select when connected to an amplifier equipped with a Dolby Digital, DTS, MPEG1 or MPEG2 decoder.

The player outputs digital audio signal in the bitstream format when you play a DVD video disc recorded in the Dolby Digital, DTS, MPEG1 or MPEG2 recording system.

Analog 2ch:

Select when connected to a TV or stereo system via the analog audio jacks.

PCM:

Select when connected to a 2 channel digital stereo amplifier.

The player outputs sounds in the PCM 2ch format when you play a DVD video disc recorded on the Dolby Digital, MPEG1 or MPEG2 recording system.

■ Rating

Parental control **DVD-V** VCD CD

DVD video discs equipped with the parental lock function are rated according to their content. The contents allowed by a parental lock level and the way a DVD video disc can be controlled may vary from disc to disc. For example, if the disc allowed you could edit out violent scenes unsuitable for children and replace them with more suitable scenes, or lock out playback of the disc altogether.

DVD video discs may or may not respond to the parental lock settings. This is not a defect in the player. Make sure this function works with your DVD video discs.

■ To set the parental level

- 1 Press ▲ / ▼ / ◀ / ▶ to select "Parental control" and then press **ENTER**.
The password setting display appears.
- 2 Press the number buttons to create a personal 5-digit security code then press **ENTER**.
The password sets.

- 3 Press ▲ / ▼ to select "Parental control" and enter the password you set then press **ENTER**.
- 4 Press **ENTER** while selecting "Parental control".
- 5 Press ▲ / ▼ to select the parental level to set and then press **ENTER**.
8 : Adult 7 : NC-17 6 : R
5 : PG-R 4 : PG-13 3 : PG
2 : G 1 : Kid Safe

■ To change the parental lock level

- 1 Press ▲ / ▼ to select "Set Password".
- 2 Press the number buttons to enter the 5-digit security code then press **ENTER**.

Follow the step "To set the parental level" to change the parental level.

Customizing the function settings (Continued)

■ To change your 5-digit security code

- 1 After selecting "Set Password", press the **9** button five times then press **ENTER**.

The 5-digit security code is cleared.

- 2 After selecting "Set Password", press the number buttons to create a new 5-digit security code.

PBC DVD-V **VCD** CD

On :

To use the menu when playing a PBC-featured VIDEO CD.

Off :

When playing a VIDEO CD without using the menu.

Screen saver DVD-V VCD CD

On :

The screen saver operates.

Off :

The screen saver is disengaged.

■ Default

Default

No :

To leave the function settings as they have been customized.

Yes :

To restore the function settings to the factory default settings.

DivX[®] registration

The DivX information appears.

Return to "Default" if you press ENTER while it is displayed.

Connections

You can connect the player to a TV or audio system.

- **Viewing on a connected TV**
- **Connecting to a device equipped with HDMI input**
- **Viewing pictures from connected video equipment**
- **Connecting to audio equipment**

Viewing on a connected TV

You can connect a TV to this player to view playback picture on it.

1 Connect a TV to the AV OUT jack of this player.

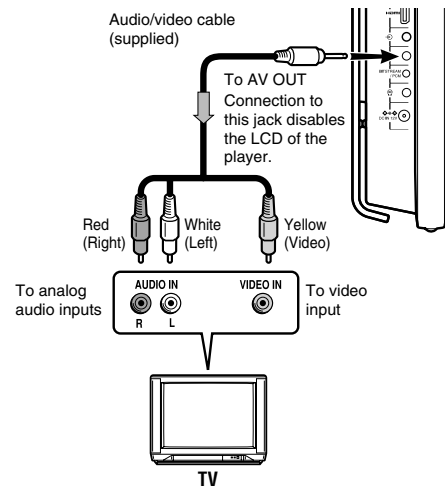

Make the following setting.	Setting	Select:	Page
	"Digital Out"	"Analog 2ch"	74

Notes

- Refer to the owner's manual of the connected TV as well.
- When you connect the player to your TV, be sure to turn off the power and unplug both units from the wall outlet before making any connections.
- Connect the player directly to your TV. If you connect the player to a VTR, TV/VTR combination or video selector, the playback picture may be distorted as DVD video discs are copy protected.

Connecting to a device equipped with HDMI input

This player is compatible with 480i/480p/720p/1080i signals.

1 Connect HDMI equipment to the HDMI terminal of this player.

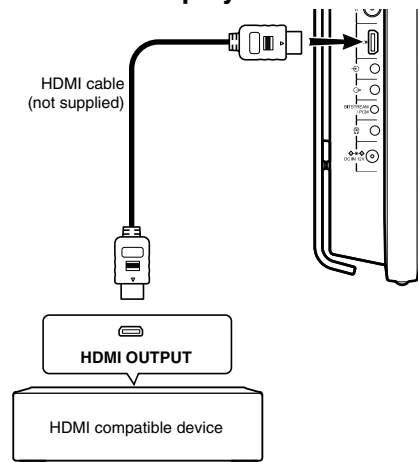

2 Press MODE repeatedly so that "HDMI" appears on the LCD.

The LCD is ready to display pictures from the equipment connected to the player.

Notes

- Refer to the owner's manual of the connected equipment as well.
- When you connect the player to other equipment, be sure to turn off the power and unplug all of the equipment from the wall outlet before making any connections.
- HDMI is an evolving technology, so it is possible that some devices may not operate properly with this player.
- If you place the player near a tuner or radio, the radio broadcast sound might be distorted. In this case, place the player away from the tuner and radio.
- The output sound of the player has a wide dynamic range. Be sure to adjust the receiver's volume to a moderate listening level. Otherwise, the speakers may be damaged by a sudden high volume sound.

HDMI, the HDMI logo and High-Definition Multimedia Interface are trademarks or registered trademarks of HDMI Licensing LLC.

Viewing pictures from connected video equipment

You can use the LCD of this player to monitor pictures of connected video equipment.

1 Connect video equipment to the AV IN jack of this player.

2 Press MODE repeatedly so that “AV-IN” appears on the LCD.

The LCD is ready to display pictures from the equipment connected to the player. (AV input mode)

Notes

- When supplying non-standard signals such as playback images from a video deck or images from a game player, some images may be displayed incorrectly. For example, shooting games, which shoots at a target on the screen with a light gun, may not work because of the LCD Colour monitor properties.
- In the external AV input mode (“AV-IN”), screen saver function/auto power OFF function becomes ineffective.

Connections

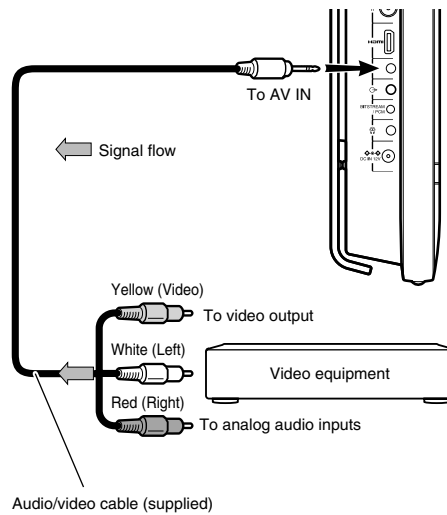

80

Connecting to audio equipment

You can enjoy high quality dynamic sounds by connecting the player to audio equipment.

The connecting method depends on the types of audio input, digital or audio.

Select the method according to the type of your equipment.

Caution

- When you connect the player to other equipment, be sure to turn off the power and unplug all of the equipment from the wall outlet before making any connections.
- Turn off the amplifier before you connect or disconnect the player's power cord. If you leave the amplifier power on, the speakers may be damaged.
- The output sound of the player has a wide dynamic range. Be sure to adjust the receiver's volume to a moderate listening level. Otherwise, the speakers may be damaged by a sudden high volume sound.

Notes

- Refer to the owner's manual of the connected equipment as well.
- If you place the player near a tuner or radio, the radio broadcast sound might be distorted. In this case, place the player away from the tuner and radio.

Connecting to an AV amplifier (via digital audio input)

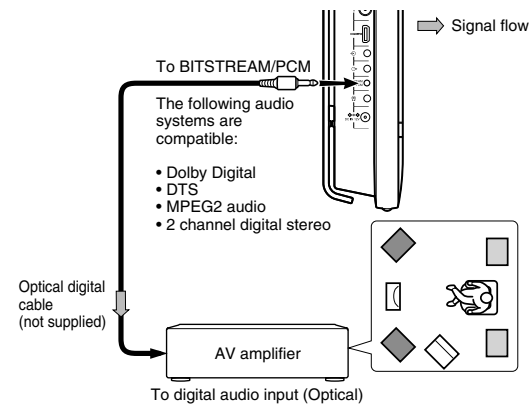

Make the following setting.	Setting	Select:	Page
	"Digital Out"	"Bitstream" or "PCM"	74

Manufactured under license from Dolby Laboratories. Dolby and the double-D symbol are trademarks of Dolby Laboratories. Confidential Unpublished Works. ©1992-1997 Dolby Laboratories, Inc. All rights reserved.

"DTS" and "DTS Digital Out" are registered trademarks of DTS, Inc.

81

Connecting to audio equipment (Continued)

CAUTION

- When you are connecting (via the BITSTREAM/PCM jack) an AV decoder that does not have Dolby Digital, Digital Theater Systems (DTS) or MPEG2 decoding function, be sure to set "Digital Out" to "PCM" from the on-screen displays **74** . Otherwise, high volume sound may damage your hearing as well as the speakers.
- When playing DTS-encoded discs (audio CDs), excessive noise may be output from the analog audio output jacks. To avoid possible damage to the audio system, you should take proper precautions when the analog audio output jacks of the player are connected to an amplification system. To enjoy DTS Digital Surround® playback, an external 5.1 channel DTS Digital Surround® decoder system must be connected to the BITSTREAM/PCM jack of the player.

Note

- DO NOT connect the BITSTREAM/PCM jack of the player to the AC-3 RF input of a Dolby Digital Receiver. This input on your A/V Receiver is reserved for Laserdisc use only and is incompatible with the BITSTREAM/PCM jack of the player.

Connecting to an audio system equipped with analog audio inputs

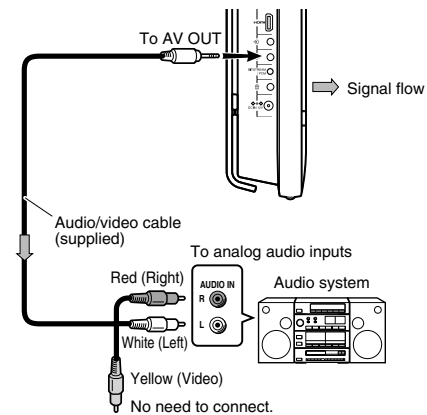

	Setting	Select:	Page
Make the following setting.	"Digital Out"	"Analog 2ch"	74

Others

Useful informations.

- **Output sound conversion table**
- **Before calling service personnel**
- **Specifications**

Output sound conversion table

Discs	Sound recording system		Audio selection and outputs					
			"Bitstream"		"Analog 2ch"		"PCM"	
			BITSTREAM/PCM jack	Speakers/AV OUT jack/ Headphone jack	BITSTREAM/PCM jack	Speakers/AV OUT jack/ Headphone jack	BITSTREAM/PCM jack	Speakers/AV OUT jack/ Headphone jack
DVD video discs	Dolby Digital		Bitstream	Yes	Bitstream	Yes	PCM	Yes
	Linear PCM	48 kHz	PCM	Yes	No	Yes	PCM	Yes
		96 kHz	PCM*	Yes	No	Yes	PCM*	Yes
	DTS		Bitstream	No	Bitstream	No	Bitstream	No
	MPEG1, MPEG2		Bitstream	Yes	Bitstream	Yes	PCM	Yes
VIDEO CDs	MPEG1		Bitstream	Yes	Bitstream	Yes	PCM	Yes
AUDIO CDs	Linear PCM 44.1 kHz		PCM	Yes	PCM	Yes	PCM	Yes
	DTS		Bitstream	No	Bitstream	No	Bitstream	No

*PCM: down sampling PCM

- Signals of 88.2 kHz or higher from the BITSTREAM/PCM jack are down converted to 44.1 kHz or 48 kHz when:
 - "3D On" is selected.
 - a copyright protected disc is played.
- Quantization will be limited to 16 bits in a copyright protected disc.

Others

Before calling service personnel

Check the following guide for the possible cause of a problem before contacting service.

Symptom	Cause	Correction
No power.	• The AC adapter or power plug is disconnected.	• Connect the AC adapter or power plug securely.
	• The battery pack has been removed.	• Install the battery pack.
	• Battery empty.	• Re-charge the battery.
The LCD turned off by itself.	• The automatic LCD off function turned the LCD off.	• Turn on the player again.
No TV channels.	• The aerial is not connected.	• Connect the aerial properly.
No TV channels after moving.	• Channel scan is not finished.	• Redo channel scan.
Picture noises and distortion.	• Interference by wave reflection or poor aerial connection.	• Change the position and direction of the aerial.
Dots on picture.	• Reception is disturbed by vibration.	• Move the aerial away from the cause of the interference.
Stripes on picture.	• Interference by other electric apparatuses.	• Move the aerial away from the cause of the interference.
No picture on the LCD monitor.	• The AV OUT jack is connected.	• When you use the LCD of the player, unplug the AV OUT jack.
No picture. (Other than built-in LCD monitor)	• The AV OUT jack is not connected to the TV monitor.	• Confirm the connection, and select the appropriate video input mode on the TV so the picture from the player appears on the TV screen.
No picture or Sound (When using the TV tuner.)	• The aerial connection is improperly positioned.	• Connect the aerial properly.
	• The channel scanning is not set to channels available in your area.	• Set by scanning.
No sound.	• The equipment connected via the audio/video cable is not set to receive DVD signal output.	• Select the correct input mode of the audio receiver so you can listen to the sound from the player.
	• The volume is too low.	• Adjust the volume by pressing the volume button.
	• The audio receiver or TV is turned off.	• Turn on the equipment connected with the audio/video cable.
	• The setting of output sound format is incorrect.	• Select the proper audio setting.

Others

Before calling service personnel (Continued)

Symptom	Cause	Correction
The playback picture has occasional distortion.	• The disc is dirty.	• Eject the disc and clean it.
	• Player is in fast forward or fast reverse mode.	• Sometimes a small amount of picture distortion may appear. This is not a malfunction.
	• The player was moved or given a shock.	• Vibrating or shaking the player during playback may produce distortion. This is not a malfunction. If not restored to usual status, stop playback and start again.
	• The disc is not set correctly.	• Eject the disc and load it again.
Brightness is unstable or noises are present in the playback pictures. (Other than built-in LCD monitor)	• The effect of copy protection. If you connect the player to a VTR, TV/VTR combination or video selector, the playback picture may be distorted as DVD video discs are copy protected.	• Connect the player directly to the TV. Avoid connecting the player to a VTR or TV/VTR combination.
The player does not start playback.	• No disc is inserted.	• Insert a disc.
	• An unplayable disc is inserted.	• Insert a playable disc. (Check the disc type, colour system and region number.)
	• The disc is loaded the wrong way round.	• Insert the disc with the playback side facing to the back of the unit. 48
	• The disc is dirty.	• Clean the disc.
	• The parental lock function is set.	• Cancel the parental lock function or change the parental lock level.
	• The player is set to the external input mode ("AV-IN").	• To play a disc with the player, "DVD/CD" needs to be set. Press MODE repeatedly so that you can view playback picture.
Playback does not follow the course of the disc's program.	• It is in the repeat playback mode, memory playback, etc.	• These operations may prevent a proper progression of the contents.
Buttons do not work.	• Power supply fluctuations or other abnormalities such as static electricity may interrupt correct operation.	• Turn the power on or off with the POWER switch. Or disconnect the power cord and insert it into the wall outlet again.

Others

Symptom	Cause	Correction
The remote control does not work properly.	• The remote control is not pointed at the remote sensor of the player.	• Point the remote control at the remote sensor of the player.
	• The remote control is too far from the player.	• Operate the remote control within about 3 m (9.9 feet).
	• The battery in the remote control is exhausted.	• Replace the battery with a new one.
	• The player's remote sensor is exposed to a strong light source such as direct sunlight or other illumination.	• Avoid the player from being exposed to a strong light source.

Others



87

Specifications

■ Player

Power supply DC 12 V 100 – 240 V AC, 50/60 Hz (with the supplied AC adapter)
Mass Approximately 3.4 kg (Including the battery pack)
External dimensions 342 × 324 × 62 mm (W/H/D) (Not including stand)
Signal system PAL/3.58NTSC
Laser Semiconductor laser, wavelength 650 nm / 795 nm
Frequency range DVD linear sound : 48 kHz sampling 4 Hz to 22 kHz 96 kHz sampling 4 Hz to 44 kHz
Operating conditions Temperature: 5°C to 35°C (41°F to 95°F)

■ Connectors

AV output (AV OUT) ø3.5mm mini jack × 1 Video: 1.0 V (p-p), 75Ω, negative sync., Audio: 2.0 V (rms), 100Ω
AV input (AV IN) ø3.5mm mini jack × 1 Video: 1.0 V (p-p), 75Ω, negative sync., Audio: 2.0 V (rms), 10kΩ
HDMI input HDMI™ connector
Audio output (BITSTREAM/PCM) Optical connector (ø3.5mm) × 1
Headphone terminal ø3.5mm stereo mini jack
Antenna input 75Ω IEC connector

Others

■ Liquid crystal display

Panel size	29.9 cm (11.8 inches diagonally measured)
Projection system	IPS (In-Plane-Switching)
Driving system	Amorphous silicon TFT active matrix
Resolution	786 (H) × 466 (V) pixels (effective pixel rate : more than 99.99%)

■ Supplied accessories

Audio/video cable	1
Remote control (MEDR120BX)	1
Coin-shaped battery (CR2025).....	1
AC adapter (EADP-60EB A).....	1
Power cord	1
Battery pack (SD-PBP120E)	1
Headphones	1
Outdoor aerial.....	1
Owner's Manual	1

- This model complies with the specifications.
- Designs and specifications are subject to change without notice.
- This model may not be compatible with features and/or specifications that may be added in the future.

Others





Memo





Memo





© 2008 Toshiba Corporation

TOSHIBA

Printed in China



SD-P120DTKE_ENG_69-92.indd 92



2008/01/17 19:15:12



Free Manuals Download Website

<http://myh66.com>

<http://usermanuals.us>

<http://www.somanuals.com>

<http://www.4manuals.cc>

<http://www.manual-lib.com>

<http://www.404manual.com>

<http://www.luxmanual.com>

<http://aubethermostatmanual.com>

Golf course search by state

<http://golfingnear.com>

Email search by domain

<http://emailbydomain.com>

Auto manuals search

<http://auto.somanuals.com>

TV manuals search

<http://tv.somanuals.com>