

# TOSHIBA

## DVD HOME CINEMA SYSTEM SD-43HK



Before connecting, operating or adjusting this product, please read this instruction booklet carefully and completely.

## OWNER'S MANUAL

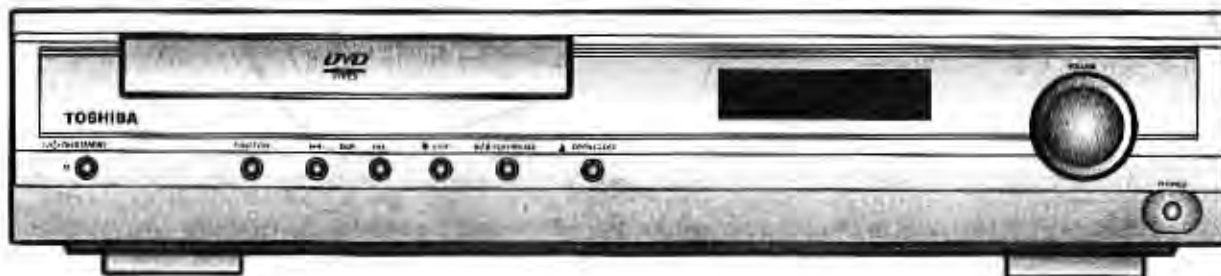



# Safety Precautions

**CLASS 1 LASER PRODUCT  
KLASSE 1 LASER PRODUKT  
LUOKAN 1 LASER LAITE  
KLASS 1 LASER APPARAT  
CLASSE 1 PRODUIT LASER**



**CAUTION**  
RISK OF ELECTRIC SHOCK  
DO NOT OPEN



**CAUTION:** TO REDUCE THE RISK OF ELECTRIC SHOCK DO NOT REMOVE COVER (OR BACK) NO USER-SERVICEABLE PARTS INSIDE REFER SERVICING TO QUALIFIED SERVICE PERSONNEL.



This lightning flash with arrowhead symbol within an equilateral triangle is intended to alert the user to the presence of uninsulated dangerous voltage within the product's enclosure that may be of sufficient magnitude to constitute a risk of electric shock to persons.



The exclamation point within an equilateral triangle is intended to alert the user to the presence of important operating and maintenance (servicing) instructions in the literature accompanying the appliance.

**WARNING:** TO REDUCE THE RISK OF FIRE OR ELECTRIC SHOCK, DO NOT EXPOSE THIS PRODUCT TO RAIN OR MOISTURE.

**CAUTION:** TO PREVENT ELECTRIC SHOCK, MATCH WIDE BLADE OF PLUG TO WIDE SLOT, FULLY INSERT.

**ATTENTION:** POUR ÉVITER LES CHOC ÉLECTRIQUES, INTRODUIRE LA LAME LA PLUS LARGE DE LA FICHE DANS LA BORNE CORRESPONDANTE DE LA PRISE ET POUSSER JUSQU'AU FOND.

**WARNING:** Do not install this equipment in a confined space such as a bookcase or similar unit.

## **CAUTION:**

This Digital Video Disc Player employs a Laser System.

To ensure proper use of this product, please read this owner's manual carefully and retain for future reference, should the unit require maintenance, contact an authorized service location see service procedure.

Use of controls, adjustments or the performance of procedures other than those specified herein may result in hazardous radiation exposure.



To prevent direct exposure to laser beam, do not try to open the enclosure. Visible laser radiation when open. DO NOT STARE INTO BEAM.

**CAUTION:** The apparatus shall not be exposed to water, dripping or splashing and that no objects filled with liquids, such as vases, shall be placed on the apparatus.



# Before Use

Disc Types	Marks	Recording Types	Disc Size	Max. Playing Time
DVD		Audio + Video	12 cm	Approx. 240 min. (Single-sided)
				Approx. 480 min. (Double-sided)
			8 cm	Approx. 80 min. (Single-sided)
				Approx. 160 min. (Double-sided)
VIDEO-CD		Audio + Video	12 cm	74 min.
			8 cm	20 min.
AUDIO-CD		Audio	12 cm	74 min.
			8 cm	20 min.

The region number of this DVD Home Theater is 4. If region numbers, which stand for their playable area, are printed on your DVD Video Disc and you do not find  or , disc playback will not be allowed by the DVD Home Theater.

## Notes on DVDs and Video CDs

Some playback operations of DVDs and Video CDs may be intentionally fixed by software manufacturers. As this unit plays DVDs and Video CDs according to disc content designed by the software manufacturer, some playback features of the unit may not be available, or other functions may be added. Refer also to the instructions supplied with the DVDs and Video CDs. Some DVDs made for business purposes may not be played on the unit.

- DVD players and the discs are coded by region. These regional codes must match in order for the disc to play. If the codes do not match, the disc will not play.

The Region Number for this player is given on the rear panel of the player.

(Your DVD player will only play DVDs that are labeled with identical region codes.)

- Because of problems and errors that can occur during the creation of DVD software and or the manufacture of DVD discs, Toshiba America Consumer Products, Inc., Toshiba Hawaii, Inc. and Toshiba of Canada Ltd. cannot guarantee that this player will play every feature of every DVD bearing the DVD logo. As one of the creators of DVD technology, Toshiba DVD players are manufactured to the highest standards of quality and, as a result, such incompatibilities are very rare. If you happen to experience and difficulty playing a DVD on a Toshiba DVD player, please feel free to call our Contact listed in "How to Obtain Warranty Services" page 47.

## Note on DTS-encoded CDs

When playing DTS-encoded CDs, excessive noise may be exhibited from the analog stereo output.

To avoid possible damage to the audio system, turn down the volume before playing back such discs, adjust the volume gradually, and keep the volume level low. To enjoy DTS Digital Surround TM playback, an external 5.1 channel DTS Digital Surround TM decoder system must be connected to the digital output of the unit.

## Notes

- Depending on the conditions of the recording equipment or the CD-R/RW disc itself, some CD-R/RW discs cannot be played on the unit.
- The unit cannot play the CD-R/RW discs that contain no data, or contain different kinds of formatted data other than MP3 and CD-DA data.
- Do not attach any seal or label to either side (the labeled side or the recorded side) of a disc.
- Do not use irregular shaped CDs (e.g., heart-shaped or octagonal). It may result in malfunctions.
- Playback of some DVD-R/RW discs may not be possible depending on the conditions of the recording or the severity of scratches on the disc surface.



# Contents

## ○ PREPARATION

Safety Precautions .....	1
Before Use .....	2
Contents .....	3
Description .....	4
Remote Control .....	6

## ○ CONNECTIONS

Before Using the DVD Player .....	7
Connecting the Speakers .....	8
Connecting to a TV .....	9
Connecting the FM and AM(MW) Antennas.....	10
Connecting the Optical Equipment.....	11
P.SCAN(Progressive Scan) Function.....	12

## ○ OPERATION

DVD Playback .....	13
MP3/WMA CD Playback.....	15
Forward/Reverse Searching.....	17
Slow Playback/Checking the Remaining Time.....	18
Repeat Playback .....	19
Disc Menu/Top Menu Function.....	20
Selecting the Audio Language/Subtitle Language .....	21
Zoom/Angle Functions.....	22
JPEG File Playback.....	23
Program Playback .....	25

## ○ SETUP

Setup Functions.....	27
General Setup .....	28
Speaker Setup.....	31
To set up Speaker Balance .....	33
Creating Realistic Sound Fields .....	34
Dolby Pro Logic II decoder .....	35

## ○ RADIO OPERATION

Listening to the Radio.....	37
Presetting the radio stations.....	38

## ○ MISCELLANEOUS

Sleep Function.....	39
Using Headphone Jack .....	39
Mute Function.....	39
Cautions on Handling and Storing Discs .....	40
Troubleshooting .....	41
Language Code List .....	42
Specifications .....	43
Memo.....	44

# Description

## Front Panel

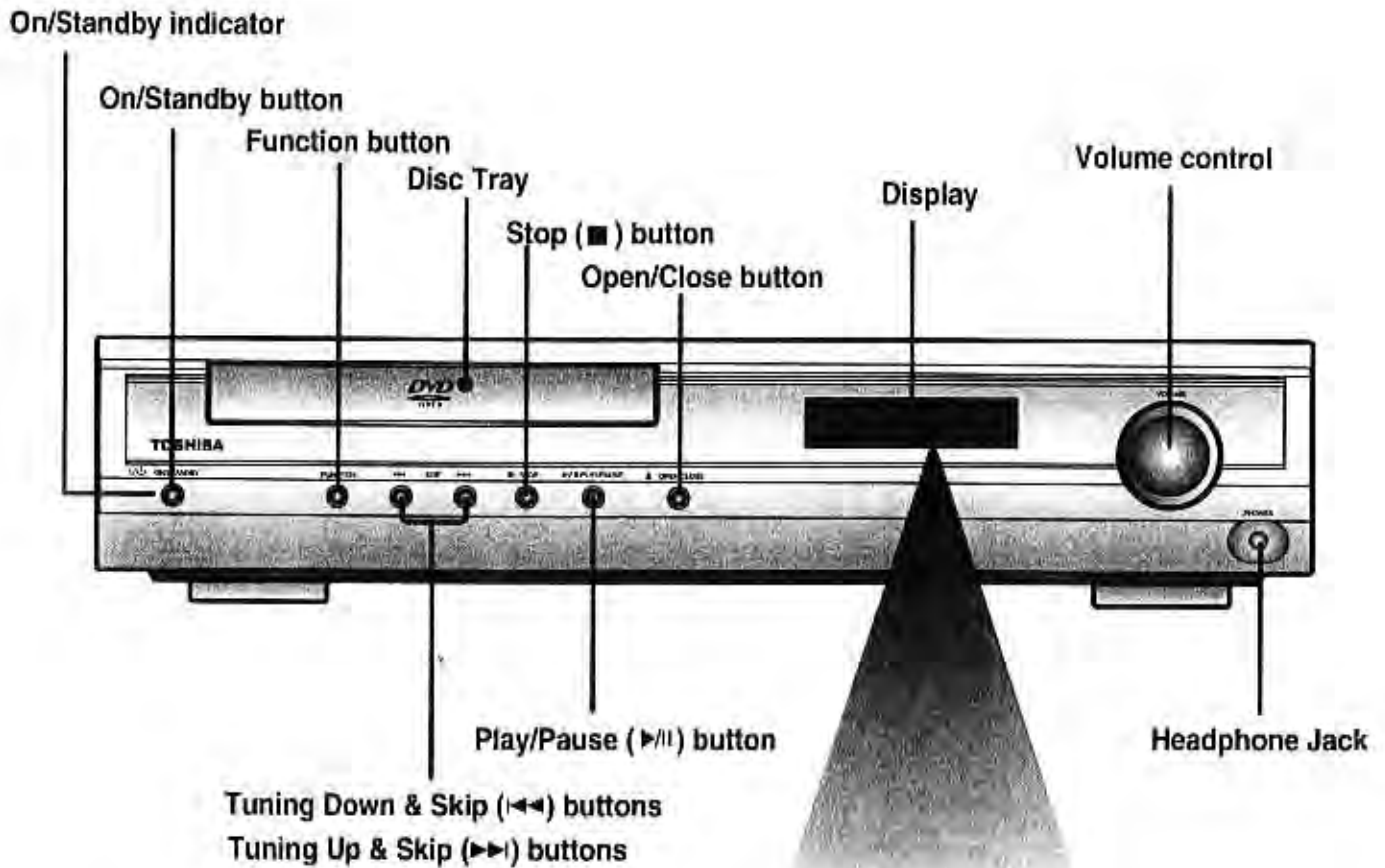

## Display

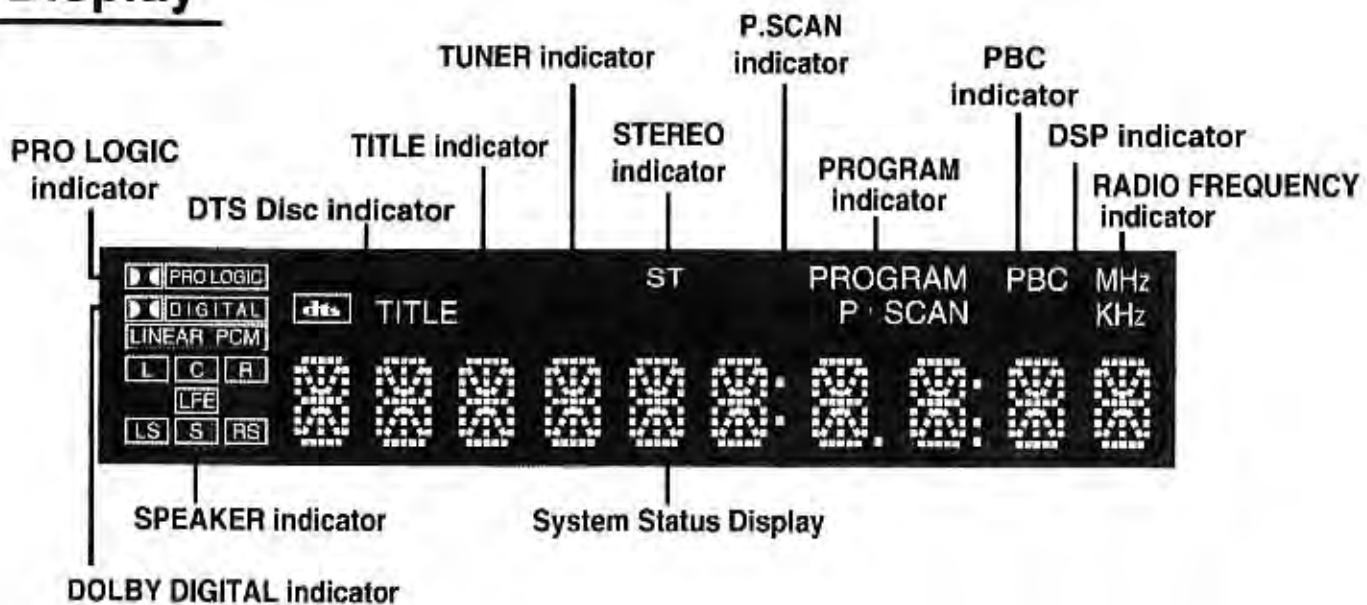



# Rear Panel

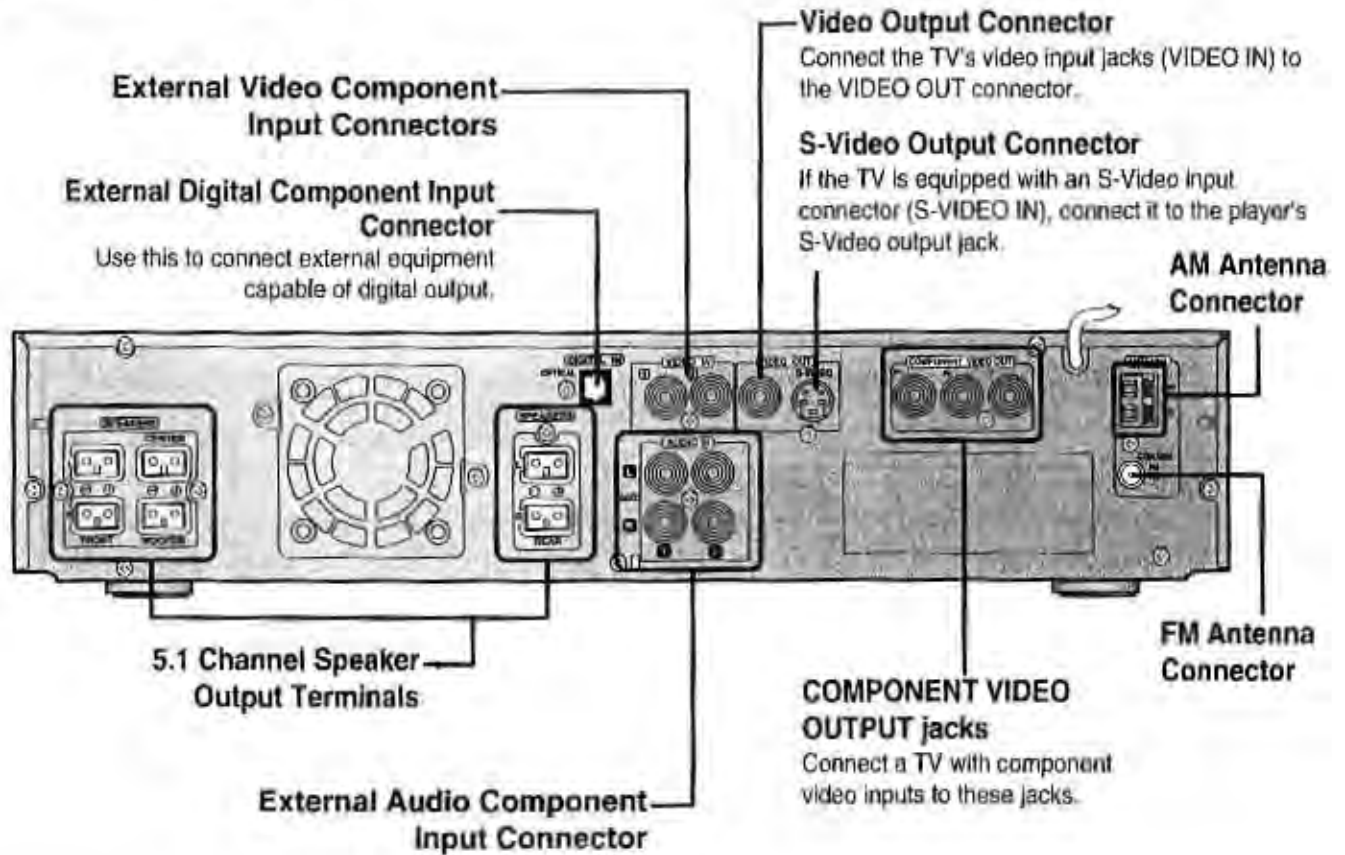

**Dust protection cap**  
Remove the dust protection cap from the OPTICAL DIGITAL IN jack and connect the optical digital cable (not supplied) securely so that the configurations of both the cable and the connector match. Keep the dust protection cap and always reattach the cap when not using the connector to protect against dust intrusion.



# Accessories

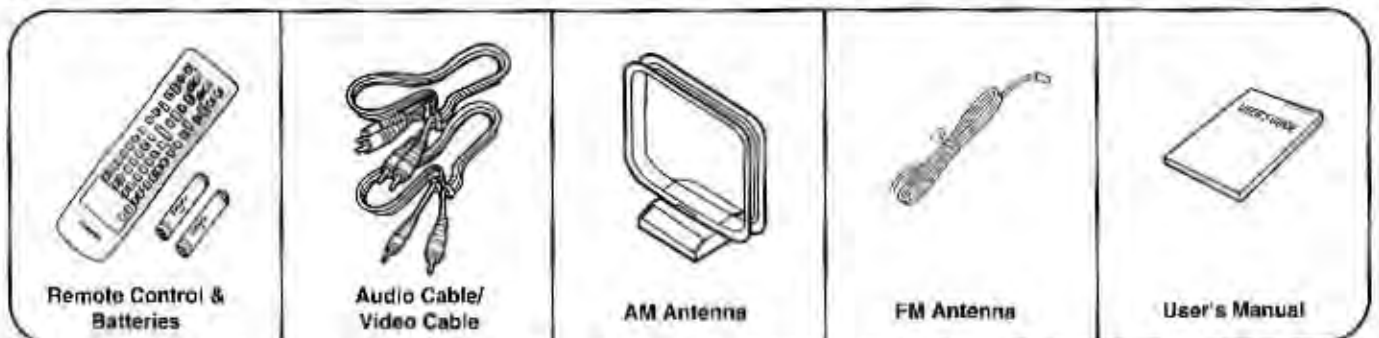



# Remote Control

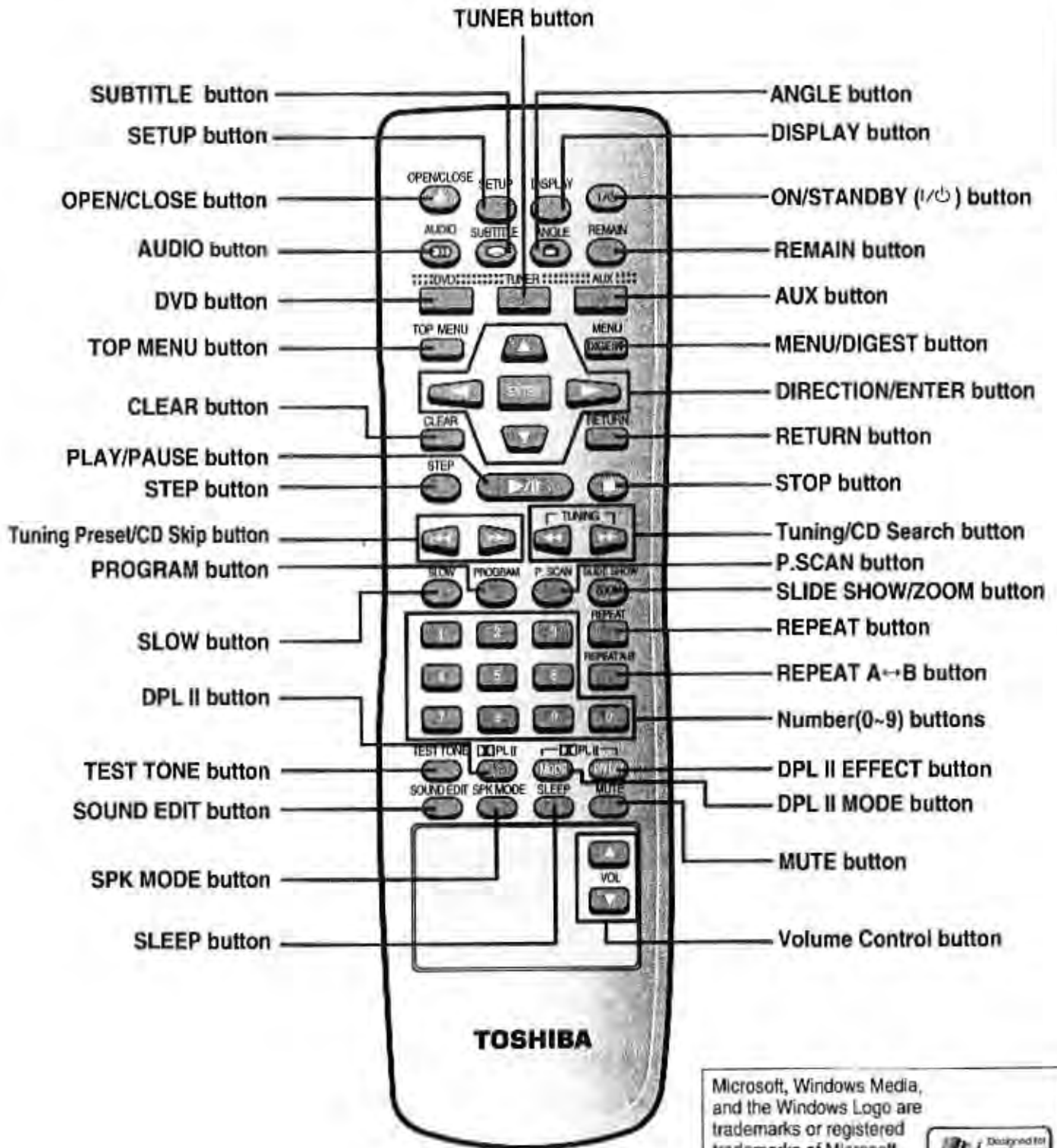

**TOSHIBA**

Microsoft, Windows Media, and the Windows Logo are trademarks or registered trademarks of Microsoft Corporation in both the United States and other countries.



## Insert Remote Batteries



**1** Open the battery cover on the back of the remote control.



**2** Insert two 1.5V AA batteries, paying attention to the correct polarities (+ and -).



**3** Replace the battery cover.

### Caution

Follow these precautions to avoid leaking or cracking cells:

- Place batteries in the remote control so they match the polarity: (+) to (+) and (-) to (-).
- Use the correct type of batteries. Batteries that look similar may differ in voltage.
- Always replace both batteries at the same time.
- Do not expose batteries to heat or flame.

## Range of Operation of the Remote Control

The remote control can be used up to approximately 23 feet/7 meters in a straight line. It can also be operated at a horizontal angle of up to 30° from the remote control sensor.

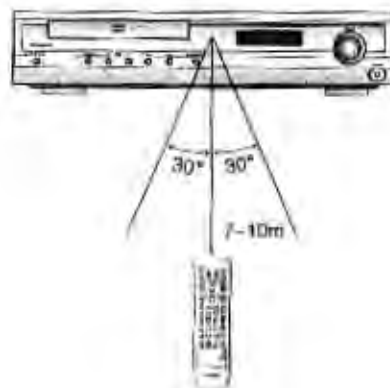

## Before Using the DVD Player

Your DVD player is capable of playing DVD, VCD, and CD discs.

User instructions may vary depending on the type of disc. Read the instructions carefully before use.

### TV Broadcast System

- This device is designed to work with the NTSC video format.
- To change the TV broadcast system to be output, press the ZOOM button while the power is turned off. The selection will switch between NTSC and PAL each time you press the button.
- For normal playback, the video format a DVD disc is recorded in must coincide with your TV's video format.

### About the symbol display

- “” may appear on the TV screen during operation. This icon means the function explained in this owner's manual is not available on that specific DVD video disc.

### Note

- When the power is not turned on, press down the STOP (■) button on the main unit for over 5 seconds. The product will be initialized to its optimum state.
- Some operational features such as the Speaker mode, Test tone, Volume, etc. will not be displayed on the TV screen.





# Connecting the Speakers

Turn off the Power first and set the volume knob to low initially before connecting.

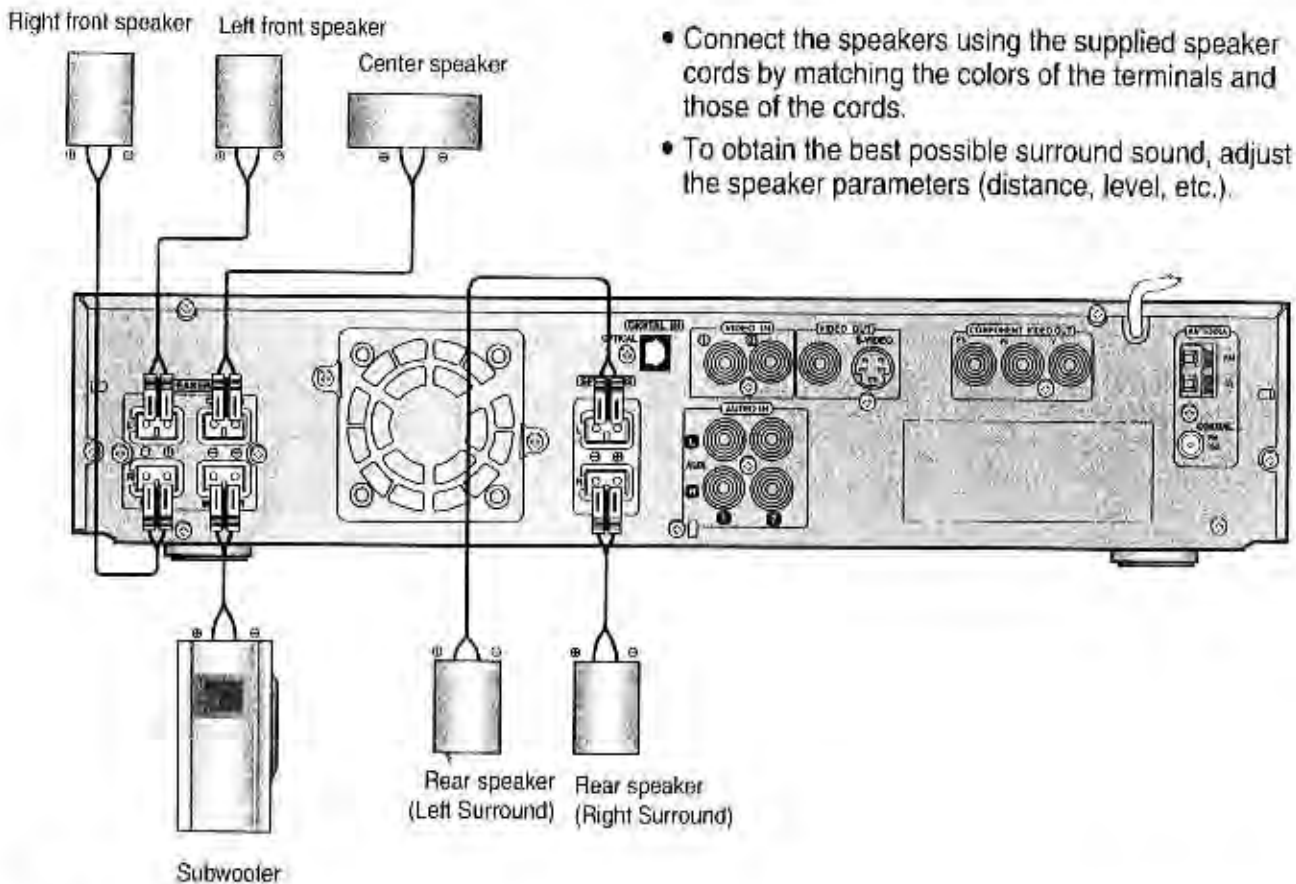

- Connect the speakers using the supplied speaker cords by matching the colors of the terminals and those of the cords.
- To obtain the best possible surround sound, adjust the speaker parameters (distance, level, etc.).

## Note

- Be sure to match the speaker cord to the appropriate terminal on the components: + to + and - to -. If the cords are reversed, the sound will be distorted and will lack bass.
- If you use front speakers with low maximum input rating, adjust the volume carefully to avoid excessive output on the speakers.
- Do not disassemble the front cover of supplied speaker.

## Ideal Speaker Placement

### Front Speakers

Set the front speakers so that their tweeters (high-range) are aligned at about ear level and at a horizontal angle of 45° to the prime listening position.

### Center Speaker

Ideally the center speaker should be positioned with its top surface flush with the front speakers. However, you may place the speaker either on top or near the bottom of your TV set.

### Rear Speakers

Set the rear speakers further back, parallel to the walls, at 60 to 90 centimeters (2 to 3 feet) above prime listening position ear level.

If the space behind the listening position is insufficient (i.e., too close to the wall), place the rear speakers facing each other on either side.

### Subwoofer Speaker

Place the subwoofer at any convenient location within the vicinity of the listening position.



# Connecting to a TV

Please turn off the Power of your TV, DVD receiver and other equipment before doing any connections. Set the volume to low initially.

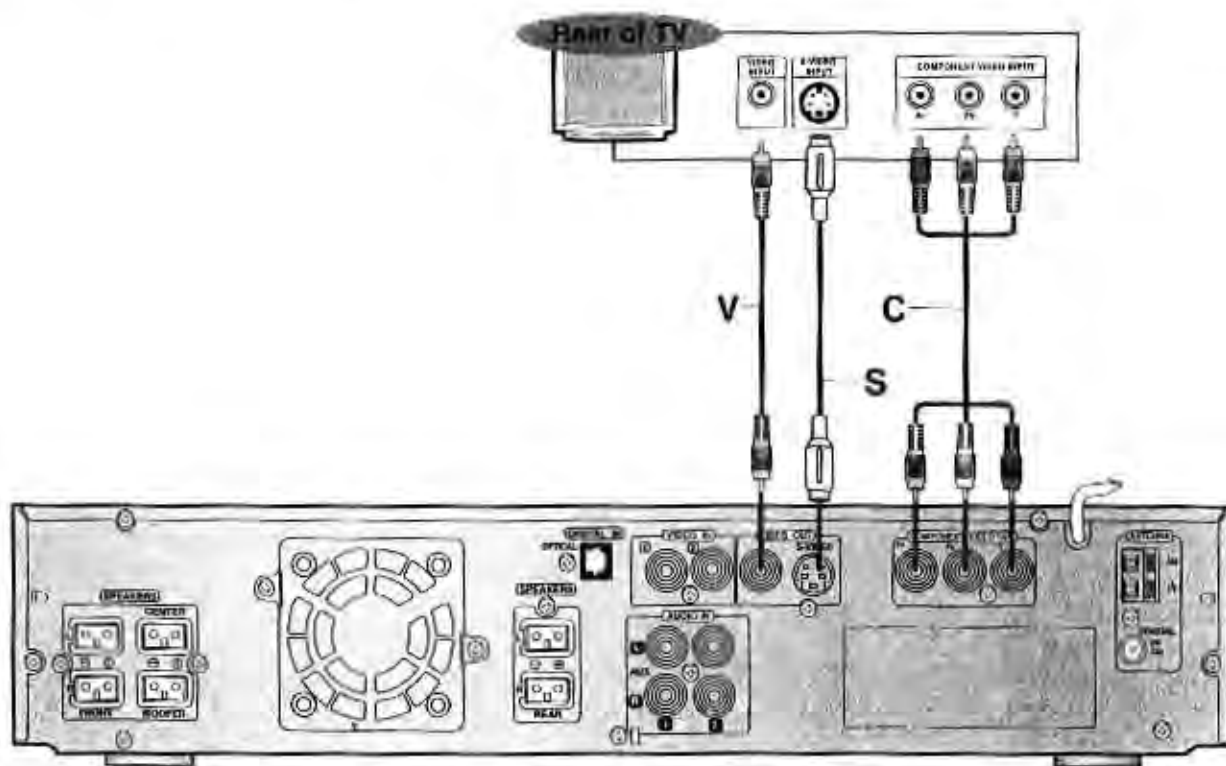

Depending on your TV and other equipment you wish to connect, there are various ways you could connect the player. Use one of the connections described below.

## Video connection (Good)

- Connect the VIDEO OUT jack on the DVD Receiver to the video in jack on the TV using the video cable supplied (V).

## S-Video connection (Better)

- Connect the S-VIDEO OUT jack on the DVD Receiver to the S-Video in jack on the TV using the optional S-Video cable (S).

## Component Video (Color Stream®) connection (Best)

- Connect the COMPONENT VIDEO OUT jacks on the DVD Receiver to the corresponding in jacks on the TV using an optional Y Pb Pr cable (C).

### Note

- When the Progressive scan mode is selected, the VIDEO and S-VIDEO outputs do not feed any signals. See page 16 to select Progressive Scan.
- The signal of S-VIDEO OUT jack will output only when the function mode is selected to CD/DVD.





# Connecting the Optical Equipment

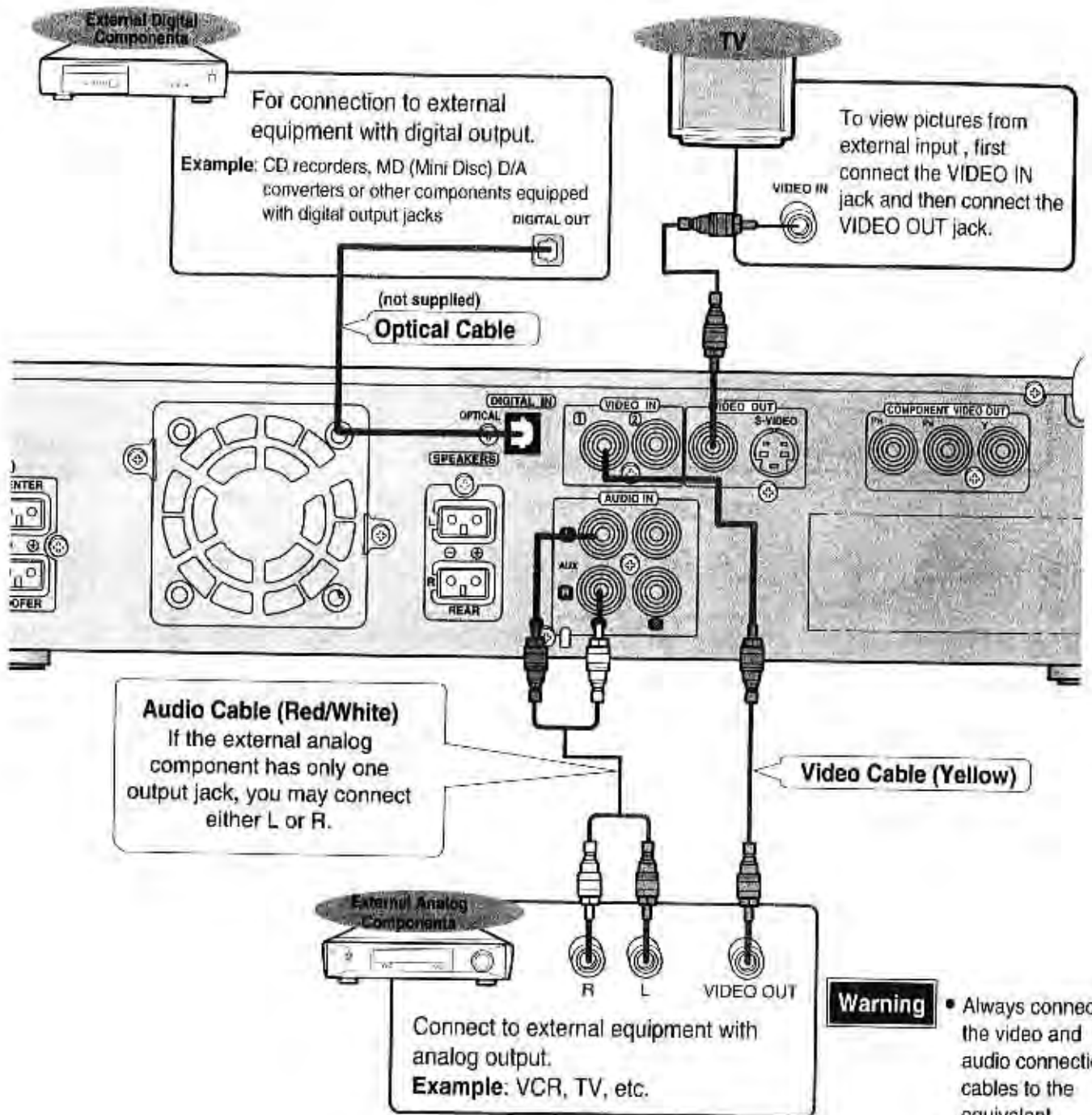

## To Play External Digital/Analog Equipment

Press **AUX** on the remote control to select DIGITAL IN, AUX1, or AUX2.

Press **Function** on the main unit to select DIGITAL IN, AUX1, or AUX2.

- Each time the button is pressed the mode switches as follows: FM → AM → DVD/CD → DIGITAL IN → AUX 1 → AUX 2.











# DVD Playback

**1**  
Press the **OPEN/CLOSE** (▲) button to open the disc tray. 

**2**  
Insert a disc.  

- Place a disc gently into the tray with the disc's label facing up.



**3**  
Press the **OPEN/CLOSE** (▲) button again to close the disc tray. 

- Playback starts automatically.

## Pausing Playback



Press the **PLAY/PAUSE** (▶/||) button during playback.

- To resume, press the **PLAY/PAUSE** (▶/||) button again.

### Note

- Depending on the disc, the initial disc information screen may look different from disc to disc.

## Stopping Playback



Press the **STOP** (■) button during playback.

- During playback, when the **STOP** (■) button is pressed, the position is stored in the memory, **PRESS PLAY** is shown on the display. When the **PLAY/PAUSE** (▶/||) button is pressed subsequently, playback resumes from the position at which it was stopped.
- If the **STOP** (■) button is pressed a second time, the resume play memory function is canceled, and **STOP** is shown on the display. When the **PLAY/PAUSE** (▶/||) button is pressed, playback starts from the beginning.

## Using the On-Screen Display

The general playback status can be displayed on the TV screen. Some items can be changed on the menu.

1

Press the **DISPLAY** button during playback.

2

Press the **LEFT/RIGHT** (◀ / ▶) to select an item.

3

Press the **UP/DOWN** (▲ / ▼) to change the setting of an item.

- The selected item will be highlighted.

- The number buttons can be also used for setting numbers (e.g., title number). For some functions, press **ENTER** to execute the setting.



Items	Function (Press ▲ / ▼ to select desired item)	Selection Method
Title Number	Displays the current title number and total number of available titles, and skips to a desired title number.	◀ / ▶, or Numbers, ENTER
Chapter Number	Displays the current chapter number and total number of available chapters, and skips to a desired chapter number.	◀ / ▶, or Numbers, ENTER
Time search	Displays the elapsed playing time, and searches a point identified by its elapsed time.	Numbers, ENTER
Audio language and Digital Audio Output mode	Displays the current audio soundtrack language, encoding method and channel number, and any changes you make to the setting.	▲ / ▼
Subtitle language	Displays the current subtitles language, and any changes you make to the setting.	▲ / ▼
Angle	Displays the current angle number and total number of angles, and any changes you make to the angle number.	▲ / ▼
Repeat	Displays the repeat mode, -, title, chapter, A-B or OFF.	▲ / ▼



Items	Function (Press ▲ / ▼ to select desired item)	Selection Method
Track Number	Displays the current track number, total number of tracks and PBC On mode, and skips to the desired track number.	▲ / ▼, or Numbers, ENTER
Time	Displays the elapsed playing time (Display only)	-
Audio Channel	Displays the audio channel, and changes you make to the audio channel.	▲ / ▼
Repeat	Displays the repeat mode, -, title, chapter, A-B or OFF.	▲ / ▼



# MP3/WMA CD Playback

You can play MP3/WMA files that have been recorded on a CD-R or CD-ROM on the DVD video player.

**What is MP3?** MP3 is an abbreviation of Motion Picture Experts Group (or MPEG) Audio Layer 3. MP3 is simply a file format with a data compression ratio of 1:10 (128 Kbps\*). That means, by using MP3 format, one CD-R or CD-RW can contain 10 times as much data volume as a regular CD.

**What is WMA?** WMA (Windows Media Audio) is a file format, created by Microsoft, that offers a higher compression rate and just as good sound quality as MP3. Typical MP3 files are about one-tenth the size of the original, whereas WMA files are about half the size of standard MP3.

## Starting Playback

- It is recommended you turn on your TV when playing back an MP3/WMA CD.

# 1

Press the **OPEN/CLOSE** (▲) button to load a disc.

# 2

Press the **PLAY/PAUSE** (▶||) button.

- After detecting the disc, playback starts.
- The on-screen bar and the contents recorded on the MP3/WMA CD will be shown on the TV if it is turned on.

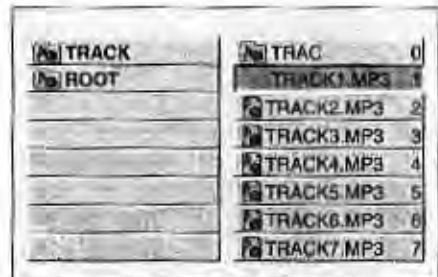

- Disc Type
- Current track (file) and total number of the tracks on the disc
- Elapsed playing time and the total playing time of the current track
- Repeat mode indicator

## To stop during playback

- Press the **STOP** (■) button.

## Using the On-Screen Display

Turn on your TV when playing back an MP3/WMA disc. When the loaded the MP3/WMA disc is recognized, the following on-screen display appears on the TV screen. (The contents of this on-screen display vary according to the disc — the way the MP3 tracks were recorded on the disc.)

In stop mode, then select as follows :

Button	To do
ENTER, ▶	Start playback or go into a directory.
▲/▼	To select a track or directory in STOP mode

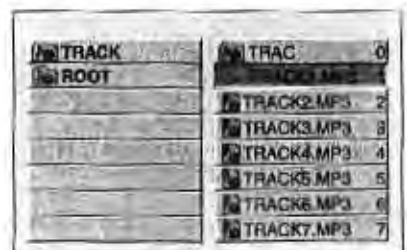

### Note

- Depending on the recording mode, some MP3/WMA CDs cannot be played.





# Forward/Reverse Searching

During playback, you can search quickly through a chapter or track for a specific scene or tune.

## Multi-Speed Playback

Press the ◀◀ and ▶▶ button.

Each time the ◀◀ button is pressed

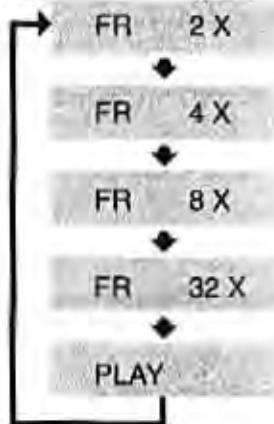

Each time the ▶▶ button is pressed

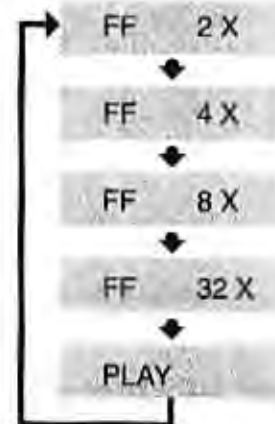

## Skipping through a Chapter

Press the ◀◀ and ▶▶ button.

- Each time the button is pressed during playback, it moves to the next or previous chapter and plays it.

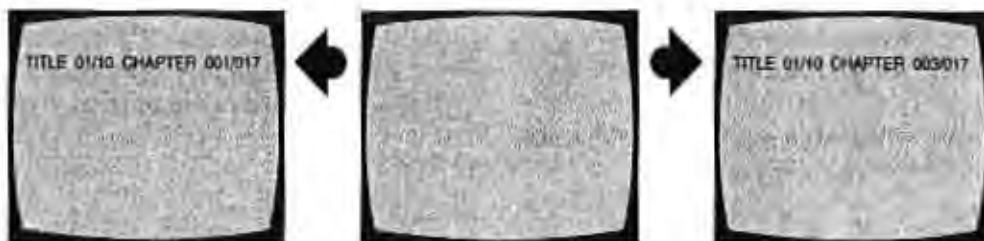

## Playing Frame by Frame

Press the **STEP** button.

- The picture moves forward one frame each time the button is pressed.

**Note**

- No sound is heard during high-speed playback, slow playback, and step motion.





# Slow Playback/Checking the Remaining Time

## Playing Slowly

Press the SLOW button.

Each time the SLOW button is pressed

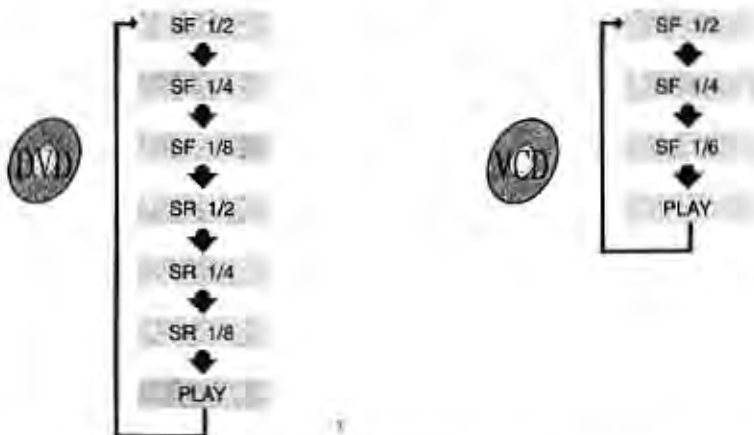

### Note

- Slow motion playback in reverse is not applicable for Video CD.

## Checking the Remaining Time

Press the REMAIN button.

- For checking the total and remaining time of a title or chapter being played.

Each time the REMAIN button is pressed

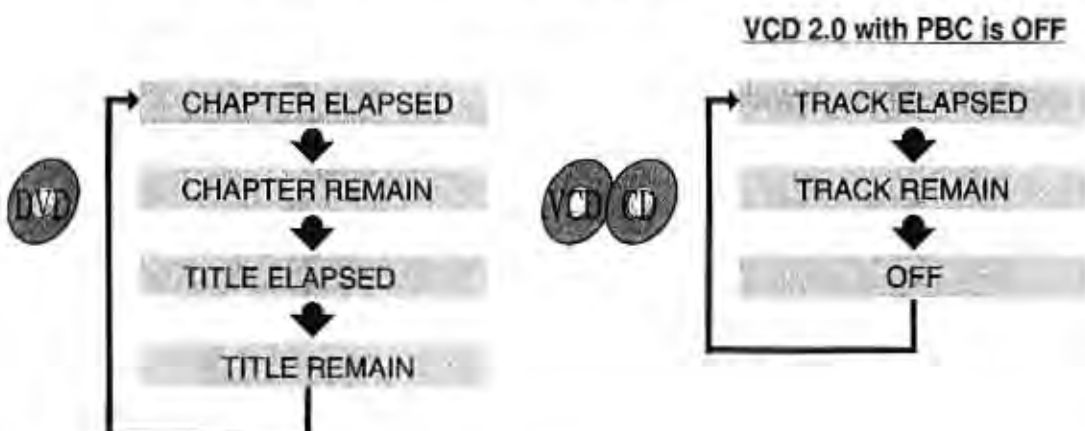



# Repeat Playback

Repeat playback allows you to repeat a chapter, title, or track.

## Playing Repeatedly

Press the REPEAT button.

Each time the REPEAT button is pressed

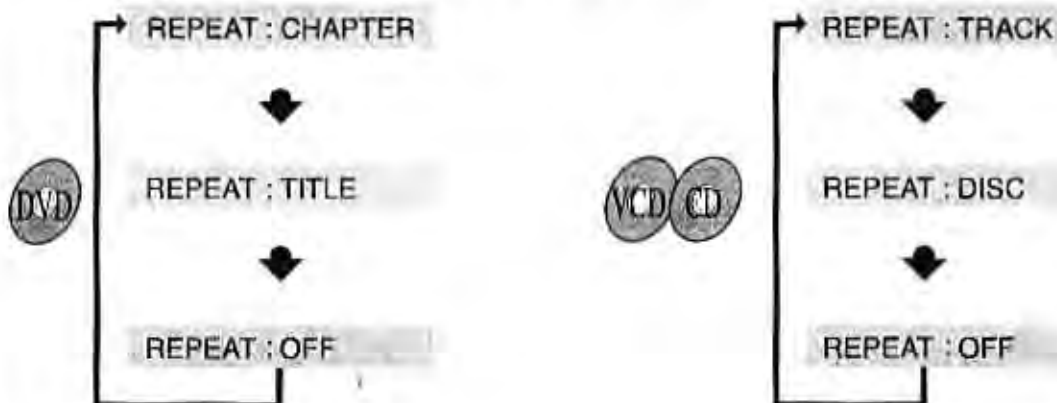

### Note

- Repeat playback operation is not possible with version 2.0 VCD discs if PBC is turned on. To operate this feature, press the MENU button, and then select "PBC OFF".

## A↔B Repeat Playback

- Press the **REPEAT A↔B** button at the beginning (A) of the segment you want to review.
- Press the **REPEAT A↔B** button again at the end (B) of the segment you want to review.
  - The segment will begin repeating.

### To return to normal playback

Press the **REPEAT A↔B** button again.

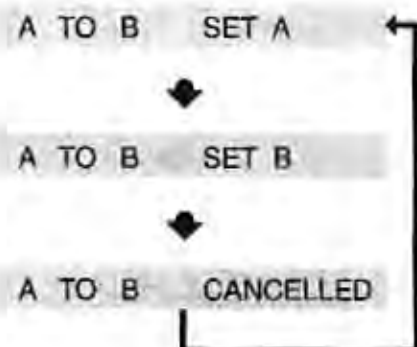

# Disc Menu/Top Menu Function

## Using the Disc Menu

You can use the menus for the audio language, subtitle language, profile, etc. DVD menu contents differ from disc to disc.

**1**

Press the **MENU(DIGEST)** button during playback.

- The Menu Screen appears.
- When playing VCD version 2.0, you can operate it using PBC On/Off function.

**2**

Use the **UP/DOWN** (▲ / ▼) or **LEFT/RIGHT** (◀ / ▶) button to access the different features.

**3**

Press the **ENTER** button.

- The selected item will play.



## PBC (Playback Control) Function

When playing a VCD (version 2.0) with PBC function, you can view special scenes or menus.

Set PBC (Playback Control) to On or Off

**On:** Video CDs with PBC are played back according to the PBC.

**Off:** Video CDs with PBC are played back in the same way Audio CDs.

## Using the Top Menu

Press the **TOP MENU** button.

- If the current title has a menu, the menu will appear on the screen. Otherwise, the disc menu may appear.
- The menu can list camera angles, spoken languages, subtitle options, and chapters for the title.

### To remove the top menu

Press the **TOP MENU** again.





# Selecting the Audio Language/Subtitle Language

## Selecting the Audio Language

Press the **AUDIO** button.

- Depending on the number of languages recorded on a DVD disc, a different audio language (ENGLISH, SPANISH, FRENCH, etc.) is selected each time the button is pressed.

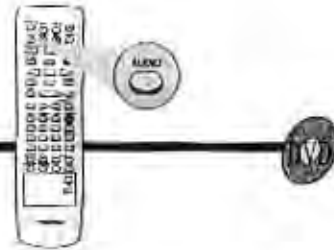

**Note**

- Depending on the disc, DTS or DOLBY PRO LOGIC can be selected.

## Selecting the Subtitle Language

Press the **SUBTITLE** button.

- Depending on the number of languages recorded on a DVD disc, a different subtitle language (ENGLISH, SPANISH, FRENCH etc.) is selected each time the button is pressed.
- To make the subtitles disappear, select "OFF".

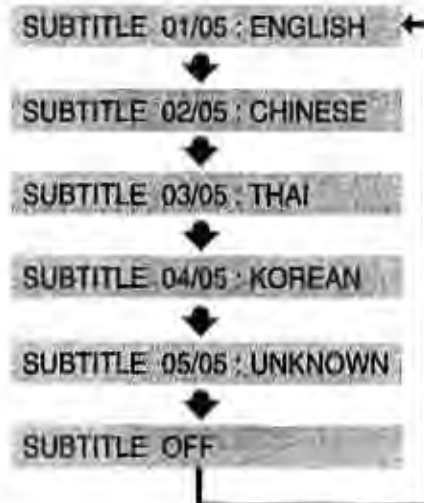

**Note**

- If this symbol "⏸" appears on the TV screen while buttons are being operated, that operation is not possible with that particular disc.
- Depending on the disc, the audio or subtitle language function may not work.



# Zoom/Angle Functions

## To enlarge an image

- This feature allows you to enlarge a particular area of the displayed image.
- During DVD playback, if you press the **ZOOM(SILD SHOW)** button followed by the **ENTER** button, the selection switches back and forth as follows.

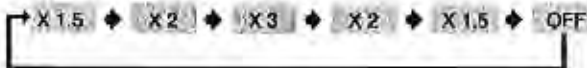

- To move to the area you want to zoom in on, press the **◀ / ▶ / ▲ / ▼** button.



### Note

- Only 2X zoom operation is possible during VCD playback.

## Selecting the desired Screen Angle

- This feature allows you to view the same scene in different angles.

### Press the ANGLE button.

- This function only works with discs on which multiple angles have been recorded.
- During playback, press the **ANGLE** button to select the desired angle: 3/3, 1/3, 2/3, 3/3 normal, in that order.

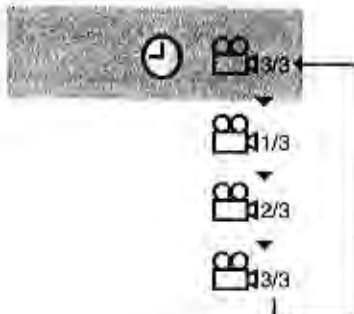





# JPEG File Playback

Images captured with a digital camera or camcorder, or JPEG files on a PC can be stored on a CD and then played back with this DVD player.

## Slide Show Function

1

Place the JPEG disc on the disc tray.

- Playback starts automatically.
- Each image is shown for 5 seconds before another image is displayed.

2

Press **SLIDE SHOW(ZOOM)** button.

- Each time the button is pressed, the image makes the transition as follows:

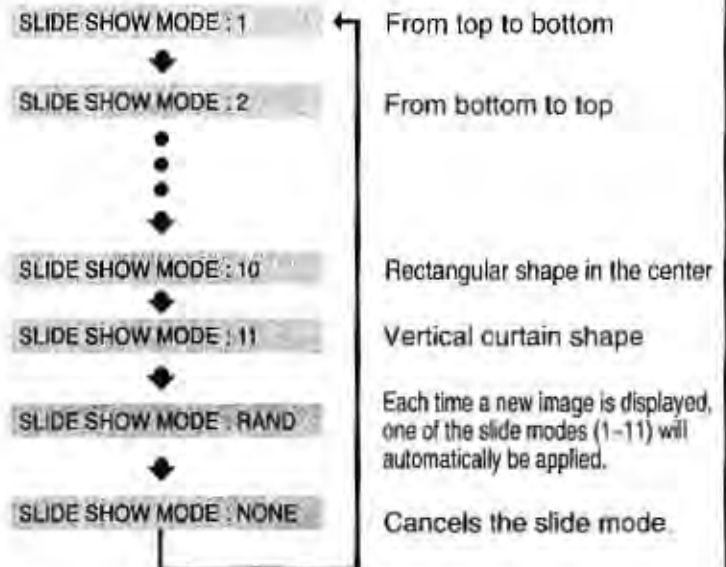

Press **⏪, ⏩** to skip to the next slide.

- Each time the button is pressed, the slide moves backward or forward.

### CD-R JPEG Discs

- Only files with the ".jpg" and ".JPG" extensions can be played.
- Only CD-R discs with JPEG files in ISO 9660 or Joliet format can be played.
- JPEG file names should be 8 characters or less in length and contain no blank spaces or special characters (. / = +).
- When playing a Kodak/Fuji Picture CD, only the JPEG files in the picture folder can be played.
- Picture discs other than Kodak/Fuji Picture CDs may take longer to start playing or may not play at all.
- Some files may not display their own entire image depending on the size.

## Digest Function

- You can view 9 JPEG images on the TV screen.

1

Press **DIGEST(MENU)** button during playback.

2

Press Cursor **◀, ▶, ▲, ▼** buttons to select the desired image and then press **ENTER** button.

- JPEG files will be shown in 9 windows.
- The selected image is played for 5 seconds before moving to the next image.



- To view the previous or next image with 9 windows, select **⏪** or **⏩** button on TV screen.

## Rotate/Flip Function

Press Cursor **◀, ▶, ▲, ▼** buttons during playback.



Original Image



▲ button: Flip Vertically



◀ button: Rotate 90° Counterclockwise



▶ button: Rotate 90° Clockwise



▼ button: Flip Horizontally



# Program Playback

Program allows you to store your favorite tracks for a particular disc in the player memory.

## To Program Tracks in a particular order



1

Insert the disc and close the tray.

- This function can be used only with CDs, and you can program up to 99 tracks.



1

2

Press the **PROGRAM** button while in the Stop mode.

- The following will be displayed on the TV screen .



3

Press the **NUMBERS** (0-9) button to select the desired track number and then press the **ENTER** button.

- The selected track is programmed.
- To select another track, repeat Step 3.



4

To play the programmed track, press the **PLAY (▶/||)** button.

### Note

- If you open the tray, all programmed tracks will be cleared.



## To delete the entire Program

- Press the **PROGRAM** button to twice when in the stop mode.



## When you have entered a wrong number

- Press the **NUMBERS (0-9)** button to select the track you do not want to program and then press the **CLEAR** button.



# Setup Functions

You can install your own Personal Preferences.



## Initial Settings General Operation

# 1

Press the **SETUP** button while in Stop mode.

- The setup menu appears.

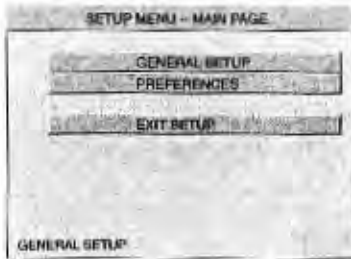

# 2

Press the **UP/DOWN** (▲/▼) to select the desired Item.

- While the desired item is displayed, press the **ENTER** button.

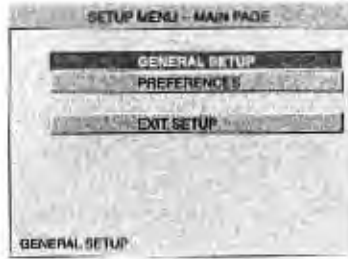

# 3

Press the **UP/DOWN** (▲/▼) to select the desired Item.



# 4

While the desired item is displayed, press **▶**, then **UP/DOWN** (▲/▼) to select the desired setting.

- The screen will display the current setting for the selected item, as well as alternate setting(s).

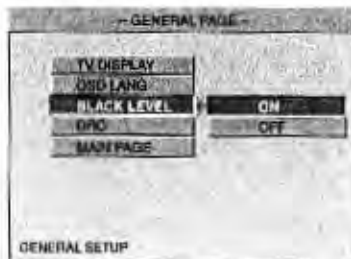

# 5

Press **ENTER** to confirm your selection.

- Some items require additional steps.



# 6

Press **SETUP**, **RETURN** to exit the setup menu.

If you select "MAIN PAGE", you will be return to the Setup screen.



## Adjusting the TV Aspect Ratio (Screen Size)

The horizontal to vertical screen size ratio of conventional TVs is 4:3, while that of wide screen and high definition TVs is 16:9. This ratio is called the aspect ratio. When playing DVDs recorded in different screen size, you should adjust the aspect ratio to fit your TV or monitor.

- \* For a standard TV, select either "4:3LB" or "4:3PS" option according to personal preference. Select "16:9" if you have a wide screen TV.

**WIDE** : Select this to view a 16:9 picture in the full-screen mode on your wide screen TV.  
•You can enjoy the wide screen aspect.

**4:3LB (4:3 Letter box)** : Select this to play a 16:9 picture in the letter box mode on a conventional TV.  
•Black bars will appear at the top and bottom of the screen.

**4:3PS (4:3 Pan&Scan)** : Select this to play a 16:9 picture in the pan & scan mode on a conventional TV.  
•You can see the central portion of the screen only (with the sides of the 16:9 picture cut off).



### Note

- If a DVD is in the 4:3 ratio, you cannot view it in wide screen.
- Since DVD discs are recorded in various image formats, they will look different depending on the software, the type of TV, and the TV aspect ratio setting

## OSD Language

Select a language for the setup menu.  
This is the menu you see when you press SETUP.

### Note

- This function may not work depending on the type of disc inserted.



## Black Level

To select the black level of playback pictures.  
Set your preference and monitor's ability.

- **On**: Expanded grey scale. (0 IRE cut off)
- **Off**: Standard grey scale. (7.5 IRE cut off)

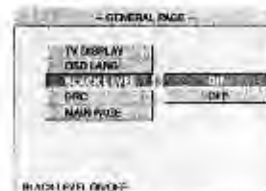

## DRC (Dynamic Range Control)

With the DVD format, you can hear a program's soundtrack in the most accurate and realistic presentation possible, thanks to digital audio technology. However, you may wish to compress the dynamic range of the audio output (the difference between the loudest sounds and the quietest ones). Then, you may listen to a movie at a lower volume without losing clarity of sound. Set DRC to On for this effect.



### Note

- This function works only in Dolby Digital mode.



# Setup Functions (Continue)



## 1

Press the **SETUP** button while in Stop mode.

- The setup menu appears.

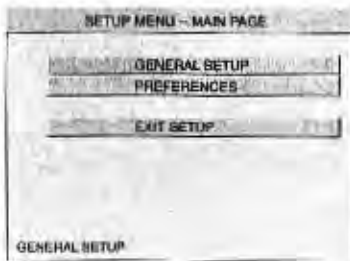

## 2

Press the **UP/DOWN** (▲/▼) to select the desired item.

- While the desired item is display, press the **ENTER** button.

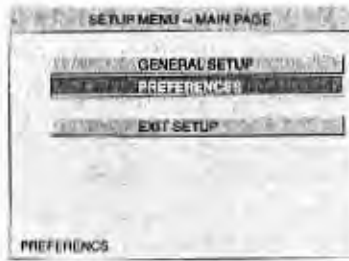

## 3

Press the **UP/DOWN** (▲/▼) to select the desired item.



## 4

While the desired item is displayed, press **▶**, then **UP/DOWN** (▲/▼) to select the desired setting.

- The screen will display the current setting for the selected item, as well as alternate setting(s).



## 5

Press **ENTER** to confirm your selection.

- Some items require additional steps.



## 6

Press **SETUP**, **RETURN** to exit the setup menu.

# Disc Language



- Select a language for the disc's Menu, Audio and Subtitle.
- **Original** : The original language set for the disc is selected.
- **Other** : To select another language, press number buttons to enter the corresponding 4-digit number according to the language code list on page 44. If you enter the wrong language code, press CLEAR.

## Parental Control

Movies on DVDs may contain scenes not suitable for children. Therefore, discs may contain Parental Control information that applies to the complete disc or to certain scenes on the disc. These scenes are rated from 1 to 8, and alternatively, more suitable scenes are available for selection on some discs. Ratings are country dependent. The Parental Control feature allows you to prevent discs from being played by your children or to have certain discs played with alternative scenes.



1. Select "PARENTAL" on the Setup menu using the **UP/DOWN** (▲ / ▼) buttons.



2. While "PARENTAL" is selected, press ► .

3. Use the **UP/DOWN** (▲ / ▼) buttons to select a parental control rating (from 1 to 8) and then press the **ENTER** button.

- **Ratings 1 to 8**: Some discs contain scenes not suitable for children. If you set a rating for the player, all disc scenes with the same rating or lower will be played. Higher rated scenes will not be played unless an alternative scene is available on the disc. The alternative must have the same rating or a lower one. If no suitable alternative is found, playback will stop. You must enter the 4-digit password or change the rating level in order to play the disc.



4. Input a password and then press the **ENTER** button.

- The player's password is set to "7 8 9 0" by default.
- There are up to 8 rating levels on a disc.
- If LEVEL 6 is selected, a disc which contains rating LEVEL 7 and above cannot be played.
- If you select NEW PASSWORD, the screen changes and enables you to enter the new password.

### Note

#### When the rating level password has been forgotten

While the player is in the stop mode, hold the **Stop** (■) button down on the main unit for more than 5 seconds.

- "INITIAL" appears on the display and all default settings will return to Factory Preset.
- Press the **On/Standby** (|/⏻) button.



# Speaker Setup

## Setting up Speaker Mode and Delay Time



# 1

Press the **SPK MODE** button.

# 2

Press the **LEFT/RIGHT** (◀ / ▶) button to select the desired item.

- Each time the button is pressed, a different mode selection is displayed on the front panel display as shown below.

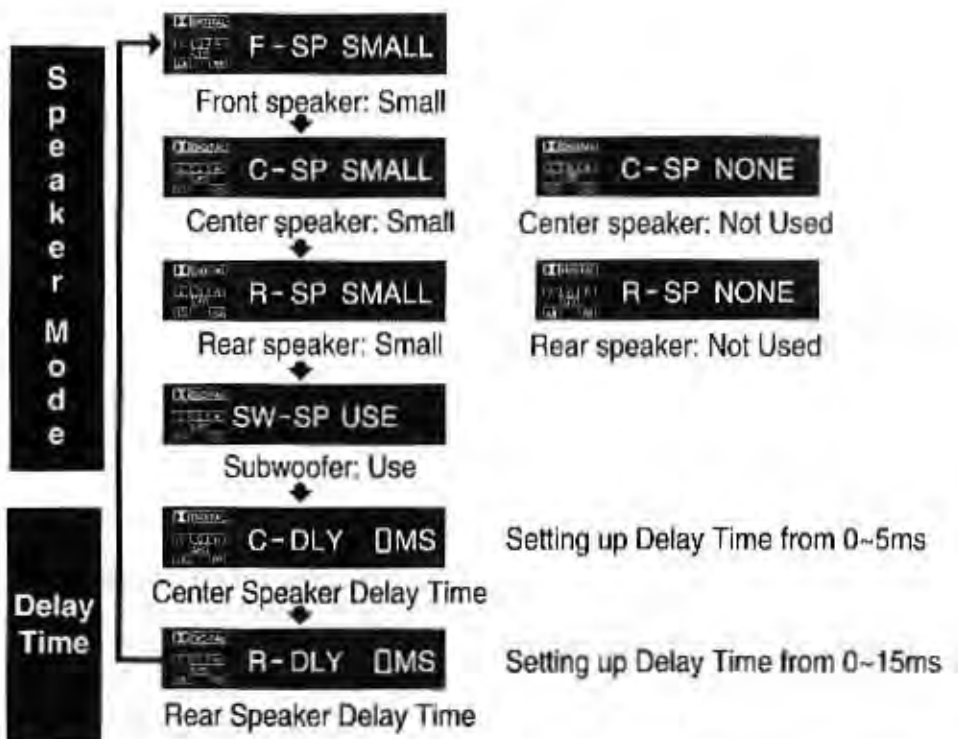

- **SMALL:** When this setting is selected, low frequencies of below 200 Hz are assigned to the subwoofer only.
- **USE:** Select when using speakers.
- **NONE:** Select this when no speakers are installed.

### Note

- The display changes depending on the current audio output mode (PRO LOGIC II, STEREO, etc.).

## Setting up the Speaker Delay Time

When 5.1CH Surround Sound is played, you can enjoy the best sound if the distance between you and each speaker is the same. Since the sounds arrive at the listening position at different times depending on the placement of speakers, you can adjust this difference by adding a delay effect to the sound of the Center Speaker and Surround Speakers.

### • Setting CENTER SPEAKER

If the distance of  $D_c$  is equal to or longer than the distance of  $D_f$  in the figure, set the mode as 0ms. Otherwise, change the setting according to the table.

Distance between $D_f$ and $D_c$	Delay Time
50	1.3 ms
100	2.6 ms
150	3.9 ms
200	5.3 ms

### • Setting REAR (SURROUND) SPEAKERS

If the distance of  $D_f$  is equal to the distance of  $D_s$  in the figure, set the mode as 0ms. Otherwise, change the setting according to the table.

Distance between $D_s$ and $D_c$	Delay Time
200	5.3 ms
400	10.6 ms
600	15.9 ms

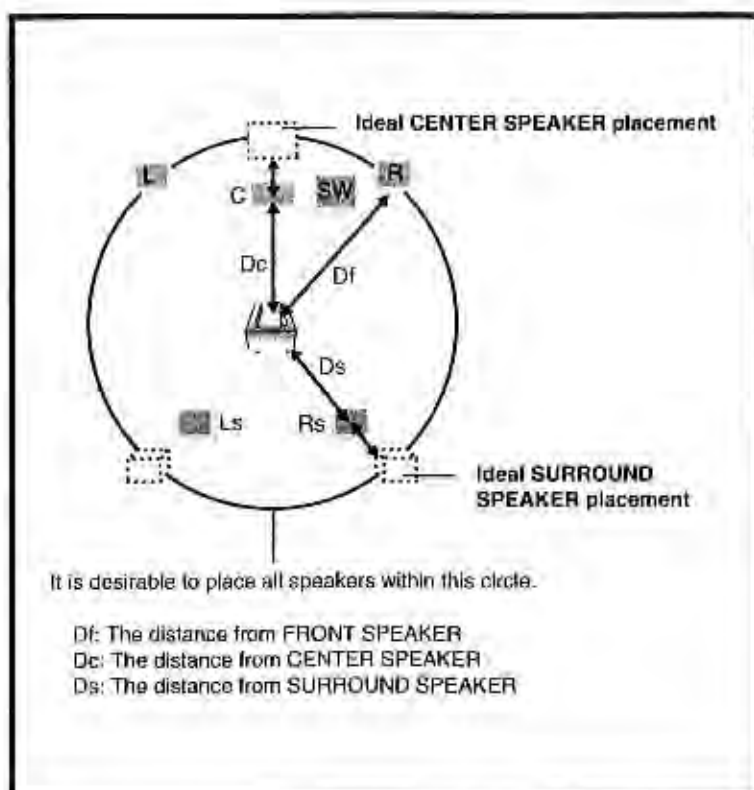

### Note

- Speaker delay time setting is a professional sound volume adjustment method for audio enthusiast. For home use, refer to "Setting up the Ideal Speaker Positions" below to install speakers in appropriate locations.





# To set up Speaker Balance

You can set the sound level of the desired channel.

## To set up Speaker Balance

# 1

Press the **SOUND EDIT** button. Each time the button is pressed, the selection switches as shown below.

# 2

Use the **LEFT/RIGHT** ( ◀ / ▶ ) button to raise or lower the output level of the chosen speaker(s).

### Example: 5.1CH Sound Setup

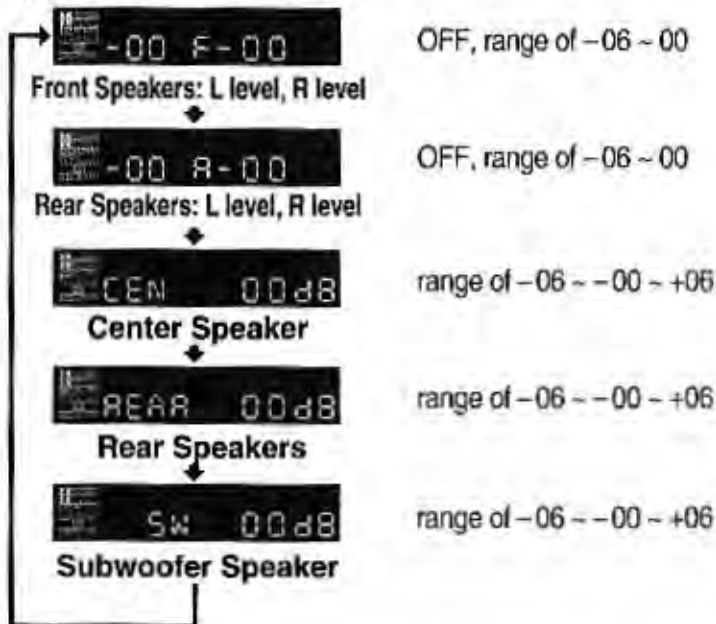

### Note

- The display changes depending on the current audio output mode ( PRO LOGIC II, STEREO, etc.).

## Test Tone FUNCTION

Press the **TEST TONE** button on the remote control.

- This function allows you can easily adjust the sound balance of the speakers from the listener's position.
- The test signal will be sent to the Left Front → Center → Right Front → Right Rear → Left Rear → LFE in that order.

To End the Speaker Setup

TEST TONE

- Press the **TEST TONE** button again.

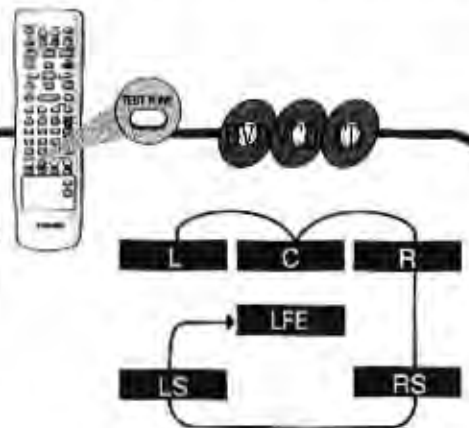

### Note

- While in STEREO or PRO LOGIC mode, TEST TONE may operate differently for VCDs or CDs.
- When playing a DVD or CD, this will work only in STOP mode.



# Creating Realistic Sound Fields

You can use the following surround modes to reproduce a realistic sound field.

- Digital Multichannel Surround —Dolby Digital and DTS Digital Surround
- Dolby Pro Logic II

## Dolby Digital and DTS Digital Surround

To enjoy surround effectively, all the speakers need to be connected and activated.

### Dolby Digital

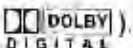
Used to reproduce multichannel sound tracks of the software encoded with Dolby Digital (  ).

**Dolby Digital** encoding method (discrete 5.1 channel digital audio format) records and digitally compresses the left front channel, right front channel, center channel, left rear channel, right rear channel and LFE channel signals (total 6 channels, but LFE channel is counted as 0.1 channel).

In addition, Dolby Digital enables stereo rear sounds, and sets the cutoff frequency of the rear treble at 20 kHz, compared to 7 kHz for Dolby Pro Logic. These facts result in better sound quality than Dolby Pro Logic.

When the system detects Dolby Digital signals, the DOLBY DIGITAL indicator lights up on the display.

### DTS Digital Surround

Used to reproduce multichannel sound tracks for software encoded with DTS Digital Surround (  ).

**DTS Digital Surround** is another discrete 5.1 channel digital audio format available on CD, LD and DVD software. Compared to Dolby Digital, audio compression rate is relatively low.

This fact allows DTS Digital Surround format to add breadth and depth to the reproduced sounds. As a result, DTS Digital Surround features natural, solid and clear sound.

When the system detects DTS Digital Surround signals, the DTS indicator lights up on the display.

## Dolby Pro Logic II

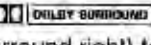
- Dolby Pro-Logic II is a new multi-channel playback format developed by Dolby Laboratories using feedback logic steering technology and offering improvements over conventional Dolby Pro Logic circuits.
- Dolby Pro Logic II can be used to decode not only sources recorded in Dolby Surround (  ) but also regular stereo sources into five channels (front left, front right, center, surround left and surround right) to achieve surround sound.
- Whereas with conventional Dolby Pro Logic the surround channel playback frequency band was limited, Dolby Pro Logic II offers a wider band range.  
In addition, the surround channels were monaural (the surround left and right channels were the same) with previous Dolby Pro Logic, but with Dolby Pro Logic II they are stereo.

### \* Sources recorded in Dolby Surround

These are sources in which three or more channels of surround have been recorded as two channels of signals using Dolby Surround encoding technology.

Dolby Surround is used for the sound tracks of movies recorded on DVDs, LDs and video cassettes to be played on stereo VCRs, as well as for the stereo broadcast signals of FM radio, TV, satellite broadcasts and cable TV.

Decoding these signals with Dolby Pro Logic makes it possible to achieve multi-channel surround playback.

The signals can also be played on ordinary stereo equipment, in which case they provide normal stereo sound.

*Manufactured under license from Dolby Laboratories. "Dolby," "Pro Logic," and the double-D symbol are trademarks of Dolby Laboratories. Confidential Unpublished Works. ©1992-1997 Dolby Laboratories, Inc. All rights reserved.*

*Manufactured under license from Digital Theater Systems, Inc. US Pat. No. 5,451,942 and other world-wide patents issued and pending. "DTS" and "DTS Digital Surround" are trademarks of Digital Theater Systems, Inc. ©1996 Digital Theater Systems, Inc. All rights reserved.*



## Dolby Pro Logic II Effect Function

This function works only in Dolby Pro Logic MUSIC mode.

1

Press **PL II MODE** button to select 'MUSIC' mode.



2

Press **PL II EFFECT** button and then press **Left/Right** (**◀ / ▶**) buttons to select the mode.

- You can select either 0 or 1.



3

Press **PL II EFFECT** button and then press **Left/Right** (**◀ / ▶**) buttons to select the next mode.

- You can select between 0 and 7.



4

Press **PL II EFFECT** button and then press **Left/Right** (**◀ / ▶**) buttons to select the next mode.

- You can select between 0 and 6.



- **PANORAMA:** This mode extends the front stereo image to include the surround speakers for an exciting "wraparound" effect with side wall imaging.
- **CENTER WIDTH:** Sound is output to the center speaker only.  
The front left and right speakers produce phantom sound.
- **DIMENSION:** Incrementally adjusts the sound field (DSP) from the front or rear.

### Note

- When playing a DVD disc encoded with two or more channels, multi-channel mode will be selected automatically and **PL II** (Dolby Pro Logic II) button does not work.





# Listening to the Radio

Preset radio stations in the DVD receiver's memory first (see "Presetting radio stations" on the Right side).

## Setting the AM Tuner Interval Spacing(option)

Some countries space AM stations 9kHz apart, and other countries use 10kHz spacing.

- 9kHz interval spacing is the initial setting.
- Each time you do the following procedure, the AM tuner interval spacing alternates between **STEP-9K** and **STEP-10K**.

**1** Select AM as the band.

**2** Press **STEP** button more than 3 seconds  
the new setting for the interval spacing appears on the display.

Remote Control Unit

**1**

Press the **TUNER** button.

- The selection toggles back and forth between "FM" and "AM" each time the **Tuner(Band)** button is pressed.

**2**

Select a broadcast station.

**Auto Station 1**

When the **◀◀** or **▶▶** button is pressed, a preset broadcast station is selected.

**Auto Station 2**

Hold in the **◀◀** or **▶▶** button. Automatic searching begins, and then stops when a station is tuned in.

**Manual Station**

Press the **◀◀** or **▶▶** button to tune to the chosen station. The frequency changes incrementally in either direction each time the corresponding button is pressed.

Main Unit

**1**

Press the **Function** button to select the desired band (FM, AM).

**2**

Select a broadcast station.

**Auto Station 1**

Press the **Stop (■)** button to select the **PRESET** mode. Then press the **◀◀** or **▶▶** button to select a station stored in the preset. See the instructions on the next page to preset stations.

**Auto Station 2**

Press the **Stop (■)** button to select the **MANUAL** mode on the front panel. Then hold in the **◀◀** or **▶▶** button to make the unit begin automatically searching for broadcast stations.

**Manual Station**

Press the **Stop (■)** button to select the **MANUAL** mode on the front panel. Press the **◀◀** or **▶▶** button to tune to the desired station. The frequency changes incrementally in either direction each time the corresponding button is pressed.





# Presetting the radio stations

You can preset 30 stations for FM and AM. Before tuning, make sure that you have turned down the volume.

Example: Presetting FM 89.1 in the memory

**1**

Press the **TUNER** button and select the FM band.

**2**

Select **MANUAL** by pressing the **STOP** (■) button on the main unit.

**3**

Use the ◀◀ or ▶▶ button to tune to 89.1

- The selection toggles back and forth between "FM" and "AM" each time the **Tuner** button is pressed.



FM 101.20



MANUAL



FM 89.10

**4**

Press the **PROGRAM** button on the remote control, 1FM will flash. If you want to save 89.1 to 1FM, press Program again.

**5**

If you want to save 89.1 to another preset location (2FM-15FM), press ◀◀ or ▶▶, then press **Program** to save it to that location.

**6**

To preset other stations, follow steps 1-5 again.



1FM 89.10



2FM 89.10



FM 89.10

## To tune in a preset station

See the previous page.



# Sleep Function



## To set up Sleep

Press the **SLEEP** button.

- Each time the button is pressed the selection on the front panel toggles as follows:  
SLEEP 10 → SLEEP 20 → SLEEP 30 →  
SLEEP 60 → SLEEP 90 → SLEEP 120 →  
SLEEP 150 → OFF.

What is the Sleep function?

You can set the sleep time so that the unit powers off automatically after a preset period of time.

## To Review Sleep Setting

- Press the **SLEEP** button.  
The remaining time for the selected Sleep time is displayed on the front panel.
- Pressing the button once again changes the Sleep time from the last setting.



## Using Headphone Jack

Connect a stereo headphone plug (ø3.5mm) into the PHONES connector.  
The speakers are automatically disconnected when you plug in the headphones (not supplied).

### Note

- When you use the headphones, keep the volume at a moderate level. If you use the headphones continuously with high volume sound, it may cause hearing damage.



## Mute Function

Press **MUTE** to mute your unit.

You can mute your unit in order, for example, to answer the telephone, "MUTE" indicator flashes in the display window.



# Cautions on Handling and Storing Discs

Small scratches on the disc may reduce sound and picture quality or cause breaks in playback. Be especially careful not to scratch discs when handling them.

## Handling discs



**Do not touch the playback side of the disc. Hold the disc by the edges so that fingerprints will not get on the surface. Do not stick paper or tape on the disc.**

## Handling and Storing Discs



**When you get fingerprints or dirt on the disc, clean it with a mild detergent diluted in water and wipe with a soft cloth.**

- When cleaning, wipe gently from the inside to the outside of the disc.

### Note

- Condensation may form if warm air comes into contact with cold parts inside the player. When condensation forms inside the player, the player may not operate correctly. If this occurs, remove the disc and let the player stand for 1 or 2 hours with the power on.

## Disc Storage

**Do not keep in direct sunlight**



**Keep in a cool ventilated area**

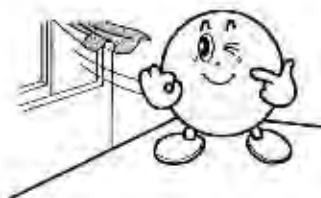

**Keep in a clean Protection jacket. Store vertically.**



### Caution

- Do not allow the discs to become contaminated with dirt.
- Do not load cracked discs or discs that are scratched.



# Troubleshooting

Check the following guide for the possible cause of a problem before contacting service.

Symptom	Cause	Correction
No power.	<ul style="list-style-type: none"> <li>The power cord is disconnected.</li> </ul>	<ul style="list-style-type: none"> <li>Plug the power cord into the wall outlet securely.</li> </ul>
The power is on, but the DVD receiver does not work.	<ul style="list-style-type: none"> <li>No disc is inserted.</li> </ul>	<ul style="list-style-type: none"> <li>Insert a disc. (Check that the DVD or, audio CD indicator in the display window is lit.)</li> </ul>
No picture.	<ul style="list-style-type: none"> <li>The TV is not set to receive DVD signal output.</li> </ul>	<ul style="list-style-type: none"> <li>Select the appropriate video input mode on the TV so the picture from the DVD receiver appears on the TV screen.</li> </ul>
	<ul style="list-style-type: none"> <li>The video cable is not connected securely.</li> </ul>	<ul style="list-style-type: none"> <li>Connect the video cable into the jacks securely.</li> </ul>
	<ul style="list-style-type: none"> <li>The connected TV power is turned off.</li> </ul>	<ul style="list-style-type: none"> <li>Turn on the TV.</li> </ul>
No sound.	<ul style="list-style-type: none"> <li>The equipment connected with the audio cable is not set to receive DVD signal output.</li> </ul>	<ul style="list-style-type: none"> <li>Select the correct input mode of the audio receiver so you can listen to the sound from the DVD receiver.</li> </ul>
	<ul style="list-style-type: none"> <li>The audio cables are not connected securely.</li> </ul>	<ul style="list-style-type: none"> <li>Connect the audio cable into the jacks securely.</li> </ul>
	<ul style="list-style-type: none"> <li>The power of the equipment connected with the audio cable is turned off.</li> </ul>	<ul style="list-style-type: none"> <li>Turn on the equipment connected with the audio cable.</li> </ul>
	<ul style="list-style-type: none"> <li>The Digital Audio Output is set to the wrong position.</li> </ul>	<ul style="list-style-type: none"> <li>Set the Digital Audio Output to the correct position, then turn on the DVD receiver again by pressing On/standby (I/O).</li> </ul>
The playback picture is poor.	<ul style="list-style-type: none"> <li>The disc is dirty.</li> </ul>	<ul style="list-style-type: none"> <li>Clean the disc.</li> </ul>
The DVD receiver does not start playback.	<ul style="list-style-type: none"> <li>No disc is inserted.</li> </ul>	<ul style="list-style-type: none"> <li>Insert a disc. (Check that the DVD, or audio CD indicator in the DVD display is lit.)</li> </ul>
	<ul style="list-style-type: none"> <li>An unplayable disc is inserted.</li> </ul>	<ul style="list-style-type: none"> <li>Insert a playable disc. (Check the disc type, color system and Regional code.)</li> </ul>
	<ul style="list-style-type: none"> <li>The disc is placed upside down.</li> </ul>	<ul style="list-style-type: none"> <li>Place the disc with the playback side down.</li> </ul>
	<ul style="list-style-type: none"> <li>The disc is not placed within the guide.</li> </ul>	<ul style="list-style-type: none"> <li>Place the disc on the disc tray correctly inside the guide.</li> </ul>
	<ul style="list-style-type: none"> <li>The disc is dirty.</li> </ul>	<ul style="list-style-type: none"> <li>Clean the disc.</li> </ul>
	<ul style="list-style-type: none"> <li>The Rating level is set.</li> </ul>	<ul style="list-style-type: none"> <li>Cancel the Rating function or change the rating level.</li> </ul>
The remote control does not work properly.	<ul style="list-style-type: none"> <li>The remote control is not pointed at the remote sensor of the DVD receiver.</li> </ul>	<ul style="list-style-type: none"> <li>Point the remote control at the remote sensor of the DVD receiver.</li> </ul>
	<ul style="list-style-type: none"> <li>The remote control is too far from the DVD receiver.</li> </ul>	<ul style="list-style-type: none"> <li>Operate the remote control within about 23 ft (7 m).</li> </ul>
	<ul style="list-style-type: none"> <li>There is an obstacle in the path of the remote control and the DVD receiver.</li> </ul>	<ul style="list-style-type: none"> <li>Remove the obstacle.</li> </ul>
	<ul style="list-style-type: none"> <li>The batteries in the remote control are exhausted.</li> </ul>	<ul style="list-style-type: none"> <li>Replace the batteries with new ones.</li> </ul>



# Language Code List

Enter the appropriate code number for the initial settings "Disc Audio", "Disc Subtitle" and/or "Disc Menu" (See page 30).

Code	Language	Code	Language	Code	Language	Code	Language
6565	Afar	7079	Faroese	7678	Lingala	8375	Slovak
6566	Abkhazian	7082	French	7679	Laothian	8376	Slovenian
6570	Afrikaans	7089	Frisian	7684	Lithuanian	8377	Samoa
6577	Ameharic	7165	Irish	7686	Latvian, Lettish	8378	Shona
6582	Arabic	7166	Scots Gaelic	7771	Malagasy	8379	Somali
6583	Assamese	7176	Galician	7773	Maori	8381	Albanian
6588	Aymara	7178	Guarani	7775	Macedonian	8382	Serbian
6590	Azerbaijani	7185	Gujarati	7776	Malayalam	8385	Sudanese
6665	Bashkir	7265	Hausa	7778	Mongolian	8386	Swedish
6669	Byelorussian	7273	Hindi	7779	Moldavian	8387	Swahili
6671	Bulgarian	7282	Croatian	7782	Marathi	8465	Tamil
6672	Bihari	7285	Hungarian	7783	Malay	8469	Telugu
6678	Bengali; Bangla	7289	Armenian	7784	Maltese	8471	Tajik
6679	Tibetan	7365	Interlingua	7789	Burmese	8472	Thai
6682	Breton	7378	Indonesian	7865	Nauru	8473	Tigrinya
6765	Catalan	7383	Icelandic	7869	Nepali	8475	Turkmen
6779	Corsican	7384	Italian	7876	Dutch	8476	Tagalog
6783	Czech	7387	Hebrew	7879	Norwegian	8479	Tonga
6789	Welsh	7465	Japanese	7982	Orlyá	8482	Turkish
6865	Danish	7473	Yiddish	8065	Panjabi	8484	Tatar
6869	German	7487	Javanese	8076	Polish	8487	Twi
6890	Bhutani	7565	Georgian	8083	Pashto, Pushto	8575	Ukrainian
6976	Greek	7575	Kazakh	8084	Portuguese	8582	Urdu
6978	English	7576	Greenlandic	8185	Quechua	8590	Uzbek
6979	Esperanto	7577	Cambodian	8277	Rhaeto-Romance	8673	Vietnamese
6983	Spanish	7578	Kannada	8279	Rumanian	8679	Volapük
6984	Estonian	7579	Korean	8285	Russian	8779	Wolof
6985	Basque	7583	Kashmiri	8365	Sanskrit	8872	Xhosa
7065	Persian	7585	Kurdish	8368	Sindhi	8979	Yoruba
7073	Finnish	7589	Kirghiz	8372	Serbo-Croatian	9072	Chinese
7074	Fiji	7665	Latin	8373	Singhalese	9085	Zulu





# Specifications

GENERAL	Power Requirement	AC 220-240V, 50/60Hz		
	Power Consumption	120W		
	Weight	7.0Kg		
	Dimensions (W x H x D)	360 x 76 x 367 mm		
	Operating Temperature Range	+5°C ~ +35°C		
	Operating Humidity Range	10% ~ 75%		
FM TUNER	Usable Sensitivity	10dB		
	S/N Ratio	55dB		
	Distortion	0.3%		
AM TUNER	Usable Sensitivity	54dB		
	S/N Ratio	35dB		
	Distortion	2%		
VIDEO INPUT	Component Video	1.0Vp-p(75Ω load) Pin Jack x 2		
VIDEO OUTPUT	Composite Video	1.0Vp-p(75Ω load)		
	Component Video	Y:1.0Vp-p(75Ω load)		
		Pr:0.70Vp-p(75Ω load)		
		Pb:0.70Vp-p(75Ω load)		
S-VIDEO	Luminance Signal: 1.0Vp-p(75Ω load) Color Signal: 0.286Vp-p(75Ω load)			
AMPLIFIER	Front speaker output	50W x 2(6Ω), Distortion 10%		
	Center speaker output	50W(6Ω), Distortion 10%		
	Rear speaker output	50W x 2(6Ω), Distortion 10%		
	Subwoofer speaker output	70W(3Ω), Distortion 10%		
	Frequency range	20~25KHz		
	S/N Ratio	75dB		
	Channel separation	53dB		
	Input sensitivity	(AUX)500mV		
SPEAKER	Speaker system	5.1ch speaker system		
		Front/Center/Rear speaker	Subwoofer speaker	
	Impedance	6Ω x 5	3Ω	
	Frequency range	100Hz~18KHz	40Hz~200Hz	
	Output sound pressure level	87dB/W/M	86dB/W/M	
	Rated input	50W	70W	
	Maximum input	100W	140W	
	Dimensions (W x H x D)	Front/Rear	103 x 150 x 120 mm	210 x 365 x 342 mm
		Center	197 x 103 x 120 mm	
	Weights	Front/Rear	2.92 Kg	6.6 Kg
Center		0.8 Kg		



# Memo

**TOSHIBA**

**AH68-01289G**

## Free Manuals Download Website

<http://myh66.com>

<http://usermanuals.us>

<http://www.somanuals.com>

<http://www.4manuals.cc>

<http://www.manual-lib.com>

<http://www.404manual.com>

<http://www.luxmanual.com>

<http://aubethermostatmanual.com>

Golf course search by state

<http://golfingnear.com>

Email search by domain

<http://emailbydomain.com>

Auto manuals search

<http://auto.somanuals.com>

TV manuals search

<http://tv.somanuals.com>