

# TOSHIBA

## DIGITAL AUDIO PLAYER MEA210

*OWNER'S MANUAL*

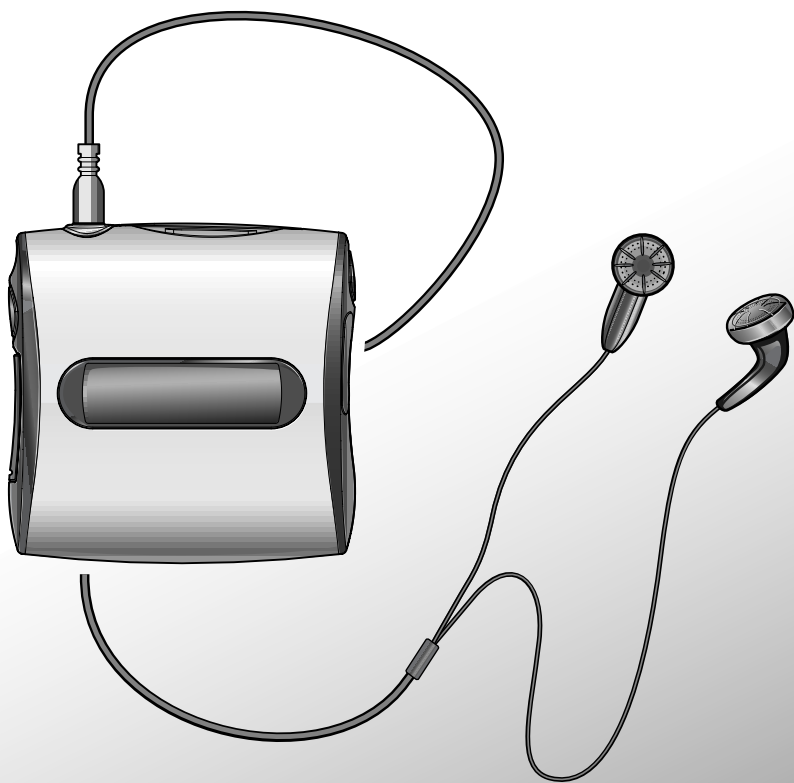

© 2001 TOSHIBA CORPORATION  
XZ2029P012

Introduction

Preparation

Audio data preparation

Operation

Others

Product Name : DIGITAL AUDIO PLAYER  
Model Number(s) : MEA210

 Tested To Comply  
With FCC Standards  
FOR HOME OR OFFICE USE

## FCC Notice “Declaration of Conformity Information”

This equipment has been tested and found to comply with the limits for a Class B digital device, pursuant to part 15 of the FCC Rules. These limits are designed to provide reasonable protection against harmful interference in a residential installation. This equipment generates, uses and can radiate radio frequency energy and, if not installed and used in accordance with the instructions, may cause harmful interference to radio communications. However, there is no guarantee that interference will not occur in a particular installation. If this equipment does cause harmful interference to radio or television reception, which can be determined by turning the equipment off and on, the user is encouraged to try to correct the interference by one or more of the following measures:

- Reorient or relocate the receiving antenna.
- Increase the separation between the equipment and receiver.
- Connect the equipment into an outlet on a circuit different from that to which the receiver is connected.
- Consult the dealer or an experienced radio/TV technician for help.

**Warning :** Changes or modifications made to this equipment, not expressly approved by Toshiba or parties authorized by Toshiba could void the user's authority to operate the equipment.

This device complies with part 15 of the FCC Rules. Operation is subject to the following two conditions :

- (1) This device may not cause harmful interference, and
- (2) this device must accept any interference received, including interference that may cause undesired operation.

Toshiba America Consumer Products, Inc.  
82 Totowa Road, Wayne, New Jersey, 07470  
(973)628-8000

### Industry Canada

This Class B digital apparatus complies with Canadian ICES-003.

# IMPORTANT SAFETY INSTRUCTIONS

**CAUTION: PLEASE READ AND OBSERVE ALL WARNINGS AND INSTRUCTIONS GIVEN IN THIS OWNER'S MANUAL AND THOSE MARKED ON THE UNIT. RETAIN THIS BOOKLET FOR FUTURE REFERENCE.**

This set has been designed and manufactured to assure personal safety. Improper use can result in unit's overheating or fire hazard. The safeguards incorporated in this unit will protect you if you observe the following procedures for installation, use and servicing. This unit is fully transistorized and does not contain any parts that can be repaired by the user.

- 1. Read owner's manual**  
After unpacking this product, read the owner's manual carefully, and follow all the operating and other instructions.
- 2. Heat**  
The product should be situated away from heat sources such as radiators, heat registers, stoves, or other products that produce heat.
- 3. Water and Moisture**  
Do not use this product near water - for example, near a bath tub, wash bowl, kitchen sink, or laundry tub; in a wet basement; or near a swimming pool and the like.
- 4. Cleaning**  
Remove all cables and battery from this product before cleaning. Do not use liquid cleaners or aerosol cleaners. Use a soft cloth for cleaning.
- 5. Object and Liquid Entry**  
Never push objects of any kind into this product through openings as they may touch electrical parts and could result in a fire or unit's overheating. Never spill liquid of any kind on the product.
- 6. Attachments**  
Do not use attachments not recommended by the product manufacturer as they may cause hazards.

# IMPORTANT SAFETY INSTRUCTIONS

---

## 7. Burden

Do not place a heavy object on, or step on the product. Doing so may cause serious damage to the product.

## 8. Headphones

When you use headphones, keep the volume at a moderate level. If you use the headphones continuously with high volume sound, it may cause hearing damage.

## 9. Damage Requiring Service

Remove all cables and battery from this product and refer servicing to qualified service personnel under the following conditions:

- If liquid has been spilled, or objects have fallen into the product.
- If the product has been exposed to rain or water.
- If the product does not operate normally by following the operating instructions. Adjust only those controls that are covered by the operating instructions as an improper adjustment of other controls may result in damage and will often require extensive work by a qualified technician to restore the product to its normal operation.
- If the product has been dropped or damaged in any way.
- When the product exhibits a distinct change in performance - this indicates a need for service.

## 10. LCD

When the LCD panel is broken and the liquid leaks out, do not touch the liquid as it may cause a rash. If your hands or clothes touch the liquid, immediately wash it off.

## 11. Restriction

Do not use this product if a medical instrument such as a pacemaker is embedded in your body, or if you are in a location where use of electronic instruments is restricted, such as an aircraft cabin.

## 12. Children's misuse

Do not put this product or SD memory card in your mouth. For children's safety, keep this product out of their reach.

### 13. Traffic

Do not use this product while driving. Do not operate this product while walking. You may become distracted and cause a traffic accident.

### 14. Servicing

Do not attempt to service this product yourself as opening or removing covers may expose you to high temperature or other hazards. Refer all servicing to qualified service personnel.

### 15. Replacement Parts

When replacement parts are required, be sure the service technician has used replacement parts specified by the manufacturer or have the same characteristics as the original part. Unauthorized substitutions may result in fire, unit overheating, or other hazards.

### 16. Safety Check

Upon completion of any service or repairs to this product, ask the service technician to perform safety checks to determine that the product is in proper operating condition.

# Precautions

## Notes on handling

- Do not shock the unit. It may cause damage to the audio data.
- Do not press against the display of the unit. It may cause damage.
- Do not use volatile liquids, such as insect spray, near the unit. Do not leave rubber or plastic products in contact with the unit for a long time. They will leave marks on the finish.
- Do not put the unit in a pants pocket. Sitting down may crush the unit.

## Notes on locating

- When you use this unit near a TV, radio, or portable phone, radio interference may occur. In this case, operate the unit away from the TV, radio, or portable phone.

## Notes on cleaning

Use a soft, dry cloth for cleaning.

- For stubborn dirt, soak the cloth in a weak detergent solution, wring well and wipe. Use a dry cloth to wipe it dry. Do not use any type of solvent, such as thinner and benzine, as they may damage the surface of the unit.
- If you use a chemical saturated cloth to clean the unit, follow that product's instructions.

## Copyrights

- It is forbidden by law to copy, broadcast, play in public, or rent copyrighted material without permission.

## Audio data

- Toshiba is not liable for any data damaged or lost by malfunction of this unit or a connected computer.
- Audio data imported by the software of this system is encoded, and cannot be copied for back-up on your computer and any other drive. Therefore, audio data in your computer may be lost in the event of system failure, crash, or recovery.

## Restrictions for copyright protection

This player system incorporates copy protection encoding technology in compliance with the terms and conditions of SDMI. Therefore, users are required to acknowledge the following restrictions on usage of this system.

- 1 Data imported to a computer or transferred to the player using the TOSHIBA Audio Manager cannot be played on any other device even if it has been copied.
- 2 In compliance with the terms and conditions of SDMI, the TOSHIBA Audio Manager cannot read data that contains copy protection signals.
- 3 Data which contains no restrictions on usage (such as CD) is limited to 3 transfers according to the terms and conditions of SDMI.

**SDMI:** Secure Digital Music Initiative, an organization established to construct technology specifications to protect digital music against illegal copy and distribution.

**PD:** An SDMI authorized device that records audio data inside or onto external media. (Portable Device)

**Note:** The TOSHIBA Audio Manager defines the TOSHIBA digital audio player as the PD.

## Exemptions

- Toshiba is not liable for any damage caused by fire, earthquake, uses by a third person, accidents, owner's intentional or unintentional misuse, or uses in other improper conditions.
- Toshiba is not liable for incidental damages (such as profit loss or interruption in business, modification or erasure of recorded data, etc.) caused by use or misuse of this unit.
- Toshiba is not liable for any damage caused by neglect of the instructions described in the owner's manual.
- Toshiba is not liable for any damage caused by misuse or malfunction through joint use of this unit and connected equipment.

# System Outline

## What is the TOSHIBA digital audio player?

The TOSHIBA digital audio player plays audio data which is stored in its internal memory or on an SD memory card (optional). To store them you must use the supplied TOSHIBA Audio Manager software.

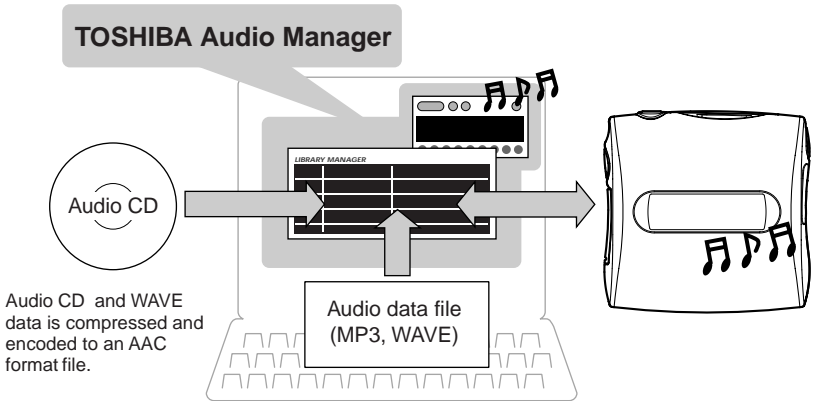

## What is the TOSHIBA Audio Manager?

The TOSHIBA Audio Manager is a software program that imports your audio data from audio CDs or audio files (MP3 or WAVE file) and transfers them to the player. The audio data is encoded and imported by the computer.

### MP3 (MPEG-1/Audio Layer3)

An international standardized compression format of sound data. This format can compress audio data to a 10th to 12th volume.

### WAVE

Standard sound file format in Windows.

### AAC (MPEG-2/Advanced Audio Coding)

An international standardized compression format of audio data that improves upon the compression rate of MP3.



**What you have to do is ...**

Perform the following procedures.

**Preparation 1: Get the player ready.**

Load battery in the player.

Page  
12

**Preparation 2: Get your computer ready.**

Install the TOSHIBA Audio Manager in your computer.

Page  
14

**Preparation 3: Prepare audio data.**

Import audio data into your computer and transfer it to the player via the TOSHIBA Audio Manager.

Page  
20

**Play the audio data on the player.**

Page  
31

Preparations 1 to 3 are necessary for all first time users of this TOSHIBA digital audio player.

Once you set up and operate the player, you will not need to make preparations 1 and 2 again.

Make preparation 3 when you want to change audio data in the player.

(continued)

## System Outline (continued)

### Minimum PC Requirements

- OS: Microsoft® Windows® 98 (Windows® 98 preinstalled)  
Microsoft® Windows® Millennium Edition  
Microsoft® Windows® 2000 (Function is not supported under Microsoft® Windows® 2000 system with Dual CPU configuration.)
- CPU: Pentium® MMX® 233MHz or higher processor  
(Pentium® II 300MHz or higher processor recommended)
- Memory: 32MB minimum (64MB or more recommended)
- Sound: Sound card 16bit or more
- Hard Disk: 30MB free space except for audio data
- CD-ROM Drive: (SCSI) ANSI X3T10-1048D Standard drive  
(ATAPI) SFF-8020 Standard drive

Microsoft, Windows are registered trademarks of the Microsoft Corporation of the U.S. registered in the USA and other countries.

MMX, Pentium are trademarks or registered trademarks of Intel Corporation registered in the USA.

### Accessories

Check to insure that the following items are supplied with the player.

- TOSHIBA Audio Manager  
CD-ROM



- Clip

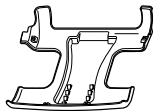

- AAA Battery (1)



- Interface cable

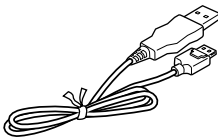

- Headphones

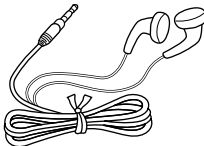

- End User License Agreement
- REGISTRATION CARD

# Table of contents

## Introduction

<b>IMPORTANT SAFETY INSTRUCTIONS</b> .....	<b>3</b>
<b>Precautions</b> .....	<b>6</b>
<b>System Outline</b> .....	<b>8</b>
<b>Table of contents</b> .....	<b>11</b>

## Preparation

<b>Loading battery</b> .....	<b>12</b>
<b>Installing the TOSHIBA Audio Manager</b> .....	<b>14</b>
Installing the TOSHIBA Audio Manager .....	14
Installing the USB driver .....	15
<b>Connection to a computer</b> .....	<b>16</b>
<b>Using an SD memory card (option)</b> .....	<b>18</b>
Inserting an SD memory card .....	18
Ejecting the SD memory card .....	18

## Audio data preparation

<b>Using the TOSHIBA Audio Manager</b> .....	<b>20</b>
<b>Using Wizard to import/transfer audio data</b> .....	<b>22</b>
<b>Importing audio data from an audio CD</b> .....	<b>23</b>
<b>Importing audio files</b> .....	<b>25</b>
<b>Transferring audio data to the player</b> .....	<b>26</b>
<b>Deleting audio data from the player</b> .....	<b>29</b>
<b>Creating a PlayList</b> .....	<b>30</b>

## Operation

<b>Playing a song</b> .....	<b>31</b>
To stop playback .....	32
To turn the power off .....	33
To play in fast forward or reverse direction .....	33
To locate a song .....	33
<b>Changing the function settings</b> .....	<b>34</b>

## Others

<b>Error messages</b> .....	<b>37</b>
<b>Formatting an SD memory card</b> .....	<b>38</b>
<b>Attaching the clip</b> .....	<b>40</b>
<b>Troubleshooting</b> .....	<b>41</b>
<b>Specifications</b> .....	<b>42</b>
<b>Identification of controls</b> .....	<b>44</b>
<b>LIMITED WARRANTY</b> .....	<b>46</b>

# Loading battery

## Caution

- Do not use battery other than that specified.
- Do not insert battery in the wrong direction.
- Do not charge, heat, open, or short-circuit the battery. Do not throw battery into a fire.
- Do not charge the supplied battery.
- When using re-chargeable battery, follow the instructions for the battery and the charger for safe handling.
- Do not leave a dead or exhausted battery in the unit.

Neglecting the above may cause battery leakage and corrosion, resulting in burns or injury.

If your fingers or clothes touch the battery acid, wash them immediately. If your eyes come in contact with battery acid, wash them and immediately consult your doctor. If the surface of an object becomes soiled, use a cloth to wipe it off, avoiding direct contact.

## 1 Open the battery cover on the player.

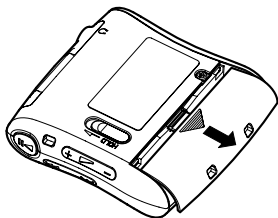

## 2 Load battery.

Make sure to match the polarity of the battery to its contacts.

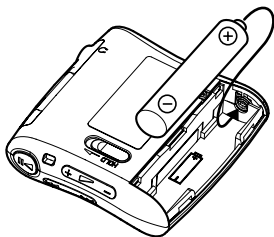

### 3 Close the battery cover.

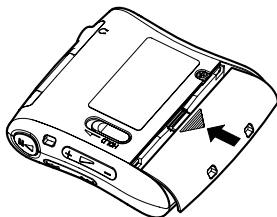

#### Notes on battery

- A durable alkaline battery or economical nickel-metal hydride rechargeable battery is recommended.
- Battery life may depend on the type of the battery or the operating condition such as storage conditions, storing, using, surrounding temperature, etc.
- If you do not use the player for a long period of time (for longer than one week), remove the battery to avoid possible damage from battery corrosion.
- A very small amount of battery life will be consumed even while the player is turned off.

#### Notes on battery indicator

- The battery consumption indicator will display when using the player. (page 45)
- When using nickel-metal hydride rechargeable battery, the battery indicator on the player may not correspond to actual battery consumption.
- If an exhausted battery is used, the battery indicator on the player may read full when you turn the player on. However the player will turn off the moment you begin operating it.

#### Notes on battery changing

Load a new battery more than 30 seconds after removing the old one. If failed to do so, the battery consumption indicator may keep displaying the status before battery changing.

# Installing the TOSHIBA Audio Manager

When you use this player for the first time, install the supplied TOSHIBA Audio Manager software into your computer. Make sure that a CD-ROM drive and a USB interface are available on your computer.

Perform the following 2 steps.

1. Installing the TOSHIBA Audio Manager
2. Installing the USB driver

Once you complete these steps, you do not have to repeat them every time.

## Preparation

- Startup your computer. Turn off all applications including virus-protection software.
- Confirm that a battery is loaded into the player. (page 12)
- Insure an unconnected USB port is available on your computer.

## Installing the TOSHIBA Audio Manager

- 1** Insert the supplied TOSHIBA Audio Manager CD-ROM into a CD-ROM drive on your computer.

“TOSHIBA Audio Manager Setup Menu” appears.



- 2** Click the button of “Audio Manager Installation Procedure.” “Audio Manager Installation Procedure” appears. Be sure to read this before proceeding.

### **3 Click the button of “AUDIO MANAGER.”**

The setup window of TOSHIBA Audio Manager appears. Follow the instructions in the windows to install.

#### **Notes**

- If the setup menu does not appear in step 1, double-click “default.htm” in the CD-ROM to display “Audio Manager Installation Procedure.” If you want to display the setup window, double-click “Setup.exe” in the CD-ROM.
- Read the “readme.txt” in the CD-ROM. It contains the system requirements of the computer and additional precautions.

### **Installing the USB driver**

#### **1 Make sure your computer has safely restarted.**

#### **2 Refer to page 16 and connect the player to a USB connector on your computer using the supplied interface cable.**

“Found New Hardware Wizard” appears.

Be sure to confirm that a battery is loaded into the player before connecting it to your computer.

#### **3 Follow the instructions on the “Installing the USB drivers” located in the “Audio Manager Installation Procedure” window.**

**Your computer is ready.**

**Now go to page 20 to prepare your favorite songs to play.**

# Connection to a computer

You must connect the player to your computer using the supplied interface cable in the following examples.

- When you install the USB drive to your computer.
- When you transfer audio data to the player.
- When you delete audio data from the player.

## 1 Open the interface door.

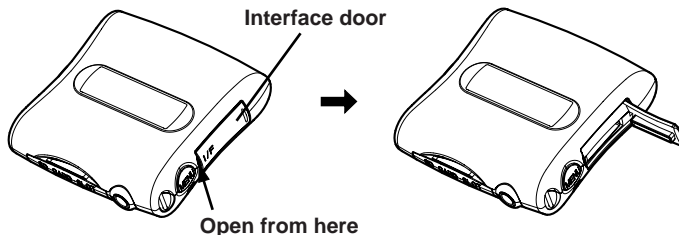

## 2 Connect to a computer using the interface cable.

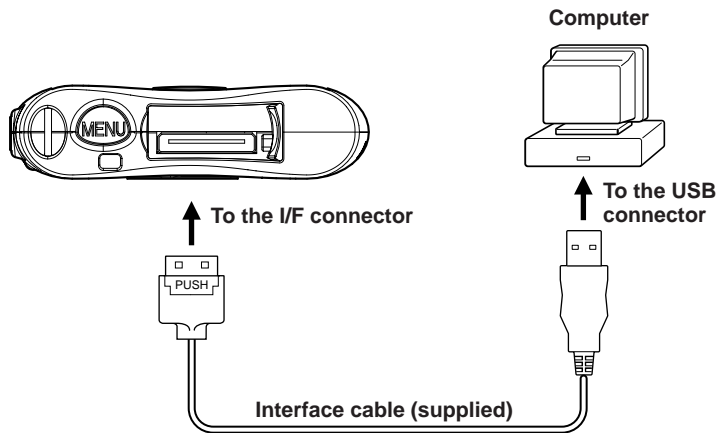

When you connect the player to your computer for the first time, "Found New Hardware Wizard" appears on the screen of your computer. Follow the on-screen instructions to install the USB driver. (page 15)



---

**To disconnect the interface cable from the player, pull out the cable while simultaneously pressing the “PUSH” mark on the connector.**

#### **Caution**

- Be sure to use the supplied interface cable when connecting to a computer. Substitution by other means may result in damage or malfunction.
- The player consumes power of 500mA/5V while connected to a computer. Confirm that a USB connector of your computer (or USB hub) satisfies this requirement before connecting the player.
- Make sure that battery is loaded before connecting to a computer. The player cannot turn on if it is connected to a computer with no battery loaded. When the player is connected to your computer, it is powered from the USB connector (or USB hub).
- Never remove the interface cable while exchanging data between the player and the computer. Doing so may damage the data.
- Close the interface door when the I/F connector is not used.
- Do not use the supplied interface cable to connect to any device other than this player.

#### **Notes**

- You cannot operate the player when connected to a computer. The player will stop playback when connected to a computer.
- The display of the player may be darker when connected to a computer. It is not abnormal.

# Using an SD memory card (option)

If you insert an SD memory card (optional) into the player, you can write audio data to it for playback.

## Inserting an SD memory card

**1** Open the card slot on the player.

**2** Insert an SD memory card into the card slot.

Slowly and fully insert an SD memory card in the correct direction. (The player automatically turns on while the SD memory card is inserted.)

**3** Close the card slot.

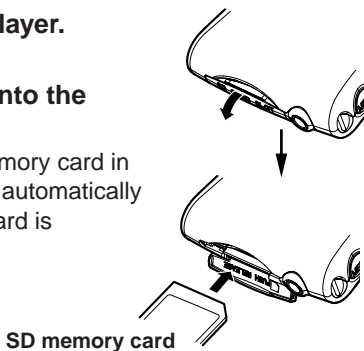

## Ejecting the SD memory card

**1** Open the card slot.

**2** Eject the SD memory card.

Press the SD memory card slightly and release to eject it a little way, then pull out the SD memory card straight and slowly.

**3** Close the card slot.

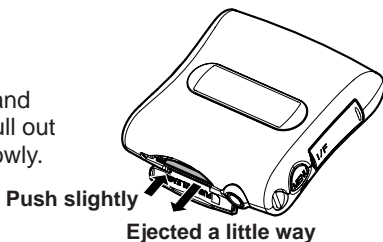

### Note

Never eject the SD memory card while you are operating the player or exchanging data between the player and the connected computer. Doing so may damage the SD memory card or the audio data in it.

### Write protect tab

An SD memory card has a write protect tab to prevent accidental erasure of the data in it.

### Write protect tab

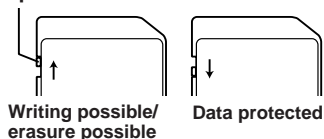

## Notes on SD memory cards

### ■ SD memory card

An SD memory card is a rewritable media designed in compliance with SDMI standards that protect intellectual copyrights. It contains a semiconductor memory, so that digital audio recording can be made on it. Deleting and re-writing of audio data is also possible.

### ■ Safety precautions to insure integrity of audio data

Audio data may be deleted in the following cases.

- When an SD memory card is misused.
- When an SD memory card is exposed to static electricity or electric noise.
- When an SD memory card is ejected during operation.

Toshiba is not liable for erasure (damage) of audio data.

### ■ Precautions on handling

- Insert an SD memory card slowly and straight into the slot on this unit.
- Never eject an SD memory card while it is being used for writing, playing or deleting of audio data. Doing so may damage audio data in the SD memory card.
- Use a recommended SD memory card. Other content may be incompatible.
- An SD memory card is a precision electronic device. Do not bend, drop or shock or otherwise abuse an SD memory card.
- Do not use or store an SD memory card in a location subject to strong static electricity.
- Do not use or store an SD memory card in a hot and humid place.
- Keep fingers and objects off the metallic "gold" surface of an SD memory card.
- Keep the SD memory card in its own case or in a commercially available storage case to protect it from static electricity.
- Inserting a static charged SD memory card may cause unit malfunction.
- Do not put an SD memory card into a pocket of pants. Sitting down may crush the unit and damage the SD memory card.
- The cartridge may become warm after a long period of use. This is not a malfunction.
- An SD memory card may become incapable of writing or deleting after a prolonged period of use. In such a case, use a new one.
- An unformatted SD memory card can not be used. This player can format the SD memory card. (page 38)

### ■ Recommended SD memory card

TOSHIBA SD memory card SD-M3201M (32MB), SD-M6401M (64MB),  
SD-M1280M (128MB)

# Using the TOSHIBA Audio Manager

## Launching the TOSHIBA AUDIO Manager

Choose “Audio Manager” from the start menu.

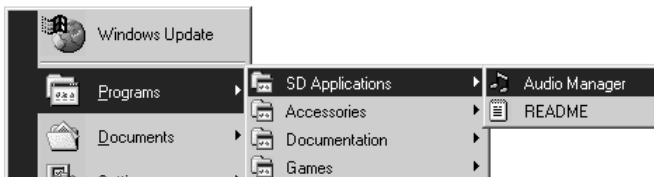

The following window (player window) appears.

When you launch the “Audio Manager” for the first time, a message to input user ID appears. Input the user ID number, which is specified by a label on the cover of the English Owner’s manual.

## (Player window)

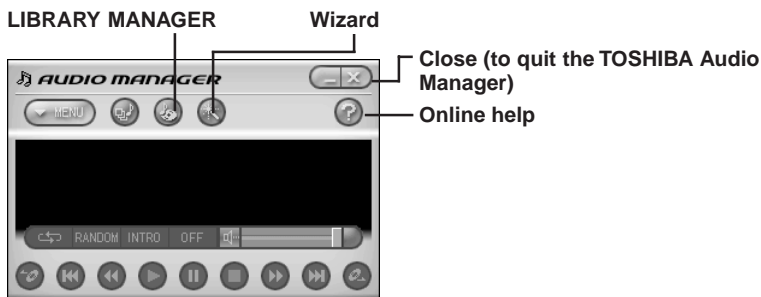

If you have any questions or problems, refer to the online help of the TOSHIBA Audio Manager.

## Procedures for importing and transferring audio data

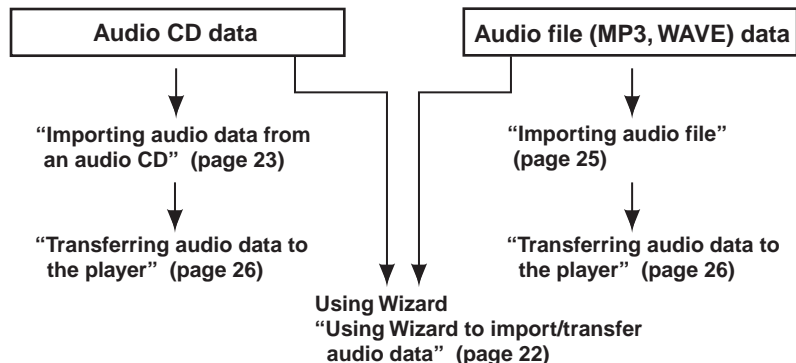

### ■ Notes on the TOSHIBA Audio Manager

- Display requirement  
Use the TOSHIBA Audio Manager on a computer with a color monitor with resolution greater than 800 x 600 and more than 65536 color capacity. If color resolution is less than 800 x 600, windows of the program will be displayed outside the visible screen area.
- Drive assignment  
A computer will recognize this player as a new drive when connected, and assign it the first available position. However, if the last position is occupied by a network drive, a computer will not assign the player the first vacant position, but instead to last position, thereby voiding the network drive position. Assign your network drive a position that does not include the player.
- If you cannot click a window of TOSHIBA Audio Manager, your system may be running short of available application memory. Quit all unnecessary applications.
- Refer to the README.TXT for CD-ROM drives on which the TOSHIBA Audio Manager has been approved to run. If you use a CD-ROM drive not included there, the TOSHIBA Audio Manager may not import audio data directly. In this case, encode audio data from the analog input device on your computer into an WAVE file using software commercially available on market, then import it into the TOSHIBA Audio Manager.

# Using Wizard to import/transfer audio data

Following the instructions in the window, you can import audio data from an audio CD and transfer it to the player or an SD memory card.

**1** Launch the TOSHIBA Audio Manager.

**2** Click  on the player window.  
The Audio Manager Wizard window appears.

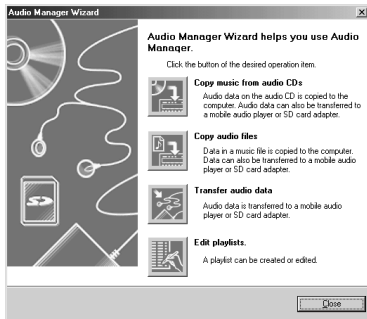

**3** Click the button you want to operate.  
Each Wizard window appears.

**Copy music from audio CDs:** To import audio data from an audio CD. You can also transfer audio data to the player or SD memory card at the same time.

**Copy audio files:** To import data from audio file. You can also transfer data to the player or SD memory card at the same time.

**Transfer audio data:** To transfer audio data to the player or SD memory card at the same time.

**Edit PlayLists:** To edit the PlayList or create a new one.

**4** Follow the instructions on the window.

## Note

If you want to import or transfer audio data in the LIBRARY MANAGER window but not included in the Wizard window, refer to page 23 to page 30.

# Importing audio data from an audio CD

This section explains how to import audio data from an audio CD. To import using the Wizard window, refer to page 22.

- 1** Launch the TOSHIBA Audio Manager.
- 2** Insert an audio CD into a CD-ROM drive on your computer.
- 3** Click  on the player window.  
The LIBRARY MANAGER window appears.
- 4** Click “CD→” on the menu, then click “Refresh.”  
Contents of the audio CD are displayed.

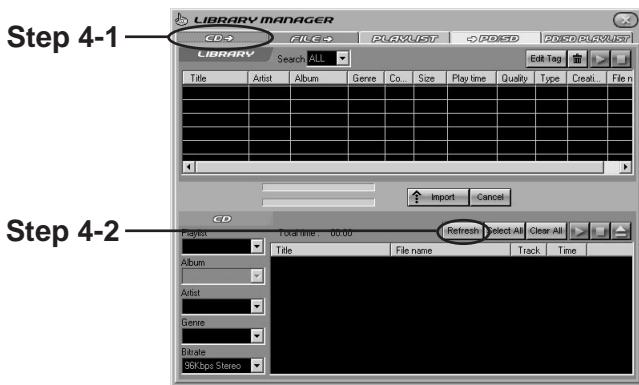

## Note

Depending on the operation status of the CD-ROM drive, the LIBRARY MANAGER may not show the entire contents of the audio CD. In this case, click “Refresh” again.

(continued)

## Importing audio data from an audio CD (continued)

- 5** Click the check box of the song you want to import, and click “↑Import.”

The process indicator starts counting. The “LIBRARY” list shows imported songs.

Before clicking “↑Import,” you can enter a name in the “PlayList” for songs you selected.

Creating a “PlayList” here will help you designate songs to transfer or play later.

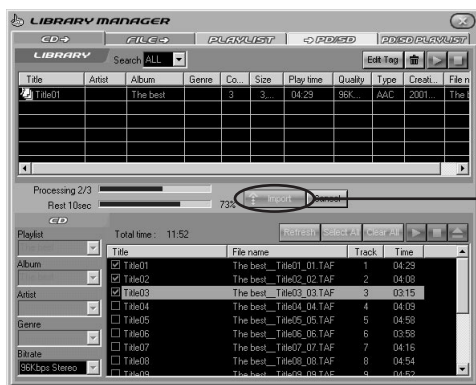

Step 5

To transfer imported audio data to the player, refer to page 26.



# Importing audio files

This section explains how to import audio file (MP3 or WAVE file) data. To import using the Wizard window, refer to page 22.

- 1** Launch the TOSHIBA Audio Manager.
- 2** Click  on the player window.  
The LIBRARY MANAGER window appears.
- 3** Click “FILE→” on the menu.  
A window for file importing appears.
- 4** Choose the folder that contains the audio file you want to import.  
The audio file (WAVE or MP3 file) appears.

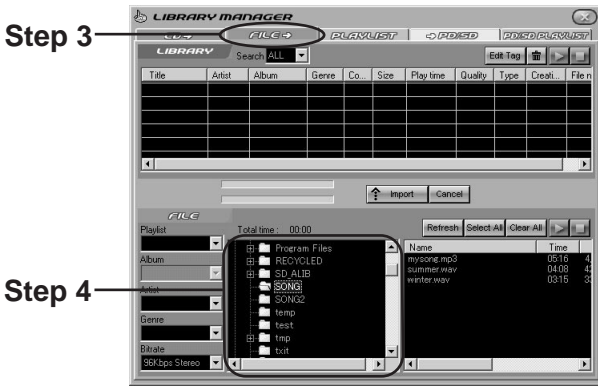

- 5** Choose the file you want to import, and click “↑Import.”  
The process indicator starts counting.

To transfer imported audio data to the player, refer to page 26.

# Transferring audio data to the player

This section explains how to transfer imported audio data to the player or an SD memory card. To import using the Wizard window, refer to page 22.

If you want to transfer data to the SD memory card, leave the SD memory card inserted in the player. (page 18)

**1** Launch the TOSHIBA Audio Manager.

**2** Click  on the player window.  
The LIBRARY MANAGER window appears.

**3** Connect the player to the computer.  
See page 16, "Connection to a computer."

**4** Click "→PD/SD" on the menu.

Contents in the PD (player) or the SD (SD memory card inserted in the player) are displayed.

At this point, be sure to turn the player on, otherwise contents will not be displayed.

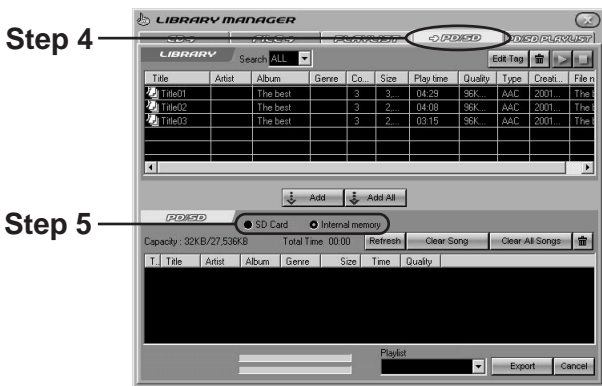

## 5 Select the location where you transfer the songs.

Internal memory : to transfer to the internal memory of the player.

SD card : to transfer to an SD memory card in the player.

## 6 Select songs to transfer from the “LIBRARY” table, and click “↓Add”.

The audio data selected is displayed in a lighter color on the lower part of the window.

If you want to transfer all songs in the PlayList simultaneously, choose “PlayList” from the “Search” menu, then choose a desired PlayList using the “Keyword” menu, then click “↓Add All”.

Step 6

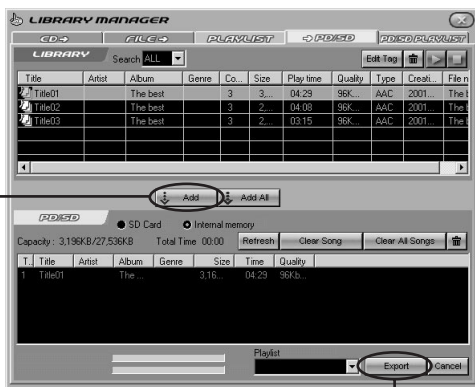

Step 7

(continued)

## Transferring audio data to the player (continued)

---

**7**

### Click “Export.”

Transferring begins. The process indicator starts counting. When transferring is complete, the indicator disappears.

### Important

Never remove the interface cable while transferring audio data.

### Notes

- You can transfer one song to the player up to 3 times. If you delete a song in the player using the same computer that transferred it previously, allowable transfers are increased by one. This is not applicable when a song is deleted utilizing a computer that did not originally transfer the song to the player.
- To play MP3 audio data on this player, be sure to use the TOSHIBA Audio Manager to transfer it. The player cannot play MP3 data which did not originate from the TOSHIBA Audio Manager.
- The PlayList is not available for this player.
- Depending on the combination of audio data's sampling frequency and bit rate, the player may not playback normally. For details, refer to page 43.

The audio data preparation is completed. To operate this player, refer to page 31.

To quit the TOSHIBA Audio Manager, click  on the window. (Page 20)

# Deleting audio data from the player

This section explains how to delete audio data from the player or SD memory card.

**1** Launch the TOSHIBA Audio Manager.

**2** Click  on the player window.  
The LIBRARY MANAGER window appears.

**3** Connect the player to a computer.

**4** Click “→PD/SD” on the menu.

Step 4

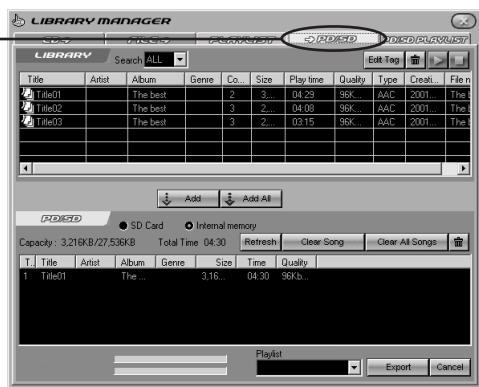

**5** Choose the memory that contains the data you want to delete.

Internal memory : the internal memory of the player.

SD card : an SD memory card inserted in the player.

**6** Choose audio data you desire to delete from the “PD/SD” on the lower part of the window, then click .

The audio data selected is deleted from the player or SD memory card.

# Creating a PlayList

You can create a new PlayList of your favorite songs from the audio data in the Library.

**1** Launch the TOSHIBA Audio Manager.

**2** Click  on the player window.  
The LIBRARY MANAGER window appears.

**3** Click “PLAYLIST” on the menu.  
The window for editing the PlayList appears.

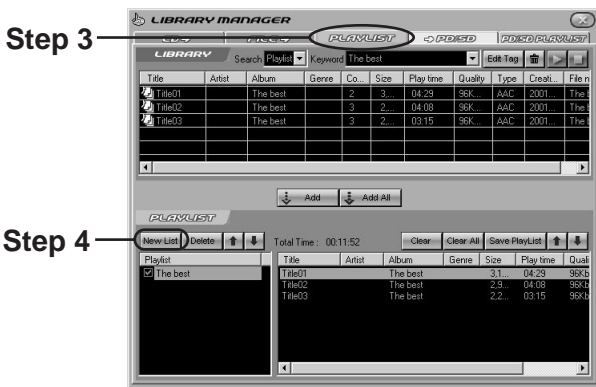

**4** Click “New List”.  
The PlayList editing screen is displayed.

**5** Input the PlayList name, and click “Save”.

**6** Choose the audio data you want to register in the PlayList from the “LIBRARY” table, and click “↓Add”.

**7** Click “Save PlayList”.  
The contents of the PlayList are stored.

# Playing a song

## Preparation

- Load battery into the player. (page 12)
- Prepare audio data for playback. (page 20)
- If the player is connected to your computer, finish writing/deleting audio data, and disconnect the cable.
- Connect the supplied headphones to the headphone jack of the player.
- For instructions on how to attach the clip to the player, refer to page 40.

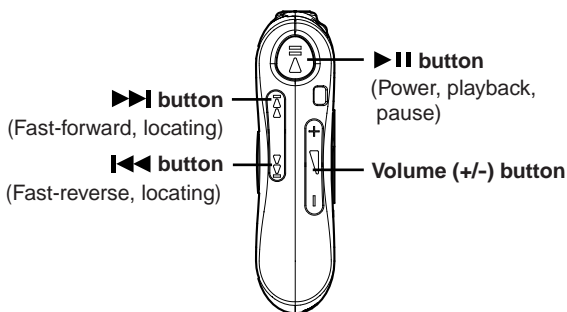
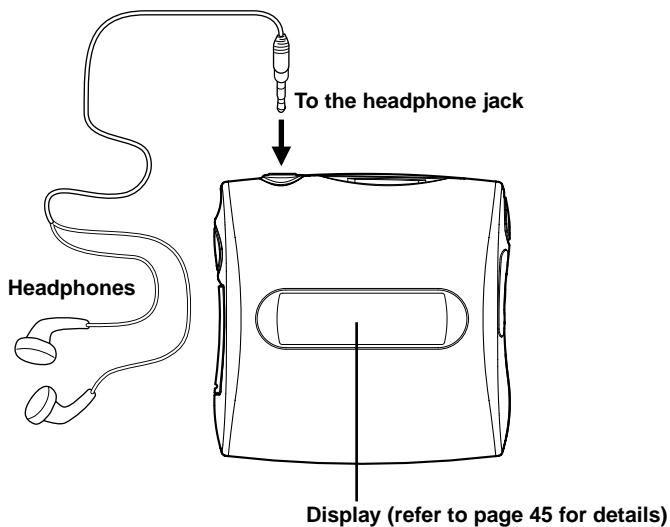

(continued)

## Playing a song (continued)

### Playback procedure

#### 1 Turn on the power.

Press the ►|| button and hold for more than 1 second, the power turns on. To play an SD memory card (option), insert it into the player. The power turns on automatically.

Display song's name

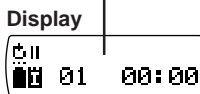

#### Note

After you have played once, the player automatically resumes playback from the location where the unit was last turned off except when:  
you remove the battery./you eject the SD memory card./you change the audio data in the SD memory card or the internal memory of the player./you re-format the SD memory card or the internal memory of the player./ the player is turned on by power from the connected computer.

#### 2 Start playback.

Press the ►|| button.

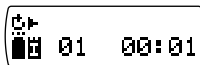

#### 3 Adjust the volume.

Press the volume (+/-) button.  
(+) : to turn up the volume.  
(-) : to turn down the volume.

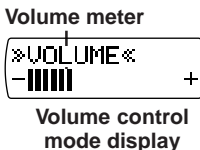

#### Note

The graphic display returns to normal mode a few seconds after adjusting the volume.

### To stop playback

#### Press the ►|| button during playback.

Playback is stopped.  
Press again to resume playback.

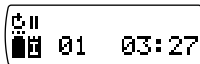

#### Note

The player automatically turns off if you do not operate it for approximately 1 minute after playback is stopped.



## To turn the power off

Press the ►|| button for more than 1 second.



## To play in fast forward or reverse direction

**Fast-forward :** press and hold the ►► button.



**Fast-reverse :** press and hold the ◀◀ button.

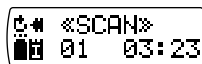

While holding the button, fast-forward or fast-reverse playback continues. If you release the button, the playback speed returns to normal.

## To locate a song

**Forward :** press and release the ►► button.



**Reverse :** press and release the ◀◀ button.



Each time you push the button, the song number in the display changes. Repeat this action until you find the desired song number.

### Notes

- If you press the ◀◀ button one time, you will only locate the beginning of the current song. To locate a previous song, repeat this action as necessary.
- To resume playback of a song you located after playback was stopped, press the ►|| button.

# Changing the function settings

You can customize your playback by changing the function settings.

## 1 Repeatedly press the MENU button to select the desired mode.



Each time you press the MENU button, the display changes.

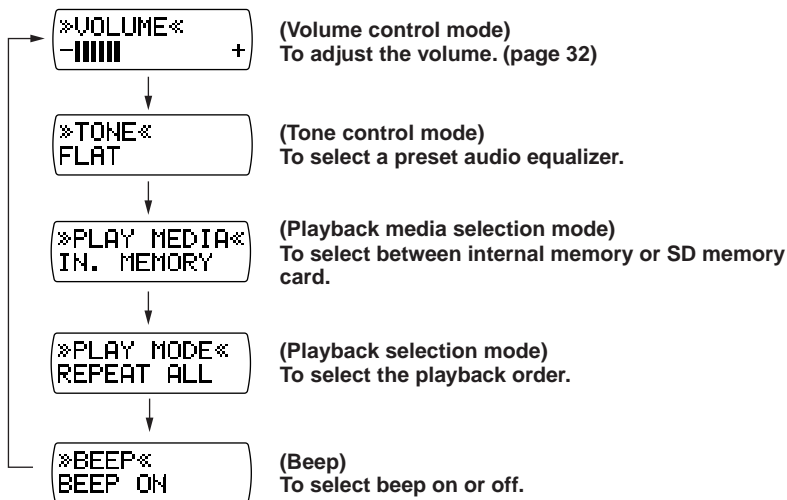

## 2 Press the volume (+/-) button to change settings.

Refer to the explanations on the following page.  
 (-) key is utilized to reverse the setting.



### Notes

- If you do not operate for a while after step 1, the display returns to normal.
- If you press and hold the MENU button in, the display returns to normal.

## Tone control mode

To select



To go to another mode



FLAT		Plays faithfully to the original sound.
BASS+		Emphasizes bass frequencies.
BASS++		Further emphasizes bass frequencies.
LOUDNESS		Emphasizes the bass and treble so that a wide dynamic range can be obtained even if you lower the volume.
HIGHCUT		Reduces the treble to prevent noise leakage from headphones.

## Playback media selection mode

To select



To go to another mode



IN. MEMORY		Plays songs in the internal memory.
SD CARD		Plays songs in the SD memory card.

### Notes

- You cannot select blank media.
- You cannot operate the media selection mode if there is no song in the internal memory or SD memory card.

(continued)

## Changing the function settings (continued)

### Playback selection mode

To select



To go to another mode



REPEAT ALL		Repeatedly plays all songs in the internal memory, and then those in the inserted SD memory card.
PLAY ONCE		Plays all songs in the internal memory, and then those in the SD memory card, and then stops.
REPEAT ONE		Plays the current song repeatedly.
RANDOM		Plays all songs in the internal memory and the SD memory card, on a random basis.

#### Notes

- If you select "RANDOM" during playback, this playback mode will become active once the current song is finished.
- If you change the internal memory/SD memory card during playback, the player stops and begins playback from the first song of the selected media; when "RANDOM" has been selected, the player stops and plays the first song of the selected media, and then plays remaining songs at random.

### Beep setting mode

To select



To go to another mode



BEEP ON		The beep (a short high sound made for confirming the operation) sounds.
BEEP OFF		The beep (a short high sound made for confirming the operation) does not sound.

In the following cases, the beep will not sound even when set to "BEEP ON".

- Any button is operated in the HOLD mode.
- Any button is operated when connecting to a computer. (However, the end buzzer is sound soon after turning the power off.)

# Error messages

Depending on the status, the player displays the following error messages for about 2 seconds.

UNUSABLE	An SD memory card that the player does not support is inserted.	An SD memory card that displays this message cannot be used.
ERROR FORMAT	The inserted SD memory card is not formatted, or the format is not supported by this system.	Format the SD memory card. (page 38) Formatting an SD memory card deletes all data in it.
REJECTED	The inserted SD memory card is not playable on this player.	Contact service. (page 47)
UNSUPPORT	The data is of a file format that the player does not support.	The data cannot be played.
READ ERROR	A reading error occurred.	Connect the player to your computer and transmit the data again. If an error of this type occurs often, empty the SD memory card and format it. Formatting an SD memory card deletes all data in it.
DATA ERROR CODE ERROR	The data is damaged.	
NO MUSIC	No playable audio data.	Transfer the audio data into the player or SD memory card.

# Formatting an SD memory card

You need to format the SD memory card when you use an unformatted disc. This player can format the SD memory card or the player's internal memory. While the player is in the formatting mode, it cannot play songs.

## Important

Formatting an SD memory card or the internal memory of the player deletes all data in it.

## Preparation

- Turn off the player.
- When you format an SD memory card, insert it into the player and turn the player off.

**1** Press the **▶||** and **◀◀** button and hold until "FORMAT" is displayed.

The player turns on and enters the formatting mode.



«FORMAT»  
SD CARD



**2** Press the volume (+/-) button to select a formatting function:

SD CARD : to format an SD memory card.

IN. MEMORY : to format the internal memory.



«FORMAT»  
SD CARD

**3** Press the **▶||** button.

The formatted item is selected.

To return to the step 2, press the MENU button.



«FORMAT» SD  
\$:MENU R:▶||

**4** Press the **▶||** button.

Formatting starts.

When formatting is complete, the message "FINISH" appears.



«FORMAT» SD  
■■■■■\_

**5** Press the **▶||** button.

The display returns to step 2 status.

To turn off the power, press the **▶||** button for more than 1 second.

---

### Important

- Improper formatting may result from the use of an incompatible computer. Use this player whenever formatting.
- Never eject an SD memory card while formatting. Doing so may damage the SD memory card.

### Notes

- An error message may be displayed during these steps.
- Press any button to return the display to the format menu screen.

NO MEDIA	No SD memory card is inserted.	Insert an SD memory card, then start formatting.
PROTECTED	The write protect tab of SD memory card is set to the data protected position.	Set the write protect tab of SD memory card to the unprotected position. (page 18)
ERROR	A formatting error occurred.	The SD memory card may be damaged.
LOW BATT.	The battery is exhausted, Formatting is not possible.	Replace the battery. (page 12)

# Attaching the clip

You can use the supplied clip to fasten the player to your belt.

## Attaching the clip

### (Back side)

Hole for the upper hook    Hole for the upper hook

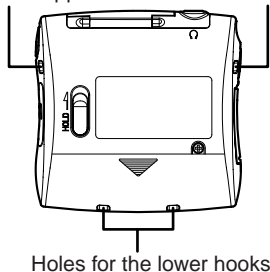

### (Clip)

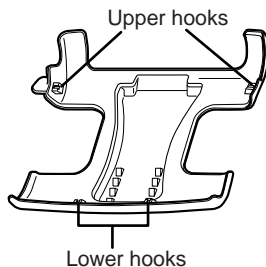

Secure the two lower hooks of the clip into the player's holes, and then fit the upper two.

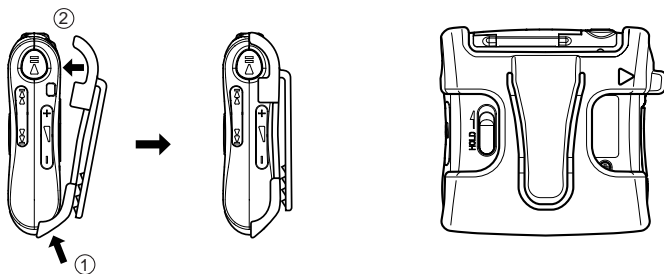

## Removing the clip

To remove the clip, pull the pull tab marked "▷" toward you to detach the hook, and slide the clip in the leftward direction.



# Troubleshooting

Check the following guide for the possible cause of a problem before contacting service.

## The player does not turn on. The buttons do not work.

- Battery is not loaded or the battery is exhausted.  
→ Load battery or replace the battery. (page 12)
- The player is locked by the HOLD switch.  
→ Return the HOLD switch back to its normal position. (page 44)
- The ►|| button was not pressed in for more than 1 second.  
→ To turn the power on, press it in for more than 1 second.
- The player is connected to a computer.  
→ Any operation other than turning the power off is not available when the player is connected to the computer.

## Playback does not start.

- There is no playable audio data in the internal memory or the SD memory card.  
→ Prepare audio data playable on this player. (page 26)

## No sound.

- The supplied headphones are not connected firmly.  
→ Connect the supplied headphones firmly. (page 31)
- The volume is set to the minimum.  
→ Adjust the volume. (page 32)

## Cannot exchange audio data.

- The inserted SD memory card is write protected.  
→ Set the write protect tab back to its unprotected position. (page 18)
- The connection to a computer is not proper.  
→ Check the connection. (page 16)

## Unusual operation or display.

- Remove the interface cable and the battery, and wait for more than 30 seconds to load the battery. (Reset operation)

# Specifications

Power supply	AAA size battery (1)						
Mass	Approx. 30g (41g including the supplied battery)						
Dimensions	53 mm × 13.5 mm × 52 mm (W/H/D) (except projecting parts)						
Recording system	SD audio V1.0/V1.1 CODEC: MPEG-2 AAC (low complexity profile) / ADTS stream MPEG-1 Audio Layer 3 (MP3) Sampling frequency: 16 kHz to 48 kHz Bit rate: 16 kbps to 192 kbps						
Recording media	Internal flash memory (approx. 32 MB) (the available capacity is 27 MB), SD memory card						
Maximum recording time	Internal flash memory: Approx. 35 minutes (bit rate 96 kbps) Approx. 54 minutes (bit rate 64 kbps)						
Playback duration	<table> <thead> <tr> <th><u>Battery</u></th> <th><u>Duration</u></th> </tr> </thead> <tbody> <tr> <td>Alkaline</td> <td>Approx. 4 hours</td> </tr> <tr> <td>Nickel-Metal Hydride rechargeable</td> <td>Approx. 4 hours</td> </tr> </tbody> </table> <p>(Measured at 25°C, bit rate 96 kbps, with alkaline battery or nickel-metal hydride rechargeable battery when played on internal flash memory) The playback duration depends on the type of the battery and the operating environment. Toshiba does not guarantee either. The playback duration may be shortened when the player is operated in a low temperature environment.</p>	<u>Battery</u>	<u>Duration</u>	Alkaline	Approx. 4 hours	Nickel-Metal Hydride rechargeable	Approx. 4 hours
<u>Battery</u>	<u>Duration</u>						
Alkaline	Approx. 4 hours						
Nickel-Metal Hydride rechargeable	Approx. 4 hours						
Operating conditions	Temperature: 5°C to 35°C, Humidity: 30% to 80% (RH) (no moisture condensation)						
I/F connector	USB interface (Required power from a connected device: 500mA)						
Headphone jack	3.5mm stereo mini jack, impedance 32 Ω						
Signal-to-noise ratio	More than 85 dB						

- The design and specifications are subject to change without notice.

---

## Audio data sampling frequency and bit rates

Player performance will vary, according to bit rate and sampling frequency. A higher value will generally offer the best audio performance, however, overall title capacity will be diminished.

### ● AAC (stereo)

	Sampling frequency		
	16kHz, 22.05kHz, 24kHz	32kHz, 44.1kHz	48kHz
Bit rate	32kbps to 64kbps	64kbps to 144kbps	64kbps to 192kbps

### ● AAC (monaural)

	Sampling frequency	
	16kHz	22.05kHz, 24kHz, 32kHz, 44.1kHz, 48kHz
Bit rate	16kbps	16kbps to 48kbps

### ● MP3 (stereo)

	Sampling frequency	
	16kHz, 22.05kHz	32kHz, 44.1kHz, 48kHz
Bit rate	32kbps to 160kbps	64kbps to 192kbps

### ● MP3 (monaural)

	Sampling frequency	
	16kHz, 22.05kHz	32kHz, 44.1kHz, 48kHz
Bit rate	32kbps to 160kbps	64kbps to 192kbps

# Identification of controls

For details, see pages in .

## Main unit

### (Front side)

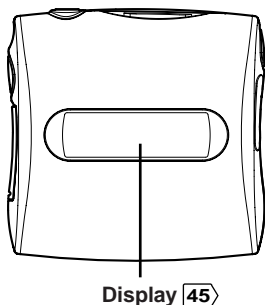

### (Right side)

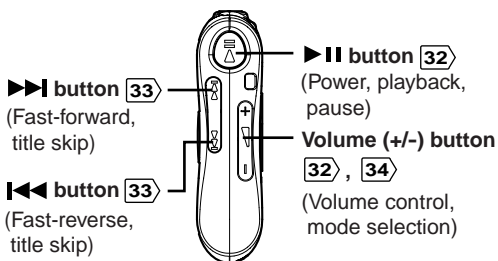

### (Left side)

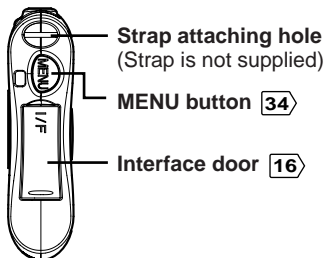

### (Back side)

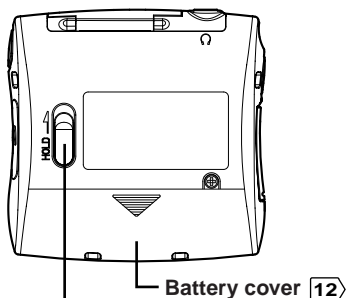

#### HOLD switch

Setting this switch in the direction of the arrow will render the unit unresponsive to any command-related activity, avoiding undesirable operation by unintentional contact. This protects your playback settings from being accidentally modified.

### (Top side)

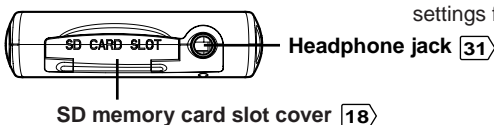

## Display

You can view information including operational status or text included in the audio data.

### (Display example while playing)

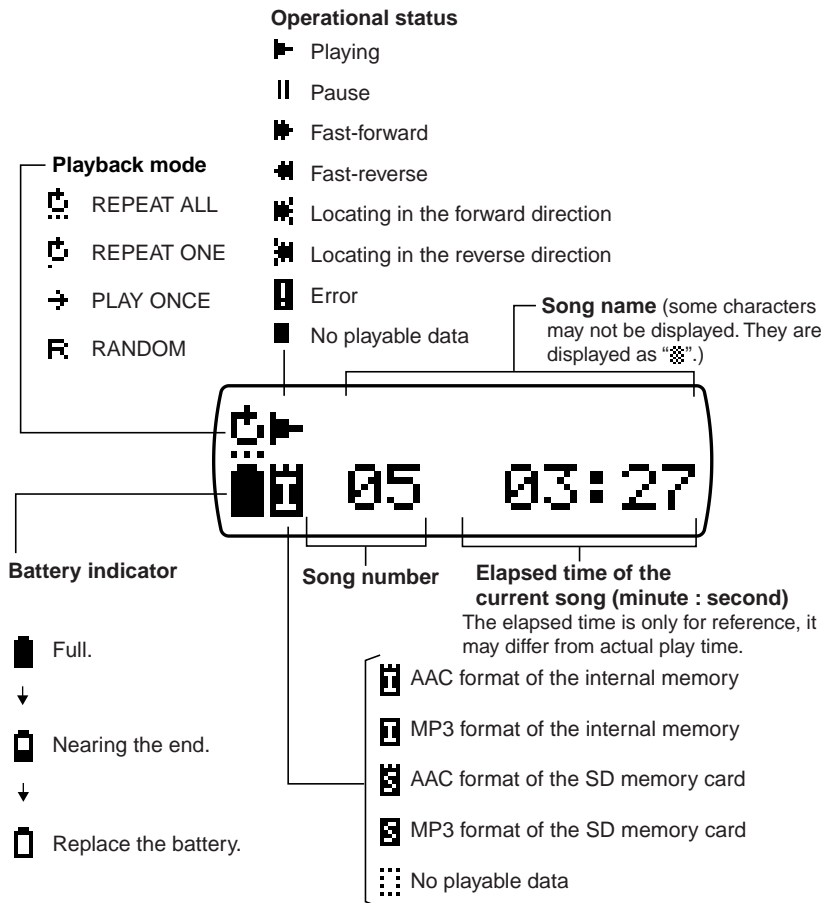

## **LIMITED WARRANTY DIGITAL AUDIO PLAYER**

Toshiba America Consumer Products, Inc. ("TACP") and Toshiba Hawaii, Inc. ("THI") make the following limited warranties. These limited warranties extend to original consumer purchaser or any person receiving this set as a gift from the original consumer purchaser and to no other purchaser or transferee.

### **Limited Ninety (90) Day Warranty**

TACP/ THI warrants this product against defects in materials or workmanship for a period of ninety (90) days after the date of original retail purchase. During this period, TACP/THI will repair a defective product or part, without charge to you. You must deliver the entire product to a TACP/THI Authorized Service Station. You are responsible for all transportation and insurance charges for the unit to and from the Authorized Service Station.

### **Limited One (1) Year Warranty**

TACP/THI further warrant the parts in this product against defects in materials or workmanship for a period of one (1) year after the date of original retail purchase. During this period, TACP/THI will repair or replace a defective unit, without charge to you, except that if a defective unit is replaced after ninety (90) days from the date of the original retail purchase you pay labor charges involved in the replacement. You must also deliver the entire product to a TACP/THI Authorized Service Station. You are responsible for all transportation and insurance charges for the unit to and from the Authorized Service Station.

### **Rental Units**

The warranty for rental units begin with the first rental or thirty (30) days from the date of shipment to the rental firm, whichever comes first.

### **Commercial Units**

Products sold and used for commercial use have a limited ninety (90) day warranty for all parts and labor.

### **Owner's Manual**

You should read the owner's manual thoroughly before operating this product. You should complete and mail the enclosed Demographic card within ten (10) days after you, or the person who has given you this product as a gift, purchased this product. This is one way to enable TACP to provide you with better customer service and improved products. Failure to return the card will not affect your rights under this warranty.

## Your Responsibility

The above warranties are subject to the following conditions:

- (1) You must retain your bill of sale or provide other proof of purchase.
- (2) You must notify a TACP/THI/TCL Authorized Service Station within thirty (30) days after you discover a defective product or part.
- (3) All warranty servicing of this product must be made by a TACP/THI/TCL Authorized Service Station.
- (4) U.S.A. warranties are effective only if the product is purchased and operated in the Continental U.S.A. or Puerto Rico.
- (5) Labor service charges for set installation. Set up, adjustment of customer controls and installation or repair of antenna systems are not covered by this warranty. Reception problems caused by inadequate antenna systems are your responsibility.
- (6) Warranties extend only to defects in materials or workmanship as limited above and do not extend to any product or parts which have been lost or discarded by you or to damage to products or parts caused by misuse, accident, damage caused by Acts of God, such as lightning or fluctuations in electric power, improper installation, improper maintenance or use in violation of instructions furnished by us; or to units which have been altered or modified without authorization of TACP/THI/TCL or to damage to products or part thereof which have had the serial number removed, altered, defaced or rendered illegible.
- (7) Physically damaged products are not acceptable for repair or exchange whether in or out of warranty and will be returned as received.

## How to Obtain Service

- (1) Refer to the troubleshooting guide in your owner's manual. This checklist may solve your problem or check our web site at **WWW.TOSHIBA.COM/TACP**.
- (2) Products shipped to the Service Station must be insured and safely and securely packed, preferably in the original shipping carton, and a letter explaining the defect and a copy of the bill of sale or other proof of purchase must be enclosed.

### In United States contact:

Toshiba America Consumer Product Inc.

(800) 631-3811

### In Hawaii contact:

Toshiba Hawaii, Inc.

327 Kamakee St  
Honolulu, HI 96814

(808) 521-5377

### In Canada contact:

Consumer Electronics Group

191 McNabb St

Markham, Ontario L3R 8H2

(905) 470-5400

Consumer Electronics Group

22171 Fraserwood Way

Richmond, B.C. V6w 1J5

(604) 303-2500

Consumer Electronics Group

1643 North Service Rd

Dorval, QC H9P 1J1

(514) 856-4100

All warranties implied by state law, including the implied warranties of merchantability and fitness for a particular purpose, are expressly limited to the duration of the limited warranties set forth above. With the exception of any warranties implied by state law as hereby limited, the foregoing warranty is exclusive and in lieu of all other warranties, guarantees, agreements and similar obligations of manufacturer or seller with respect to the repair or replacement of any parts. In no event shall TACP/ THI be liable for consequential or incidental damages.

No person, agent, distributor, dealer, or company is authorized to change, modify, or extend the terms of these warranties in any manner whatsoever. The time within which an action must be commenced to enforce any obligation of TACP/THI arising under the warranty or under any statute, or law of the United States or any state thereof, is hereby limited to ninety (90) days from the date you discover or should have discovered, the defect. This limitation does not apply to implied warranties arising under state law. This warranty gives you specific legal rights and you may have other rights, which may vary from state to state. Some states do not allow limitation on how long an implied warranty lasts, when an action may be brought, or the exclusion or limitation of incidental or consequential damages, so the above provisions may not apply to you.

**ATTENTION CANADIAN CONSUMERS: (Toshiba Canada "TCL")**

Canadian consumers are requested to complete the special Canadian "Warranty Registration Form" enclosed, and forward this completed form with a copy of bill of sale to TOSHIBA OF CANADA to "Register and Validate" their warranty. Product must be purchased from an Authorized Canadian Dealer.

**IMPORTANT: PACKING AND SHIPPING INSTRUCTION**

When you send the product to a Service Station, you must use the original carton box and packing material, and then insert the original carton box containing the unit into another carton, using more packing material.

**Products purchased in the U.S.A. and used in Canada are not covered by these warranties.**

**Products purchased in Canada and used in the U.S.A. are not covered by these warranties.**



## Free Manuals Download Website

<http://myh66.com>

<http://usermanuals.us>

<http://www.somanuals.com>

<http://www.4manuals.cc>

<http://www.manual-lib.com>

<http://www.404manual.com>

<http://www.luxmanual.com>

<http://aubethermostatmanual.com>

Golf course search by state

<http://golfingnear.com>

Email search by domain

<http://emailbydomain.com>

Auto manuals search

<http://auto.somanuals.com>

TV manuals search

<http://tv.somanuals.com>