

TOSHIBA
Satellite A300/
Satellite Pro A300/
Satellite A300D/
Satellite Pro A300D series
User's Manual

Copyright

© 2008 by TOSHIBA Corporation. All rights reserved. Under the copyright laws, this manual cannot be reproduced in any form without the prior written permission of TOSHIBA. No patent liability is assumed, with respect to the use of the information contained herein.

TOSHIBA Satellite A300/Satellite Pro A300/Satellite A300D/Satellite Pro A300D series Portable Personal Computer User's Manual

First edition April 2008

Copyright authority for music, movies, computer programs, data bases and other intellectual property covered by copyright laws belongs to the author or to the copyright owner. Copyrighted material can be reproduced only for personal use or use within the home. Any other use beyond that stipulated above (including conversion to digital format, alteration, transfer of copied material and distribution on a network) without the permission of the copyright owner is a violation of copyright or author's rights and is subject to civil damages or criminal action. Please comply with copyright laws in making any reproduction from this manual.

Disclaimer

This manual has been validated and reviewed for accuracy. The instructions and descriptions it contains are accurate for the TOSHIBA Satellite A300/Satellite Pro A300/Satellite A300D/Satellite Pro A300D series Portable Personal Computer at the time of this manual's production. However, succeeding computers and manuals are subject to change without notice. TOSHIBA assumes no liability for damages incurred directly or indirectly from errors, omissions or discrepancies between the computer and the manual.

Trademarks

IBM is a registered trademark, and IBM PC and PS/2 are trademarks of International Business Machines Corporation.

Intel, Intel SpeedStep and Intel Core and Centrino are trademarks or registered trademarks of Intel Corporation or its subsidiaries in the United States and other countries/regions.

AMD, the AMD Arrow logo, AMD Athlon, AMD Turion, Radeon, and combinations thereof, ATI Mobility Radeon are trademarks of Advanced Micro Devices, Inc.

Windows and Microsoft are registered trademarks and Windows Vista is a trademark of Microsoft Corporation.

Photo CD is a trademark of Eastman Kodak.

Memory Stick is a registered trademark and i.LINK is a trademark of Sony-Corporation.

Bluetooth™ is a registered trademark owned by its proprietor and used by TOSHIBA under license.

DVD MovieFactory is a trademark of Ulead Systems Inc.

Labelflash™ is a trademark of YAMAHA CORPORATION.

Manufactured under license from Dolby Laboratories. "Dolby" and the double-D symbol are trademarks of Dolby Laboratories. Confidential unpublished works. Copyright 1992-1997 Dolby Laboratories. All rights reserved.

Manufactured under license from Digital Theater Systems, Inc. U.S. Pat. No's. 5,451,942; 5,956,674; 5,974,380; 5,978,762; 6,226,616; 6,487,535 and other U.S. and world-wide patents issued and pending. "DTS" and "DTS Digital Surround" are registered trademarks of Digital Theater Systems, Inc. Copyright 1996, 2003 Digital Theater Systems, Inc. All Rights Reserved.

Other trademarks and registered trademarks not listed above may be used in this manual.

Macrovision License of Notice

For DVD Manufacturing License Agreement

This product incorporates copyright protection technology that is protected by U.S. patents and other intellectual property rights. Use of this copyright protection technology must be authorized by Macrovision, and is intended for home and other viewing uses only unless otherwise authorized by Macrovision. Reverse engineering or disassembly is prohibited. The copyright protection technology availability depends on the model you purchased.

For RTLA (Restricted Technology License Agreement)

This product incorporates copyright protection technology that is protected by U.S. patents and foreign patents, including patent numbers 5,315,448 and 6,836,549, and other intellectual property rights. The use of Macrovision's copy protection technology in the product must be authorized by Macrovision. Reverse engineering or disassembly is prohibited. The copyright protection technology availability depends on the model you purchased.

Safety instructions

Use the following safety guidelines to help to protect yourself and your computer.

When using your computer



Do not operate your portable computer for an extended period of time with the base resting directly on your body. With extended operation, heat can potentially build up in the base. Allowing sustained contact with the skin could cause discomfort or, eventually, a burn.

- Do not attempt to service the computer yourself. Always follow installation instructions closely.
- Do not carry a battery in your pocket, purse, or other container where metal objects (such as car keys) could short-circuit the battery terminals. The resulting excessive current flow can cause extremely high temperatures and may result in damage from burns.
- Be sure that nothing rests on your AC adaptor's power cable and that the cable is not located where it can be tripped over or stepped on.
- Place the AC adaptor in a ventilated area, such as a desk top or on the floor, when you use it to run the computer or to charge the battery. Do not cover the AC adaptor with papers or other items that will reduce cooling; also, do not use the AC adaptor while it is inside a carrying case.
- Use only the AC adaptor and batteries that are approved for use with this computer. Use of another type of battery or AC adaptor may risk fire or explosion.
- Before you connect the computer to a power source, ensure that the voltage rating of the AC adaptor matches that of the available power source. 115 V/60 Hz in most of North and South America and some Far Eastern countries such as Taiwan. 100 V/50 Hz in eastern Japan and 100 V/60 Hz in western Japan. 230 V/50 Hz in most of Europe, the Middle East, and the Far East.
- If you use an extension cable with your AC adaptor, ensure that the total ampere rating of the products plugged in to the extension cable does not exceed the ampere rating of the extension cable.
- To remove power from the computer, turn it off, remove the battery, and disconnect the AC adaptor from the electrical outlet.
- To help avoid the potential hazard of electric shock, do not connect or disconnect any cables or perform maintenance or reconfiguration of this product during an electrical storm.
- When setting up the computer for work, place it on a level surface.

FCC information

FCC notice “Declaration of Conformity Information”

This equipment has been tested and found to comply with the limits for a Class B digital device, pursuant to part 15 of the FCC rules. These limits are designed to provide reasonable protection against harmful interference in a residential installation. This equipment generates, uses and can radiate radio frequency energy and, if not installed and used in accordance with the instructions, may cause harmful interference to radio communications. However, there is no guarantee that interference will not occur in a particular installation. If this equipment does cause harmful interference to radio or television reception, which can be determined by turning the equipment off and on, the user is encouraged to try to correct the interference by one or more of the following measures:

- Reorient or relocate the receiving antenna.
- Increase the separation between the equipment and receiver.
- Connect the equipment into an outlet on a circuit different from that to which the receiver is connected.
- Consult the dealer or an experienced radio/TV technician for help.



Only peripherals complying with the FCC class B limits may be attached to this equipment. Operation with non-compliant peripherals or peripherals not recommended by TOSHIBA is likely to result in interference to radio and TV reception. Shielded cables must be used between the external devices and the computer's external monitor port, USB port, and microphone jack. Changes or modifications made to this equipment, not expressly approved by TOSHIBA or parties authorized by TOSHIBA could void the user's authority to operate the equipment.

FCC conditions

This device complies with part 15 of the FCC Rules. Operation is subject to the following two conditions:

1. This device may not cause harmful interference.
2. This device must accept any interference received, including interference that may cause undesired operation.

Contact

Address: TOSHIBA America Information Systems, Inc.
9740 Irvine Boulevard
Irvine, California 92618-1697
Telephone: (949) 583-3000

EU Declaration of Conformity



Supplementary Information: The product complies with the requirements Of the Low Voltage Directive 2006/95/EC, the EMC Directive 2004/108/EC and/or the R&TTE Directive 1999/5/EC.”

This product is carrying the CE-Mark in accordance with the related European Directives. Responsible for CE-Marking is TOSHIBA Europe, Hammfelddamm 8, 41460 Neuss, Germany.

VCCI Class B information

この装置は、情報処理装置等電波障害自主規制協議会（VCCI）の基準に基づくクラスB情報技術装置です。この装置は、家庭環境で使用することを目的としていますが、この装置がラジオやテレビジョン受信機に近接して使用されると、受信障害を引き起こすことがあります。
取扱説明書に従って正しい取り扱いをして下さい。

Canadian regulatory information (Canada only)

This digital apparatus does not exceed the Class B limits for radio noise emissions from digital apparatus as set out in the Radio Interference Regulation of the Canadian Department of Communications.

Note that Canadian Department of Communications (DOC) regulations provide, that changes or modifications not expressly approved by TOSHIBA Corporation could void your authority to operate this equipment.

This Class B digital apparatus meets all requirements of the Canadian Interference-Causng Equipment Regulations.

Cet appareil numérique de la class B respecte toutes les exgences du Règlement sur le matériel brouilleur du Canada.

Modem warning notice

Conformity statement

The equipment has been approved to [Commission Decision “CTR21”] for pan-European single terminal connection to the Public Switched Telephone Network (PSTN).

However, due to differences between the individual PSTNs provided in different countries/regions the approval does not, of itself, give an unconditional assurance of successful operation on every PSTN network termination point.

In the event of problems, you should contact your equipment supplier in the first instance.

Network compatibility statement

This product is designed to work with, and is compatible with the following networks. It has been tested to and found to conform with the additional requirements conditional in EG 201 121.

Germany	ATAAB AN005,AN006,AN007,AN009,AN010 and DE03,04,05,08,09,12,14,17
Greece	ATAAB AN005,AN006 and GR01,02,03,04
Portugal	ATAAB AN001,005,006,007,011 and P03,04,08,10
Spain	ATAAB AN005,007,012, and ES01
Switzerland	ATAAB AN002
All other countries/regions	ATAAB AN003,004

Specific switch settings or software setup is required for each network, please refer to the relevant sections of the user guide for more details.

The hookflash (timed break register recall) function is subject to separate national type approvals. It has not been tested for conformity to national type regulations, and no guarantee of successful operation of that specific function on specific national networks can be given.

Japan regulations

Region selection

If you are using the computer in Japan, technical regulations described in the Telecommunications Business Law require that you select the Japan region mode. It is illegal to use the modem in Japan with any other selection.

Redial

Up to two redial attempts can be made. If more than two redial attempts are made, the modem will return `Black Listed`. If you are experiencing problems with the `Black Listed` code, set the interval between redials at one minute or longer.

Japan's Telecommunications Business Law permits up to two redials on analogue telephones, but the redials must be made within a total of three minutes.

The internal modem is approved by Japan Approvals Institute for Telecommunications Equipment.



A05-0413001
A05-0025001
A05-5016201

Pursuant to FCC CFR 47, Part 68:

When you are ready to install or use the modem, call your local telephone company and give them the following information:

- The telephone number of the line to which you will connect the modem
- The registration number that is located on the device.

US: AGSMD01BDELPHI

S56MD01B13054

CXSMM01BRD02D330

The FCC registration number of the modem will be found on either the device which is to be installed, or, if already installed, on the bottom of the computer outside of the main system label.

- The Ringer Equivalence Number (REN) of the modem, which can vary. For the REN of your modem, refer to your modem's label.

The modem connects to the telephone line by means of a standard jack called the USOC RJ11C.

Type of service

Your modem is designed to be used on standard-device telephone lines. Connection to telephone company-provided coin service (central office implemented systems) is prohibited. Connection to party lines service is subject to state tariffs. If you have any questions about your telephone line, such as how many pieces of equipment you can connect to it, the telephone company will provide this information upon request.

Telephone company procedures

The goal of the telephone company is to provide you with the best service it can. In order to do this, it may occasionally be necessary for them to make changes in their equipment, operations, or procedures. If these changes might affect your service or the operation of your equipment, the telephone company will give you notice in writing to allow you to make any changes necessary to maintain uninterrupted service.

If problems arise

If any of your telephone equipment is not operating properly, you should immediately remove it from your telephone line, as it may cause harm to the telephone network. If the telephone company notes a problem, they may temporarily discontinue service. When practical, they will notify you in advance of this disconnection. If advance notice is not feasible, you will be notified as soon as possible. When you are notified, you will be given the opportunity to correct the problem and informed of your right to file a complaint with the FCC. In the event repairs are ever needed on your modem, they should be performed by TOSHIBA Corporation or an authorized representative of TOSHIBA Corporation.

Disconnection

If you should ever decide to permanently disconnect your modem from its present line, please call the telephone company and let them know of this change.

Fax branding

The Telephone Consumer Protection Act of 1991 makes it unlawful for any person to use a computer or other electronic device to send any message via a telephone fax machine unless such message clearly contains in a margin at the top or bottom of each transmitted page or on the first page of the transmission, the date and time it is sent and an identification of the business, other entity or individual sending the message and the telephone number of the sending machine or such business, other entity or individual. In order to program this information into your fax modem, you should complete the setup of your fax software before sending messages.



Use only No. 26 AWG or larger telecommunication line cord.

Instructions for IC CS-03 certified equipment

- 1 The Industry Canada label identifies certified equipment. This certification means that the equipment meets certain telecommunications network protective, operational and safety requirements as prescribed in the appropriate Terminal Equipment Technical Requirements document(s). The Department does not guarantee the equipment will operate to the user's satisfaction.

Before installing this equipment, users should ensure that it is permissible to be connected to the facilities of the local telecommunications company. The equipment must also be installed using an acceptable method of connection.

The customer should be aware that compliance with the above conditions may not prevent degradation of service in some situations. Repairs to certified equipment should be coordinated by a representative designated by the supplier. Any repairs or alterations made by the user to this equipment, or equipment malfunctions, may give the telecommunications company cause to request the user to disconnect the equipment.

Users should ensure for their own protection that the electrical ground connections of the power utility, telephone lines and internal metallic water pipe system, if present, are connected together. This precaution may be particularly important in rural areas.



Users should not attempt to make such connections themselves, but should contact the appropriate electric inspection authority, or electrician, as appropriate.

-
- 2** The user manual of analog equipment must contain the equipment's Ringer Equivalence Number (REN) and an explanation notice similar to the following:
- The Ringer Equivalence Number (REN) of the modem, which can vary. For the REN of your modem, refer to your modem's label.



The Ringer Equivalence Number (REN) assigned to each terminal device provides an indication of the maximum number of terminals allowed to be connected to a telephone interface. The termination on an interface may consist of any combination of devices subject only to the requirement that the sum of the Ringer Equivalence Numbers of all the devices does not exceed 5.

- 3** The standard connecting arrangement (telephone jack type) for this equipment is jack type(s): USOC RJ11C.

The IC registration number of the modem is shown below.

Canada: 4005B-DELPHI
109AH-ML3054
3652B-RD02D330

Notes for users in Australia and New Zealand

Modem warning notice for Australia

Modems connected to the Australian telecoms network must have a valid Austel permit. This modem has been designed to specifically configure to ensure compliance with Austel standards when the country/region selection is set to Australia. The use of other country/region setting while the modem is attached to the Australian PSTN would result in you modem being operated in a non-compliant manner. To verify that the country/region is correctly set, enter the command ATI which displays the currently active setting.

To set the country/region permanently to Australia, enter the following command sequence:

```
AT%TE=1
ATS133=1
AT&F
AT&W
AT%TE=0
ATZ
```

Failure to set the modem to the Australia country/region setting as shown above will result in the modem being operated in a non-compliant manner. Consequently, there would be no permit in force for this equipment and the Telecoms Act 1991 prescribes a penalty of \$12,000 for the connection of non-permitted equipment.

Notes for use of this device in New Zealand

- The grant of a Telepermit for a device in no way indicates Telecom acceptance of responsibility for the correct operation of that device under all operating conditions. In particular the higher speeds at which this modem is capable of operating depend on a specific network implementation which is only one of many ways of delivering high quality voice telephony to customers. Failure to operate should not be reported as a fault to Telecom.
- In addition to satisfactory line conditions a modem can only work properly if:
 - (a) it is compatible with the modem at the other end of the call and
 - (b) the application using the modem is compatible with the application at the other end of the call - e.g., accessing the Internet requires suitable software in addition to a modem.
- This equipment shall not be used in any manner which could constitute a nuisance to other Telecom customers.
- Some parameters required for compliance with Telecom's PTC Specifications are dependent on the equipment (PC) associated with this modem. The associated equipment shall be set to operate within the following limits for compliance with Telecom Specifications:
 - (a) There shall be no more than 10 call attempts to the same number within any 30 minute period for any single manual call initiation, and
 - (b) The equipment shall go on-hook for a period of not less than 30 seconds between the end of one attempt and the beginning of the next.
 - (c) Automatic calls to different numbers shall be not less than 5 seconds apart.
- Immediately disconnect this equipment should it become physically damaged, and arrange for its disposal or repair.
- The correct settings for use with this modem in New Zealand are as follows:
 - ATB0 (CCITT operation)
 - AT&G2 (1800 Hz guard tone)
 - AT&P1 (Decadic dialing make-break ratio = 33%/67%)
 - ATS0=0 (not auto answer)
 - ATS10=less than 150 (loss of carrier to hangup delay, factory default of 15 recommended)
 - ATS11=90 (DTMF dialing on/off duration=90 ms)
 - ATX2 (Dial tone detect, but not (U.S.A.) call progress detect)
- When used in the Auto Answer mode, the S0 register must be set with a value of 3 or 4. This ensures:

-
- (a) a person calling your modem will hear a short burst of ringing before the modem answers. This confirms that the call has been successfully switched through the network.
 - (b) caller identification information (which occurs between the first and second ring cadences) is not destroyed.

- The preferred method of dialing is to use DTMF tones (ATDT...) as this is faster and more reliable than pulse (decadic) dialing. If for some reason you must use decadic dialing, your communications program must be set up to record numbers using the following translation table as this modem does not implement the New Zealand "Reverse Dialing" standard.

Number to be dialed: 0 1 2 3 4 5 6 7 8 9

Number to program into computer: 0 9 8 7 6 5 4 3 2 1

Note that where DTMF dialing is used, the numbers should be entered normally.

- The transmit level from this device is set at a fixed level and because of this there may be circumstances where the performance is less than optimal. Before reporting such occurrences as faults, please check the line with a standard Telepermitted telephone, and only report a fault if the phone performance is impaired.
- It is recommended that this equipment be disconnected from the Telecom line during electrical storms.
- When relocating the equipment, always disconnect the Telecom line connection before the power connection, and reconnect the power first.
- This equipment may not be compatible with Telecom Distinctive Alert cadences and services such as FaxAbility.

NOTE THAT FAULT CALLOUTS CAUSED BY ANY OF THE ABOVE CAUSES MAY INCUR A CHARGE FROM TELECOM

General conditions

As required by PTC 100, please ensure that this office is advised of any changes to the specifications of these products which might affect compliance with the relevant PTC Specifications.

The grant of this Telepermit is specific to the above products with the marketing description as stated on the Telepermit label artwork. The Telepermit may not be assigned to other parties or other products without Telecom approval.

A Telepermit artwork for each device is included from which you may prepare any number of Telepermit labels subject to the general instructions on format, size and colour on the attached sheet.

The Telepermit label must be displayed on the product at all times as proof to purchasers and service personnel that the product is able to be legitimately connected to the Telecom network.

The Telepermit label may also be shown on the packaging of the product and in the sales literature, as required in PTC 100.

The charge for a Telepermit assessment is \$337.50. An additional charge of \$337.50 is payable where an assessment is based on reports against non-Telecom New Zealand Specifications. \$112.50 is charged for each variation when submitted at the same time as the original.

An invoice for \$NZ1237.50 will be sent under separate cover.

Following information is only for EU-member States



The symbol indicates that this product may not be treated as household waste. Please ensure this product is properly disposed as inappropriate waste handling of this product may cause potential hazards to the environment and human health.

For more detailed information about recycling of this product, please contact your local city office, your household waste disposal service or the shop where you purchased the product.



This symbol may not be displayed depending on the country and region where you purchased.

ENERGY STAR® Program



Your computer model may be ENERGY STAR® Compliant. If the model you purchased is compliant, it is labeled with the ENERGY STAR® logo on the computer and the following information applies.

TOSHIBA is a partner in the Environmental Protection Agency's (EPA) ENERGY STAR® Program and has designed this computer to meet the latest ENERGY STAR® guidelines for energy efficiency. Your computer ships with the power management options preset to a configuration that will provide the most stable operating environment and optimum system performance for both AC power and battery modes.

To conserve energy, your computer is set to enter the low-power Sleep mode which shuts down the system and display within 15 minutes of inactivity in AC power mode. We recommend that you leave this and other energy saving features active, so that your computer will operate at its maximum energy efficiency. You can wake the computer from Sleep mode by pressing the power button.

According to the EPA, a computer meeting the new ENERGY STAR® specifications will use between 20% and 50% less energy depending on how it is used. If all U.S. household and businesses replaced old computers with new ENERGY STAR® qualified models, we would save more than \$1.8 billion in energy costs over the next five years and avoid greenhouse gas emissions equivalent to more than 2.7 million cars.

If every computer purchased by businesses next year met the new ENERGY STAR® requirements, businesses would save more than \$210 million over the lifetime of those models. That is equivalent to lighting 120 million square feet of U.S. commercial building space each year.

Visit <http://www.energystar.gov> or <http://www.energystar.gov/powermanagement> for more information regarding the ENERGY STAR® Program.

Optical disc drive standards

TOSHIBA Satellite A300/Satellite Pro A300/Satellite A300D/Satellite Pro A300D series computer is shipped with one of the following drives preinstalled: DVD Super Multi (+-R DL) drive or DVD Super Multi (+-R DL) /w Label Flash drive.

The drive has one of the following labels:

CLASS 1 LASER PRODUCT

LASER KLASSE 1

LUOKAN 1 LASERLAITE

APPAREIL A LASER DE CLASSE1

KLASS 1 LASER APPARAT

Before it is shipped, the Class 1 Laser is certified to meet the United States Chapter 21 Standards of the Department of Health and Human Services (DHHS 21 CFR).

For any other country, the drive is certified to meet the Class 1 Laser standards of IEC825 and EN60825.

Optical disc drive safety instructions



- *The drive employs a laser system. To ensure proper use of this product, please read this instruction manual carefully and retain for future reference. Should the unit ever require maintenance, contact an authorized service location.*
- *Use of controls, adjustments or the performance of procedures other than those specified may result in hazardous radiation exposure*
- *To prevent direct exposure to the laser beam, do not try to open the enclosure.*

DVD Super Multi (+-R DL) drive

Panasonic UJ-870B/UJ-870F/UJ870AB/UJ870EB

Location of the required label

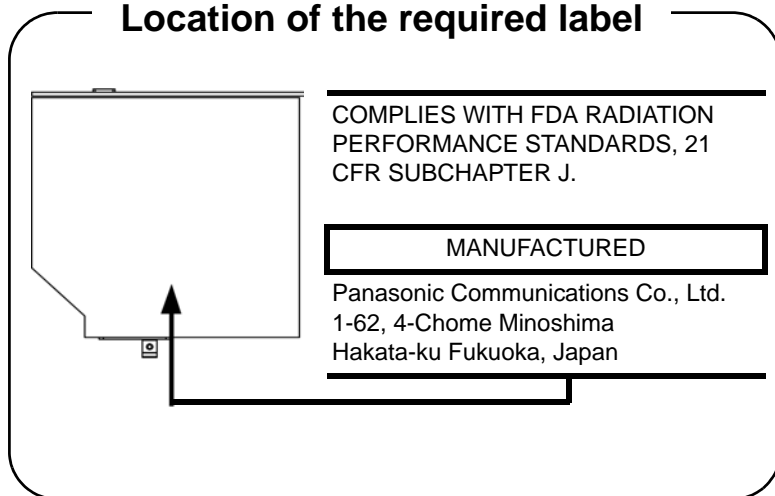

HLDS GSA-T40N/GSA-T40F/GSA-T50N/GSA-T50F

Location of the required label

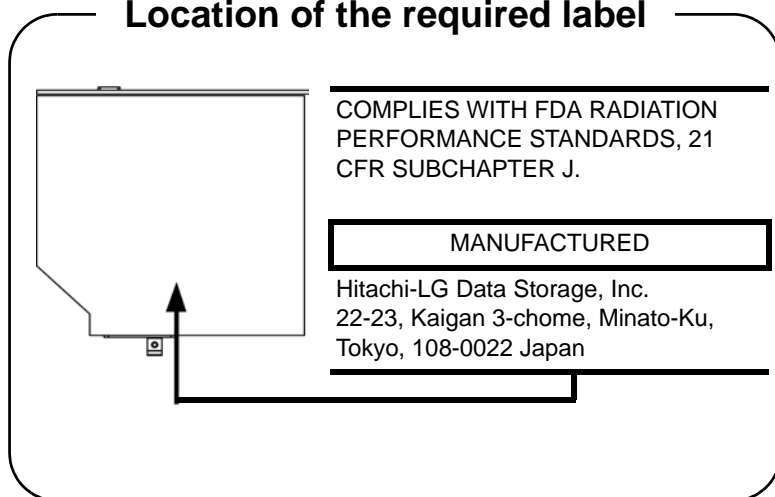

Pioneer DVR-KD08TBM/DVR-KD08TBF/DVR-TD08TBM/DVR-TD08TBF

Location of the required label

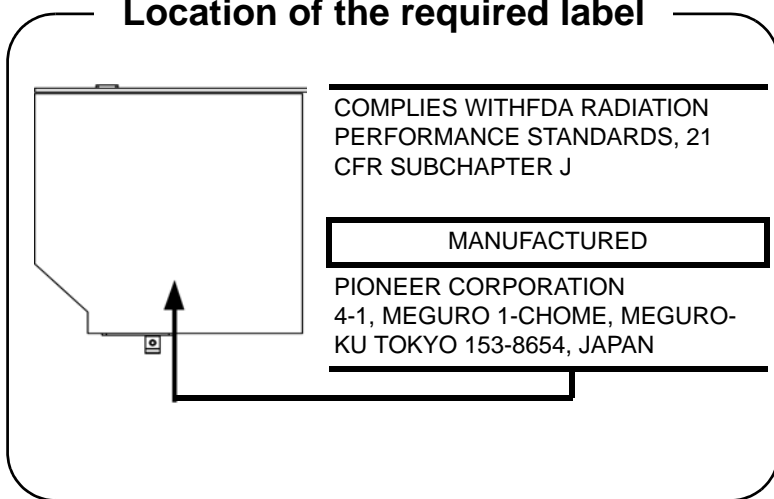

Toshiba Samsung TS-L632H/TS-L632P/TS-L633A/TS-L633P

Location of the required label

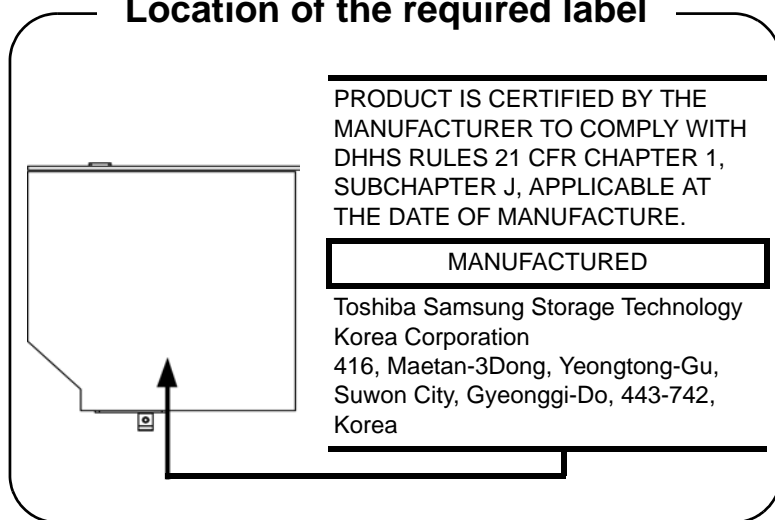

International precautions

CLASS 1 LASER PRODUCT
LASER KLASSE 1 PRODUKT
TO EN 60825-1
クラス1レーザ製品

CLASS 1 LASER PRODUCT
LASERSCHUTZKLASSE 1
PRODUKT
TO EN60825

ADVERSEL: USYNLIG
LASERSTRÅLING VED ÅBNING,
NÅR SIKKERHEDSAF-BRYDER
ER UDE AF FUNKTION.
UNDGÅ UDSÆTTELSE FOR
STRÅLING

CAUTION: This appliance contains a laser system and is classified as a "CLASS 1 LASER PRODUCT." To use this model properly, read the instruction manual carefully and keep this manual for your future reference. In case of any trouble with this model, please contact your nearest "AUTHORIZED service station." To prevent direct exposure to the laser beam, do not try to open the enclosure.

VORSICHT: Dieses Gerät enthält ein Laser-System und ist als "LASERSCHUTZKLASSE 1 PRODUKT" klassifiziert. Für den richtigen Gebrauch dieses Modells lesen Sie bitte die Bedienungsanleitung sorgfältig durch und bewahren diese bitte als Referenz auf. Falls Probleme mit diesem Modell auftreten, benachrichtigen Sie bitte die nächste "autorisierte Service-Vertretung". Um einen direkten Kontakt mit dem Laserstrahl zu vermeiden darf das Gerät nicht geöffnet werden.

ADVARSEL: Denne mærkning er anbragt udvendigt på apparatet og indikerer, at apparatet arbejder med laserstråler af klasse 1, hvilket betyder, at der anvendes laserstråler af svageste klasse, og at man ikke på apparatets yderside kan blive udsat for utilsadellig kraftig stråling.

APPARATET BOR KUN ÅBNES AF
FAGFOLK MED SÆRLIGT KENDSKAB
TIL APPARATER MED
LASERSTRÅLER!

Indvendigt i apparatet er anbragt den her gengivne advarselsmærkning, som advarer imod at foretage sådanne indgreb i apparatet, at man kan komme til at udsatte sig for laserstråling.

OBS! Apparaten innehåller laserkomponent som avger laserstråling överstigande gränsen för laserklass 1.

VAROITUS. Suojakoteloä si saa avata. Laite sisältää laseriodin, joka lähettää näkymätöntä silmilie vaarallista lasersäteilyä.

CAUTION: USE OF CONTROLS OR ADJUSTMENTS OR PERFORMANCE OF PROCEDURES OTHER THAN THOSE SPECIFIED IN THE OWNER'S MANUAL MAY RESULT IN HAZARDOUS RADIATION EXPOSURE.

VORSICHT: DIE VERWENDUNG VON ANDEREN STEUERUNGEN ODER EINSTELLUNGEN ODER DAS DURCHFÜHREN VON ANDEREN VORGÄNGEN ALS IN DER BEDIENUNGSANLEITUNG BESCHRIEBEN KÖNNEN GEFÄHRLICHE STRAHLENEXPOSITIONEN ZUR FOLGE HABEN.

Important notice

Copyrighted works including, but not limited to music, video, computer program, databases are protected by copyright laws. Unless specifically permitted under applicable copyright laws, you cannot copy, modify, assign, transmit or otherwise dispose of any copyrighted work with the consent of the owner of the copyright. Please take notice that unauthorized copying, modification, assignment, transmission and disposition may be subject to claims for damages and penalties.

- Avoid using a telephone (other than a cordless type) during an electrical storm. There may be a remote risk of electric shock from lightning.
- Do not use the telephone to report a gas leak in the vicinity of the leak.
- Use only the power cord indicated in this manual.
- Replace only with the same or equivalent type battery recommended by the manufacturer.
- Dispose of used batteries according to the manufacturer's instructions.



Use only the battery pack that came with the computer or an optional battery pack. Use of wrong battery could damage your computer.

TOSHIBA assumes no liability for any damage in such case.

Table of Contents

Preface

General Precautions

Chapter 1 Introduction

Equipment checklist	1-1
Hardware	1-1
Software	1-2
Documentation	1-3
Features	1-3
Processor	1-3
Memory	1-3
Disks	1-5
Keyboard	1-6
Pointing device	1-7
Power	1-7
Ports	1-7
Slots	1-8
Multimedia	1-8
Communications	1-8
Security	1-9
Software	1-9
Special features	1-10
TOSHIBA Value Added Package	1-12
Utilities and applications	1-13
Options	1-15

Chapter 2 The Grand Tour

Front with the display closed	2-1
Left side	2-3
Right side	2-5
Back side	2-6
Underside	2-7
Front with the display open	2-8
Function button	2-10
System indicators	2-11

Keyboard indicators	2-12
Optical disc drive	2-13
Region codes for DVD drives and media	2-13
Writable discs	2-13
DVD Super Multi (+-R DL) drive	2-14
Remote controller	2-14
Using the remote controller	2-20
Installing/Removing batteries	2-22
Placing slim size remote controller	2-26
AC adaptor	2-27

Chapter 3 **Getting Started**

Connecting the AC adaptor	3-2
Opening the display	3-3
Turning on the power	3-3
Starting up for the first time	3-4
Turning off the power	3-4
Shut down mode (Boot mode)	3-4
Hibernation mode	3-4
Sleep mode	3-6
Restarting the computer	3-7
System recovery options	3-8
System recovery options	3-8
Create optical recovery discs	3-8
Restoring the preinstalled software from the recovery HDD	3-9
Restoring the preinstalled software from your creating recovery media	3-9

Chapter 4 **Operating Basics**

Using the touchpad	4-1
Using the fingerprint sensor	4-2
How to swipe the finger	4-3
Points to note about the fingerprint sensor	4-3
Fingerprint sensor limitations	4-5
Points to note about the fingerprint utility	4-5
Set up procedure	4-5
How to delete the fingerprint data	4-6
Windows logon via fingerprint authentication	4-7
Fingerprint system boot authentication	4-7
Fingerprint Single-Swipe Sign-On feature	4-8
USB Sleep and Charge function	4-9
How to enable/disable USB sleep and charge function	4-10
Using optical disc drives	4-10
Loading discs	4-11
Removing discs	4-13

Function button	4-14
Writing CD/DVDs on DVD Super Multi (+-R DL) drive	4-15
Important message (DVD Super Multi (+-R DL) drive)	4-15
Before writing or rewriting	4-15
When writing or rewriting	4-17
Disclaimer (DVD Super Multi (+-R DL) drive)	4-18
TOSHIBA Disc Creator	4-18
Data verification	4-19
How to learn more about TOSHIBA Disc Creator	4-20
Video	4-20
When using Ulead DVD MovieFactory® for TOSHIBA	4-20
Media care	4-22
CD/DVD	4-22
Using the web camera	4-23
Using the software	4-24
Using the microphone	4-25
Using the TOSHIBA Face Recognition	4-25
Note on Use	4-25
Disclaimer	4-26
How to register the Face Recognition Data	4-26
How to Delete the Face Recognition Data	4-27
How to launch the help file	4-27
Windows Logon via TOSHIBA Face Recognition	4-28
Modem	4-29
Region selection	4-29
Properties menu	4-30
Connecting	4-30
Disconnecting	4-31
Using the FM tuner	4-31
Wireless communications	4-32
Wireless LAN	4-32
Bluetooth™ wireless technology	4-33
Wireless communication switch	4-33
LAN	4-34
Connecting LAN cable	4-34
Disconnecting LAN cable	4-35
Cleaning the computer	4-35
Moving the computer	4-36
Heat dispersal	4-36

Chapter 5 **The Keyboard**

Typewriter keys	5-1
Function keys: F1 ... F12	5-2
Soft keys: FN key combinations	5-2

Emulating keys on an enhanced keyboard	5-2
Hot keys	5-3
FN sticky key	5-5
Windows special keys	5-5
Keypad overlay	5-5
Turning on the overlays	5-6
Arrow mode	5-6
Numeric mode	5-6
Temporarily using normal keyboard (overlay on)	5-6
Temporarily using overlay (overlay off)	5-7
Temporarily changing modes	5-7
Generating ASCII characters	5-7

Chapter 6 **Power and Power-up Modes**

Power conditions	6-1
Power indicators	6-2
Battery indicator	6-2
DC IN indicator	6-3
Power indicator	6-3
Battery types	6-3
Battery	6-3
Real Time Clock battery	6-4
Care and use of the battery pack	6-5
Safety precautions	6-5
Charging the batteries	6-7
Monitoring battery capacity	6-9
Maximizing battery operating time	6-9
Retaining data with power off	6-10
Extending battery life	6-10
Replacing the battery pack	6-11
Removing the battery pack	6-11
Installing the battery pack	6-12
Starting the computer by password	6-13
Power-up modes	6-13
Windows utilities	6-13
Hot keys	6-13
Panel power on/off	6-14
System auto off	6-14

Chapter 7 **HW Setup and Passwords**

HW Setup	7-1
Accessing HW Setup	7-1
HW Setup window	7-1

Chapter 8 **Optional Devices**

Cards/Memory	8-1
Power devices.....	8-1
Peripheral devices	8-1
Other.....	8-1
ExpressCard	8-2
Installing an ExpressCard.....	8-2
Removing an ExpressCard.....	8-4
Multiple digital media card slot.....	8-5
Installing a SD/SDHC/MS/MS Pro/MMC/xD card.....	8-6
Removing a SD/SDHC/MS/MS Pro/MMC/xD card.....	8-7
Memory expansion.....	8-7
Installing memory module.....	8-8
Removing memory module.....	8-10
Additional battery pack (3 cell, 6 cell and 9 cell).....	8-11
Additional AC adaptor.....	8-11
USB FDD Kit.....	8-11
eSATA.....	8-11
External monitor.....	8-11
Television.....	8-12
HDMI.....	8-12
Setting for display video on HDMI.....	8-13
Settings for audio on HDMI.....	8-13
i.LINK (IEEE1394).....	8-14
Precautions.....	8-14
Connecting.....	8-15
Disconnecting.....	8-15
Security lock.....	8-15

Chapter 9 **Troubleshooting**

Problem solving process.....	9-1
Preliminary checklist.....	9-2
Analyzing the problem.....	9-2
Hardware and system checklist.....	9-3
System start-up.....	9-3
Self test.....	9-4
Power.....	9-4
Password.....	9-6
Keyboard.....	9-6
LCD panel.....	9-7
Hard disk drive.....	9-7
DVD Super Multi(+R DL) drive.....	9-8
Diskette drive.....	9-9
Infrared port.....	9-9
Pointing device.....	9-9

Fingerprint sensor	9-11
ExpressCard	9-12
SD/SDHC/MS/MS Pro/MMC/xD card	9-12
External monitor	9-12
Sound system	9-13
TV output signal	9-13
USB	9-14
USB Sleep and Charge function	9-14
eSATA/USB combo port	9-15
Modem	9-16
Sleep/Hibernation	9-17
LAN	9-17
Wireless LAN	9-18
Bluetooth	9-18
i.LINK (IEEE1394) device	9-19
Recovery discs	9-19
FM tuner	9-19
TOSHIBA support	9-20
Before you call	9-20
Where to write	9-21

Chapter 10 **Disclaimers**

CPU	10-1
Memory (main system)	10-2
Battery life	10-3
HDD drive capacity	10-3
LCD	10-3
Graphics Processor Unit (GPU)	10-3
Wireless LAN	10-4
Non-applicable icons	10-4
Copy protection	10-4
Images	10-4
LCD brightness and eye strain	10-4

Appendix A **Specifications**

Appendix B **Display Controller**

Appendix C **V.90/V.92**

Appendix D **Wireless LAN**

Appendix E **AC Power Cord and Connectors**

Glossary

Index

Preface

Congratulations on your purchase of the TOSHIBA Satellite A300/Satellite Pro A300/Satellite A300D/Satellite Pro A300D series computer. This powerful, lightweight notebook computer is designed to provide years of reliable, high-performance computing.

This manual tells you how to set up and begin using your Satellite A300/Satellite Pro A300/Satellite A300D/Satellite Pro A300D series computer. It also provides detailed information on configuring your computer, basic operations and care, using optional devices and troubleshooting.

If you are a new user of computers or if you're new to portable computing, first read over the *Introduction* and *The Grand Tour* chapters to familiarize yourself with the computer's features, components and accessory devices. Then read *Getting Started* for step-by-step instructions on setting up your computer.

If you are an experienced computer user, please continue reading the preface to learn how this manual is organized, then become acquainted with this manual by browsing through its pages. Be sure to read the *Special features* section of the Introduction, to learn about features that are uncommon or unique to the computers and carefully read *HW Setup and Passwords*. If you are going to install ExpressCards or connect external devices such as a printer, be sure to read Chapter 8, *Optional Devices*.

Manual contents

This manual is composed of the following chapters, appendixes, a glossary and an index.

Chapter 1, *Introduction*, is an overview of the computer's features, capabilities, and options.

Chapter 2, *The Grand Tour*, identifies the components of the computer and briefly explains how they function.

Chapter 3, *Getting Started*, provides a quick overview of how to begin operating your computer.

Chapter 4, *Operating Basics*, includes tips on care of the computer and on using the touchpad, the fingerprint sensor, optical disc drive, Audio/Video controls, the web camera, the microphone, the internal modem, the FM tuner, wireless communication and LAN.

Chapter 5, *The Keyboard*, describes special keyboard functions including the keypad overlay and hot keys.

Chapter 6, *Power and Power-up Modes*, gives details on the computer's power resources and battery save modes.

Chapter 7, *HW Setup and Passwords*, explains how to configure the computer using the HW Setup program. It also tells how to set a password.

Chapter 8, *Optional Devices*, describes the optional hardware available.

Chapter 9, *Troubleshooting*, provides helpful information on how to perform some diagnostic tests, and suggests courses of action if the computer doesn't seem to be working properly.

Chapter 10 *Disclaimers*, provides Legal Footnotes information related to your computer.

The *Appendixes* provide technical information about your computer.

The *Glossary* defines general computer terminology and includes a list of acronyms used in the text.

The *Index* quickly directs you to the information contained in this manual.

Conventions

This manual uses the following formats to describe, identify, and highlight terms and operating procedures.

Abbreviations

On first appearance, and whenever necessary for clarity, abbreviations are enclosed in parenthesis following their definition. For example: Read Only Memory (ROM). Acronyms are also defined in the *Glossary*.

Icons

Icons identify ports, dials, and other parts of your computer. The indicator panel also uses icons to identify the components it is providing information on.

Keys

The keyboard keys are used in the text to describe many computer operations. A distinctive typeface identifies the key top symbols as they appear on the keyboard. For example, **ENTER** identifies the Enter key.

Key operation

Some operations require you to simultaneously use two or more keys. We identify such operations by the key top symbols separated by a plus sign (+). For example, **CTRL + C** means you must hold down **CTRL** and at the same time press **C**. If three keys are used, hold down the first two and at the same time press the third.

ABC When procedures require an action such as clicking an icon or entering text, the icon's name or the text you are to type in is represented in the typeface you see to the left.

Display

ABC Names of windows or icons or text generated by the computer that appear on its display screen are presented in the typeface you see to the left.

Messages

Messages are used in this manual to bring important information to your attention. Each type of message is identified as shown below.



Pay attention! A caution informs you that improper use of equipment or failure to follow instructions may cause data loss or damage your equipment.



Please read. A note is a hint or advice that helps you make best use of your equipment.

Terminology

This term is defined in this document as follows:

Start The word “**Start**” refers to the “” button in Microsoft® Windows Vista™.

General Precautions

TOSHIBA computers are designed to optimize safety, minimize strain and withstand the rigors of portability. However, certain precautions should be observed to further reduce the risk of personal injury or damage to the computer.

Be certain to read the general precautions below and to note the cautions included in the text of the manual.

Creating a computer-friendly environment

Place the computer on a flat surface that is large enough for the computer and any other items you are using, such as a printer.

Leave enough space around the computer and other equipment to provide adequate ventilation. Otherwise, they may overheat.

To keep your computer in prime operating condition, protect your work area from:

- Dust, moisture, and direct sunlight.
- Equipment that generates a strong electromagnetic field, such as stereo speakers (other than speakers that are connected to the computer) or speakerphones.
- Rapid changes in temperature or humidity and sources of temperature change such as air conditioner vents or heaters.
- Extreme heat, cold, or humidity.
- Liquids and corrosive chemicals.

Stress injury

Carefully read the *Instruction Manual for Safety and Comfort*. It contains information on the prevention of stress injuries to your hands and wrists that can be caused by extensive keyboard use.

Heat injury

- Avoid prolonged physical contact with the computer. If the computer is used for long periods, its surface can become very warm. While the temperature will not feel hot to the touch, if you maintain physical contact with the computer for a long time, for example if you rest the computer on your lap or if you keep your hands on the palm rest, your skin might suffer a low-heat injury.
- If the computer has been used for a long time, avoid direct contact with the metal plate supporting the various interface ports as this can become hot.
- The surface of the AC adaptor can become hot when in use but this condition does not indicate a malfunction. If you need to transport the AC adaptor, you should disconnect it and let it cool before moving it.
- Do not lay the AC adaptor on a material that is sensitive to heat as the material could become damaged.

Pressure or impact damage

Do not apply heavy pressure to the computer or subject it to any form of strong impact as this can damage the computer's components or otherwise cause it to malfunction.

ExpressCard overheating

Some ExpressCards can become hot during prolonged use which may result in errors or instability in the operation of the device in question. In addition, you should also be careful when you remove an ExpressCard that has been used for a long time.

Mobile phones

Please be aware that the use of mobile phones can interfere with the audio system. The operation of the computer will not be impaired in any way, but it is recommended that a minimum distance of 30cm is maintained between the computer and a mobile phone that is in use.

Instruction Manual for Safety and Comfort

All important information on the safe and proper use of this computer is described in the enclosed *Instruction Manual for Safety and Comfort*. Be sure to read it before using the computer.

Chapter 1

Introduction

This chapter provides an equipment checklist, and it identifies the computer's features, options and accessories.



Some of the features described in this manual may not function properly if you use an operating system that was not preinstalled by TOSHIBA.

Equipment checklist

Carefully unpack your computer. Save the box and packaging materials for future use.

Hardware

Check to make sure you have all the following items:

- Satellite A300/Satellite Pro A300/Satellite A300D/Satellite Pro A300D series Portable Personal Computer
- Universal AC adaptor and power cord
- Modular cable (Provided with some models)
- Remote controller (Provided with some models)
- Cleaning cloth (Provided with some models)
 - The computer includes a cleaning cloth which can be used to wipe away dust and fingerprints from the keyboard and palm rest area of your computer.



- *When wiping the keyboard, palm rest and display panel, do so gently without using excessive pressure.*
- *Do not use the cleaning cloth when it is dirty or wet.*
- *Do not use the cleaning cloth soaked with water, detergents or volatile organic solvents.*

- It is recommended to wash the cloth when getting soiled by using a gentle, mild detergent and rinse it well. Make the cloth air dry completely before using again on your computer.

Software

Microsoft® Windows Vista™

The following software is preinstalled:

- Microsoft® Windows Vista™
- Modem Driver (Can be used only for Modem models)
- Bluetooth Driver (Can be used only for Bluetooth models)
- Display Drivers for Windows
- Fingerprint utility (Can be used only for Fingerprint utility models)
- LAN Driver
- Pointing Device Driver
- Presto! BizCard 5 (Is preinstalled with some models)
- Sound Driver for Windows
- Ulead DVD MovieFactory® for TOSHIBA
- Wireless LAN driver (Can be used only for Wireless LAN models)
- TOSHIBA Assist
- TOSHIBA CD/DVD Drive Acoustic Silencer
- TOSHIBA ConfigFree
- TOSHIBA Disc Creator
- TOSHIBA DVD PLAYER
- TOSHIBA Face Recognition (Is preinstalled with some models)
- TOSHIBA SD Memory Utilities
- TOSHIBA User's Manual
- TOSHIBA Value Added Package



*SD Memory Card Format Utility and other SD functions are packaged into TOSHIBA SD Memory Utilities. When uninstalling the SD utilities, click **Start** → **Control Panel** → **Uninstall a program**, and select **TOSHIBA SD Memory Utilities**.*

Documentation

- *User Information Guide*
- *Instruction Manual for Safety and Comfort*
- *End User License Agreement*

Features

This computer incorporates the following features and benefits:

Processor

Built-in	Please visit your region's website for the configuration details of the model that you have purchased.
-----------------	--

Memory

Slots	PC2-5300 512MB, 1 GB or 2 GB memory modules can be installed in the two memory slots of all models.
--------------	---

PC2-6400 512MB, 1 GB, 2 GB or 4 GB memory modules can only be installed in the two memory slots of below models:

Mobile Intel® GM45 Express Chipset model/
 Mobile Intel® GL40 Express Chipset model/
 Mobile Intel® PM45 Express Chipset model/
 AMD M780G Chipset model/
 AMD M780V Chipset model/
 AMD M770 Chipset model.

Maximum system memory size and speed are depending on the model you purchased.



- *PC2-6400/PC2-5300 memory modules work as PC2-4200 speed on Mobile Intel® GL960 Express Chipset model.*
- *PC2-6400 memory module works as PC2-5300 speed on Mobile Intel® GL40/GM965 Express Chipset models.*

Video RAM

Depending on the model you purchased.

Mobile Intel® GM965 Express Chipset model/
Mobile Intel® GM45 Express Chipset model/
Mobile Intel® GL960 Express Chipset model/
Mobile Intel® GL40 Express Chipset model:
Video RAM capacity shares with main memory,
and the proportion depends on Dynamic Video
Memory Technology.

Mobile Intel® GM965 Express Chipset model/
Mobile Intel® GM45 Express Chipset model/
Mobile Intel® PM965 Express Chipset model/
Mobile Intel® PM45 Express Chipset model in
graphic chip by ATI Mobility Radeon™ HD 3470:
External 64/128/256 MB.

Mobile Intel® GM965 Express Chipset model/
Mobile Intel® GM45 Express Chipset model/
Mobile Intel® PM965 Express Chipset model/
Mobile Intel® PM45 Express Chipset model in
graphic chip by ATI Mobility Radeon™ HD 3650:
External 256/512 MB.

AMD M690G Chipset model/
AMD M780G Chipset model/
AMD M780V Chipset model:
Video RAM capacity shares with main memory,
and the proportion depends on ATI
HyperMemory™.

AMD M690G Chipset model/
AMD M780G Chipset model/
AMD M770 Chipset model in graphic chip by ATI
Mobility Radeon™ HD 3470:
External 64/128/256 MB.

AMD M690G Chipset model/
AMD M780G Chipset model/
AMD M770 Chipset model in graphic chip by ATI
Mobility Radeon™ HD 3650:
External 256/512 MB.

Disks

Hard disk drive (HDD)

The computer has one or two integrated, 2 1/2" hard disk drive(s) for nonvolatile storage of data and software (depending on the model you purchased). It comes in the following sizes.

- 80 GB
- 120 GB
- 160 GB
- 200 GB
- 250 GB
- 300 GB
- 320 GB
- 400 GB
- 500 GB

Disclaimer (Hard disk drive capacity)

For more information on the Disclaimer regarding Hard disk drive capacity, please refer to the [Disclaimers](#) section in Chapter 10.

DVD Super Multi (+-R DL) drive

Some models are equipped with a full-size DVD Super Multi (+- R DL) drive module that allows you to record data to rewritable CD/DVDs as well as run CD/DVDs without using an adaptor. It reads DVD-ROMs at maximum 8 speed and CD-ROMs at maximum 24 speed. It writes CD-R at up to 24 speed, CD-RW at up to 16 speed, DVD-R at up to 8 speed, DVD-RW at up to 6 speed, DVD-RAM at up to 5 speed, DVD+R at up to 8 speed, DVD+RW at up to 8 speed, DVD+R DL at up to 4 speed and DVD-R DL at up to 4 speed. This drive supports the following formats:

- DVD-ROM
- DVD-Video
- DVD-R
- DVD-RW
- DVD+R
- DVD+RW
- DVD-RAM
- DVD+R DL
- DVD-R DL
- CD-DA
- CD-Text
- CD-R
- CD-RW
- CD-ROM Mode 1, Mode 2
- CD-ROMXA Mode 2 (Form1, Form2)
- CD-G (Audio CD only)
- Photo CD (single/multi-session)
- Enhanced CD (CD-EXTRA)
- Addressing Method 2

Keyboard

Built-in

86 keys or 87 keys, compatible with IBM® enhanced keyboard, embedded numeric overlay, dedicated cursor control,  and  keys. See Chapter 5, [The Keyboard](#), for details.

Pointing device

Built-in	A touchpad and control buttons in the palm rest enable control of the on-screen pointer.
-----------------	--

Power

Battery pack	The computer is powered by one rechargeable lithium-ion battery pack.
RTC battery	The internal RTC battery backs up the Real Time Clock (RTC) and calendar.
AC adaptor	The universal AC adaptor provides power to the system and recharges the batteries when they are low. It comes with a detachable power cord. Because it is universal, it can receive a range of AC voltage between 100 and 240 volts.

Ports

Headphone	Enables connection of a stereo headphone.
Microphone	Enables connection of a microphone.
External monitor	15-pin, analog VGA port.
Universal Serial Bus (USB 2.0) ports	Three or four Universal Serial Bus (USB) enable a chain connection of USB-equipped devices to your computer through the ports. (Depending on the model you purchased)
eSATA/USB combo port	One eSATA/Universal Serial Bus (USB) combo enables a chain connection of USB-equipped or eSATA-equipped devices to your computer through the port. (Provided with some models)
i.LINK™ (IEEE1394)	This port enables high-speed data transfer directly from external devices such as digital video camera.
Video-out port	This S-Video out port allows you to transfer NTSC or PAL data to external devices. See Chapter 8, Optional Devices , for details. (Provided with some models)
HDMI	This HDMI jack allows you to connect external display/audio devices. (Provided with some models)

Infrared receiver window	This is a sensor window that receives signals from the remote controller which is provided with your computer. (Provided with some models)
---------------------------------	--

Slots

Multiple digital media slot	This slot allows you to easily transfer data from devices, such as digital cameras and Personal Digital Assistants, that use flash memory (SD/SDHC/MS/MS Pro/MMC/xD memory cards). (Provided with some models)
------------------------------------	--

ExpressCard slot	ExpressCard slot allows you to install an ExpressCard™/34 or ExpressCard™/54 to expand functionality. See Chapter 8, Optional Devices , for details.
-------------------------	--

Multimedia

Web camera	Record/Send still or video images with this integrated web camera. (Provided with some models)
-------------------	--

Sound system	Windows Sound System compatible sound system provides internal speaker as well as jacks for an external microphone and headphone. It also has a volume control dial.
---------------------	--

Communications

LAN	The computer is equipped with a LAN that supports Ethernet LAN (10 Mbit/s, 10BASE-T), Fast Ethernet LAN (100 Mbit/s, 100BASE-TX) or Giga-bit. It is preinstalled as a standard device in some markets.
------------	--

Wireless LAN	A Wireless LAN mini card is equipped with other LAN systems based on Direct Sequence Spread Spectrum/Orthogonal Frequency Division Multiplexing radio technology that complies with the IEEE 802.11 Standard (Revision A, B, G and draft N). Roaming over multiple channels. (Provided with some models)
---------------------	--

Modem	Some computers in this series are equipped with an internal modem. The internal modem provides capability for data and fax communication. It supports V.90 (V.92). Refer to V.90 section in . The speed of date transfer and fax depends on analog telephone line conditions. It has a modem jack for connecting to a telephone line. It is preinstalled as a standard device in some markets. Both of V.90 and V.92 are supported only in USA and Canada. Only V.90 is available in other regions.
Bluetooth	Some computers in this series are equipped with Bluetooth functions. Bluetooth™ wireless technology eliminates the need for cables between electronic devices such as computers and printers. Bluetooth™ provides fast, reliable, and secure wireless communication in a small space.
Wireless communication switch	This switch turns wireless devices RF transmission(Wireless LAN, Bluetooth and WiMAX) functions on and off. (Provided with some models)

Security

Security lock slot	Connects a security lock to anchor the computer to a desk or other large object.
---------------------------	--

Software

Operating system	Microsoft® Windows Vista™ is available. Refer to the preinstalled <i>Software</i> section at the front of this chapter.
TOSHIBA Utilities	A number of utilities and drivers are preinstalled to make your computer more convenient to use. Refer to the <i>Utilities and applications</i> section in this chapter.
Plug and Play	When you connect an external device to the computer or when you install a component, Plug and Play capability enables the system to recognize the connection and make the necessary configurations automatically.

Special features

The following features are either unique to TOSHIBA computers or are advanced features which make the computer more convenient to use. To access the Power Options, click **Start** → **Control Panel** → **System and Maintenance** → **Power Options**.

Hot keys	Key combinations allow you to quickly modify the system configuration directly from the keyboard without running a system configuration program.
Display automatic power off	This feature automatically cuts off power to the internal display when there is no keyboard input for a time specified. Power is restored when any key is pressed. This can be specified in the Power Options.
HDD automatic power off	This feature automatically cuts off power to the hard disk drive when it is not accessed for a time specified. Power is restored when the hard disk is accessed. This can be specified in the Power Options.
System automatic sleep/hibernation	This feature automatically shuts down the system in sleep mode or hibernation mode when there is no input or hardware access for a time specified. This can be specified in the Power Options.
Keypad overlay	A ten-key pad is integrated into the keyboard. Refer to the Keypad overlay section in Chapter 5, The Keyboard , for instructions on using the keypad overlay.
Power-on password	Two levels of password security, supervisor and user, are available to prevent unauthorized access to your computer.
Instant security	A hot key function blanks the screen and disables the computer providing data security.
Intelligent power supply	A microprocessor in the computer's intelligent power supply detects the battery's charge and calculates the remaining battery capacity. It also protects electronic components from abnormal conditions, such as voltage overload from an AC adaptor. This can be specified in the Power Options.
Battery save mode	This feature allows you to configure the computer in order to save battery power. This can be specified in the Power Options.

Panel power on/off	This feature turns power to the computer off when the display panel is closed and turns it back on when the panel is opened. This can be specified in the Power Options.		
Low battery automatic hibernation mode	When battery power is exhausted to the point that computer operation cannot be continued, the system automatically enters hibernation and shuts down. This can be specified in the Power Options.		
Heat dispersal	To protect from overheating, the CPU has an internal temperature sensor. If the computer's internal temperature rises to a certain level, the cooling fan is turned on or the processing speed is lowered. This can be specified in the Power Options.		
	<table border="0"> <tr> <td data-bbox="504 582 705 686">Maximum Performance</td> <td data-bbox="705 582 1041 686">Turns on fan first, then if necessary lowers CPU processing speed.</td> </tr> </table>	Maximum Performance	Turns on fan first, then if necessary lowers CPU processing speed.
	Maximum Performance	Turns on fan first, then if necessary lowers CPU processing speed.	
<table border="0"> <tr> <td data-bbox="504 686 705 790">Battery Optimized</td> <td data-bbox="705 686 1041 790">Lowers the CPU processing speed first, then if necessary turns on the fan.</td> </tr> </table>	Battery Optimized	Lowers the CPU processing speed first, then if necessary turns on the fan.	
Battery Optimized	Lowers the CPU processing speed first, then if necessary turns on the fan.		
Hibernation	This feature allows you to turn off the power without exiting from your software. The contents of main memory are saved to the hard disk, when you turn on the power again, you can continue working right where you left off. Refer to the Turning off the power section in Chapter 3, Getting Started , for details		
Sleep	If you have to interrupt your work, you can turn off the power without exiting from your software. Data is maintained in the computer's main memory. When you turn on the power again, you can continue working right where you left off.		

TOSHIBA Value Added Package

This section describes the TOSHIBA Component features preinstalled on the computer.

TOSHIBA Power Saver	TOSHIBA Power Saver provides you with the features of more various power supply managements.
TOSHIBA Button Support	<p>This utility controls the following computer button functions.</p> <ul style="list-style-type: none"> ■ Mute button ■ CD/DVD button <p>The starting application from the button can be changed.</p>
TOSHIBA Zooming Utility	This utility allows you to enlarge or reduce the icon size on the Windows Desktop, or the zoom factor associated with specific supported applications.
TOSHIBA PC Diagnostic Tool	The TOSHIBA PC Diagnostic Tool will display basic system configuration information and allow the functionality of some of the computer's built-in hardware devices to be tested.
TOSHIBA Flash Cards	<p>This utility supports the following functions.</p> <ul style="list-style-type: none"> ■ Hot key function ■ TOSHIBA utility launcher function
	<ul style="list-style-type: none"> ■ <i>When you start or resume your computer, the TOSHIBA Flash Cards may take a moment to become available and may display several times before completely activating. The hot key functions will be available once the TOSHIBA Flash Cards are completely active.</i> ■ <i>If your system is busy and you see a [Not Responding] message, allow TOSHIBA Flash Cards to completely activate before you continue to use the utility and hot keys.</i>
TOSHIBA Accessibility	The TOSHIBA Accessibility utility provides support to movement impaired users when they need to use the TOSHIBA hot key functions. In use, the utility allows you to make the FN key "sticky", that is you can press it once, release it, and then press one of the " F " keys in order to access its specific function. When set, the FN key will remain active until another key is pressed.

Utilities and applications

This section describes preinstalled utilities and tells how to start them. For details on operation, refer to each utility's online manual, help files or readme.txt files

TOSHIBA Assist	TOSHIBA Assist is a graphical user interface that provides easy access to help and services.
HW Setup utility	To start the utility, click the Windows Start button, point to All Programs , click TOSHIBA , click Utilities , and select HWSetup icon.
TOSHIBA DVD PLAYER	This software is provided for playback of DVD Video.
TOSHIBA Disc Creator	<p>You can create CD/DVDs in several formats including audio CDs that can be played on a standard stereo CD player and data CD/DVDs to store the files and folders on your hard disk drive. This software can be used on a model with DVD Super Multi (+-R DL) drive.</p> <p>You can boot TOSHIBA Disc Creator from the menu bar as follows.</p> <p>Start → All Programs → TOSHIBA → CD&DVD Applications → Disc Creator</p>
TOSHIBA DVD-RAM utility	<p>TOSHIBA DVD-RAM Utility has the function of Physical Format and Write-Protect to DVD-RAM. This utility is contained the setup module of TOSHIBA Disc Creator.</p> <p>You can boot TOSHIBA DVD-RAM Utility from the menu bar as follows.</p> <p>Start → All Programs → TOSHIBA → CD&DVD Applications → DVD-RAM Utility</p>
Ulead DVD MovieFactory® for TOSHIBA	You can edit digital video and make a DVD-Video and support Labelflash function.
TOSHIBA ConfigFree	<p>ConfigFree is a suite of utilities to allow easy control of communication devices and network connections. ConfigFree also allows you to find communication problems and create profiles for easy switching between location and communication networks.</p> <p>You can boot ConfigFree from the menu bar as follows.</p> <p>Start → All Programs → TOSHIBA → ConfigFree</p>

TOSHIBA Face Recognition

TOSHIBA Face Recognition uses a face verification library to verify the face data of users when they log in to Windows. If the verification is successful, the user will be logged into Windows automatically. The user can thus avoid having to enter a password or the like, which makes the login process easier.

TOSHIBA Bluetooth Stack

This software enables communication between remote Bluetooth devices.



Bluetooth cannot be used in models that do not have a Bluetooth module installed.

Fingerprint Utility

This product has a fingerprint utility installed for the purpose of enrolling and recognizing fingerprints. By enrolling the ID and password to the fingerprint authentication device, it is no longer necessary to input the password from the keyboard. Just by swiping the finger against the fingerprint sensor, the following functions will be enabled:

- Logon to Windows and access a security-enabled homepage through IE (Internet Explorer).
- Files and folders can be encrypted/decrypted and third party access to them prevented.
- Disable the password-protected screen-saver when returning from power-saving (sleep) mode.
- Pr-OS feature and Single Sign-On feature.
- Authentication of the User Password and Hard Disk Password when booting up the computer.



Fingerprint utility cannot be used in models that do not have a fingerprint module installed.

Windows Mobility Center

This section describes the Windows Mobility Center.

Mobility Center is a utility for accessing several mobile PC settings quickly in one window. A default maximum of eight tiles are provided by the operating system, and the additional two tiles are added to your Mobility Center.

- **Lock Computer:** This can be used to lock your computer without turning it off. This has the same function as the **Lock** button at the bottom of the right pane in the start menu.
- **TOSHIBA Assist:** This can be used to open **TOSHIBA Assist** if it is already installed in your computer.

Options

You can add a number of options to make your computer even more powerful and convenient to use. The following options are available:

Memory expansion

Two memory expansion slots are available for installing PC2-5300 512MB, 1 GB or 2 GB memory modules of all models.

The two slots are also available for installing PC2-6400 512MB, 1 GB, 2 GB or 4 GB memory modules of below models:

Mobile Intel[®]R GM45 Express Chipset model/
 Mobile Intel[®]R GL40 Express Chipset model/
 Mobile Intel[®]R PM45 Express Chipset model/
 AMD M780G Chipset model/
 AMD M780V Chipset model/
 AMD M770 Chipset model.

Maximum system memory size and speed are depending on the model you purchased.



- *PC2-6400/PC2-5300 memory modules work as PC2-4200 speed on Mobile Intel[®] GL960 Express Chipset model.*
- *PC2-6400 memory module works as PC2-5300 speed on Mobile Intel[®] GL40/GM965 Express Chipset models.*

Battery Pack	An additional battery pack 3 cell type (PA3533U-1BRS/ PA3533U-1BAS), 6 cell type (PA3534U-1BRS/ PA3534U-1BAS) and 9 cell type (PA3535U-1BRS/ PA3535U-1BAS) can be purchased from your TOSHIBA dealer. The battery pack is identical to the one that came with your computer. Use it as a spare or replacement.
AC adaptor	If you use your computer at more than one site, it may be convenient to purchase an additional AC adaptor (PA3468U-1ACA, PA3468E-1AC3, PA3516U-1ACA, PA3516E-1AC3, PA3290U-3ACA, PA3290E-3AC3) for each site so you will not have to carry the adaptor with you.
USB FDD	The USB floppy disk drive accommodates either a 1.44 MB or 720 KB floppy disk through connection to one of the computer's USB ports. In use, please be aware that, while you cannot format 720 KB floppy disks under Windows Vista™, you are able to read and write to disks that have already been formatted.
Security lock	A slot is available to attach a security cable to the computer to deter theft.

Chapter 2

The Grand Tour

This chapter identifies the various components of your computer. Become familiar with each component before you operate the computer.





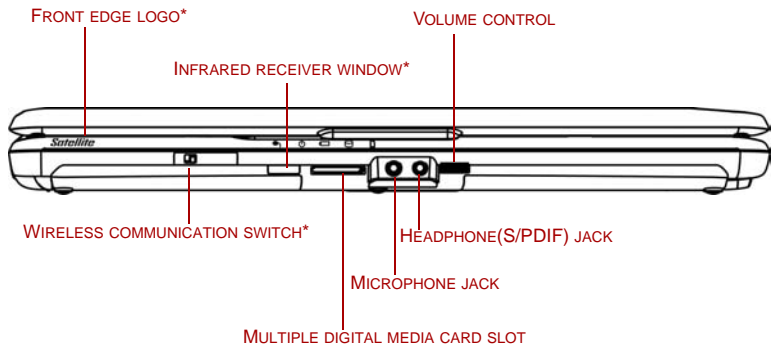

Front with the display closed

Figure 2-1 shows the computer's front with its display panel in the closed position.



*DEPENDING ON THE MODEL YOU PURCHASED.

Figure 2-1 Front of the computer with display closed

Front edge logo	Front edge logo indicates the computer series you bought. (The availability of this function depends on the model you purchased.)
Wireless communication switch Off On 	Slide this switch toward the right of the computer to turn on Wireless communication. Slide it toward the left of the computer to turn off the functions. (Provided with some models)
	<i>Set the switch to turn off in airplanes and hospitals. Check the Wireless communication indicator. It stops glowing when the wireless communication is terminated.</i>
Infrared receiver window	Infrared receiver window is provided with some models. This is a sensor window that receives signals from the remote controller which is provided with your computer.
Multiple digital media slot 	This slot allows you to easily transfer data from devices, such as digital camera and PDA, that use flash memory (SD/SDHC/MS/MS Pro/MMC/xD memory cards).
Microphone jack 	A standard 3.5 mm mini microphone jack enables connection of a microphone or other device for audio input.
Headphone (S/PDIF) jack 	A standard 3.5 mm mini headphone jack with S/PDIF jack out enables connection of a stereo headphone (16 ohm minimum) or other device for audio output. When you connect headphones, the internal speaker is automatically disabled.
Volume control 	Use this dial to adjust the volume of the system speaker and headphones.

Left side

Figure 2-2 shows the computer's left side.

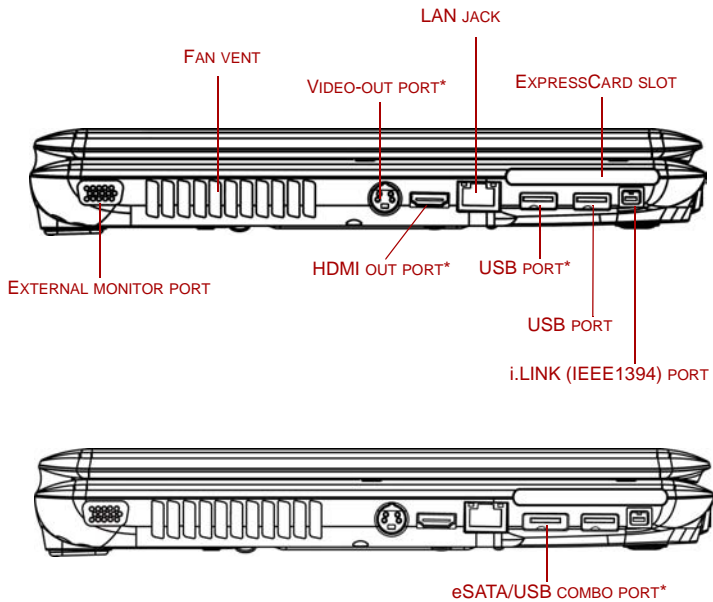

*DEPENDING ON THE MODEL YOU PURCHASED.

Figure 2-2 The left side of the computer

External monitor port

This 15-pin port allows you to connect an external monitor.



Fan vent

Provides air flow for the fan.



Be careful not to block the fan vent. Also be careful to keep foreign objects out of the vents. A pin or similar object can damage the computer's circuitry.

Video-out port

Plug a 4-pin S-Video connector into this port.



HDMI out port

HDMI out port can connect with Type A connector HDMI cable. One HDMI cable can send and receive video, audio and control signals.(Provided with some models)

LAN jack

This jack allows you to connect to a LAN. The adaptor has built-in support for Ethernet LAN (10 Mbit/s, 10BASE-T), Fast Ethernet LAN (100 Mbit/s, 100BASE-TX) or Giga-bit. The LAN has two indicators. See Chapter 4, *Operating Basics*, for details.

Universal serial bus (USB 2.0) port

One or two universal serial bus (USB) ports comply with USB 2.0 standards, which enable data transfer speeds 40 times faster than the USB 1.1 standards. The ports with the icon (⚡) has USB Sleep and Charge function and also support USB 1.1.(Depending on the model you purchased)

eSATA/USB combo port

One eSATA/universal serial bus (USB) combo port comply with USB 2.0 standards, which enables data transfer speeds 40 times faster than the USB 1.1 standards. The port with the icon (⚡) has USB Sleep and Charge function and also supports USB 1.1. This combo port also enables a chain connection of USB-equipped or eSATA-equipped devices to your computer through the port.(Provided with some models)



Keep foreign objects out of the USB connector and eSATA/USB combo connector. A pin or similar object can damage the computer's circuitry.



A connected eSATA device may not be recognized if it is connected to the computer's eSATA/USB combo port while the computer is in Sleep Mode or Hibernation Mode.

If this occurs, disconnect the eSATA device and then reconnect the device while the computer is turned on.



Operation of all functions of all USB devices and eSATA devices has not been confirmed. Some functions might not execute properly.

ExpressCard slot

The computer provides an ExpressCard slot on its left side, which allows you to install an additional ExpressCard.



Keep foreign objects out of the ExpressCard slot. A pin or similar object can damage the computer's circuitry.

i.LINK (IEEE1394) port

Connects an external device, such as a digital video camera to this port for high-speed data transfer.



S400



When multiple IEEE1394 devices are connected to a PC, the devices may not correctly be identified. This problem may occur when Windows Vista™ is restarted while the devices are connected or when the power to the IEEE1394 devices is turned on before the PC is turned on. If it occurs, disconnect the IEEE1394 cables and then reconnect them.

Right side

Figure 2-3 shows the computer's right side.

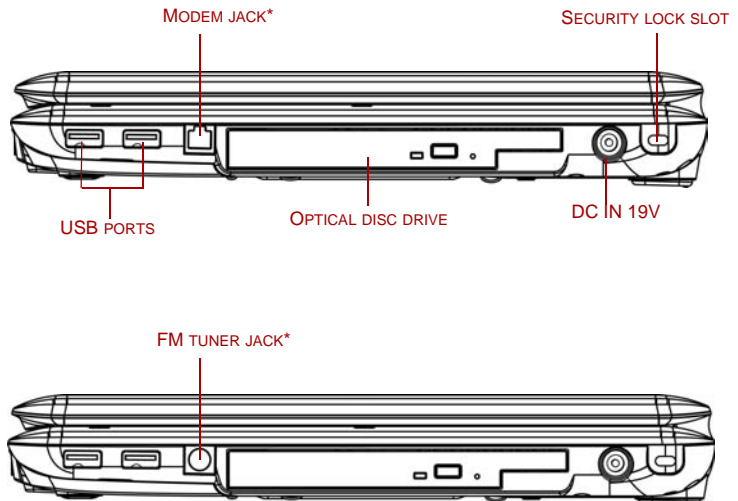

*DEPENDENT ON THE MODEL YOU PURCHASED.

Figure 2-3 The right side of the computer

Universal serial bus (USB 2.0) ports

The two universal serial bus (USB) ports comply with USB 2.0 standards, which enable data transfer speeds 40 times faster than the USB 1.1 standards. The ports with the icon (⚡) have USB Sleep and Charge function and also support USB 1.1.



Keep foreign objects out of the USB connectors. A pin or similar object can damage the computer's circuitry.



Operation of all functions of all USB devices has not been confirmed. some functions might not execute properly.

Modem jack

In areas where an internal modem is installed as standard equipment, there is a modem jack that allows you to use a modular cable to connect the modem directly to a telephone line. The modem is not supported in some marketing regions. (Provided with some models)

FM tuner jack

A FM tuner jack enables FM tuner antenna connection.

Optical disc drive

A DVD Super Multi (+-R DL) drive.

DC IN 19V

The AC adaptor connects to this socket. Use only the model of AC adaptor that comes with the computer. Using the wrong adaptor can damage your computer.

Security lock slot

A security cable attaches to this slot. The optional security cable anchors your computer to a desk or other large object to deter theft.

Back side

Figure 2-4 shows the computer's back side.



Figure 2-4 The computer's back side

Underside

Figure 2-5 shows the underside of the computer. Make sure the display is closed before turning over your computer.

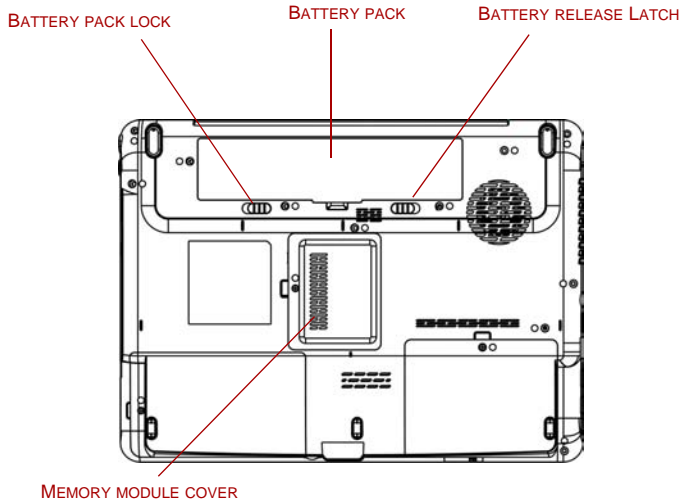

Figure 2-5 The underside of the computer

Battery pack

The battery pack powers the computer when the AC adaptor is not connected. The Batteries section in Chapter 6, [Power and Power-up Modes](#), describes how to access the battery pack. Additional battery packs can be purchased from your TOSHIBA dealer to extend the computer's battery operating time.

Battery release latch



Slide this latch to release the battery pack. This latch moves only when the computer is upside down.

Battery pack lock

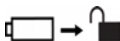

Slide the battery pack lock to unlocked position to free the battery latch.

Memory module cover



This cover protects two memory module sockets. One or two modules are preinstalled.

Front with the display open

Figure 2-6 shows the front of the computer with the display open. To open the display, lift the display up and position the display at a comfortable viewing angle.

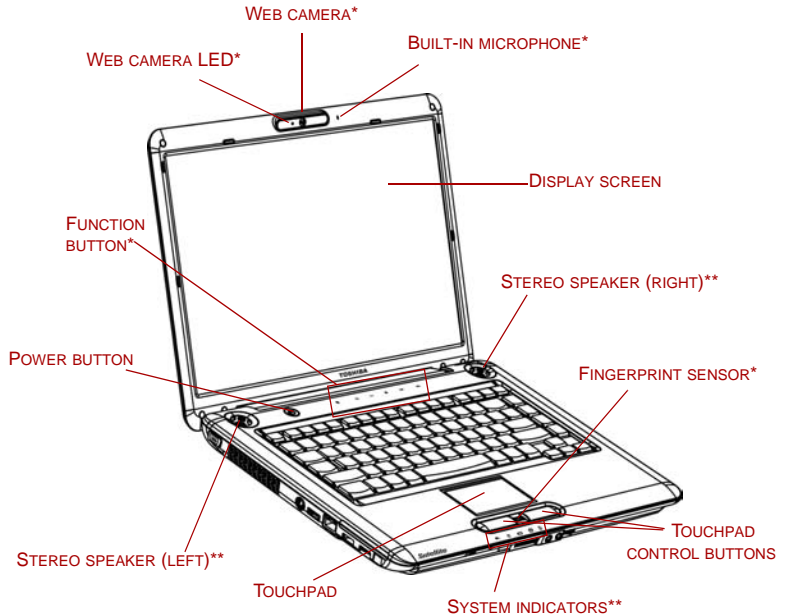

*PROVIDED WITH SOME MODELS.

**APPEARANCE DEPENDS ON THE MODEL YOU PURCHASED.

Figure 2-6 The front with the display open

Display screen

The full-color LCD displays high-contrast text and graphics. The computer's LCD is 15.4" WXGA, 1280 horizontal x 800 vertical pixels.

The computer has a Thin-Film Transistor (TFT) display. Refer to Appendix B, [Display Controller](#).

When the computer operates on power through the AC adaptor, the display screen's image will be somewhat brighter than when it operates on battery power. The lower brightness level is intended to save battery power.

Stereo speaker

The speaker emits sound generated by your software as well as audio alarms, such as low battery condition, generated by the system.

Fingerprint sensor	Just by swiping the finger against the fingerprint sensor, the following functions will be enabled (Provided with some models):
	<ul style="list-style-type: none"> <li data-bbox="520 199 1051 279">■ Logon to Windows and access a security-enabled homepage through IE (Internet Explorer). <li data-bbox="520 287 1051 343">■ Files and folders can be encrypted/decrypted and third party access to them prevented. <li data-bbox="520 351 1051 430">■ Disable the password-protected screensaver when returning from power-saving (Sleep) mode. <li data-bbox="520 438 1051 470">■ Single-Swipe Sign-On feature. <li data-bbox="520 478 1051 558">■ Authentication of the User Password and Hard Disk Password when booting up the computer.
Touchpad	Moves the pointer and selects or activates items on the screen. Can be set to perform other mouse functions, such as scrolling, selecting, and double-clicking.
Touchpad control buttons	Function like the left and right buttons on an external mouse.
System indicators	Five LEDs allow you to monitor the DC IN, power status, main battery, HDD/ODD/eSATA and multiple digital media card. Details are in the system indicators section.
Function button	Six buttons allow you to manage audio/video, run applications and access utilities. Details are in the Function button section. (Provided with some models)
Power button 	Press the power button to turn the computer's power on and off. The power button LED indicates the status.
Web camera	Record/Send still or video images with this integrated web camera. (Provided with some models)
Web camera LED	The web camera LED glows blue when the web camera software is used. (Provided with some models)
Built-in microphone	Records monaural sounds into your applications. (Provided with some models)



Please handle your computer carefully to avoid scratching or damaging the surface.







Function button

Six buttons are provided with some models.



Available for use: Mute, CD/DVD, Play/Pause, Stop, Previous, Next.

These buttons allow you to manage audio/video, run applications and access utilities. Refer to the [Function button](#) section in Chapter 4, [Operating Basics](#) for details.

Mute button	Press this button to turn off the sound.
	
CD/DVD button	Press this button to launch an application program that allows Windows Media Player / TOSHIBA DVD PLAYER.
	
Play/Pause button	Press this button to begin playing an audio CD, a DVD movie or digital audio files. This button also acts as a Pause button.
	
Stop	Press this button to stop play.
	
Previous button	Press this button to advance to the previous track, chapter or data.
	
Next button	Press this button to advance to the next track, chapter or data.
	

System indicators

Figure 2-7 shows the system indicators, which light when various computer operations are in progress.

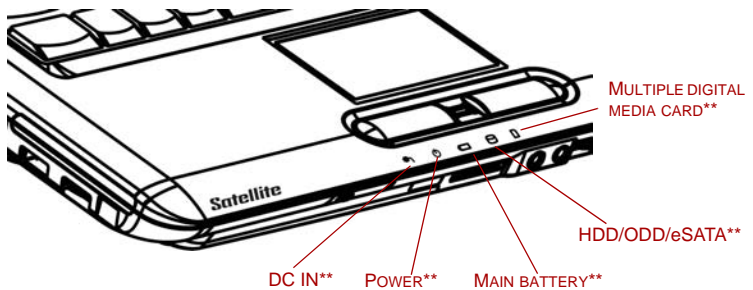

**APPEARANCE DEPENDS ON THE MODEL YOU PURCHASED.

Figure 2-7 System indicators

DC IN



The **DC IN** indicator glows white/green when DC power is supplied from the AC power adaptor. If the adaptor's output voltage is abnormal or if the power supply malfunctions, this indicator shows no light.

Power



The **Power** indicator glows white/green when the computer is on. If you turn off the computer in sleep mode, this indicator blinks orange. If the computer shuts down, this indicator shows no light.

Main battery



The **Main battery** indicator shows the condition of the charge. White/Green means fully charged and orange means being charged. Refer to Chapter 6, [Power and Power-up Modes](#).

HDD/ODD/eSATA



The **HDD/ODD/eSATA** indicator glows white/green when the computer is accessing a hard disk drive, optical disc drive or eSATA-equipped device.

Multiple digital media card



The **Multiple digital media card** indicator glows white/green when the computer is accessing the multiple digital media card.

Keyboard indicators

The figures below show the positions of the keypad overlay indicators and the **CAPS LOCK** indicator.

When the **CAPS LOCK** indicator glows the keyboard is in all-caps mode.

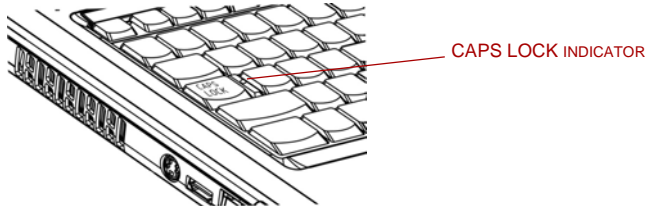

Figure 2-8 CAPS LOCK indicator

CAPS LOCK

This indicator glows green when letter keys are locked into their uppercase format.

When the **F10** key indicator glows the keypad overlay allows you to control the cursor.

When the **F11** key indicator glows the keypad overlay allows you to enter numbers.

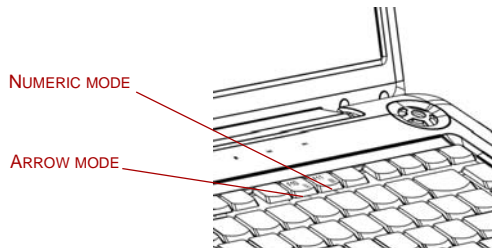

Figure 2-9 Keypad overlay indicators

Arrow mode



When the Arrow mode indicator lights green, you can use the keypad overlay (dark gray labeled keys) as cursor keys. Refer to the [Keypad overlay](#) section in Chapter 5, *The Keyboard*.

Numeric mode



You can use the keypad overlay (dark gray labeled keys) for numeric input when the Numeric mode indicator lights green. Refer to the [Keypad overlay](#) section in Chapter 5, *The Keyboard*.

Optical disc drive

A DVD Super Multi (+-R DL) drive. When the computer is accessing a CD/DVD, an indicator on the drive glows.

Region codes for DVD drives and media

Optical disc drive and media are manufactured according to the specifications of six marketing regions. When you purchase DVD-Video, make sure it matches your drive, otherwise it will not play properly.

Code	Region
1	Canada, United States
2	Japan, Europe, South Africa, Middle East
3	Southeast Asia, East Asia
4	Australia, New Zealand, Pacific Islands, Central America, South America, Caribbean
5	Russia, Indian Subcontinent, Africa, North Korea, Mongolia
6	China

Writable discs

This section describes the types of writable CD/DVD discs. Check the specifications for your drive to for the type of discs it can write. Use TOSHIBA Disc Creator to write compact discs. Refer to Chapter 4, [Operating Basics](#).

CDs

- CD-R discs can be written only once. The recorded data cannot be erased or changed.
- CD-RW discs can be recorded more than once.

DVDs

- DVD-R, DVD+R, DVD-R DL and DVD+R DL discs can be written only once. The recorded data cannot be erased or changed.
- DVD-RW, DVD+RW and DVD-RAM discs can be recorded more than once.

DVD Super Multi (+-R DL) drive

The full-size DVD Super Multi drive (+-R DL) module allows you to record data to rewritable CDs as well as run either 12 cm (4.72") or 8 cm (3.15") CD/DVDs without using an adaptor.



The read speed is slower at the center of a disc and faster at the outer edge.

DVD read	8 speed (maximum)
DVD-R write	8 speed (maximum)
DVD-RW write	6 speed (maximum)
DVD+R write	8 speed (maximum)
DVD+RW write	8 speed (maximum)
DVD+R DL write	4 speed (maximum)
DVD-R DL write	4 speed (maximum)
DVD-RAM write	5 speed (maximum)
CD read	24 speed (maximum)
CD-R write	24 speed (maximum)
CD-RW write	16 speed (maximum, Ultra-speed media)

Remote controller

A remote controller, which is provided with some models, enables you to perform some functions of your computer from a distant location.

There are two different types of remote controllers:

- Full size
- Slim size

You can use your remote controller with Media Center to play CDs, DVDs and videos, to view pictures and to watch and record television programs (depending on its type).

The remote controller helps you to control the playback of a movie through Media Center .

Using the remote controller, you can:

- Navigate and control all Media Center windows.
- Control the video.
- Place the computer in and out of Sleep mode.

Full size remote controller

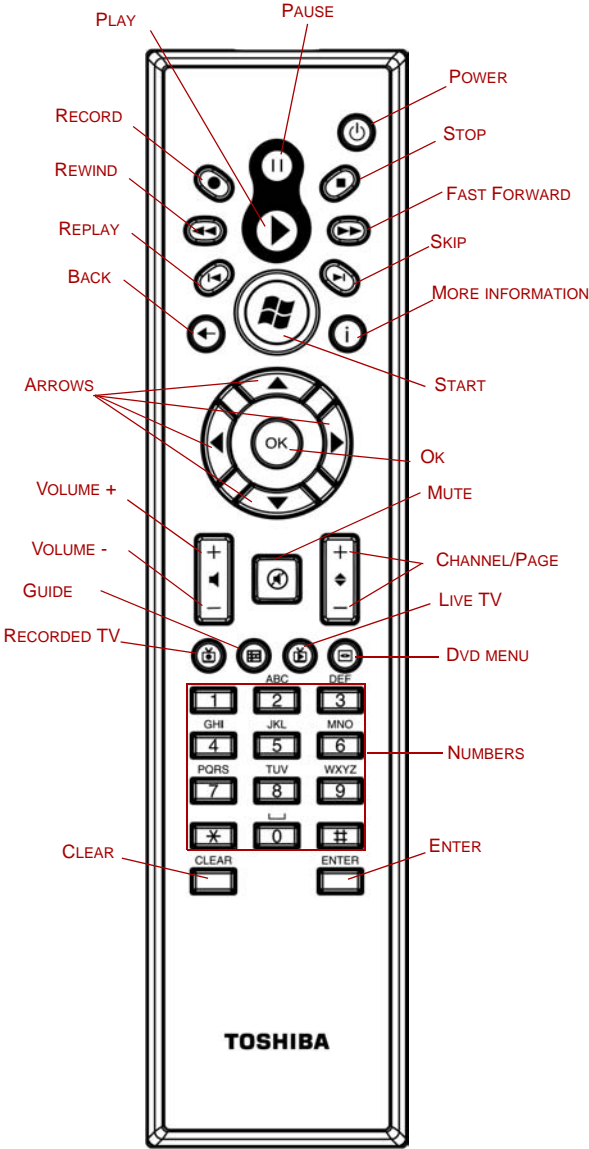



















Figure 2-10 Full size remote controller

<p>Power</p> 	<p>Starts or terminate the operating system.</p> <p>This button functions like the power button of your computer. By default, the Sleep mode is equivalent to the power off state of your computer. To change the setting, click Start → Control panel → System and Maintenance → Power Options → Choose what the power buttons do → When I press the sleep button:. The following three options are available: Do nothing, Sleep and Hibernate.</p>
<p>Record</p> 	<p>Records the selected television program and stores it on your hard disk drive.(Can be used only for TV tuner models)</p>
<p>Stop</p> 	<p>Stops the media currently playing.</p>
<p>Pause</p> 	<p>Pauses an audio or video track.</p>
<p>Play</p> 	<p>Plays the selected media.</p>
<p>Rewind</p> 	<p>Moves the media (video, DVD, music, and so on) backwards.</p>
<p>Fast forward</p> 	<p>Moves the media (video, DVD, music, and so on) forwards.</p>
<p>Replay</p> 	<p>Moves media backward (seven seconds for videos, one music track or one DVD chapter at a time).</p>
<p>Skip</p> 	<p>Moves media forward (30 seconds for videos , one music track or one DVD chapter).</p>
<p>Back</p> 	<p>Displays the previous window.</p>

More information 	The button provides more detail information.
Arrows	Moves the cursor to navigate within Media Center windows.
OK 	Selects the desired action or window option. It acts like the ENTER Key.
Volume +	Increases the volume while viewing DVDs or replaying CDs.
Volume -	Decreases the volume while viewing DVDs or replaying CDs.
Start 	Opens Media Center to the main window.
Channel/Page up(+) and down(-)	Changes the TV channel or moves a page up and down, depending on the available options.
Mute 	Turns your computer sound off.
Recorded TV 	Allows you to start recording of TV programs. The Recorded TV feature of Media Center will be activated.(Can be used only for TV tuner models)
Guide 	Opens the Television Program Guide to display available TV channels and programs to watch and record.(Can be used only for TV tuner models)
Live TV 	A shortcut to the full screen view. It also takes you to the current point in a live TV program after pausing live TV.(Can be used only for TV tuner models)
DVD menu 	Opens the main menu on a DVD movie, if available.

Numbers	Allows you to select a channel or chapter number while CD/DVD replay. Numbers, letters or symbols can be entered. To select a channel or chapter number of two or more digits, press the buttons sequentially. For example, press the "1" button and then the "0" button to select the number 10.
CLEAR	Deletes entered numbers, letters or symbols.
ENTER	The OK button on the remote controller has the same functions.

Slim size remote controller

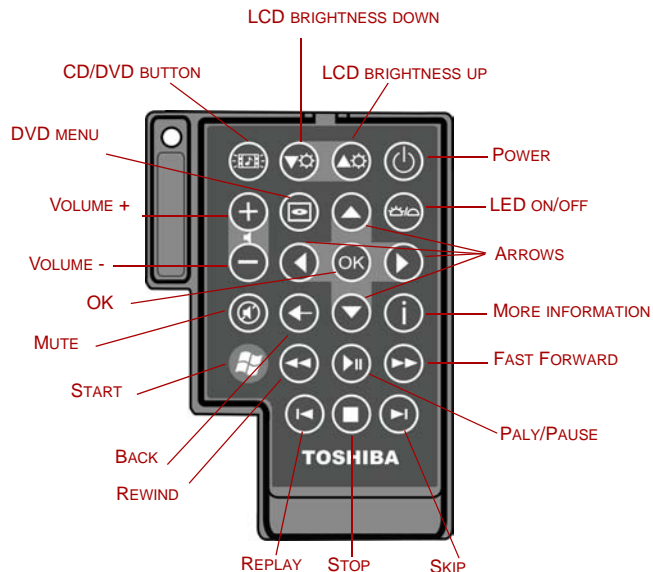



















Figure 2-11 Slim size remote controller

CD/DVD button 	Press this button to launch an application program that allows Windows Media Player / TOSHIBA DVD PLAYER.
Brightness down 	Decreases the computer's display panel brightness in individual steps.

Brightness up 	Increases the computer's display panel brightness in individual steps.
Power 	Starts or terminate the operating system. This button functions like the power button of your computer. By default, the Sleep mode is equivalent to the power off state of your computer. To change the setting, click Start → Control panel → System and Maintenance → Power Options → Choose what the power buttons do → When I press the sleep button: . The following three options are available: Do nothing, Sleep and Hibernate.
Volume +	Increases the volume while viewing DVDs or replaying CDs.
Volume -	Decreases the volume while viewing DVDs or replaying CDs.
DVD menu 	Opens the main menu on a DVD movie, if available.
Arrows	Moves the cursor to navigate within Media Center windows.
OK 	Selects the desired action or window option. It acts like the ENTER Key.
LED on/off 	Pressing this button to switch the lighting of indicators.
Mute 	Turns your computer sound off.
Back 	Displays the previous window.
More information 	The button provides more detail information.

Start 	Opens Media Center to the main window.
Rewind 	Moves the media (video, DVD, music, and so on) backwards.
Play/Pause 	Plays the selected media. This button also acts as a pause button.
Fast forward 	Moves the media (video, DVD, music, and so on) forwards.
Replay 	Moves media backward (seven seconds for videos, one music track or one DVD chapter at a time).
Stop 	Stops the media currently playing.
Skip 	Moves media forward (30 seconds for videos , one music track or one DVD chapter).

Using the remote controller

Some computers include a remote control unit, which allows you to control some of your computer's functions from a distant location.



- *The remote controller is designed specifically for this computer.*
- *Some application programs may not support remote control functions.*

Operational range of the remote controller

Point the remote controller at your computer and press a button. The operational angle and distance are described below.

Distance	Within 5 meters from the infrared receiver window.
Angle	Within about 30 degrees horizontally and about 15 degrees vertically of perpendicular to the infrared receiver window.

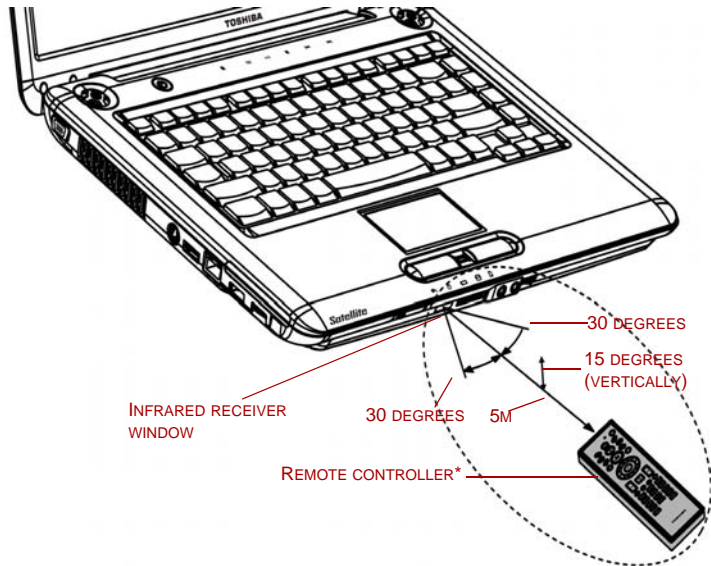

*THE APPEARANCE OF THE PROVIDED REMOTE CONTROLLER MAY VARY FROM MODEL TO MODEL, AND IT IS NOT PROVIDED WITH SOME MODELS.

Figure 2-12 Operational range of the remote controller



Even if within the effective scope as described above, the remote controller may malfunction or not work correctly in the following cases.

- When an obstacle stands between the infrared receiver window of your computer and the remote controller.
- When direct sunlight or strong fluorescent light strikes the infrared receiver window.
- When the infrared receiver window or the infrared emission part of the remote controller is dirty.
- When other computers which use an infrared remote controller are used near to your computer.
- When a low battery condition is present.

Installing/Removing batteries

Be sure to install the provided AA type or CR2016 type batteries before using the remote controller. The procedures for installing and removing the batteries vary depending on the type of the remote controller. Check the type and then install or remove the batteries as instructed.



Store the battery for the remote controller beyond the reach of children. If a child swallows a battery, this might result in choking. If it happens, contact a doctor immediately.



Observe the following precautions when using the battery of the remote controller.

- *Do not use batteries other than those specified.*
- *Ensure that you insert the batteries with their polarities correctly aligned (+ or -).*
- *Do not recharge, heat, disassemble or short the battery, or put it into a fire or flame.*
- *Do not use a battery whose “recommended expiration date” has been reached, or which is completely discharged.*
- *Do not use different types of batteries or old and new batteries at the same time.*
- *Do not carry the battery together with metal necklaces, hairpins or other metal accessories.*
- *When storing or disposing of used batteries, make sure to put some insulation tape on their terminals (+ and -) to avoid short-circuits.*

If these precautions are not followed, heating, fluid leakage or explosion may occur. This may cause burns or personal injury. If battery fluid gets on your skin or clothes, wash immediately with clean water. If battery fluid gets in your eyes, rinse your eyes with clean water immediately and see a doctor. Do not touch the battery fluid on instruments or devices with bare hands. Wipe off with a cloth or paper towel.

Type of battery that can be used for the remote controller

When the provided batteries run down, please replace them with adequate ones. For full size remote controller, AA manganese and AA alkaline batteries are available; for slim size remote controller, CR2016 type battery is available. Other types or battery should not be used.

Installing the batteries

Full size remote controller

1. Open the battery cover on the back side of the remote controller. Slide the cover in the direction of the arrow to remove the cover.

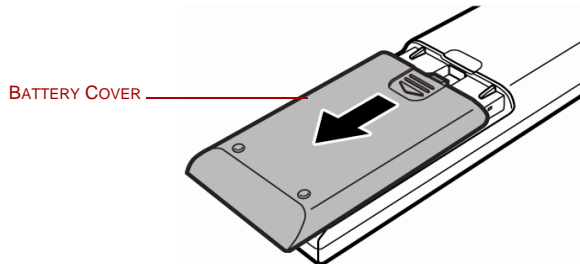

Figure 2-13 Opening the battery cover

2. Insert the batteries in place. Be sure to place the batteries with their polarities (+ and -) in the correct position.

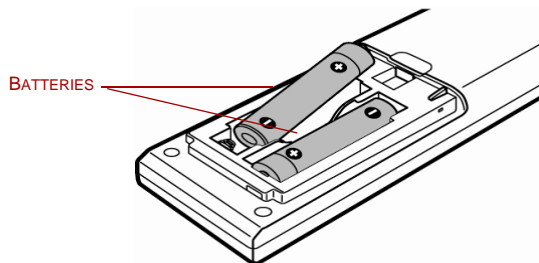

Figure 2-14 Inserting the batteries

3. Close the battery cover. Close the cover securely until it clicks

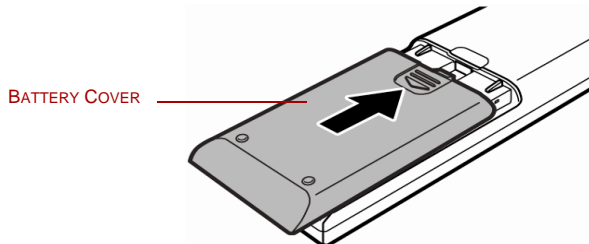

Figure 2-15 Closing the battery cover

Slim size remote controller

1. Open the battery cover on the back side of the remote controller.

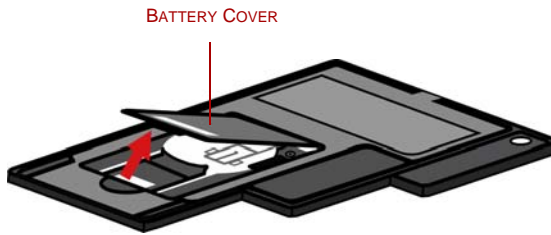

Figure 2-16 Opening the battery cover

2. Be sure to place the batteries with correct polarities. Press the battery down to the stopper then push it forward to fit into the battery case.

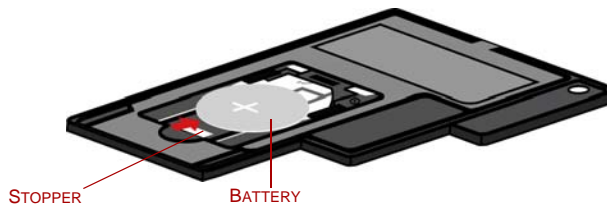

Figure 2-17 Inserting the batteries

3. Close the battery cover. Close the cover securely until it clicks



Figure 2-18 Closing the battery cover

Replacing the batteries

When the batteries in the remote controller reach the end of their life, the remote controller may not operate correctly or work only within a short distance from your computer. In this instance, you should purchase new batteries and replace the discharged ones.

Full size remote controller

1. Open the battery cover on the back side of the remote controller.
2. Replace the batteries. Be sure to place the batteries with their polarities (+ and -) in the correct position.

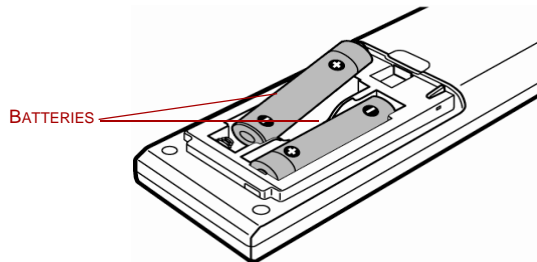

Figure 2-19 Removing the batteries

3. Close the battery cover. Close the cover securely until it clicks.

Slim size remote controller

1. Open the battery cover on the back side of the remote controller.
2. Hold down the stopper and slide the battery out of battery case.

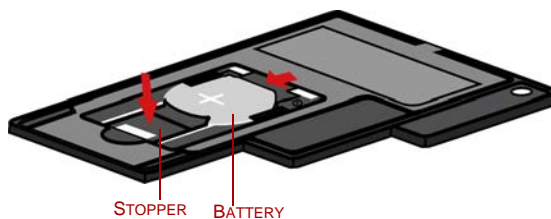

Figure 2-20 Removing the batteries

3. Insert the battery in place. Be sure to place the batteries with correct polarities. Press the battery down to the stopper then push it forward to fit into the battery case.
4. Close the battery cover. Close the cover securely until it clicks.

Placing slim size remote controller

Inserting a slim size remote controller

To insert the slim size remote controller, follow the steps below.

1. Make sure the ExpressCard slot is empty.
2. Set the front side upward and insert the slim size remote controller.

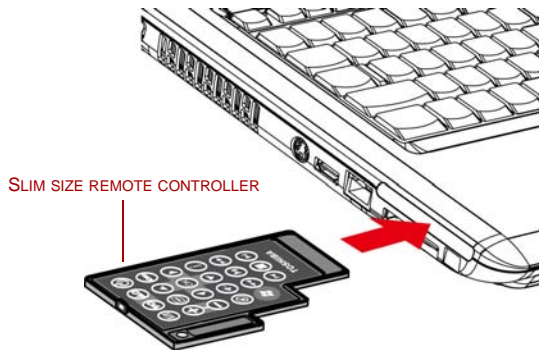

Figure 2-21 Inserting the slim size remote controller

3. Press gently to ensure a firm connection.

Remove a slim size remote controller

To remove the slim size remote controller, follow the steps below.

1. Press the slim size remote controller slightly to make it stretch out.
2. Grasp the slim size remote controller and pull it out from the slot.

AC adaptor

The AC adaptor converts AC power to DC power and reduces the voltage supplied to the computer. It can automatically adjust to any voltage from 100 to 240 volts and to a frequency of either 50 or 60 hertz, enabling you to use the computer in almost any region.

To recharge the battery, simply connect the AC adaptor to a power source and the computer. See Chapter 6 [Power and Power-up Modes](#) for details.

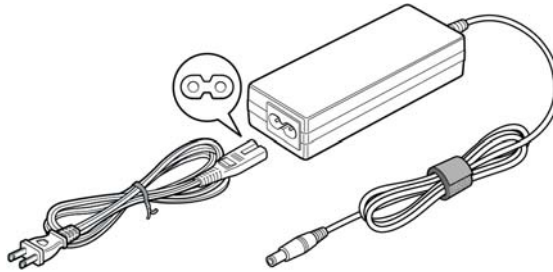

Figure 2-22 The AC adaptor (2-pin plug)

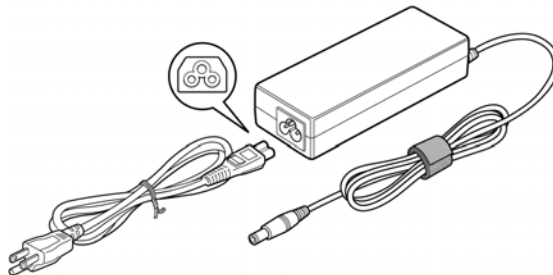

Figure 2-23 The AC adaptor (3-pin plug)



- Use of the wrong adaptor could damage your computer. TOSHIBA assumes no liability for any damage in such case. The output rating for the computer is 19 volts DC.
- Please use only the AC adaptor supplied with the computer or an AC adaptor certified by TOSHIBA.

Chapter 3

Getting Started

This chapter provides basic information to start using your computer. It covers the following topics:



Be sure also to read Instruction Manual for Safety and Comfort. This guide, which is included with the computer, explains product liability.

- Connecting the AC adaptor
- Opening the display
- Turning on the power
- Starting up for the first time
- Turning off the power
- Restarting the computer
- System recovery options

If you are a new user, follow the steps in each section of this chapter as you prepare to operate your computer



All users should be sure to carefully read the sections Windows Vista™ setup, which describe actions to take when you turn on the power for the first time.

Connecting the AC adaptor

Attach the AC adaptor when you need to charge the battery or you want to operate from AC power. It is also the fastest way to get started, because the battery pack will need to be charged before you can operate from battery power.

The AC adaptor can be connected to any power source supplying from 100 to 240 volts and 50 or 60 hertz. For details on using the AC adaptor to charge the battery pack, refer to Chapter 6, [Power and Power-up Modes](#).



Use of the wrong adaptor could damage your computer. TOSHIBA assumes no liability for any damage in such case. The output rating for the computer is 19 volts DC.

1. Connect the power cord to the AC adaptor.

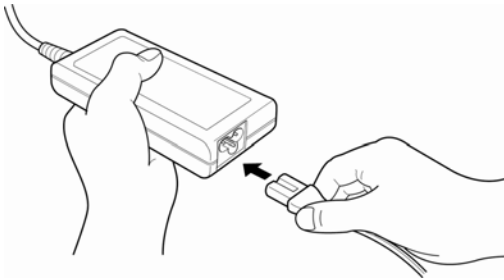

Figure 3-1 Connecting the power cord to the AC adaptor

2. Connect the AC adaptor's DC output plug to the DC IN 19V jack on the right side of the computer.

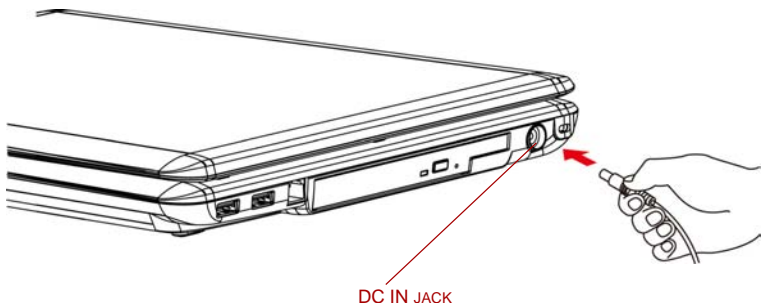

Figure 3-2 Connecting the adaptor to the computer

3. Plug the power cord into a live wall outlet - the **Battery** and **DC IN** indicators on the front of the computer should glow.

Opening the display

The display panel can be rotated in a wide range of angles for optimal viewing.

To open the display, lift the panel up and adjust it to the best viewing angle.



While you open the display, hold the base of the computer to avoid raising it.

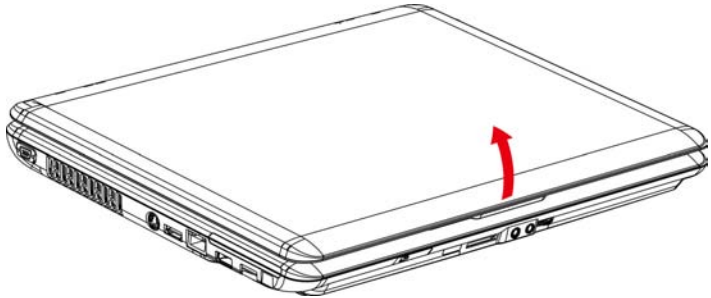

Figure 3-3 Opening the display panel

Turning on the power

This section describes how to turn on the power



After you turn on the power for the first time, do not turn it off until you have set up the operating system (OS) and the OS has started up.

1. If the external diskette drive is connected, make sure it is empty. If a diskette is in the drive, press the eject button and remove the diskette.
2. Open the display panel.
3. Press and hold the computer's power button for two or three seconds.

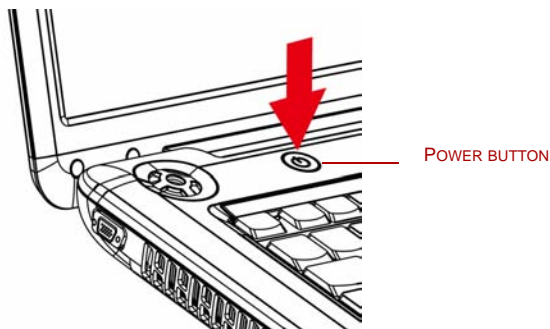

Figure 3-4 Turning on the power

Starting up for the first time

When you first turn on the power, the computer's initial screen is the Microsoft® Windows Vista™ Startup Screen Logo. Follow the on-screen directions.

Turning off the power

The power can be turned off in one of three modes : shut down (Boot) , hibernation mode or sleep mode.

Shut down mode (Boot mode)

When you turn off the power in shut down mode, no data is saved and the computer will boot to the operating system's main screen.

1. If you have entered data, save it to the hard disk or to a diskette.
2. Make sure all disk(disc) activities are terminated, then remove any CD/DVD or diskette.



Make sure the disk's indicator is off. If you turn off the power while a disk(disc) is being accessed, you can lose data or damage the disk(disc).

3. Click Windows Start button, point to  , and then select **Shut Down**.
4. Turn off the power to any peripheral devices.



Do not turn the computer or devices back on immediately. Wait a moment to let all capacitors fully discharge.

Hibernation mode

The hibernation feature saves the contents of memory to the hard disk when the computer is turned off. The next time the computer is turned on, the previous state is restored. The hibernation feature does not save the status of peripheral devices.



- *While entering hibernation mode, the computer saves the contents of memory to the HDD. Data will be lost if you remove the battery or disconnect the AC adaptor before the save is completed. Wait for the **HDD/ODD/eSATA** indicator to go out.*
- *Do not install or remove a memory module while the computer is in hibernation mode. Data will be lost.*

Benefits of hibernation mode

The hibernation feature provides the following benefits:

- Saves data to the hard disk when the computer automatically shuts down because of a low battery.



For the computer to shut down in hibernation mode, the hibernation feature must be enabled in the Hibernate tab in Power Options. Otherwise, the computer will shut down in sleep mode. If battery power becomes depleted, data saved in sleep mode will be lost.

- You can return to your previous working environment immediately when you turn on the computer.
- Saves power by shutting down the system when the computer receives no input or hardware access for the duration set by the system hibernation feature.
- You can use the panel power off feature.

Starting hibernation mode

To enter hibernation mode, follow the steps below.

Windows Vista™

1. Click Windows Start button.
2. Point to .
3. Select **Hibernate**.

Automatic hibernation mode

The computer will enter hibernation mode automatically when you press the power button or close the lid. First, however, make the appropriate settings according to the steps below.

1. Open the **Control Panel**.
2. Open **Mobile PC** and open **Power Options**.
3. Select **Choose what the power buttons do**.
4. Enable the desired hibernation settings for **When I press the power button** and **When I close the lid**.
5. Click the **Save changes** button.



*You can also enable hibernation mode by pressing **FN + F4** - please refer to Chapter 5, [The Keyboard](#), for further details.*

Data save in hibernation mode

When you turn off the power in hibernation mode, the computer takes a moment to save current memory data to the hard disk. During this time, the **HDD/ODD/eSATA** indicator will light.

After you turn off the computer and memory is saved to the hard disk, turn off the power to any peripheral devices.



Do not turn the computer or devices back on immediately. Wait a moment to let all capacitors fully discharge.

Sleep mode

In sleep mode the power remains on, but the CPU and all other devices are in sleep mode.



Turning Off Your Computer where Electronic Devices are Regulated or Controlled.

When you have to turn off your computer aboard an aircraft or in places where electronic devices are regulated or controlled, always shut down the computer completely or put the computer into Hibernation mode instead of allowing it to go into sleep mode, and turn off any wireless communication switches or devices, while in sleep mode, the computer operating system may reactivate itself to run pre-programmed tasks or to preserve unsaved data, and might interfere with aviation or other systems, possibly causing serious injury.



- *Before entering sleep mode, be sure to save your data.*
- *Do not install or remove a memory module while the computer is in sleep mode. The computer or the module could be damaged.*
- *Do not remove the battery pack while the computer is in sleep mode (unless the computer is connected to an AC power source). Data in memory will be lost.*

Benefits of sleep mode

The sleep feature provides the following benefits:

- Restores the previous working environment more rapidly than hibernation feature.
- Saves power by shutting down the system when the computer receives no input or hardware access for the duration set by the system sleep feature.
- You can use the panel power off feature.

Executing sleep mode



You can also enable sleep mode by pressing **FN + F3**. See Chapter 5, *The Keyboard*, for details.

You can enter sleep mode in one of three ways:

1. Click Windows Start button, point to , and then click **Sleep**.
2. Close the display panel. This feature must be enabled. Refer to the Power Options in the Control Panel.
3. Press the power button. This feature must be enabled. Refer to the Power Options in the Control Panel.

When you turn the power back on, you can continue where you left when you shut down the computer.



- *When the computer is shut down in sleep mode, the power indicator glows orange.*
- *If you are operating the computer on battery power, you can lengthen the operating time by shutting down in hibernation mode. Sleep mode consumes more power.*

Sleep mode limitations

Sleep mode will not function under the following conditions:



- Power is turned back on immediately after shutting down.
- Memory circuits are exposed to static electricity or electrical noise.

Restarting the computer

Certain conditions require that you reset the computer, for example, if:

- You change certain computer settings.
- An error occurs and the computer does not respond to your keyboard commands.

If you need to restart the computer, there are three ways this can be achieved:

1. Click **Start** then click the arrow button () in the power management buttons () and select **Restart** from the menu.
2. Press **CTRL, ALT** and **DEL** simultaneously (once) to display the menu window, then click the arrow button in the lower right corner of the screen, then select **Restart**.
3. Press the power button and hold it down for five seconds. Once the computer has turned itself off, wait between ten and fifteen seconds before turning the power on again by pressing the power button.

System recovery options

About 1.5 GB hidden partition is allocated on the hard disk drive for the system recovery options. This partition stores files which can be used to repair the system in the event of a problem.

System recovery options

The system recovery options feature is installed on the hard disk when shipped from the factory. The system recovery options menu includes some tools to repair startup problems, run diagnostics or restore the system.

You can see the more information about **Startup Repair** in **Windows Help and Support** content.

The System Recovery Options can also be run manually to repair problems.

1. Turn off the computer.
2. While holding the **F8** key, turn the computer on again.
3. The **Advanced Boot Options** menu will be displayed. Use the arrow keys to select **Repair Your Computer** and press **ENTER**.
4. Follow the on-screen instructions from this point onward.



The Window Vista Complete PC Backup feature can be used on Windows Vista™ Business Edition and Ultimate Edition.

Create optical recovery discs

A recovery image of your computer is stored on the hard disk. You may use this image to create CD or DVD recovery discs using the following steps:

1. Select either blank CDs or DVDs media.
2. The application will allow you to choose a type of media to create recovery CDs/DVD including: CD-R, CD-RW, DVD-R, DVD-RW, DVD+R and DVD+RW.



Some media may not be compatible with optical drive of your computer. Please verify your optical drive supports the blank media you choose.

3. Turn on your computer to open Windows Vista™.
4. Insert the (first) blank media into the tray of the optical drive.
5. Double click the Recovery Disc Creator icon on the Windows Vista™ desktop, or select the application from Start menu.
6. After Recovery Disc Creator starts, select the type of media and the title you wish to copy to the media then click the Create button.



*If your optical drive can only write to CDs, select **CD** as the **Disc Set** on Recovery Disc Creator. If your Optical Drive of your computer can write to either CD or DVDs, select the one you are using as the **Disc Set** on Recovery Disc Creator.*

Restoring the preinstalled software from the recovery HDD

A portion of the total hard disk drive space is configured as a hidden recovery partition. This partition stores files which can be used to restore preinstalled software in the event of a problem.

When re-setting up your hard disk, do not change, delete or add partition in a manner other than specified in the manual. Otherwise, space for software may be destroyed.

In addition, if you use a third-party partitioning program to reconfigure partitions on your hard disk, it may become impossible to re-setup your computer.



- *When the sound mute feature has been activated by pressing the **FN+ESC** key, be sure to disable this to allow sounds to be heard before starting the restore process. Please refer to Chapter 5, [The Keyboard](#), for further details.*
- *You can not use System Recovery Options if restoring the preinstalled software without System Recovery Options.*

1. Turn off your computer.
2. While holding down 0 (zero) key on the keyboard, turn on your computer.
3. A menu appears. Follow the on-screen instructions.

Restoring the preinstalled software from your creating recovery media

If preinstalled files are damaged, use the your creating Recovery Media or using HDD Recovery to restore them. To restore the operating system and all preinstalled software, follow the steps below.



- *When the sound mute feature has been activated by pressing the **FN+ESC** key, be sure to disable this to allow sounds to be heard before starting the restore process. Please refer to Chapter 5, [The Keyboard](#), for further details.*
- *You can not use System Recovery Options if restoring the preinstalled software without System Recovery Options.*
- *When you reinstall the Windows operating system, the hard disk will be reformatted and all data will be lost.*

1. Load the Recovery Media in the optional optical disc drive and turn off the computer's power.
2. Hold down the **F12** key and turn on the power. When **TOSHIBA Leading Innovation>>>** appears, release the **F12** key.

For 2HDDs model,

If HDD1 is first, go to the (3.) step.

If HDD1 is not first, do as follows.

- a. Select **Enter Setup**
 - b. Press the **F9** key to set to default settings, and select **Yes**.
 - c. Press the **F10** key to save the changes, and select **Yes**.
 - d. When the TOSHIBA Leading Innovation>>> prompt appears,
press the **F12** key to display the Boot menu. Go to the (3.)step.
3. Use the up or down cursor key to select CD/DVD in the display menu. For details, refer to the [Boot Priority](#) section in Chapter 7, [HW Setup and Passwords](#).
 4. A menu appears. Follow the on-screen instructions.



*When drivers Utilities are installed, you can setup the respective drivers and utilities from the following folder. C: \TOSAPINS****



*When removing pre-installed drivers/utilities or when installing, you can setup the respective drivers/utilities from the following folder. C:\TOSAPINS****

Chapter 4

Operating Basics

This chapter gives information on basic operations including using the touchpad, the fingerprint sensor, optical disc drives, Audio/Video controls, the web camera, the microphone, the internal modem, the FM tuner, wireless communication and LAN. It also provides tips on caring for your computer, diskettes and CD/DVD.

Using the touchpad

To use the touchpad, simply touch and move your finger tip across it in the direction you want the on-screen pointer to go.

Two buttons below the touchpad are used like the buttons on a mouse pointer.

Press the left button to select a menu item or to manipulate text or graphics designated by the pointer. Press the right button to display a menu or other function depending on the software you are using.



You can also tap the touchpad to perform functions similar to those of the left button on a standard mouse.

Click: Tap the touchpad once.

Double-click: Tap twice

Drag and drop: Tap to select the material you want to move. Leave your finger on the touchpad after the second tap and move the material.

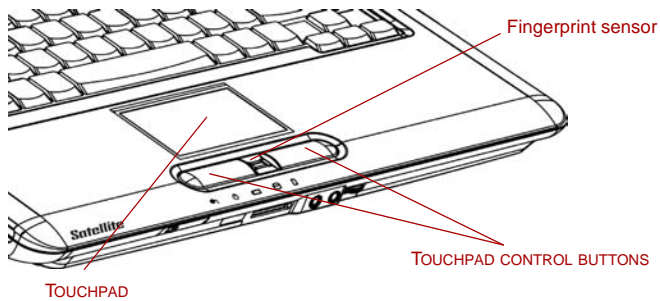

Figure 4-1 Touchpad, touchpad control buttons and fingerprint sensor

Using the fingerprint sensor

This product has a fingerprint utility installed for the purpose of enrolling and recognizing fingerprints. By enrolling the ID and password to the fingerprint authentication device, it is no longer necessary to input the password from the keyboard. Just by swiping the finger against the fingerprint sensor, the following functions will be enabled:

- Logon to Windows and access a security-enabled homepage through IE (Internet Explorer).
- Files and folders can be encrypted/decrypted and third party access to them prevented.
- Disable the password-protected screen-saver when returning from power-saving (Sleep) mode.
- Single-Swipe Sign-On feature.
- Authentication of the User Password and Hard Disk Password when booting up the computer.



To “swipe” refers to the action of reading a fingerprint using the fingerprint sensor.

How to swipe the finger

Using the following steps when swiping fingers for fingerprint registration or authentication will help to minimize authentication failures:

1. Align the first joint of the finger to the center of the sensor. Lightly touch the sensor and swipe finger levelly towards you.
2. While lightly touching the sensor, swipe the finger towards you until the sensor surface becomes visible.
3. Ensure the center of the fingerprint is on the sensor when swiping the finger.

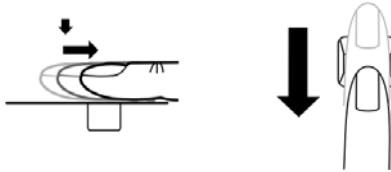

Figure 4-2 Slide the finger over the recognition sensor



- **Avoid swiping with the finger stiff or pressed-on too hard:**
Fingerprint reading may fail if the center of the fingerprint is not touching on the sensor, or when finger is swiped while pressing hard. Make sure that the center of the fingerprint is touching the sensor before swiping.
- **Confirm the center of the fingerprint whirl before swiping:**
The thumb's fingerprint has a bigger whirl, which is prone to misalignment and distortions. This will cause difficulty in registration and a drop in the authentication success rate. Always confirm the center of the fingerprint whirl so that it is swiped along the centerline of the sensor.
- **When fingerprint reading is not successful:**
There is a possibility of authentication failures if the finger is swiped too quickly or too slowly. Follow the onscreen instructions to adjust the speed of the swipe.

Points to note about the fingerprint sensor

Failure to follow these guidelines might result in (1) damage to the sensor or cause sensor failure, (2) finger recognition problems, or lower finger recognition success rate.

- Do not scratch or poke the sensor with your nails or any hard or sharp objects.
- Do not press the sensor strongly.
- Do not touch the sensor with a wet finger or any wet objects. Keep sensor surface dry and free of water vapor.
- Do not touch the sensor with a soiled or dirty finger. Minute foreign particles on a soiled or dirty finger may scratch the sensor.

- Do not paste stickers or write on the sensor.
- Do not touch the sensor with a finger or any object with built-up static electricity.

Observe the following before you place your finger on the sensor whether for fingerprint enrollment/registration or recognition.

- Wash and dry your hands thoroughly.
- Remove static electricity from your fingers by touching any metal surface. Static electricity is a common cause of sensor failures, especially when the weather is dry.
- Clean the sensor with a lint-free cloth. Do not use detergent or any other chemicals to clean the sensor.
- Avoid the following finger conditions for enrollment or recognition as they may result in fingerprint enrollment errors or a drop in the fingerprint recognition success rate
 - Soaked or swollen finger (e.g. after taking bath)
 - Injured finger
 - Wet finger
 - Soiled or oily finger
 - Extremely dry skin condition on finger

Observe the following to improve the fingerprint recognition success rate.

- Enroll two or more fingers.
- Enroll additional fingers if recognition failure occurs often using enrolled fingers.
- Check your finger condition. Changed conditions, such as injured, rough, extremely dry, wet, soiled, dirty, oily, soaked, swollen fingers, may lower the recognition success rate. Also if the fingerprint is worn down or the finger becomes thinner or fatter, the recognition success rate may be lowered.
- The fingerprint for each finger is different and unique. Please ensure that only the registered or enrolled fingerprint or fingerprints are used for identification.
- Check sliding position and speed.
- The fingerprint sensor compares and analyzes the unique characteristics in a fingerprint. However, there may be instances where certain users are unable to register their fingerprints due to insufficient unique characteristics in their fingerprints.
- The recognition success rate may differ from user to user.

Fingerprint sensor limitations

- The fingerprint sensor compares and analyzes the unique characteristics in a fingerprint.
- A warning message will be displayed when recognition is abnormal or recognition is not successful within a fixed duration.
- The recognition success rate may differ from user to user.
- Toshiba does not guarantee that this fingerprint recognition technology will be error-free.
- Toshiba does not guarantee that the fingerprint sensor will recognize the enrolled user or accurately screen out unauthorized users at all times. Toshiba is not liable for any failure or damage that might arise out of the use of this fingerprint recognition software or utility.

Points to note about the fingerprint utility

- If Windows Vista™'s file encryption function EFS (Encryption File System) is used to encrypt a file, the file cannot be further encrypted using the encryption function of this software.
- You can back up the fingerprint data or the information registered to Password Bank.
- Please use Import/Export menu on Fingerprint Software Management.
- Please also refer to the fingerprint utility **Help** file for more information. You can start it using the following method:
 - Click **Start**, point to **All Programs**, point to **TrueSuite Access Manager** and click **Help**.
 - Click **Start**, point to **All Programs**, point to **TrueSuite Access Manager** and click it. The main screen is displayed. Click **Help** in the upper right corner of the screen.

Set up procedure

Please use the following procedure when first using fingerprint authentication.

Fingerprint registration

Enroll the required authentication data using the Fingerprints Enrollment Wizard.

- *The fingerprint authentication uses the same Windows logon ID and password. If the Windows logon password has not been setup, please do so before registration.*
- *This sensor has memory space for at least 21 fingerprint patterns. You might be able to register more fingerprint patterns depending on the sensor memory usage.*

1. Click **Start**, point to **All Programs**, point to **TrueSuite Access Manager** and click it. Or double click the icon in the Task Bar.
2. The Enter Windows Password screen is displayed. Enter a password into the **Enter Windows Password** field. Click **Next**.
3. The Control Center screen is displayed. Click the non-enrolled finger icon above the finger.
4. The Fingerprint Enrollment screen is displayed. Confirm the message and click **Next**.
5. The Scanning Practice screen is displayed. You can practice swiping your finger. When you have finished practicing swiping your finger, click **Next**.
6. The Fingerprint Image Capture screen is displayed. Follow the onscreen instructions and use the same finger you have selected under the Control Center to swipe your finger with good images three times for the fingerprint template to be created.
7. In case of finger injury or authentication failure, it is recommended that another fingerprint also be enrolled. The following message will be displayed: [We recommended enrolling at least two fingerprint images.] Click **OK** and repeat steps 3, 4, 5 and 6 with another finger.

How to delete the fingerprint data

Saved fingerprint data is stored in the Non-volatile memory inside the fingerprint sensor. If you hand over the PC to others, or dispose of it, the following operations are recommended.

1. Click **Start**, point to **All Programs**, point to **TrueSuite Access Manager** and click it.
2. The **TrueSuite Access Manager** Fingerprint Software screen is displayed.
3. Enter your Windows Password and click **Next** to enter the Control Center. Or swipe your enrolled finger to enter the Control Center.
4. The user's fingers screen is displayed.
 - To delete all registered fingerprints:
 1. Click **Delete All Fingerprint**
 2. Follow the on-screen instructions to delete the registered fingerprints
 - To delete individual fingerprints:
 1. Click the fingerprint mark above the registered finger
 2. Are you sure you want to delete this fingerprint? will be displayed on screen, click **Yes** button.

5. When **Delete All Fingerprints** is selected, the user selection screen will be displayed, so select which user's fingerprint data to delete.
 - Selecting **Delete current user's fingerprints** will delete the fingerprint data for the currently logged in user.
 - Selecting **Delete all users' fingerprints** will delete the fingerprint data for all users, however this item can only be selected if the currently logged in user has administrator privileges.

A message will be displayed asking for confirmation to delete the fingerprint.

Windows logon via fingerprint authentication

In place of the usual Windows logon by ID and password, fingerprint authentication also allows logon to Windows.

This is useful especially when many users are using the PCs, as user selection can be skipped.

Fingerprint authentication procedure

1. Start up the computer.
2. The **Logon Authorization** screen is displayed. Choose any of the enrolled fingers and swipe the fingerprint on the sensor.
If authentication is successful, the user will be logged on to Windows.



- *If the fingerprint authentication fails, please logon using the Windows logon password.*
- *Please logon using the Windows logon password if the fingerprint authentication failed for five times. To logon using the Windows logon password, enter the Windows logon password at the [Welcome] screen as normal.*
- *A warning message will be displayed when authentication is abnormal or authentication is not successful within a fixed duration.*

Fingerprint system boot authentication

General

The fingerprint authentication system can be used to replace the keyboard based User Password authentication system when booting up.

If you do not want to use the fingerprint authentication system for password authentication when booting up, but prefer to use the keyboard-based system instead, press the **ESC** key or click **Switch User** button when the Fingerprint System Authentication screen is displayed. This will switch the password input screen to the keyboard-based one.



- *It is necessary to register the User Password before using the fingerprint Pre-OS feature and its extended function, the fingerprint Single Sign-On feature. Please use TOSHIBA HW Setup to register the User Password.*
- *If you fail fingerprint authentication more than five times, you must enter the User Password or Supervisor Password manually to start the computer.*
- *When swiping, please do it slowly and at a constant speed. If this does not improve the authentication rate, please adjust the speed.*
- *If there are any changes in the environment or settings related to authorization, you will be required to provide authorization information such as a User Password and HDD password.*

How to enable fingerprint system boot authentication settings

It is necessary to first enroll your fingerprint with the TrueSuite Access Manager application prior to enabling and configuring the fingerprint Pre-OS feature.

Check that your fingerprint is enrolled before configuring the settings.

1. Swipe your finger across the fingerprint sensor. Or enter Windows password and click **Next**.
2. Click **settings**.
3. The **Administrator Settings** screen is displayed. Place a checkmark in "Enable Pre-OS Fingerprint Authentication" and click **OK**.

The modified configuration for fingerprint Pre-OS feature becomes effective the next time the system is booted up.

Fingerprint Single-Swipe Sign-On feature

General

This is a feature that allows the user to complete the authentication for both the User Password (and optionally, the HDD user and Supervisor passwords) and logging on to Windows using only one fingerprint authentication when booting up. It is necessary to register the User Password and Windows Logon password before using the fingerprint Pre-OS feature and this fingerprint Single Sign-On feature. Please use TOSHIBA HW Setup to register your User Password.

Only one fingerprint authentication is required to replace the User Password (and, if selected, the HDD user and Supervisor passwords) and Windows Logon password.

How to enable fingerprint Single-Swipe Sign-On feature

It is necessary to first enroll your fingerprint with the TrueSuite Access Manager application prior to enabling and configuring the fingerprint Single Sign-On feature. Check that the fingerprint is enrolled before configuring the settings.

1. Swipe your finger across the fingerprint sensor. Or enter Windows password and click **Next**.
2. Click **settings**.
3. The **Administrator Settings** screen is displayed. Place a checkmark in "Enable Pre-OS Fingerprint Authentication".
4. Then, place a checkmark in "Enable Single Sign-On Fingerprint Authentication" and click **OK**.

The modified configuration for the fingerprint Single Sign-On feature becomes effective the next time the system is booted up.

Fingerprint utility limitations

TOSHIBA does not guarantee that the fingerprint utility technology will be completely secure or error-free. TOSHIBA does not guarantee that the fingerprint utility will accurately screen out unauthorized users at all times. TOSHIBA is not liable for any failure or damage that might arise out of the use of the fingerprint software or utility.



- *The fingerprint sensor compares and analyzes the unique characteristics in a fingerprint. However, there may be instances where certain users are unable to register their fingerprints due to insufficient unique characteristics in their fingerprints.*
- *The recognition success rate may differ from user to user.*

USB Sleep and Charge function

Your computer can supply USB bus power (DC5V) to the USB port even when the power of the computer is turned OFF. "Power OFF" includes sleep mode, hibernation mode or shutdown state.

This function can only be used for ports that support the USB Sleep and Charge function (hereinafter called "compatible ports").

Compatible ports are USB ports that have the (⚡) symbol icon.

You can use the USB Sleep and Charge function to charge certain USB compatible external devices such as mobile phones or portable digital music players.

However, the USB Sleep and Charge function may not work with certain external devices even if they are compliant with the USB specification. In those cases, turn the power of the computer ON to charge the device.



- *The USB Sleep and Charge function only works for compatible ports. This function is disabled in the default setting. To enable it, you must change [Disabled] to [Enabled] in the HW setup.*
- *When USB Sleep and Charge function is set to [Enabled] in HW Setup, USB bus power (DC5V) will be supplied to compatible ports even when the power of the computer is turned OFF. USB bus power (DC5V) is similarly supplied to the external devices which are connected to the compatible ports. However, some external devices cannot be charged solely by supplying USB bus power (DC5V). As for the specifications of the external devices, please contact the device manufacturer or check the specifications of the external devices thoroughly before use.*
- *Using the USB sleep and charge function to charge external devices will take longer than charging the devices with their own chargers.*
- *If external devices are connected to compatible ports when the AC adaptor is not connected to the computer, the battery of the computer will be depleted even when the power of the computer is turned OFF. As such, we recommend that you connect the AC adaptor to the computer when using the USB sleep and charge function.*
- *External devices connected to the USB bus power (DC5V) function that interfaces with the power ON/OFF of the computer may always be in an operational state.*
- *When there is a current overflow of the external devices connected to the compatible ports, USB bus power (DC5V) supply may be stopped for safety reasons.*



Metal paper clips or hair pins/clips will generate heat if they come into contact with USB ports. Do not allow USB ports to come into contact with metal products, for example when carrying the computer in your bag.

How to enable/disable USB sleep and charge function

You can set enable/disable USB sleep and charge function in HW setup. Please refer to the [USB Sleep and Charge function](#) in Chapter7.

Using optical disc drives

Operation is the same for all other disc drives. The full-size drive provides high-performance execution of CD/DVD-based programs. You can run CD/DVD without an adaptor. When the computer is accessing a CD/DVD, an indicator on the drive glows.



Use the TOSHIBA DVD PLAYER application to view DVD-Video discs.

If you have a DVD Super Multi (+-R DL) drive, refer also to the Writing CD/DVDs on DVD Super Multi (+-R DL) drive section for precautions on writing to CD/DVDs.

Loading discs

To load CD/DVD, follow the steps below and refer to figures.

- a. When the power is on, press the eject button to open the drawer slightly.

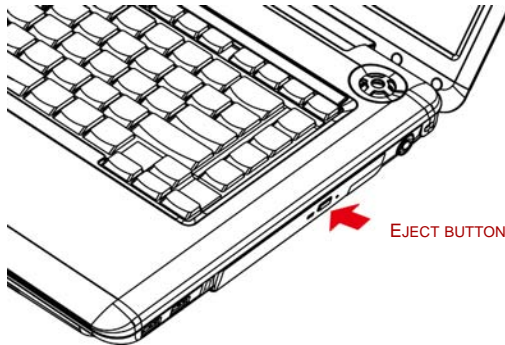

Figure 4-3 Pressing the eject button

- b. Pressing the eject button will not open the drawer when the drive's power is off. If the power is off, you can open the drawer by inserting a slender object (about 15 mm) such as a straightened paper clip into the eject hole just to the right of the eject button.

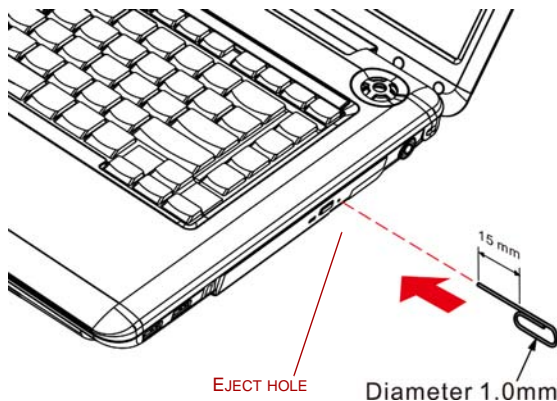

Figure 4-4 Manual release with the eject hole

2. Grasp the drawer gently and pull until it is fully opened.

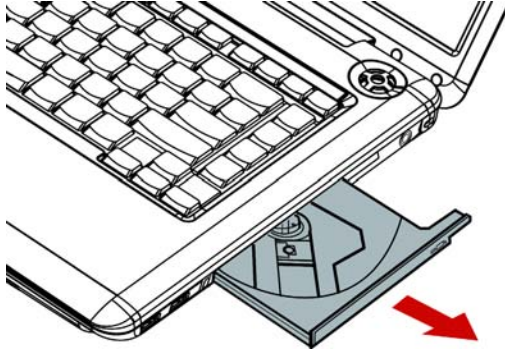

Figure 4-5 Pulling the drawer open

3. Lay the CD/DVD, label side up, in the drawer.

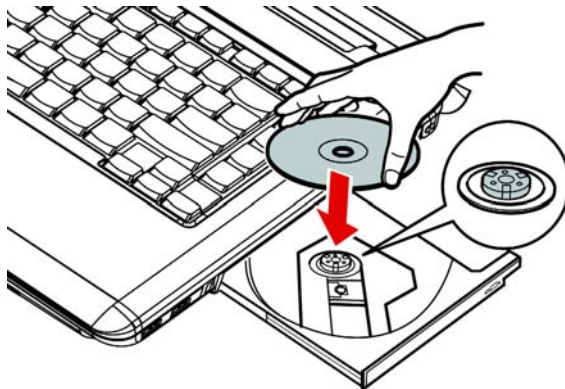

Figure 4-6 Inserting a CD/DVD



When the drawer is fully opened, the edge of the computer will extend slightly over the CD/DVD tray. Therefore, you will need to turn the CD/DVD at an angle when you place it in the tray. After seating the CD/DVD, however, make sure it lies flat, as shown in above figure.



- Do not touch the laser lens. Doing so could cause misalignment.
- Do not keep foreign matter from entering the drive. Check the back edge of the tray to make sure it carries no debris before closing the drive.

4. Press gently at the center of the CD/DVD until you feel it click into place. The CD/DVD should lie below the top of the spindle, flush with the spindle base.

5. Push the center of the drawer to close it. Press gently until it locks into place.



If the CD/DVD is not seated properly when the drawer is closed, the CD/DVD might be damaged. Also, the drawer might not open fully when you press the eject button.

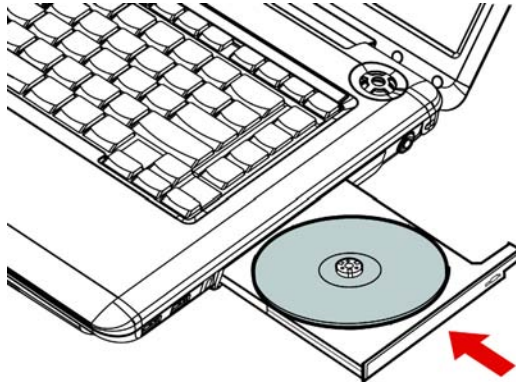

Figure 4-7 Closing the drawer

Removing discs

To remove the CD/DVD, follow the steps below and refer to below figure.



Do not press the eject button while the computer is accessing the drive. Wait for the optical disc drive indicator to go out before you open the drawer. Also, if the CD/DVD is spinning when you open the drawer, wait for it to stop before you remove it.

1. To pop the drawer partially open, press the eject button. Gently pull the drawer out until it is fully opened.



- *When the drawer pops open slightly, wait a moment to make sure the CD/DVD has stopped spinning before pulling the drawer fully open.*
- *Turn off the power before you use the eject hole. If the CD/DVD is spinning when you open the drawer, the CD/DVD could fly off the spindle and cause injury.*

- The CD/DVD extends slightly over the sides of the drawer so you can grasp it. Hold the CD/DVD gently and lift it out.

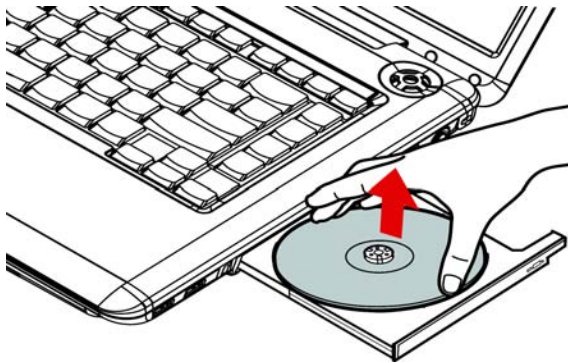

Figure 4-8 Removing a CD/DVD

- Push the center of the drawer to close it. Press gently until it locks into place.

Function button

This section describes about Function button.

Six buttons are provided with some models.



Figure 4-9 Function button

Icon	Function button	DVD	*CD/None
	Mute	Mute	Mute
	CD/DVD	Launch TOSHIBA DVD PLAYER	Launch Windows Media Player
	Play/Pause	Play/Pause	Play/Pause
	Stop	Stop	Stop
	Previous	Previous chapter	Previous tune
	Next	Next chapter	Next tune

*Windows Media Player 11

Writing CD/DVDs on DVD Super Multi (+-R DL) drive

Some models are equipped with a full-size DVD Super Multi (+-R DL) drive, which can be used to write data to either CD-R/-RW or DVD-R/-RW/+R/+RW/-RAM/+R DL/-R DL discs. The following applications for writing are supplied: TOSHIBA Disc Creator. Ulead DVD MovieFactory® for TOSHIBA, which is a product of Ulead Systems, Inc.

Important message (DVD Super Multi (+-R DL) drive)

Before you write or rewrite to CD-R/-RW or DVD-R/-RW/+R/+RW/-RAM/+R DL/-R DL disc, read and follow all setup and operating instructions in this section.

If you fail to do so, the DVD Super Multi (+-R DL) drive may not function properly, and you may fail to write or rewrite, lose data or incur other damage.

Before writing or rewriting

- Based on TOSHIBA's limited compatibility testing, we suggest the following manufacturers of CD-R/-RW and DVD-R/+R/-RW/+RW/-RAM/+R DL/-R DL disc. However, in no event does TOSHIBA guarantee the operation, quality or performance of any disc. Disc quality can affect write or rewrite success rates.

CD-R:

TAIYO YUDEN CO., LTD.
MITSUBISHI KAGAKU MEDIA CO., LTD.
RICOH CO., LTD.

CD-RW: (High-Speed, Multi-Speed)

MITSUBISHI KAGAKU MEDIA CO., LTD.

CD-RW: (Ultra-Speed)

MITSUBISHI KAGAKU MEDIA CO., LTD.

DVD-R:

DVD Specifications for DVD-R Disc for General Version 2.0
HITACHI MAXELL LTD.
MATSUSHITA ELECTRIC INDUSTRIAL CO., LTD.
TAIYO YUDEN CO., LTD.

DVD+R:

MITSUBISHI KAGAKU MEDIA CO., LTD.
RICOH CO., LTD.

DVD-RW:

DVD Specifications for DVD-RW Disc for General Version 1.2
MITSUBISHI KAGAKU MEDIA CO., LTD.
VICTOR COMPANY OF JAPAN, LTD.

DVD+RW:

MITSUBISHI KAGAKU MEDIA CO., LTD.

DVD-RAM:

DVD Specifications for DVD-RAM Disc for Version 2.0, 2.1 or 2.2
MATSUSHITA ELECTRIC INDUSTRIAL CO., LTD.
HITACHI MAXELL LTD.

DVD+R DL:

MITSUBISHI KAGAKU MEDIA CO., LTD.
RICOH CO., LTD.

DVD-R DL:

MITSUBISHI KAGAKU MEDIA CO., LTD.

DVD-R for Labelflash™:

FUJIFILM CORPORATION.

DVD+R for Labelflash™:

FUJIFILM CORPORATION.



This DVD Super Multi (+R DL) drive cannot use discs that allow writing faster than 8x speed (DVD-R, DVD+R and DVD+RW media), 6x speed (DVD-RW media), 5x speed (DVD-RAM media) and 4x speed (DVD-R DL and DVD-R DL media).

- If the disc is poor in quality, dirty or damaged, writing or rewriting errors may occur. Be careful to check the disc for dirt or damage before you use it.
- The actual number of rewrites to CD-RW, DVD-RW, DVD+RW or DVD-RAM is affected by the quality of the disc and the way it is used.
- There are two types of DVD-R discs: authoring and general use discs. Do not use authoring discs. Only general use discs can be written to by a computer drive.
- We can support only format 1 of DVD-R DL. Therefore you can not do the additional writing. If your data is under DVD-R(SL) capacity, we suggest to use DVD-R(SL) media.
- You can use DVD-RAM discs that can be removed from a cartridge and DVD-RAM discs designed without a cartridge. You cannot use a disc with a 2.6 GB single-sided capacity or 5.2 GB double-sided capacity.
- Other DVD-ROM drives for computers or other DVD players may not be able to read DVD-R/-R DL/-RW or DVD+R/+R DL/+RW discs.

- Data written to a CD-R/DVD-R/DVD+R disc cannot be deleted either in whole or in part.
- Data deleted (erased) from a CD-RW and DVD-RW, DVD+RW and DVD-RAM disc cannot be recovered. Check the content of the disc carefully before you delete it. If multiple drives that can write data to discs are connected, be careful not to delete data from the wrong drive.
- In writing to a DVD-R/-R DL/-RW, DVD+R/+R DL/+RW or DVD-RAM disc, some disc space is required for file management, so you may not be able to write the full capacity of the disc.
- Since the disc is based on the DVD standard, it will be filled with dummy data if the written data is less than about 1 GB. Even if you write only a small amount of data, it might take time to fill in the dummy data.
- DVD-RAM formatted by FAT32 cannot be read in Windows 2000 without DVD-RAM Driver Software.
- When multiple drives that can write data to discs are connected, be careful not to write to the wrong drive.
- Be sure to connect the universal AC adaptor before you write or rewrite.
- Before you enter sleep/hibernation mode, be sure to finish DVD-RAM writing. Writing is finished if you can eject DVD-RAM media.
- Be sure to close all other software programs except the writing software.
- Do not run software such as a screen saver, which can put a heavy load on the CPU.
- Operate the computer in the full-power mode. Do not use power-saving features.
- Do not write while virus check software is running. Wait for it to finish, and then disable virus detection programs including any software that checks files automatically in the background.
- Do not use hard disk utilities, including those intended to enhance HDD access speed. They may cause unstable operation and data damage.
- Write from the computer's HDD to the CD/DVD. Do not try to write from shared devices such as a LAN server or any other network device.
- Writing with software other than TOSHIBA Disc Creator is not recommended.

When writing or rewriting

Please observe/consider the following when you write or rewrite to a CD-R/-RW, DVD-R/-R DL/-RW/-RAM or DVD+R/+R DL/+RW disc.

- Do not perform any of the following actions:
 - Change users in the Windows Vista™ operating system.
 - Operate the computer for any other function, including use of a mouse or touchpad, closing/opening the LCD panel.
 - Start a communication application such as a modem.
 - Apply impact or vibration to the PC.

- Install, remove or connect external devices, including items such as a SD/SDHC memory card, ExpressCard, Memory Stick/Memory Stick Pro, xD picture card, MultiMediaCard, USB device, external monitor, i.LINK device, or an optical digital device.
- Use the Audio/Video control button to reproduce music or voice.
- Open the optical disc drive.
- Do not use shut down/log off and sleep/hibernation while writing or rewriting.
- Make sure writing or rewriting is completed before going into sleep/hibernation. Writing is completed if you can open the DVD Super Multi (+-R DL) drive tray.
- Set the computer on a level surface and avoid places subject to vibration such as airplanes, trains, or cars. Do not use an unstable surface such as a stand.
- Keep mobile phones and other wireless communication devices away from the computer.
- Always copy data from the HDD to the optical disc. Do not use cut-and-paste. The original data will be lost if there is a write error.

Disclaimer (DVD Super Multi (+-R DL) drive)

TOSHIBA does not bear responsibility for the following:

- Damage to any CD-R/-RW or DVD-R/-R DL/-RW/+R/+R DL/+RW/DVD-RAM disc that may be caused by writing or rewriting with this product.
- Any change or loss of the recorded contents of CD-R/-RW or DVD-R/-R DL/-RW/+R/+R DL/+RW/DVD-RAM disc that may be caused by writing or rewriting with this product, or for any business profit loss or business interruption that may be caused by the change or loss of the recorded contents.
- Damage that may be caused by using third party equipment or software. Given the technological limitations of current optical disc writing drives, you may experience unexpected writing or rewriting errors due to disc quality or problems with hardware devices. Also, it is a good idea to make two or more copies of important data, in case of undesired change or loss of the recorded contents.

TOSHIBA Disc Creator

Note the following limitations when you use TOSHIBA Disc Creator:

- DVD-Video cannot be created using TOSHIBA Disc Creator.
- DVD-Audio cannot be created using TOSHIBA Disc Creator.
- You cannot use TOSHIBA Disc Creator's 'Audio CD for Car or Home CD Player' function to record music to DVD-R, DVD-R DL, DVD-RW, DVD+R, DVD+R DL or DVD+RW media.
- Do not use the 'Disc Backup' function of TOSHIBA Disc Creator in order to copy DVD Video or DVD-ROM material that has copyright protection.

- DVD-RAM discs cannot be backed up using the 'Disc Backup' function of TOSHIBA Disc Creator.
- You cannot back up CD-ROM, CD-R or CD-RW media to DVD-R, DVD-R DL or DVD-RW media using the 'Disc Backup' function of TOSHIBA Disc Creator.
- You cannot back up CD-ROM, CD-R or CD-RW media to DVD+R, DVD+R DL or DVD+RW media using the 'Disc Backup' function of TOSHIBA Disc Creator.
- You cannot back up DVD-ROM, DVD Video, DVD-R, DVD-R DL, DVD-RW, DVD+R, DVD+R DL or DVD+RW to CD-R or CD-RW media using the 'Disc Backup' function of TOSHIBA Disc Creator.
- TOSHIBA Disc Creator cannot record in packet format.
- You might not be able to use the 'Disc Backup' function of TOSHIBA Disc Creator to back up a DVD-R, DVD-R DL, DVD-RW, DVD+R, DVD+R DL or DVD+RW disc that was made with other software on a different optical media recorder.
- If you add data to a DVD-R, DVD-R DL, DVD+R or DVD+R DL disc that you have already recorded to, you might not be able to read the added data under some circumstances. For example, it cannot be read under 16-bit operating systems, such as Windows 98SE and Windows Me, while in Windows NT4 you will need Service Pack 6 or later, and in Windows 2000, you will need Service Pack 2. In addition to this, some DVD-ROM and DVD-ROM/CD-RW drives cannot read this added data regardless of the operating system.
- TOSHIBA Disc Creator does not support recording to DVD-RAM discs - to achieve this you should use Windows Explorer or another similar utility.
- When you back up a DVD disc, be sure that the source drive supports recording to DVD-R, DVD-R DL, DVD-RW, DVD+R, DVD+R DL or DVD+RW media - if this is not the case then the source disc might not be backed up correctly.
- When you back up a DVD-R, DVD-R DL, DVD-RW, DVD+R, DVD+R DL or DVD+RW disc, be sure to use the same type of disc.
- You cannot partially delete any data written to a CD-RW, DVD-RW, DVD+RW disc.

Data verification

To verify that data has been written or rewritten correctly to a data CD/DVD you should follow the steps below before you begin the write/rewrite process:

1. Display the setting dialog box by one of the following two steps:
 - Click the setting button () for writing on the main toolbar in the **Data CD/DVD** mode.
 - Select **Setting for writing** → **Data CD/DVD** in the **Setting** menu.
2. Mark the **Verify written data** check box.

3. Select **File Open** or **Full Compare** mode.
4. Click the **OK** button.

How to learn more about TOSHIBA Disc Creator

Please refer to the Help files for additional TOSHIBA Disc Creator information.

Video

You can record video using Ulead DVD MovieFactory® for TOSHIBA.

When using Ulead DVD MovieFactory® for TOSHIBA

How to make a Labelflash DVD

Simplified steps for making a Labelflash DVD:

1. Insert a Labelflash disc in DVD drive.



Set **PRINTING SIDE** for underside.

2. Click **Start** → **All Programs** → **DVD MovieFactory for TOSHIBA** → **Ulead DVD MovieFactory for TOSHIBA Launcher** to launch DVD MovieFactory.
3. Click **Print Disc Label** → **Label Printing**. Ulead Label@Once is started.
4. Click the **General** tab.
5. Choose **DVD Drive** for Printer. e.g.<E:> PIONEER DVD...
6. Add and customize the look of your images and text.
7. Click **Labelflash setting** and choose **Draw Quality**.
8. Click **Print**.

How to make a DVD-Video

Simplified steps for making a DVD-Video from video data captured from a DV-Camcorder:

1. Click **Start** → **All Programs** → **DVD MovieFactory for TOSHIBA** → **Ulead DVD MovieFactory for TOSHIBA Launcher** to launch DVD MovieFactory.
2. Insert a DVD-RW or DVD+RW disc in Burner.
3. Click **Video Disc** → **Burn Video to Disc** to launch **Direct Recording** dialog box ,choose **DVD-Video/+VR** to invoke **Straight Capture to Disc** Page.
4. Choose **DVD-Video** format.
5. Choose the capture source is **DV**.
6. Press **Capture** button.

Simplified steps for making a DVD-Video from adding video source:

1. Click **Start** → **All Programs** → **DVD MovieFactory for TOSHIBA** → **Ulead DVD MovieFactory for TOSHIBA Launcher** to launch DVD MovieFactory.
2. Click **Video Disc** → **New Project** to invoke 2nd Launcher, choose your project type, then invoke DVD MovieFactory.
3. Add source from HD Disk by click **Add Video files** button to invoke browser dialog box.
4. Choose the source video then go to Next page to apply Menu.
5. After choose the menu template, press **Next** button to go to **Burning Page**.
6. Choose the output type then press **Burn** button.

How to learn more about Ulead DVD MovieFactory®

Please refer to the Help and Manual files for additional Ulead DVD MovieFactory information.

Important information for use

Note the following limitations when you write Video DVD:

1. Editing digital video
 - Log in with Administrator rights to use DVD MovieFactory.
 - Make sure that your computer is running on AC power when using DVD MovieFactory.
 - Operate the computer at Full Power. Do not use power-saving features.
 - While you are editing DVD, you can display preview. However, if another application is running. The preview might not display properly.
 - DVD MovieFactory cannot edit or play copy protected content.
 - Do not enter sleep or hibernation mode while using DVD MovieFactory.
 - Do not operate DVD MovieFactory immediately after turning on the computer. Please wait until all Disc Drive activity has stopped.
 - When recording to a DV-Camcorder, to ensure you capture all of your data, let the camcorder record for a few seconds before you begin recording your actual data.
 - CD recorder, JPEG functions, DVD-Audio, mini DVD and Video CD functions are not supported in this version.
 - While recording video to DVD, please close all other programs.
 - Do not run software like a screen saver because it can put a heavy load on the CPU.
 - Do not support mp3 decode and encode.

2. Before recording the video to DVD
 - When you record DVD disc, please use only discs recommended by the Drive manufacturer.
 - Do not set the working drive to a slow device like a USB 1.1 hard disk drive or it will fail to write DVD.
 - Do not perform any of the following actions:
 - Operate the computer for any other function, including using a mouse or touchpad, or closing/opening the display panel.
 - Bump or cause vibration to the computer.
 - Use the Mode control button and Audio/Video control button to reproduce music or voice.
 - Open the DVD drive.
 - Install, remove or connect external devices, including items such as a SD/SDHC memory card, ExpressCard, Memory Stick/Memory Stick Pro, xD picture card, MultiMediaCard, USB device, external monitor, i.LINK device, or an optical digital device.
 - Please verify your disc after recording important data.
 - DVD-R/+R/+RW disc cannot be written in VR format.
 - Not support to output VCD and SVCD format.
3. About Straight to Disc
 - Not support to record on DVD-R/+R disc
 - Not support to record DVD+VR format by HDV
 - HDV support to burn DVD-Video only
 - DVD-VR format not support to add Menu
4. About recorded DVDs
 - Some DVD-ROM drives for personal computers or other DVD players may not be able to read DVD-R/+R/-RW/-RAM discs.
 - When playing your recorded disc on your computer, please use InterVideo WinDVD software application.
 - If you use an over-used rewritable disc, the full formatting might be locked. Please use a brand new disc.

Media care

This section provides tips on protecting data stored on your CD/DVD. Handle your media with care. The following simple precautions will increase the lifetime of your media and protect the data stored on them:

CD/DVD

1. Store your CD/DVD in the container they came in to protect them and keep them clean.
2. Do not bend the CD/DVD.

3. Do not write on, apply a sticker to, or otherwise mark the surface of the CD/DVD that contains data.
4. Hold the CD/DVD by its outside edge or the edge on the center hole. Fingerprints on the surface can prevent the drive from properly reading data.
5. Do not expose to direct sunlight, extreme heat or cold. Do not place heavy objects on your CD/DVD.
6. If your CD/DVD become dusty or dirty, wipe them with a clean dry cloth. Wipe from the center out, do not wipe in a circular direction around the CD/DVD. If necessary, use a cloth dampened in water or a neutral cleaner. Do not use benzine, thinner or similar cleaner

Using the web camera

Built-in web camera is provided with some models.

This section describes the bundled webcam utility, which can capture still and video images. The web camera will auto-run when Windows starts.



Please unstick the protective plastic-film before using the Web Camera.

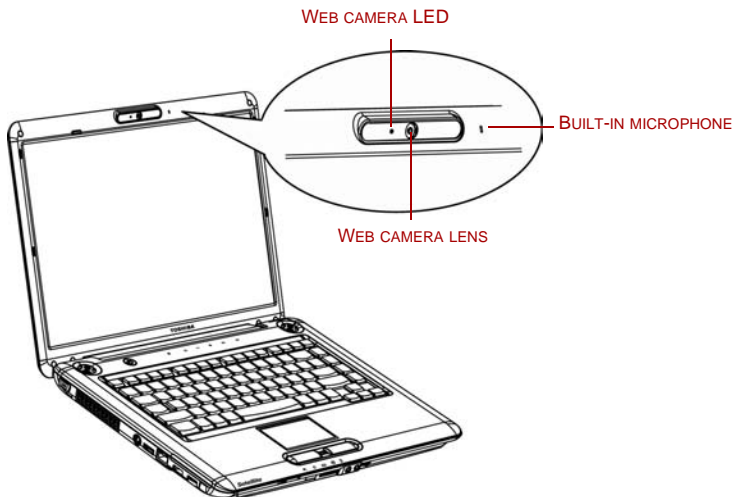

Figure 4-10 Web camera

Using the software

The web camera software is pre-configured to start when you turn on Windows Vista™; if you need to restart it go to **Start** → **All Programs** → **Camera Assistant Software** → **Camera Assistant Software**.



Figure 4-11 Using the Software

Capture Still Image	Click to see a preview of the captured image; you can also e-mail the image.
Video Recording	Click to prepare for recording. Click again to start recording. One more to stop recording and see preview of the video.
Audio Recording	Click to start recording, Click again to stop and listen to a preview of the audio.
Function	Accesses additional functions: About, Player, Effects, Properties, Settings and Help.
About	Displays software manufacturer details.
Player	Plays video files.
Effects	Chooses images to be displayed on the capture screen.
Properties	Chooses from the Options tab to flip, zoom, flicker rate, night mode and backlight compensation; in the Image tab change the colour settings; in the profile tab change the lighting conditions.

Settings	Chooses from the : Options tab to change the tool position; the Picture tab to select picture output options such as size, export file and saving location; the Video tab to choose output settings such as Frame Rate, Size, Compression and the file save path; the Audio Device , Compression, Volume and file save path.
Help	Displays the help files for the software.

Using the microphone

You can use the built-in or an external microphone that connects to the microphone jack to record monaural sounds into your applications. It can also be used to issue voice commands to applications that support such functions. (Built-in microphone is provided with some models)

Since your computer has a microphone and speaker, “feedback” may be heard under certain conditions. Feedback occurs when sound from the speaker is picked up in the microphone and amplified back to the speaker, which amplifies it again to the microphone.

This feedback occurs repeatedly and causes a very loud, high-pitched noise. It is a common phenomenon that occurs in any sound system when the microphone input is output to the speaker (throughput) and the speaker volume is too loud or too close to the microphone. You can control throughput by adjusting the volume of your speaker or through the Mute function in the Master Volume panel. Refer to your Windows documentation for details on using the Master Volume panel.

Using the TOSHIBA Face Recognition

TOSHIBA Face Recognition uses a face verification library to verify the face data of users when they log in to Windows. The user can thus avoid having to enter a password or the like, which makes the login process easier. This software is preinstalled with some models.

Note on Use

- TOSHIBA Face Recognition does not guarantee the correct identification of a user. Changes to the likeness of a registrant, such as hair style changes, wearing a cap, or wearing glasses may effect the recognition rates when such changes occur after the registrant had registered.
- TOSHIBA Face Recognition may incorrectly recognize faces that are similar to a registrant.
- For high security purposes, TOSHIBA Face Recognition is not a suitable substitute for Windows passwords. When security is a high priority, use your established Windows passwords to log in.

- Bright background light and/or shadows may prevent a registrant from being recognized correctly. In that case, log in using your Windows password. If recognition of a registrant fails repeatedly, refer to your computer documentation to learn ways to improve recognition performance.

Disclaimer

Toshiba does not guarantee that the face recognition utility technology will be completely secure or error-free. Toshiba does not guarantee that the face recognition utility will accurately screen out unauthorized users at all times. Toshiba is not liable for any failure or damage that might arise out of the use of the face recognition software or utility.

TOSHIBA, ITS AFFILIATES AND SUPPLIERS SHALL HAVE NO RESPONSIBILITY FOR DAMAGE TO OR LOSS OF ANY BUSINESS, PROFITS, PROGRAMS, DATA, NETWORK SYSTEMS OR REMOVABLE STORAGE MEDIA ARISING OUT OF OR RESULTING FROM THE USE OF THE PRODUCT, EVEN IF ADVISED OF THE POSSIBILITY THEREOF.

How to register the Face Recognition Data

Take a picture for facial verification purposes, and register the data needed when you log in. To register the data needed when you log in, follow the steps as described below:

1. To launch this utility, click **Start** → **All Programs** → **TOSHIBA** → **Utilities** → **TOSHIBA Face Recognition**.
 - The **Registration** screen is displayed for a logged-in user whose face has not been registered.
 - The **Management** screen is displayed for a logged-in user whose face has already been registered.
2. Click the **Register face** button in the **Management** screen. The Registration screen is displayed.
 - If you wish to practice, click on the **Next** button in the **Registration** screen.
 - If you do not wish to practice, click on the **Skip** button in the **Registration** screen.
3. Click the **Next** button to start the guide.
4. First, take a picture while moving your neck slightly to the left and right.
5. Now take a picture while moving your neck down and up.
 - Click the **Back** button to practice the guide once more.
6. Click the **Next** button to start image-capturing process. Adjust the position of your face so that it fits within the face-shaped frame.
7. Once your face has been positioned properly, the recording will commence. Start moving your neck very slightly to the left and right, and then move your neck down and up.

8. Registration will end after you have repeatedly moved your neck left, right, down and up. When the register succeeds, below message will be displayed on the screen:

Registration successful. Now we'll do the verification test. Click the Next button.

Click the **Next** button to perform the verification test.
9. Perform the verification test. Face the screen as you do when you register.
 - If verification fails, click the **Back** button and re-register. Please refer to step 8 from step 6.
10. If verification is successful, click the **Next** button and register an account.
11. Register the account. Fill in the account registration fields.
 - Fill in the all fields.

When you have finished it, click **Next** button.
12. The **Management** screen is displayed. The registered account name will be displayed. Clicking on it will cause the captured image of your face to be displayed on the left.

How to Delete the Face Recognition Data

Delete image data, account information, and personal record data created during registration. To delete the Face Recognition Data, follow the steps as described below:

1. To launch this utility, click **Start** → **All Programs** → **TOSHIBA** → **Utilities** → **TOSHIBA Face Recognition**. The **Management** screen is displayed.
2. Select a user which is deleted in the **Management** screen.
3. Click the **Delete** button. "**You are about to delete the user data. Would you like to continue?**" will be displayed on the screen
 - If you do not want the data to be deleted, click the **No** button and you will then be returned to the **Management** screen.
 - Clicking on the **Yes** button will remove the selected user from the **Management** screen.

How to launch the help file

For further information on this utility, please refer to help file.

- To launch the help file, click **Start** → **All Programs** → **TOSHIBA** → **Utilities** → **TOSHIBA Face Recognition Help**.

Windows Logon via TOSHIBA Face Recognition

This section explains how to login to Windows with TOSHIBA Face Recognition. Two authentication modes are provided.

- **AUTO Mode Login screen** : If the face authentication tile is selected by default, you can log in without using the keyboard or mouse.
- **1:1 Mode Login screen** : This mode is essentially the same as AUTO mode, but the **Select Account** screen will appear before the **Display Captured Image** screen, and you will need to select the user account to be authenticated in order to start the authentication process.

AUTO Mode Login screen

1. Turn on the computer.
2. The **Select Tiles** screen will be displayed.
3. Select **Start face recognition**.
4. "**Please turn your face to the camera**" will be displayed.
5. Verification will be performed. If the authentication is successful, the image data taken in step 4 will be faded in and placed over one another.
 - If an error occurs during authentication, you will be returned to the **Select Tiles** screen.
6. **Windows Welcome** screen will be displayed, and will be logged in automatically to Windows.

1:1 Mode Login screen

1. Turn on the computer.
2. The **Select Tiles** screen will be displayed.
3. Select **Start face recognition**.
4. The **Select Account** screen will be displayed.
5. Select the account, and click the **arrow** button.
6. "**Please turn your face to the camera**" will be displayed.
7. Verification will be performed. If the authentication is successful, the image data taken in step 6 will be faded in and placed over one another.
 - If an error occurs during authentication, you will be returned to the **Select Tiles** screen.
8. **Windows Welcome** screen will be displayed, and will be logged in automatically to Windows.
 - If authentication was successful, but an authentication error subsequently occurred during the login to Windows, you will be asked to provide your account information.

Modem

The availability of this feature is depending on the model you purchased. This section describes how to connect and disconnect the internal modem to and from a telephone jack.



The internal modem does not support voice functions. All data and fax functions are supported.



- *In case of a lightning storm, unplug the modem cable from the telephone jack.*
- *Do not connect the modem to a digital telephone line. A digital line will damage the modem.*

Region selection

Telecommunication regulations vary from one region to another, so you will need to make sure the internal modem's settings are correct for the region in which it will be used.

To select a region, follow the steps below.

1. In Windows Vista™, click **Start**, point to **All Programs**, point to **TOSHIBA**, point to **Networking** and click **Modem Region Select**.



Do not use the Country/Region Select function in the Modem setup utility in the Control Panel if the function is available. If you change the Country/Region in the Control Panel, the change may not take effect.

2. The Region Selection icon will appear in the Windows Task Bar.



Figure 4-12 The Region Selection icon (Windows Vista™)

3. Click the icon with the primary mouse button to display a list of regions that the modem supports. A sub menu for telephony location information will also be displayed. A check will appear next to the currently selected region and telephony location.
4. Select a region from the region menu or a telephony location from the submenu.
 - When you click a region it becomes the modem's region selection, and the New Location for telephony will be set automatically.
 - When you select a telephony location, the corresponding region is automatically selected and it becomes the modem's current region setting.

Properties menu

Click the icon with the secondary mouse button to display the following menu.

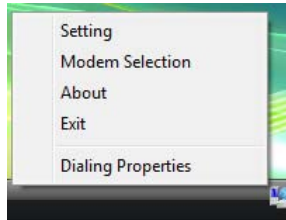

Figure 4-13 The menu list (Windows Vista™)

Setting

You can enable or disable the following settings:

AutoRun Mode

The Region Select utility starts automatically when you start up the operating system.

Open the Dialing Properties dialog box after selecting region.

The dialing properties dialog box will be displayed automatically after you select the region.

Location list for region selection.

A submenu appears displaying location information for telephony.

Open dialog box, if the modem and Telephony Current

Location region code do not match.

A warning dialog box is displayed if current settings for region code and telephony location are incorrect.

Modem Selection

If the computer cannot recognize the internal modem, a dialog box is displayed. Select the COM port for your modem to use.

Dialing Properties

Select this item to display the dialing properties.



If you are using the computer in Japan, the Telecommunications Business Law requires that you select Japan region mode. It is illegal to use the modem in Japan with any other selection.

Connecting

To connect the internal modem cable, follow the steps below.

1. Plug one end of the modular cable into the modem jack.

2. Plug the other end of the modular cable into a telephone jack.

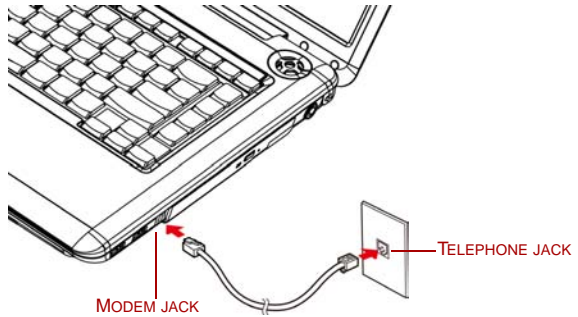

Figure 4-14 Connecting the internal modem



Do not pull on the cable or move the computer while the cable is connected.

Disconnecting

To disconnect the internal modem cable, follow the steps below.

1. Pinch the lever on the connector in the telephone jack and pull out the connector.
2. Disconnect the cable from the computer in the same manner.

Using the FM tuner

The availability of this feature is depending on the model you purchased.

1. Plug the FM tuner antenna into the FM tuner jack.

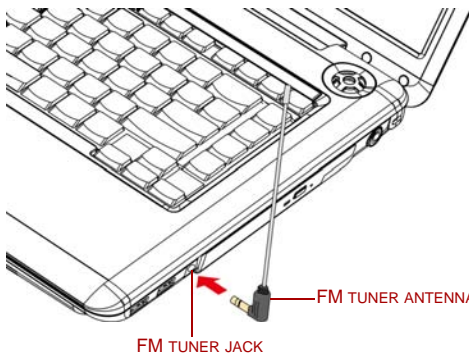

Figure 4-15 Plug FM tuner antenna into the jack

2. Select **Start** → **All Programs** → **NXP FM Tuner** to start FM software.

Wireless communications

The computer's wireless communication function supports both Wireless LAN and Bluetooth devices.

Wireless LAN

The Wireless LAN is compatible with other LAN systems based on Direct Sequence Spread Spectrum/Orthogonal Frequency Division Multiplexing radio technology that complies with IEEE 802.11 wireless LAN standard (Revision A, B, G or draft N).

Supported features. It supports the following features:

- Automatic Transmit Rate Select mechanism in the transmit range of 54, 48, 36, 24, 18, 9 and 6 Mbit/s (Revision A and G).
- Automatic Transmit Rate Select mechanism in the transmit range of 11, 5.5, 2 and 1 Mbit/s (Revision B).
- Frequency Channel Selection (Revision A/draft N: 5 GHz, Revision B/G/draft N: 2.4GHz)
- Roaming over multiple channels
- Card Power Management
- Wired Equivalent Privacy (WEP) data encryption, based on the 128 bit encryption algorithm (Atheros module type).
- 11a, 11b, 11g and 11n wireless are based on IEEE 802.11a, 802.11b, 802.11g and 802.11n respectively. The IEEE 802.11n specification has not been finalized and is currently in draft release. The TOSHIBA 11a/b/g/n Wireless LAN Adaptors are based on the draft release version 2.0, of the IEEE 802.11n specification. An adaptor with 11a/b, 11a/b/g or 11a/b/g/n can communicate on any of its supported formats; the actual connection will be based on the access point to which it connects.
- Connection compatibility with the wireless equipment in draft 11n mode is not guaranteed.
- The draft 11n function cannot be used with WEP/TKIP. Draft 11n mode can be used only with WPA-PSK(AES) mode or no security mode.

Security

- Be sure to enable encryption function. Otherwise your computer will allow the illegal access by outsider through wireless LAN to cause illegal instruction, eavesdropping, and loss or destruction of stored data. TOSHIBA strongly recommends the customer to enable the encryption function.
- TOSHIBA is not liable for the eavesdropping of data due to the use of Wireless LAN and the damage thereof.

Bluetooth™ wireless technology

Bluetooth™ wireless technology eliminates the need for cables between electronic devices such as desktop computers, printers and mobile phones. You cannot use the built-in Bluetooth functions and an optional Bluetooth Adaptor simultaneously.

Bluetooth™ wireless technology has the following features:

Worldwide operation

The Bluetooth radio transmitter and receiver operates in the 2.45 GHz band, which is license-free and compatible with radio systems in most countries in the world.

Radio links

You can easily establish links between two or more devices. The link is maintained even if the devices are not within line of sight.

Security

Two advanced security mechanisms ensure a high level of security:

- Authentication prevents access to critical data and makes it impossible to falsify the origin of a message.
- Encryption prevents eavesdropping and maintains link privacy.

Wireless communication switch

You can enable or disable RF transmission(Wireless LAN, Bluetooth and WiMAX) functions on and off, with this switch (Provided with some models). No transmissions are sent or received when the switch is off. Slide the switch toward the right of the computer to turn it on and toward the left of the computer to turn it off.



Set the switch to off in airplanes and hospitals. Check the indicator. It will stop glowing when the wireless communication function is off.

Turn the computer off when you enter an airplane and check the carrier's regulations before you use a computer on board.

Wireless communication indicator

The wireless communication indicator indicates the status of the wireless communication functions.

Indicator status	Indication
Indicator off	Wireless communication switch is set to off.
Indicator glows	Wireless communication switch is on. Wireless LAN, Bluetooth or WiMAX is turned on by an application.

If you used the Task Bar to disable Wireless LAN, restart the computer or follow the procedures below to enable the system to recognize Wireless LAN. Click **Start** → **Control Panel** → **System and Maintenance** → **System** → **Device Manager** → **Network Adaptors**, and right click the wireless device then choose Enable.

It may not be possible to make a network connection to a specified network name using the ad hoc network function.

If this occurs, the new network(*) will have to be configured for all computers connected to the same network in order to re-enable network connections.

* Please be sure to use new network name.

LAN

The computer has built-in support for Ethernet LAN (10 megabits per second, 10BASE-T), Fast Ethernet LAN (100 megabits per second, 100BASE-TX) or Gigabit Ethernet LAN (1000 megabits per second, 1000BASE-T)(depending on model you purchased). This section describes how to connect/disconnect to a LAN.



Do not install or remove an optional memory module while Wake-up on LAN is enabled.



The Wake-up on LAN function consumes power even when the system is off. Leave the AC adaptor connected while using this feature.

Connecting LAN cable



The computer must be configured properly before connecting to a LAN. Logging onto a LAN using the computer's default settings could cause a malfunction in LAN operation. Check with your LAN administrator regarding set-up procedures.

If you are using Fast Ethernet LAN (100 Mbit/s, 100BASE-TX), be sure to connect with a category 5 cable, CAT5, or higher.

If you are using Ethernet LAN (10 Mbit/s, 10BASE-T), connect with a category 3 cable, CAT3, or higher.

If you are using Gigabit Ethernet (1000 megabits per second, 1000BASE-T), connect with a category 5E cable, CAT5E, or higher.

To connect the LAN cable, follow the steps below.

1. Turn off the power to the computer and to all external devices connected to the computer.

2. Plug one end of the cable into the LAN jack. Press gently until you hear the latch click into place.

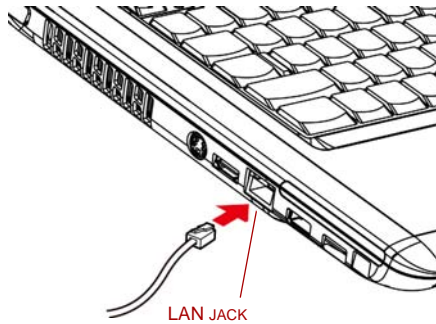

Figure 4-16 Connecting the LAN cable

3. Plug the other end of the cable into a LAN hub connector. Check with your LAN administrator before connecting to a hub.



When the computer is exchanging data with the LAN, the LAN active indicator glows orange. When the computer is connected to a LAN hub but is not exchanging data, the link indicator glows green.

Disconnecting LAN cable

To disconnect the LAN cable, follow the steps below.



Make sure the LAN active indicator (orange LED) is out before you disconnect the computer from the LAN.

1. Pinch the lever on the connector in the computer's LAN jack and pull out the connector.
2. Disconnect the cable from the LAN hub in the same manner. Check with your LAN administrator before disconnecting from the hub.

Cleaning the computer

To help ensure long, trouble-free operation, keep the computer free of dust and use care with liquids around the computer.

- Be careful not to spill liquids into the computer. If the computer does get wet, turn the power off immediately and let the computer dry completely before you turn it on again.
- Clean the computer using a slightly damp (with water) cloth. You can use glass cleaner on the display. Spray a small amount of cleaner on a soft, clean cloth and wipe the screen gently with the cloth.



Never spray cleaner directly onto the computer or let liquid run into any part of it. Never use harsh or caustic chemical products to clean the computer.

Moving the computer

The computer is designed for rugged durability. However, a few simple precautions taken when moving the computer will help ensure trouble-free operation.

- Make sure all disk activities are terminated before moving the computer. Check if the **HDD/ODD/eSATA** indicator and external device indicator are off.
- If a CD/DVD is in the drive, remove it. Also make sure the drawer is securely closed.
- Turn off the power to the computer.
- Disconnect the AC adaptor and all peripherals before moving the computer.
- Close the display. Do not pick up the computer by its display panel.
- Close all port covers.
- Use the carrying case when transporting the computer.
- When carrying your computer, be sure to hold it securely so that it does not fall or hit anything.
- Do not carry your computer by holding protruded portions.

Heat dispersal

To protect from overheating, the CPU has an internal temperature sensor. If the computer's internal temperature rises to a certain level, the cooling fan is turned on or the processing speed is lowered. You can select whether to control the CPU temperature by turning on the fan first, then if necessary, lowering the CPU speed. Or, by lowering the CPU speed first, then if necessary, turning on the fan. These functions are controlled within the Power Options.

When the CPU temperature falls to a normal range, the fan is turned off and the CPU operation returns to standard speed.



If the CPU temperature reaches an unacceptably high level with either setting, the system automatically shuts down to prevent damage. Data in memory will be lost.

Chapter 5

The Keyboard

The computer's keyboard layout is compatible with 104/105-key enhanced keyboard. Pressing **FN** key and other keys can execute all enhanced keyboard function.

The number of keys on your keyboard depends on which country/region's keyboard layout your computer is configured with. Keyboards for numerous languages are available.

There are five types of keys: typewriter keys, function keys, soft keys, Windows special keys and keypad overlay.

Typewriter keys

The typewriter keys, produce the uppercase and lowercase letters, numbers, punctuation marks, and special symbols that appear on the screen.

There are some differences, however, between using a typewriter and using a computer keyboard:

- Letters and numbers produced in computer text vary in width. Spaces, which are created by a "space character," may also vary depending on line justification and other factors.
- The lowercase l (el) and the number 1 (one) are not interchangeable on computers as they are on a typewriter.
- The uppercase O (oh) and the 0 (zero) are not interchangeable.
- The **CAPS LOCK** function key locks only the alphabetic characters in uppercase while the shift lock on a typewriter places all keys in the shifted position.
- The **SHIFT** keys, the **TAB** key, and the **BACK SPACE** key perform the same function as their typewriter counterparts but also have special computer functions.

Function keys: F1 ... F12

The function keys, not to be confused with **FN**, are the 12 keys at the top of your keyboard. These keys are dark gray, but function differently from the other dark gray keys.



F1 through **F12** are called function keys because they execute programmed functions when pressed. Used in combination with the **FN** key, keys marked with icons execute specific functions on the computer. See the section, Soft keys: FN key combinations, in this chapter. The function executed by individual keys depends on the software you are using.

Soft keys: FN key combinations

The **FN** (function) is unique to Toshiba computers and is used in combination with other keys to form soft keys. Soft keys are key combinations that enable, disable or configure specific features.



Some software may disable or interfere with soft-key operations. Soft key settings are not restored by the Resume feature.

Emulating keys on an enhanced keyboard

The keyboard is designed to provide all the features of the 104/105-key enhanced keyboard, shown in figure 5-1. The 104/105-key enhanced keyboard has a numeric keypad and scroll lock key. It also has additional **ENTER**, **CTRL** and **ALT** keys to the right of the main keyboard. Since the keyboard is smaller and has fewer keys, some of the enhanced keyboard functions must be simulated using two keys instead of one on the larger keyboard.

Your software may require you to use keys that the keyboard does not have. Pressing the **FN** key and one of the following keys simulates the enhanced keyboard's functions.



Press **FN + F10** or **FN + F11** to access the computer's integrated keypad.

When activated, the keys with dark gray markings on their bottom edge become either numeric keypad keys (**FN + F11**) or cursor control keys (**FN + F10**). Please refer to the [Keypad overlay](#) section in this chapter for more information on how to operate these keys, taking care to note that the power on default for both settings is off.

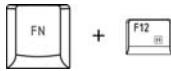

Press **FN + F12** (Scroll Lock) to lock the cursor on a specific line. The power on default is off.



Press **FN + ENTER** to simulate **ENTER** on the enhanced keyboard's numeric keypad.

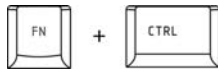

Press **FN + CTRL** to simulate the enhanced keyboard's right **CTRL** key.

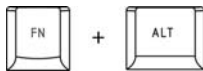

Press **FN + ALT** to simulate the enhanced keyboard's right **ALT** key.

Hot keys

Hot keys (pressing **FN** + a function or **ESC** key) allow you to enable or disable certain features of the computer.

Sound mute



Pressing **FN + ESC** in a Windows environment turns sound on or off. When you press these hot keys, the current setting will be displayed as an icon.

Lock

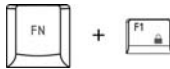

Pressing **FN + F1** enters "Lock computer" mode. To restore your desktop, you need to log on again.

Power plan



Pressing **FN + F2** changes the power settings.

Sleep



Pressing **FN + F3** switches the system to sleep mode.

Hibernate

Pressing **FN + F4** switches the system to hibernation mode.

**Output**

Pressing **FN + F5** changes the active display device.

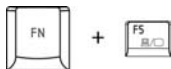
**Brightness down**

Pressing **FN + F6** decreases the computer's display panel brightness in individual steps.

**Brightness up**

Pressing **FN + F7** increases the computer's display panel brightness in individual steps.

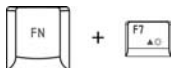
**Wireless**

Pressing **FN + F8** switches the active wireless devices if the wireless communication switch is switched on.



If your wireless communication device is not installed, a dialog box will not appear.

Touchpad

Pressing **FN + F9** enables or disables the touchpad function.

**Zoom**

Pressing **FN + SPACE** changes the display resolution.



TOSHIBA zooming utility (reduce)



Pressing **FN + 1** reduces the icon size on the desktop or the font sizes within one of the supported application windows.

TOSHIBA zooming utility (enlarge)



Pressing **FN + 2** enlarges the icon size on the desktop or the font sizes within one of the supported application windows.

FN sticky key

You can use the Toshiba Accessibility Utility to make the **FN** key sticky, that is, you can press it once, release it, and they press an “**F number**” key.

To start the Toshiba Accessibility Utility, click **Start** → **All Programs** → **TOSHIBA** → **Utilities** → **Accessibility**.

Windows special keys

The keyboard provides two keys that have special functions in Windows: one activates the **Start** menu and the other has the same function as the secondary mouse button.



This key activates the Windows **Start** menu.



This key has the same function as the secondary mouse button.

Keypad overlay

Your computer's keyboard does not have a separate numeric keypad but includes a numeric keypad overlay which functions like one - this is located in the center of the keyboard with the relevant keys having dark gray letters at their front edge. The overlay provides the same functions as the numeric keypad on a standard 101/102-key enhanced keyboard.

Turning on the overlays

The numeric keypad overlay can be used for numeric data input or cursor and page control.

Arrow mode

To turn on the Arrow mode, press **FN + F10**. The Arrow mode indicator lights. Now try cursor and page control using the keys shown in figure 5-1. Press **FN + F10** again to turn off the overlay.

Numeric mode

To turn on the Numeric mode, press **FN + F11**. The Numeric mode indicator lights. Now try numeric data entry using the keys in figure 5-1. Press **FN + F11** again to turn off the overlay.

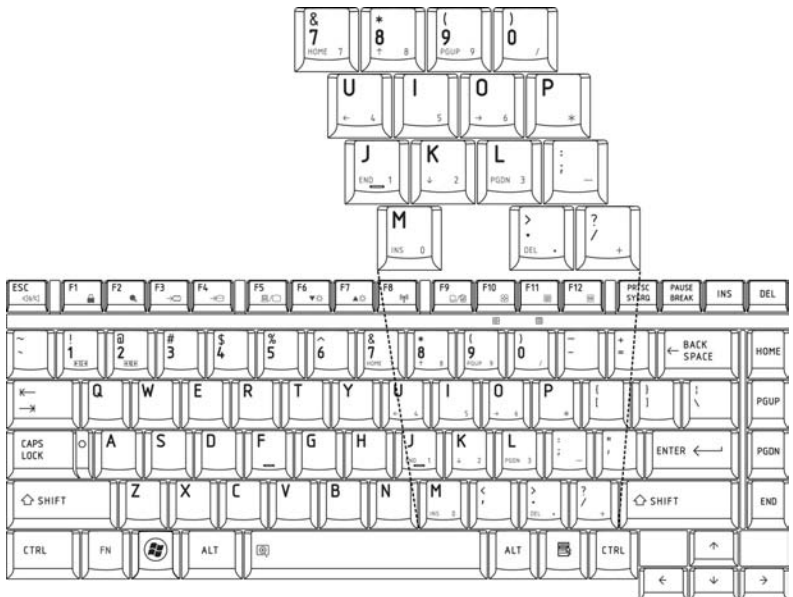

Figure 5-1 The numeric keypad overlay

Temporarily using normal keyboard (overlay on)

While using the overlay, you can temporarily access the normal keyboard functions without turning off the overlay :

1. Hold **FN** and press any other key. All keys will operate as if the overlay were off.
2. Type uppercase characters by holding **FN + SHIFT** and pressing a character key.
3. Release **FN** to continue using the overlay.

Temporarily using overlay (overlay off)

While using the normal keyboard, you can temporarily use the keypad overlay without turning it on:

1. Press and hold down **FN**.
2. Check the keyboard indicators. Pressing **FN** turns on the most recently used overlay. If the Numeric mode indicator lights, you can use the overlay for numeric entry. If the Arrow mode indicator lights, you can use the overlay for cursor and page control.
3. Release **FN** to return to normal keyboard operation.

Temporarily changing modes

If the computer is in **Numeric mode**, you can switch temporarily to **Arrow mode** by pressing **SHIFT**.

If the computer is in **Arrow mode**, you can switch temporarily to **Numeric mode** by pressing **SHIFT**.

Generating ASCII characters

Not all ASCII characters can be generated using normal keyboard operation. But, you can generate these characters using their ASCII codes. With the overlay on:

1. Hold down **ALT**.
2. Using the overlay keys, type the ASCII code.
3. Release **ALT**, and the ASCII character appears on the display screen.

With the overlay off:

1. Hold **ALT + FN**.
2. Using the overlay keys, type the ASCII code.
3. Release **ALT + FN**, and the ASCII character appears on the display screen.

Chapter 6

Power and Power-up Modes

The computer's power resources include the AC adaptor and internal batteries. This chapter gives details on making the most effective use of these resources including charging and changing batteries, tips for saving battery power, and power-up modes.

Power conditions

The computer's operating capability and battery charge status are affected by the power conditions: whether an AC adaptor is connected, whether a battery is installed and what the charge level is for the battery.

Table Power conditions

		Power on	Power off (no operation)
AC adaptor connected	Battery fully charged	<ul style="list-style-type: none"> Operates LED: Battery White/Green DC IN White/Green 	<ul style="list-style-type: none"> LED: Battery White/Green DC IN White/Green
	Battery partially charged or no charge	<ul style="list-style-type: none"> Operates Quick Charge LED: Battery Orange DC IN White/Green 	<ul style="list-style-type: none"> Quick charge LED: Battery Orange DC IN White/Green
	No battery installed	<ul style="list-style-type: none"> Operates No charge LED: Battery off DC IN White/Green 	<ul style="list-style-type: none"> No charge LED: Battery off DC IN White/Green

		Power on	Power off (no operation)
AC adaptor not connected	Battery charge is above low battery trigger point	<ul style="list-style-type: none"> Operates LED: Battery off DC IN off 	
	Battery charge is below low battery trigger point	<ul style="list-style-type: none"> Operates LED: Battery blinking orange DC IN off 	
	Battery charge is exhausted	Computer goes into hibernation or shuts down (depending on the Toshiba power Management Utility Setting)	
	No battery installed	<ul style="list-style-type: none"> No operation LED: Battery off DC IN off 	

Power indicators

The **Battery**, **DC IN** and **Power** indicators on the system indicator panel alert you to the computer's operating capability and battery charge status.

Battery indicator

Check the **Battery** indicator to determine the status of the battery pack - the following indicator conditions should be noted:

Blinking orange	Indicates battery charge is below low battery trigger point.
Orange	Indicates the AC adaptor is connected and charging the battery.
White/Green	Indicates the AC adaptor is connected and the battery is fully charged.
No light	Under any other conditions, the indicator does not light.



If the battery becomes too hot while it is being charged, the charge will stop and the battery indicator will go out. When the battery's temperature falls to a normal range, charge will resume. This event occurs regardless of whether the power to the computer is on or off.

DC IN indicator

Check the **DC IN** indicator to determine the power status with the AC adaptor connected.

White/Green	Indicates the AC adaptor is connected and supplying proper power to the computer.
Orange	Indicates a problem with the power supply. Plug the AC adaptor into another outlet. If it still does not operate properly, see your dealer.
No light	Under any other conditions, the indicator does not light.

Power indicator

Check the **Power** indicator to determine the power status of the computer - the following indicator conditions should be noted:

White/Green	Indicates power is being supplied to the computer and the computer is turned on.
Blinking orange	Indicates the power was turned off while the computer was in sleep mode.
No light	Under any other conditions, the indicator does not light.

Battery types

The computer has two different types of batteries:

- Battery — 3 cell, 6 cell or 9 cell depending on the models
- Real Time Clock (RTC) battery



Battery pack(3 cell) is used for Mobile Intel® GM965/GM45/GL960/GL40 Express Chipset models and AMD M690G/M780G/M780V Chipset models.

Battery

When the AC power cord is not connected, the computer's main power source is a removable lithium ion battery pack, also referred to in this manual as the battery. You can purchase additional battery packs for extended use of the computer away from an AC power source.



The battery pack is a lithium ion battery, which can explode if not properly replaced, used, handled or disposed of. Dispose of the battery as required by local ordinances or regulations. Use only batteries recommended by TOSHIBA as replacements.

The battery recharges the RTC batteries. The battery maintains the state of the computer when you enable Resume.



When the computer is powered off in hibernation and sleep mode, and the AC adaptor is not connected, the battery pack supply power to maintain data and programs in memory. If the battery pack is completely discharged, hibernation and sleep do not function and the computer loses all data in memory. One of the following messages appears when you turn on the power:

The firmware has detected that a CMOS battery fail occurred.<F1> contiune

The firmware has detected that a CMOS battery fail occurred.<F1> contiune, <F2> to setup

To ensure that the battery pack maintains its maximum capacity, operate the computer on battery power at least once a month until the battery pack is fully discharged. Refer to [Extending battery life](#) in this chapter for procedures. If the computer is continuously operated on AC power, more than a month, the battery may fail to retain a charge. It may not function efficiently over the expected life of the battery and the Battery LED may not indicate a low-battery condition.

Real Time Clock battery

The Real Time Clock (RTC) battery provides power for the internal real time clock and calendar. It also maintains the system configuration.

If the RTC battery becomes completely discharged, the system loses this data and the real time clock and calendar stop working. One of the following messages appears when you turn on the power:

The firmware has detected that a CMOS battery fail occurred.<F1> contiune

The firmware has detected that a CMOS battery fail occurred.<F1> contiune, <F2> to setup



The computer's RTC battery is a lithium ion battery and should be replaced only by your dealer or by a TOSHIBA service representative. The battery can explode if not properly replaced, used, handled or disposed of. Dispose of the battery as required by local ordinances or regulations

Care and use of the battery pack

The battery pack is a vital component of portable computing. Taking proper care of it will help ensure longer operating time on battery power as well as a longer life for your battery pack. Follow the instructions in this section carefully to ensure safe operation and maximum performance.

Safety precautions

Mishandling of batteries can cause death, serious injury or property damage. Carefully observe the following advisories:

Danger: Indicates an imminently hazardous situation, Which could result in death or serious injury, if you do not follow instructions.

Warning: Indicates a potentially hazardous situation, Which could result in death or serious injury, if you do not follow instructions.

Caution: Indicates a potentially hazardous situation, Which if not avoided, may result in moderate or minor injury or property damage.

Note: Provides important information.

Danger

1. Never try to dispose of the battery pack by burning or expose it to a heating device such as a microwave oven. The battery pack could explode and cause bodily injury.
2. Never try to disassemble, repair or otherwise tamper with a battery pack. The battery pack will overheat and ignite. Leakage of caustic alkaline solution or other electrolytic substances will cause fire or injury, possibly resulting in death or serious injury.
3. Never short-circuit the battery pack by contacting the terminals with a metal object. A short-circuit can cause fire or otherwise damage the battery pack and possibly cause injury. To avoid accidental short-circuit, always wrap the battery pack in plastic and cover the terminals with electrical tape when storing or disposing of the battery pack.
4. Never puncture the battery pack with a nail or other sharp object. Never strike it with a hammer or other object. Never step on it.
5. Never try to change the battery pack in any manner other than that described in user's manual. Never connect the battery pack to a plug socket or to a automobile's cigarette lighter socket. It may rupture or ignite.
6. Use only the battery pack supplied with the computer or other device or an battery pack approved by the computer or device's manufacturer. Battery packs have different voltages and terminal polarities. Use of an improper battery could cause smoke, fire or rupture of the battery pack.
7. Never subject a battery pack to heat, such as storage near a heat source. Exposure to heat can cause the battery pack to ignite,

explode or leak caustic liquid and cause death or serious injury. It could also fail or malfunction causing data lose.

8. Never expose the battery pack to abnormal shock, vibration or pressure. The battery pack's internal protective device will fail, causing it to overheat, explode, ignite or leak caustic liquids possibly resulting in death or serious injury.
9. Never let a battery pack become wet. A wet battery pack will overheat, ignite or rupture possibly resulting in death or serious injury.

Warning

1. Never allow caustic electrolyte fluid leaked from a battery pack to contact your eyes, skin or clothing. If caustic electrolyte fluid should contact your eyes, immediately wash your eyes with large amounts of running water and seek medical attention, to help prevent eye damage. If electrolyte fluid should contact your skin immediately wash it under running water to prevent rash. If it contacts your clothes, promptly remove them to prevent the fluid from contacting your skin or eyes.
2. Immediately turn off the power, disconnect the AC adaptor and remove the battery if any of the following events are observed in the battery pack: offensive or unusual odor, excessive heat, discoloration or deformation. Never use the computer again until it has been checked by a TOSHIBA service provider. It might generate smoke or fire, or the battery pack might rupture.
3. Make sure the battery is securely installed in the computer before attempting to charge the battery pack. Improper installation could generate smoke or fire, or cause the battery pack to rupture.
4. Keep the battery pack out of reach of infants and children. It can cause injury.

Caution

1. Never continue to use a battery pack after its recharging capacity has become impaired, or after the display of a warning message indicating that the battery pack's power is exhausted. Continued use of an exhausted or impaired battery pack could cause the loss of data.
2. Never dispose of battery packs with normal trash. Bring them to your TOSHIBA dealer or to another recycling center to save resources and prevent environmental damage. Cover the terminals with electrical tape to prevent short-circuits, which could cause the battery pack to ignite or rupture.
3. Use only battery packs recommended by TOSHIBA as replacements.
4. Always make sure the battery pack is installed correctly and securely. Otherwise, a battery pack could fall out and possibly cause injury.
5. Change the battery pack only in an ambient temperature between 5 and 35 degrees Celsius. Otherwise, the electrolyte solution might

leak, battery pack performance might deteriorate and the battery life might be shortened.

6. Be sure to monitor the remaining battery power. If the battery pack and real time clock battery discharge completely. Sleep and hibernation will not function and data in memory will be lost. Also, the computer might register an incorrect time and date. In this case, connect the AC adaptor to recharge the batteries.
7. Never install or remove the battery pack without first turning off the power and disconnecting the AC adaptor. Never remove the battery pack while the computer in hibernate or sleep mode. Data will be lost.

Note

1. Never remove the battery pack while the Wake-up on LAN function is enabled. Data will be lost. Before you remove a battery pack, disable the Wake-up on LAN function.
2. To ensure the battery pack maintains maximum capacity, operate the computer on battery power once a week until the battery pack is fully discharged. Refer to the section [Extending battery life](#) in this chapter for procedures. If the computer is continuously operated on AC power for an extended period, more than a month, the battery might fail to retain a charge. It might not function efficiently over the expected life of the battery pack and **Battery** indicator might not indicate a low-battery condition.
3. After the battery pack is charged, avoid leaving the AC adaptor connected and the computer turned off for more than a few hours at a time. Continuing to charge a fully-charged battery pack can damage the battery.

Charging the batteries

When the power in the battery pack becomes low, the Battery indicator flashes orange indicating that only a few minutes of battery power remain. If you continue to use the computer while the Battery indicator flashes, the computer enables hibernation mode (so you don't lose data) and automatically turns off.

You must recharge a battery pack when it becomes discharged.

Procedures

To recharge a battery pack while it is installed in the computer, connect the AC adaptor to the **DC IN** socket and plug the other end into a working outlet.

The **Battery** indicator glows orange when the battery is being charged.



Use only the computer connected to an AC power source or the optional TOSHIBA Batteries charger to charge the battery pack. Never attempt to charge the battery pack with any other charger.

Time

The following table shows the approximate time required to fully charge a discharged battery.

Charging time (hours)

Battery type	Power on	Power off
Battery pack (3 cell)	8 hours or more	2 hours
Battery pack (6 cell)	8 hours or more	3 hours
Battery pack (9 cell)	8 hours or more	4 hours
RTC battery	24 hours	24 hours



The charging time when the computer is on is affected by ambient temperature, the temperature of the computer and how you use the computer. If you make heavy use of external devices, for example, the battery might scarcely charge at all during operation. Refer also to the section Maximizing battery operating time.

Battery charging notice

The battery may not charge right away under the following conditions:

- The battery is extremely hot or cold. If the battery is extremely hot, it might not charge at all. Also, to ensure the battery charges to its full capacity, charge the battery at room temperature of 10° to 30°C (50° to 86°F).
- The battery is nearly completely discharged. Leave the AC adaptor connected for a few minutes and the battery should begin charging.

The **Battery** indicator may show a rapid decrease in battery operating time when you try to charge a battery under the following conditions:

- The battery has not been used for a long time.
- The battery has completely discharged and been left in the computer for a long time.
- A cool battery is installed in a warm computer.

In such case, follow the steps below.

1. Fully discharge the battery by leaving it in the computer with the power on until the power automatically shuts off.
2. Plug in the AC adaptor.
3. Charge the battery until the **Battery** indicator glows white/green.

Repeat the steps two or three times until the battery recovers normal capacity.



Leaving the AC adaptor connected will shorten battery life. At least once a month, run the computer on battery power until the battery is fully discharged, then recharged the battery.

Monitoring battery capacity

Remaining battery power can be monitored in Power Options.



Wait at least 16 seconds after turning on the computer before trying to monitor the remaining operating time. The computer needs this time to check the battery's remaining capacity and to calculate the remaining operating time, based on the current power consumption rate and remaining battery capacity. The actual remaining operating time may differ slightly from the calculated time.

Maximizing battery operating time

A battery's usefulness depends on how long it can supply power on a single charge.

How long the charge lasts in a battery depends on:

- How you configure the computer (for example, whether you enable battery-power saving options). The computer provides a battery save mode, which can be set in Power Options, to conserve battery power. This mode has the following options:
 - CPU Processing speed
 - Screen brightness
 - Cooling Method
 - System sleep
 - System hibernation
 - Monitor Power off
 - HDD Power off
- How often and how long you use the hard disk, optical disc drive and the diskette drive.
- How much charge the battery contained to begin with.
- How you use optional devices, such as an ExpressCard, to which the battery supplies power.
- Enabling hibernation and sleep mode conserves battery power if you are frequently turning the computer off and on.
- Where you store your programs and data.
- Closing the display when you are not using the keyboard saves power.
- Operating time decreases at low temperatures.
- The condition of the battery terminals. Make sure the battery terminals stay clean by wiping them with a clean dry cloth before installing the battery pack.

Retaining data with power off

When you turn off your computer with fully charged batteries, the batteries retain data for the following approximate time periods.

Retention Time

Battery type	State and Retention Time
Battery pack (3 cell)	about 28 hours (sleep mode) about 15 days (shutdown mode)
Battery pack (6 cell)	about 57 hours (sleep mode) about 30 days (shutdown mode)
Battery pack (9 cell)	about 86 hours (sleep mode) about 45 days (shutdown mode)
RTC battery	about 3 months

Extending battery life

To maximize the life of your battery packs:

- At least once a month, disconnect the computer from a power source and operate it on battery power until the battery pack fully discharges. Before doing so, follow the steps below.
 1. Turn off the computer's power.
 2. Disconnect the AC adaptor and turn on the computer's power. If it does not turn on then go to Step 4.
 3. Operate the computer on battery power for five minutes. If the battery pack has at least five minutes of operating time, continue operating until the battery pack is fully discharged. If the battery LED flashes or there is some other warning to indicate a low battery, go to step 4
 4. Connect the AC adaptor to the computer and the power cord to a power outlet. The **DC IN** LED should glow white/green, and the Battery LED should glow orange to indicate that the battery pack is being charged. If the DC IN indicator does not glow, power is not being supplied. Check the connections for the AC adaptor and power cord
 5. Charge the battery pack until the **Battery** indicator glows white/green.
- If you have extra battery packs, rotate their use.
- If you will not be using the system for an extended period more than one month, remove the battery pack.
- Disconnect the AC adaptor when the battery is fully charged. Overcharging makes the battery hot and shortens life.
- If you are not going to use the computer for more than eight hours, disconnect the AC adaptor.
- Store spare battery packs in a cool dry place out of direct sunlight.

Replacing the battery pack

When the battery pack reaches the end of its operating life you will need to install a new one. If the **Battery** indicator flashes orange shortly after fully recharging the battery, the battery pack needs to be replaced. You might also replace a discharged battery pack with a charged spare when you are operating your computer away from an AC power source. This section explains how to remove and install battery packs.

Removing the battery pack

To remove a discharged battery, follow the steps as detailed below:



- *When handling battery pack, be careful not to short circuit the terminals. Also do not drop, hit or otherwise apply impact; do not scratch or break the casing and do not twist or bend the battery pack.*
- *Do not remove the battery pack while the computer is in sleep mode. Data is stored in RAM, so if the computer loses power it will be lose.*
- *In hibernation mode, data will be lose if you remove the battery or disconnect the AC adaptor before the save is completed. Wait for the **HDD/ODD/eSATA** indicator, optical disc drive indicator and external device indicator to go out.*

1. Save your work.
2. Turn the computer's power off. Make sure the **Power** indicator is off.
3. Remove all cables connected to the computer.
4. Turn the computer upside down with the back of the computer facing you.
5. Slide the battery pack locking latch toward the unlock position.

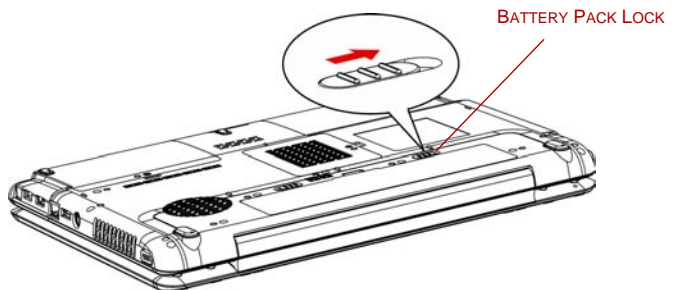

Figure 6-1 Slide the locking latch to the unlocked position

- Slide the battery release latch to free the battery pack for removal, then lift up the battery pack.

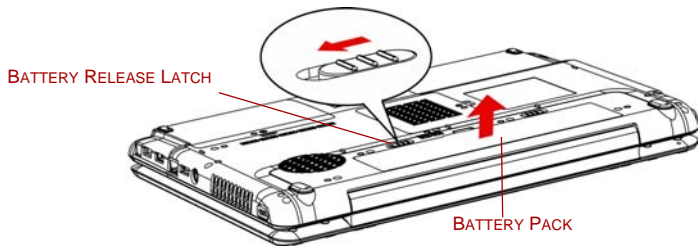

Figure 6-2 Removing the battery pack

- Pull the battery pack forward to remove it.



For environmental reasons, do not throw away a spent battery pack. Please return spent battery pack to your TOSHIBA dealer.

Installing the battery pack

To install a battery pack, follow the steps below.



The battery pack is a lithium ion battery, which can explode if not properly replaced, used, handled or disposed of. Dispose of the battery as required by local ordinances or regulations. Use only batteries recommended by TOSHIBA as replacements.

- Be sure the computer's power is off and all cables are disconnected.
- Insert the battery pack.

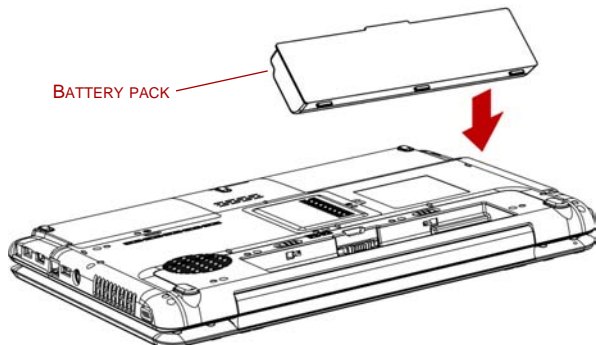

Figure 6-3 Installing the battery pack

- Push the battery pack until it is firmly seated.
- Slide the battery pack locking latch toward the lock position.

Starting the computer by password

If you have already registered a password, there are two ways to start the computer:

- Swipe your fingerprint on the sensor if you have already registered the fingerprint with the Fingerprint utility and enabled Fingerprint Power-on Security. If you would not like to swipe your finger or cannot authenticate the fingerprint for some reasons, press the **ESC** key or click **Switch User** button to skip the fingerprint authentication screen. You can try to swipe the fingerprint up to five times. If you failed fingerprint authentication more than five times, you must enter the password manually to start the computer.
- Enter the password manually.

To enter a password manually, follow these steps:

1. Turn on the power as described in Chapter 3, [Getting Started](#). The following message appears:

Enter Current Password



*At this point, the hot keys **FN + F1** to **F9** do not work. They will function after you enter the password.*

2. Enter the password.
3. Press **ENTER**.



If you enter the password incorrectly three times in a row, the computer shuts off. In this case, you must turn the computer back on to retry password entry.

Power-up modes

The computer has the following power-up modes:

- **Boot:** Computer shuts down without saving data. Always save your work before you turn the computer off in boot mode.
- **Hibernation:** Data in memory is saved to the hard disk.
- **Sleep:** Data is maintained in the computer's main memory.



Refer also to the sections [Turning on the power](#) and [Turning off the power](#) in Chapter 3, [Getting Started](#).

Windows utilities

You can specify the setting in Power Options.

Hot keys

You can use hot keys **FN + F3** to enter sleep mode and **FN + F4** to enter hibernation mode. See Chapter 5, [The Keyboard](#) for details.

Panel power on/off

You can set up your computer so that power turns off automatically when you close the display panel. When you open the panel, power turns on in sleep or hibernation mode but not in boot mode.



If the panel power off function is enabled and use Shut down Windows, do not close the display until the shut down function is completed.

System auto off

This feature turns the system off automatically if it is not used for a set duration. The system shuts down in sleep mode or hibernation mode.

Chapter 7

HW Setup and Passwords

This chapter explains how to use TOSHIBA HW Setup program to configure your computer and how to set passwords.

HW Setup

TOSHIBA HW Setup allows you to configure settings for General, Password, Display, CPU, Boot Priority, Keyboard, USB, LAN and LED.



If the supervisor password is set, access to the TOSHIBA HW Setup program can be prevented when the user password is used to log on to the computer.

Accessing HW Setup

To start the utility, click the Windows Start button, point to **All Programs**, click **TOSHIBA**, click **Utilities**, and select **HWSetup** icon.

HW Setup window

The HW Setup window contains the following tabs: General, Password, Display, CPU, Boot Priority, Keyboard, USB, LAN and LED.

There are also three buttons: **OK**, **Cancel** and **Apply**.

OK	Accepts your changes and closes the HW Setup window.
Cancel	Closes the window without accepting your changes.
Apply	Accepts all your changes without closing the HW Setup window.

General

This window displays the BIOS version and contains two buttons: **Default** and **About**.

Default	Returns all HW Setup values to the factory settings.
About	Displays the HW Setup version.

Setup

This field displays the installed **BIOS version** and date.

Password

User Password

This option allows you to set or reset the user password for power on.

Not Registered	Changes or remove the password. (Default)
Registered	Sets the password. A dialogue box will appear to allow you to set the password.

To enter a user password:

1. Select **Registered** to display the following prompt:

Enter Password:

Enter a password of up to 10 characters. The character string you enter is displayed as a string of asterisks. For example, if you enter a password consisting of four characters, the display is shown as:

Enter Password: ****

2. Click the **OK** button. The following message appears, allowing you to verify the password.

Verify Password:

3. If character strings match, the password is registered click OK button. If they do not match, the following message appears. You must repeat from step 1.

Entry Error!!!

To delete a user password:

1. Select **Not Registered** to display the following prompt:
Enter Password:
2. Enter the currently registered password. The character string you enter is displayed as a string of asterisks.
Enter Password: ****
3. Click the **OK** button. If the character string you enter matches the registered password, the password option is reset and the display changes to:
Not registered

If they do not match, the following message appears. You must repeat step 1.

Incorrect Password!!!



If you enter the password incorrectly three times in a row, the computer need to shut off.

You will not be able to access the password option in the HW Setup. In this case you must turn the power off and back on to retry the procedure.

4. Follow the same procedures described in the earlier section, How to set the password, to set a new user password.

Display

This tab allows you to customize your computer's display settings for either the internal LCD screen or for an external monitor.

Power On Display

Allows you to set the display to be used when the computer is booted.

Auto-Selected	Selects an external monitor if one is connected, otherwise, it selects the internal LCD display (Default).
LCD + Analog RGB	Selects both the internal LCD and an external monitor for simultaneous display.

CPU

Dynamic CPU Frequency Mode

This option allows you to choose from the following settings:

Dynamically Switchable	CPU power consumption and clock speed automatic switching function is enabled. When the computer is in use, CPU operation is automatically switched when necessary. (Default)
Always Low	CPU power consumption and clock speed automatic switching function is disabled. The CPU always runs at low power consumption and low speed.

Boot Priority

Boot Priority Options

This option sets the priority for booting the computer.

If there is only 1 HDD, the Boot Priority Options setting will be like the following.

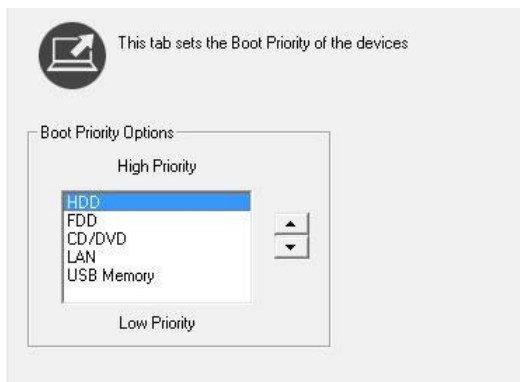

If there are 2 HDDs, the Boot Priority Options setting will be like the following.

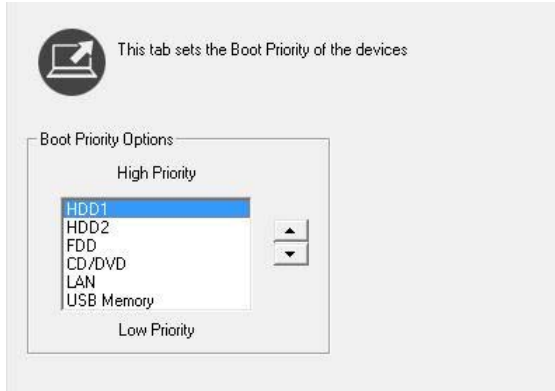

You can override the settings and manually select a boot device by pressing one of the following keys while the computer is booting:

U	Selects the USB diskette drive.
N	Selects the network.
1	Selects the primary HDD.
2	Selects the secondary HDD.
C	Selects the CD-ROM*.

This procedure does not affect the settings.

* In this computer, CD-ROM refers to the DVD Super Multi (+-R DL) drive.



ExpressCard HDD boot is not supported.

To change the boot drive, follow the steps below.

1. Hold down **F12** and boot the computer.
2. Use the up/down cursor keys to select boot device you want and press **ENTER**.



- *If a supervisor password is set, the menu above does not appear when you use the user password to start the computer.*
- *The selection method above does not change the boot priority settings in HW Setup.*
- *If you press a key other than one of those above or if the selected device is not installed, the system will boot according to the current setting in HW Setup.*

Keyboard

Wake-up on Keyboard

When this feature is enabled and the computer is in sleep mode, you can turn on the computer by pressing any key. It is effective only for the internal keyboard and only when the computer is in sleep mode.

Enabled	Enables the Wake-up on Keyboard.
Disabled	Disables the Wake-up on Keyboard. (Default)

USB

Legacy USB Support

Use this option to enable or disable USB Legacy Emulation. If your operating system does not support USB, you can still use a USB mouse and keyboard by setting the **USB Legacy Emulation** item to enabled.

Enabled	Enables the USB Legacy Emulation. (Default)
Disabled	Disables the USB Legacy Emulation.

USB Sleep and Charge function

This section describes the setting for USB Sleep and Charge function. For more information, please refer to the [USB Sleep and Charge function](#) section in Chapter 4.

The default setting in BIOS Setup is [Disabled]. Changing the setting to [Enabled] enables the use of this function.

There are two modes, Mode 1 and Mode 2 in [Enabled]. For normal use, set the setting to Mode 1.



If the function does not work with Mode-1 setting, change it to Mode-2. Some external devices may not be able to use this function in either mode. When this happens, change the setting to [Disabled].

Enabled (Mode 1)	Enables Sleep and Charge function Mode 1.
Enabled (Mode 2)	Enables Sleep and Charge function Mode 2.
Disabled	Disables Sleep and Charge function. (Default)

LAN

Wake-up on LAN

This feature lets the computer's power be turned on when it receives a wake-up signal from the LAN.

Enabled	Enables the Wake-up on LAN. (Default)
----------------	---------------------------------------

Disabled	Disables the Wake-up on LAN.
-----------------	------------------------------



Do not install or remove an optional memory module while Wake-up on LAN is enabled.



Wake-up on LAN does not work without the AC adaptor. Leave it connected, if you are using this feature.

Built-in LAN

Enabled	Enables built-in LAN functions. (Default)
----------------	---

Disabled	Disables built-in LAN functions.
-----------------	----------------------------------

illumination

illumination ON/OFF

This feature allows you to set conditions for Front Edge Logo LED, touchpad illumination LED and Function button backlight LED. (Depending on the model you purchased)

ON	On. (Default)
-----------	---------------

OFF	Off.
------------	------

Chapter 8

Optional Devices

Optional devices can expand the computer's capabilities and its versatility. The following optional devices are available from your TOSHIBA dealer:

Cards/Memory

- ExpressCard
- SD, SDHC, MS, MS Pro, MMC, xD memory cards
- Memory expansion

Power devices

- Additional battery pack (3 cell, 6 cell and 9 cell)
- Additional AC adaptor

Peripheral devices

- USB FDD Kit
- eSATA
- External monitor
- Television
- HDMI
- i.LINK (IEEE1394)

Other

- Security lock

ExpressCard

Installing an ExpressCard

The ExpressCard slot is located on the left side of the computer. You can install one ExpressCard in the slot.

Windows' hot-install feature allows you to install ExpressCard while the computer's power is on.



Do not install an ExpressCard while the computer is in sleep or hibernation mode. Some cards might not work properly.

To install an ExpressCard, follow the steps below.

1. There is a dummy card in the slot. Press the dummy card slightly to make it stretch out.

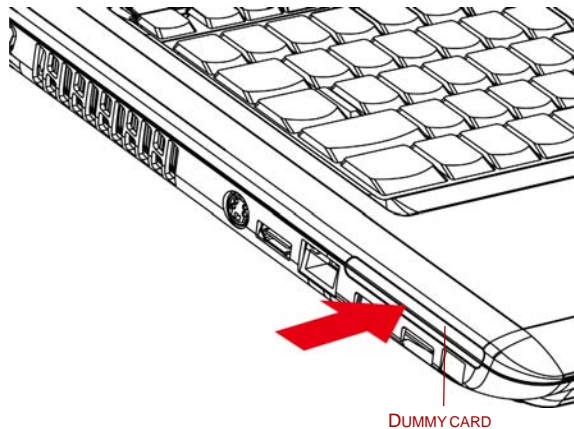

Figure 8-1 Pressing the dummy card

2. Grasp the dummy card and pull it out from the slot.

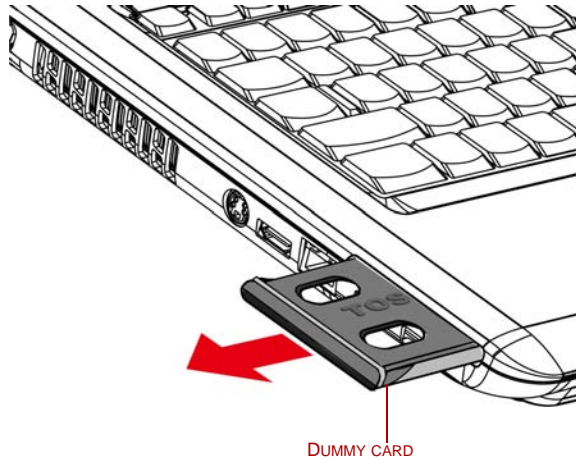
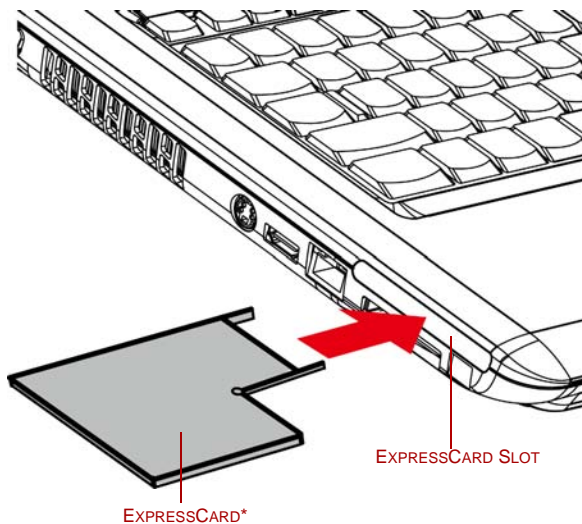

Figure 8-2 Removing the dummy card

3. Insert the ExpressCard.
4. Press gently to ensure a firm connection.
5. Check the configuration in the HW Setup window to make sure it is appropriate for your card.



*THE CARD'S SHAPE DEPENDS ON THE CARD YOU PURCHASED.

Figure 8-3 Inserting the ExpressCard

Removing an ExpressCard

To remove the ExpressCard, follow the steps below.

1. In Windows Vista™, open the **Safely Remove Hardware** icon on the system tray and disable the ExpressCard.
2. Press the ExpressCard slightly to make it stretch out.
3. Grasp the ExpressCard and pull it out from the slot.

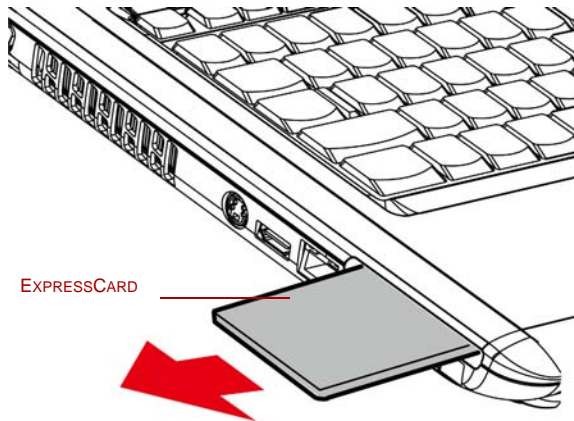

Figure 8-4 Removing the ExpressCard

Multiple digital media card slot

The computer is equipped with a multiple digital media card slot that can accommodate Secure Digital (SD)/ Secure Digital High Capacity (SDHC)/ Memory Stick (MS)/Memory Stick Pro (MS Pro)/Multi Media Card (MMC)/xD memory cards. These memory cards allow you to easily transfer data from devices, such as digital cameras and Personal Digital Assistants, that use SD/SDHC/MS/MS Pro/MMC/xD memory cards.

See below for the card capacities:

Card Type	Capacities
SD	8 MB, 16 MB, 32 MB, 64 MB, 128 MB, 256 MB, 512 MB, 1 GB, 2 GB
SDHC	4 GB, 8 GB, 16 GB
MMC	8 MB, 16 MB, 32 MB, 64 MB, 128 MB, 256 MB, 512 MB, 1 GB, 2 GB
MS	8 MB, 16 MB, 32 MB, 64 MB, 128 MB, 256 MB
MS Pro	256 MB, 512 MB, 1 GB, 2 GB
xD	16 MB, 32 MB, 64 MB, 128 MB, 256 MB, 512 MB, 1 GB, 2 GB



The Logo of SD Memory card is 

The Logo of SDHC Memory card is 

Installing a SD/SDHC/MS/MS Pro/MMC/xD card

To install the memory card, follow the steps below.

1. Insert the memory card.
2. Press gently to ensure a firm connection.

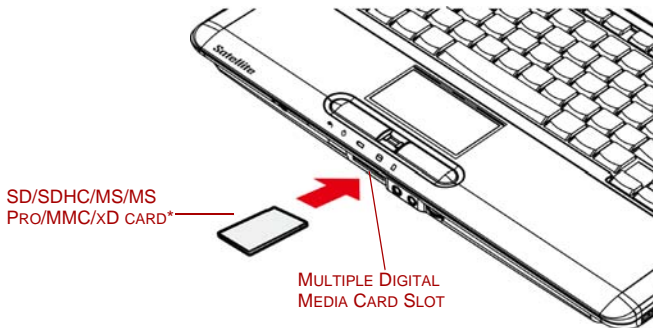

*THE CARD'S SHAPE DEPENDS ON THE CARD YOU PURCHASED.

Figure 8-5 Inserting the memory card



- *Keep foreign objects out of the multiple digital media card slot. A pin or similar object can damage the computer's circuitry.*
- *Make sure the SD/SDHC/MS/MS Pro/MMC/xD card is oriented properly before you insert it.*
- *Memory Stick Duo/PRO Duo and the Memory Stick adaptor are not compatible with the multiple digital media card slot. Do not insert Memory Stick Duo/PRO Duo into the slot. Data may be lost or damaged if you use any card other than those supported.*
- *Two kinds of cards will not work at the same time. Please insert only one card when using multiple digital media card slot.*
- *Do not format a memory card with Windows as it might result in that card not being able to be used with some peripheral devices.*
- *The card is designed so that it can be inserted only one way. Do not try to force the card into the slot.*
- *For more details on using memory cards, see manuals accompanying the cards.*



If Windows fail to read the SD/SDHC/MS/MS Pro/MMC/xD card, remove it then reinsert it.

Removing a SD/SDHC/MS/MS Pro/MMC/xD card

To remove the memory card, follow the steps below.

1. In Windows Vista™, open the **Safely Remove Hardware** icon on the system tray and disable the inserted memory card.
2. Gently press the memory card inside the socket to eject it.
3. Grasp the card and remove it.

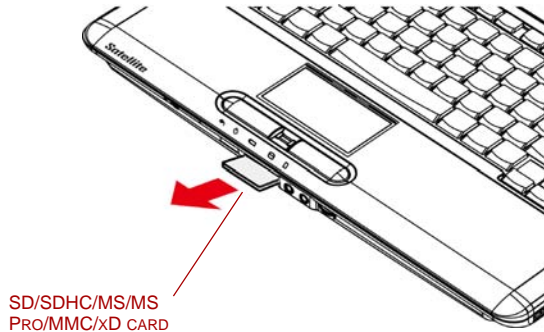

Figure 8-6 Removing the inserted memory card



- *Make sure the multiple digital media card slot indicator is out before you remove the card or turn off the computer's power. If you remove the card or turn off the power while the computer is accessing the card you may lose data or damage the card.*
- *Please do not remove the inserted memory card from the multiple digital media card slot while in sleep or in hibernation state. If you do, PC may become unstable or the data in the memory card may be lost.*
- *Do not turn off or make computer in sleep or hibernation mode during data is being transferred. The computer could become unstable or data would be lost.*

Memory expansion

You can install additional memory in the computer's memory module to increase the amount of RAM.

Installing memory module

To install a memory module, make sure the computer is in boot mode then:

1. Turn the computer off in boot mode. Refer to the [Turning off the power](#) section in Chapter 3.



- *If you use the computer for a long time, the memory modules will become hot. In this case, let the memory modules cool to room temperature before you replace them.*
- *Do not try to install a memory module with the computer turned on or turned off in sleep and hibernation mode. You can damage the computer and the memory module.*

2. Remove all cables connected to the computer.
3. Turn the computer upside down and remove the battery pack (refer to Chapter 6, [Power and Power-up Modes](#).)
4. Remove one screw securing the memory module cover.
5. Lift off the cover.



- *Use a point size 0 Phillips screwdriver.*
- *Insert the two memory modules of the same specifications and capacity into Slot A and Slot B respectively. The computer will operate in dual channel mode. You can access the inserted memory modules efficiently in dual channel.*
- *Slot A is reserved for main memory; Slot B is for expanded memory. If only one memory module is installed, use Slot A. Slot A is lower than Slot B.*

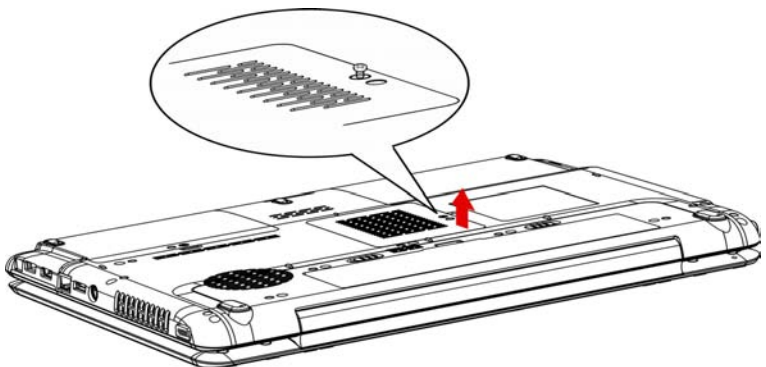

Figure 8-7 Removing the cover

6. Insert the memory module into the connector on the computer. Press the module carefully and firmly to ensure a solid connection.
7. Push the module down so that it lies flat and is secured by two latches.



Do not touch the connectors on the memory module or on the computer. Debris on the connectors may cause memory access problems.

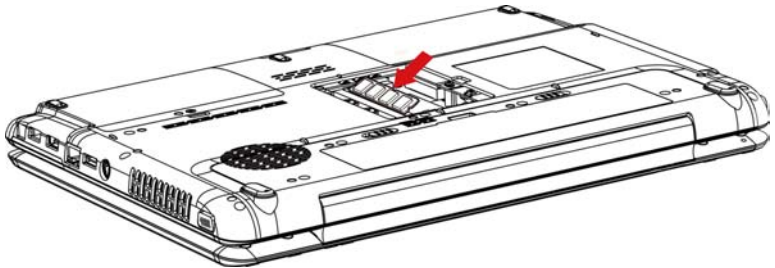

Figure 8-8 Inserting the memory module

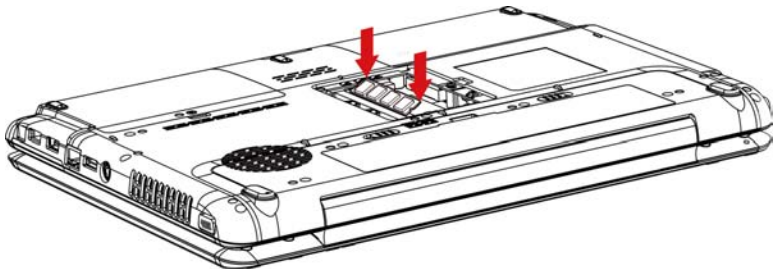

Figure 8-9 Pushing the memory module down

8. Seat the cover and secure it with one screw.
9. When you turn the computer on, it should automatically recognize the total memory capacity. Use the HW Setup program to verify that the added memory is recognized. If it is not recognized, check the module's connection.

Removing memory module

To remove the memory module, make sure the computer is in boot mode then:

1. Turn the computer off and remove all cables connected to the computer.



- *If you use the computer for a long time, the memory modules will become hot. In this case, let the memory modules cool to room temperature before you replace them.*
- *Do not try to remove a memory module with the computer turned on or turned off in sleep and hibernation mode. You can damage the computer and the memory module.*

2. Turn the computer upside down and remove the battery pack (refer to Chapter 6, [Power and Power-up Modes](#).)
3. Remove one screw securing the memory module cover.
4. Lift off the cover.
5. Use a slender object such as a pen to press two latches on either side of the memory module to the outside. The memory module will pop up.
6. Grasp the memory module by the sides and pull it out.



Do not touch the connectors on the memory module or on the computer. Debris on the connectors may cause memory access problems.

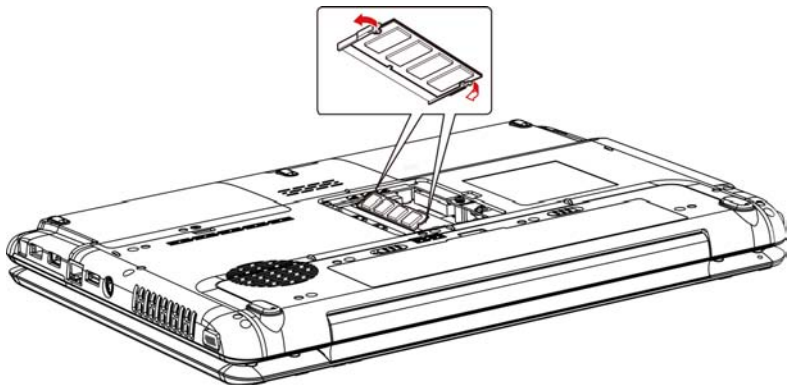

Figure 8-10 Removing the memory module

7. Seat the cover and secure it with one screw.

Additional battery pack (3 cell, 6 cell and 9 cell)

You can increase the portability of the computer with additional battery packs (3 cell: PA3533U-1BRS/PA3533U-1BAS, 6 cell: PA3534U-1BRS/PA3534U-1BAS, 9 cell: PA3535U-1BRS/PA3535U-1BAS). If you're away from an AC power source, you can replace a low battery with a fully charged one. See Chapter 6, *Power and Power-up Modes*.

Additional AC adaptor

If you frequently transport the computer between different sites such as your home and office, purchasing an AC adaptor (PA3468U-1ACA, PA3468E-1AC3, PA3516U-1ACA, PA3516E-1AC3, PA3290U-3ACA, PA3290E-3AC3) for each location will reduce the weight and bulk of your carrying load.

USB FDD Kit

The 3 1/2" external FDD drive module can be connected to the USB port.

eSATA

An eSATA-equipped device can be connected to the eSATA/USB combo port.

External monitor

An external analog monitor can be connected to the external monitor port on the computer. The computer supports VGA and Super VGA video modes. To connect a monitor, follow the steps below.



The hibernation and sleep feature can be used with an external monitor. Simply enable hibernation and sleep and the computer will maintain the data as it is displayed on the external monitor.

1. Connect the monitor to the external monitor port.
2. Turn the monitor's power on.

When you turn on the power, the computer automatically recognizes the monitor and determines whether it is color or monochrome.

You can use the HW Setup to select between `Auto-selected` and `LCD+AnaLog RGB` displays. Refer to Chapter 7, *HW Setup and Passwords*.

If you have selected `LCD+AnaLog RGB` under the `Display` options of the HW Setup, both the external monitor and the internal LCD will be active when you turn on the computer. If `Auto-selected` is selected, only the external monitor will be active.

To change the display settings, press **FN + F5**. If you disconnect the monitor before you turn the computer off, be sure to press **FN + F5** to switch to the internal display. Refer to Chapter 5, *The Keyboard*, for details on using hot keys to change the display setting.



If you set LCD+Ana.Log RGB for the computer's display, you must set the computer's display resolution to the same as that of the external monitor or other device, such as a projector.

Television

A television can be connected to the video out port on the computer. To connect a television, follow the steps below.

1. Turn the computer off.
2. Use a video cable (not supplied) to connect the television to the video out port.

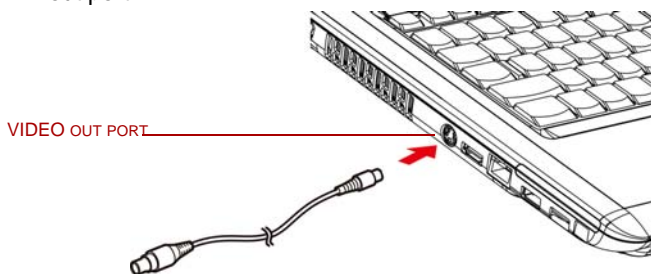

Figure 8-11 Connecting a television

3. Turn the television on.
4. Turn the computer on.

HDMI

Some models are equipped with HDMI out port than can send/receive video, audio and control signals by connecting with external display/audio devices. 1080p, 720p, 576p and 480p signal formats are supported, but actually available signal format depends on each HDMI devices. To connect external devices, follow the steps as detailed below:



As the port operation of all HDMI (High-Definition Multimedia Interface) monitors has not been confirmed, some HDMI monitors may not function properly.

1. Plug one end of the HDMI cable into the HDMI port of the HDMI device.

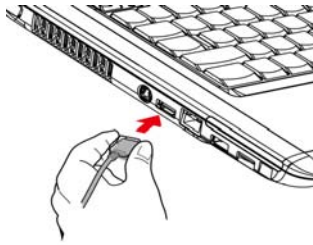

Figure 8-12 Connecting a HDMI cable

2. Plug the other end of the HDMI cable into the HDMI out port on your computer.

Setting for display video on HDMI

To view video on the HDMI device, be sure to configure the following settings otherwise you may find that nothing is displayed.



- *Be Sure to use the **FN + F5** hot keys to select the display device before starting to play video. Do not change the display device while playing video.*
- *Do not change the display device under the following conditions.*
 - *While data is being read or written.*
 - *While communication is being carried out.*

Settings for audio on HDMI

To set the audio device to use the HDMI, follow the steps below.

1. Click Start.
2. Click Control Panel.
3. Click Hardware and Sound.
4. Click Sound.
5. Click Playback tab.
6. Click HDMI Device.
7. Click the Set Default button.

To set the audio device to use internal speaker, follow the steps below.

1. Click Start.
2. Click Control Panel.
3. Click Hardware and Sound.
4. Click Sound.
5. Click Playback tab.
6. Click Speakers.
7. Click the Set Default button.

i.LINK (IEEE1394)

i.LINK (IEEE1394) is used for high-speed data transfer for a range of compatible devices such as

1. Digital video cameras
2. Hard disk drives
3. MO drives
4. CD-RW drives



i.LINK uses a four-pin connector, which does not carry electric current. External devices will need their own power supply.

Precautions

- Make a back-up of your data before transferring it to the computer. There is a possibility that the original data will be damaged. There is a particular risk that some frames will be deleted in the case of digital video transfer. TOSHIBA assumes no liability for such loss of data.
- Do not transfer data in areas where static electricity is easily generated or in areas subjected to electronic noise. Data can be destroyed.
- If you are transferring data through an IEEE1394 hub, do not connect or disconnect other devices from the hub during data transfer. There is a likelihood that data will be damaged. Connect all devices to the hub before you turn on the computer's power.
- You may not use any copyrighted video or music data copied from a video camera except for your personal enjoyment.
- If you connect/disconnect an i.LINK device to/from another i.LINK device that is currently exchanging data with the computer, data frames might be dropped.
- Make sure data transfer has ended or turn off the computer, before you:
 - Connect/disconnect an i.LINK device to/from the computer.
 - Connect/disconnect an i.LINK device to/from another i.LINK device that is connected to the computer.

Connecting

1. Make sure the connectors are properly aligned and plug the i.LINK (IEEE1394) cable into the computer.
2. Plug the other end of the cable into the device.

Note the following when you use i.LINK:

 - You may need to install drivers for your i.LINK devices.
 - Not all i.LINK devices have been tested. Therefore, compatibility with all i.LINK devices cannot be guaranteed.
 - Use S100, S200 or S400 cables no longer than three meters.
 - Some devices might not support sleep or automatic off functions.
 - Do not connect or disconnect an i.LINK device while it is using an application or when the computer is automatically shutting it down to save power. Data might be destroyed.
 - When multiple IEEE1394 devices are connected to a PC, the devices may not correctly be identified. This problem may occur when Windows Vista™ is restarted while the devices are connected or when the power to the IEEE1394 devices is turned on before the PC is turned on. If it occurs, disconnect the IEEE1394 cables and then reconnect them.

Disconnecting

1. Open the **Safety Remove Hardware** icon on the Task Bar.
2. Point to **i.LINK (IEEE1394) device** and click.
3. Disconnect the cable from the computer then from the i.LINK device.



Refer also to the documentation that came with your i.LINK device.

Security lock

A security lock enables you to anchor your computer to a desk or other heavy object to help prevent unauthorized removal of the computer. Attach one end of a cable to the desk and the other end to the security lock slot on the right side of the computer.

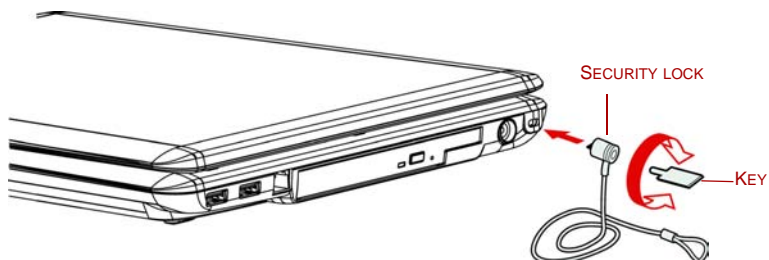

Figure 8-13 Security lock

Chapter 9

Troubleshooting

TOSHIBA designed the computer for durability. However, should problems occur, following the procedures in this chapter can help to determine the cause.

All readers should become familiar with this chapter. Knowing what might go wrong can help prevent problems from occurring.

Problem solving process

Resolving problems will be much easier if you observe the following guidelines:

- Stop immediately when you recognize a problem exists. Further action may result in data loss or damage. You may destroy valuable problem-related information that can help solve the problem.
- Observe what is happening. Write down what the system is doing and what actions you performed immediately before the problem occurred. If you have a printer attached, print a copy of the screen using the PRTSC(Print Screen) key.

The questions and procedures offered in this chapter are meant as a guide, they are not definitive problem solving techniques. Many problems can be solved simply, but a few may require help from your dealer. If you find you need to consult your dealer or others, be prepared to describe the problem in as much detail as possible.

Preliminary checklist

Consider the simplest solution first. The items in this checklist are easy to fix and yet can cause what appears to be a serious problem.

- Make sure you turn on all peripheral devices before you turn on the computer. This includes your printer and any other external device you are using.
- Before you attach an external device, turn the computer off. When you turn the computer back on it recognizes the new device.
- Make sure all options are set properly in the setup program.
- Check all cables. Are they correctly and firmly attached? Loose cables can cause signal errors.
- Inspect all connecting cables for loose wires and all connectors for loose pins.
- Check that your diskette is correctly inserted and that the diskette's write protect tab is correctly set.

Make notes of your observations and keep them in a permanent error log. This will help you describe your problems to your dealer. If a problem recurs, the log will help you identify the problem faster.

Analyzing the problem

Sometimes the system gives clues that can help you identify why it is malfunctioning. Keep the following questions in mind:

- Which part of the system is not operating properly: keyboard, diskette drives, hard disk drive, printer, display. Each device produces different symptoms.
- Is the operating system configuration set properly? Check the configuration options.
- What appears on the display screen? Does it display any messages or random characters? Print a copy of the screen if you have a printer attached. Look up the messages in the software and operating system documentation. Check that all connecting cables are correctly and firmly attached. Loose cables can cause erroneous or intermittent signals.
- Do any icons light? Which ones? What color are they? Do they stay on or blink? Write down what you see.

Record your observations so you can describe them to your dealer.

Software

The problems may be caused by your software or diskette. If you cannot load a software package, the media (usually a diskette) may be damaged or the program might be corrupted. Try loading another copy of the software.

If an error message appears while you are using a software package, check the software documentation. These documents usually include a problem solving section or a summary of error messages.

Next, check any error messages in the OS documentation.

Hardware

If you cannot find a software problem, check your hardware. First run through the items in the preliminary checklist above. If you still cannot correct the problem, try to identify the source. The next section provides checklists for individual components and peripherals.

Hardware and system checklist

This section discusses problems caused by your computer's hardware or attached peripherals. Basic problems may occur in the following areas:

- System start-up
- Self test
- Power
- Password
- Keyboard
- LCD panel
- Hard disk drive
- DVD Super Multi (+-R DL) drive
- Diskette drive
- infrared port
- Pointing device
- Fingerprint sensor
- ExpressCard
- SD/SDHC/MS/MS Pro/MMC/xD Card
- External monitor
- Sound system
- TV output signal
- USB
- USB Sleep and Charge function
- eSATA/USB combo port
- Modem
- Sleep/Hibernation
- LAN
- Wireless LAN
- Bluetooth
- i.LINK (IEEE1394) device
- Recovery Discs
- FM tuner

System start-up

When the computer does not start properly, check the following items:

- Self Test
- Power Sources
- Power-on Password

Self test

When the computer starts up, the self-test will be run automatically, and the following will be displayed:

```
TOSHIBA Leading Innovation>>>
```

This message remains on the screen for a few seconds.

If the self test is successful, the computer tries to load the operating system.

Depending on how the Boot Priority is set in the Hardware Setup, the computer tries to load first from drive A then from drive C, or first from drive C then from drive A.

If any of the following conditions are present, the self test failed:

- The computer stops and does not proceed to display information or messages.
- Random characters appear on the screen, and the system does not function normally.
- The screen displays an error message.

Turn off the computer and check all cable connections. If the test fails again, contact your dealer.

Power

When the computer is not plugged into an AC adaptor, the battery pack is the primary power source. However, your computer has a number of other power resources, including intelligent power supply and Real Time Clock battery. These resources are interrelated and any one could affect apparent power problems. This section provides check lists for AC adaptor and the main battery. If you cannot resolve a problem after following them, the cause could lie with another power resource. In such case, contact your dealer.

Overheating power down

If the computer's internal temperature becomes too high, the computer will automatically shut down.

AC power

If you have trouble turning on the computer with the AC adaptor connected, check the **DC IN** indicator. Refer to Chapter 6, *Power and Power-up Modes* for more information.

Problem	Procedure
AC adaptor doesn't power the computer (DC IN indicator does not glow white/green)	<p>Check the connections. Make sure the cord is firmly connected to the computer and a power outlet.</p> <p>Check the condition of the cord and terminals. If the cord is frayed or damaged, replace it. If the terminals are soiled, wipe them with cotton or a clean cloth.</p> <p>If the AC adaptor still does not power the computer, contact your dealer.</p>

Battery

If you suspect a problem with the battery, check the DC IN indicator as well as the battery indicator. For information on indicators and battery operation see Chapter 6, *Power and Power-up Modes*.

Problem	Procedure
Battery doesn't power the computer	The battery may be discharged - connect the AC adaptor to recharge the battery.
Battery doesn't charge when the AC adaptor is attached (Battery indicator does not glow orange).	<p>If the battery is completely discharged, it will not begin charging immediately. Wait a few minutes.</p> <p>If the battery still does not charge, make sure the outlet is supplying power. Test it by plugging in an appliance. If it doesn't work, try another power source</p> <p>Check whether the battery is hot or cold to the touch. If the battery is too hot or too cold, it will not charge properly. Let it reach room temperature.</p> <p>Unplug the AC adaptor and remove the battery to make sure the terminals are clean. If necessary wipe them with a soft dry cloth dipped in alcohol. Connect the AC adaptor and replace the battery. Make sure it is securely seated.</p>

Problem	Procedure
	<p>Check the Battery indicator. If it does not glow, let the computer charge the battery for at least 20 minutes. If the Battery indicator glows after 20 minutes, let the battery continue to charge at least another 20 minutes before turning on the computer.</p> <p>If the indicator still does not glow, the battery may be at the end of its operating life. Replace it. If you do not think the battery is at the end of its operating life, see your dealer.</p>
<p>Battery doesn't power the computer as long as expected</p>	<p>If you frequently recharge a partially charged battery, the battery might not charge to its full potential. Fully discharge the battery, then try to charge it again.</p> <p>Check the power consumption settings in Power Options. Consider using a power saving mode.</p>

Password

Problem	Procedure
<p>Cannot enter password</p>	<p>Refer to the Password section in Chapter 7, HW Setup and Passwords.</p>

Keyboard

Keyboard problems can be caused by your setup configuration. For more information refer to Chapter 5, [The Keyboard](#) and Chapter 7, [HW Setup and Passwords](#).

Problem	Procedure
<p>Some letter keys produce numbers</p>	<p>Check that the numeric keypad overlay is not selected. Press FN + F10 and try typing again.</p>
<p>Output to screen is garbled</p>	<p>Make sure the software you are using is not remapping the keyboard. Remapping involves reassigning the meaning of each key. See your software's documentation.</p> <p>If you are still unable to use the keyboard, consult your dealer</p>

LCD panel

Apparent LCD problems may be related to the computer's setup. Refer to Chapter 7, *HW Setup and Passwords*, for more information.

Problem	Procedure
No display	Press hot keys FN + F5 to change the display priority, to make sure it is not set for an external monitor.
Markings appear on the LCD screen.	They might have come from contact with the keyboard or touchpad. Try wiping the LCD gently with a clean dry cloth. If markings remain, use LCD cleaner. Be sure to let the LCD dry before closing it.
Problems above remain unresolved or other problems occur	Refer to your software's documentation to determine if the software is causing the difficulty. Contact your dealer if the problems continue.

Hard disk drive

Problem	Procedure
Computer does not boot from hard disk drive	Check if a diskette is in the diskette drive or a CD/DVD is in the optical disc drive. Remove any diskette and/or CD/DVD and check Boot priority. Refer to Chapter 7, <i>Boot Priority</i> section. There may be a problem with your operating system files. Refer to your OS documentation.
Slow performance	Your files may be fragmented. Run SCANDISK and defragmenter to check the condition of your files and disk. Refer to your OS documentation or online HELP for information on running SCANDISK and the defragmenter. As a last resort, reformat the hard disk. Then, reload the operating system and other files. If problems persist, contact your dealer.

DVD Super Multi(+R DL) drive

For more information, refer to Chapter 4, [Operating Basics](#).

Problem	Procedure
<p>You cannot access a CD/DVD in the drive</p>	<p>Make sure the drive's drawer is securely closed. Press gently until it clicks into place.</p> <hr/> <p>Open the drawer and make sure the CD/DVD is properly seated. It should lie flat with the label facing up.</p> <hr/> <p>A foreign object in the drawer could block laser light from reading the CD or DVD. Make sure there is no obstruction. Remove any foreign object.</p> <hr/> <p>Check whether the DVD is dirty. If it is, wipe it with a clean cloth dipped in water or a neutral cleaner. See the Media care section in Chapter 4 for details on cleaning.</p>
<p>Some CD/DVDs run correctly, but others do not</p>	<p>The software or hardware configuration may be causing a problem. Make sure the hardware configuration matches your software's needs. Check the CD/DVD's documentation.</p> <hr/> <p>Check the type of CD/DVD you are using. Refer to Chapter 1, Introduction for more information.</p> <hr/> <p>Check the region code on the DVD. It must match that on the drive. Region codes are listed in the Optical disc drive section in Chapter 2, The Grand Tour.</p>
<p>Cannot write correctly</p>	<p>If you have trouble writing, make sure you are observing the following precautions:</p> <ul style="list-style-type: none"> ■ Use only media recommended by TOSHIBA ■ Do not use the mouse or keyboard during writing. ■ Use only the software supplied with the computer for recording. ■ Do not run or start other software during writing. ■ Do not jar the computer during writing. ■ Do not connect/disconnect external devices or install/remove internal cards during writing. <p>If problems persist, contact your dealer.</p>

Diskette drive

Problem	Procedure
Drive does not operate	There may be a faulty cable connection. Check the connection to the computer and to the drive.
Some programs run correctly but others do not	The software or hardware configuration may be causing a problem. Make sure the hardware configuration matches your software needs.
You cannot access the external 3 1/2" diskette drive	Try another diskette. If you can access the diskette, the original diskette (not the drive) is probably causing the problem.
If problems persist, contact your dealer.	

Infrared port

Refer also to the documentation for your IrDA compatible device and related software.

Problem	Procedure
Infrared devices do not work as expected	Check that the device is connected to an electric outlet. Make sure the outlet is supplying power by plugging in an appliance.
	Make sure there is no obstruction blocking communication between the computer and the target device.
If problems persist, contact your dealer.	

Pointing device

If you are using a USB mouse, also refer to the [USB](#) section in this chapter and to your mouse documentation.

Touchpad

Problem	Procedure
On-screen pointer does not respond to Pad operation	The system might be busy. If the pointer is shaped as an hourglass, wait for it to resume its normal shape and try again to move it.
Double-tapping does not work	Try changing the double-click speed setting in the mouse control utility. Click Start → Control Panel → Hardware and Sound → Mouse to access it.

Problem	Procedure
The mouse pointer moves too fast or too slow	Try changing the speed setting in the mouse control utility. Click Start → Control Panel → Hardware and Sound → Mouse to access it.
When the reaction of touchpad is sensitive to slow	<p>Adjust the touch Sensitivity.</p> <ol style="list-style-type: none"> 1. Open the Control Panel. 2. Click the Hardware and Sound icon. 3. Click the Mouse icon. 4. Click the Device Setting tab. 5. Click the Setting button. 6. The Properties for Synaptics touchpad on PS/2 port screen appears. Double-click Sensitivity in the Select an item section on the left side of the screen. 7. PalmCheck and Touch Sensitivity are displayed. Click Touch Sensitivity. 8. Move the slide bar for Touch Sensitivity to make an adjustment. Click the OK button. 9. Click the OK button on the Device Setting tab. <p>If problems persist, contact your dealer.</p>

USB mouse

This section applies only with Windows Vista™ operating system.

Problem	Procedure
On-screen pointer does not respond to mouse operation	<p>The system might be busy. If the pointer is shaped as an hourglass, wait for it to resume its normal shape and try again to move it.</p> <p>Make sure the mouse is properly connected to the USB port.</p>
Double-clicking does not work	Try changing the double-click speed setting in the mouse control utility. Click Start → Control Panel → Hardware and Sound → Mouse to access it.
The mouse pointer moves too fast or too slow	Try changing the double-click speed setting in the mouse control utility. Click Start → Control Panel → Hardware and Sound → Mouse to access it.
The mouse pointer moves erratically	The mouse might be dirty. Refer to your mouse documentations for instructions on cleaning.

If problems persist, contact your dealer.

Fingerprint sensor

Problem	Procedure
Reading of the fingerprint was not successful	<p>Please try again using the correct posture. Refer to <i>Using the fingerprint sensor</i> in Chapter 4, <i>Operating Basics</i>.</p> <p>Try the recognition process again using another enrolled finger.</p>
The fingerprint cannot be read due to injuries to the finger	<p>Try the recognition process again using another enrolled finger.</p> <p>If fingerprints from all the enrolled fingers cannot be read, please logon by using the keyboard to input the password for the time being.</p> <p>If problems persist, contact your dealer.</p>
Fingerprint Pre-OS feature or Single Sign On feature cannot be enabled	<p>Please use TOSHIBA HW Setup to register the User Password if it was not registered.</p>
Fingerprint Pre-OS feature does not work	<p>Make sure you have enroll finger in windows account.</p> <p>Set the User Password by using TOSHIBA HW Setup and restart the system.</p> <p>Make sure place a checkmark in “Enable Pre-OS Fingerprint Authentication” on the TrueSuite Access Manager setting.</p>

ExpressCard

Refer also to Chapter 8, [Optional Devices](#).

Problem	Procedure
ExpressCard error occurs	<p>Reseat the ExpressCard to make sure it is firmly connected.</p> <p>Make sure the connection between the external device and the card is firm.</p> <p>Check the card's documentation.</p> <p>If problems persist, contact your dealer.</p>

SD/SDHC/MS/MS Pro/MMC/xD card

Refer also to Chapter 8, [Optional Devices](#).

Problem	Procedure
Memory card error occurs	<p>Reseat the memory card to make sure it is firmly connected.</p> <p>Check the card's documentation.</p>
You cannot write to the memory card	Make sure the card is not write protected.
You cannot read a file	Make sure the target file is on the memory card inserted in the slot.
	If problems persist, contact your dealer.

External monitor

Refer also to Chapter 8, [Optional Devices](#), and to your monitor's documentation.

Problem	Procedure
Monitor does not turn on	Make sure that the external monitor's power switch is on. Confirm that the external monitor's power cable is plugged into a working power outlet.
No display	<p>Try adjusting the contrast and brightness controls on the external monitor.</p> <p>Press hot keys FN + F5 to change the display priority and make sure it is not set for the internal display.</p>

Problem	Procedure
Display error occurs	Check that the cable connecting the external monitor to the computer is attached firmly. If problems persist, contact your dealer.

Sound system

Problem	Procedure
No sound is heard	Adjust the volume control dial. Check the software volume settings. Make sure the headphone connection is secure. Check Windows Device Manager. Make sure the sound function is enabled and that settings for I/O address, Interrupt level and DMA are correct for your software and do not conflict with other hardware devices that you may have connected to the computer. If problems persist, contact your dealer.

TV output signal

Problem	Procedure
Display on TV is poor	Make sure the TV type is correct for your area: NTSC (US, JAPAN), PAL (Europe).
No display	Try adjusting the contrast and brightness controls on the external monitor. Press hot keys FN + F5 to change the display. Refer to Chapter 5, The Keyboard . If problems persist, contact your dealer.



If you turn the computer off in hibernation and sleep mode while the display is on TV, the computer will select either the internal LCD or an external computer CRT as the display device.

USB

Refer also to your USB device's documentation.

Problem	Procedure
USB device does not work	<p>Check for a firm cable connection between the USB ports on the computer and the USB device.</p> <p>Make sure the USB device drivers are properly installed. Refer to your Windows documentation for information on checking the drivers.</p> <hr/> <p>If you are using an operating system that does not support USB, you can still use a USB mouse and/or USB keyboard. If these devices do not work, make sure the USB KB/Mouse Legacy Emulation item in HW Setup is set to [Enabled].</p> <hr/> <p>If problems persist, contact your dealer.</p>

USB Sleep and Charge function

Problem	Procedure
I cannot use the USB Sleep and Charge function	<p>The setting of USB Sleep and Charge function may be [Disabled]. Change the setting to [Enabled] in the HW Setup.</p> <hr/> <p>When there is a current overflow of the external device connected to the compatible port, USB bus power (DC5V) supply may be stopped for safety reasons. When the happens, disconnect an external device if some external devices are connected. After that, turn the power of the computer ON/OFF to restore the function. If this function can not be still used even if only one external device is connected, stop using the external device because its current is over the acceptable value of this computer.</p> <hr/> <p>Some external devices may not be able to use the USB Sleep and Charge function. In this case, please try one or more of the following methods.</p> <ul style="list-style-type: none"> ■ Change a mode setting of [Enabled] by the HW Setup. ■ Turn OFF the computer while external devices are connected. <p>If this function can not be still used, change the setting to [Disabled] in the BIOS Setup and stop using the function.</p>

Problem	Procedure
<p>The battery depletes quickly even when I have turned OFF the power of the computer</p>	<p>When USB Sleep and Charge function is set to [Enabled] in the HW Setup, USB bus power (DC5V) will be supplied to the external device connected to the compatible port. If external device is connected to the compatible port when the AC adaptor is not connected to the computer, the battery of the computer will be depleted even when the power of the computer is turned OFF. Connect the AC adaptor to the computer or change the USB Sleep and Charge function setting the [Disabled] in the HW Setup. Instead use a USB Port does not have the USB Sleep and Charge function-compatible icon (⚡).</p>
<p>External devices connected to the compatible ports do not work when connected to a compatible port</p>	<p>Some external devices may not work when connected to a compatible port when the USB Sleep and Charge function is [Enabled] in the HW Setup.</p> <p>Reconnect the external device after turning ON the computer.</p> <p>If the external device still does not work, connect device to an USB port that does not have the USB Sleep and Charge function-compatible icon (⚡) or change the USB Sleep and Charge function setting to [Disabled] in the HW Setup.</p>
<p>The USB WakeUp function does not work</p>	<p>When USB Sleep and Charge function is set to [Enabled] in the HW Setup, the USB WakeUp function does not work for ports that support the USB Sleep and Charge function. In that case, use an USB port that does not have the USB Sleep and Charge function-compatible icon (⚡) or change the USB Sleep and Charge function setting to [Disabled] in the HW Setup.</p>

eSATA/USB combo port

Refer also to your eSATA device and USB device's documentation.

Problem	Procedure
<p>e/SATA device or USB device does not work</p>	<p>Check for a firm cable connection between the eSATA/USB combo port on the computer and the eSATA device or USB device.</p> <p>Make sure the eSATA device or USB device drivers are properly installed. Refer to your Windows documentation for information on checking the drivers.</p>

Problem	Procedure
	<p>If you are using an operating system that does not support USB, you can still use a USB mouse and/or USB keyboard. If these devices do not work, make sure the USB KB/Mouse Legacy Emulation item in HW Setup is set to [Enabled].</p> <p>If problems persist, contact your dealer.</p>

Modem

Problem	Procedure
Communication software can't initialize modem	Make sure the computer's internal modem settings are correct. Refer to <i>Phone and Modem Options</i> in the Control Panel.
You can hear a dial tone but can't make a call	<p>If the call is going through a PBX machine, make sure the communication application's tone dial detection feature is disabled.</p> <p>You can also use the ATX command.</p>
You place a call, but a connection can't be made	Make sure the settings are correct in your communications application.
After making a call you can't hear a ring	<p>Make sure the tone or pulse selection in your communications application is set correctly.</p> <p>You can also use the ATD command. Refer to the chapter on AT commands in online help files for Appendix C, AT Command.</p>
Communication is cut off unexpectedly	The computer will automatically cut off communication when connection with the carrier is not successful for a set time interval. Try lengthening this time interval.
A CONNECT display is quickly replaced by NO CARRIER	<p>Check the error control setting in your communications application.</p> <p>You can also use the ATN command.</p>

Problem	Procedure
Character display becomes garbled during a communication	<p>In data transmission, make sure the parity bit and stop bit settings correspond with those of the remote computer.</p> <p>Check the flow control and communication protocol.</p>
You cannot receive an incoming call	<p>Check the rings before auto answer setting in an incoming call your communications application.</p> <p>You can also use the ATSO command.</p> <p>If problems persist, contact your dealer.</p>

Sleep/Hibernation

Problem	Procedure
The system will not enter sleep/hibernation	<p>Is Windows Media Player open? The system might not enter sleep/hibernation, if Windows Media Player is either playing a selection or finished playing a selection. Close Windows Media Player before you select sleep/hibernation.</p> <p>If problems persist, contact your dealer.</p>

LAN

Problem	Procedure
Cannot access LAN	Check for a firm cable connection between the LAN jack and the LAN HUB.
Wake-up on LAN	<p>Make sure the AC adaptor is connected. The does not work Wake-up on LAN function consumes power even when the system is off.</p> <p>If problems persist, consult your LAN administrator.</p>

Wireless LAN

If the following procedures do not restore LAN access, consult your LAN administrator. For more information on wireless communication, refer to Chapter 4, *Operating Basics*.

Problem	Procedure
Cannot access Wireless LAN	<p>Make sure the computer's wireless communication switch is set to on.</p> <p>If problems persist, consult your LAN administrator.</p>

Bluetooth

For more information on wireless communication, refer to Chapter 4, *Operating Basics*

Problem	Procedure
Cannot access Bluetooth device	<p>Make sure the computer's wireless communication switch is set to on.</p> <p>Make sure the Bluetooth Manager is running and the power to the Bluetooth device is turned on.</p> <p>Make sure no optional Bluetooth Adpater is installed in the computer. The built-in Bluetooth function and an optional Bluetooth Adpater cannot operate simultaneously.</p> <p>If problems persist, contact your dealer.</p>

i.LINK (IEEE1394) device

Problem	Procedure
i.LINK device does not function	<p>Make sure the cable is securely connected to the computer and to the device.</p> <p>Make sure the device's power is turned on.</p> <p>Reinstall the drivers. Open the Windows Control Panel and double-click the Add Hardware icon. Follow the on-screen directions.</p> <p>Restart Windows.</p> <p>If problems persist, contact your dealer.</p>

Recovery discs

Problem	Procedure
<p>The following message appears when executing Recovery Disc Creator.</p> <p>[The Recovery Disc Creator can not be launched because there is no recovery partition.]</p>	<p>You will see this message if you have previously chosen to remove the partition and are trying to create Recovery Media. When there is no recovery partition, the Recovery Disc Creator cannot make Recovery Media.</p> <p>However, if you have already created a "Recovery Media", you can use it to restore the recovery partition.</p> <p>Simply follow the instructions in "Restoring the preinstall software from your creating Recovery Media" section in this manual. You will be directed to select Restore Original Factory Image from the drop-down menu. If you have not created Recovery Media, please contact TOSHIBA support for assistance.</p>

FM tuner

Problem	Procedure
Poor reception	<p>Adjust the FM tuner antenna.</p> <p>Make sure the FM tuner antenna connection is secure.</p>

TOSHIBA support

If you require any additional help using your computer or if you are having problems operating the computer, you may need to contact TOSHIBA for additional technical assistance.

Before you call

Some problems you experience may be related to software or the operating system so it is important that you investigate other sources of assistance first. Before contacting TOSHIBA, try the following:

- Review troubleshooting sections in the documentation supplied with your software and/or peripheral devices.
- If a problem occurs when you are running software applications, consult the software documentation for troubleshooting suggestions and consider calling the software company's technical support department for assistance.
- Consult the dealer you purchased your computer and/or software. They are your best resource for current information and support.

Where to write

If you are still unable to solve the problem and suspect that it is hardware related, write to TOSHIBA at the nearest location listed on the below.

Outside of Europe	Europe
<p>Australia TOSHIBA Australia Pty. Ltd. Information Systems Division 84-92 Talavera Road North Ryde N.S.W. 2113 Sydney</p>	<p>Germany & Austria TOSHIBA Europe (I.E.) GmbH Geschäftsbereich, Deutschland-Österreich Hammfelddamm8, D-41460 Neuss, Germany</p>
<p>Canada TOSHIBA of Canada Ltd. 191 McNabb Street, Markham, Ontario L3R 8H2</p>	<p>France TOSHIBA Systèmes France S.A. 7, Rue Ampère B.P. 131, 92804 Puteaux Cedex</p>
<p>China TOSHIBA Personal Computer & Network (Shanghai) Co., Ltd. 43F, Hongkong new world tower, No. 300 Huai Hai Zhong Road, Shanghai, P.R. China 200021</p>	<p>Netherlands TOSHIBA Information Systems, Benelux B.V. Rivium Boulevard 41 2909 LK Capelle a/d IJssel</p>
<p>United States of America TOSHIBA America Information Systems, Inc. 9740 Irvine Boulevard Irvine, California 92618 USA</p>	<p>Spain TOSHIBA Information Systems, ESPAÑA Parque Empresarial San Fernando Edificio Europa, 1ª Planta, Escalera A 28830 Madrid</p>
<p>Singapore TOSHIBA Singapore Pte. Ltd. 438B Alexandra Road #06-01 Alexandra Technopark Singapore 119968</p>	<p>United Kingdom TOSHIBA Information Systems (U.K.) Ltd. TOSHIBA Court Weybridge Business Park Addlestone Road Weybridge, Surrey KT15 2UL</p>
<p>India TOSHIBA India Pvt Ltd. PC Division 6th Floor, DR Gopal Das Bhawan Barakhamba Road, Delhi-110001, India</p>	<p>The Rest of Europe TOSHIBA Europe (I.E.) GmbH Geschäftsbereich, Deutschland-Österreich Hammfelddamm 8, D-41460 Neuss, Germany</p>

Chapter 10

Disclaimers

This chapter states the Disclaimer(s) information applicable to TOSHIBA computers.

CPU

Central Processing Unit (CPU) Performance Disclaimer.

CPU performance in your computer product may vary from specifications under the following conditions:

- use of certain external peripheral products
- use of battery power instead of AC power
- use of certain multimedia, computer generated graphics or video applications
- use of standard telephone lines or low speed network connections
- use of complex modeling software, such as high end computer aided design applications
- use of several applications or functionalities simultaneously
- use of computer in areas with low air pressure (high altitude > 1,000 meters or > 3,280 feet above sea level)
- use of computer at temperatures outside the range of 5°C to 30°C (41°F to 86°F) or > 25°C (77°F) at high altitude (all temperature references are approximate and may vary depending on the specific computer model-please refer to your PC documentation or visit the Toshiba website at <http://www.pcsupport.toshiba.com> for details).

CPU performance may also vary from specifications due to design configuration.

Under some conditions, your computer product may automatically shut-down. This is a normal protective feature designed to reduce the risk of lost data or damage to the product when used outside recommended conditions. To avoid risk of lost data, always make back-up copies of data by periodically storing it on an external storage medium. For optimum performance, use your computer product only under recommended conditions. Read additional restrictions in your product documentation. Contact Toshiba technical service and support, refer to TOSHIBA support section in chapter 9, *Troubleshooting* for more information.

64-Bit Computing. 64-bit processors are designed to take advantage of 32 and 64 bit computing.

64-bit computing requires that the following hardware and software requirements are met:

- 64-bit Operating System
- 64-bit CPU, Chipset and BIOS (Basic Input/Output System)
- 64-bit Device drivers
- 64-bit applications

Certain device drivers and/or applications may not be compatible with a 64-bit CPU and therefore may not function properly. A 32-bit version of the operating system is preinstalled on your computer unless explicitly stated that the operating system is 64-bit. See "<http://www.pcsupport.toshiba.com>" for more information.

Core™ 2 Duo or Core™ Duo Processor.

Intel® Dual Core Technology is a new technology designed to deliver improved performance to the notebook PC. Performance or compatibility may vary. For more information on Intel's Core 2 Duo processors, visit: <http://www.intel.com/core2duo/>

See 64-Bit Computing Legal Footnote, if applicable.

Memory (main system)

Part of the main system memory may be used by the graphics system for graphics performance and therefore reduce the amount of main system memory available for other computing activities. The amount of main system memory allocated to support graphics may vary depending on the graphics system, applications utilized, system memory size and other factors.

For PC's configured with 4 GB of system memory, the full system memory space for computing activities will be considerably less and will vary by model and system configuration.

Battery life

Battery life may vary considerably depending on product model, configuration, applications, power management settings and features utilized, as well as the natural performance variations produced by the design of individual components. Published battery life numbers are achieved on select models and configurations tested by Toshiba at the time of publication. Recharge time varies depending on usage. Battery may not charge while computer is consuming full power.

After a period of time, the battery will lose its ability to perform at maximum capacity and will need to be replaced. This is a normal phenomenon for all batteries. To purchase a new battery pack, see the accessories information that is shipped with your computer, or visit the Toshiba web site at <http://www.pcsupport.toshiba.com>.

HDD drive capacity

1 Gigabyte (GB) means $10^9 = 1,000,000,000$ bytes using powers of 10. The computer operating system, however, reports storage capacity using powers of 2 for the definition of $1 \text{ GB} = 2^{30} = 1,073,741,824$ bytes, and therefore shows less storage capacity. Available storage capacity will also be less if the product includes one or more pre-installed operating systems, such as Microsoft Windows and/or pre-installed software applications, or media content. Actual formatted capacity may vary.

LCD

Over a period of time, and depending on the usage of the computer, the brightness of the LCD screen will deteriorate. This is an intrinsic characteristic of LCD technology.

Maximum brightness is only available when operating in AC power mode. The screen will dim when the computer is operated on battery power and you will not be able to increase the brightness of the screen.

Graphics Processor Unit (GPU)

Graphics processor unit (GPU) performance may vary depending on product model, design configuration, applications, power management settings and features utilized. GPU performance is only optimized when operating in AC power mode and may decrease considerably when operating in battery power mode.

Wireless LAN

The transmission speed over the wireless LAN and the distance over which wireless LAN can reach may vary depending on surrounding electromagnetic environment, obstacles, access point design and configuration, and client design and software/hardware configurations. The actual transmission speed will be lower than the theoretical maximum speed.

Non-applicable icons

Certain notebook chassis are designed to accommodate all possible configurations for an entire product series. Therefore, please be aware that your selected model may not have all the features and specifications corresponding to all of the icons or switches shown on the notebook chassis, unless you have selected all those features.

Copy protection

Copy protection technology included in certain media may prevent or limit recording or viewing of the media.

Images

All images are simulated for purposes of illustration.

LCD brightness and eye strain

Your LCD display has a brightness approaching that of a TV device. We recommend that you adjust the brightness of your LCD to a comfortable level to prevent possible strain on your eyes.

Appendixes

Table of Contents

Appendix A **Specifications**..... **A-1**
Appendix B **Display Controller** **B-1**
Appendix C **V.90/V.92** **C-1**
Appendix D **Wireless LAN**..... **D-1**
Appendix E **AC Power Cord and Connectors**..... **E-1**

Appendix A

Specifications

This appendix summarizes the computer's technical specifications.

Environmental requirements

	Operating	Non-operating
Ambient temperature	5°C to 35°C	-20°C to 60°C
Relative humidity	20% to 80%	10% to 90%
Altitude (from sea level)	0 to 3,000 meters	0 to 10,000 meters

Power requirements

AC adaptor	100-240 volts AC 50 or 60 hertz (cycles per second)
Computer	19V DC

Built-in modem

The ability of this feature is depending on the model you purchased.

Network control unit (NCU)

Type of NCU	AA
Type of line	Telephone line (analog only)
Type of dialing	Pulse Tone
Control command	AT commands EIA-578 commands
Monitor function	Computer's speaker

Communication specifications

Communication system	Data: Full duplex Fax: Half duplex
Communication protocol	Data ITU-T-Rec (Former CCITT) V.21/V.22/V.22bis/V.32 /V.32bis/V.34/V.90 Bell 103/212A Fax ITU-T-Rec (Former CCITT) V.17/V.29/V.27ter/V.21 ch2
Communication speed	Data transmission and reception 300/1200/2400/4800/7200/9600/12000/14400/ 16800/19200/21600/24000/26400/28800/31200/ 33600 bps Data reception only with V.90 28000/29333/30666/32000/33333/34666/36000/ 37333/38666/40000/41333/42666/44000/45333/ 46666/48000/49333/50666/52000/53333/54666/ 56000 bps Fax 2400/4800/7200/9600/12000/14400 bps
Error correcting	MNP class 4 and ITU-T V.42
Data compression	MNP class 5 and ITU-T V.42bis

Appendix B

Display Controller

Display controller

The display controller interprets software commands into hardware commands that turn particular pixels on or off.

The controller is an advanced Video Graphics Array (VGA) that provides Super VGA (SVGA) and Extended Graphics Array (XGA) support for the internal LCD and external monitors.

A high-resolution external monitor connected to the computer can display up to 2048 horizontal and 1536 vertical pixels at up to 16M colors.

The display controller also controls the video mode, which uses industry standard rules to govern the screen resolution and the maximum number of colors that can be displayed on screen.

Software written for a given video mode will run on any computer that supports the mode.

The computer's display controller supports all SVGA and XGA modes, the most widely used industry standards.



Some of display modes might not be supported depending on the external monitor which you use.



If you are running some application (for example a 3D application or video playback and so on), you may use some disturbance, flickering or frame dropping on your screen. If that occurs,adjust the resolution of display, lowering it until the screen is displayed properly.You could also disable Windows Aero™ to help correct this situation.

Appendix C

V.90/V.92

The TOSHIBA internal modem uses V.90 technology. The modem is capable of downstream speeds of 56Kbps (kilobits per second) when connected to an Internet service provider that supports V.90/V.92. As with any modem, the actual throughput (speed of data transfer) depends on analog telephone line conditions, which can vary considerably. Therefore, many users will experience throughput in the range of 32-44Kbps under normal telephone line conditions. Upstream data flows at the V.34 rate.



V.90 rates can be achieved only when one V.90 capable modem is connected to another. The TOSHIBA Internal modem will select automatically V.34 if the remote modem lacks V.90 capability or if a combination of network and/or phone line conditions prevent V.90 connection.

V.90/V.92 mode

Function	Transmission speed
Data V.90/V.92	From 56K (maximum) to 28Kbps (minimum) Reception only

Table Result codes for a V.90 connection

No.	Result code	Description
70	CONNECT 32000 EC*	Connection at 32000 bits/s
72	CONNECT 36000 EC*	Connection at 36000 bits/s
74	CONNECT 40000 EC*	Connection at 40000 bits/s
76	CONNECT 44000 EC*	Connection at 44000 bits/s
78	CONNECT 48000 EC*	Connection at 48000 bits/s
80	CONNECT 52000 EC*	Connection at 52000 bits/s
82	CONNECT 56000 EC*	Connection at 56000 bits/s
100	CONNECT 28000 EC*	Connection at 28000 bits/s
101	CONNECT 29333 EC*	Connection at 29333 bits/s
102	CONNECT 30666 EC*	Connection at 30666 bits/s
103	CONNECT 33333 EC*	Connection at 33333 bits/s
104	CONNECT 34666 EC*	Connection at 34666 bits/s
105	CONNECT 37333 EC*	Connection at 37333 bits/s
106	CONNECT 38666 EC*	Connection at 38666 bits/s
107	CONNECT 41333 EC*	Connection at 41333 bits/s
108	CONNECT 42666 EC*	Connection at 42666 bits/s
109	CONNECT 45333 EC*	Connection at 45333 bits/s
110	CONNECT 46666 EC*	Connection at 46666 bits/s
111	CONNECT 49333 EC*	Connection at 49333 bits/s
112	CONNECT 50666 EC*	Connection at 50666 bits/s
113	CONNECT 53333 EC*	Connection at 53333 bits/s
114	CONNECT 54666 EC*	Connection at 54666 bits/s

*EC stands for the Error Control method, which appears only when the extended result codes configuration option is enabled. EC is replaced by one of the following symbols, depending on the error control method used.

V42bis	V.42 error control and V.42bis data compression
V42	V.42 error control only
NoEC	No error control protocol

AT Command

-V90=*	V.90 Dial Line Rate
	-V90 sets the maximum V.90 downstream that the modem attempts to connect
-V90=0	V.90 disabled
-V90=1	V.90 enabled: automatic speed selection - maximum modem speed(default)

Appendix D

Wireless LAN

This appendix is intended to help you get your Wireless LAN network up and running, with a minimum of parameters.

Card specifications

Form Factor	■ Mini Card
Compatibility	■ IEEE 802.11 Standard for Wireless LANs ■ Wi-Fi (Wireless Fidelity) certified by the Wi-Fi Alliance. The 'Wi-Fi CERTIFIED' logo is a certification mark of the Wi-Fi Alliance.
Network Operating System	■ Microsoft® Windows Networking
Media Access Protocol	■ CSMA/CA (Collision Avoidance) with Acknowledgment (ACK)
Data Rate	■ 54/48/36/24/18/9/6 Mb/s (Revision A and G) ■ 11/5.5/2/1 Mb/s (Revision B)

Radio characteristics

Radio characteristics of Wireless LAN cards may vary according to:

- Country/region where the product was purchased
- Type of product

Wireless communication is often subject to local radio regulations. Although Wireless LAN wireless networking products have been designed for operation in the license-free 2.4 GHz and 5 GHz band, local radio regulations may impose a number of limitations to the use of wireless communication equipment.



Refer to the sheet Information to the User for regulatory information that may apply in your country/region.

-
- | | |
|----------------------|---|
| R-F Frequency | <ul style="list-style-type: none"> ■ Band 5 GHz (5150-5850 MHz) (Revision A, draft N) ■ Band 2.4 GHz (2400-2483.5 MHz)
(Revision B, G, draft N) |
|----------------------|---|
-

The range of the wireless signal is related to the transmit rate of the wireless communication. Communications at lower transmit range may travel larger distances.

- The range of your wireless devices can be affected when the antennas are placed near metal surfaces and solid high-density materials.
- Range is also impacted due to “obstacles” in the signal path of the radio that may either absorb or reflect the radio signal.

Supported frequency sub-bands

Subject to the radio regulations that apply in your country/region, your Wireless LAN card may support a different set of 5 GHz/2.4 GHz channels. Consult your Authorized Wireless LAN or TOSHIBA Sales office for information about the radio regulations that apply in your country/region.

Table Wireless IEEE 802.11 Channels Sets (Revision B and G)

Frequency Range Channel ID	2400-2483.5 MHz
1	2412
2	2417
3	2422
4	2427
5	2432
6	2437
7	2442
8	2447
9	2452
10	2457* ¹
11	2462
12	2467* ²
13	2472* ²

When installing Wireless LAN cards, the channel configuration is managed as follows:

- For wireless clients that operate in a Wireless LAN infrastructure, the Wireless LAN card will automatically start operation at the channel identified by the Wireless LAN Access Point. When roaming between different access points the station can dynamically switch to another channel if required.
- In a Wireless LAN Access Point, the Wireless LAN card will use the factory-set default channel (printed in bold), unless the LAN Administrator selected a different channel when configuring the Wireless LAN Access Point device.

Table Wireless IEEE 802.11 Channels Sets (Revision A)

Frequency Range	Channel ID	5150-5850 MHz	Note
	36	5180	
	40	5200	
	44	5220	
	48	5240	
	52	5260	
	56	5280	
	60	5300	
	64	5320	
	100	5500 ^{*3}	
	104	5520 ^{*3}	
	108	5540 ^{*3}	
	112	5560 ^{*3}	
	116	5580 ^{*3}	
	120	5600 ^{*3}	
	124	5620 ^{*3}	
	128	5640 ^{*3}	
	132	5660 ^{*3}	
	136	5680 ^{*3}	
	140	5700 ^{*3}	
	149	5745 ^{*3}	US only ^{*4}
	153	5765 ^{*3}	US only ^{*4}
	157	5785 ^{*3}	US only ^{*4}
	161	5805 ^{*3}	US only ^{*4}

*1 Factory-set default channels

*2 Refer to the sheet Approved Countries/Regions for use for the countries/regions that in which these channels can be used.

*3 These channels are available to A/B/G combo type only.

*4 Available Area: US (USA, CANADA) only.

Appendix E

AC Power Cord and Connectors

The AC input plug of power cord must be compatible with various international AC power outlets. Power cords need to meet the local standards and the specifications listed as below:

Length:	Minimum 1.7 meters
Wire size:	Minimum 0.75 mm ²
Current rating:	Minimum 2.5 amperes
Voltage rating:	125 or 250V AC (depending on country/region's power standards)

Certification agencies

Europe:

Austria:	OVE	Italy:	IMQ
Belgium:	CEBEC	The Netherlands:	KEMA
Denmark:	DEMKO	Norway:	NEMKO
Finland:	FIMKO	Sweden:	SEMKO
France:	LCIE	Switzerland:	SEV
Germany:	VDE	United Kingdom:	BSI

Outside of Europe:

U.S. and Canada:	UL listed and CSA certified No. 18 AWG, Type SVT or SPT-2		
China:	CCC, CQC	India:	STQC
Australia:	AS		

In Europe, two conductors power cords must be VDE type, H05VVH2-F or H03VVH2-F; while three conductors be VDE type, H05VV-F.

For the United States and Canada, two pin plug configuration must be 2-15P (250V) or 1-15P (125V); while three pin be 6-15P (250V) or 5-15P (125V) as designated in the U.S. National Electrical code handbook and the Canadian Electrical Code Part II.

The following illustrations show the plug shapes for USA, Australia, Canada, United Kingdom, Europe, and China.

USA

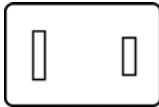

UL approved

United Kingdom

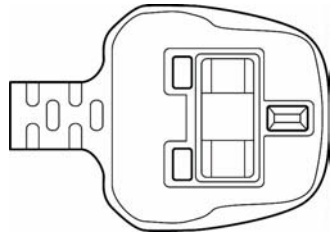

BS approved

Australia

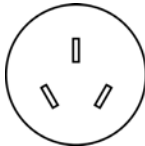

AS approved

Europe

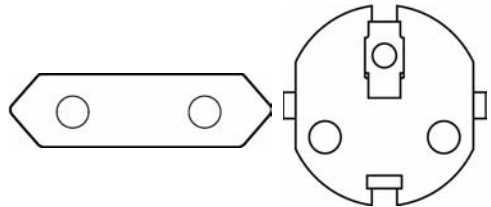

Approved by the appropriate agency

Canada



CSA approved

China

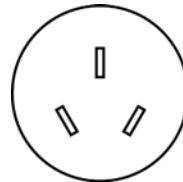

CCC approved

Glossary

The terms in this glossary cover topics related to this manual. Alternate naming is included for reference.

Abbreviations

- AC:** alternating current
- AGP:** accelerated graphics port
- ANSI:** American National Standards Institute
- APM:** advanced power manager
- ASCII:** American Standard Code for Information Interchange
- BIOS:** basic input output system
- CD-ROM:** Compact Disc Read Only Memory
- CD-RW:** Compact Disc ReWritable
- CMOS:** complementary metal-oxide semiconductor
- CPU:** central processing unit
- CRT:** cathode ray tube
- DC:** direct current
- DDC:** display data channel
- DMA:** direct memory access
- DOS:** disk operating system
- DVD:** digital versatile disc
- DVD-R:** Digital Versatile Disc Recordable
- DVD-RAM:** Digital Versatile Disc Random Access Memory
- DVD-R DL:** Digital Versatile Disc Recordable Dual Layer
- DVD-ROM:** Digital Versatile Disc Read Only Memory
- DVD-RW:** Digital Versatile Disc ReWritable
- DVD+R DL:** Digital Versatile Disc Recordable Double Layer
- ECP:** extended capabilities port
- FDD:** floppy diskette drive
- FIR:** fast infrared
- HDD:** hard disk drive
- IDE:** integrated drive electronics

I/O: input/output
IrDA: Infrared Data Association
IRQ: interrupt request
KB: kilobyte
LCD: liquid crystal display
LED: light emitting diode
LSI: large scale integration
MB: megabyte
OCR: optical character recognition (reader)
PCB: printed circuit board
PCI: peripheral component interconnect
RAM: random access memory
RGB: red, green, and blue
ROM: read only memory
RTC: real time clock
SCSI: small computer system interface
SIO: serial input/output
TFT: thin-film transistor
UART: universal asynchronous receiver/transmitter
USB: Universal Serial Bus
VESA: Video Electronic Standards Association
VGA: video graphics array
VRT: voltage reduction technology
WXGA+: wide extended graphics array plus
WUXGA: wide ultra extended graphics array
XGA: extended graphics array

A

adaptor: A device that provides an interface between two dissimilar electronic devices. For example, the AC adaptor modifies the power from a wall outlet for use by the computer. This term also refers to the add-in circuit cards that control external devices, such as video monitors and magnetic tape devices.

allocate: To assign a space or function for a specific task.

alphanumeric: Keyboard characters including letters, numbers and other symbols, such as punctuation marks or mathematical symbols.

alternating current (AC): Electric current that reverses its direction of flow at regular intervals.

analog signal: A signal whose characteristics such as amplitude and frequency vary in proportion to (are an analog of) the value to be transmitted. Voice communications are analog signals.

- ANSI:** American National Standards Institute. An organization established to adopt and define standards for a variety of technical disciplines. For example, ANSI defined the ASCII standard and other information processing requirements.
- antistatic:** A material used to prevent the buildup of static electricity.
- application:** A group of programs that together are used for a specific task such as accounting, financial planning, spreadsheets, word processing and games.
- ASCII:** American Standard Code for Information Interchange. ASCII code is a set of 256 binary codes that represent the most commonly used letters, numbers, and symbols.
- async:** Short for asynchronous.
- asynchronous:** Lacking regular time relationship. As applied to computer communications, asynchronous refers to the method of transmitting data that does not require a steady stream of bits to be transmitted at regular time intervals.

B

- backup:** A duplicate copy of files kept as a spare in case the original is destroyed.
- batch file:** A file that can be executed from the system prompt containing a sequence of operating system commands or executable files.
- binary:** The base two number system composed of zeros and ones (off or on), used by most digital computers. The right-most digit of a binary number has a value of 1, the next a value of 2, then 4, 8, 16, and so on. For example, the binary number 101 has a value of 5. *See also* ASCII.
- BIOS:** Basic Input Output System. The firmware that controls data flow within the computer. *See also* firmware.
- bit:** Derived from "binary digit," the basic unit of information used by the computer. It is either zero or one. Eight bits is one byte. *See also* byte.
- board:** A circuit board. An internal card containing electronic components, called chips, which perform a specific function or increase the capabilities of the system.
- boot:** Short for bootstrap. A program that starts or restarts the computer. The program reads instructions from a storage device into the computer's memory.
- bps:** Bits per second. Typically used to describe the data transmission speed of a modem.
- buffer:** The portion of the computer's memory where data is temporarily stored. Buffers often compensate for differences in the rate of flow from one device to another.
- bus:** An interface for transmission of signals, data or electric power.
- byte:** The representation of a single character. A sequence of eight bits treated as a single unit; also the smallest addressable unit within the system.

C

- cache memory:** High speed memory which stores data that increases processor speed and data transfer rate. When the CPU reads data from main memory, it stores a copy of this data in cache memory. The next time the CPU needs that same data, it looks for it in the cache memory rather than the main memory, which saves time. The computer has two cache levels. Level one is incorporated into the processor and level two resides in external memory.
- capacity:** The amount of data that can be stored on a magnetic storage device such as a floppy diskette or hard disk drive. It is usually described in terms of kilobytes (KB), where one KB = 1024 bytes and megabytes (MB), where one MB = 1024 KB.
- card:** Synonym for board. See board.
- CardBus:** An industry standard bus for 32-bit PC Cards.
- CD-ROM:** A Compact Disc Read Only Memory is a high capacity disc that can be read from but not written to. The CD-ROM drive uses a laser, rather than magnetic heads, to read data from the disc.
- CD-R:** A Compact Disc Recordable disc can be written once and read many times. See also CD-ROM.
- CD-RW:** A Compact Disc ReWritable disc can be rewritten many times. See also CD-ROM.
- character:** Any letter, number, punctuation mark, or symbol used by the computer. Also synonymous with byte.
- chassis:** The frame containing the computer.
- chip:** A small semiconductor containing computer logic and circuitry for processing, memory, input/output functions and controlling other chips.
- CMOS:** Complementary Metal-Oxide Semiconductor. An electronic circuit fabricated on a silicon wafer that requires very little power. Integrated circuits implemented in CMOS technology can be tightly packaged and are highly reliable.
- cold start:** Starting a computer that is currently off (turning on the power).
- COM1, COM2, COM3 and COM4:** The names assigned to the serial and communication ports.
- commands:** Instructions you enter at the terminal keyboard that direct the actions of the computer or its peripheral devices.
- communications:** The means by which a computer transmits and receives data to and from another computer or device.
- compatibility:** 1) The ability of one computer to accept and process data in the same manner as another computer without modifying the data or the media upon which it is being transferred.
2) the ability of one device to connect to or communicate with another system or component.
- components:** Elements or parts (of a system) which make up the whole (system).

- Composite Video (YUV):** A standard video signal used to transmit images, e.g. from a VCR to a TV.
- computer program:** A set of instructions written for a computer that enable it to achieve a desired result.
- computer system:** A combination of hardware, software, firmware, and peripheral components assembled to process data into useful information.
- configuration:** The specific components in your system (such as the terminal, printer, and disk drives) and the settings that define how your system works. You use the HW Setup program to control your system configuration.
- control keys:** A key or sequence of keys you enter from the keyboard to initiate a particular function within a program.
- controller:** Built-in hardware and software that controls the functions of a specific internal or peripheral device (e.g. keyboard controller).
- co-processor:** A circuit built into the processor that is dedicated to intensive math calculations.
- CPS:** Characters Per Second. Typically used to indicate the transmission speed of a printer.
- CPU:** Central Processing Unit. The portion of the computer that interprets and executes instructions.
- CRT:** Cathode Ray Tube. A vacuum tube in which beams projected on a fluorescent screen-producing luminous spots. An example is the television set.
- cursor:** A small, blinking rectangle or line that indicates the current position on the display screen.

D

- data:** Information that is factual, measurable or statistical that a computer can process, store, or retrieve.
- data bits:** A data communications parameter controlling the number of bits (binary digits) used to make up a byte. If data bits = 7 the computer can generate 128 unique characters. If data bits = 8 the computer can generate 256 unique characters.
- DC:** Direct Current. Electric current that flows in one direction. This type of power is usually supplied by batteries.
- default:** The parameter value automatically selected by the system when you or the program do not provide instructions. Also called a preset value.
- delete:** To remove data from a disk or other data storage device. Synonymous with erase.
- device driver:** A program that controls communication between a specific peripheral device and the computer. The CONFIG.SYS file contains device drivers that MS-DOS loads when you turn the computer on.
- dialog box:** A window that accepts user input to make system settings or record other information.

- Digital Audio:** An audio compression standard that enables high-quality transmission and real-time playback of sound files.
- disk drive:** The device that randomly accesses information on a disk and copies it to the computer's memory. It also writes data from memory to the disk. To accomplish these tasks, the unit physically rotates the disk at high speed past a read-write head.
- disk storage:** Storing data on magnetic disk. Data is arranged on concentric tracks much like a phonograph record.
- display:** A CRT, LCD, or other image producing device used to view computer output.
- documentation:** The set of manuals and/or other instructions written for the users of a computer system or application. Computer system documentation typically includes procedural and tutorial information as well as system functions.
- DOS:** Disk Operating System. See operating system.
- driver:** A software program, generally part of the operating system, that controls a specific piece of hardware (frequently a peripheral device such as a printer or mouse).
- DVB-T (Digital Video Broadcasting - Terrestrial):** Also known as terrestrial digital TV. Digital TV broadcasting standard.
- DVD-R (+R, -R):** A Digital Versatile Disc Recordable disk can be written once and read many times. The DVD-R drive uses a laser to read data from the disc.
- DVD-RAM:** A Digital Versatile Disc Random Access Memory is a high-capacity, high performance disc that allows you to store large volumes of data. The DVD-RAM drive uses a laser to read data from the disc.
- DVD-R DL:** A disc having two layers on one side with the DVD-R storage capacity about 1.8 times larger than before. The DVD-RW drive uses a laser to read data from the disc.
- DVD-ROM:** A Digital Versatile Disc Read Only Memory is a high capacity, high performance disc suitable for play back of video and other high-density files. The DVD-ROM drive uses a laser to read data from the disc.
- DVD-RW (+RW, -RW):** A Digital Versatile Disc ReWritable disc can be rewritten many times.
- DVD+R DL:** A disc having two layers on one side with the DVD+R storage capacity about 1.8 times larger than before. The DVD-RW drive uses a laser to read data from the disc.

E

- echo:** To send back a reflection of the transmitted data to the sending device. You can display the information on the screen, or output it to the printer, or both. When a computer receives back data it transmitted to a CRT (or other peripheral device) and then retransmits the data to printer, the printer is said to echo the CRT.
- erase:** See delete.

escape: 1) A code (ASCII code 27), signaling the computer that what follows are commands; used with peripheral devices such as printers and modems.

2) A means of aborting the task currently in progress.

escape guard time: A time before and after an escape code is sent to the modem which distinguishes between escapes that are part of the transmitted data, and escapes that are intended as a command to the modem.

execute: To interpret and execute an instruction.

Extended Capability Port: An industry standard that provides a data buffer, switchable forward and reverse data transmission, and run length encoding (RLE) support.

F

fast infrared: An industry standard that enables cableless infrared serial data transfer at speeds of up to 4 Mbps.

file: A collection of related information; a file can contain data, programs, or both.

firmware: A set of instructions built into the hardware which controls and directs a microprocessor's activities.

floppy diskette: A removable disk that stores magnetically encoded data.

floppy diskette drive (FDD): An electromechanical device that reads and writes to floppy diskettes.

Fn-esse: A TOSHIBA utility that allows you to assign functions to hot keys.

folder: An icon in Windows used to store documents or other folders.

format: The process of readying a blank disk for its first use. Formatting establishes the structure of the disk that the operating system expects before it writes files or programs onto the disk.

function keys: The keys labeled **F1** through **F12** that tell the computer to perform certain functions.

G

gigabyte (GB): A unit of data storage equal to 1024 megabytes. See *also* megabyte.

graphics: Drawings, pictures, or other images, such as charts or graphs, to present information.

H

hard disk: A non-removable disk usually referred to as drive C. The factory installs this disk and only a trained engineer can remove it for servicing. Also called fixed disk.

hard disk drive (HDD): An electromechanical device that reads and writes a hard disk. See *also* hard disk.

hardware: The physical electronic and mechanical components of a computer system: typically, the computer itself, external disk drives, etc. *See also* software and firmware.

hertz: A unit of wave frequency that equals one cycle per second.

hexadecimal: The base 16 numbering system composed of the digits 0 through 9 and the letters A, B, C, D, E, and F.

host computer: The computer that controls, regulates, and transmits information to a device or another computer.

hot key: The computer's feature in which certain keys in combination with the extended function key, **FN**, can be used to set system parameters, such as speaker volume.

HW Setup: A TOSHIBA utility that allows you to set the parameters for various hardware components.

I

icon: A small graphic image displayed on the screen or in the indicator panel. In Windows, an icon represents an object that the user can manipulate.

i.LINK (IEEE1394): This port enables high-speed data transfer directly from external devices such as digital video cameras.

input: The data or instructions you provide to a computer, communication device or other peripheral device from the keyboard or external or internal storage devices. The data sent (or output) by the sending computer is input for the receiving computer.

instruction: Statements or commands that specify how to perform a particular task.

interface: 1) Hardware and/or software components of a system used specifically to connect one system or device to another.

2) To physically connect one system or device to another to exchange information.

3) The point of contact between user, the computer, and the program, for example, the keyboard or a menu.

interrupt request: A signal that gives a component access to the processor.

I/O: Input/output. Refers to acceptance and transfer of data to and from a computer.

I/O devices: Equipment used to communicate with the computer and transfer data to and from it.

IrDA 1.1: An industry standard that enables cableless infrared serial data transfer at speeds of up to 4 Mbps.

J

jumper: A small clip or wire that allows you to change the hardware characteristics by electrically connecting two points of a circuit.

K

K: Taken from the Greek word kilo, meaning 1000; often used as equivalent to 1024, or 2 raised to the 10th power. *See also* byte and kilobyte.

KB: *See* kilobyte.

keyboard: An input device containing switches that are activated by manually pressing marked keys. Each keystroke activates a switch that transmits a specific code to the computer. For each key, the transmitted code is, in turn, representative of the (ASCII) character marked on the key.

kilobyte (KB): A unit of data storage equal to 1024 bytes. *See also* byte and megabyte.

L

level 2 cache: *See* cache.

Light Emitting Diode (LED): A semiconductor device that emits light when a current is applied.

Liquid Crystal Display (LCD): Liquid crystal sealed between two sheets of glass coated with transparent conducting material. The viewing-side coating is etched into character forming segments with leads that extend to the edge of the glass. Applying a voltage between the glass sheets alters the brightness of the liquid crystal.

LSI: Large Scale Integration.

- 1) A technology that allows the inclusion of up to 100,000 simple logic gates on a single chip.
- 2) An integrated circuit that uses large scale integration.

M

main board: *See* motherboard.

megabyte (MB): A unit of data storage equal to 1024 kilobytes. *See also* kilobyte.

megahertz: A unit of wave frequency that equals 1 million cycles per second. *See also* hertz.

menu: A software interface that displays a list of options on the screen. Also called a screen.

microprocessor: A hardware component contained in a single integrated circuit that carries out instructions. Also called the central processing unit (CPU), one of the main parts of the computer.

mode: A method of operation, for example, the Boot Mode, Sleep Mode or the Hibernation Mode.

modem: Derived from modulator/demodulator, a device that converts (modulates) digital data for transmission over telephone lines and then converts modulated data (demodulates) to digital format where received.

monitor: A device that uses rows and columns of pixels to display alphanumeric characters or graphic images. *See also* CRT.

motherboard: A name sometimes used to refer to the main printed circuit board in processing equipment. It usually contains integrated circuits that perform the processor's basic functions and provides connectors for adding other boards that perform special functions. Sometimes called a main board.

N

non-system disk: A formatted floppy diskette you can use to store programs and data but you cannot use to start the computer. *See* system disk.

nonvolatile memory: Memory, usually read-only (ROM), that is capable of permanently storing information. Turning the computer's power off does not alter data stored in nonvolatile memory.

numeric keypad overlay: A feature that allows you to use certain keys on the keyboard to perform numeric entry, or to control cursor and page movement.

O

OCR: Optical Character Recognition (reader). A technique or device that uses laser or visible light to identify characters and input them into a storage device.

online state: A functional state of a peripheral device when it is ready to receive or transmit data.

operating system: A group of programs that controls the basic operation of a computer. Operating system functions include interpreting programs, creating data files, and controlling the transmission and receipt (input/output) of data to and from memory and peripheral devices.

output: The results of a computer operation. Output commonly indicates data.

1) printed on paper, 2) displayed at a terminal, 3) sent through the serial port of internal modem, or 4) stored on some magnetic media.

P

PAL: PAL (Phase Alternating Line) is the dominant video and broadcasting standard in Europe.

parity: 1) The symmetrical relationship between two parameter values (integers) both of which are either on or off; odd or even; 0 or 1.
2) In serial communications, an error detection bit that is added to a group of data bits making the sum of the bits even or odd. Parity can be set to none, odd, or even.

password: A unique string of characters used to identify a specific user. The computer provides various levels of password protection such as user and supervisor.

- pel:** The smallest area of the display that can be addressed by software. Equal in size to a pixel or group of pixels. See pixel.
- peripheral component interconnect:** An industry standard 32-bit bus.
- peripheral device:** An I/O device that is external to the central processor and/or main memory such as a printer or a mouse.
- Péritel:** Péritel is a 21-pin connecting cable/port system that allows images and high-quality stereo sound (including Dolby® Pro-Logic sound formats) to be sent from one audio-visual device to another. It is also known as a “SCART connector” or “Euro connector”.
- pixel:** A picture element. The smallest dot that can be made on a display or printer. Also called a pel.
- plug and play:** A capability with Windows that enables the system to automatically recognize connections of external devices and make the necessary configurations in the computer.
- port:** The electrical connection through which the computer sends and receives data to and from devices or other computers.
- Power Saver Utility:** A TOSHIBA utility that allows you to set the parameters for various power-saving functions.
- printed circuit board (PCB):** A hardware component of a processor to which integrated circuits and other components are attached. The board itself is typically flat and rectangular, and constructed of fiberglass, to form the attachment surface.
- program:** A set of instructions a computer can execute that enables it to achieve a desired result. See *also* application.
- prompt:** A message the computer provides indicating it is ready for or requires information or an action from you.

R

- Radio frequency interference (RFI) shield:** A metal shield enclosing the printed circuit boards of the printer or computer to prevent radio and TV interference. All computer equipment generates radio frequency signals. The FCC regulates the amount of signals a computing device can allow past its shielding. A Class A device is sufficient for office use. Class B provides a more stringent classification for home equipment use. TOSHIBA portable computers comply with Class B computing device regulations.
- Random Access Memory (RAM):** High speed memory within the computer circuitry that can be read or written to.
- restart:** Resetting a computer without turning it off (also called “warm boot” or “soft reset”). See *also* boot.
- RGB:** Red, green and blue. A device that uses three input signals, each activating an electron gun for a primary additive color (red, green and blue) or port for using such a device. See *also* CRT.
- RJ11:** A modular telephone jack.
- RJ45:** A modular LAN jack.

ROM: Read Only Memory: A nonvolatile memory chip manufactured to contain information that controls the computer's basic operation. You cannot access or change information stored in ROM.

S

S-Video: Short for *Super-Video*, a type of connection used by S-VHS videocassette players, camcorders, DVD players, etc. to transmit high-quality video signals.

SCSI: Small Computer System Interface is an industry standard interface for connection of a variety of peripheral devices.

SD Card: Secure Digital cards are flash memory widely used in a variety of digital devices such as digital cameras and Personal Digital Assistants.

SECAM L: SECAM (Sequential Color Memory) is a broadcasting standard used in France.

serial communications: A communications technique that uses as few as two interconnecting wires to send bits one after another.

serial interface: Refer to a type of information exchange that transmits information sequentially, one bit at a time.

SIO: Serial Input/Output. The electronic methodology used in serial data transmission.

soft key: Key combinations that emulate keys on the IBM keyboard, change some configuration options, stop program execution, and access the numeric keypad overlay.

software: The set of programs, procedures and related documentation associated with a computer system. Specifically refers to computer programs that direct and control the computer system's activities. See also hardware.

stop bit: One or more bits of a byte that follow the transmitted character or group codes in asynchronous serial communications.

subpixel: Three elements, one red, one green and blue (RGB), that make up a pixel on the color LCD. The computer sets subpixels independently, each may emit a different degree of brightness. See also pixel.

synchronous: Having a constant time interval between successive bits, characters or events.

system disk: A disk that has been formatted with an operating system. For MS-DOS the operating system is contained in two hidden files and the COMMAND.COM file. You can boot a computer using a system disk. Also called an operating system disk.

T

terminal: A typewriter-like keyboard and CRT display screen connected to the computer for data input/output.

TFT display: A liquid crystal display (LCD) made from an array of liquid crystal cells using active-matrix technology with thin film transistor (TFT) to drive each cell.

touchpad: A pointing device integrated into the TOSHIBA computer palm rest.

TTL: Transistor-transistor logic. A logic circuit design that uses switching transistors for gates and storage.

U

Universal Serial Bus: This serial interface allows you to communicate with several devices connected in a chain to a single port on the computer.

V

VGA: Video Graphics Array is an industry standard video adaptor that allows you to run any popular software.

volatile memory: Random access memory (RAM) that stores information as long as power is supplied to the computer.

W

warm start: Restarting or resetting a computer without turning it off.

window: A portion of the screen that can display its own application, document or dialog box. Often used to mean a Microsoft Windows window.

Wireless LAN: Local Area Network (LAN) through wireless communication.

write protection: A method for protecting a floppy diskette from accidental erasure.

Index

A

- AC adaptor, 1-7, 2-6, 2-27, A-1
 - additional, 1-16, 8-11
 - connecting, 3-2
 - problems, 9-5
 - safety instructions, -iii, -xxix
- ASCII characters, 5-7

B

- Battery
 - charging, 6-7
 - life, 10-3
 - monitoring capacity, 6-9
 - Real Time Clock battery, 1-7, 6-4
 - remote controller, 2-22
 - retention time, 6-10
 - types, 6-3
- Battery pack, 1-7, 1-16, 2-7, 6-3
 - additional, 8-11
 - extending battery life, 6-10
 - indicator, 2-11, 6-2
 - location, 2-7
 - operating time, 6-9
 - problems, 9-5
 - replacing, -xviii, 6-11
 - safety instructions, -iii, 6-5
 - save mode, 1-10
- Bluetooth
 - problems, 9-18
- Bluetooth, 1-9, 4-33
 - indicator, 4-33
 - problems, 9-18
 - switch, 1-9, 2-1

C

- Checklist
 - equipment, 1-1
 - problems, 9-2, 9-3
- Cleaning the computer, 4-35
- COM port, 4-30

D

- DC IN, 2-6
 - connecting, 3-2
 - indicator, 2-11, 6-3
 - location, 2-5
- Display, 2-8, 10-3
 - automatic power off, 1-10
 - brightness down, 5-4
 - brightness up, 5-4
 - controller, B-1
 - HDMI, 8-13
 - HW Setup, 7-3
 - opening, 3-3
 - problems, 9-7, 9-12, 9-13
 - resolution, 5-4
 - safety instructions, 10-4
 - size, 2-8
 - switching, 5-4
- DVD Super Multi (+-R DL) drive,
 - 1-6, 2-14, 4-15
 - problems, 9-8

E

- eSATA/USB combo port, 1-7
 - indicator, 2-11
 - location, 2-3
 - problems, 9-15

ExpressCard, 1-8
location of slot, 2-3
overheating, -xxix
problems, 9-11, 9-12
using, 2-4, 8-2

External monitor, 8-11
controller, B-1
HW Setup, 7-3
port, 1-7, 2-3
problems, 9-12

F

Fan vent
location, 2-3

Fingerprint sensor, 2-9
location, 2-8, 4-2
problems, 9-11
using, 1-14, 4-2

FM tuner
jack location, 2-5
problems, 9-19
using, 4-31

FN + 1 (TOSHIBA zooming utility reduce), 5-5

FN + 2 (TOSHIBA zooming utility enlarge), 5-5

FN + ALT (enhanced keyboard simulation), 5-3

FN + CTRL (enhanced keyboard simulation), 5-3

FN + ENTER, 5-3

FN + ESC (sound mute), 5-3

FN + F1 (lock), 5-3

FN + F12 (scroll lock), 5-3

FN + F2 (power plan), 5-3

FN + F3 (sleep), 5-3

FN + F4 (hibernate), 5-4

FN + F5 (output), 5-4

FN + F6 (brightness down), 5-4

FN + F7 (brightness up), 5-4

FN + F8 (wireless), 5-4

FN + F9 (touchpad), 5-4

FN + SPACE (zoom), 5-4

Function button, 2-9, 2-10, 4-14
indicator, 7-7
location, 2-8

Function keys, 5-2

H

Hard disk drive, 1-5
automatic power off, 1-10
capacity, 10-3
indicator, 2-11
problems, 9-7

HDD/ODD/eSATA indicator, 2-11

HDMI, 2-4, 8-12
port, 1-7, 2-3

Headphone, 1-7
port, 2-1
problems, 9-13

Hibernation mode, 1-11
problems, 9-17
setting, 3-4

Hot keys, 1-10
brightness down, 5-4
brightness up, 5-4
hibernate, 5-4
lock, 5-3
output/display, 5-4
power plan, 5-3
sleep, 5-3
sound mute, 5-3
TOSHIBA zooming utility enlarge, 5-5
TOSHIBA zooming utility reduce, 5-5
touchpad, 5-4
wireless, 5-4
zoom, 5-4

HW Setup
accessing, 7-1
Boot Priority, 7-4
CPU, 7-4
display, 7-3
general, 7-2
illumination, 7-7
keyboard, 7-6
LAN, 7-7
password, 7-2
USB, 7-6
window, 7-1

- I**
- i.LINK (IEEE1394), 1-7
 - port, 2-3, 2-5
 - problems, 9-19
 - using, 8-14
 - illumination, See Indicator
 - Indicator
 - battery, 6-2
 - DC IN, 6-3
 - front edge logo, 2-2
 - Function button, 7-7
 - keyboard, 2-12
 - LAN, 4-35
 - optical disc drive, 2-13
 - power, 6-3
 - system, 2-9, 2-11
 - touchpad, 7-7
 - web camera, 2-9
 - wireless communication, 2-2, 4-33
 - Infrared receiver window, 1-8
 - port, 2-1
 - problems, 9-9
- K**
- Keyboard, 1-6, 5-1
 - emulating keys on enhanced, 5-2
 - FN sticky key, 5-5
 - function keys, 5-2
 - hot keys, 5-3
 - HW Setup, 7-6
 - indicator, 2-12
 - problems, 9-6
 - typewriter keys, 5-1
 - Windows special keys, 5-5
 - Keypad overlay, 1-10, 5-5
 - arrow mode, 5-6
 - indicator, 2-12
 - numeric mode, 5-6
 - temporarily changing modes, 5-7
 - temporarily using normal keyboard (overlay on), 5-6
 - temporarily using overlay (overlay off), 5-7
 - turning on the overlays, 5-6
- L**
- LAN, 1-8, 4-34
 - cable types, 4-34
 - connecting, 4-34
 - disconnecting, 4-35
 - indicator, 4-35
 - port, 2-3, 2-4
 - problems, 9-17
 - LCD, See Display
 - Lock, security, See Security lock
- M**
- Main battery, See Battery pack
 - Memory, 1-3, 10-2
 - expansion, 1-15, 8-7
 - installing module, 8-8
 - module cover, 2-7
 - removing module, 8-10
 - Microphone, 1-7
 - built-in, 2-8, 2-9
 - port, 2-1, 2-2
 - problems, 9-13
 - using, 4-25
 - Microprocessor, See Processor
 - Modem, 1-9, 4-29, A-2, C-1
 - connecting, 4-30
 - disconnecting, 4-31
 - jack location, 2-5
 - problems, 9-16
 - properties menu, 4-30
 - region selection, 4-29
 - Moving the computer, 4-36
 - Multiple digital media card
 - problems, 9-12
 - using, 8-5
- N**
- Numeric keypad, See Keypad overlay

O

- Optical disc drive, 2-6, 2-13
 - indicator, 2-11
 - location, 2-5
 - safety instructions, -xiv
 - using, 4-10

P

Password

- fingerprint sensor, 2-9
- fingerprint utility, 1-14
- power on, 1-10
- problems, 9-6
- starting the computer with, 6-13
- user, 7-2

Pointing device

- problems, 9-9
- touchpad, 4-1

Ports

- DC IN, 2-5
- eSATA/USB combo, 2-3
- external monitor, 2-3
- FM tuner, 2-5
- HDMI, 2-3
- headphone, 2-1
- i.LINK (IEEE1394), 2-3
- infrared receiver window, 2-1
- LAN, 2-3
- microphone, 2-1
- modem, 2-5
- USB, 2-3, 2-5
- video-out, 2-3

Power, 1-7

- button, 2-9
- button location, 2-8
- conditions, 6-1
- hibernation mode, 3-4
- indicator, 2-11, 6-3
- power-up modes, 6-13
- problems, 9-4
- settings, 1-10, 5-3
- shut down mode (boot mode), 3-4
- sleep mode, 3-6
- turning off, 3-4
- turning on, 3-3

Problems

- AC power, 9-5
- analyzing the problem, 9-2
- battery, 9-5
- Bluetooth, 9-18
- diskette drive, 9-9
- DVD Super Multi (+-R DL) drive, 9-8
- eSATA/USB combo port, 9-15
- ExpressCard, 9-12
- external monitor, 9-12
- fingerprint sensor, 9-11
- FM tuner, 9-19
- hard disk drive, 9-7
- hardware and system checklist, 9-3
- i.LINK (IEEE1394) device, 9-19
- infrared port, 9-9
- keyboard, 9-6
- LAN, 9-17
- LCD panel, 9-7
- modem, 9-16
- overheating power down, 9-4
- password, 9-6
- pointing device, 9-9
- power, 9-4
- recovery discs, 9-19
- SD/SDHC/MS/MS Pro/MMC/xD card, 9-12
- self test, 9-4
- sleep/hibernation, 9-17
- sound system, 9-13
- system start-up, 9-3
- TOSHIBA support, 9-20
- touchpad, 9-9
- TV output signal, 9-13
- USB, 9-14
- USB mouse, 9-10
- USB Sleep and Charge, 9-14
- Wireless LAN, 9-18

Processor, 1-3

R

- Real Time Clock battery, See Battery
- Recovery media, 3-9
 - problems, 9-19

- Remote controller, 2-14
 - battery, 2-22
 - placing, 2-26
 - using, 2-20
- Restarting the computer, 3-7

S

- Security lock
 - attaching, 8-15
 - location, 2-5
- Shut down mode (boot mode), 3-4
- Sleep mode, 1-11
 - problems, 9-17
 - setting, 3-6
- Soft keys
 - emulating keys on enhanced keyboard, 5-2
 - ENTER, 5-3
 - right ALT key, 5-3
 - right CTRL key, 5-3
 - scroll lock, 5-3
- Sound system, 1-8
 - headphone, 1-7, 2-2
 - microphone, 2-2, 2-9
 - speaker, 2-8
 - volume control, 2-2

T

- TOSHIBA Accessibility, 1-12
- TOSHIBA Assist, 1-13
- TOSHIBA Bluetooth Stack, 1-14
- TOSHIBA ConfigFree, 1-13
- TOSHIBA Disc Creator, 1-13, 4-18
- TOSHIBA DVD-RAM utility, 1-13
- TOSHIBA Face Recognition, 1-14
 - using, 4-25
- Toshiba HW setup, 7-1
- TOSHIBA PC Diagnostic Tool, 1-12
- TOSHIBA support, 9-20
- TOSHIBA web site, 10-3
- TOSHIBA zooming utility, 1-12
- Touchpad, 2-9
 - control buttons, 2-9
 - problems, 9-9
 - using, 4-1
- TV, 8-12
 - problems, 9-13

U

- USB, 1-7
 - location, 2-3, 2-5
 - problems, 9-14
 - Sleep and Charge, 4-9
- USB mouse
 - problems, 9-10

V

- Video, 4-20
 - HDMI, 8-13
- Video RAM, 1-4
- Video-out port, 1-7, 2-3
 - location, 2-3
- Volume control, 2-2
 - location, 2-1

W

- Web camera, 1-8, 2-9
 - location, 2-8
 - using, 4-23
- WiMAX
 - switch, 1-9
- Wireless LAN, 1-8, 10-4
 - indicator, 4-33
 - problems, 9-18
 - switch, 1-9, 2-1
 - using, 4-32

Free Manuals Download Website

<http://myh66.com>

<http://usermanuals.us>

<http://www.somanuals.com>

<http://www.4manuals.cc>

<http://www.manual-lib.com>

<http://www.404manual.com>

<http://www.luxmanual.com>

<http://aubethermostatmanual.com>

Golf course search by state

<http://golfingnear.com>

Email search by domain

<http://emailbydomain.com>

Auto manuals search

<http://auto.somanuals.com>

TV manuals search

<http://tv.somanuals.com>