

TOSHIBA

Leading Innovation >>>

UNINTERRUPTIBLE POWER SYSTEM (UPS)

4300 SERIES Ancillary Cabinets

- 431A - TOSHIBA AUXILIARY CABINET
- 431B - TOSHIBA BATTERY CABINET
- 431M - MAINTENANCE BYPASS SWITCH

INSTALLATION AND OPERATION MANUAL

THREE PHASE - 30-50 KVA



Part # 64525-002
February 2012

Manufactured in the USA

© Copyright 2012 TOSHIBA International Corporation
All rights reserved.



4300 SERIES

Ancillary Cabinets

- 431A - TOSHIBA AUXILIARY CABINET
- 431B - TOSHIBA BATTERY CABINET
- 431M - MAINTENANCE BYPASS SWITCH

INSTALLATION AND OPERATION MANUAL

THREE PHASE - 30/50 KVA

Part # 64525-002
February 2012



Product Use and Warranty Restrictions

The Toshiba products listed in this document are intended for usage in general electronics applications (computer, personal equipment, office equipment, measuring equipment, industrial robotics, domestic appliances, etc.). These Toshiba products are neither intended nor warranted for usage in equipment that requires extraordinarily high quality and/or reliability or where a malfunction or failure may cause loss of human life or bodily injury (Unintended Usage). Unintended Usage includes atomic energy control instruments, airplane or spaceship instruments, transportation instruments, traffic signal instruments, combustion control instruments, surgical operating room or life-support equipment, all types of safety devices, etc. Unintended Usage of Toshiba products listed in this document shall be made at the customer's own risk.

NOTICE

PLEASE INFORM TOSHIBA INTERNATIONAL CORPORATION OR AUTHORIZED REPRESENTATIVE IN CASE OF INCONSISTENCIES, OMISSIONS, OR QUESTIONS.

The instructions contained in this manual are not intended to cover all of the details or variations in equipment, or to provide for every possible contingency concerning installation, operation, or maintenance. Should further information be required or if problems arise which are not covered sufficiently, contact your Toshiba sales office.

The contents of this instruction manual shall not become a part of or modify any prior or existing agreement, commitment, or relationship. The sales contract contains the entire obligation of Toshiba International Corporation UPS Division. The warranty contained in the contract between the parties is the sole warranty of Toshiba International Corporation UPS Division and any statements contained herein DO NOT create new warranties or modify the existing warranty.

Any electrical or mechanical modifications to this equipment without prior written consent of Toshiba International Corporation will void all warranties and may void the UL/CUL listing. Unauthorized modifications can also result in personal injury, loss of life, or destruction of the equipment.

QUALIFIED PERSONNEL ONLY

Qualified Personnel are those who have the skills and knowledge relating to the construction, installation, operation, and maintenance of the electrical equipment and have received safety training on the hazards involved (Refer to the latest edition of NFPA 70E for additional safety requirements).

UNINTERRUPTIBLE POWER SYSTEM (UPS)

Please complete the following information and retain for your records.

Unless otherwise specified, the warranty period for the UPS or UPS part is 36 months from the shipment date (see Toshiba International Corporation bill of lading).

Unless otherwise specified, the warranty period for a UPS battery is 24 months from the shipment date (see Toshiba International Corporation bill of lading).

JOB NUMBER _____

MODEL NUMBER _____

SERIAL NUMBER _____

APPLICATION _____

SHIPMENT DATE _____

INSTALLATION DATE _____

INSPECTED BY _____

Purpose

This manual provides information on how to safely install your Toshiba International Corporation power electronics product. This manual includes a section of general safety instructions that describes the warning labels and symbols that are used throughout the manual. Read the manual completely before installing, operating, or performing maintenance on this equipment.

This manual and the accompanying drawings should be considered a permanent part of the equipment and should be readily available for reference and review. Dimensions shown in the manual are in metric and/or the English customary equivalent.

Toshiba International Corporation reserves the right, without prior notice, to update information, make product changes, or discontinue any product or service identified in this publication.

Toshiba is a registered trademark of the Toshiba Corporation. All other product or trade references appearing in this manual are registered trademarks of their respective owners.

Toshiba International Corporation shall not be liable for direct, indirect, special, or consequential damages resulting from the use of the information contained within this manual.

This manual is copyrighted. No part of this manual may be photocopied or reproduced in any form without the prior written consent of Toshiba International Corporation.

© Copyright 2011 Toshiba International Corporation
All rights reserved.
Printed in the U.S.A.

Toshiba Customer Support Center

Contact the Toshiba Customer Support Center for assistance with application information or for any problems that you may experience with your Uninterruptible Power System (UPS).

Toshiba Customer Support Center
8 a.m. to 5 p.m. (CST) - Monday through Friday
USA Toll Free (877) 867-8773
Tel (713) 466-0277
Fax (713) 466-8773

You may also contact Toshiba by writing to:

Toshiba International Corporation
13131 West Little York Road
Houston, Texas 77041-9990
Attn: UPS Product Manager

For further information on Toshiba products and services, please visit our website at:

www.toshiba.com/ind

Contents

1	Introduction	1
2	General Safety Instructions	2
2.1	Symbols.....	2
2.2	Signal Words.....	3
2.3	Qualified Personnel.....	3
2.4	Factory Authorized Personnel.....	4
3	Important Safety Instructions	4
3.1	Maximum Operating Temperatures.....	4
3.1	Battery Safety.....	5
4	Safety Precautions	6
4.1	Disclaimer.....	6
4.2	General Maintenance.....	6
4.3	Transporting.....	7
4.4	Transporting By Forklift.....	8
4.5	Inspection/Storage.....	9
5	Installation Precautions	10
5.1	Wiring/Connection.....	12
6	Warning Labels	13
7	Storage/Operating Environment	14
7.1	Storage Environment.....	14
7.2	Operating Precautions.....	14
7.3	Maintenance Precautions.....	16
8	Installation	17
8.1	Unpacking.....	18
8.2	UPS Clearance.....	18
8.3	Anchor Bolts.....	19
8.4	Grounding Wire.....	20
9	4300 Series Overview	21
10	431A - Toshiba Auxiliary Cabinet	23
10.1	4300 Auxiliary Cabinet Transformer Options.....	23
10.2	Alternative Configurations.....	24
10.3	EQUIPMENT WARNING LABELS.....	24
10.9	INSTALLATION INSTRUCTIONS.....	25
10.5	Anchor the 431A Cabinet.....	27
10.6	Join the Auxiliary Cabinet with the UPS.....	28
10.7	Join the 431A Cabinet with the 431M.....	29

11	431B - Toshiba Battery Cabinet	31
11.1	431B Estimated Runtimes	31
11.2	EQUIPMENT WARNING LABELS.....	32
11.3	INSTALLATION INSTRUCTIONS.....	33
11.4	Place the 431B Cabinet.....	34
11.5	Join the Battery Cabinet with the UPS	35
11.6	Wire the Battery Cabinet to the UPS	36
11.7	431B Backup Runtime Tables	37
12	431M - MBS Cabinet Installation Guide	39
12.1	431M Maintenance Bypass Switch (MBS) Options	39
12.2	EQUIPMENT WARNING LABELS.....	41
12.3	IMPORTANT SAFETY INSTRUCTIONS.....	42
12.4	INSTALLATION INSTRUCTIONS.....	43
12.5	Place the 431M Cabinet	45
12.6	Join the 431M Cabinet with the UPS	46
12.7	Join the 431A Cabinet with the 431M	47
12.8	MBS Operation	48
13	Optional Kickplate Installation	50
14	External Layouts/Dimensions	54

1 Introduction

This manual provides information on how to safely install and operate your 4300 Series accessory cabinets. This manual includes a section of general safety instructions that describes the warning labels and symbols that are used throughout the manual. Read the manual completely before installing, operating, or performing maintenance on this equipment.

Qualified personnel should read this manual carefully before transporting, installing, and wiring the UPS Ancillary Cabinets. In addition they have a thorough understanding of the information provided in the chapters titled:

- General Safety Instructions
- Important Safety Instructions
- Safety Precautions
- Installation Precautions

Please read the 4300 Series Operation Manual for important instructions on operating the UPS. This manual and the accompanying drawings should be considered a permanent part of the equipment and should be readily available for reference and review. Dimensions shown in the manual are in metric and/or the English customary equivalent.

Keep the Installation Manual and the Operation Manual near the UPS for necessary reference.

SAVE THESE INSTRUCTIONS

2 General Safety Instructions

DO NOT attempt to transport, install, operate, maintain or dispose of this equipment until you have read and understood all of the product safety information provided in this manual.

2.1 Symbols

The symbols listed below are used throughout this manual. When symbols are used in this manual they will include important safety information that must be carefully followed.



Safety Alert Symbol indicates that a potential personal injury hazard exists.



Prohibited Symbol indicates **DO NOT** take action.



Mandatory Symbol indicates that the following instruction is required.



Ground Symbol indicates the location of the equipment grounding conductor.



Electrical - Voltage & Shock Hazard Symbol indicates parts inside may cause electric shock.



Explosion Hazard Symbol indicates parts may explode.

2.2 Signal Words

The signal words listed below are used throughout this manual. When the words DANGER, WARNING, CAUTION and ATTENTION are used in this manual they will include important safety information that must be carefully followed.



The word **DANGER** in capital letters preceded by the safety alert symbol indicates that an **imminently hazardous** situation exists, and if not avoided **will result in loss of life or serious injury to personnel.**



The word **WARNING** in capital letters preceded by the safety alert symbol indicates that a **potentially hazardous** situation exists, and if not avoided **may result in loss of life or serious injury to personnel.**



The word **CAUTION** in capital letters preceded by the safety alert symbol indicates that a **potentially hazardous** situation exists, and if not avoided **may result in minor or moderate injury.**



The word **NOTICE** in capital letters without the safety alert symbol indicates a **potentially hazardous** situation exists, and if not avoided **may result in equipment and property damage.**

2.3 Qualified Personnel

Installation, operation, and maintenance shall be performed by Qualified Personnel Only. A Qualified Person is one who has the skills and knowledge relating to the construction, installation, operation, and maintenance of the electrical equipment and has received safety training on the hazards involved (Refer to the latest edition of NFPA 70E for additional safety requirements).

Qualified Personnel shall:

- Have read the entire operation manual.
- Be familiar with the construction and function of the UPS, the equipment being driven, and the hazards involved.
- Be trained and authorized to safely energize, de-energize, ground, lockout/tagout circuits and equipment, and clear faults in accordance with established safety practices.
- Be trained in the proper care and use of protective equipment such as safety shoes, rubber gloves, hard hats, safety glasses, face shields, flash clothing, etc., in accordance with established safety practices.
- Be trained in rendering first aid.

For further information on workplace safety visit www.osha.gov.

2.4 Factory Authorized Personnel

Factory authorized personnel have been factory trained and certified to install, service, and repair the UPS. Contact the Toshiba Customer Support Center for assistance in locating the factory authorized personnel nearest you.

3 Important Safety Instructions

3.1 Maximum Operating Temperatures

The following contains important instructions that should be followed during the installation, operation, and maintenance of the 4300 Series UPS Ancillary cabinets.

 **CAUTION**

Misuse of this equipment could result in personal injury and/or equipment damage. In no event will Toshiba Corporation be responsible or liable for either indirect or consequential damage or injury that may come from the use of this equipment.

The maximum operating ambient temperature for the 4300 Series Ancillary Cabinets are as follows:

- 431A (Auxiliary Cabinet) – 104 °F (40 °C).
- 431B (Battery Cabinet) – 90 °F (32 °C).
- 431M (MBS Cabinet) – 104 °F (40 °C).

If the 4300 System is exposed to the same ambient temperature as the DC backup supply (431M or other), the maximum operating ambient temperature is:

- DC backup: 90 °F (32 °C). Table 3.2 lists the nominal battery voltage.

TABLE 3.2 UPS NOMINAL BATTERY VOLTAGE

CAPACITY	NOMINAL VOLTAGE	FLOAT VOLTAGE
30 kVA	288 Vdc	324 V
50 kVA	288 Vdc	324 V

3.1 Battery Safety

The following contains important instructions that should be followed during the installation, operation, and maintenance of the 4300 Series UPS Ancillary cabinets.



A battery can present a risk of electrical shock and high short circuit current.

To be performed by **Qualified Personnel** only.

1. Verify that the UPS is off and that the power is disconnected from the power source.
2. Remove watches, ring, jewelry, or other metal objects.
3. Use tools with insulated handles to prevent inadvertent shorts.
4. Wear rubber gloves and boots.
5. Do not place tools or any metal parts on top of batteries.
6. Determine if the battery is inadvertently grounded. If inadvertently grounded, remove source of ground.

Contact with any part of a grounded battery can result in electrical shock.

The likelihood of shock will be reduced if such grounds are removed prior to installation or maintenance.

INSTRUCTIONS IMPORTANTES CONCERNANT LA SÉCURITÉ

CONSERVER CES INSTRUCTIONS Cette notice contient des instructions importantes concernant la sécurité



ATTENTION

Un battery puet présenter un risque de choc électrique, de brûlure par transfert d' énergie.



ATTENTION

L'élimination des batteries est règlementée. Consulter les codes locaux à cet effet

4 Safety Precautions

The Toshiba products listed in this document are intended for usage in general electronics applications (computer, personal equipment, office equipment, measuring equipment, industrial robotics, domestic appliances, etc.). These Toshiba products are neither intended nor warranted for use in equipment that, if a malfunction or failure occurs, may result in loss of human life or bodily injury (collectively referred to as “Unintended Usage”). Unintended Usage includes atomic energy control instruments, airplane or spaceship instruments, transportation instruments, traffic signal instruments, combustion control instruments, medical operating room or life support equipment, all types of safety devices, etc. Unintended Usage of Toshiba products listed in this document shall be made at the customer’s own risk.



The application of the UPS without special consideration for equipment that supports human safety and/or maintain public services may cause serious accidents.

4.1 Disclaimer









IN NO EVENT WILL TOSHIBA CORPORATION BE RESPONSIBLE OR LIABLE FOR EITHER INDIRECT OR CONSEQUENTIAL DAMAGE OR INJURY THAT MAY COME FROM THE MISUSE OF THIS EQUIPMENT. ANY MODIFICATIONS WITHOUT AUTHORIZATION BY TOSHIBA COULD RESULT IN PERSONAL INJURIES, DEATH OR DESTRUCTION OF THE UPS.

TOSHIBA RESERVES THE RIGHT TO MAKE CHANGES WITHOUT FURTHER NOTICE TO ANY PRODUCTS HEREIN TO IMPROVE RELIABILITY, FUNCTION OR DESIGN. TOSHIBA DOES NOT ASSUME ANY LIABILITY ARISING OUT OF THE APPLICATION OR USE OF ANY PRODUCT OR UPS DESCRIBED HEREIN; NEITHER DOES IT CONVEY ANY LICENSE UNDER ITS PATENT RIGHTS, NOR THE RIGHTS OF OTHERS.

4.2 General Maintenance

 WARNING	
	<p>DO NOT remove the rear/side panels, or any sheet metal not designed to be removed.</p> <p>Removing rear/side panels may result in electric shock, burns, personal injuries or UPS failure.</p>
	<p>Keep the area around the UPS clean.</p> <p>Use a non-metal vacuum cleaner to clean the UPS.</p>
	<p>Only factory authorized personnel should perform internal general maintenance on the UPS and ancillary cabinets.</p>
	<p>Contact the authorized Toshiba Customer Support Center or an authorized Toshiba representative for information on proper disposal of UPS and ancillary cabinet components.</p> <p>It is illegal to dispose of certain components without conforming to environmental regulations for industrial/commercial waste.</p>

4.3 Transporting

 WARNING	
	<p>DO NOT tilt the ancillary cabinet more than 10° from upright position.</p> <p>Tilting the ancillary cabinet more than 10° may cause crushing, trapping or other personal injuries.</p>
 CAUTION	
	<p>DO NOT transport, move, store, or place the ancillary cabinet on its sides.</p> <p>Excessive force applied from heavy components inside may damage the ancillary cabinet.</p>
	<p>Avoid vibration or shock exceeding 0.5 g.</p> <p>Failing to observe this precaution may cause damage to the ancillary cabinet.</p>
	<p>DO NOT allow the ancillary cabinet to suffer shock or impact when unpacking.</p> <p>Tools used to remove packaging materials may cause damage to the ancillary cabinet.</p>
	<p>DO NOT install the ancillary cabinet where water may fall on it.</p> <p>Water may cause electrical shock, personal injury or ancillary cabinet failure.</p>
	<p>DO NOT push or pull on the sides of the packaging or the ancillary cabinet to move it. Always use a crane, forklift, or pallet jack for transporting and positioning the ancillary cabinet.</p> <p>Pushing/pulling on the sides of the unit to move it may result in damage to the ancillary cabinet.</p>

The ancillary cabinet may be packed in a crate for extra protection during transportation. Avoid impact or vibration against the ancillary cabinet during transportation. DO NOT expose the ancillary cabinet directly to water.

4.4 Transporting By Forklift

Refer to Chapter 7 - Weights and Dimensions.

Verify forklift maximum load capacity and ensure that the forks are long enough to properly support the UPS. Insert the forks into the space shown in Figure 4.1. Spaces for the forks are provided underneath the ancillary cabinet. All ancillary cabinets have the same dimensions for forklift access.

DO NOT tilt UPS when lifting and/or transporting. Minimize the impact when lowering the ancillary cabinet to the floor.

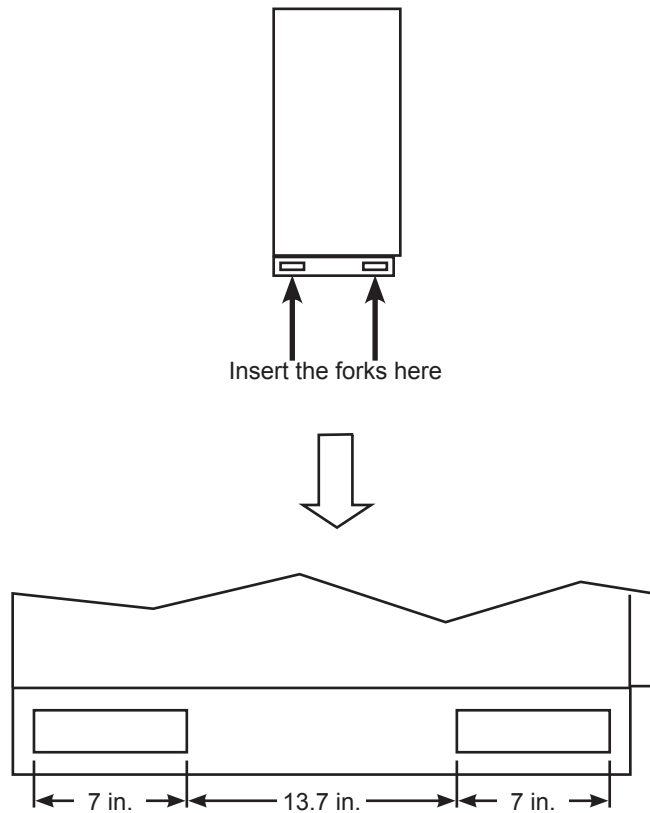

431A/B/M Ancillary Cabinet: Side View - Fork Access Dimensions in Channel Base

Figure 4.1 - Transporting by Forklift

4.5 Inspection/Storage

Inspection

Upon receipt of the ancillary cabinet, an inspection for shipping damage should be performed. Use caution when removing the unit from the pallet. Refer to labels or documentation attached to packing material.

Unpacking

Check the unit for loose, broken, bent or otherwise damaged parts. If damage has occurred during shipping, keep all original crating and packing materials for return to the shipping agent.

NOTE: The factory warranty does not apply to damage incurred during shipping!

Ensure that the rated capacity and the model number specified on the nameplate conform to the order specifications.

Storage

During periods of non-use, the following guidelines are recommended for storage.

Storage Preparation

- 1) The 431B battery cabinet should be charged for 24 hours to fully charge the batteries.
- 2) Stop the battery charger.
- 3) Place both 431B Main Circuit Breaker switches in the "OFF" position.







Storage Conditions

- For best results, store the ancillary cabinet in the original shipping container and place on a wood or metal pallet
- Storage temperature range: 32 to 104 °F (0 to 40 °C)
- The optimum storage temperature is 70 °F (21 °C). A higher ambient temperature will require recharging batteries more frequently during storage

Avoid the following storage locations:

- Locations that are subject to extreme temperature changes or high humidity
- Locations that are subject to high levels of dust or metal particles
- Locations that are subject to excessive vibration
- Inclined floor surfaces

5 Installation Precautions





 CAUTION	
	<p>Install the ancillary cabinet in a controlled environment. Improper storage and installation environment may deteriorate insulation, shorten component life and cause malfunctions. <i>See Table 5.1 - UPS Installation Environment Standards</i></p>
	<p>DO NOT tilt the ancillary cabinet more than 10° from upright position. Tilting the ancillary cabinet more than 10° may cause crushing, trapping or other personal injuries and cause physical damage to internal components.</p>
 WARNING	
	<p>Keep the SPECIFIED CLEARANCE around the UPS. Inadequate space around the UPS makes it difficult to perform maintenance/inspections, will lead to insufficient ventilation, and/or cause malfunctions.</p>
	<p>Install anchor bolts to secure the UPS to the installation floor. The UPS may fall during an earthquake if the anchor bolts are not installed and secured.</p>
	<p>Only factory authorized personnel should relocate, modify, or replace parts in the ancillary cabinet after initial installation. Electrical shock, injury or ancillary cabinet failure may occur if non-authorized technicians attempt to modify or relocate the UPS. Please contact Toshiba Customer Support Center if you plan to move or make modifications to the UPS</p>

 WARNING	
	METAL CONDUIT IS NOT AN ACCEPTABLE GROUND.

Conductor Routing and Grounding

- 1) Use separate metal conduits for routing the input power, output power, and control circuits.
- 2) Follow the wire size and tightening torque specifications.
- 3) Always ground the unit to reduce the potential for electrical shock and to help reduce electrical noise.
- 4) A separate ground cable should be run inside the conduit with the input power, output power, and control circuits.

5.1 Wiring/Connection

 WARNING	
	<p>Perform wiring and connections with correct polarity.</p> <p>Be careful when connecting the UPS to the DC backup system. A wrong connection may cause damage to the UPS, DC backup system, or charger.</p>
	<p>Connect ONLY one (1) ground wire to the earth ground terminal.</p> <p>A missing ground wire may cause an electrical shock hazard. Connecting to more than one ground may cause a ground loop.</p> <p><i>See Chapter 9 - UPS Wiring</i></p>
	<p>DO NOT force, bend, or pull wires.</p> <p>DO NOT damage wire insulation.</p> <p>DO NOT place heavy objects on top of UPS.</p>
	<p>Observe the above precautions when making wire connections or handling the wires. Failing to observe these precautions may damage the insulation of the wires or may cause a fire or an electric shock hazard.</p>
NOTICE	
<p>Follow the torque criteria for tightening screws.</p> <p>Loose connections may cause fire due to heating.</p> <p><i>See Chapter 9 - UPS Wiring</i></p>	

6 Warning Labels

Each ancillary cabinet section shows representative warning labels for that unit. See Sections 9.-3, 10-2, and 11-2.

NOTICE

Make sure all the warning labels are installed in the appropriate locations.

If a label is missing or illegible, contact Toshiba Customer Support Center or an authorized representative.

7 Storage/Operating Environment

7.1 Storage Environment

Observe the following when storing the ancillary cabinets.

- Store ancillary cabinet indoors.
- Temperature fluctuations should be minimized.
- The optimal storage temperature range is 68 – 77 °F (20 – 25° C).
- A maximum temperature range of 32 – 104 °F (0 – 40 °C) should be observed.
- The optimal relative humidity at the storage location should be between 50 – 60%.
- Humidity must not exceed 90%.
- Avoid locations where ancillary cabinet may be exposed to corrosive gas.
- Avoid locations with dirt and/or dust.

TABLE 7.1 - UPS STORAGE/OPERATING ENVIRONMENT STANDARDS

Item	Environment standard	
Storage Location	Indoors	
Ambient Temperature	Minimum storage temperature: 32 °F (0 °C)	
	Maximum storage temperature: 104 °F (40 °C)	
Relative Humidity	The relative humidity must be between 30 and 90% and without condensation due to temperature changes.	
Altitude	This equipment is rated for installations up to 3240 ft. (1000 m) above sea level. Consult with the factory to determine the derating factor for installations above 3240 ft. (1000 m).	
Dust	Dust must not exceed normal atmospheric levels and must not include conductive/corrosive particles, silicone or oils.	
Flammable Gas	No flammable and/or explosive gas.	
	Hydrogen sulfide (H ₂ S)	Less than or equal to 0.0001 PPM
	Sulfurous acid gas (SO ₂)	Less than or equal to 0.05 PPM
	Chlorine gas (Cl ₂)	Less than or equal to 0.002 PPM
	Ammonia gas (NH ₃)	Less than or equal to 0.1 PPM
	Nitrous acid gas (NO ₂)	Less than or equal to 0.02 PPM
	Nitrous oxides (NO _x)	Less than or equal to 0.02 PPM
	Ozone (O ₃)	Less than or equal to 0.002 PPM
	Hydrochloric acid mist (HCl)	Less than or equal to 0.1 mg/m ³

7.2 Operating Precautions

Initial startup/commissioning of the ancillary cabinet should be performed by factory authorized personnel.

- 1) The ancillary cabinet should not be powered up until the entire operation manual has been read. Follow Lockout/Tag Out procedures.

- 2) The voltage of the input power source must be within the rated input voltage range. The input frequency range must be within the rated input frequency range.
- 3) The ancillary cabinet should not be used with a load that has a rated input that is greater than the rated output of the UPS.
- 4) If using the ancillary cabinet to provide power to motors that require high starting current or with motors that require a long starting time, call Toshiba support for guidance in oversizing the UPS for locked-rotor current.
- 5) DO NOT insert metal objects or combustible materials in the ventilation slots of the ancillary cabinet.
- 6) DO NOT place, hang, or paste any objects on the exterior surfaces of the ancillary cabinet.
- 7) DO NOT attempt to disassemble, modify, or repair the ancillary cabinet. Call your Toshiba sales representative for repair information.
- 8) Turn the power on only after installing **ALL** of the covers.
- 9) DO NOT remove any covers of the ancillary cabinet when power is on.
- 10) If the ancillary cabinet should emit smoke or an unusual odor or sound, turn the power off immediately.
- 11) Additional warnings and notifications shall be posted at the equipment installation location as deemed required by **Qualified Personnel**.

7.3 Maintenance Precautions

All internal maintenance should be performed by factory authorized personnel.

- 1) Turn off, lockout, and tagout ALL power sources before connecting the power wiring to the equipment or when performing maintenance.
- 2) Hard-wire type UPS units are not equipped with an over-current protection device, nor do they have an output disconnect for the AC output. A user-installed circuit breaker should be provided between the UPS output and the load input.
- 3) The maximum ambient operating temperature is 90 °F (32 °C) for 4300 systems having the Battery Cabinet, and 104 °F (40 °C) for 4300 systems without
- 4) Only factory authorized personnel should service the UPS. Contact Toshiba for the nearest authorized service center.
- 5) Battery servicing should be performed by factory authorized personnel only.

Note: Contact your nearest factory authorized service center for battery replacement.

Qualified Personnel ONLY!

Qualified Personnel have the skills and knowledge relating to the construction, installation, operation, and maintenance of the electrical equipment and has received safety training on the hazards involved (Refer to the latest edition of NFPA 70E for additional safety requirements).







Qualified Personnel shall:

- 1) Have read the entire operation manual.
- 2) Be trained and authorized to safely energize, de-energize, ground, lockout and tag circuits and equipment, and clear faults in accordance with established safety practices.
- 3) Be trained in the proper use and care of protective equipment such as safety shoes, rubber gloves, hard hats, safety glasses, face shields, flash clothing, etc., in accordance with established safety practices.
- 4) Be trained in rendering first aid.
- 5) Be knowledgeable of the DC backup supply system and the required handling and maintenance precautions.

For further information on workplace safety visit www.osha.gov.

 WARNING	
	<p>Misuse of equipment could result in injury and equipment damage.</p> <p>In no event will Toshiba Corporation be responsible or liable for either indirect or consequential damage or injury that may result from the misuse of this equipment.</p>

8 Installation

 WARNING	
	<p>Keep the SPECIFIED CLEARANCE around the ancillary cabinets. Inadequate space around the UPS makes it difficult to perform maintenance/inspections, lead to insufficient ventilation, and/or will cause malfunctions. <i>See Figure 10.1 - UPS Clearance</i></p>
	<p>DO NOT tilt the ancillary cabinet more than 10° from upright position. Tilting the UPS more than 10° may cause crushing, trapping or other personal injuries.</p>
	<p>Install anchor bolts to secure the ancillary cabinet to the installation floor. The UPS may fall during an earthquake if the anchor bolts are not installed and secured.</p>
	<p>DO NOT transport, move, store, or place the ancillary cabinet on its side. Forces due to heavy components inside may damage the UPS.</p>
	<p>DO NOT allow the UPS to suffer shock or impact when unpacking. Tools used to remove packaging materials may cause damage to the UPS.</p>
	<p>DO NOT push or pull on the sides of the packaging, or the UPS to move it. Always use a crane, forklift, or pallet jack for transporting and positioning the UPS. Pushing/pulling on the sides of the unit to move it may result in damage to the UPS. See Figure 4.1 Exterior Handling label.</p>

8.1 Unpacking

Unpack the UPS indoors on a paved floor. The UPS should be as close as possible to its final storage location. Allow enough space for forklift operations to unpack the UPS crate. Then remove the crate.

Points to observe

- Retain all small articles during unpacking and installation.
- Make sure that exterior paint is not scratched and that the UPS cabinet is not damaged.
- DO NOT damage the UPS when using tools to remove packaging materials.
- If provided, DO NOT remove the plastic sheet cover, until installation.
- Do not remove the fan covers until UPS start up. The fan covers should be removed by factory authorized personnel. Packing materials should be disposed by the appropriate means.
- Immediately report any abnormalities to Toshiba Customer Support Center or an authorized representative.

8.2 UPS Clearance

Maintain the indicated clearance during installation. See Figure 8.1. Ensure that the front and top air vents are NOT blocked.

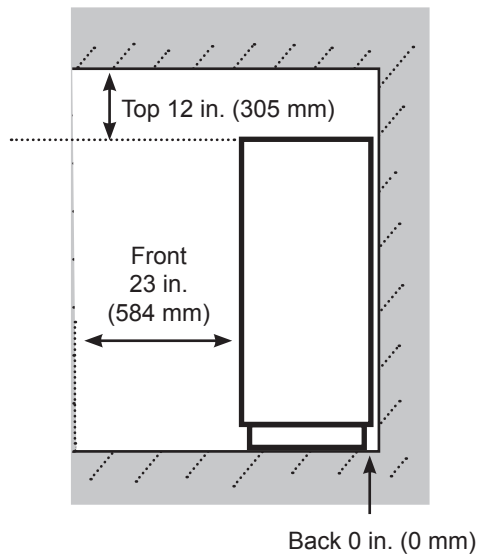

FIGURE 8.1 - UPS CLEARANCE

8.3 Anchor Bolts

Install the anchor bolts to secure the UPS on the floor. See Figure 8.2 for anchor bolt installation detail. Use 1/2" (12 mm) diameter anchor bolts. There are four 0.63" (16 mm) diameter holes provided in the cabinet base. See Figure 8.3A for the hole locations and dimensions for the specified Ancillary Cabinets..

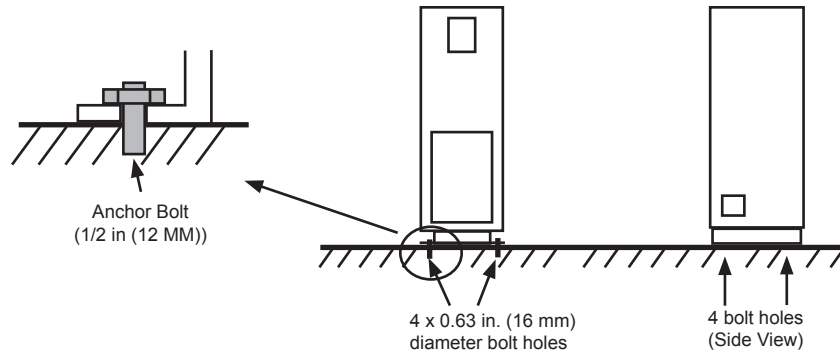

FIGURE 8.2 ANCHOR BOLT INSTALLATION DETAIL

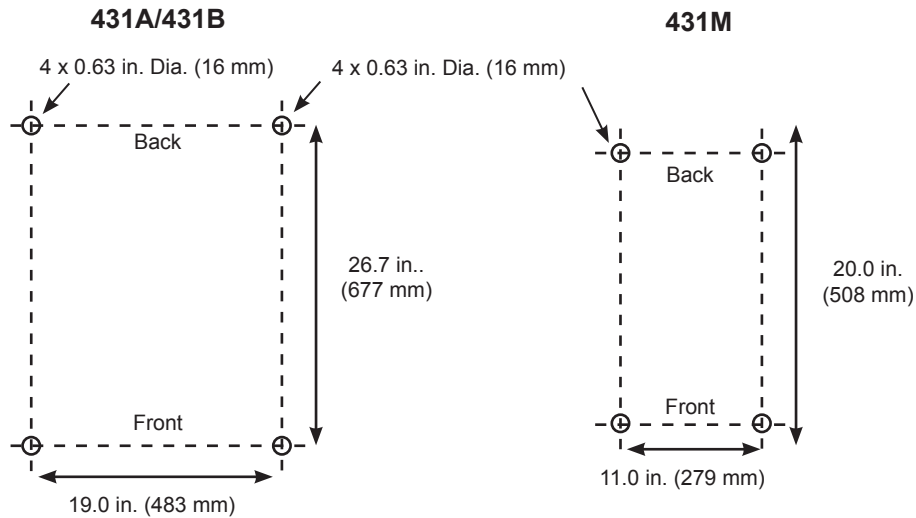

FIGURE 8.3A HOLE LOCATIONS/DIMENSIONS ON BOTTOM OF CABINETS

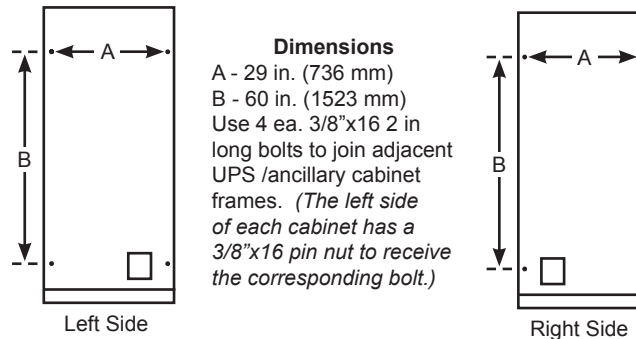



FIGURE 8.3B HOLE LOCATIONS/DIMENSIONS ON SIDES OF CABINETS

8.4 Grounding Wire

 WARNING	
	<p>Be sure to ground the UPS and ancillary cabinets as specified.</p> <p>Using the UPS and ancillary cabinets without a proper ground will deteriorate the insulation, cause leakage of currents and electric shock. The resistance to ground should be 10 ohms or less.</p>

The earth grounding bus for 431A and 431B are located inside, at the bottom-left front of each cabinet.

The earth grounding bus for 431M is located on the right side wall just above the inter-cabinet access port.

Use a AWG 2 (or 38 mm²) or larger cable for the grounding wire. Run the grounding wire through the opening at the bottom, through a hole in the top knockout plate or through the side access hole. Connect the grounding wire to the earth ground bus.

The ground wire must have a crimp terminal with a 3/16 in. (4.76 mm) diameter screw hole. The ground bus has twelve (12) 0.163 in. (4.1 mm) holes tapped for a 10/32 screw. Connect the crimp terminal and ground bus together using a 10/32 screw.

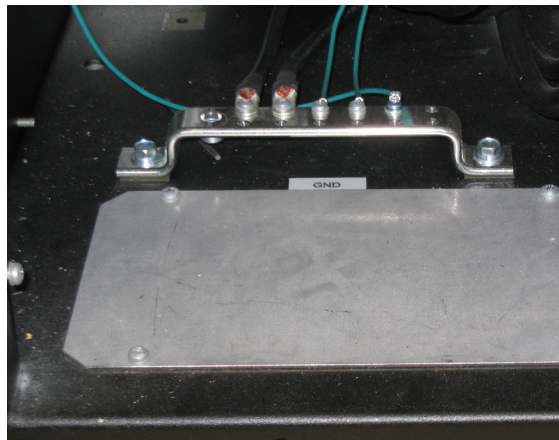

Figure 8-4 - Example: UPS Ground Bus

9 4300 Series Overview

The 4300 Series UPS and ancillary cabinets have been specifically designed for line-up-and-match installations. The optional Transformer/Switching Cabinet, Battery Cabinet, and MBS Cabinet have been designed with a pleasing aesthetic look in IT black, while occupying a minimal footprint for the delivered capacity and capability.

The ancillary units should be installed in the relative order shown below..



Figure 9-1 - 4300 Series System Assembly

The electrical connections between the 4300 Series system components is show in Figure 9-2

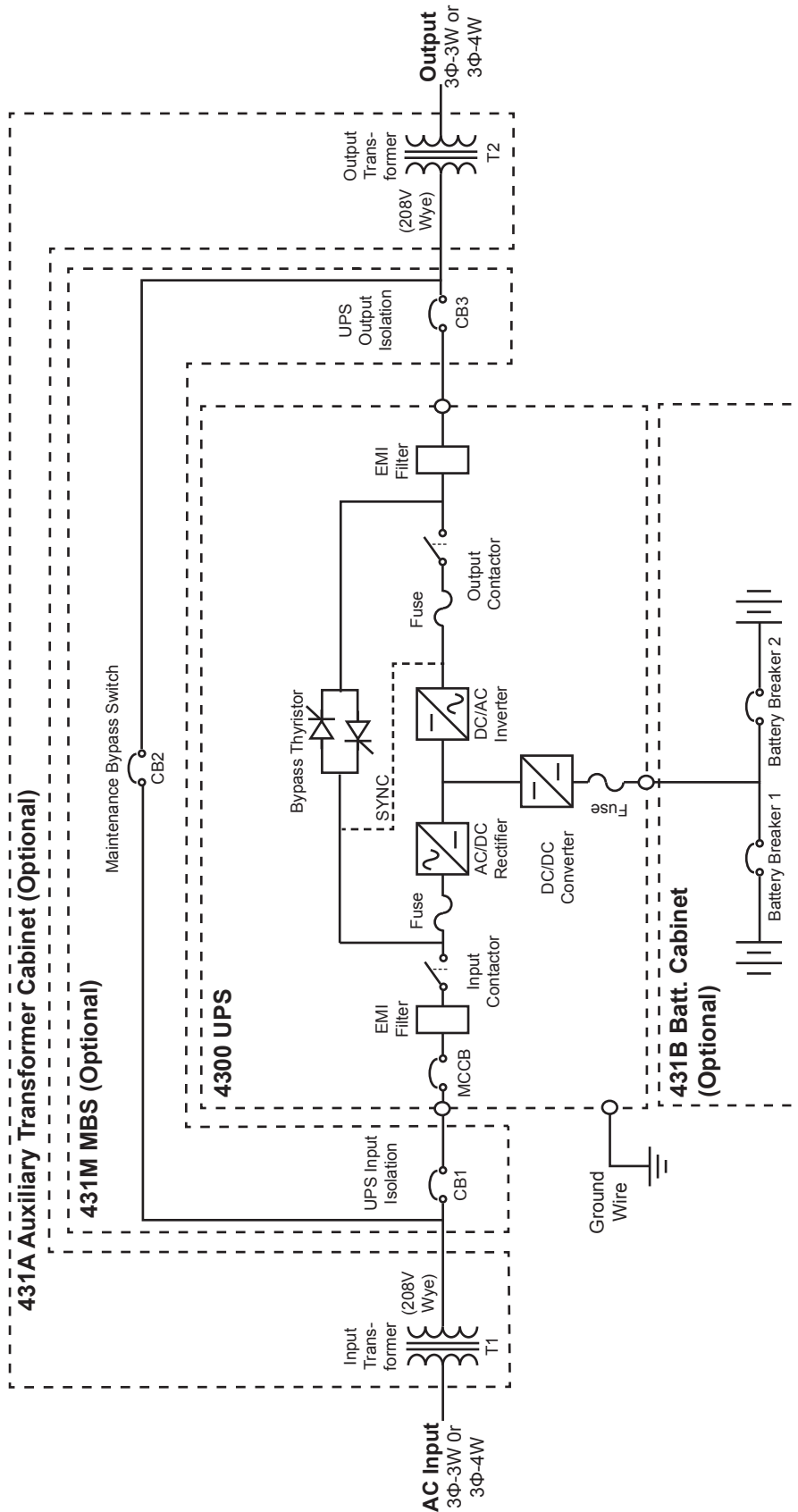
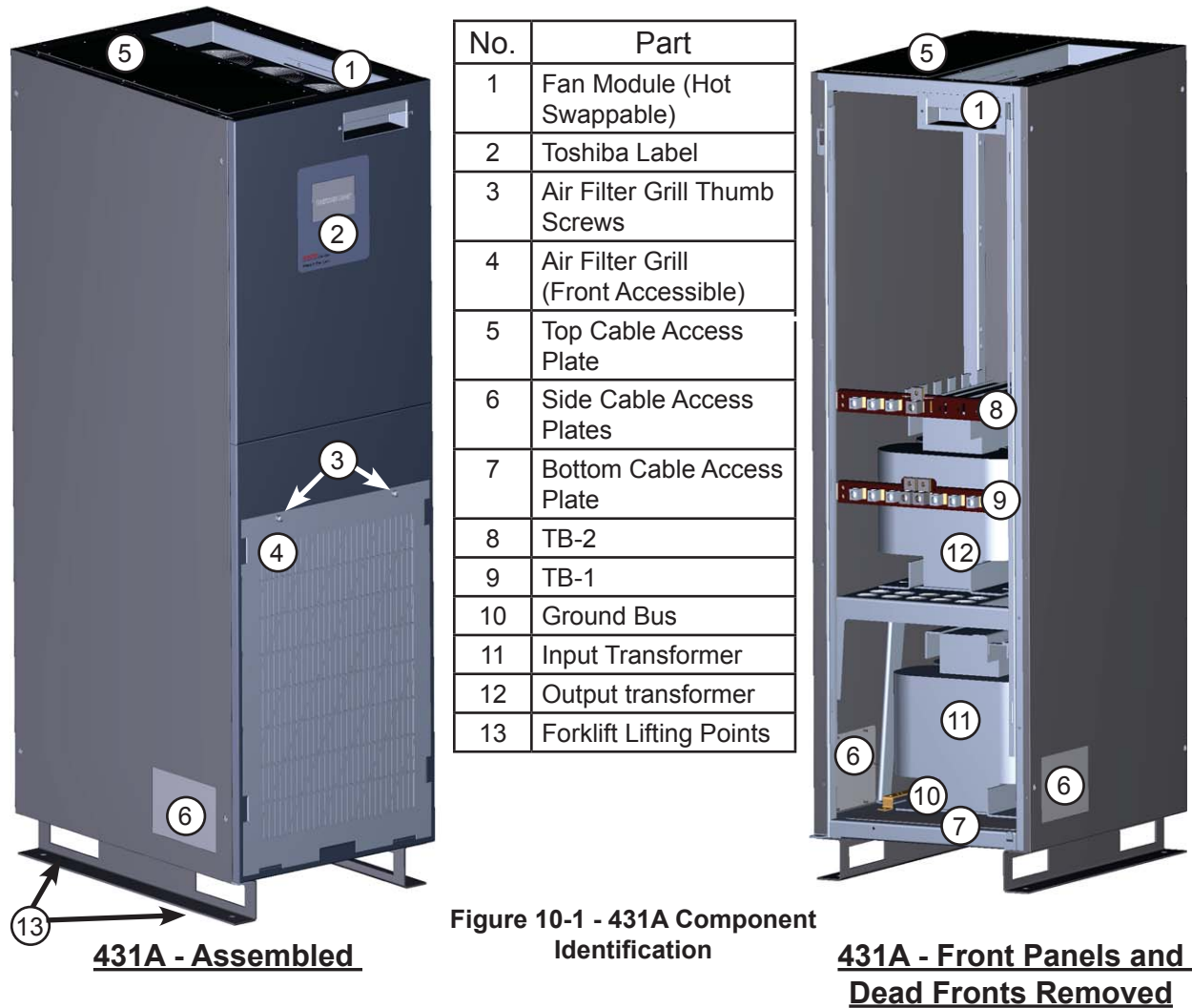

Figure 9-2 - One-Line Diagram of 4300 UPS with Optional matching 431M MBS, 431B Battery Cabinet, and 431A Transformer Cabinet

10 431A - Toshiba Auxiliary Cabinet



10.1 4300 Auxiliary Cabinet Transformer Options

(All cabinets are O'Brien Black (Textured))

Xfmr Cabinet Part Number*	Transformer Rating	Input Transformer(s) Primary and Secondary Line Voltage IN, 208/120 V OUT	# of Φ	Output Transformer 208/120 V IN, Load Voltage OUT
431A-	300 – 30 kVA 500 – 50 kVA	Where line voltage is : B – 208 V (Δ) C – 240 V (Δ) M – 600 V (Δ) N – 380/400/415 V (Δ) (multi-tap) S – 480 V (Δ) X – 208/120 V (Y) (No Transformer)	3	Where load voltage is : H – 220/127 V (Y) J – 240/138 V (Y) K – 480/277 V (Y) M – 600/347 V (Y) P – 380/220 V (Y) Q – 400/230 V (Y) X – 208/120 V (Y) (No Transformer)

Example: **431A500S3K** is a 50kVA, three-phase transformer cabinet with a 480V to 208/120V input transformer, and a 208/120 V to 480/277 V output transformer.

10.2 Alternative Configurations

The 431A has three additional modules that can be integrated into the unit:

- Maintenance bypass panel (MBS) with mechanical interlock secured by a solenoid release.
- 12 pole Power Distribution Unit (PDU)
- 2, 3, or 4 Breaker Sub-feed Panel

These can be combined in the following configurations:

- One Transformer and EITHER a PDU OR a Sub-feed Panel
- A MBS and EITHER a PDU OR a Sub-feed Panel

10.3 EQUIPMENT WARNING LABELS

DO NOT attempt to install, operate, maintain or dispose of this equipment until you have read and understood all of the product warnings and user directions that are contained in this instruction manual.

Shown below are examples of warning labels that may be found attached to the equipment. **DO NOT** remove or cover any of the labels. If the labels are damaged or if additional labels are required, contact your TOSHIBA representative for additional labels.

The following are examples of the warning labels that may be found on the equipment. The labels are there to provide useful information or to indicate an imminently hazardous situation that may result in serious injury, severe property and equipment damage, or death if the instructions are not followed.

(A) 48082

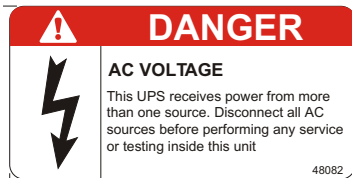

(B) 40308

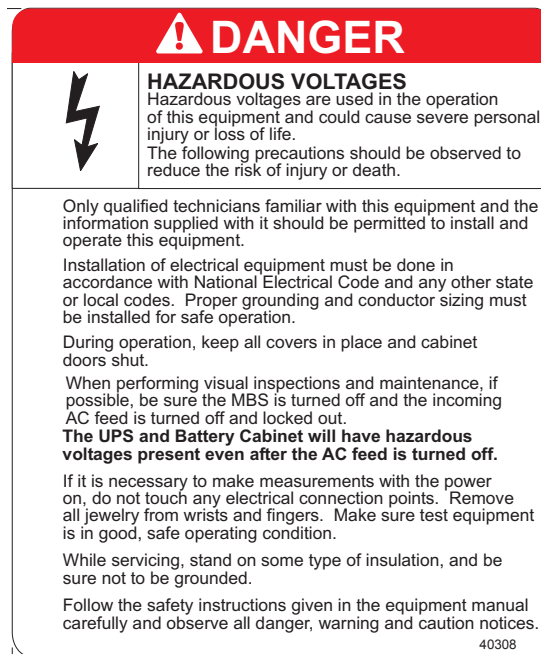

Figure 10-2: Auxiliary Cabinet Warning Labels

10.9 INSTALLATION INSTRUCTIONS



DANGER: HAZARDOUS VOLTAGES MAY EXIST.



Verify all power is removed from the UPS and power cables prior connecting the power cables to the Ancillary cabinet terminals, Maintenance Bypass Switch terminals, or UPS terminals.

The Toshiba Auxiliary Cabinet (431A) can be used in either of two arrangements. 431A with the 4300 UPS, or 431A with the 431M and the 4300 UPS.

431A with the 4300 UPS

Select the proper cable size per Table 10.3 then got to Section **Place the 431A Cabinet**.

431A with 431M and 4300 UPS

Select the proper cable size per Table 10.3.

Terminate the cable end connecting to the 431M with 0.5 inch bolt hole terminal lugs. See Table 10.2 below.

The 431M Circuit Breakers are equipped with terminal bus strips pre-drilled in a standard NEMA 2-hole pattern (0.5 in. bolt holes on 1.75 in. centers) to facilitate installation of power cables. Use of NEMA two-hole cable terminations is recommended.

Terminate the cable end connecting to the 431M with 0.5 inch bolt hole terminal lugs. See Table 10.2 below.

Table 10.1: Bolt Tightening Specifications

ITEM	Torque
Grade 8, 1/2 in. Bolts	119 ft-lb (161 N•M)

The following table lists examples of NEMA 2-hole compression type fittings.

Table 10.2: Compression Fittings

IlSCO P/N	Description	Conductor Size	Fitting Color
CLND-6-12-134 CSWD -6-12-134	Long Barrel Short Barrel	#6	Blue
CLND-4-12-134 CSWD -4-12-134	Long Barrel Short Barrel	#4	Grey
CLND-3-12-134	Long Barrel	#3	White
CLND-2-12-134 CSWD -2-12-134	Long Barrel Short Barrel	#2	Brown
CLND-1-12-134 CSWD -1-12-134	Long Barrel Short Barrel	#1	Green
CLND-1/0-12-134 CSWD -1/0-12-134	Long Barrel Short Barrel	1/0	Pink
CLND-2/0-12-134 CSWD -2/0-12-134	Long Barrel Short Barrel	2/0	Black
CLND-3/0-12-134 CSWD -3/0-12-134	Long Barrel Short Barrel	3/0	Orange
CLND-4/0-12-134 CSWD -4/0-12-134	Long Barrel Short Barrel	4/0	Purple
CLND-250-12-134 CSWD -250-12-134	Long Barrel Short Barrel	250	Yellow
CLND-300-12-134 CSWD -300-12-134	Long Barrel Short Barrel	300	White
CLND-350-12-134 CSWD -350-12-134	Long Barrel Short Barrel	350	Red

Go to Section **Place the 431A Cabinet**.

Table 10.3 - 431A Input/Output Power Cable Sizes
(Cable sizes for 75°C Copper Cable)

Trans- former	Code	Input/Output Trans- former Voltage	Xfmr Type	Recommended/Maximum Wire size and Torque Requirement					
				30 kVA		50 kVA		Tightening Torque	
				Phase AWG*	Neutral AWG*	Phase AWG*	Neutral AWG*		
Input	B	208V Δ to 208/120V Y	Input Iso	2 - 250 kcmil	N/A	2/0 - 250 kcmil	N/A	200 in.-lbs.	
	C	240V Δ to 208/120V Y	Input Iso	3 - 250 kcmil	N/A	1/0 - 250 kcmil	N/A	200 in.-lbs.	
	N	380V Δ to 208/120V Y	Input Iso	6 - 250 kcmil	N/A	3 - 250 kcmil	N/A	200 in.-lbs.	
	N	400/415V Δ to 208/120V Y	Input Iso	6 - 250 kcmil	N/A	3 - 250 kcmil	N/A	200 in.-lbs.	
	S	480V Δ to 208/120V Y	Input Iso	6 - 250 kcmil	N/A	4 - 250 kcmil	N/A	200 in.-lbs.	
	M	600V Δ to 208/120V Y	Input Iso	6 - 250 kcmil	N/A	6 - 250 kcmil	N/A	200 in.-lbs.	
	X	208/120V Y 4 wire input (No Transformer)	N/A	1/0 - 250 kcmil	4/0 - 350 kcmil	250 kcmil	350 kcmil	200 in.-lbs.	
	K	480/277V Y to 208/120V Y	Input Auto	6 - 250 kcmil	3 - 350 kcmil	3 - 250 kcmil	2/0 - 350 kcmil	200 in.-lbs.	
	F	208/120V Y 4 wire input (No Transformer)	N/A	1/0 - 250 kcmil	4/0 - 350 kcmil	250 kcmil	350 kcmil	200 in.-lbs.	
	H	208/120V Y to 220/127V Y	Output Auto	1 - 250 kcmil	4/0 - 350 kcmil	4/0 - 250 kcmil	350 kcmil	200 in.-lbs.	
Output	J	208/120V Y to 240/139V Y	Output Auto	2 - 250 kcmil	3/0 - 350 kcmil	3/0 - 250 kcmil	350 kcmil	200 in.-lbs.	
	P	208/120V Y to 380/220V Y	Output Iso	4 - 250 kcmil	1 - 350 kcmil	1 - 250 kcmil	4/0 - 350 kcmil	200 in.-lbs.	
	Q	208/120V Y to 400/230V Y	Output Iso	4 - 250 kcmil	1 - 350 kcmil	2 - 250 kcmil	3/0 - 250 kcmil	200 in.-lbs.	
	K	208/120V Y to 480/277V Y	Output Auto	6 - 250 kcmil	3 - 350 kcmil	3 - 250 kcmil	2/0 - 250 kcmil	200 in.-lbs.	
	M	208/120V Y to 600/347V Y	Output Iso	6 - 250 kcmil	4 - 350 kcmil	4 - 250 kcmil	1/0 - 250 kcmil	200 in.-lbs.	

* Wire capacity for Phase lugs is 250 kcmil - 6 AWG, Neutral lugs is 350 kcmil - 6 AWG.

10.5 Anchor the 431A Cabinet

The 431A Cabinet has four mounting holes to anchor the unit after it has been set in place. See Figure 10-4.

Verify the Right Side Access Plate of the 431A and the corresponding left side access plate of the 431M or 4300 UPS is removed before anchoring the unit.

NOTE: Ensure the 431A can be joined to the UPS/431M before final anchoring of the 431A. See below.

Install the anchor bolts to secure the UPS on the floor. See Figure 9-4 for anchor bolt installation detail. Use 1/2" (12 mm) diameter anchor bolts. There are four 0.63" (16 mm) diameter holes provided in the UPS base. See Figure 8.3 for the hole locations and dimensions for the specified UPS models

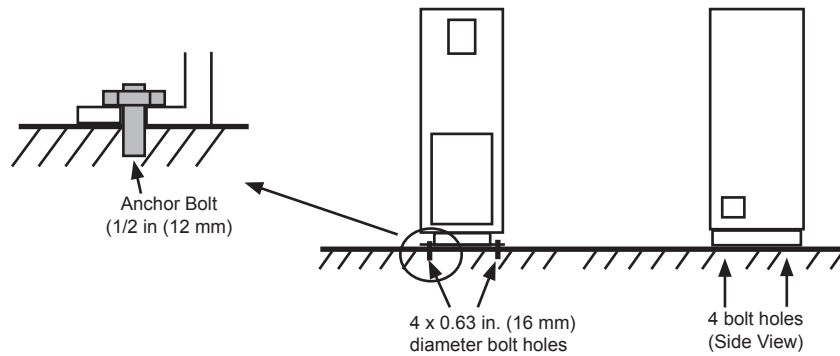

Figure 10-3 Anchor Bolt Installation Detail

If the 431A is joining to the:

4300 UPS, go to section 10.6

431M, go to section 10.7

Figure 10-4 - 431A Base Anchor Points

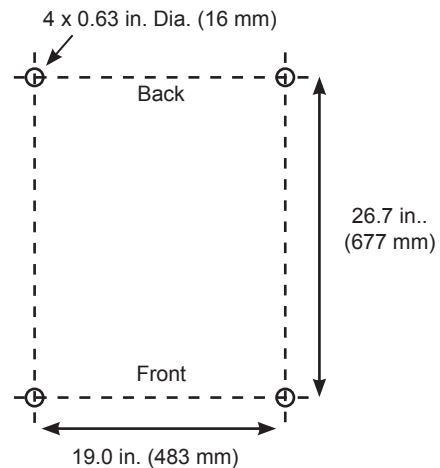

10.6 Join the Auxiliary Cabinet with the UPS

The Toshiba Auxiliary Cabinet (431A) is equipped with four 14 mm mating holes located on the front and back of the left and right sides of the cabinet.

1. Remove the top and bottom 431A Cabinet Front panels.
2. Remove the cable access plate at the lower-front right side of the 431A Cabinet. (See Figure 10.5)
3. Remove the cable access plate at the lower-front left side of the UPS Cabinet.
4. Position the 431A cabinet to the left of and adjacent to the UPS Cabinet.
5. Align the four 0.63 in (14 mm) bolt holes on the right side of the 431A Cabinet with the matching four 14 mm bolt holes on the left side of the UPS Cabinet.
6. Bolt the cabinets together with four 3/8-16 in. x 2 in. long bolts.
7. Select the power cables per Table 10.2 /Table 10.3. Cable size for the UTILITY and LOAD terminals are dependant on the Input/Output Voltages to the transformers. The UPS Input/Output cables will be the same size: 3Phase/4Wire 208/120V.
8. Run the power cables from UPS power terminals TB1 to 431A Cabinet power terminals TB1 per Figure 10-6.
9. Run the appropriately sized power cables from 431A TB2 to the Utility and Load per Figure 10-6.

Figure 10-5 - 431A Cable Access Plate

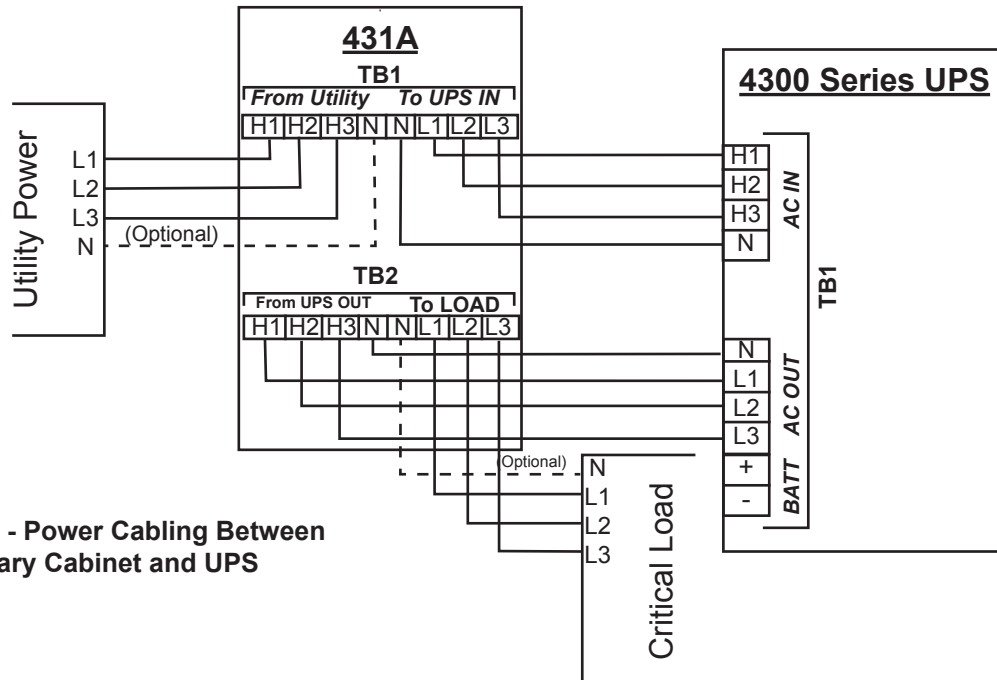
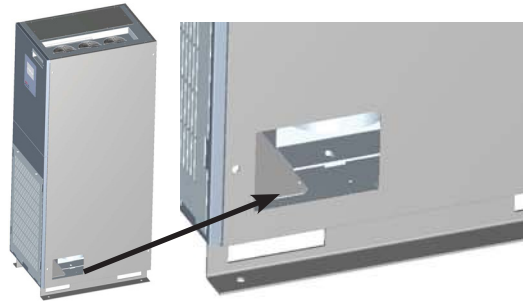

Figure 10-6 - Power Cabling Between Auxiliary Cabinet and UPS

10.7 Join the 431A Cabinet with the 431M

The Toshiba Auxiliary Cabinet (431A) is equipped with four 14 mm mating holes located on the front and back of the left and right sides of the cabinet.

1. Remove the top and bottom 431A Front panels.
2. Remove the cable access plate at the lower-front right side of the 431A Cabinet. (See Figure 10-7)
3. Remove the cable access plate at the lower-front left side of the 431M Cabinet.
4. Position the 431A cabinet to the left of and adjacent to the 431M Cabinet.
5. Align the four 14 mm bolt holes on the right side of the 431A Cabinet with the matching four 14 mm bolt holes on the left side of the 431M Cabinet.
6. Bolt the cabinets together with four 3/8-16 in. x 2 in. long bolts.
7. Select the power cables per Table 10.3.
 - Cable size for the UTILITY and LOAD terminals are dependant on the Input/Output Voltages to the transformers.
 - The UPS Input/Output cables will be the same size: 3Phase /4Wire 208/120V.
8. Run the power cables from 431M power terminals TB1 to 431A power terminals TB1 per Figure 10-8.
9. Run the appropriately sized power cables from 431A TB2 to the Utility and Load per Figure 10-8.

Figure 10.7 - 431A Cable Access Plate

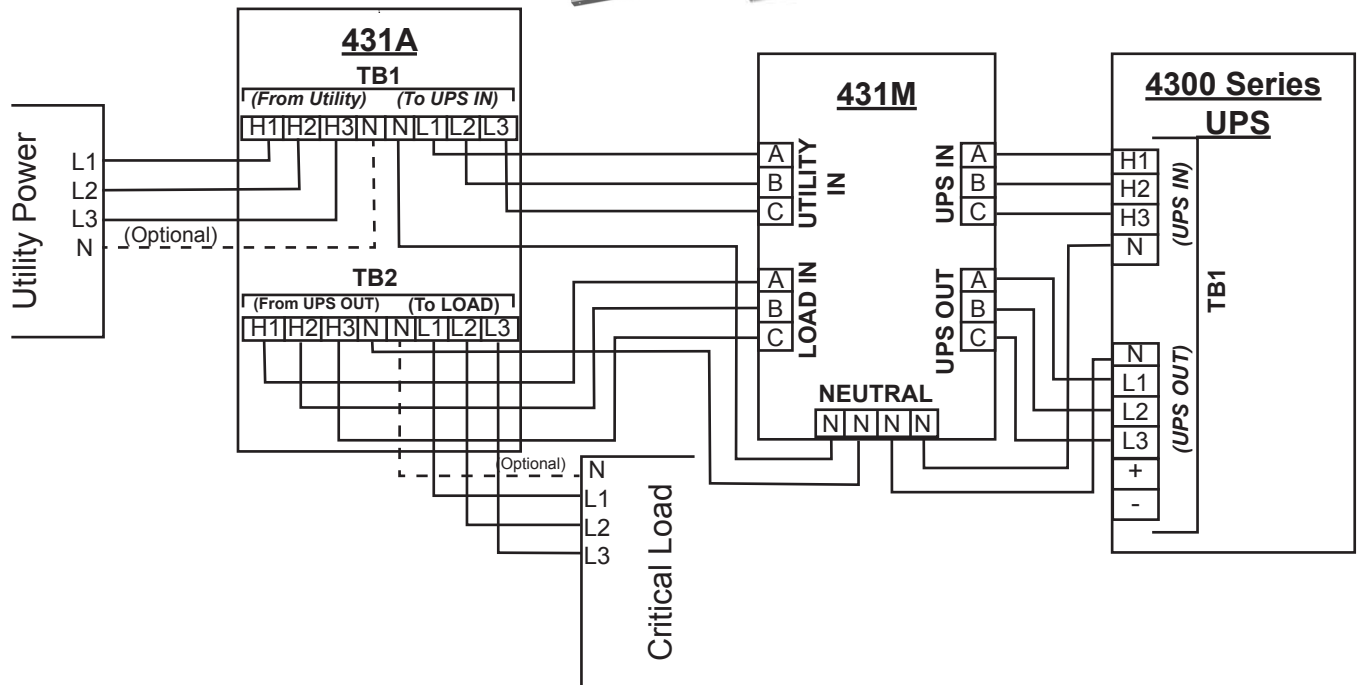
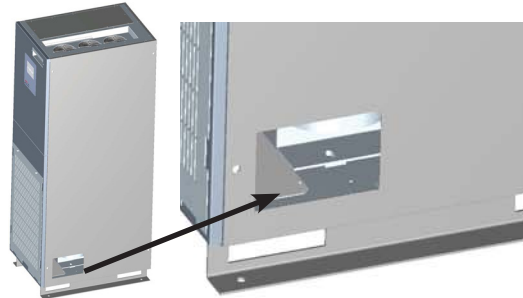

Figure 10-8 - Power Cabling Between Auxiliary Cabinet, MBS, and UPS

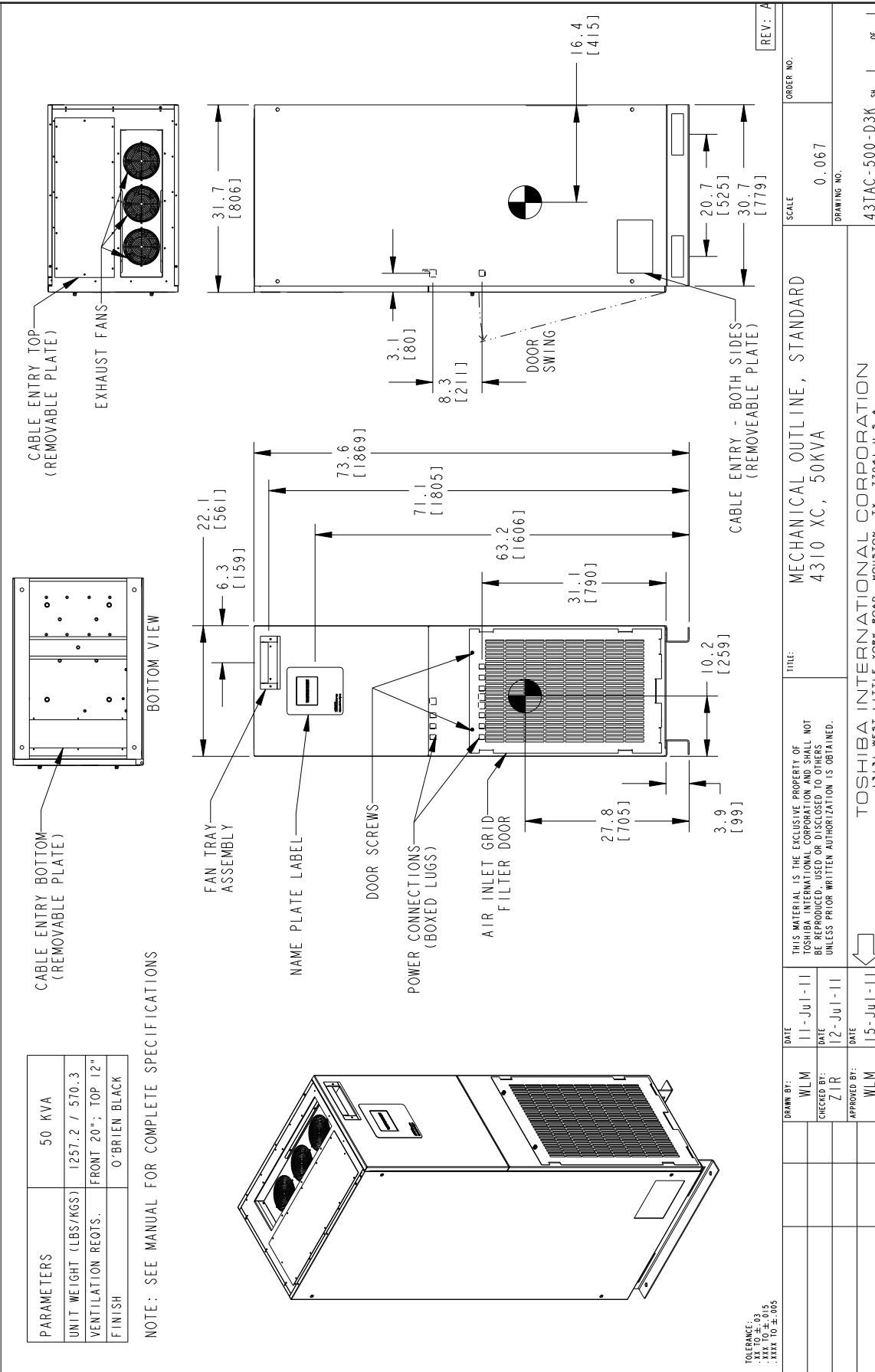
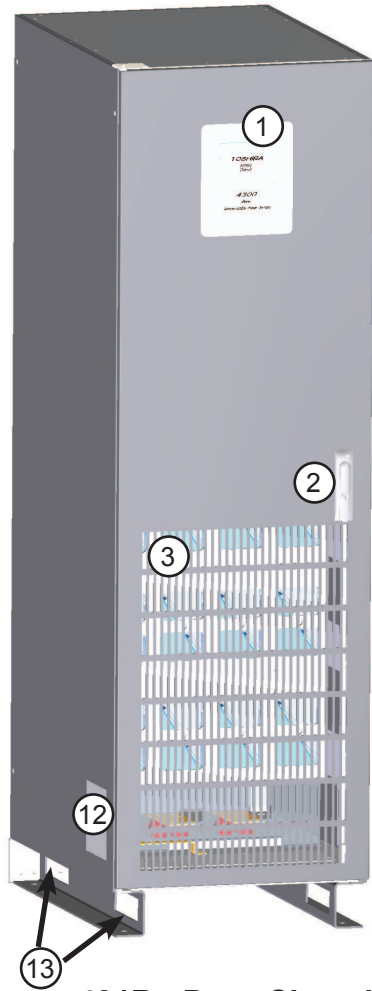

Figure 10-9 - Toshiba Auxiliary Cabinet Outline Drawing

11 431B - Toshiba Battery Cabinet



431B - Door Closed

No.	Part
1	Toshiba Label
2	Door Latch
3	Ventilation Grill
4	Upper Battery Retention Plate
5	MCCB1 - Upper Battery Section Breaker
6	MCCB2 - Lower Battery Section Breaker
7	Lower Battery Retention Plate
8	Batteries
9	Power Bus Stubs (+), (-)
10	Ground Bus
11	Bottom Cable Access Port
12	Side Cable Access Port
13	Forklift Fork Slots

Figure 11-1 - 431B Component Identification

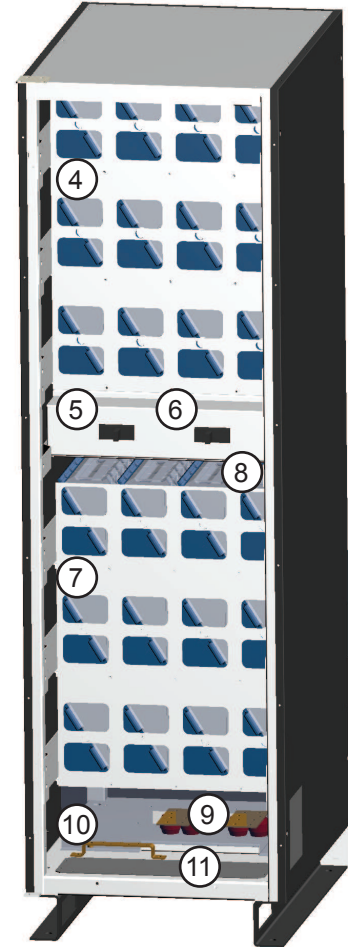

431B - Door Open

11.1 431B Estimated Runtimes

(All cabinets are O'Brien Black (Textured))

Xfmr Cabinet Part Number*	UPS Rating	DC Bus Nominal Voltage	Batteries/Circuit Breaker Configuration	Battery Runtime in Min. @ Full Load, 0.8 PF
431B-	300 – 30 kVA	R – 288 VDC	1- 1 Breaker, 3 Battery Strings	006 – 6 min. runtime
	300 – 30 kVA		2- 2 Breaker, 6 Battery Strings	017 – 17 min. runtime
	500 – 50 kVA		2- 2 Breaker, 6 Battery Strings	008 – 8 min. runtime

Example: **431B-500R2008** is a battery cabinet with upper and lower battery sections, nominal 288 DCV, dual breakers sized for a 50kVA UPS with an approximate runtime of 8 minutes at 50kVA load at 0.8 Power Factor.

11.2 EQUIPMENT WARNING LABELS

DO NOT attempt to install, operate, maintain or dispose of this equipment until you have read and understood all of the product warnings and user directions that are contained in this instruction manual.



Figure 11-2 shows examples of warning labels that may be found attached to the equipment. **DO NOT** remove or cover any of the labels. If the labels are damaged or if additional labels are required, contact your TOSHIBA representative for additional labels.

The following are examples of the warning labels that may be found on the equipment. The labels are there to provide useful information or to indicate an imminently hazardous situation that may result in serious injury, severe property and equipment damage, or death if the instructions are not followed.

(A) 40308

⚠ DANGER	
	<p>HAZARDOUS VOLTAGES Hazardous voltages are used in the operation of this equipment and could cause severe personal injury or loss of life. The following precautions should be observed to reduce the risk of injury or death.</p>
<p>Only qualified technicians familiar with this equipment and the information supplied with it should be permitted to install and operate this equipment.</p> <p>Installation of electrical equipment must be done in accordance with National Electrical Code and any other state or local codes. Proper grounding and conductor sizing must be installed for safe operation.</p> <p>During operation, keep all covers in place and cabinet doors shut.</p> <p>When performing visual inspections and maintenance, if possible, be sure the MBS is turned off and the incoming AC feed is turned off and locked out.</p> <p>The UPS and Battery Cabinet will have hazardous voltages present even after the AC feed is turned off.</p> <p>If it is necessary to make measurements with the power on, do not touch any electrical connection points. Remove all jewelry from wrists and fingers. Make sure test equipment is in good, safe operating condition.</p> <p>While servicing, stand on some type of insulation, and be sure not to be grounded.</p> <p>Follow the safety instructions given in the equipment manual carefully and observe all danger, warning and caution notices.</p>	
40308	

(B) 41750

	<p>WARNING - Risk of electric shock</p> <p>DO NOT REMOVE COVER. NO USER SERVICEABLE PARTS INSIDE. REFER SERVICING TO QUALIFIED SERVICE PERSONNEL. HAZARDOUS LIVE PARTS INSIDE THIS UPS ARE ENERGIZED FROM THE BATTERY SUPPLY EVEN WHEN THE INPUT AC POWER IS DISCONNECTED.</p> <p>CAPACITORS STORE HAZARDOUS ENERGY. DO NOT REMOVE COVER UNTIL 5 MINUTES AFTER DISCONNECTING ALL SOURCES OF SUPPLY.</p> <p>TO REDUCE THE RISK OF FIRE OR ELECTRIC SHOCK, INSTALL IN A TEMPERATURE AND HUMIDITY CONTROLLED INDOOR AREA FREE OF CONDUCTIVE CONTAMINANTS.</p>
	<p>AVERTISSEMENT</p> <p>EN CAS D'UTILISATION EN ATMOSPHERE CONTROLLEE. CONSULTER LA NOTICE TECHNIQUE.</p> <p>BATTERY BACK-UP TIME, WHICH WAS FACTORY-SET AT A PREDETERMINED LEVEL, DECREASES GRADUALLY BETWEEN SERVICE PERIODS. THE BATTERIES SHOULD BE REPLACED EVERY THREE YEARS AFTER THE LAST SERVICING, THE DATE OF WHICH IS WRITTEN ON THE ID PLATE LOCATED ON THE REAR SIDE OF THE UPS UNIT, OR IN THE BOX BELOW.</p> <p>DATE OF LAST BATTERY CHARGE:</p>
PN 41750	<input type="text"/> <input type="text"/>

(C) 43784

⚠ DANGER	
	<p>DC VOLTAGE DC Voltage supplied by batteries is still present after equipment has been turned off and taken off line. Accidental contact with live parts can cause personal injury and death. Disconnect all DC Sources before performing any service or testing in this compartment.</p>
43784	

(D) 49455

⚠ WARNING		⚠ WARNING
	<p>This unit contains sealed lead acid batteries. Lack of preventative maintenance could result in batteries exploding and emitting gasses and/or flame. Annual preventative maintenance must be performed by an authorized, trained technician.</p>	<p>CRITICAL FUSE SIZING Incorrect fuse replacement size may result in fire or inadequate equipment protection. Replace only with same type and rating of fuse.</p>

(E) 48082

⚠ DANGER	
	<p>AC VOLTAGE This UPS receives power from more than one source. Disconnect all AC sources before performing any service or testing inside this unit</p>
48082	

(F) 66005

<p>32° AMBIENT TEMPERATURE</p>

Figure 11-2: Battery Cabinet Warning Labels

11.3 INSTALLATION INSTRUCTIONS



DANGER: HAZARDOUS VOLTAGES MAY EXIST.



Verify all power is removed from the UPS and power cables prior connecting the power cables to the Battery Cabinet and UPS terminals.

The Toshiba Battery Cabinet (431B) comes in either of two configurations:

- 431B with three battery strings in the upper section,
- 431B with three battery strings each in the upper and lower sections.

No more than two Toshiba 431B Battery Cabinets may be connected in parallel to the 4300 Series UPS.

INSTRUCTIONS IMPORTANTES CONCERNANT LA SÉCURITÉ CONSERVER CES INSTRUCTIONS

Cette notice contient des instructions importantes concernant la sécurité



ATTENTION

Un battery puet présenter un risque de choc électrique, de brûlure par transfert d'énergie.



ATTENTION

L'élimination des batteries est règlementée. Consulter les codes locaux à cet effet

4431B and 4300 UPS

Select the proper cable size per Table 11.3.

Terminate the cable end connecting to the 431B with 0.5 inch bolt hole terminal lugs. See Table 11.2 below.

The 431B DC Output is equipped with terminal bus strips pre-drilled in a standard NEMA two-hole pattern (0.5 in. bolt holes on 1.75 in. centers) to facilitate installation of power cables. Use of NEMA two-hole cable terminations is recommended.

Table 11.1: Bolt Tightening Specifications

ITEM	Torque
Grade 8, 1/2 in. Bolts	119 ft-lb (161 N•M)

The following table lists examples of NEMA 2-hole compression type fittings.

Table 11.2: Compression Fittings

IlSCO P/N	Description	Conductor Size	Fitting Color
CLND-6-12-134 CSWD -6-12-134	Long Barrel Short Barrel	#6	Blue
CLND-4-12-134 CSWD -4-12-134	Long Barrel Short Barrel	#4	Grey
CLND-3-12-134	Long Barrel	#3	White
CLND-2-12-134 CSWD -2-12-134	Long Barrel Short Barrel	#2	Brown
CLND-1-12-134 CSWD -1-12-134	Long Barrel Short Barrel	#1	Green
CLND-1/0-12-134 CSWD -1/0-12-134	Long Barrel Short Barrel	1/0	Pink
CLND-2/0-12-134 CSWD -2/0-12-134	Long Barrel Short Barrel	2/0	Black
CLND-3/0-12-134 CSWD -3/0-12-134	Long Barrel Short Barrel	3/0	Orange

Ilsc P/N	Description	Conductor Size	Fitting Color
CLND-4/0-12-134 CSWD -4/0-12-134	Long Barrel Short Barrel	4/0	Purple
CLND-250-12-134 CSWD -250-12-134	Long Barrel Short Barrel	250	Yellow
CLND-300-12-134 CSWD -300-12-134	Long Barrel Short Barrel	300	White
CLND-350-12-134 CSWD -350-12-134	Long Barrel Short Barrel	350	Red

Go to Section **Place the 431B Cabinet.**

Table 11.3 - 431B Power Cable Sizes
(Cable sizes for 75°C Copper Cable)

Recommended/Maximum Wire size and Torque Requirement				
UPS Rating	Maximum DC Current	Recommended Cable Sizes	UPS Terminal Lug Tightening Torque	431B Bus Lugs Tightening Torque
20 kVA	84 Adc	4 AWG – 350 kcmil	200 in.-lbs.	119 ft-lb (161 N•M)
30 kVA	126 Adc	1 AWG – 350 kcmil	200 in.-lbs.	119 ft-lb (161 N•M)
40 kVA	169 Adc	1/0 – 350 kcmil	200 in.-lbs.	119 ft-lb (161 N•M)
50 kVA	210 Adc	4/0 – 350 kcmil	200 in.-lbs.	119 ft-lb (161 N•M)
60 kVA	253 Adc	250 kcmil – 350 kcmil	200 in.-lbs.	119 ft-lb (161 N•M)

* Wire capacity for DC lugs is 350 kcmil - 6 AWG,

11.4 Place the 431B Cabinet

The 431B Cabinet has four mounting holes to anchor the unit after is has been set in place. See Figure 10-3. Use 1/2 in (12 mm) bolts to anchor the 431B.

Verify the Left Side Access Plate of the 431B and the corresponding Right side access plate of the 4300 UPS are removed before anchoring the unit.

NOTE: Ensure the 431B can be joined to the UPS before final anchoring of the 431A. Use four 3/8 in. -16 x 2 in long bolts to bolt the ancillary cabinet frames together.

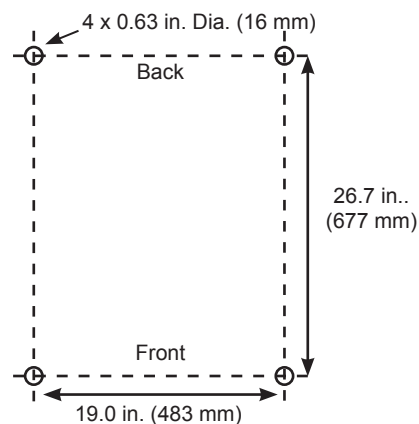

Figure 11-3 - 431B Base Anchor Points



11.5 Join the Battery Cabinet with the UPS

The Toshiba Battery Cabinet (431B) is equipped with four 14 mm mating holes located on the front and back of the left and right sides of the cabinet.

1. Ensure Battery Cabinet Breaker are OFF.

 WARNING	
	<p>Switch the Battery Cabinet Circuit Breakers off before removing dead fronts. Failure to switch breakers off may result in electric shock, burns, personal injuries or UPS failure.</p>

2. Remove the UPS dead-fronts.
3. Remove the cable access plate at the lower-front right side of the UPS Cabinet.
4. Remove the cable access plate at the lower-front left side of the 431B Cabinet. (See Figure 11-4)
5. Position the 431B cabinet to the right of and adjacent to the UPS Cabinet.
6. Align the four 14 mm bolt holes on the left side of the 431B Cabinet with the matching four 14 mm bolt holes on the right side of the UPS Cabinet.
7. Bolt the cabinets together with four 3/8-16 in. x 2 in. long bolts.

Figure 11-4 - 431B Cable Access Plate



11.6 Wire the Battery Cabinet to the UPS

1. Select the DC power cables per Table 11.2 /Table 11.3.

⚠ WARNING

⚠ Switch the Battery Cabinet Circuit Breakers off before removing dead fronts.

Failure to switch breakers off may result in electric shock, burns, personal injuries or UPS failure.

2. Run the power cables from UPS power terminals TB1 (+) and (-) to 431B Cabinet power terminals (+) and (-) per Figure 11.5 and 11.6.
3. Select the power cables per Table 11.2 /Table 11.3. Cable size for the 431B is determined by the full load capacity of the UPS.
4. Run the power cables from UPS power terminals TB1 (+) and (-) to 431B Cabinet power terminals (+) and (-) per Figure 11.5 and Figure 11.6.

Note: The UPS cable ends insert into power lugs, the 431B ends require a NEMA 2-hole connector to connect to the +/- bus terminals.

No.	Component
1	Positive Terminal (+) Bus Strip
2	Negative Terminal (-) Bus Strip
3	Lexan Shield with Cable Access
4	Ground Bus
5	Bottom Cable Access Plate
6	Side Cable Access Plate

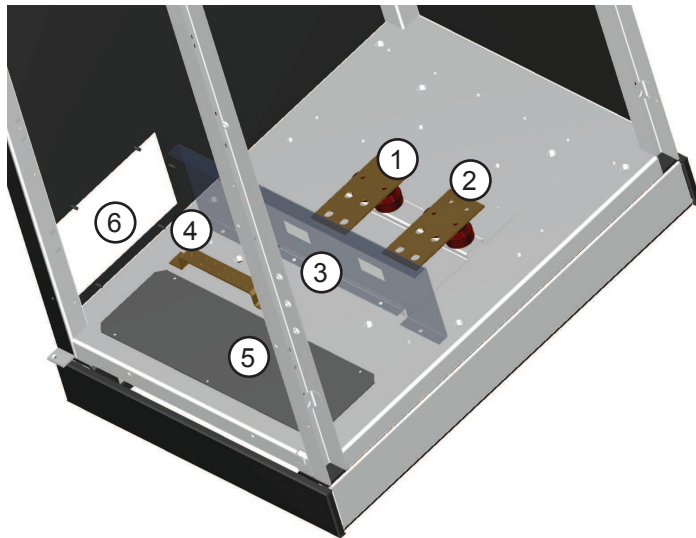

Figure 11-5 - 431B DC Bus Terminal Detail

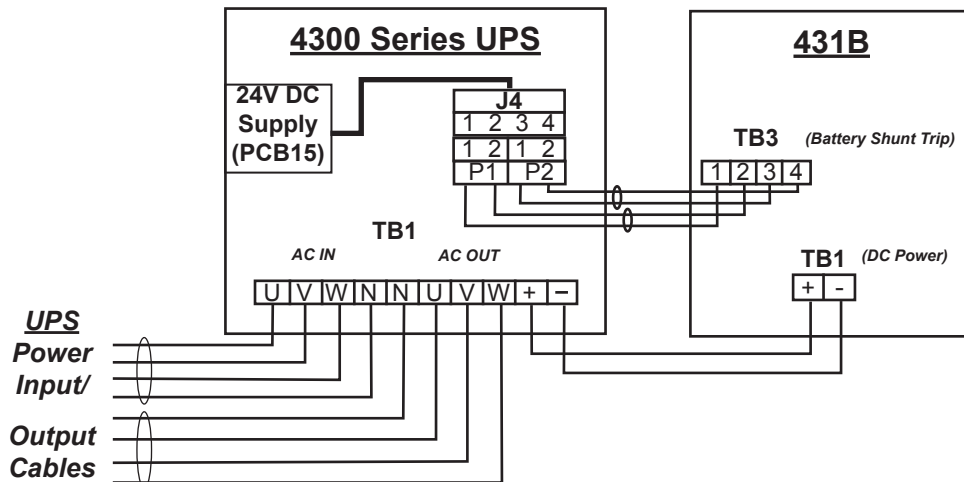

Figure 11-6 - 431B DC and Breaker Cable Connections

1. Run the pre-wired shunt trip cable shown in Figure 11.7 from the 431B through the 431B/UPS cable access port located at the bottom left side of the 431B, to the UPS 24VDC power supply on the lower left side of the UPS.
2. Plug the shunt trip cable connector into the shunt trip receptacle in the lower left front of the UPS.
(The connectors are keyed to only plug in one way.)
3. Reinstall the dead fronts.

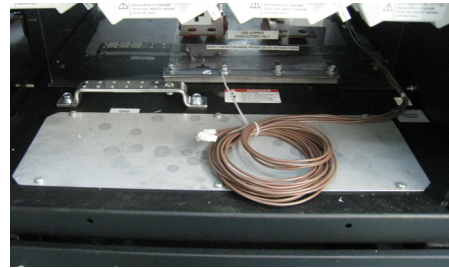

Figure 11-7 - 431B Factory Supplied Shunt Trip Wiring

11.7 431B Backup Runtime Tables

The following give the typical backup runtimes at various loads for a single cabinet 431B.

UPS	Capacity	PF	Runtime in Minutes at % Full Load									
			100%	90%	80%	70%	60%	50%	40%	30%	20%	10%
4300	30kVA	0.8	17	21	24	30	38	45	59	>90	>90	>90
4300	30kVA	0.9	15	17	20	24	33	38	53	74	>90	>90
4300	50kVA	0.8	8	9	11	14	17	24	32	46	70	>90
4300	50kVA	0.9	7	8	9	11	15	20	26	44	60	>90

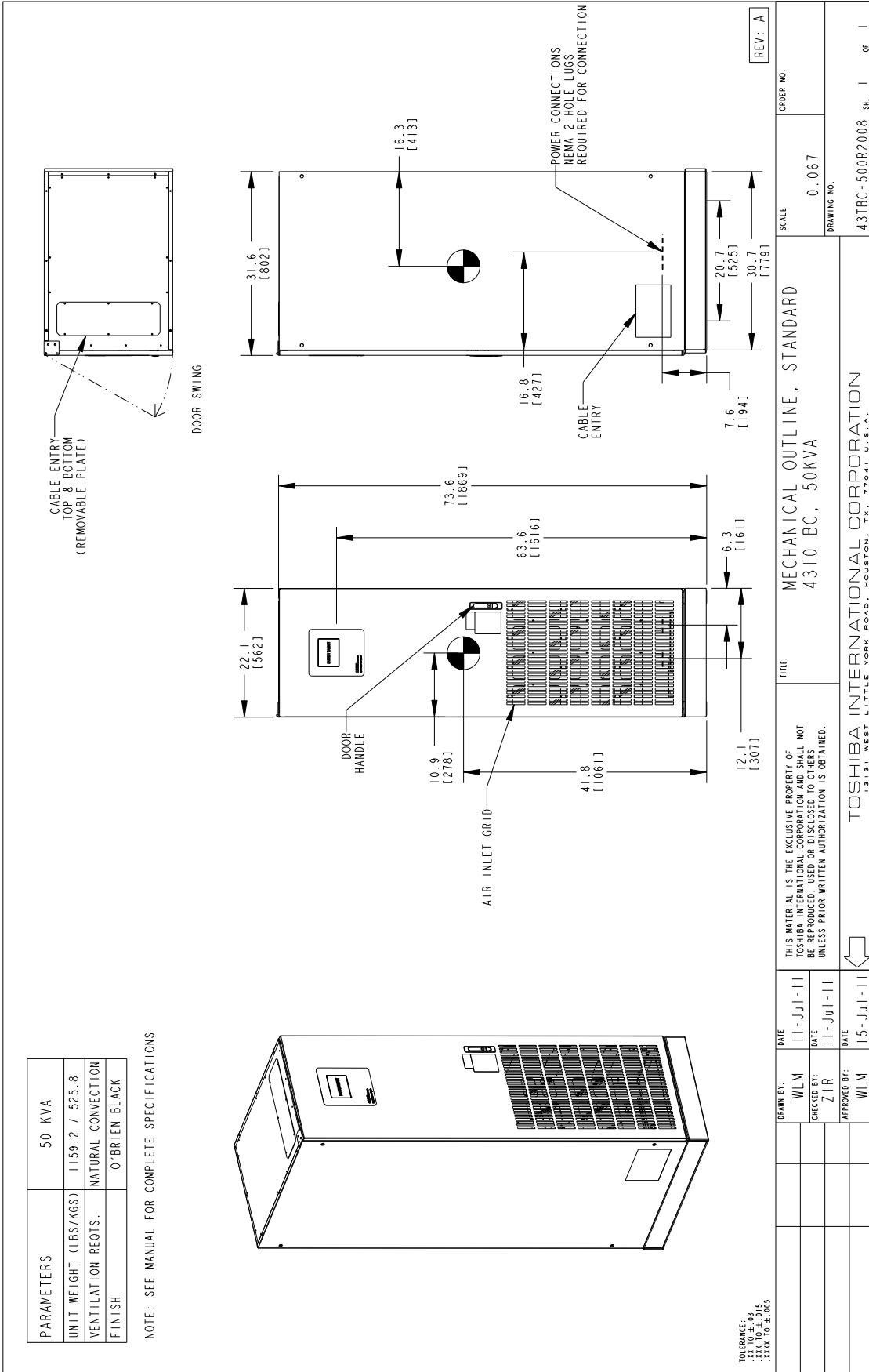

Figure 11-9 - Toshiba Battery Cabinet Outline Drawing

12 431M - MBS Cabinet Installation Guide

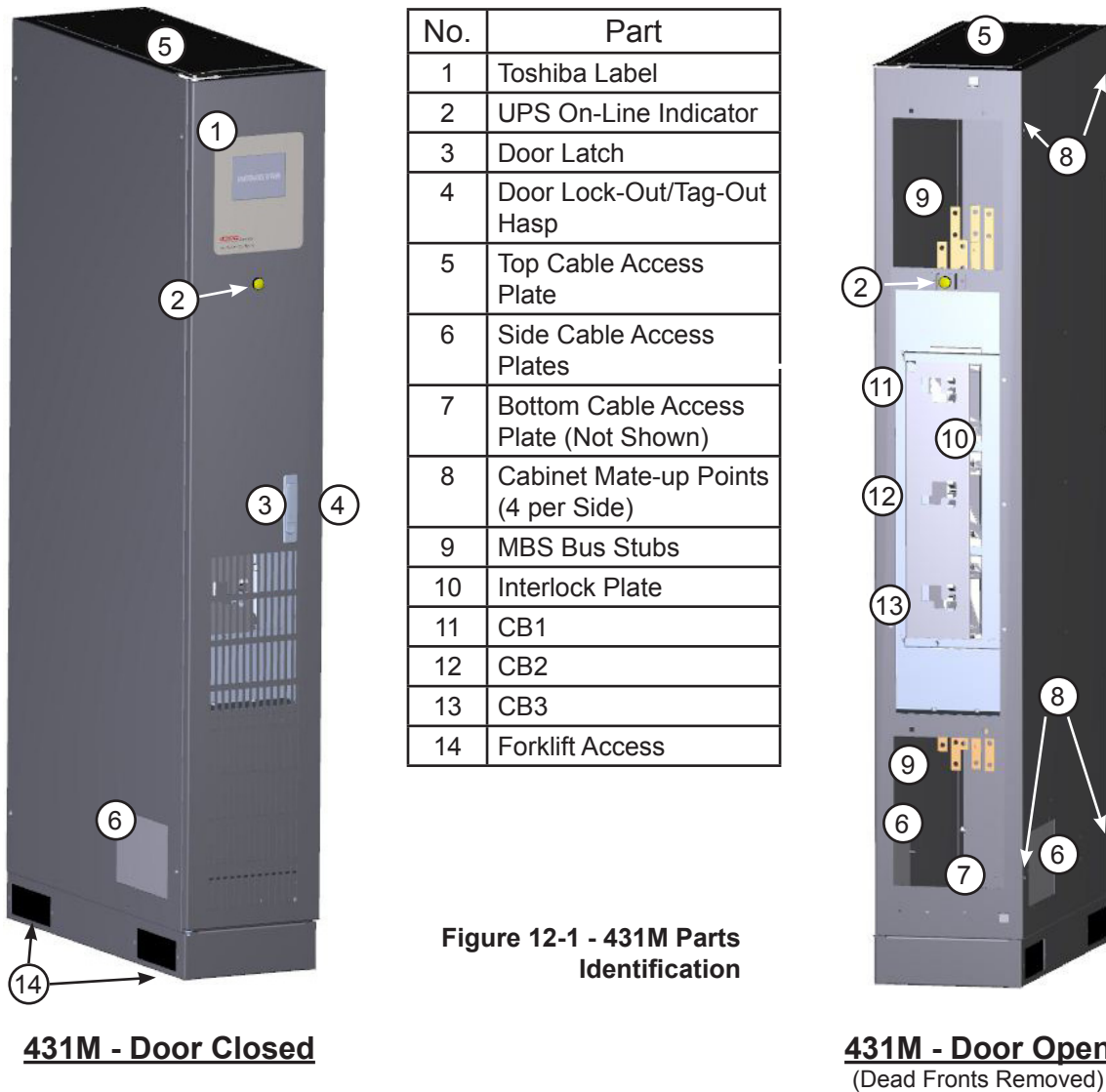

Figure 12-1 - 431M Parts Identification

12.1 431M Maintenance Bypass Switch (MBS) Options

(All cabinets are O'Brien Black (Textured))

MBS Cabinet Part Number*	UPS Capacity	Operating Voltage	# of Brkers	Safety Interlock
431M-	300 – 30 kVA 500 – 50 kVA	-F – 208/120 V	3	MS – Mechanical Interlock (Slide Bar) with Solenoid Release Unit. (Note: The solenoid locks the slide bar in

Example: **431M500-F3MS** is a floor-mount, 50kVA, 208/120V, Maintenance Bypass Switch with Slide-bar Mechanical Interlock.

Figure 12-1 and Figure 12-2 show the external and internal components of the 431M.

No.	Part
5	Top Cable Access Plate
6	Side Cable Access Plate (removed)
7	Bottom Cable Access Plate
9A	MBS Bus Stubs - Utility Input
9B	MBS Bus Stubs - UPS Input
9C	MBS Bus Stubs - UPS Output
9D	MBS Bus Stubs - Output to Load
11	CB1 (UPS Input Isolation Breaker)
12	CB2 (Bypass Breaker)
13	CB3 (UPS Output Isolation Breaker)
14	Forklift Access
15 ¹	Cable Anchor Tray - Cable Tie Points for Power Cable Strain Relief
16	Neutral Bus Strip
17	Ground Bus Strip
18	TB1 - (24Vdc Solenoid Lock Release for Interlock Plate (Fig. 10))

1 - Secure the cables with cable ties to the Cable Anchor Tray. This will provide strain relief for the upper power bus strips.

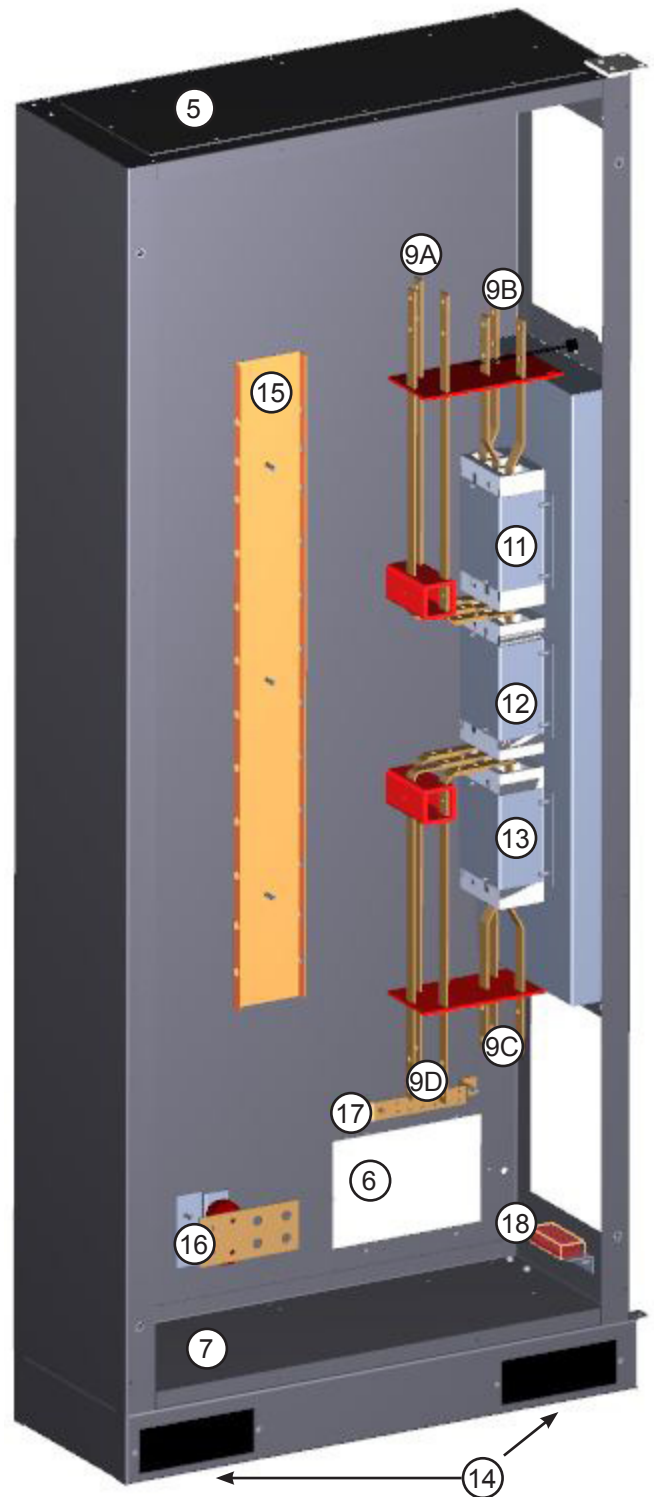

Figure 12-2 - 431M - Internal Arrangement
(Left Side Panel and Dead Fronts Removed)

12.2 EQUIPMENT WARNING LABELS

DO NOT attempt to install, operate, maintain or dispose of this equipment until you have read and understood all of the product warnings and user directions that are contained in this instruction manual.

Shown below are examples of warning labels that may be found attached to the equipment. **DO NOT** remove or cover any of the labels. If the labels are damaged or if additional labels are required, contact your TOSHIBA representative for additional labels.

The following are examples of the warning labels that may be found on the equipment. The labels are there to provide useful information or to indicate an imminently hazardous situation that may result in serious injury, severe property and equipment damage, or death if the instructions are not followed.

(A) 48082

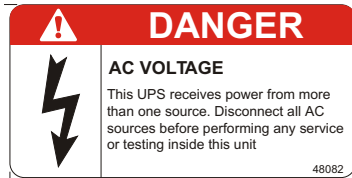
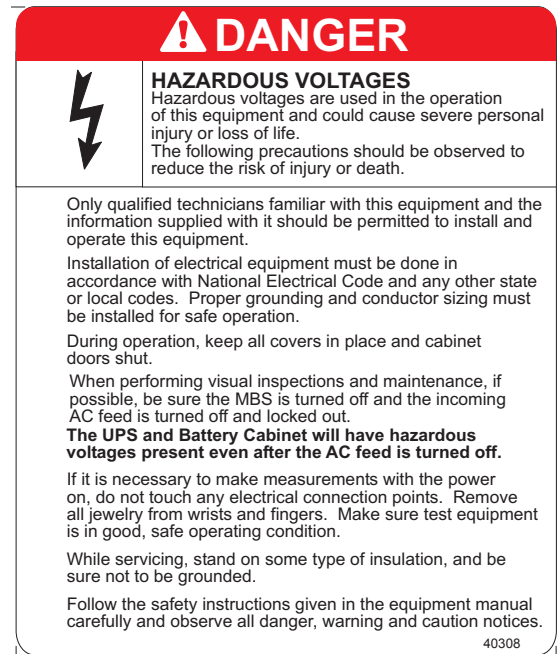

Figure 12-3 - 431M Cabinet Warning Labels

(B) 40308



12.3 IMPORTANT SAFETY INSTRUCTIONS

SAVE THESE INSTRUCTIONS

This manual contains important instructions that should be followed during the installation, maintenance, and operation of the MBS to assure safe and proper operation.

1. Turn off, lockout, and tagout all power sources before connecting the power wiring to the equipment or when performing maintenance.
2. Verify the MBS is de-energized before removing the cabinet dead fronts.
3. Verify cables and terminals are de-energized before installing cable in terminals.

Qualified Personnel ONLY!

Qualified Personnel is one that has the skills and knowledge relating to the construction, installation, operation, and maintenance of the electrical equipment and has received safety training on the hazards involved (Refer to the latest edition of NFPA 70E for additional safety requirements).

Qualified Personnel shall:

1. Have read the entire operation manual.
2. Be trained and authorized to safely energize, de-energize, ground, lockout and tag circuits and equipment, and clear faults in accordance with established safety practices.
3. Be trained in the proper care and use of protective equipment such as safety shoes, rubber gloves, hard hats, safety glasses, face shields, flash clothing, etc., in accordance with established safety practices.
4. Be trained in rendering first aid.

For further information on workplace safety visit www.osha.gov.

12.4 INSTALLATION INSTRUCTIONS



DANGER: HAZARDOUS VOLTAGES MAY EXIST.



Verify all power is removed from the UPS and power cables prior connecting the power cables to the Auxiliary Cabinet terminals, Maintenance Bypass Switch terminals, or UPS terminals.

The Toshiba Maintenance Bypass Cabinet (431M) can be used in either of two arrangements:

- 431M with the 4300 UPS,
- 431A with the 431M and the 4300 UPS.

431M with 431A and 4300 UPS

Select the proper cable size per Table 12.1.

Table 12.1 - 431M Input/Output Power Cable Sizes
(Cable sizes for 75°C Copper Cable)

Recommended/Maximum Wire size and Torque Requirement					
UPS Rating	Output Current	Ampacity (Four conductors in conduit)	Phase AWG*	Neutral AWG*	Tightening Torque
30 kVA	75 A	117	1 - 250 kcmil	3/0 - 350 kcmil	200 in.-lbs.
50 kVA	125 A	188	3/0 - 250 kcmil	350 kcmil	200 in.-lbs.

* Wire capacity for Phase lugs is 250 kcmil - 6 AWG, Neutral lugs is 350 kcmil - 6 AWG.

Terminate the cable end connecting to the 431M with 0.5 inch bolt hole terminal lugs. See Table 12.2 for recommended torque, and Table 12.3 for examples of NEMA 2-Hole terminations.

The 431M Circuit Breakers are equipped with terminal bus strips pre-drilled in a standard NEMA 2-hole pattern (0.5 in. bolt holes on 1.75 in. centers) to facilitate installation of power cables. Use of NEMA two-hole cable terminations is recommended.

Terminate the cable end connecting to the 431M with 0.5 inch bolt hole terminal lugs. See Table 12.2 below.

Table 12.2: Bolt Tightening Specifications

ITEM	Torque
Grade 8, 1/2 in. Bolts	119 ft-lb (161 N•M)

The following table lists examples of NEMA 2-hole compression type fittings.

Table 12.3: Suggested NEMA 2-Hole Compression Fittings

Ilsc P/N	Description	Conductor Size	Fitting Color
CLND-6-12-134 CSWD -6-12-134	Long Barrel Short Barrel	#6	Blue
CLND-4-12-134 CSWD -4-12-134	Long Barrel Short Barrel	#4	Grey
CLND-3-12-134	Long Barrel	#3	White
CLND-2-12-134 CSWD -2-12-134	Long Barrel Short Barrel	#2	Brown
CLND-1-12-134 CSWD -1-12-134	Long Barrel Short Barrel	#1	Green
CLND-1/0-12-134 CSWD -1/0-12-134	Long Barrel Short Barrel	1/0	Pink
CLND-2/0-12-134 CSWD -2/0-12-134	Long Barrel Short Barrel	2/0	Black
CLND-3/0-12-134 CSWD -3/0-12-134	Long Barrel Short Barrel	3/0	Orange
CLND-4/0-12-134 CSWD -4/0-12-134	Long Barrel Short Barrel	4/0	Purple
CLND-250-12-134 CSWD -250-12-134	Long Barrel Short Barrel	250	Yellow
CLND-300-12-134 CSWD -300-12-134	Long Barrel Short Barrel	300	White
CLND-350-12-134 CSWD -350-12-134	Long Barrel Short Barrel	350	Red

Go to Section **Place the 431A Cabinet.**

12.5 Place the 431M Cabinet

The 431M Cabinet has

- Four mounting bolt holes on the right side to secure the unit to the left side of the UPS. See Figure 12-5.
- Four corresponding mounting bolt holes on the left side to secure the unit to the right side of the Auxiliary Cabinet 431A, if available.
- Four mounting bolt holes on the base to anchor the unit to the floor. See Figure 12.4. Use 1/2 in (12 mm) bolt to anchor the unit.

Verify the Right Side Access Plate of the 431M and the corresponding left side access plate of the 4300 UPS is removed before securing the unit to the floor, UPS or 431A.

1. Locate the four mounting holes on the right side of the 431M.
2. Secure the 431M to the left side of the UPS using the four 3/8 in. -16 x 2 in. long bolts provided.
3. Thread the bolts into the pin-nuts in the UPS frame, and tighten to 70 +/- 10 in-lbs (7.9 +/- 1.2 Nm).

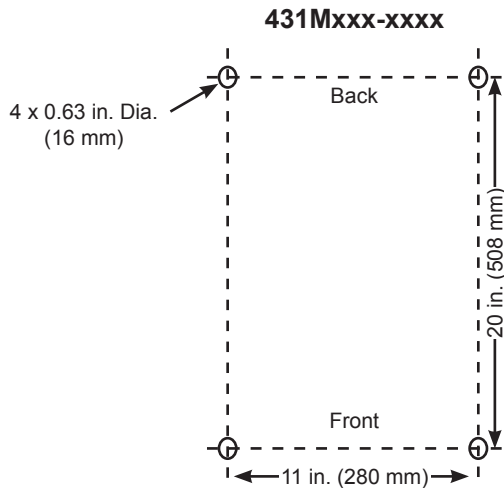

Figure 12-4 - Mounting Hole Locations/Dimension on UPS Base

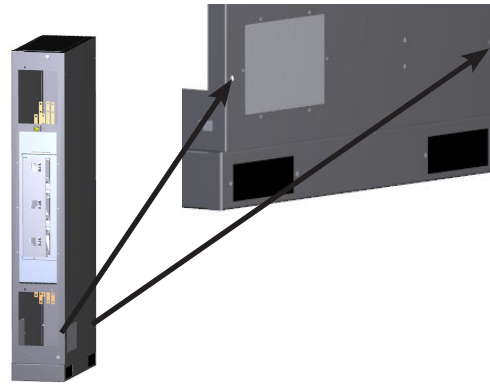

Figure 12-5 - 431M Lower Attach Points - Detail
(Upper Attach Points similar)

12.7 Join the 431A Cabinet with the 431M

The Toshiba Auxiliary Cabinet (431A) is equipped with four 14 mm mating holes located on the front and back of the left and right sides of the cabinet.



DANGER: HAZARDOUS VOLTAGES MAY EXIST.



Verify all power is removed from the UPS and power cables prior connecting the power cables to the Auxiliary Cabinet terminals, Maintenance Bypass Switch terminals, or UPS terminals.

1. Remove the top and bottom 431M Front panels.
2. Remove the cable access plate at the lower-front right side of the 431A Cabinet.
3. Remove the cable access plate at the lower-front left side of the 431M Cabinet.
4. Position the 431A cabinet to the left of and adjacent to the 431M Cabinet.
5. Align the four 16 mm bolt holes on the right side of the 431A Cabinet with the matching four 16 mm bolt holes on the left side of the 431M Cabinet.
6. Bolt the cabinets together with four 3/8-16 in. x 2 in. long bolts.
7. Secure the 431A base anchor bolts.
8. Select the power cables per Tables 12-1, 12-2, and 12-3.
 - Cable size for the UTILITY and LOAD terminals depend on the transformers Input/Output Voltages.
 - The UPS Input/Output cables will be the same size: 3Phase /4Wire 208/120V.
9. Run power cables from 431M bus stub terminals UTILITY IN to 431A TB1 - UPS IN terminals. (Fig. 12-7)
10. Run power cables from 431M bus stub terminals LOAD IN to 431A TB2 - UPS OUT terminals. (Fig. 12-7)
11. Run the appropriately sized power cables from 431A TB1 to the 431M From UTILITY (Figure 12-2 #9A), and 431A TB2 From UPS OUT (Figure 12-2 #9D), bus stubs per Figure 7.
12. Connect 431M UPS IN Bus Terminals (Figure 12-2 #9B) to UPS TB1 - UPS IN, per Figure 12-7.
13. Connect 431M UPS OUT Bus Terminals (Figure 12-2 #9C) to UPS TB1 - UPS OUT, per Figure 12-7.
14. Connect the Neutral cables to the 431M Neutral Bus stub, Figure 12-2 #16 and Figure 12-7.
15. Connect the Mechanical Interlock Solenoid power plug, TB1 P-1(Figure 12-2 #18) to the UPS 24V power terminal jack J1 in the UPS .
16. Connect the Ground wires (#2 AWG or better) to the ground bus, Figure 12-2 #17.
17. Verify the connections are correct.
18. Install the 431M top and bottom Dead Fronts.

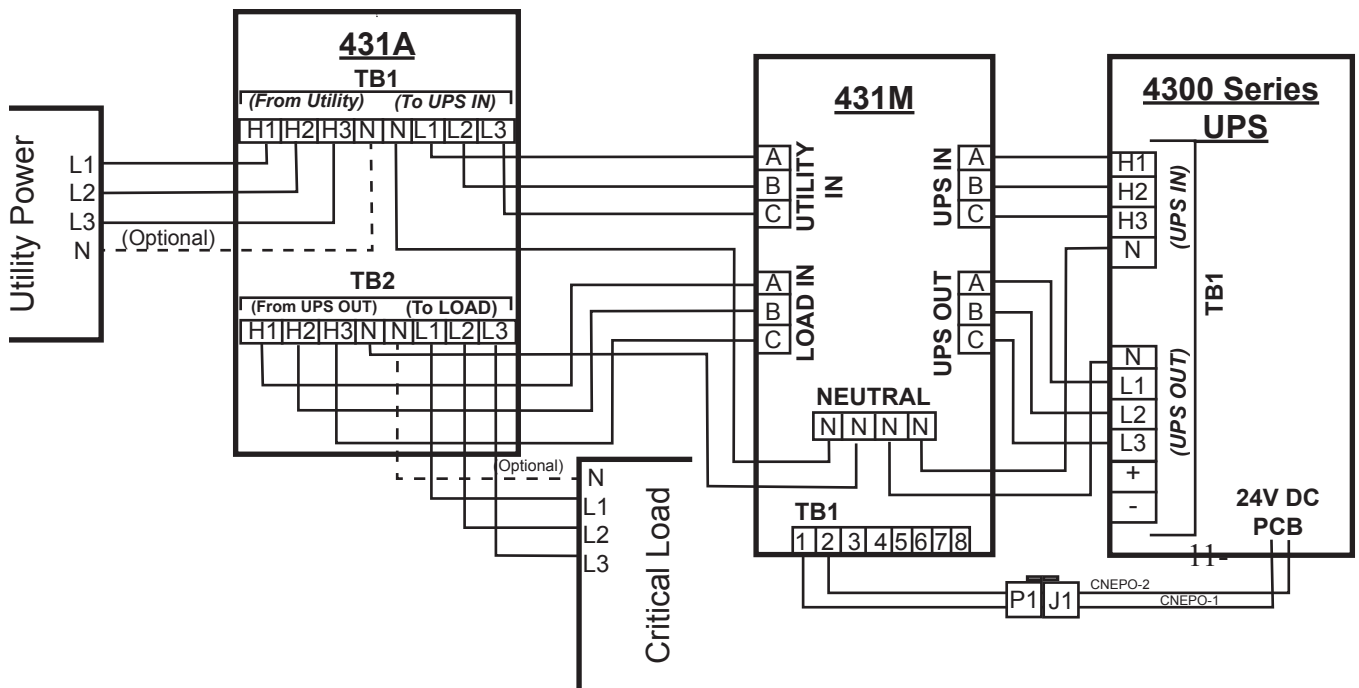

Figure 12-7 - Power Cabling Between Auxiliary Cabinet, MBS, and UPS

12.8 MBS Operation

Switch MBS from on-line to Bypass (Solid lines)

The 431M Mechanical Interlock Plate is locked in the On-Line position by a solenoid. When the UPS is placed in Static Bypass mode, the light on the front of the MBS lights and the interlock solenoid retracts and allows the Mechanical Interlock Plate to be moved. See Figure 12-8.

1. Place the UPS in static bypass. The Bypass indicator light on the 431M should illuminate and the interlock solenoid will retract.

NOTE: If the Bypass indicator light DOES NOT ILLUMINATE in bypass mode, contact Toshiba Field Service immediately.

2. Slide the Mechanical Interlock Plate to the center position as shown in Figure 12-8 B.
3. Switch CB2 ON (up) as shown in Figure 12-8 C.
4. Switch CB3 OFF (down) and CB1 OFF (down), as shown in Figure 12-8 D.
5. Slide the mechanical Interlock Plate to the left position as shown in Figure 12-8 E.
6. The circuit breakers are now locked in Maintenance Bypass position.

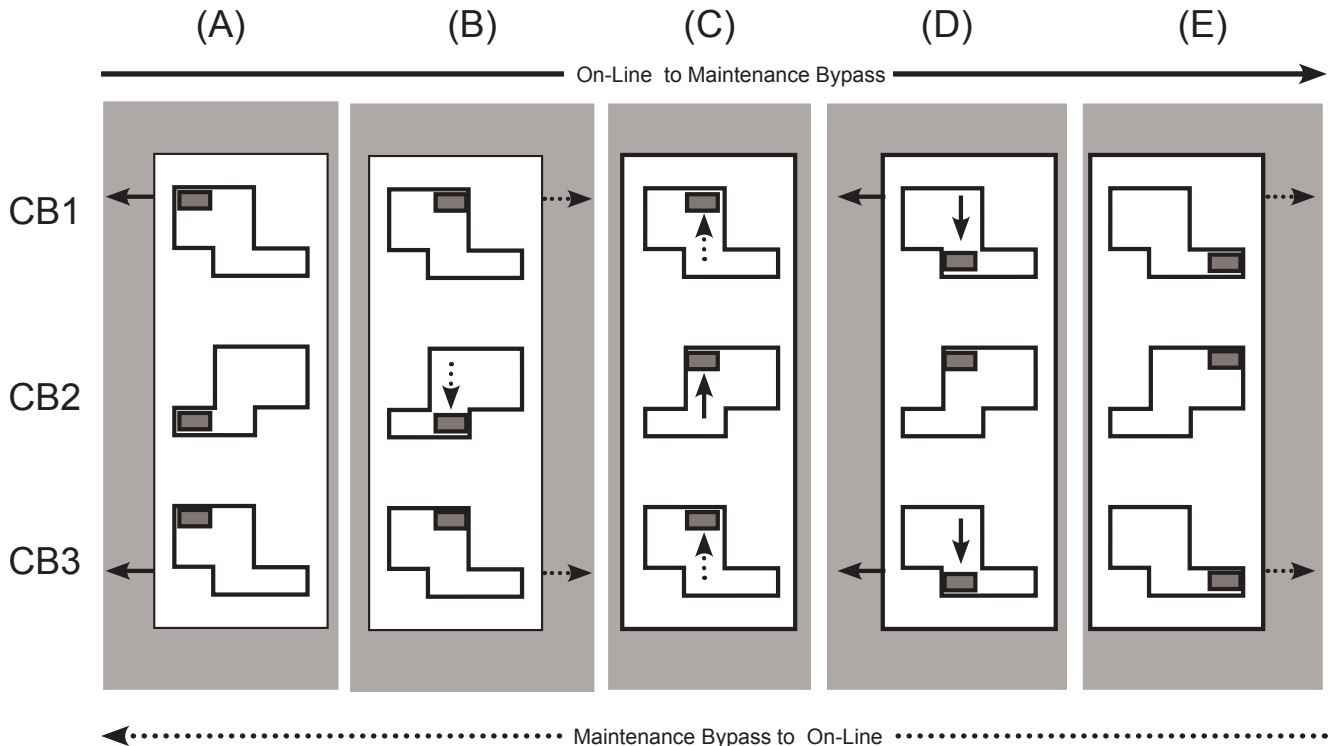

Figure 12-8 - MBS Mechanical Interlock Plate Operation

Switch MBS from Bypass to On-Line (Dotted lines)

1. The Maintenance Bypass position is shown in Figure 12-8 E. The UPS should be in static bypass mode, and the MBS indicator light should be illuminated.
2. Slide the mechanical Interlock Plate right to the Center position as shown in Figure 12-8 D.
3. Switch in order, CB1 ON (up), and CB3 ON (up) as shown in Figure 12-8 C.
4. Switch CB2 OFF (down), as shown in Figure 12-8 B.
5. Slide the mechanical Interlock Plate to the right position as shown in Figure 12-8 A.
6. Place the UPS in On-Line mode.
7. The MBS indicator light should extinguish, and the MBS solenoid locks the Mechanical Interlock Plate in place.

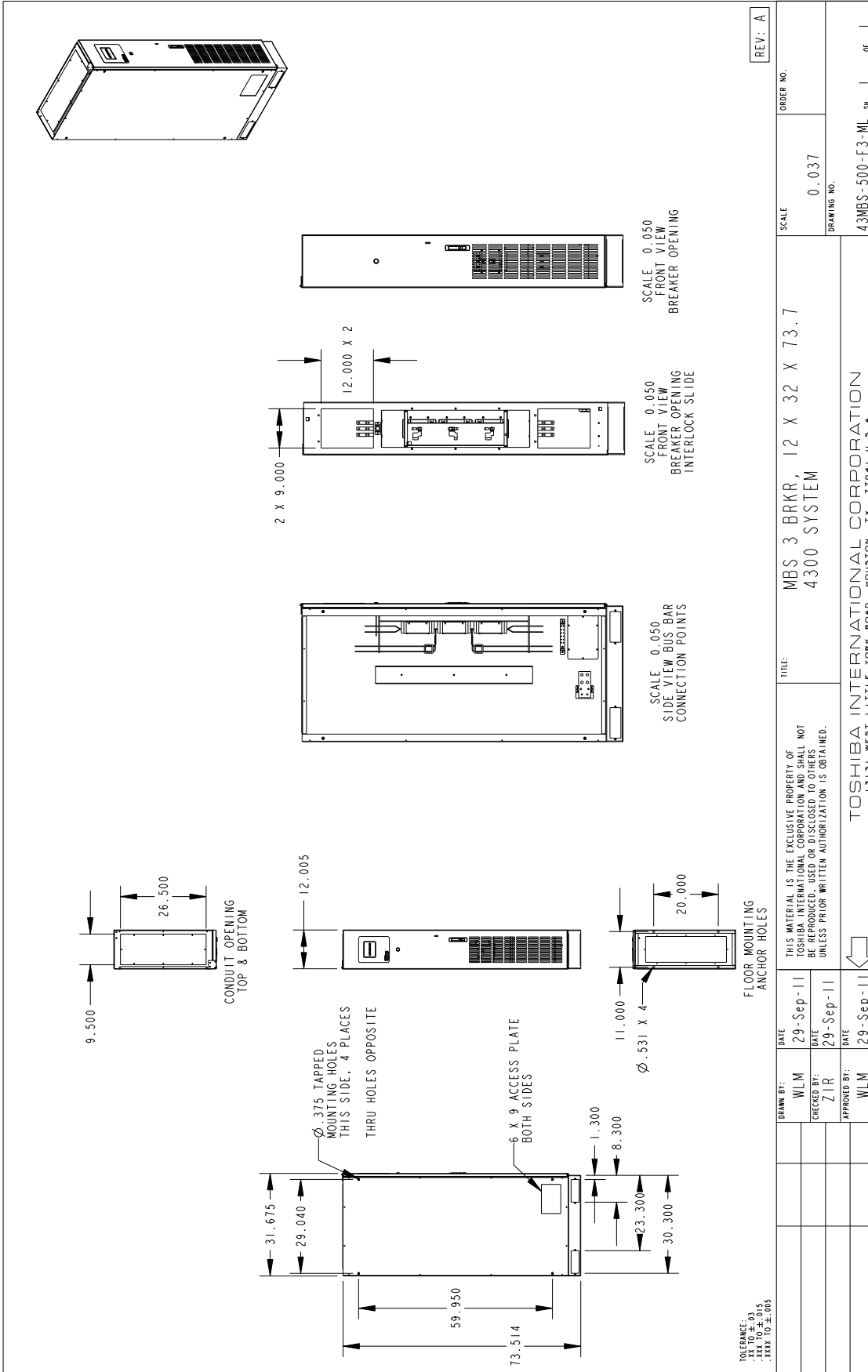

Figure 12-9 - 431M Cabinet Outline Drawing

13 Optional Kickplate Installation

Purpose

This Installation Guide shows how to correctly install the optional 4300 Series Kick Plates on the 4300 UPS, 431A Ancillary Cabinet, and the 431B Battery Cabinet. These instructions are also available in the Manuals for the respective cabinets.

Toshiba International Corporation reserves the right, without prior notice, to update information, make product changes, or discontinue any product or service identified in this publication.

Toshiba International Corporation shall not be liable for direct, indirect, special, or consequential damages resulting from the use of the information contained within this Installation Guide.

Box Contents

Part Number	4300-30/50-KP-A	4300-30/50-KP-B
Instruction Sheet (P/N 66597)	1	1
F/B (Front/Back) Kick Plate, 22 in.	2	2
Side Kick Plate, 30.5 in.	2	(None)
NOTES	Initial set of kick plates to enclose the base of one 4300 cabinet.	Add-on kick plates to enclose additional cabinets. The sides are moved to the outer sides outermost cabinets in the lineup.
	Both pair of kick plates are symmetrical - there is no upside down.	

Tools Required

None - The kick plates consist of the F/B panels that magnetically latch to the welded base of the 4300 Series cabinets and a second pair (sides) that magnetically latch to the F/B plates.

Installing 4300-30/50-KP-A

NOTE: Due to variations within manufacturing specifications, the spacing on the base channels may be slightly more or less than the separation between the magnetic latches of the kick plates.

To correct this the installer should bend the magnetic latch support tab slightly to ensure a snug fit to the base channels.

STEP 1: Fit the F/B Plates with the UPS C-channel skids.

- 1.1 Place a F/B kick plate on edge on the floor, magnetic latches side toward the UPS with the magnetic latch faces facing left. See Figure 13-1.
- 1.2 Place one in front and one at the back of the UPS.
- 1.3 Slide the front F/B kick plate forward until both magnet latches adhere to the left and right vertical C-channel base skid member.
- 1.4 If one of the magnets does not latch firmly, or the spacing is too narrow, bend one or the other of the magnetic latch supports in or out as required to ensure a good fit. See Figure 13-1.
- 1.5 Repeat Step 13-3 and 13-4 for the F/B kick plate at the back of the UPS.
- 1.6 Remove the F/B kick plates from the C-channel base skids.

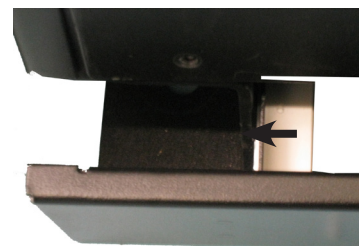

Left Base Skid



Right Base Skid

Figure 13-1

STEP 2: Slide Side Plates in along C-Channel base.

- 2.1 Facing the front of the UPS, slide a side kick plate with the smooth side facing out down along the left base C-channel skid until it is protruding about one inch in front of the UPS. See Figure 13-2.
- 2.2 Repeat for the right C-channel skid.

STEP 3: Align the F/B Plate with the UPS front.

Place a F/B kick plate on the floor as in Step 13-1. Angle the right edge out away from the UPS until the pair of front slots at the ends of the F/B kick plate are visible. See Figure 13-3.

STEP 4: Insert Side Plate tabs into F/B Plate slots.

Insert the side plate tabs into the F/B kick plate slots on the floor in front of the UPS, and then slide the right edge out until the pair of front slots at each end of the plate are visible. See Figure 13-3.

- 4.1 Carefully slide the F/B kick plate forward until the Side plate tabs are inserted in the F/B kick plate slots. (*NOTE - This is a snug fit.*)
- 4.2 Slide the right side of the F/B kick plate forward to engage the tabs of the right Side kick plate.
- 4.3 Slide the F/B kick plate forward until the left and right Side kick plate magnetic latches make contact with the F/B kick plate.
- 4.4 Slide the F/B kick plate back until it make contact with both the C-channel base skids.

STEP 5: Attach the rear F/B Plate to the back of the UPS

Repeat Step 4 for the F/B kick plate at the rear of the UPS.

Completion

When the kick plates are properly installed, the front panel will be nearly flush with the front (Figure 13-4). The side kick plate will be inset about a quarter inch from the vertical side plane (Figure 13-5), and the back F/B kick plate will extend out about a quarter inch beyond the vertical back plane of the UPS (Figure 13-6).

Figure 13-4

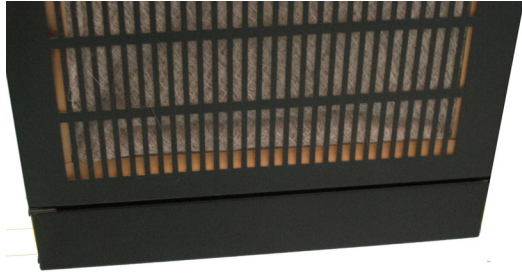

Front Kick Plate

Figure 13-5



Side Kick Plate

Figure 13-6



Back Kick Plate

Installing 4300-30/50-KP-B

The 4300-30/50-KP-B Kick Plate Kit contains one pair of F/B kick plates. This kit is required for each standard additional 4300 Series add on frame, such as the 431A and 431B. The 431M is already provided with a base skirt.

NOTE: Due to variations within manufacturing specifications, the spacing on the base channels may be slightly greater of less than the separation between the magnetic latches of the kick plates.

To correct this the installer should bend the magnetic latch support tab slightly to ensure a snug fit to the base channels.

STEP 1: Move Side Plates to outer-most C-channel base

Move the Side kick plates to the the outer sides of the assembled 4300 Series units. See Figure 13-7, 13-8.

STEP 2: Install the F/B Plates

Install the F/B kick plates as described on Pages 50-52.

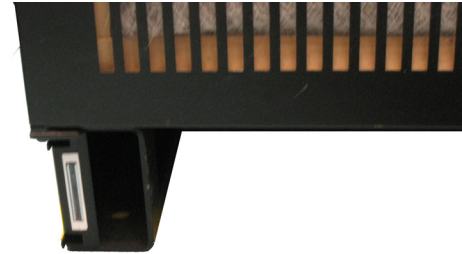

Figure 13-7

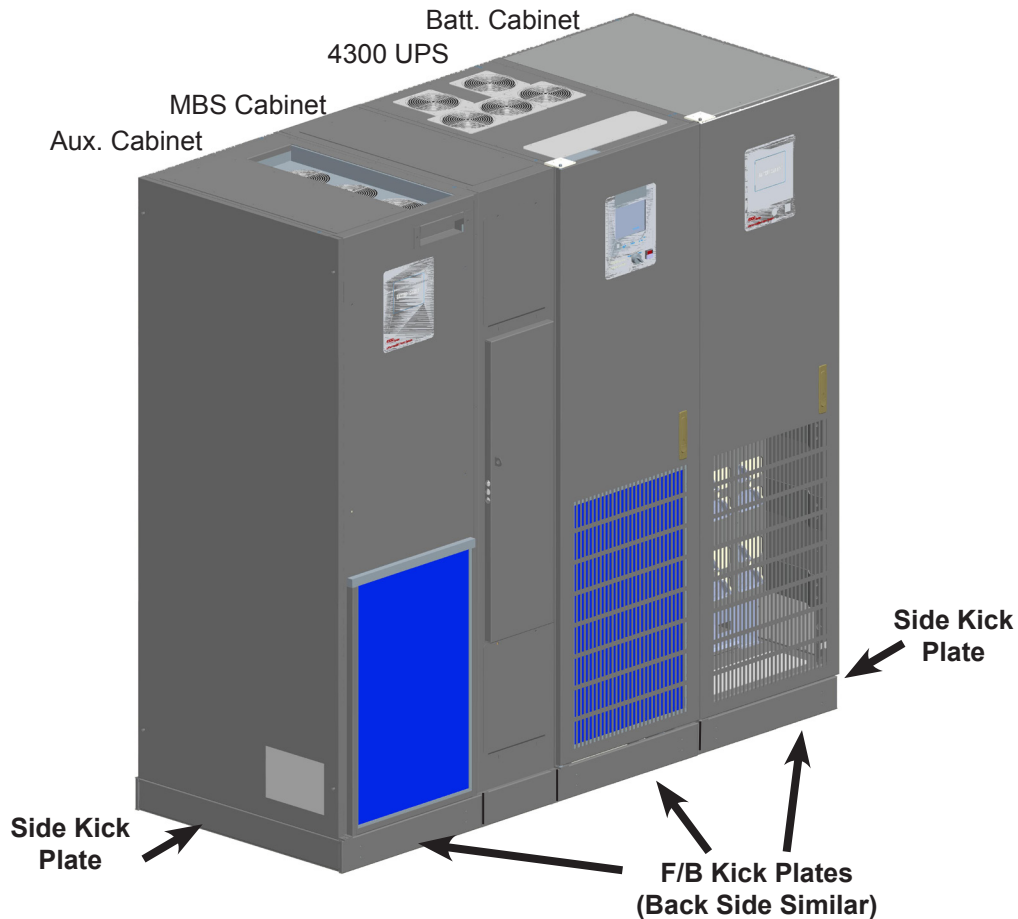

Figure 13-8

14 External Layouts/Dimensions

Dimensional Data

Table 14.1 - External Dimensions

EXTERNAL DIMENSIONS			
Unit	Height	Width	Depth
431A	73.7 in. (1872 mm)	22.1 in. (561 mm)	30.7 in. (779 mm)
431B	73.7 in. (1872 mm)	22.1 in. (561 mm)	30.7 in. (779 mm)
431M	73.7 in. (1872 mm)	12.0 in. (304 mm)	30.7 in. (779 mm)

Electrical Conduit Knock-out Data

Table 14.2 - Conduit Access Ports

CABLE ACCESS OPENING SIZES (30/50KVA)		
	Left/Right Side	Top/Bottom
431A 431B	6 in. (152 mm) x 9 in. (229 mm)	4.75 in. (121 mm) x 16.5 in. (419 mm)
431M	6 in. (152 mm) x 9 in. (229 mm)	8 in. (203 mm) x 25 in. (635 mm)

TOSHIBA

TOSHIBA INTERNATIONAL CORPORATION

INDUSTRIAL DIVISION

13131 West Little York Road, Houston, Texas 77041

Tel. (713) 466-0277 Fax. (713) 466-8773

US (800) 231-1412 Canada (800) 872-2192 Mexico 01/800/527-1204

www.Toshiba.com/ind

Printed in the U.S.A.

Free Manuals Download Website

<http://myh66.com>

<http://usermanuals.us>

<http://www.somanuals.com>

<http://www.4manuals.cc>

<http://www.manual-lib.com>

<http://www.404manual.com>

<http://www.luxmanual.com>

<http://aubethermostatmanual.com>

Golf course search by state

<http://golfingnear.com>

Email search by domain

<http://emailbydomain.com>

Auto manuals search

<http://auto.somanuals.com>

TV manuals search

<http://tv.somanuals.com>