

TOSHIBA



HDD/DVD VIDEO RECORDER

RD-XS35SU RD-XS35SC

OWNER'S MANUAL



**INSTALLATION
GUIDE**

Read this booklet first.



Introduction

Connections

Basic setup

SAFETY PRECAUTIONS

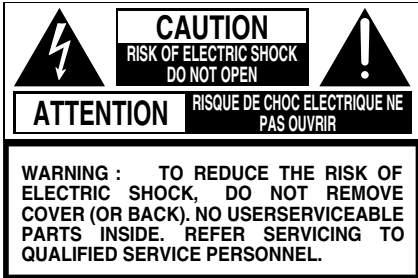

The lightning flash with arrowhead symbol, within an equilateral triangle, is intended to alert the user to the presence of uninsulated "dangerous voltage" within the product's enclosure that may be of sufficient magnitude to constitute a risk of electric shock to persons.



The exclamation point within an equilateral triangle is intended to alert the user to the presence of important operating and maintenance (servicing) instructions in the literature accompanying the appliance.



The symbol for CLASS II (Double Insulation)

WARNING: TO REDUCE THE RISK OF FIRE OR ELECTRIC SHOCK, DO NOT EXPOSE THIS APPLIANCE TO RAIN OR MOISTURE. DANGEROUS HIGH VOLTAGES ARE PRESENT INSIDE THE ENCLOSURE. DO NOT OPEN THE CABINET. REFER SERVICING TO QUALIFIED PERSONNEL ONLY.

CAUTION: TO PREVENT ELECTRIC SHOCK, MATCH WIDE BLADE OF PLUG TO WIDE SLOT, FULLY INSERT.

ATTENTION: POUR EVITER LES CHOCES ELECTRIQUES, INTRODUIRE LA LAME LA PLUS LARGE DE LA FICHE DANS LA BORNE CORRESPONDANTE DE LA PRISE ET POUSSER JUSQU'AU FOND.

CAUTION: This HDD/DVD video recorder employs a Laser System. To ensure proper use of this product, please read this owner's manual carefully and retain for future reference. Should the unit require maintenance, contact an authorized service location - see service procedure.

Use of controls or adjustments or performance of procedures other than those specified herein may result in hazardous radiation exposure.

To prevent direct exposure to laser beam, do not try to open the enclosure. Visible and invisible laser radiation when open and interlocks defeated. DO NOT STARE INTO BEAM.

FCC NOTICE: This equipment has been tested and found to comply with the limits for a Class B digital device, pursuant to part 15 of the FCC Rule. These limits are designed to provide reasonable protection against harmful interference in a residential installation.

This equipment generates, uses, and can radiate radio frequency energy and, if not installed and used in accordance with the instructions, may cause harmful interference to radio communications.

However, there is no guarantee that interference will not occur in a particular installation. If this equipment does cause harmful interference to radio or television reception, which can be determined by turning the equipment off and on, the user is encouraged to try to correct the interference by one or more of the following measures:

- Reorient or relocate the receiving antenna.
- Increase the separation between the equipment and receiver.
- Connect the equipment into an outlet on a circuit different from that to which the receiver is connected.
- Consult the dealer or an experienced radio/TV technician for help.

WARNING: Changes or modifications made to this equipment, not expressly approved by Toshiba, or parties authorized by Toshiba, could void the user's authority to operate the equipment.

Note to cable system installer:

This reminder is provided to call the cable system installer's attention to Article 820-40 of the NEC that provides guidelines for proper grounding and, in particular, specifies that the cable ground shall be connected to the grounding system of the building, as close to the point of cable entry as practical.

The instructions shall state that an ALL-POLE MAINS SWITCH with a contact separation of at least 3 mm in each pole shall be incorporated in the electrical installation of the building.

CAUTION: These servicing instructions are for use by qualified service personnel only. To reduce the risk of electric shock do not perform any servicing other than that contained in the operating instructions unless you are qualified to do so.

In the spaces provided below, record the Model and Serial No. located on the rear panel of your recorder.

Model No. _____ Serial No. _____

Retain this information for future reference.

Location of the required label

PRODUCT IS CERTIFIED BY THE
MANUFACTURER TO COMPLY
WITH DHHS RULE 21 CFR
SUBCHAPTER J IN EFFECT AT
DATE OF MANUFACTURE.

TOSHIBA CORPORATION

1-1, SHIBAURA 1-CHOME, MINATO-KU,
TOKYO 105-8001, JAPAN

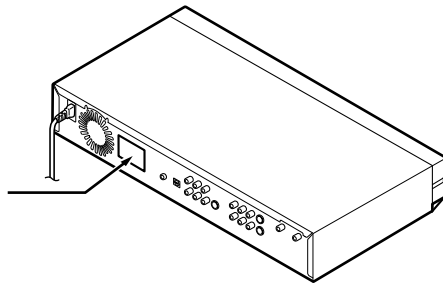

IMPORTANT SAFETY INSTRUCTIONS

1. Read these instructions.
2. Keep these instructions.
3. Heed all warnings.
4. Follow all instructions.
5. Do not use this apparatus near water.
6. Clean only with dry cloth.
7. Do not block any ventilation openings. Install in accordance with the manufacturer's instructions.
8. Do not install near any heat sources such as radiators, heat registers, stoves, or other apparatus (including amplifiers) that produce heat.
9. Do not defeat the safety purpose of the polarized or grounding-type plug. A polarized plug has two blades with one wider than the other. A grounding type plug has two blades and a third grounding prong. The wide blade or the third prong are provided for your safety. If the provided plug does not fit into your outlet, consult an electrician for replacement of the obsolete outlet.
10. Protect the power cord from being walked on or pinched particularly at plugs, convenience receptacles, and the point where they exit from the apparatus.
11. Only use attachments/accessories specified by the manufacturer.
12. Use only with the cart, stand, tripod, bracket, or table specified by the manufacturer, or sold with the apparatus. When a cart is used, use caution when moving the cart/apparatus combination to avoid injury from tip-over.
13. Unplug this apparatus during lightning storms or when unused for long periods of time.
14. Refer all servicing to qualified service personnel. Servicing is required when the apparatus has been damaged in any way, such as power-supply cord or plug is damaged, liquid has been spilled or objects have fallen into the apparatus, the apparatus has been exposed to rain or moisture, does not operate normally, or has been dropped.



ADDITIONAL SAFETY INSTRUCTIONS

15. Do not overload wall outlets; extension cords, or integral convenience receptacles as this can result in a risk of fire or electric shock.
16. Apparatus should not be exposed to dripping or splashing and no objects filled with liquids, such as vases, should not be placed on the apparatus.
17. Keep your fingers well clear of the disc tray as it is closing. Neglecting to do so may cause serious personal injury.
18. Do not place anything on top of this unit.
19. Do not place the apparatus on amplifiers or equipment that may produce heat.
20. Do not cover the ventilating holes for the inside cooling fan.
21. Do not use a cracked, deformed, or repaired disc. These discs are easily broken and may cause serious personal injury and apparatus malfunction.
22. If the apparatus should smoke or smell, immediately disconnect the power cord from the wall outlet. Wait until the smoke or smell stops, then ask your dealer for a check and repair. Neglecting to do so may cause fire.
23. During thunderstorms, do not touch the connecting cables or the apparatus.
24. The apparatus includes lead, an ingredient of solder used on the PCB, which is a harmful substance to human and the environment. When disposing of this apparatus, follow the rules and regulations in your area.

Precautions

Notes on handling

- Never disconnect the power cord from a wall outlet while the recorder is not in standby mode, unless it is in an emergency. Doing so may cause malfunction.
- When shipping the recorder, the original shipping carton and packing materials come in handy. For maximum protection, repack the unit as it was originally packed at the factory.
- Do not use volatile liquids, such as insect spray, near the recorder. Do not leave rubber or plastic products in contact with the recorder for a long time. They will leave marks on the finish.
- The top and rear panels of the recorder may become warm after a long period of use. This is not a malfunction.

When not in use

- For usual absence
Be sure to remove the disc from the recorder and turn off the power.
- Prolonged absence
Unplug the recorder from a wall outlet.

Notes on locating

- Place the recorder on a level surface. Do not use it on a shaky or unstable surface such as a wobbly table or inclined stand. The loaded disc may dislodge from its proper position and cause damage to the recorder. Before placing the recorder, make sure that the surface can stand the weight of the recorder. Never place the recorder in a high location to avoid damage to the product or person by an accidental fall of the recorder.
- When you place this recorder near a TV, radio, or VCR, the playback picture may become poor and the sound may be distorted depending on the condition and location of said equipment. In such an event, place the recorder as far away much as possible from the TV, radio, or VCR.
- To avoid damage to this product, never place or store the unit in direct sunlight; hot, humid areas; or areas subject to excessive dust, oily smoke, cigarette smoke or vibration.

Notes on cleaning

Use a soft, dry cloth for cleaning.

- Do not use any type of solvent, such as thinner or benzine, as they may damage the surface of the recorder.

Notes on antennas

- Image and sound quality depend very much on signal reception.
- Reception may be poor in weak signal areas. In this event, consult your dealer, or purchase a commercially available antenna booster. Refer to the booster's instruction manual for installation details.

Notes on recording and editing

- When you record/edit important content, make trial operations beforehand to confirm the recorder can function properly.
Toshiba does not compensate for content which was not recorded/edited because of some malfunction of this product or discs during operation, and is not liable for incidental damages (such as profit loss or interruption of business, etc.) produced in such conditions.
- When the power cord is disconnected or when a power failure occurs during any operation of this product, all contents recorded in this recorder may be erased.
- Depending on the channel or program, an excessive sound input level may cause noise or cut of recorded sound. Adjust the initial setting of the recording level when necessary.
- If a program you have set a timer recording includes copy restriction signals, it may not be recorded. When programming a recording, confirm that a program you want to record is not copy-restricted.

Exemptions

- Toshiba is not liable for any damage caused by fires, natural disaster (such as thunder, earthquake, etc.), acts by third parties, accidents, owner's intentional or unintentional misuse, or uses in other improper conditions.
- Toshiba is not liable for incidental damages (such as profit loss or interruption in business, modification or erasure of recorded data, etc.) caused by use or inability to use of this product.
- Toshiba is not liable for any damage caused by neglect of the instructions described in the owner's manual.
- Toshiba is not liable for any damage caused by misuse or malfunction through simultaneous use of this product and the connected equipment or software that Toshiba is not concerned with.
- Toshiba does not compensate for contents which were not recorded/edited because of some malfunctions of this product or discs during operation, and is not liable for incidental damages (such as profit loss or interruption in business, etc.) produced by such conditions.

Power outage

- After a power outage the clock display will flash. Set the clock to the correct time.

Notes on the unit and the HDD

- Do not give a shock or shake (especially during operation).
- Do not use in a shaky or unstable location.
- Hold the unit horizontally.
- Do not cover the ventilation holes for the cooling fan of the unit.
- Do not use in a place where the temperature rises or changes rapidly.
- Do not disconnect the power plug from a wall outlet while the unit is turned on.
- Do not disconnect the power plug from the wall outlet or break the power supply to the unit during recording or playing. Before disconnecting the power plug, be sure to press the power button and make sure the unit ends the finishing process and power turns off (standby mode). If the power plug is disconnected or power supply is disrupted while the unit is recording, all recorded content will be erased.
- Toshiba is not liable for any damage or loss of recorded data caused by shock, shakes, misoperation or malfunction.

Notes on moisture condensation

Moisture condensation damages the unit. Please read the following carefully.

Moisture condensation occurs, for example, when you pour a cold drink into a glass on a warm day. Drops of water form on the outside of the glass. In the same way, moisture may condense on the optical pick-up lens inside this unit, one of the most crucial internal parts of the unit.

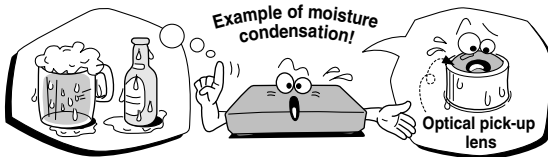

■ **Moisture condensation occurs during the following cases.**

- When you bring the unit directly from a cold place to a warm place.
- When you use the unit in a room where you just turned on the heater, or a place where the cold wind from the air conditioner directly hits the unit.
- In summer, when you use the unit in a hot and humid place just after you move the unit from an air conditioned room.
- When you use the unit in a humid place.

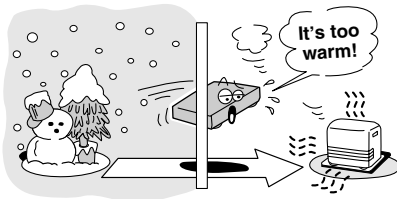

■ **Do not use the unit when moisture condensation may occur.**

If you use the unit in such a situation, it may damage discs and internal parts. Connect the power cord of the unit to the wall outlet, turn on the unit, remove the disc, and leave it for two or three hours. After two or three hours, the unit will have warmed up and evaporated any moisture. Keep the unit connected to the wall outlet and moisture condensation will seldom occur.

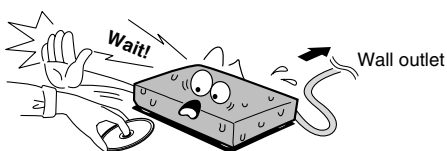

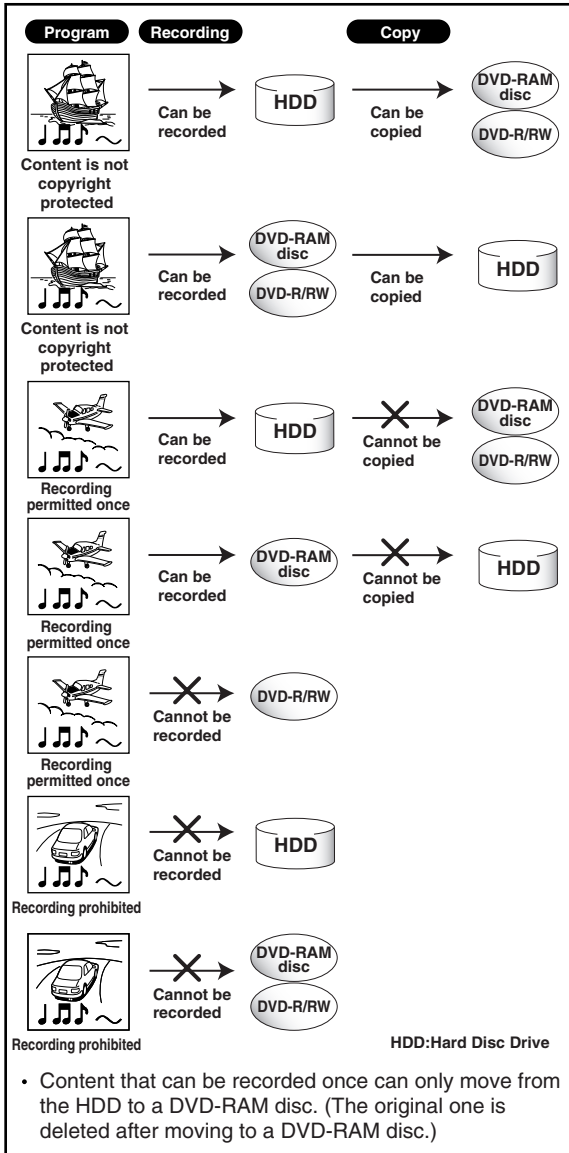

In the United States, TV Guide and other related marks are registered marks of Gemstar-TV Guide International, Inc. and/or one of its affiliates. In Canada, TV Guide is a registered mark of Transcontinental Inc., and is used under license by Gemstar-TV Guide International, Inc.

The TV Guide On Screen system is manufactured under license from Gemstar-TV Guide International, Inc. and/or one of its affiliates.

The TV Guide On Screen system is protected by one or more of the following issued United States patents 6,498,895; 6,418,556; 6,331,877; 6,239,794; 6,154,203; 5,940,073; 4,908,713; 4,751,578; 4,706,121.

Manufactured under license from QSound Labs, Inc. U.S. patent Nos. 5,105,462, 5,208,860 and 5,440,638 and various foreign counterpart. Copyright QSound Labs, Inc. 1998-2002. QXpander™ is a trademark of QSound Labs, Inc. All rights reserved.

Installation procedure

Read carefully “SAFETY PRECAUTIONS”,
“IMPORTANT SAFETY INSTRUCTIONS” and
“Precautions”.

(➡ pages 2 to 9)

Check the supplied accessories.
(See right)

Load the batteries in the remote control.

(➡ page 18)

Connect an antenna to the recorder.

(➡ page 20)

Connect a cable box or satellite system to the recorder.

(➡ pages 22 to 25)

Connect the recorder to a TV.

(➡ pages 20 to 21, 26)

Connect optional equipment to the recorder.

(➡ page 27)

Set up the TV Guide On Screen® interactive
program guide. (➡ page 32)

Your recorder is ready. Read the separate
volume “OPERATIONS GUIDE”.

Accessories

Remote control
Batteries (AAA) x 2

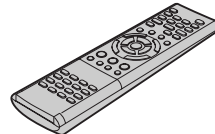

Coaxial cable

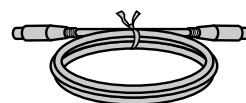

Video/Audio cable

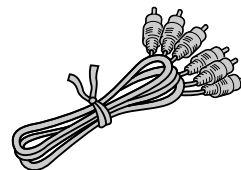

G-LINK® cable

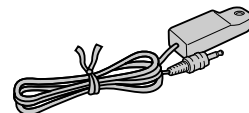

- Owner's manual (INSTALLATION GUIDE)
- Owner's manual (OPERATIONS GUIDE)

About this product

Some differences

Because of its recording capacity and hard disc drive (HDD), this DVD recorder operates more like a computer and differently than a standard DVD player. In addition to containing a microprocessor, it contains a HDD, an operating system, random access memory (RAM), and a DVD-RAM/R/RW drive. The operating system includes software stored on the HDD that is transferred to the RAM when the machine is turned on and at other times during operation. This transfer can take time. Therefore, when you turn the DVD recorder on, it may take a little while before it is ready to use. Likewise, other functions may not be performed as quickly as they would on other AV equipment. Additionally, because programs stored on the DVD-RAM/R/RW drive cannot be accessed as quickly as those stored on the HDD, accessing those programs (or deleting a program from a DVD-RAM disc) may take more time. Please take these factors into consideration as you use the DVD recorder.

About the hard disc drive (HDD)

Like any HDD, the HDD in the DVD recorder is a fragile device that is susceptible to partial or complete failure if it is jarred or as a result of use over time. It will not last forever. Therefore, do not use the HDD for longer term storage of programs you wish to retain. [If portions of the HDD become damaged, programs recorded on those portions may exhibit pixelization or block noise when played back. Repeated playback of the program may cause the problem to get worse and, eventually, the program may become unplayable. Accordingly, if you notice such noise in a program that you want to save, you should transfer to a recordable DVD disc as soon as possible.] Recordable DVD discs are also susceptible to damage if not handled and stored carefully and some or all of the programs on them may become unplayable. You can reduce these risks by using high quality DVD recordable discs and checking their playability from time to time. If it becomes necessary to service your DVD recorder, it may be necessary to delete some or all of the programs on the HDD.

Playback Restrictions

This owner's manual explains the basic instructions for this recorder. Some DVD video discs are produced in a manner that allows specific or limited operation during playback. As such, the recorder may not respond to all operating commands. This is not a defect in the recorder. Please refer to the notes on compatible discs later in this Introduction and to the discussion of DVD playback and features later in this manual.

“Ⓢ” may appear on the TV screen during operation. “Ⓢ” means that the operation is not permitted by the recorder or the disc.

Recording Restrictions and Copyright

Copy-protected contents of DVD-Video discs, VIDEO CDs or audio CDs on the market cannot be copied on this recorder. Contents without copy protection should be copied or edited only in accordance with applicable copyright laws, which may restrict copying or editing. Contents that permit single copying (copy once contents) can be recorded onto DVD-RAM discs, with some dubbing and editing restrictions. DVD-R/RW discs cannot record these contents.

The unauthorized recording, use, distribution, or revision of copyrighted materials including, without limitation, television programs, videotapes, and DVDs, is prohibited under the Copyright Laws of the United States and other countries, and may subject you to civil and criminal liability.

Compatibility

In isolated cases, a disc bearing the DVD or CD logo may not fully and properly play back all features or as intended by the creator of the disc. This can be due, among other reasons, to problems and errors that can occur during the creation or recording of DVD and other software and the manufacture of software discs (including blank discs). Moreover, because of variations in the quality of discs, this recorder may not be able to record on all discs that bear a DVD-RAM, DVD-R or DVD-RW logo, but you should not encounter difficulty if you use only high quality recordable DVD discs. Additionally, discs recorded in this device may not operate properly in other DVD players, recorders and/or personal computer drives. If you happen to encounter difficulties playing or recording a DVD disc or playing a CD disc, please feel free to call our Customer Service Hotline at 1-800-319-6684.



Choosing a disc

When you want to play DVD or CD software or copy programs from the HDD to a recordable DVD, load an appropriate disc into the recorder. There are many types and formats of discs. Please use the following information to select an appropriate disc.

Notes

- Handle the disc according to the disc instruction manual.
- Toshiba cannot guarantee that all discs bearing the DVD or CD logos will operate as expected. Additionally, Toshiba cannot guarantee that discs recorded in this device will operate properly in other DVD players, recorders and/or personal computer drives.

For recording / playback

Disc	Mark	Specification	Remarks
DVD-RAM		<ul style="list-style-type: none"> • Single sided 4.7GB (12cm (4³/₄ in.)) • Double sided 9.4GB (12cm (4³/₄ in.)) 	<p>Read carefully the section “On DVD-RAM discs” (➡ page 14).</p> <p>Select a DVD-RAM disc that shows a statement on its package such as “this disc can be used with video recorders and drives compatible with 4.7GB DVD-RAM discs” or “this disc can copy images that permit single copying.”</p>
DVD-R		<ul style="list-style-type: none"> • 4.7GB For General Ver.2.0 (12cm (4³/₄ in.)) 	<p>Read carefully the section “On DVD-R discs” (➡ page 15).</p> <p>Depending on the disc status or the recording equipment, playback of the disc may not be possible on this recorder.</p>
DVD-RW		<ul style="list-style-type: none"> • Ver. 1.1 or later (12cm (4³/₄ in.)) 	<p>Read carefully the section “On DVD-RW discs” (➡ page 15).</p> <p>Depending on the disc status or the recording equipment, playback of the disc may not be possible on this recorder.</p>

Using different disc types for different purposes

DVD-RAM discs for your personal library

DVD-RAM discs comply with the global standard DVD-VR (Video Recording) format, and are optimized for recording of TV programs. You can rewrite repeatedly without deterioration of an image quality, erase unnecessary parts, divide a chapter, or specify playback area by frame. Its cartridge is suitable for a longer-term storage and family use, and its large capacity of 9.4 GB allows more recording space.

DVD-R/RW discs when creating your own original discs for distribution

DVD-R discs are designed to comply with the global standard DVD-Video format, and can be recorded only once. DVD-R discs are convenient when you edit your original content (recorded personal events such as a wedding party) with this recorder, transfer them to the recorder and make copies to send to your friends or relatives. The discs can be played on other compatible DVD players. DVD-RW discs, which are rewritable, can be used as well.











* DVD-R and DVD-RW may not be the best suited format for recording TV programs. Because of the way the discs are formatted, it may not be possible to edit or divide the program as you may prefer, to record secondary languages, or programs that are copy protected in a way that allows only one copy. (NOTE: “Copy once” protected programs generally can be recorded to DVD-RAM discs.)



* This recorder records on a DVD-R/RW disc in DVD-Video format only.

* On DVD-R/RW discs, direct recording, copying or the method “Creating a DVD-Video using DVD-R/RW” (➡ page 112 in “OPERATIONS GUIDE”) are available.

We cannot guarantee that DVD-RAM/R/RW discs recorded on this recorder will be playable on all DVD recorders/players. Similarly, there is no guarantee that all DVD-RAM/R/RW discs recorded on other recorders will be playable on this recorder.

For playback only

Disc	Mark	Specification	Remarks
DVD video disc	 	<ul style="list-style-type: none"> • 12cm (4³/₄ in.) / 8cm (3¹/₄ in.) • Region number  or  <ul style="list-style-type: none"> • Color system: NTSC 	The region number of this DVD recorder is 1. If region numbers, corresponding to a specific playable area, are printed on your DVD video disc and you do not find  or  , or the disc is encoded to permit playback only in regions other than Region 1, disc playback will not be allowed by the recorder.
VIDEO CD		<ul style="list-style-type: none"> • 12cm (4³/₄ in.) / 8cm (3¹/₄ in.) • Color system: NTSC • Version 1.1 and 2.0 	
Audio CD		<ul style="list-style-type: none"> • 12cm (4³/₄ in.) / 8cm (3¹/₄ in.) 	
CD-R		<ul style="list-style-type: none"> • 12cm (4³/₄ in.) • CD-DA (audio CD) format 	Depending on the disc status, playback may not be possible.
CD-RW			

- You cannot play discs other than those listed above.
- You cannot play non-standardized discs even if they may be labeled as above.
- You cannot play discs with specialized encoding (such as SACD discs) or the DVD audio extensions of DVD Audio discs.
- This recorder uses the NTSC color system, and cannot play DVD video discs recorded in any other color system (PAL, SECAM, etc.), even if they have region marks  or .
- Toshiba cannot guarantee that all discs bearing the DVD or CD logos will operate as expected. Please see the discussion of compatibility on  page 11.

- Toshiba is not liable for any damage or loss caused directly or indirectly by the malfunction of this recorder, including, without limitation, any one of the following:
 - Failure to record contents intended to be recorded by the consumer.
 - Failure to edit contents as intended by the consumer.
 - When a DVD-RAM disc or a DVD-R/RW disc created on this recorder is used (e.g., insertion, playback, recording or editing) in another DVD player, recorder or personal computer drive.
 - When a DVD-RAM disc or a DVD-R/RW disc that is used in the manner described in the immediately preceding bullet point is used again in this recorder.
 - When a DVD-RAM disc or a DVD-R/RW disc that was recorded in another DVD recorder, or in a personal computer drive is used in this recorder.
- Some functions such as Library may not work with personal computer discs.
- Discs recorded in this recorder may not operate as expected on other DVD players, recorders or personal computer drives.

On DVD-RAM discs

■ Use only DVD-RAM discs that comply with DVD-RAM standard Version 2.0, 2.1 or 2.2.

The recorder cannot record on a disc formatted in any other standard. When using such a disc, initialize it by using the disc-format function of this recorder.

- The recorder may not record, dub, or edit some DVD-RAM discs, because they are edited/recorded with another manufacturer's equipment or PC, contain a large number of titles, or have little remaining capacity. Also, a DVD-RAM disc may not be edited or recorded if its title contains still pictures.
- DVD-RAM discs formatted in UDF2.0 on a PC are not compatible with this recorder. Before using these discs, initialize them on this recorder.
- This recorder complies with current copyright protection technology and can copy a disc only when the disc permits copying once. When there is no indication on the disc, copying will not be allowed. Such an indication on a disc is required also for the Library Management database.

■ DVD-RAM discs with cartridges are recommended for recording.

- Two types of DVD-RAM discs are available: ones with cartridges and ones without cartridges. You can use either of them with this recorder, but the former ones are recommended.
- In order to record highly detailed data, make sure the disc is clean. DVD-RAM discs with cartridges are easier to handle in this regard.
- Do not open the cartridge shutter. The disc may not play, or may not be recorded or edited once it becomes dirty.
- There are two types of DVD-RAM cartridges; removable (TYPE 2/4) and not removable (TYPE 1). It is recommended you do not remove the disc even when you can.
Refer to the instruction manual that comes with the disc if it is absolutely necessary to remove the disc.
- Some commercially available cartridge discs cannot be recorded or edited once the inside discs are removed.

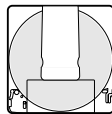

● To protect recorded contents

Slide the write-protect tab to "PROTECT" with something small enough. The disc can play, but cannot be edited or erased. Refer to the instructions that come with the disc.

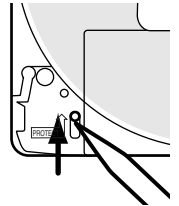

■ When using a disc without a cartridge (commercially available discs)

- Discs without cartridges can easily attract fingerprints and dust, which is the reason they are not recommended. If you cannot avoid using them, handle with proper care.
- When you write in a title column on a disc, use a pen with a soft tip. Do not use a pen with a hard tip, such as a ballpoint pen.

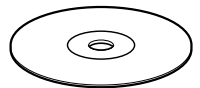

Recommended discs

The following discs have been tested with this recorder:

9.4 GB double-sided cartridge: Panasonic 2X, 3X, 5X

4.7 GB single-sided cartridge: Panasonic 2X, 3X, 5X

On DVD-R discs

■ Standards

- DVD-R for General Ver.2.0 discs can be used for recording and playback.
- Discs compatible with the following recording speeds can also be used:
Ver. 2.0/2X
Ver. 2.0/4X
Ver. 2.0/8X
Ver. 2.0/16X
- Select discs labeled “for video,” “for recording,” “120 min.” etc.

■ Recording conditions

- Images for which copying is prohibited or restricted (copy once or copy prohibited) cannot be recorded. Even if the disc is labeled as CPRM compatible, this recorder can only be used to record copy-free material.
- DVD-VR mode recording is not possible.

■ Recommended discs

That's (Taiyo-Yuden) 4X, 8X, 16X

On DVD-RW discs

■ Standards

- Discs labeled DVD-RW Ver.1.1 or 1.2 can be used.
- Discs compatible with the following recording speeds can also be used:
Ver. 1.1/2X
Ver. 1.2/4X
Ver. 1.2/6X
- Select discs labeled “for video,” “for recording,” “120 min.” etc.

■ Recording conditions

- Images for which copying is prohibited or restricted (copy once or copy prohibited) cannot be recorded. Even if the disc is labeled as CPRM compatible, this recorder can only be used to record copy-free material.
- DVD-VR mode recording is not possible.





■ Recommended discs*

JVC 2X, 4X, 6X

* Operation has been confirmed with recommended discs and tested disc, but some other discs may not be usable.

Marks on DVD video discs

The following are examples of marks and the meanings.

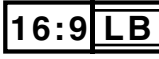
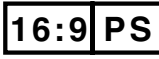
Mark	Meanings
	Number of audio streams recorded in the disc. (2 streams such as English and Japanese in this example.)
	Number of subtitle languages recorded in the disc. (2 subtitle languages are recorded in this example.)
	Number of camera angles recorded in the disc. (3 camera angles are recorded in this example.)
	Pictures are recorded in the standard picture shape (4:3 aspect ratio).
	Pictures are recorded in the letter box picture shape (4:3 aspect ratio with horizontal black bars in the top and bottom of pictures).
	Pictures are recorded in the 16:9 wide picture shape. TVs with 4:3 aspect ratio will display them in the letter box style.
	Pictures are recorded in the 16:9 wide picture shape. TVs with 4:3 aspect ratio will display them in the pan scan style (one or both sides of pictures are cut).
	Actual picture shape may vary depending on the aspect ratio or mode selection of the TV.

Choosing a disc (Continued)

Structure of disc contents

Normally, DVD video discs are divided into titles, and the titles are subdivided into chapters.

VIDEO CDs/audio CDs are divided into tracks.



Title: Divided contents of a DVD video disc. Roughly corresponds to a story title in short stories.

Chapter: Divided contents of a title. This corresponds to a chapter in a story.

Track: Divided contents of a VIDEO CD or an audio CD.

Each title, chapter, or track is assigned a number, which is called "title number", "chapter number", or "track number" respectively.

Some discs may not have these numbers.

When you record on the HDD or a DVD-RAM disc, one recording will always equal one title. You can divide a title into several chapters by marking borders in it to facilitate scene search.

On handling discs

- Do not touch the playback side of the disc.

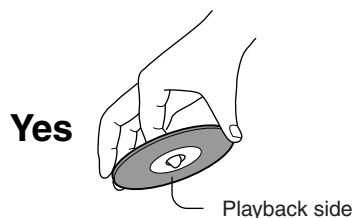

- Do not stick paper or tape to discs.



On cleaning discs

- Fingerprints and dust on the disc cause picture and sound deterioration. Wipe the disc from the center outwards with a soft cloth. Always keep the disc clean.



- Do not use any type of solvent such as thinner, benzene, commercially available cleaners or antistatic spray for vinyl LPs. It may damage the disc.

On storing discs

- Do not store discs in a place subject to direct sunlight or near heat sources.
- Do not store discs in places subject to moisture and dust such as a bathroom or near a humidifier.
- Store discs vertically in a case. Stacking or placing objects on discs outside of their case may cause warping.

Table of Contents

Introduction

■ SAFETY PRECAUTIONS	2
■ IMPORTANT SAFETY INSTRUCTIONS	4
■ Precautions	6
■ Installation procedure	10
■ About this product	11
■ Choosing a disc	12
■ Preparation of the remote control	18

Connections

■ Connecting an antenna and TV	20
■ Connecting to cable TV signal	22
■ Connecting to a satellite system	24
■ Connecting the G-LINK® cable	25
■ Connecting to a TV equipped with component video inputs	26
■ Connecting to an audio system	27

Basic setup

■ Starting up the recorder	30
■ A: TV Guide On Screen® setup	32
Setting up TV Guide On Screen®	33
■ B: Language setting	39
■ C: Satellite set top box setting	40
■ D: Output sound setting	44
■ E: TV shape setting	46
■ F: Remote control settings	48
Operating a TV with the remote control of this recorder	48
Operating the second and third TOSHIBA HDD/DVD video recorders with the remote control of this recorder	50
■ Limited United States Warranty	52
■ CANADIAN WARRANTY INFORMATION	54

Preparation of the remote control

1 Open the cover.

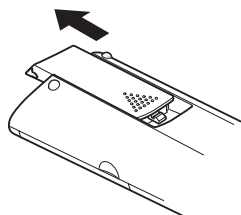

2 Insert batteries (AAA size).

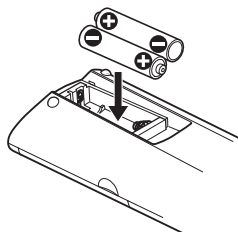

Make sure to match the + and – on the batteries to the marks inside the battery compartment.

3 Close the cover.

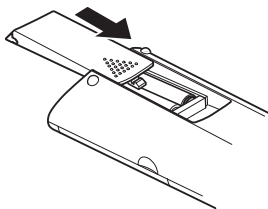

Caution

- Never throw batteries into a fire.

Notes

- Dispose of batteries in a designated disposal area.
- Attention should be drawn to the environmental aspects of battery disposal.
- Do not mix different battery types or combine used batteries with new ones.
- If the remote control does not operate correctly, or if the operating range becomes reduced, replace both batteries with new ones.
- If the batteries are dead or if you will not be using the remote control for a long time, remove the batteries to prevent battery acid from leaking into the battery compartment.

■ Operating with the remote control

Point the remote control at the remote sensor and press the buttons.

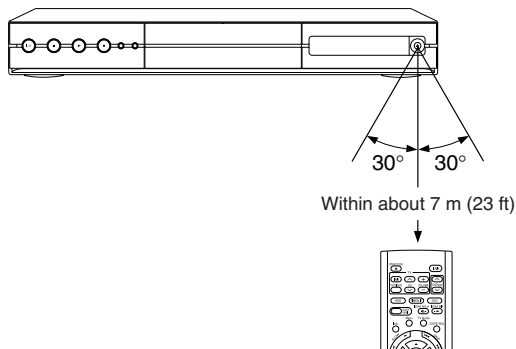

Distance : About 7 m (23 ft) from the front of the remote sensor

Angle : About 30° in each direction of the front of the remote sensor

* Do not expose the remote sensor of the recorder to a strong light source such as direct sunlight or other illumination. If you do so, you may not be able to operate the recorder via the remote control.

Notes

- Do not drop or give the remote control a shock.
- Do not leave the remote control near an extremely hot or humid place.
- Do not spill water or put anything wet on the remote control.
- Do not disassemble the remote control.



CAUTION: RISK OF EQUIPMENT DAMAGE!

Never plug in any power cords until you have finished connecting all equipment

Connection procedure

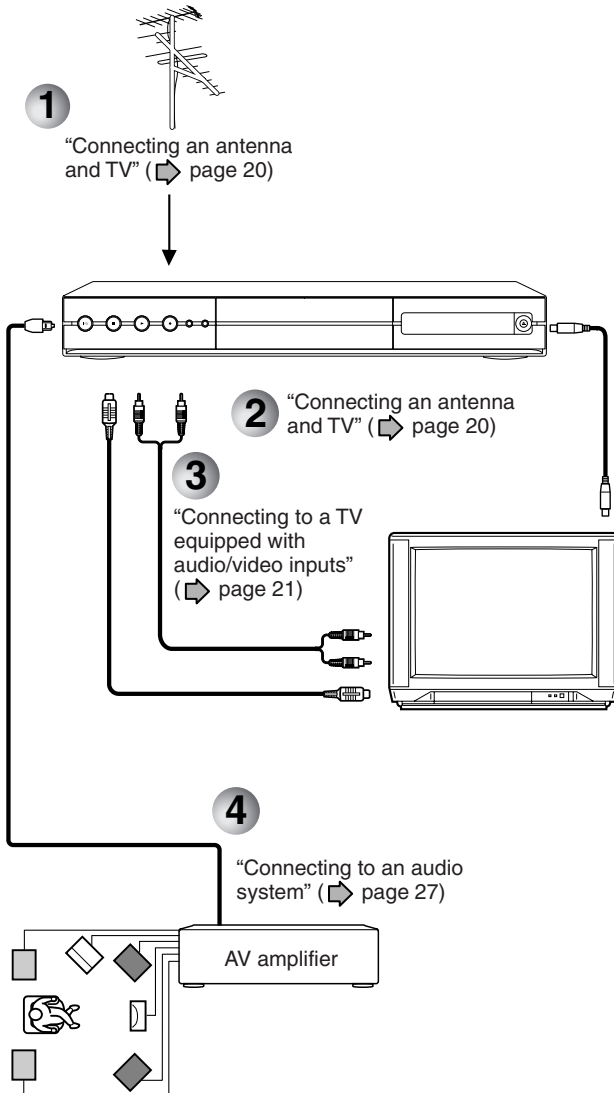

■ **When you connect a TV equipped with audio/video inputs**

Perform steps 1, 2 and 3.

■ **When you connect an audio system**

Perform steps 1, 2, 3 and 4.

Connections

Connect your recorder to your TV or stereo system.

- Connecting an antenna and TV
- Connecting to cable TV signal
- Connecting to a satellite system
- Connecting the G-LINK® cable
- Connecting to a TV equipped with component video inputs
- Connecting to an audio system

Connecting an antenna and TV

Connect your TV and the antenna to this recorder for recording and to view broadcast signals on the TV.

- 1** Disconnect the antenna cable from your TV, and connect it to the RF IN (FROM ANT.) terminal on the recorder.
- 2** Using the supplied coaxial cable of this recorder, connect the RF OUT (TO TV) terminal to the TV.

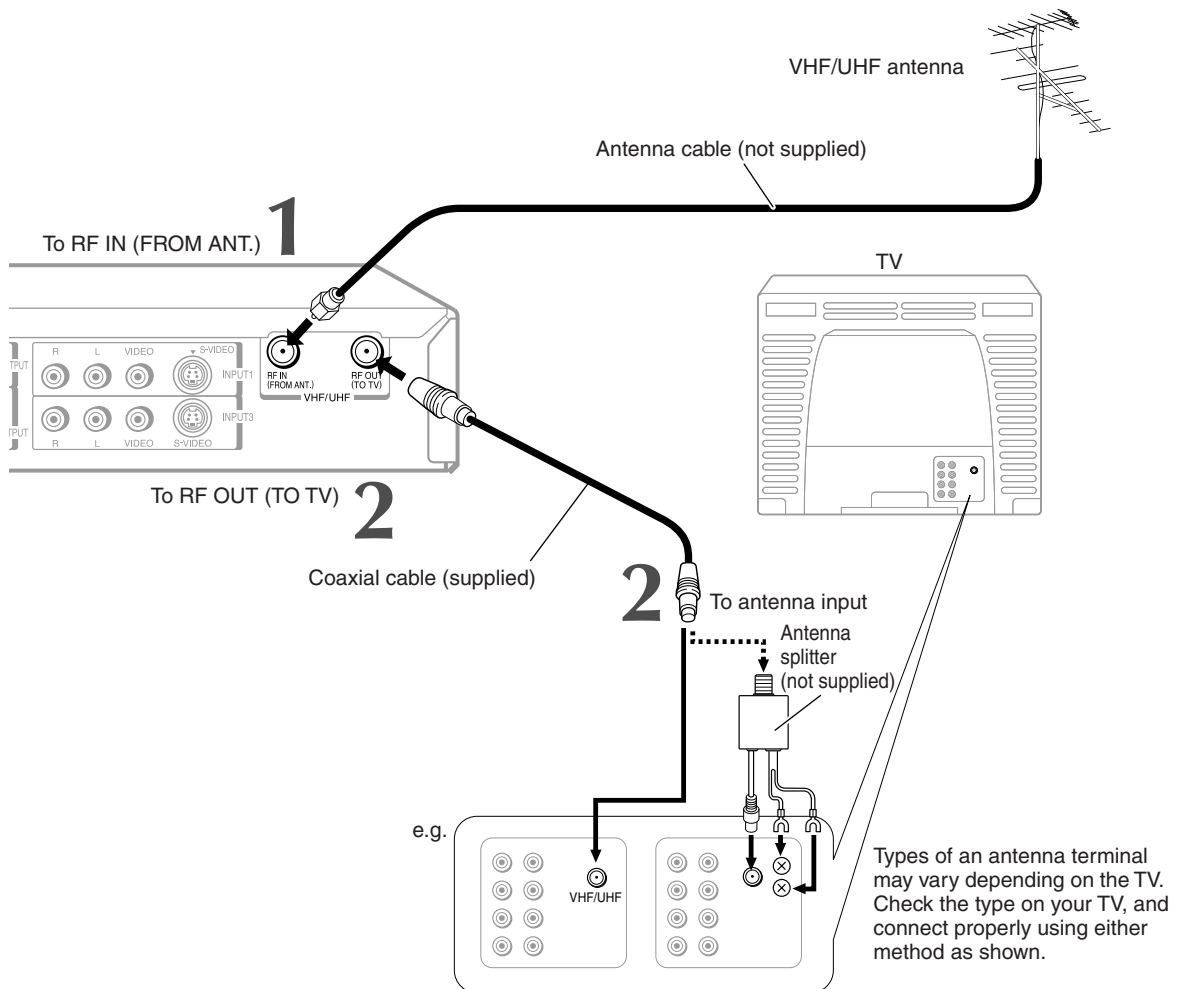

For connecting to a cable box or a satellite system, see ➔ page 22 to 25.

Note

- This connection ensures broadcast signals to be passed through to your TV. Unlike a VCR, you cannot assign channel 3 or 4 to playback from this recorder. The antenna input only passes through the broadcast signals to your TV. Therefore to playback video from this recorder you must connect it to a video input on your TV. (See the next page.)

3 Connect to a TV equipped with audio/video inputs.

Connect as below for watching received channels or recorded contents. Watching via the RF OUT terminal is not available.

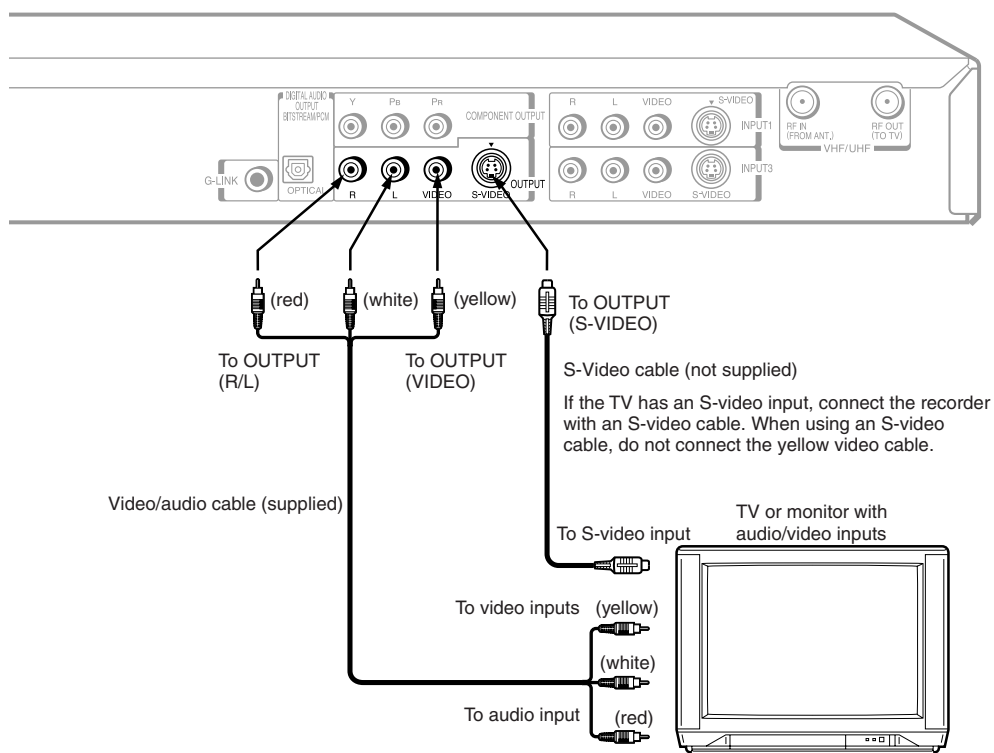

4 Connect the power cord of the recorder to a wall outlet.

Make sure that the powered recorder lights the ON/STANDBY indicator on the front panel.

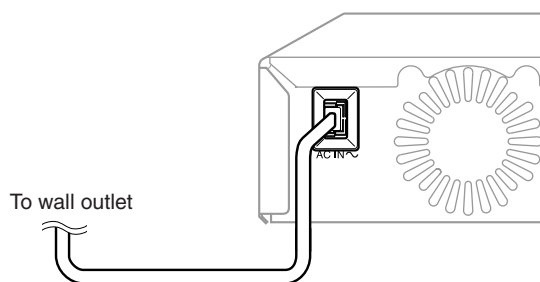

Notes

- Refer to the owner's manual of the connected TV as well.
- When you connect the recorder to your TV, be sure to turn off the power and unplug both units from the wall outlet before any connections.
- If your television set has one audio input, connect the left and right audio outputs of the recorder to a Y cable adapter (not supplied) and then connect to your TV.
- Connect the recorder directly to your TV. If you connect the recorder to a VCR, TV/VCR combination, video selector or AV amplifier, the playback picture may be distorted due to copy protection.

Connecting to cable TV signal

Choose one of the setup options below to connect the recorder to your cable signal. Connect the recorder to the TV using the audio/video cable.

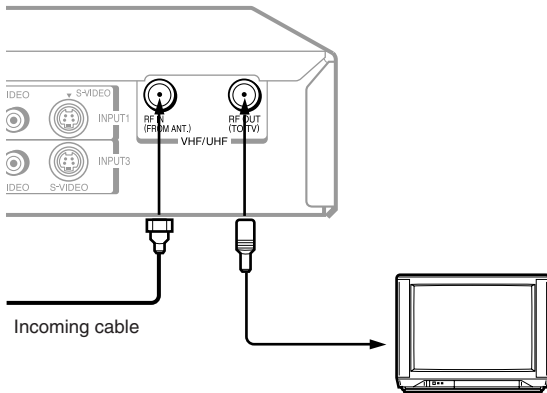

This set-up will allow you to:

- record an unscrambled channel.
- record an unscrambled channel while watching another (only when you connect a cable-compatible TV).

You will need to:

- on your TV select a desired channel to watch while recording a different channel using the recorder.

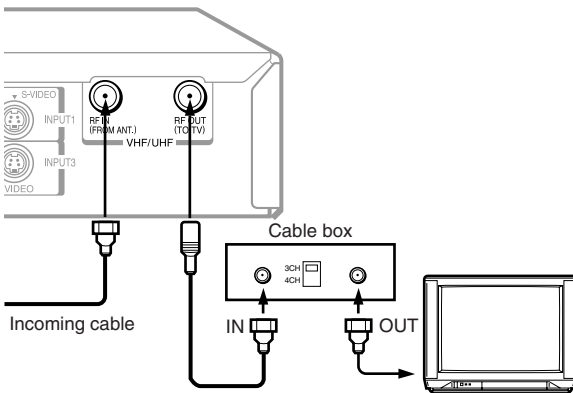

This set-up will allow you to:

- record an unscrambled channel.
- record an unscrambled channel while watching another (scrambled or unscrambled).

You will need to:

- set TV channel to the output channel of the cable box.
- to record an unscrambled channel while watching a scrambled channel, select a desired cable channel via the cable box.

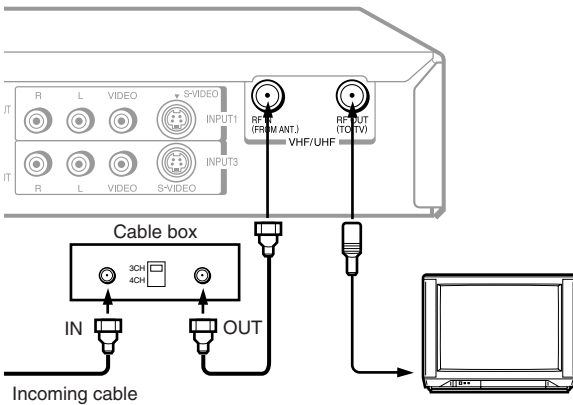

This set-up will allow you to:

- record any channels through the cable box.

You will need to:

- select a desired cable channel via the cable box.
- while the recorder is turned off, set TV channel to the output channel of the cable box.

To download program listings the TV Guide On Screen® system needs to be able to change channels on your cable box when the recorder is not in use. Please connect the supplied G-LINK® cable to the G-LINK jack of the recorder. After you connect the G-LINK® cable you will be able to control your cable box using the recorder's remote control. ➡ page 25

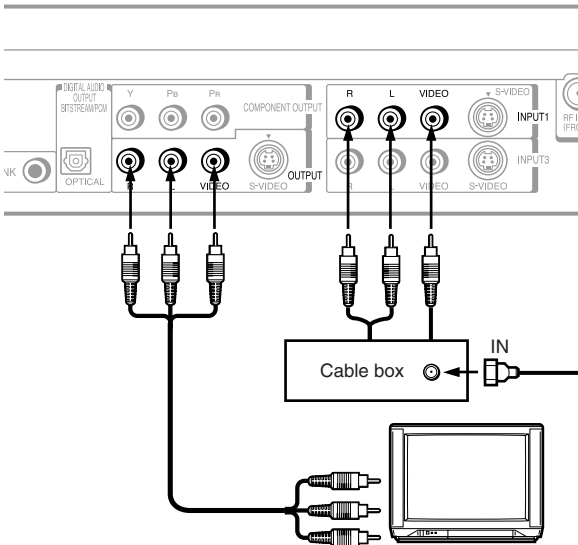

This set-up will allow you to:

- watch or record a channel through the cable box via the INPUT1 (VIDEO/L/R) jacks.

To download program listings the TV Guide On Screen® system needs to be able to change channels on your cable box when the recorder is not in use. Please connect the supplied G-LINK® cable to the G-LINK jack of the recorder. After you connect the G-LINK® cable you will be able to control your cable box using the recorder's remote control. ➔ page 25

Connecting to a satellite system

Choose one of the following according to your type of satellite receiver.

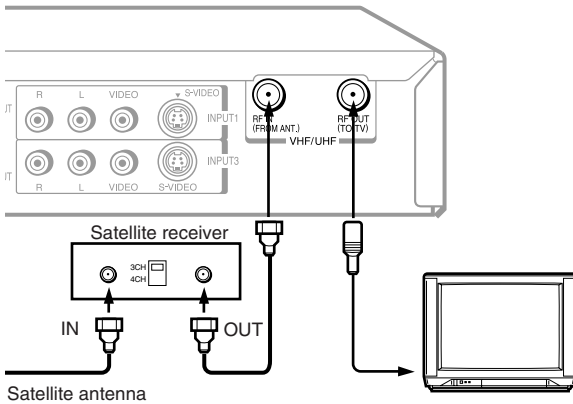

When the satellite receiver does not have audio/video outputs

- 1 Connect a satellite antenna to the satellite receiver.
- 2 Connect the RF IN (FROM ANT.) terminal on the recorder and the RF OUT terminal of the satellite receiver.
- 3 Connect the RF OUT (TO TV) terminal on the recorder and the antenna input connector of the TV.

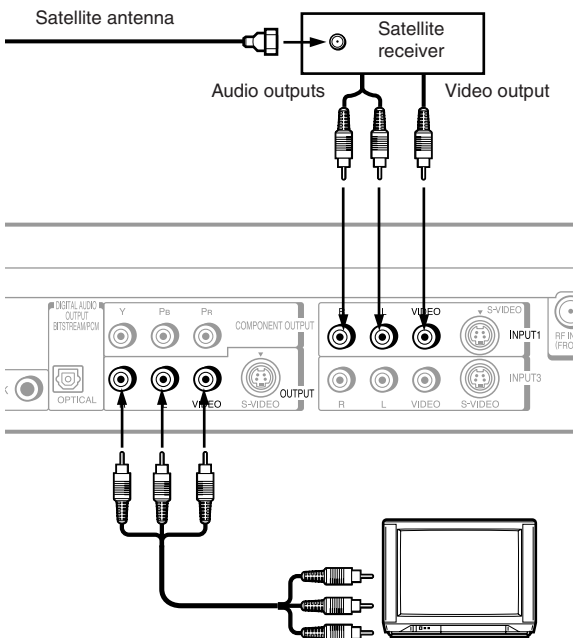

When the satellite system has audio/video outputs

- 1 Connect a satellite antenna to the satellite system.
- 2 Connect the INPUT1 or INPUT3 (VIDEO/L/R) jacks on the recorder and the audio/video output jacks of the satellite system.
- 3 Connect the OUTPUT (VIDEO/L/R) jacks on the recorder and the audio/video input jacks of the TV.
- 4 Connect the RF OUT (TO TV) terminal on the recorder and the antenna input connector of the TV.

Note

- If you use the DSS set top box control function (➡ page 40), connect your satellite set top box to the INPUT3 jacks.

Connecting the G-LINK® cable

To download program listings the TV Guide On Screen® system needs to be able to change channels on your cable box when the recorder is not in use. Please connect the supplied G-LINK® cable to the G-LINK jack of the recorder. After you connect the G-LINK® cable you will be able to control your cable box using the recorder's remote control. To connect the G-LINK® cable follow the instructions below.

1 Connect the plug of the supplied G-LINK® cable to the G-LINK jack on the recorder.

2 Place the transmitter near the set top box connected to the recorder.

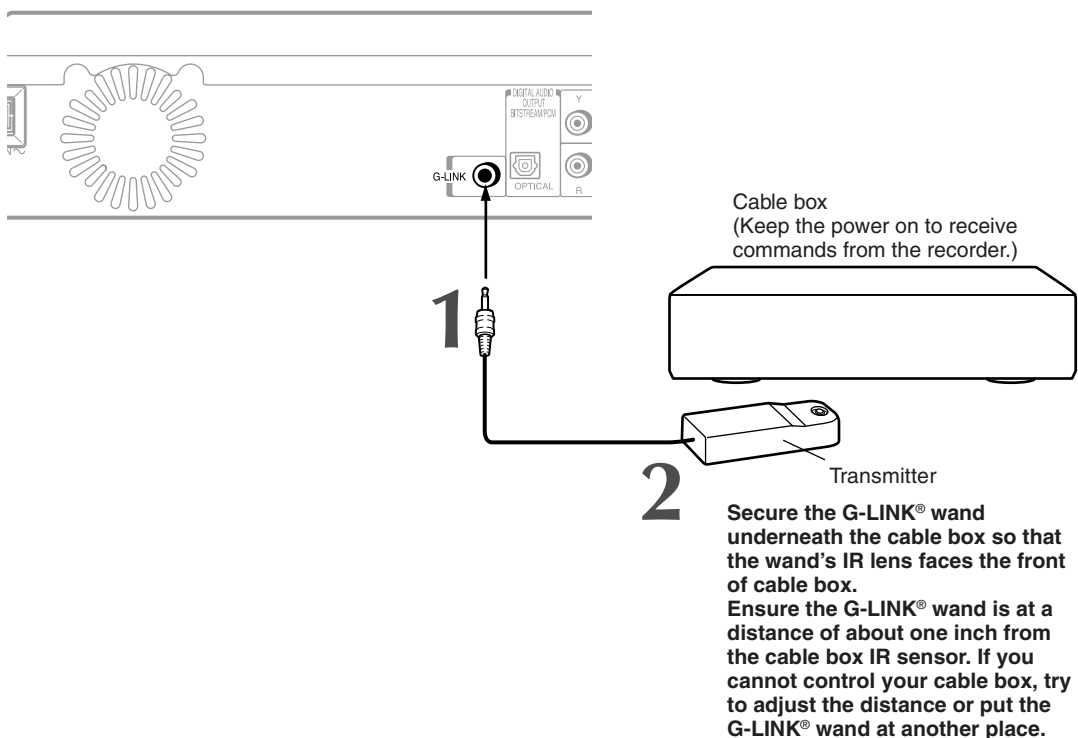

After connecting, make the necessary settings (➡ page 32).
When you use the recorder for the first time, also make the settings.

Notes

- Do not connect an accessory other than the supplied G-LINK® cable to the G-LINK jack.
- Do not cover the transmitter.
- The TV Guide On Screen® interactive program guide supports cable-ready and cable box as well as over-the-air broadcast. It does not provide listings for satellite services. TV Guide program data and schedules are updated daily through your antenna or cable system once you have completed the TV Guide On Screen® setup.
- Refer to the owner's manual of the connected set top box as well.
- Power off the recorder overnight or when not in use to allow the TV Guide On Screen® system to receive and update its listings. If a cable box is connected to this recorder, leave the cable box turned on at all times. Program listings should start displaying within 24 hours after setting up the TV Guide On Screen® system (➡ page 32).

Connecting to a TV equipped with component video inputs

If your TV has component video inputs, you can obtain pictures in better quality.

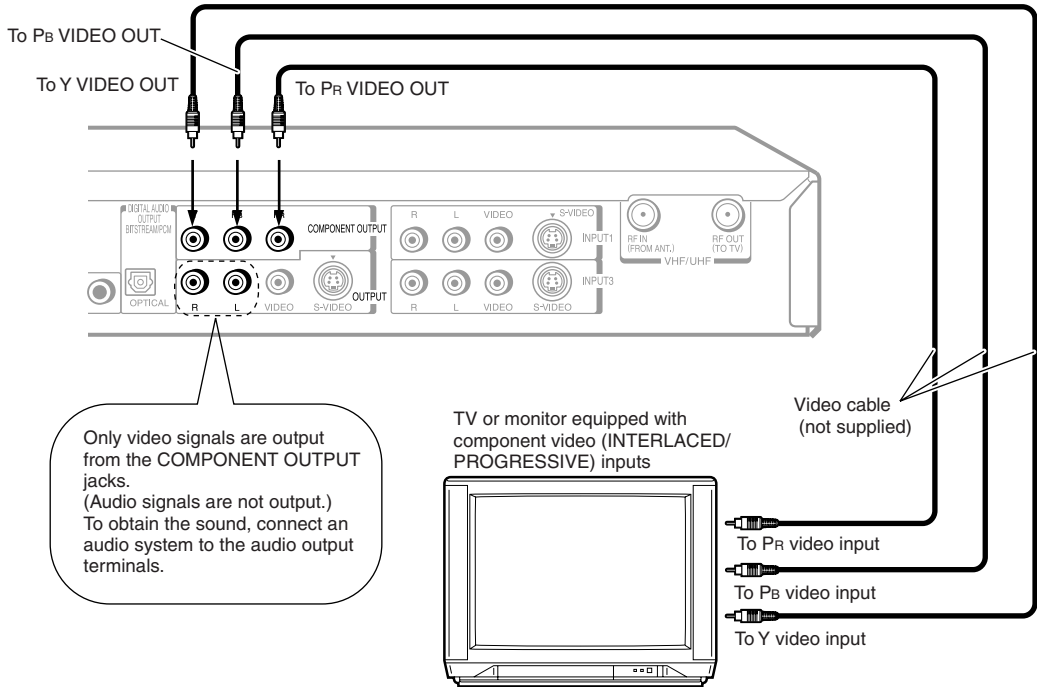

■ Component video outputs/inputs

Some TVs or monitors are equipped with component video inputs. Connecting to these inputs allows you to enjoy higher quality picture playback.

Actual labels for component video inputs may vary depending on the TV manufacturer. (ex. Y, R-Y, R-B or Y, C_B, C_R)

In some TVs or monitors, the color levels of the playback picture may be reduced slightly or the tint may change. In such a case, adjust the TV or monitor for optimum performance.

To switch the output signal (Progressive/Interlaced)

PROGRESSIVE Press PROGRESSIVE button to change the video output signals (progressive and interlace) from COMPONENT OUTPUT jacks.

- Make the following setting.

On-screen display	Select	Page
"Audio out select"	"Analog 2ch"	➡ page 39

Notes

- Refer to the owner's manual for the TV to be connected to this recorder for more information concerning an audio system.
- If you place the recorder near a tuner or radio, the radio broadcast sound might be distorted. In this case, place the recorder away from the tuner and radio.
- The output sound of the recorder has a wide dynamic range. Be sure to adjust the audio amplifier's volume to a moderate listening level. Otherwise, the speakers and your hearing may be damaged by sudden high volume sound.
- Turn off the amplifier before you connect or disconnect the recorder's power cord. If you leave the amplifier power on, the speakers may be damaged.
- Consumers should note that not all high definition television sets are fully compatible with this product and may cause artifacts to be displayed in the picture. In case of 525 progressive scan picture problems, it is recommended that the user switch the connection to the "Standard Definition" output. If there are questions regarding our TV set compatibility with this model 525p DVD player, please contact our Customer Service Center.

Connecting to an audio system

You can enjoy multichannel surround-sound such as 5.1 channel by connecting to an amplifier compatible with Dolby® Digital and DTS® sound.

- For connection to your TV, see ➔ pages 20 to 21, 26.
- For details of output sound, see ➔ page 162 in “OPERATIONS GUIDE”.

Caution

- When you are connecting (via the DIGITAL AUDIO OUTPUT BITSTREAM/PCM jack) an AV decoder that does not have Dolby Digital, Digital Theater Systems (DTS) or MPEG2 decoding function, be sure to set “Audio out select” to “PCM” from the on-screen displays (➔ page 39). Otherwise, high volume sound may damage your hearing as well as the speakers.
- When playing DTS-encoded discs (DVD video discs and audio CDs), excessive noise may be output from the analog stereo jacks. To avoid possible damage to the audio system, you should take proper precautions when the analog audio out (L/R) jacks of the recorder are connected to an amplification system. To enjoy DTS Digital Surround® playback, an external 5.1 channel DTS Digital Surround® decoder system must be connected to the DIGITAL AUDIO OUTPUT BITSTREAM/PCM jack of the recorder.

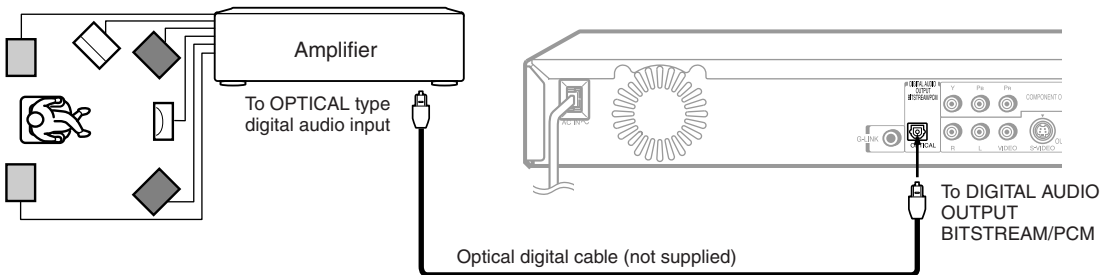

Manufactured under license from Dolby Laboratories. “Dolby” and the double-D symbol are trademarks of Dolby Laboratories.

“DTS” and “DTS Digital Out” are trademarks of Digital Theater Systems, Inc.

- Make the setting on ➔ page 39, “Audio out select”.

Notes

- DO NOT connect the DIGITAL AUDIO OUTPUT BITSTREAM/PCM jack of the recorder to the AC-3 RF input of a Dolby Digital Receiver. This input on your A/V Receiver is reserved for Laserdisc use only and is incompatible with the DIGITAL AUDIO OUTPUT BITSTREAM/PCM jack of the recorder.
- Connect the DIGITAL AUDIO OUTPUT BITSTREAM/PCM jack of the recorder to the “OPTICAL” input of a Receiver or Processor.
- Refer to the owner’s manual for the TV to be connected to this recorder for more information concerning connecting an audio system.
- The output sound of the recorder has a wide dynamic range. Be sure to adjust the audio amplifier’s volume to a moderate listening level. Otherwise, the speakers and your hearing may be damaged by a sudden high volume sound.
- Turn off the amplifier before you connect or disconnect the recorder’s power cord. If you leave the amplifier power on, the speakers may be damaged.

Basic setup

Read this chapter for necessary settings to get started. When you use this recorder for the first time, be sure to perform A to C in this order. Proceed to D if necessary.

- **Starting up the recorder**
- **A: TV Guide On Screen® setup**
 - Setting up TV Guide On Screen®**
- **B: Language setting**
- **C: Satellite set top box setting**
- **D: Output sound setting**
- **E: TV shape setting**
- **F: Remote control settings**
 - Operating a TV with the remote control of this recorder**
 - Operating the second and third TOSHIBA HDD/DVD video recorders with the remote control of this recorder**

Starting up the recorder

After all the necessary connections,

- Turn on the equipment connected to the recorder.
- Select the corresponding video input on your television.

Perform these selections whenever you operate the recorder.

■ Turning the power on

Press ON/STANDBY button from the remote control or on the front panel of the recorder.

ON/STANDBY button/ ON/STANDBY indicator

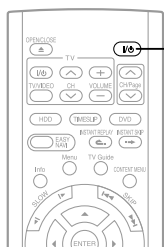

ON/STANDBY button

When the power turns on, ON/STANDBY indicator changes color from red (standby mode) to green (operation).

After a few seconds, a startup screen appears.

The following icon will appear on the top right corner of the screen. The icon will continue flashing momentarily.

e.g.



While the icon is flashing, the recorder is checking the status and reading data of the HDD and the DVD drive for startup. If the DVD drive does not contain a disc, the recorder consumes less time to startup, because it does not need to read data from the DVD drive.

While the "Loading" icon is flashing, the recorder cannot respond to any operations of buttons other than CH/Page and INPUT SELECT. Operate all other functions after the icon has disappeared.

Notes

- When the recorder is turned on for the first time, the Welcome screen will be displayed after the "Loading" icon has disappeared. See "A: TV Guide On Screen setup" (▶ page 32).
- While displaying "WAIT" on the front panel, do not operate the recorder or unplug the power cord. Otherwise, this may result in malfunction of the recorder.

■ Turning the power off

Press ON/STANDBY button from the remote control or on the front panel of the recorder.

The "Unloading" icon appears on the right corner of the top of the screen, and the ON/STANDBY indicator turns red. Then the power turns off.

Note

- If the recorder freezes for about 15 minutes and will not respond to any buttons, holding down ON/STANDBY button on the front panel for about 10 seconds can force the recorder to turn off. However, this is an emergency measure, which contains a risk of damage to data or discs. Avoid casual use of this measure. If you try this while the recorder is operating properly, especially while the "Loading" or "Unloading" icon is flashing, it may result in re-initialization of the HDD.

■ Startup/finishing (closing) icons

These icons are displayed on the right corner on the top of the screen. While they are flashing, the recorder is operating as follows:



Loading

Startup, reading a disc, finishing recording



Unloading

Unloading a disc, finishing the recorder's operation



Open

Opening a disc tray



Close

Closing a disc tray

■ If a message appears

The recorder may display a message. Each message varies according to operational status.

To respond, follow the examples below.

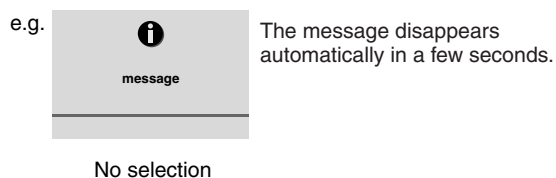
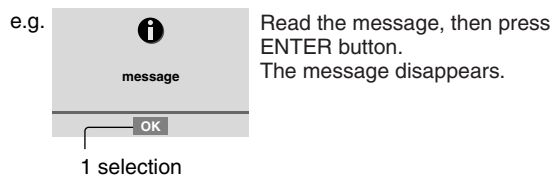
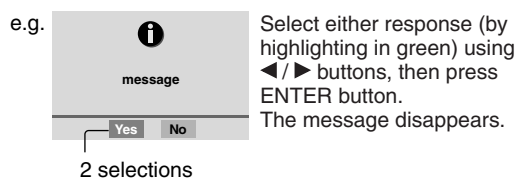
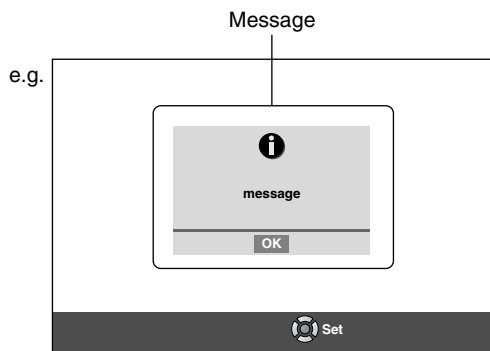

A: TV Guide On Screen[®] setup

This step sets the recorder's clock and tuner to record broadcasting TV programs.

Once you complete this process there is generally no need to reset the clock. (However, if there are discrepancies in the recorder's time display or changes made to receivable TV stations, you should make this setting again.)

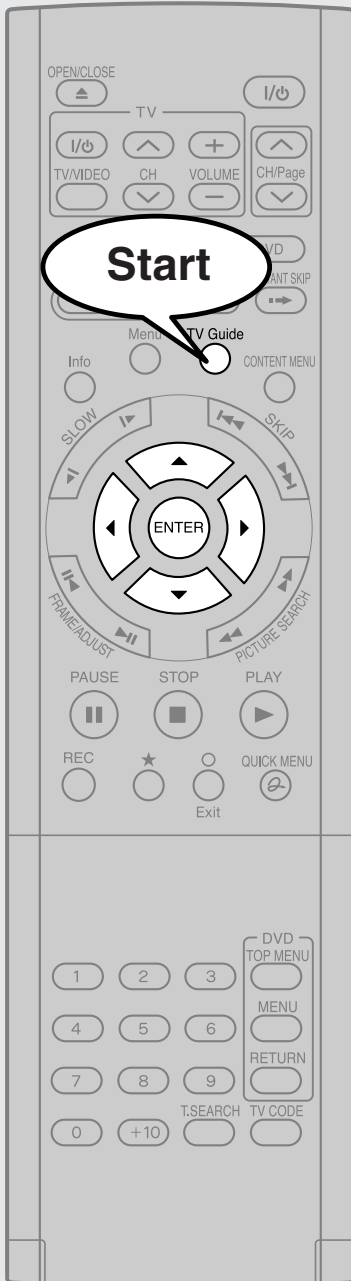

To set up the recorder for the first time see the TV Guide On Screen[®] setup instructions on page 33.

1 Press TV Guide.



2 Press ◀/▶ to select "SETUP".

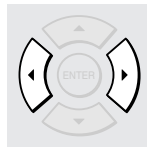

3 Press ▲/▼ to select "Change system settings", then press ENTER.

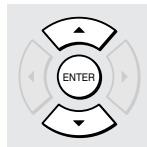

4 Press ▲/▼ to select "No, repeat setup process", then press ENTER.



Setting up TV Guide On Screen®

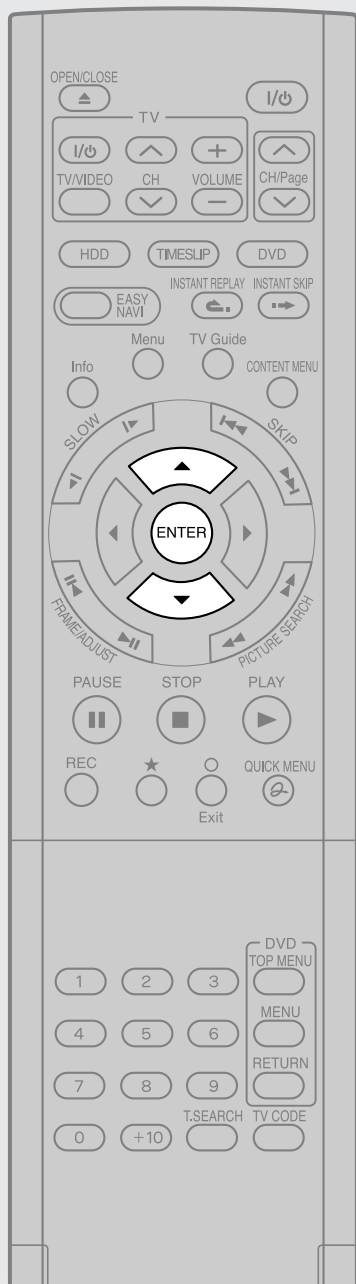

1 Setup selection

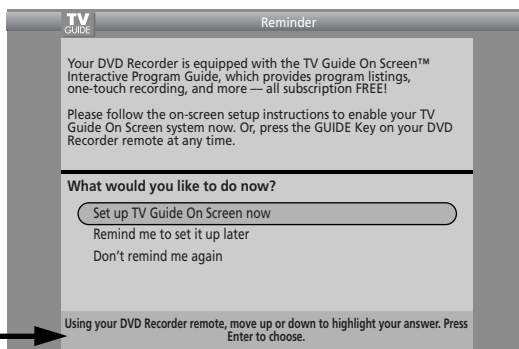
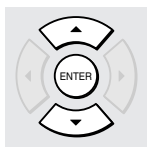

Instructions are provided at the bottom for each screen.

Press ▲ / ▼ to select “Set up TV Guide On Screen Now”, then press ENTER.

2 Country

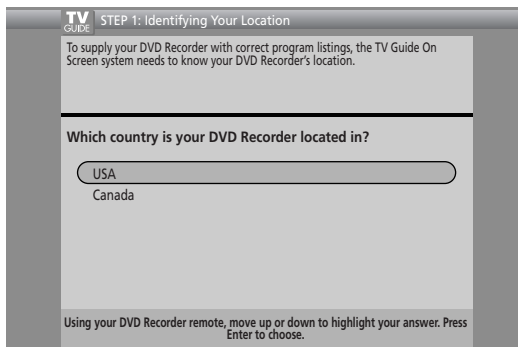
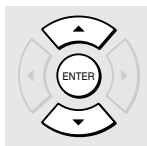

Press ▲ / ▼ to select, then press ENTER.

(Continued)

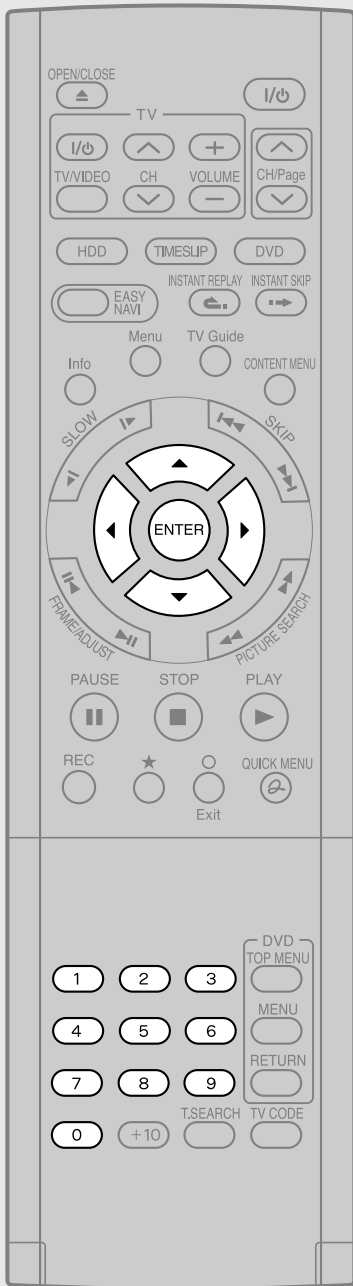

3 ZIP or postal code

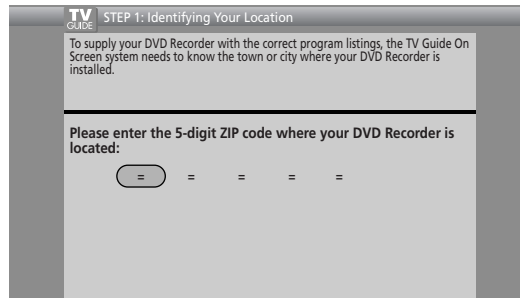

Use one of the options below to enter your ZIP or Postal Code, then press ENTER:

- Number buttons
- ▲ / ▼ to select a number, then ◀ / ▶ to move to another field.

4 Cable service

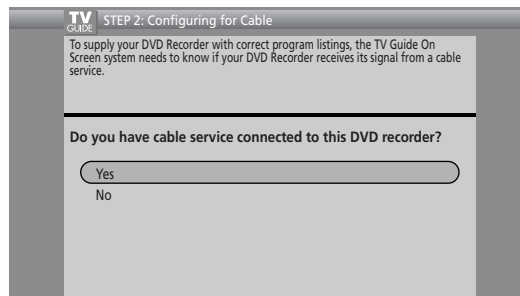
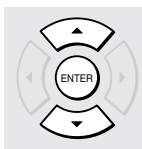

Press ▲ / ▼ to select, then press ENTER.

If the answer is “No”, you will go to step 12.

5 Cable connection

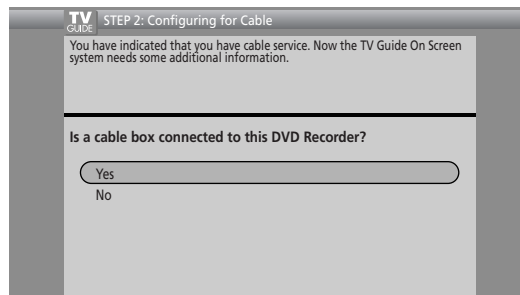
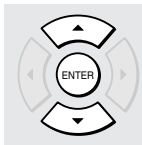

Press ▲ / ▼ to select, then press ENTER.

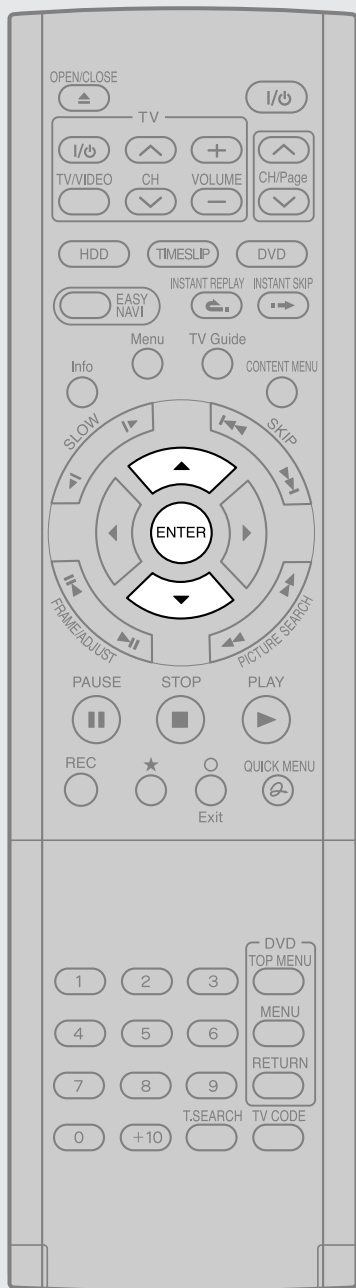

6 Cable input

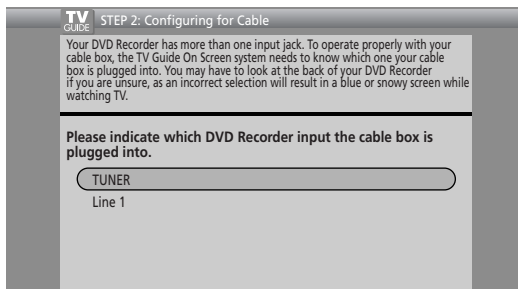
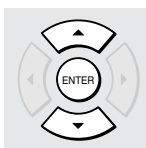

Press ▲ / ▼ to select, then press ENTER.

If you select "TUNER", you will go to step 7.
If you select "Line 1", you will go to step 8.

7 Tuning channel for the cable box

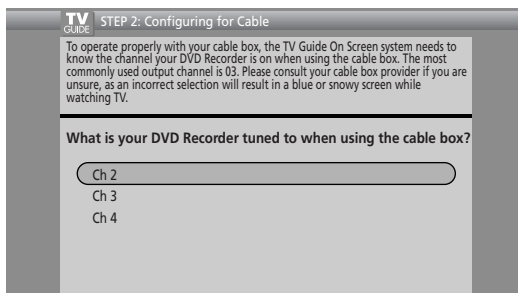
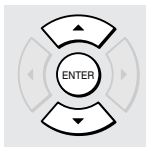

Press ▲ / ▼ to select, then press ENTER.

8 Read the instructions and observe the diagram. Confirm that the G-LINK® cable and its wand is properly installed. (➡ page 25) If OK, press ENTER.

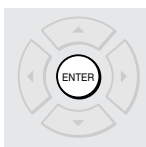

(Continued)

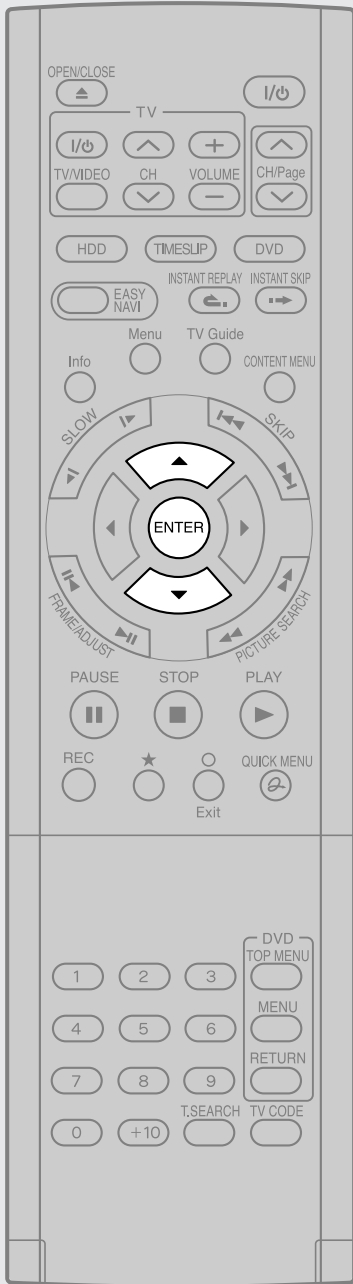

9 Cable box brand name

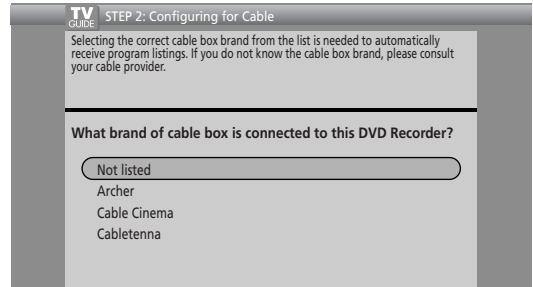
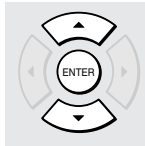

Press ▲ / ▼ to view and select more brands, then press ENTER.

10 Cable box preparation

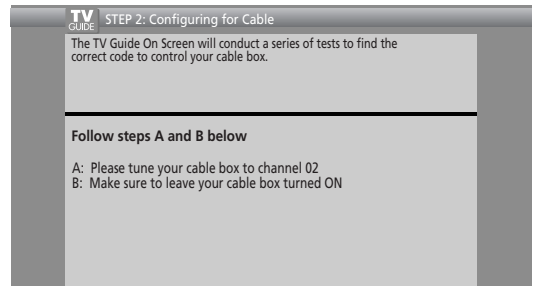

Follow the instructions, then press ENTER.

11 Cable box code testing

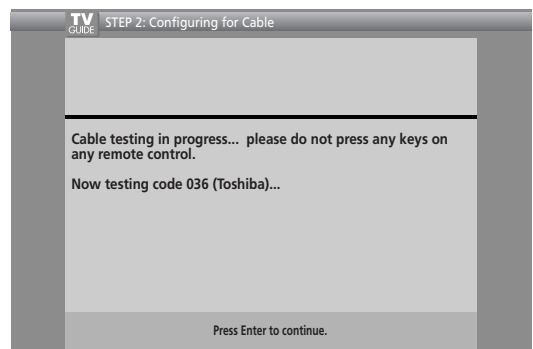

When testing is done, the following screen automatically appears.

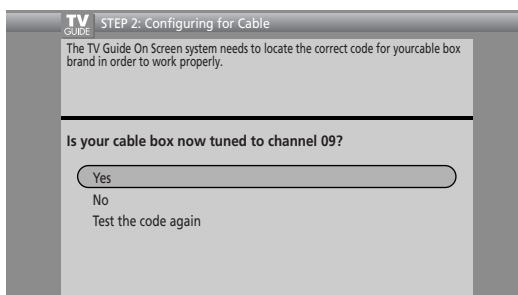
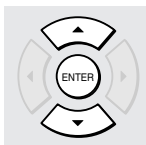
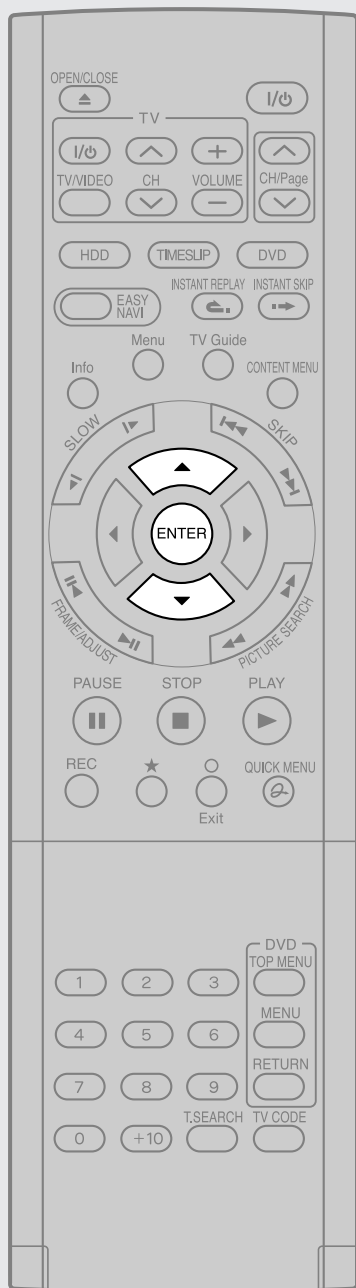

Press ▲ / ▼ to select, then press ENTER.

If your answer is "Yes", and:

- if you selected "TUNER" at step 6, you will go to step 13.
- if you selected "Line 1" at step 6, you will go to step 12.

12 Antenna connection

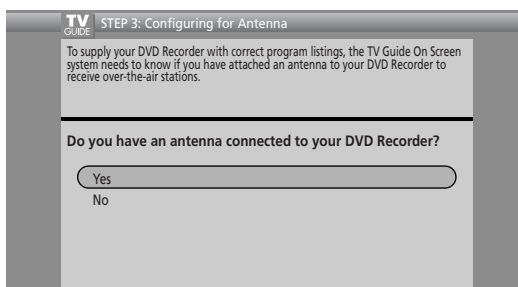
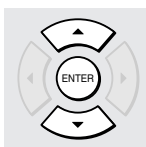

Press ▲ / ▼ to select, then press ENTER.

13 Confirmation

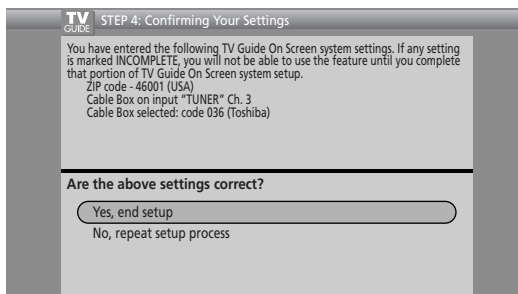
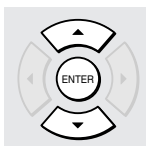

Press ▲ / ▼ to select, then press ENTER.

(Continued)

A: TV Guide On Screen® setup (Continued)

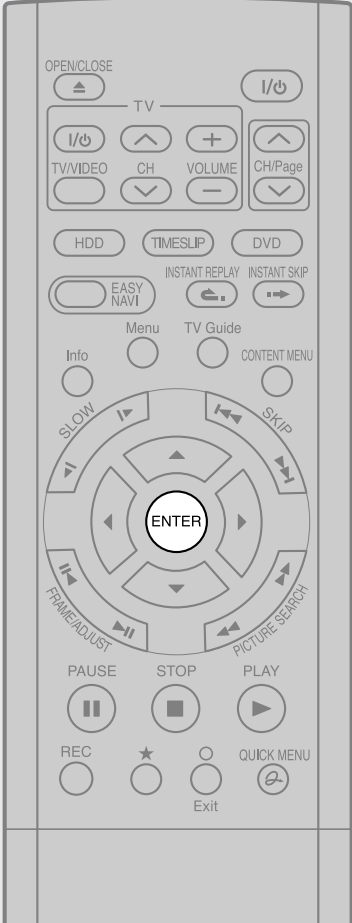

14 Confirmation



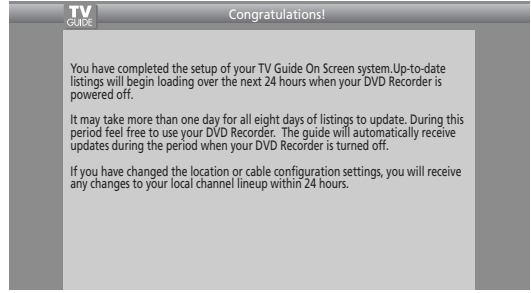

**You have successfully completed the setup!
Press ENTER.**

15 Information



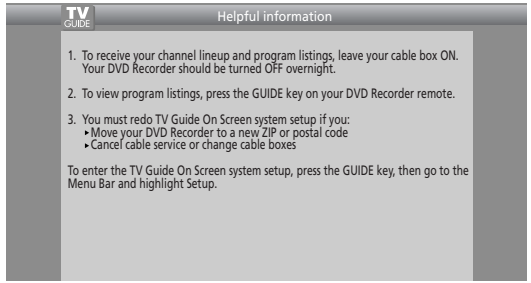

Read the information and press ENTER.

Notes

- When the clock data cannot be downloaded from the TV Guide On Screen® system, set the clock manually. (➡ page 157, in “OPERATIONS GUIDE”)
- It may take about 24 hours for the TV Guide On Screen® system to be fully available after the setup is finished.
- TV Guide On Screen® system is not compatible with the DSS set top box control function (➡ page 40). If you select “Yes” at step 5 (➡ page 34) and complete the setup, the recorder sets itself to TV Guide On Screen® system and disables the setting on ➡ page 40.

“A: TV Guide On Screen® setup” is complete. Go to “B: Language setting”. (➡ page 39)

B: Language setting

Select a preferred language for on-screen displays.



1 Press SETUP.



The setup menu appears.

2 Press ◀/▶ to select “Initial settings”, then press ENTER.

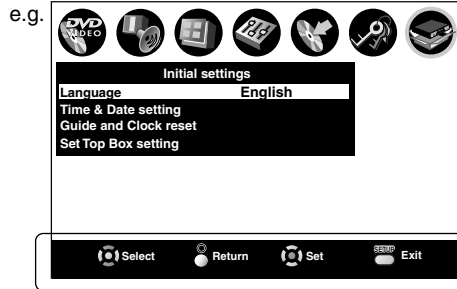
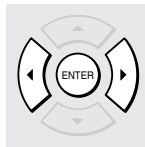

Refer to the guide on the bottom on each GUI for further programming related information.

3 Press ▲/▼ to select “Language”, then press ENTER.

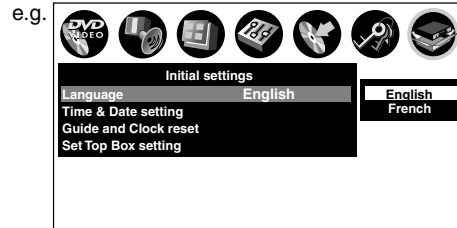
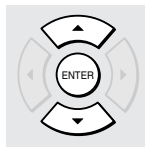

4 Press ▲/▼ to select a language, then press ENTER.

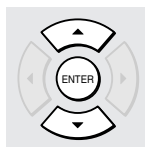

English: To view on-screen displays in English.
French: To view on-screen displays in French.

“B: Language setting” is complete. Go to “C: Satellite set top box setting” (➡ page 40).



Note

- This setting is not available for TV Guide On Screen® displays.

C: Satellite set top box setting

Set your recorder to control channels of a connected satellite set top box. (DSS set top box control function)

This setting is only for users who do not or can not control channels of a connected cable box by means of TV Guide On Screen® system.

If you selected “Yes” at step 5 on  page 34, you do not need to do this setting. Skip to “D: Output sound setting” ( page 44).

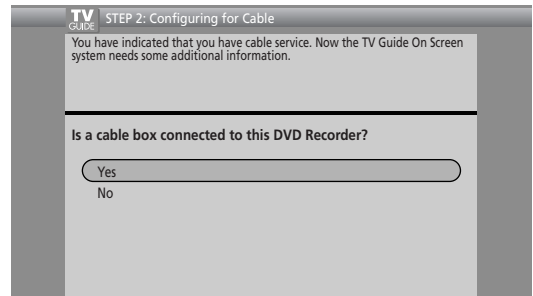

Important

- Be sure to connect your satellite set top box to the INPUT3 jacks of the recorder.
- Make the G-LINK® cable connection ( page 25) between your satellite set top box and the recorder.



Start

- ### 1 Press SETUP to display the setup menu.

When it is already displayed, press  button.



- ### 2 Press / to select “Initial settings”, then press ENTER.

e.g.

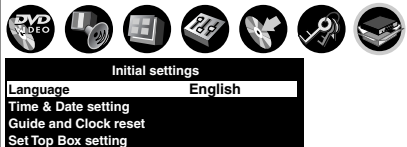

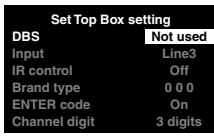

- ### 3 Press / to select “Set Top Box setting”, then press ENTER.

e.g.

Set Top Box setting	
DBS	Not used
Input	Line3
IR control	Off
Brand type	0 0 0
ENTER code	On
Channel digit	3 digits

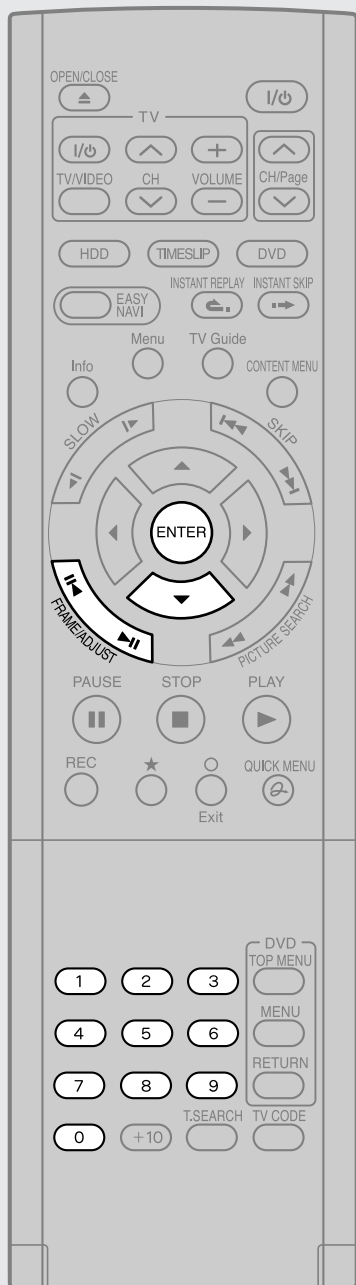

4 Press ADJUST (or ◀/▶) to set “DBS” to “Not used” or “Use”.



Not used:

When a satellite set top box is not connected to the INPUT3 jacks of the recorder.
Skip to step 8.

Use:

When a satellite set top box is connected to the INPUT3 jacks of the recorder.

5 Press ▼, then press ADJUST (or ◀/▶) to set “IR control” to “On” or “Off”.



Off: Channels of the satellite set top box are selected by its own selector.
Skip to step 8.

On: The recorder can change channels of the satellite set top box.

6 Press ▼, then press the number buttons to enter the 3 digits of a brand code of your satellite set top box obtained from the list (▶ page 43).

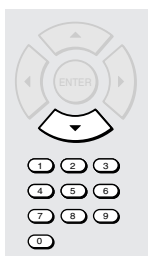

e.g. If you connect a TOSHIBA satellite set top box:

0 → 9 → 0

7 Press ▼, then press ADJUST (or ◀/▶) to set “ENTER code” to “On” or “Off”.



Confirm whether the connected satellite set top box requires ENTER input after digits in channel selection or not.

On: If ENTER input is required.

Off: If ENTER input is not required.

(Continued)

8 Press ENTER.



“Initial settings” menu returns.
To exit the setting menu, press SETUP button.

If you have set “IR control” to “On” at step 5 (➡ page 41), turn on your satellite set top box and confirm its channels are selected by the number buttons or CH/Page buttons of the recorder’s remote control. If not, shift the G-LINK® wand of the G-LINK® cable or try another brand code.

“C: Satellite set top box setting” is complete. Go to “D: Output sound setting” (➡ page 44).

Notes

- This setting will be reset to default if you redo the TV Guide On Screen® setup and select “Yes” at the cable selection (step 5, ➡ page 34).
- The recorder can control satellite set top box of 3 digit channel selection only. If the channel control does not work properly, set “IR control” to “Off” at step 5 on ➡ page 41.

■ Satellite set top box brand code

Brands	Codes			
DirecTV	106			
Drake	093			
Echostar	092	100		
Hitachi	091	099	102	105
Hughes	091	099	102	105
Magnavox	094	095		
Optimus	094	095		
Panasonic	096			
Philips	091	099	102	105
Primestar	092	100		
ProScan	097	103		
RCA	097	103		
Samsung	097	103		
Sony	098			
Toshiba	090			
Uniden	094	095		
Zenith	101			

Note

- Some models of satellite set top box may not be controlled with this recorder.

D: Output sound setting

Select the output sound setting corresponding to the connected TV or audio system.

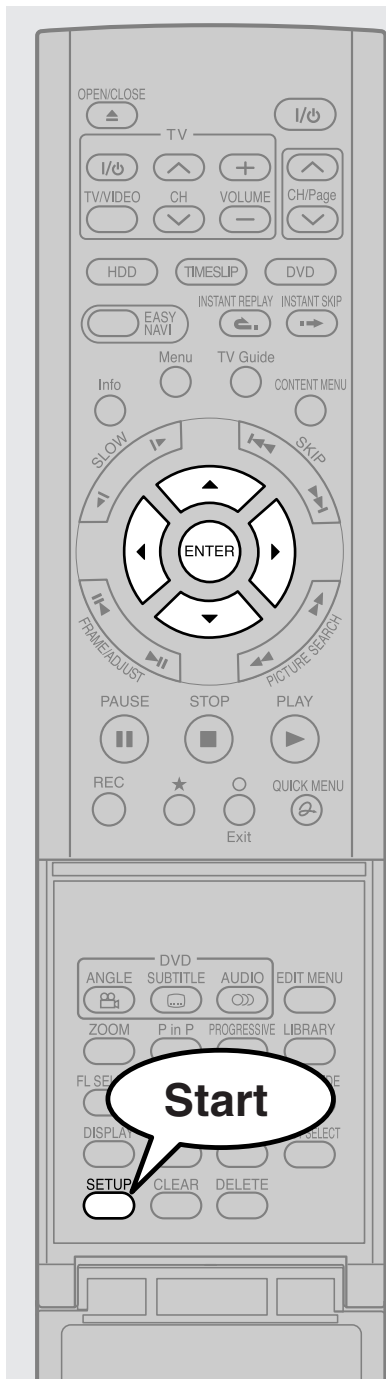

1 Press SETUP to display the setup menu.



When it is already displayed, press O button.

2 Press ◀/▶ to select “Picture/Audio settings”, then press ENTER.

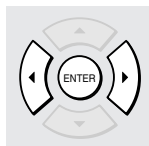

e.g.

Picture/Audio settings	
Pause / Still	Auto
Output Black level	Standard
Custom picture select	Normal
Custom picture setting	
Progressive conversion	Auto
Play DNR	
Audio out select	Bitstream
Virtual surround	Off
SAP	Off

3 Press ▲/▼ to select “Audio out select”, then press ENTER.

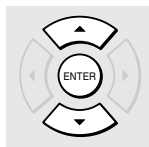

e.g.

Picture/Audio settings	
Pause / Still	Auto
Output Black level	Standard
Custom picture select	Normal
Custom picture setting	
Progressive conversion	Auto
Play DNR	
Audio out select	Bitstream
Virtual surround	Off
SAP	Off

Bitstream
Analog 2ch
PCM

4 Press ▲ / ▼ to select the output sound format.

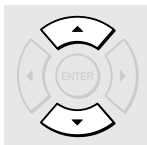

Bitstream:

Select when connected to an amplifier equipped with a Dolby Digital, DTS, MPEG1 and MPEG2 decoder. (➡ page 27)

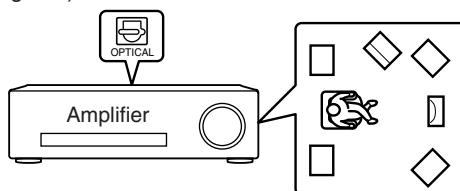

The recorder outputs digital audio signals in the bitstream format when you play a DVD video disc recorded on the Dolby Digital, DTS, MPEG1 and MPEG2 recording system.

Analog 2ch:

Select when connected to a TV or audio system via the analog audio jacks. (➡ pages 21, 26)

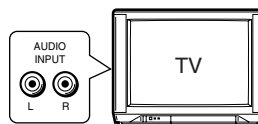

PCM:

Select when connected to a 2 channel digital stereo system. (➡ page 27)

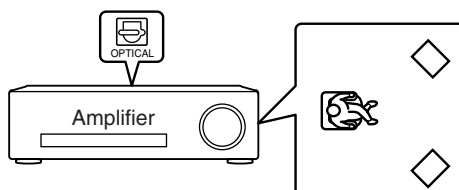

The recorder outputs sounds in the PCM 2ch format when you play a disc recorded on the Dolby Digital, MPEG1 and MPEG2 recording system.

5 Once the proper setting is selected, press ENTER.



The submenu disappears.
To exit the setting menu, press SETUP button.

“D: Output sound setting” is complete. Go to “E: TV shape setting”. (➡ page 46)

E: TV shape setting

Select the picture shape according to the aspect ratio of your TV.

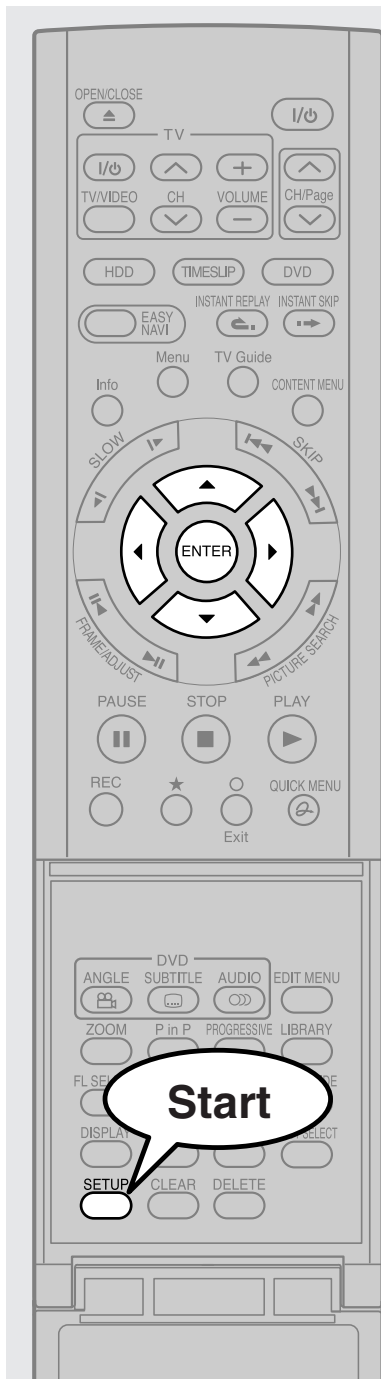

1 Press SETUP to display the setup menu.



When it is already displayed, press **O** button.
(To return to the previous menu)

2 Press **◀/▶** to select “Display settings”, then press ENTER.

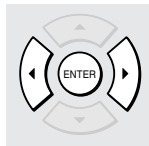

e.g.

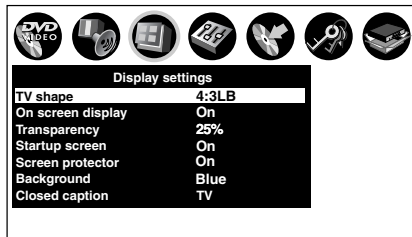

3 Press **▲/▼** to select “TV shape”, then press ENTER.

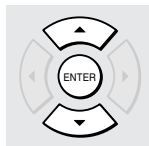

e.g.

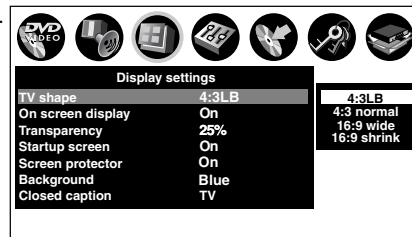

4 Press ▲ / ▼ to select the picture shape.

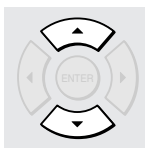

4:3LB:

Select when a standard 4:3 TV is connected.
Displays theatrical images with masking bars above and below the picture.



4:3 normal:

Select when a standard 4:3 TV is connected.
Displays pictures cropped to fill your TV screen. Either or both of the picture's sides are cut off.



16:9 wide:

Select when a 16:9 wide TV is connected.

16:9 shrink:

Select when a 16:9 wide TV is connected.
When a 4:3 aspect ratio image has been elongated to 16:9 wide picture size, use this setting.
Masking bars to the right and left appears.



5 When the proper setting is selected, press ENTER.

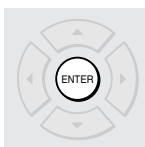

The submenu disappears.
To exit the setting menu, press SETUP button.

Notes

- Actual picture shape may depend on signal types of broadcasts or input sources, or settings on the connected TV. Refer to the owner's manual of your TV.
- When a DVD video disc has a particular available picture shape, the contents may not be compatible with other picture shapes.

“E: TV shape setting” is complete. Go to “F: Remote control settings”. (➡ page 48)

F: Remote control settings

Take this step according to your preference and usage.

Operating a TV with the remote control of this recorder

The remote control of this recorder has a function to operate a TV.

Preparation: Please find the brand code on the next page for the TV you wish to control.

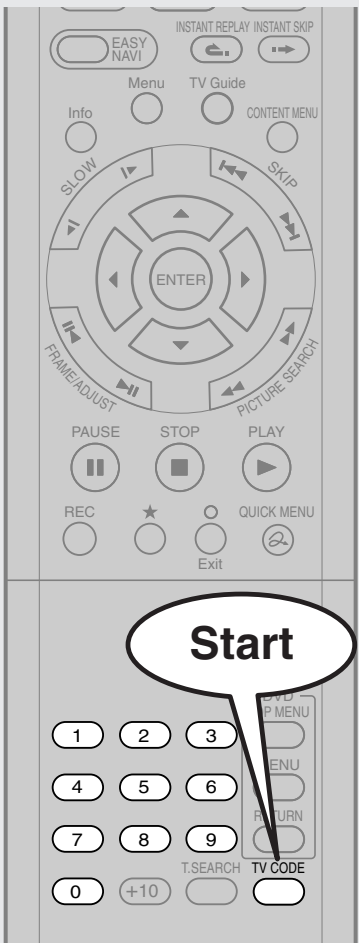

1 While holding TV CODE, press the number buttons to enter a corresponding brand code (see the next page) of your TV.

e.g. To enter 0071

TV CODE TV CODE 0 → 0 → 7 → 1

Hold down.

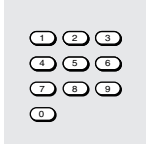

2 Release TV CODE.

The brand code is memorized.

Operating your TV with the remote control

Point the remote control to your TV after you have entered the brand code. Operate your TV with the buttons below.

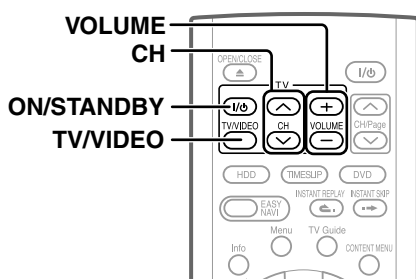

- ON/STANDBY:** To turn on and off the TV
- TV/VIDEO** : To change the video input
- CH** : To select the TV channel
- VOLUME** : To adjust the volume

■ Brand code table

Brand name	Brand code					Brand name	Brand code				
Toshiba	0001	0021	0071	0311	0411	Philco	0051	0161	0271	0291	0361
	0431	0831	0841	0851	1341		0421	0501	0551	0621	0631
	1611	1621	1681	1781	1951		0661	0711			
	2121	2461	2491			Philips	0051	0161	0271	0321	0361
Bell & Howell	0081	0431					0421	0461	0551	0631	0661
	Citizen	0051	0381	0471	0551	0621	0711	2141	2351		
Curtis Mathes	0851	1561				Proton	0051	0161	0621	0651	2491
	0051	0391	0431	0531	0621	Quasar	0711	0741	0801	1401	2281
Emerson	0851	1521	1561	2501		Radio Shack	0431	1521	2481		
	0051	0111	0121	0141	0151	Radio Shack/Realistic	0051	0161	0381	0391	0431
	0161	0201	0211	0351	0381		0541	0621	1431	1561	2501
Fisher	0431	0521	0561	0571	0621	RCA	0051	0221	0391	0501	0621
	0691	1241	1291	1371	1561		0661	0711	0871	0881	0911
	2481						0921	0941	1001	1041	1071
	0251	0401	0431	1151	2451		1091	1181	1211	1241	1301
GE	2481						1461	1491	1521	1531	2291
	0041	0051	0091	0181	0321		2481	2501			
	0371	0391	0591	0621	0711	Realistic	0431	1521			
	0741	0881	1041	1471	1521	Runco	0011				
Goldstar	2481	2501				Samsung	1811	0051	0161	0501	0531
	0051	0061	0161	0231	0451		0621	0661	0851	0931	1021
	0501	0621	0661	0771	0961		1141	1431	1561	1591	1601
Hallmark	1431	1561	2481				1771	1821	1831	1841	1851
	0051	0621					1861	1931	2081	2101	2311
Hitachi	2381	0031	0051	0161	0191	Sanyo	0051	0261	0401	0431	0791
	0301	0601	0621	0641	0671		0901	1151	2461		
	0811	0821	0951	1011	1061	Sears	0001	0051	0151	0191	0251
	1241	1361	1651	1711	1731		0311	0331	0391	0401	0411
	1741	1751	1761	2041	2051		0431	0621	0661	1041	1081
2131						1151	1481	1521	2461	2481	
Infinity	0631						2501				
JBL	0631					Sharp	2181	0051	0111	0161	0351
JVC	0101	0161	0191	0241	0331		0541	0581	0611	0621	0731
	0511	0561	0601	0741	0991		0891	1101	1561	1721	1871
	1321	1421	2161	2171	2261		1881	1941	2341		
LXI	0001	0311	0391	0411	0431	Sony	1231	0441	1111	1511	2411
	0621	0631	1041	1171	1521		1891	1901	2061	2421	2431
	2491	2501					2401				
Magnavox	0051	0271	0291	0341	0361	Soundesign	0051	0151	0381	0551	0621
	0421	0551	0621	0631	0661		2481				
	0971	0981	1131	2221	2351	Sylvania	0051	0071	0271	0291	0341
Marantz	0051	0481	0621	0631	0641		0361	0421	0551	0621	0631
	2491						0661	0861	1441	2191	2201
Memorex	0081	0431	0501	0621	2491	Tandy	1101				
MGA	0051	0251	0261	0371	0501	Technics	0741				
	0621	0661	0761			Teknika	0051	0081	0151	0161	0191
Mitsubishi	0051	0251	0261	0281	0371		0341	0381	0471	0501	0551
	0491	0501	0621	0661	0761		0621	0851	1271	1401	1561
	2231	2241					2481				
MTC	0051	0501	0621	0851		Wards	0051	0081	0141	0151	0181
NAD	0001	0311	0411	0621	1061		0211	0271	0321	0341	0361
Optonica	0541	1101					0391	0421	0501	0541	0621
Panasonic	2301	0631	0711	0741	1271		0631	0661	1051	1521	2491
	1351	1401	1501	1701	1791		2501				
	1801	2111	2151			Zenith	0011	0051	0081	0781	1281
						1571	2091	2211	2251	2391	
						2361	2441				

Notes

- TOSHIBA code is already set when you operate this recorder for the first time.
- Some brands have several codes. Try one by one until the remote control can operate your TV.
- Even after the recorder's remote control is programmed, it may not operate some or all of the features on your other device. If this happens and you wish to use those features, you will need to use the device's original remote control.
- When replacing the batteries of the remote control, re-enter the brand code of your TV.

Operating the second and third TOSHIBA HDD/DVD video recorders with the remote control of this recorder

Switches the codes to operate the recorder.

If you use the second and third TOSHIBA HDD/DVD video recorders, set the different remote codes for each recorder to avoid confusion in the response of the recorders.

Example: Setting this recorder's remote control mode to DR 2, after another HDD/DVD recorder has been set to DR 1.

(It is necessary to set the remote control mode on both the recorder and the remote control.)

Setting up the recorder

1 Press SETUP.



The setting menu appears.

2 Press ◀/▶ to select "Operational settings", then press ENTER.

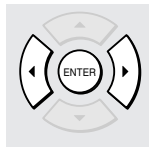

e.g.

Operational settings	
Operation beep	Off
Completion beep	On
IR code	DR 1
Instant skip interval	30 sec.
Instant replay interval	10 sec.
Title thumbnail point	35 sec.
HDD/RAM title play	Title resume
Still group interval	3 sec.
Priority contents	Photo

3 Press ▲/▼ to select "IR code", then press ENTER.

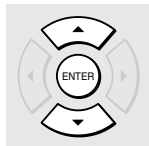

e.g.

Operational settings	
Operation beep	Off
Completion beep	On
IR code	DR 1
Instant skip interval	30 sec.
Instant replay interval	10 sec.
Title thumbnail point	35 sec.
HDD/RAM title play	Title resume
Still group interval	3 sec.
Priority contents	Photo

DR 1
DR 2
DR 3

4 Press ▲/▼ to select "DR 2" (example), then press ENTER.

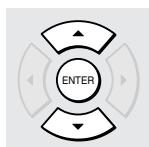

The submenu disappears. Press ENTER button and the IR code you selected is activated. Operation may not be possible temporarily until you set the corresponding mode of the remote control. Proceed to the next setting.



Setting up the remote control

5

While pressing EASY NAVI, press 2.

The remote control mode is set to "DR 2".

Select the same mode that you have set to the recorder.

	Mode setting	
	Recorder	Remote control
When using with DR 1 mode	DR 1 DR 2 DR 3	+
When using with DR 2 mode	DR 1 DR 2 DR 3	+
When using with DR 3 mode	DR 1 DR 2 DR 3	+

Notes

- If the recorder's mode and the remote control's mode are different, the recorder's mode (DR 1, DR 2 or DR 3) appears on the display of the front panel.
- When the batteries of the remote control are replaced or when the time indicator of the front panel flashes, check the remote control modes of both the recorder and the remote control, and re-program it if necessary.

■ Disabling the remote control for a temporary period

You can temporarily disable the reception of the remote control signals at the recorder, when the selection of DR 1, DR 2 and DR 3 is not sufficient while you are using several Toshiba HDD/DVD video recorders.

Press HDD and DVD buttons on the recorder at the same time for three seconds or more.

The recorder display shows "DR - OFF", indicating that the remote control is disabled.

To enable the remote control, perform the same step again. (The display shows "DR-1", "DR-2" or "DR-3" depending on your setting.)

Notes

- This function is not available in Standby mode.
- You cannot use this feature when the power is turned off, if you have set "Front Display" to "Off".

Limited United States Warranty

Digital Audio Video ("DAV") Product-Depot Repair Warranty

Toshiba America Consumer Products, L.L.C., ("TACP") makes the following limited warranties to original consumers in the United States. THESE LIMITED WARRANTIES EXTEND TO THE ORIGINAL CONSUMER PURCHASER OR ANY PERSON RECEIVING THIS DAV PRODUCT AS A GIFT FROM THE ORIGINAL CONSUMER PURCHASER AND TO NO OTHER PURCHASER OR TRANSFEREE.

DAV PRODUCTS PURCHASED IN THE U.S.A. AND USED ANYWHERE OUTSIDE OF THE U.S.A., INCLUDING, WITHOUT LIMITATION, CANADA AND MEXICO, ARE NOT COVERED BY THESE WARRANTIES.

DAV PRODUCTS PURCHASED ANYWHERE OUTSIDE OF THE U.S.A., INCLUDING, WITHOUT LIMITATION, CANADA AND MEXICO, AND USED IN THE U.S.A., ARE NOT COVERED BY THESE WARRANTIES.

Limited Ninety (90) Day Warranty on Labor*

TACP warrants this DAV Product and its parts against defects in materials or workmanship for a period of ninety (90) days after the date of original retail purchase. DURING THIS PERIOD, TACP WILL, AT TACP'S OPTION, REPAIR OR REPLACE A DEFECTIVE PART WITH A NEW OR REFURBISHED PART WITHOUT CHARGE TO YOU FOR PARTS OR LABOR.

Limited One (1) Year Warranty on Parts*

TACP further warrants the parts in this DAV Product against defects in materials or workmanship for a period of one (1) year after the date of original retail purchase. DURING THIS PERIOD, TACP WILL, AT TACP'S OPTION, REPAIR OR REPLACE A DEFECTIVE PART WITH A NEW OR REFURBISHED PART WITHOUT CHARGE TO YOU FOR THE PART, PROVIDED THAT IF A DEFECTIVE PART IS REPAIRED OR REPLACED AFTER NINETY (90) DAYS FROM THE DATE OF ORIGINAL RETAIL PURCHASE, THE CONSUMER SHALL PAY ALL LABOR CHARGES INVOLVED IN THE REPAIR OR REPLACEMENT THEREOF.

*Rental Units

The warranty for DAV Product rental units begins on the date of the first rental or thirty (30) days after the date of shipment to the rental firm, whichever comes first.

*Commercial Units

DAV Products sold and used for commercial purposes have a limited warranty for all parts and labor, which warranty begins on the date of original retail purchase and ends on the date that is ninety (90) days thereafter.

Owner's Manual and Product Registration Card

Read this owner's manual thoroughly before operating this DAV Product.

Complete and mail the enclosed product registration card or register your DAV Product on-line at www.tacp.toshiba.com/service as soon as possible. By registering your DAV Product you will enable TACP to bring you new products specifically designed to meet your needs and help us to contact you in the unlikely event a safety notification is required under the Consumer Product Safety Act. Failure to complete and return the product registration card does not diminish your warranty rights.

Your Responsibility

THE ABOVE WARRANTIES ARE SUBJECT TO THE FOLLOWING CONDITIONS:

- (1) You must retain your bill of sale or provide other proof of purchase.
- (2) All warranty servicing of this DAV Product must be made by the Depot Warranty Repair Center specified by the TACP Consumer Solutions Center.
- (3) The warranties from TACP are effective only if the DAV Product is purchased and operated in the Continental U.S.A. or Puerto Rico.
- (4) Labor service charges for set installation, setup, adjustment of customer controls and installation or repair of antenna systems are not covered by this warranty. Reception problems caused by inadequate antenna systems are your responsibility.
- (5) Warranties extend only to defects in materials or workmanship as limited above and do not extend to any DAV Product or parts that have been lost or discarded by you or to damage to DAV Product or parts caused by fires, misuse, accident, Acts of God, such as lightning or fluctuations in electric power, improper installation, improper maintenance or use in violation of instructions furnished by TACP; use or malfunction through simultaneous use of this DAV Product and connected equipment; or to units that have been modified or had the serial number removed, altered, defaced, or rendered illegible.

How to Obtain Warranty Services

If, after following all of the operating instructions in this manual and checking the section "Before calling service personnel", you find that service is needed:

- (1) For instructions on how to obtain warranty service for your DAV Product, contact TACP's Consumer Solution Center toll-free at 1-800-631-3811.
- (2) You must include a copy of original bill of sale or other proof of purchase along with the entire DAV Product to the Depot Warranty Repair Center specified by the TACP Consumer Solutions Center. You are responsible for all inbound transportation and insurance charges for the DAV Product to the Depot Warranty Repair Center specified by the TACP Consumer Solutions Center.

For additional information, visit TACP's web site:
www.tacp.toshiba.com.

ALL WARRANTIES IMPLIED BY THE LAW OF ANY STATE OF THE U.S.A., INCLUDING THE IMPLIED WARRANTIES OF MERCHANTABILITY AND FITNESS FOR A PARTICULAR PURPOSE, ARE EXPRESSLY LIMITED TO THE DURATION OF THE LIMITED WARRANTIES SET FORTH ABOVE. WITH THE EXCEPTION OF ANY WARRANTIES IMPLIED BY THE LAW OF ANY STATE OF THE U.S.A. AS HEREBY LIMITED, THE FOREGOING WARRANTY IS EXCLUSIVE AND IN LIEU OF ALL OTHER WARRANTIES, GUARANTEES, AGREEMENTS, AND SIMILAR OBLIGATIONS OF TACP WITH RESPECT TO THE REPAIR OR REPLACEMENT OF ANY PARTS. IN NO EVENT SHALL TACP BE LIABLE FOR CONSEQUENTIAL OR INCIDENTAL DAMAGES (INCLUDING, BUT NOT LIMITED TO, LOST PROFITS, BUSINESS INTERRUPTION, OR MODIFICATION OR ERASURE OF RECORDED DATA CAUSED BY USE, MISUSE OR INABILITY TO USE THIS DAV PRODUCT).

No person, agent, distributor, dealer or company is authorized to change, modify or extend the terms of these warranties in any manner whatsoever. The time within which an action must be commenced to enforce any obligation of TACP arising under the warranty or under any statute, or law of the United States or of any state thereof, is hereby limited to ninety (90) days from the date you discovered or should have discovered, the defect. This limitation does not apply to implied warranties arising under state law.

THIS WARRANTY GIVES YOU SPECIFIC LEGAL RIGHTS AND YOU MAY ALSO HAVE OTHER RIGHTS WHICH MAY VARY FROM STATE TO STATE IN THE U.S.A. SOME STATES OF THE U.S.A. DO NOT ALLOW LIMITATIONS ON HOW LONG AN IMPLIED WARRANTY LASTS, WHEN AN ACTION MAY BE BROUGHT, OR THE EXCLUSION OR LIMITATION OF INCIDENTAL OR CONSEQUENTIAL DAMAGES, SO THE ABOVE PROVISIONS MAY NOT APPLY TO YOU UNDER SUCH CIRCUMSTANCES.



**- IMPORTANT -
CANADIAN WARRANTY INFORMATION
GARANTIE CANADIENNE**

STANDARD WARRANTY TYPE OF SET	DVD Player DVD/VCR Combination Home Theatre in a Box DVD Recorder Portable DVD	GARANTIE NORMALE TYPE D'APPAREIL	Lecteur DVD DVD/magnétoscope combo Cinéma maison dans une boîte Enregistreur DVD DVD Portatif
WARRANTY PERIOD	12 MONTHS	DURÉE DE LA GARANTIE:	12 MOIS

CANADIAN WARRANTY

Toshiba of Canada Limited (TCL) makes the following limited warranties to original consumers in Canada. Please retain your "Bill of Sale" as proof of purchase. **To obtain a "Canadian Warranty" please register online at www.toshiba.ca.**

GARANTIE CANADIENNE

1) Toshiba du Canada Limitée (TCL) offre au Canada les garanties limitées suivantes aux consommateurs originaux. Veuillez conserver votre « facture » comme preuve d'achat. **Pour obtenir une garantie canadienne, veuillez vous inscrire en ligne à www.toshiba.ca**

Canadian Warranty Information

Should service be required on this unit during the one year warranty period, TCL's option will be to repair or exchange the defective unit. It will be necessary to follow this procedure:

Contact: Toshiba of Canada Limited at the Consumer Electronics Group, customer support line.

Phone: 1-800-268-3404

Email: ceg_customer_support@toshiba.ca

All in-warranty repairs must be made by an authorized TCL service centre.

For service exchange TCL will arrange to have the unit picked up by courier and a replacement unit will be returned via same courier. (Note: A major credit card number will be required as a charge of \$25.00 will apply if no fault is found with the unit.) During the first 3 months of ownership, a new unit will be supplied as a replacement. During the remainder of the warranty period a service-renewed unit will be supplied.

The original "Bill of Sale" must be provided as proof of purchase (it will be returned with the replacement unit.)

This 12-month warranty will be strictly adhered to.

Out of warranty units should be repaired by a TCL authorized service centre.

Note: It is the responsibility of the owner to ensure proper packaging. Should damage in shipping occur, due to poor packaging, a charge back for the repair will result.

This warranty applies to the original purchaser only and is not transferable.

This warranty does not apply to sets that have been subjected to misuse, neglect, accident, physical damage or acts of nature.

Sets with the serial number removed, altered, replaced or defaced will not be covered by this warranty.

The warranties from TCL are effective only if the product is purchased in Canada from an authorized TCL dealer and operated in Canada.

Products utilized for rental or commercial purposes are not covered by this warranty.

This warranty is in lieu of all other warranties, guaranties or agreements, whether expressed or implied, and no person, agent distributor, dealer, service centre or company is authorized to change, modify or extend its terms in any manner whatsoever.

Information sur la garantie Canadienne

Si vous avez besoin de service sur cet appareil au cours de l'année de garantie, Toshiba du Canada Limitée aura l'option de réparer ou échanger l'appareil défectueux. Vous devrez suivre la procédure suivante:

Contact: Toshiba du Canada Limitée au Groupe Électronique aux consommateurs, service à la clientèle.

Tél: 1-800-268-3404

Courriel: ceg_customer_support@toshiba.ca

Toutes les réparations au cours de la garantie doivent être faites par un centre de service autorisé Toshiba.

Pour un échange TCL s'assurera qu'un service de courrier ramassera l'unité et qu'un appareil de remplacement soit expédié par le même service de courrier.

(Note: Un numéro de carte de crédit sera requis car une charge de 25,00\$ sera appliquée si toutefois l'appareil n'avait aucun problème de fonctionnement.)

Une nouvelle unité sera fournie comme remplacement durant les premiers 3 mois de propriété. Par contre durant la balance de la garantie une unité remise à neuf sera fournie.

La «facture» originale doit être fournie comme preuve d'achat (elle vous sera retournée avec l'unité de remplacement.)

Cette garantie de 12 mois sera strictement adhéree.

Les unités hors de garantie devraient être réparées par un centre de service autorisé Toshiba.

Note: C'est la responsabilité du propriétaire de s'assurer que l'emballage est adéquat. Vous serez facturé pour toutes réparations causées par des dommages encourus à cause d'un emballage non adéquat.

Cette garantie est octroyée à l'acheteur initial et n'est pas transférable. Cette garantie ne s'applique pas aux appareils qui ont été sujets aux abus, négligences, accidents, dommages physiques ou actes naturels.

Les appareils dont le numéro de série a été enlevé, altéré, remplacé ou barbouillé ne sont pas couverts par cette garantie.

Les garanties de TCL sont valides seulement sur les unités qui sont achetées et utilisées au Canada d'un marchand autorisé TCL.

Cette garantie ne couvre pas les produits de location ou à usage commercial. Cette garantie remplace toutes autres garanties ou ententes exprimées ou sous-entendues. Aucune personne, agent, distributeur, concessionnaire ou compagnie n'est autorisée à changer, modifier ou prolonger les termes de cette garantie de quelque façon que ce soit.

Memo

Introduction

Connections

Basic setup

TOSHIBA



Printed on 70% Recycled Paper

Download from Www.Somanuals.com. All Manuals Search And Download.

Printed in China

Free Manuals Download Website

<http://myh66.com>

<http://usermanuals.us>

<http://www.somanuals.com>

<http://www.4manuals.cc>

<http://www.manual-lib.com>

<http://www.404manual.com>

<http://www.luxmanual.com>

<http://aubethermostatmanual.com>

Golf course search by state

<http://golfingnear.com>

Email search by domain

<http://emailbydomain.com>

Auto manuals search

<http://auto.somanuals.com>

TV manuals search

<http://tv.somanuals.com>