

TOSHIBA

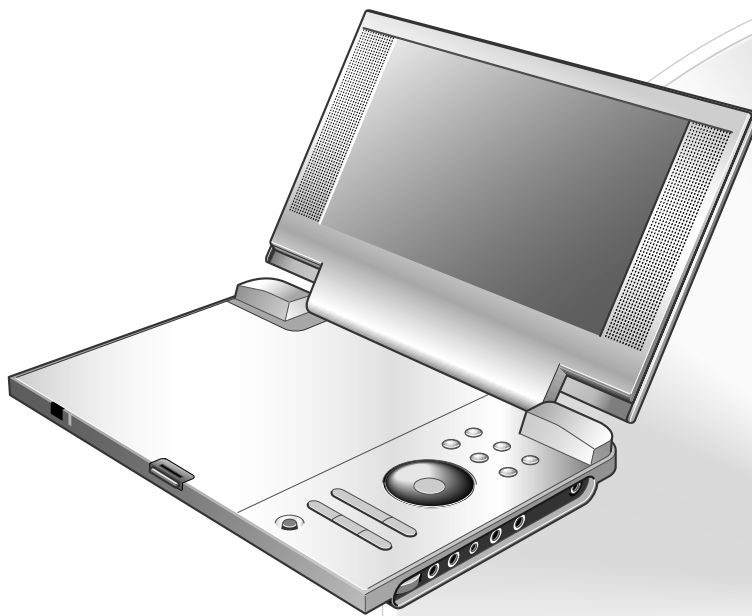

PORTABLE DVD PLAYER **SD-P1880SE**

OWNER'S MANUAL



Introduction 2

Basic playback 17

Advanced playback 31

Function setup 45

Connections 53

Others 65

SAFETY PRECAUTIONS

WARNING: TO REDUCE THE RISK OF FIRE OR ELECTRIC SHOCK, DO NOT EXPOSE THIS APPLIANCE TO RAIN OR MOISTURE. DANGEROUS HIGH VOLTAGES ARE PRESENT INSIDE THE ENCLOSURE. DO NOT OPEN THE CABINET. REFER SERVICING TO QUALIFIED PERSONNEL ONLY.

CAUTION: This equipment employs a Laser System.
To ensure proper use of this product, please read this owner's manual carefully and retain for future reference. Should the unit require maintenance, contact an authorised service location - see service procedure.

Use of controls or adjustments or performance of procedures other than those specified herein may result in hazardous radiation exposure.

To prevent direct exposure to laser beam, do not try to open the enclosure.
Visible and invisible laser radiation when open and interlocks defeated.
DO NOT STARE INTO BEAM.

This equipment is categorized as "Class 1 Laser Product" in EN60825, the European common laser standard.



In the spaces provided below, record the Model and Serial No. located on the bottom of your DVD player.

Model No. _____ Serial No. _____

Retain this information for future reference.

About disposal

The cold cathode fluorescent lamp in the LCD panel contains a small amount of mercury. Please follow local ordinances or regulations when you dispose of the product.

Location of the required

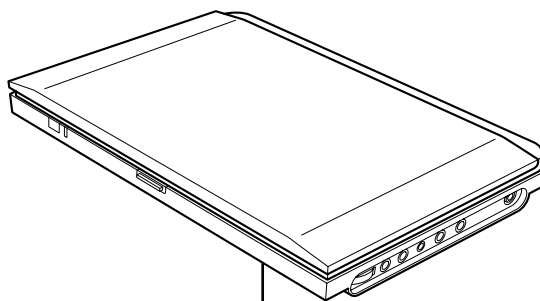
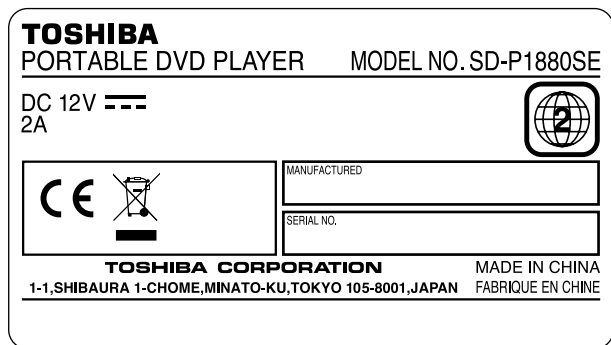

Following information is only for EU-member states:

The use of the symbol indicates that this product may not be treated as household waste. By ensuring this product is disposed of correctly, you will help prevent potential negative consequences for the environment and human health, which could otherwise be caused by inappropriate waste handling of this product. For more detailed information about recycling of this product, please contact your local city office, your household waste disposal service or the shop where you purchased the product.

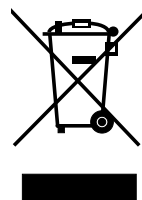

IMPORTANT SAFETY INSTRUCTIONS

CAUTION: PLEASE READ AND OBSERVE ALL WARNINGS AND INSTRUCTIONS GIVEN IN THIS OWNER'S MANUAL AND THOSE MARKED ON THE UNIT. RETAIN THIS BOOKLET FOR FUTURE REFERENCE.

This unit is fully transistorized and does not contain any parts that can be repaired by the user.

DO NOT REMOVE THE CABINET COVER, OR YOU MAY BE EXPOSED TO DANGEROUS VOLTAGE. REFER SERVICING TO QUALIFIED SERVICE PERSONNEL ONLY.

1. Read these instructions.
2. Keep these instructions.
3. Heed all warnings.
4. Follow all instructions.
5. Do not use this apparatus near water.
6. Clean only with dry cloth.
7. Do not install near any heat sources such as radiators, heat registers, stoves, or other apparatus (including amplifiers) that produce heat.
8. Do not insert any foreign objects into the disc holder or the memory card slot. Heat build-up or fire may result.
9. Protect the power cord from being walked on or pinched particularly at plugs, convenience receptacles, and the point where they exit from the apparatus.
10. Only use attachments/accessories specified by the manufacturer.
11. Unplug this apparatus during lightning storms or when unused for long periods of time. However, while it is thundering or lightning, do not touch the apparatus and any connected cable and/or equipment. This will prevent you from receiving the electric shock by an electric surge.
12. Refer all servicing to qualified service personnel. Servicing is required when the apparatus has been damaged in any way, such as power-supply cord or plug is damaged, liquid has been spilled or objects have fallen into the apparatus, the apparatus has been exposed to rain or moisture, does not operate normally, or has been dropped.

ADDITIONAL SAFETY INSTRUCTIONS

13. When you use headphones, keep the volume at a moderate level. If you use the headphones continuously with high volume sound, it may cause hearing damaged.
14. Do not overload wall outlets; extension cords, or integral convenience receptacles as this can result in a risk of fire or electric shock.
15. Apparatus shall not be exposed to dripping or splashing and no objects filled with liquids, such as vases, shall be placed on the apparatus and/or around it.
16. Be careful not to catch your fingers in the disc holder when closing the lid. It may cause personal injury.
17. Do not put a vessel containing liquid such as a vase, or a metal object on the apparatus. If liquid or a foreign metal object is let into the apparatus, it may cause fires or electric shock.
18. Do not use a cracked, deformed, or repaired disc. These discs are easily broken and may cause serious personal injury and apparatus malfunction.
19. Do not touch a spinning disc. When you open the disc holder, the disc may have not stopped spinning. Touching a spinning disc may cause personal injury or damage to the product.
20. Do not rest the product on your lap or other parts of body. The product may become warm during use. Even low temperatures may cause personal injury when exposed to your skin for prolonged periods.
21. Use the supplied AC adapter to operate the product. Substitute devices not specified by the manufacturer may result in fire or product malfunction. Do not cover the AC adapter with a blanket or place it near heating or on electric carpet when it is in use.
22. When you use this product in an airplane, follow the instructions of the airline. Disregarding them may cause harmful interference to radio communication.
23. Do not stare at the pick-up lens or look at the laser beam. Doing so may cause damage to eyesight.

24. Do not use this product while walking or driving. Neglecting this may cause a traffic accident.
25. CAUTION: If the DVD player is dropped and the cabinet or enclosure surface has been damaged or the DVD player does not operate normally, take the following precautions:
- ALWAYS turn off the DVD player and unplug the power cord to avoid possible electric shock or fire.
 - NEVER allow your body to come in contact with any broken glass or liquid from the damaged DVD player. The LCD panel inside the DVD player contains glass and a toxic liquid. If the liquid comes in contact with your mouth or eyes, or your skin is cut by broken glass, rinse the affected area thoroughly with water and consult your doctor.
 - ALWAYS contact a service technician to inspect the DVD player any time it has been damaged or dropped.
26. Use the player in a location that facilitates the immediate removal of the plug if there is a malfunction or failure.
27. Do not allow children to scratch, lick or put the memory card into their mouth. Keep the memory card out of the reach of children. Injury to the child or malfunction may result.
28. Battery Pack
- a) Never throw the battery pack into a fire, as that could cause the battery pack to explode. Never heat the battery pack, as that could cause leakage of alkaline solution or other electrolytic substance.
 - b) Never disassemble the battery pack, as that could cause leakage of alkaline solution or other electrolytic substance.
 - c) Never short-circuit the battery pack by either accidentally or intentionally bringing the terminals in contact with another metal object. This could cause personal injury or a fire, and could also damage the battery pack.
 - d) Never drive a nail into the battery pack. Never strike the battery pack with a hammer. Never step or tread on the battery pack.
 - e) If you ever smell an unusual odor, excessive heat, discoloration, or deformation of the battery pack, remove it from the player after confirming safety and discontinue use of it. Take the battery pack to an authorized Toshiba service provider.
 - f) Keep the battery pack away from heat or fire.
 - g) Never dispose of used battery packs with other ordinary solid wastes, since they contain toxic substances. Always dispose of used battery packs in accordance with community regulations that apply to the disposal of batteries. Cover the metal terminals with insulating tape, in order to prevent accidental short-circuiting.
- h) Always confirm that the battery pack is compatible with your player, before attaching the battery pack to the player.
 - i) Never expose the terminals of the battery pack to any other metal object. Wrap the battery or place it in a protective plastic bag, whenever transporting it.
 - j) Always confirm that the temperature is between 5 and 35°C (41°F and 95°F) before you charge the battery. Leakage, excessive heat, or deterioration of the battery pack may occur if this caution is not heeded.
- k) Never immerse the battery pack in any liquid.
- l) Never expose the battery pack to direct sunlight. Never store or use the battery pack in a locked and unventilated vehicle. (where excessive internal temperatures may be encountered.)
- m) Always keep the battery pack out of reach of infants or small children.
 - n) Never shock the battery pack by dropping or throwing it.
 - o) If the liquid contained within the battery pack leaks, use a large amount of water and immediately wash off any liquid which may accidentally contact any part of the body. Remove any liquid that has contacted your clothing by washing it immediately with a detergent.
 - p) Always confirm that a "click" sound has resulted, when attaching the battery pack to the player. This sound confirms that the battery pack has been properly attached.
29. Coin-shaped Battery
- a) Keep coin-shaped batteries out of children's reach. Be careful not to ingest internally, especially by children, as doing so may cause poisoning.
 - b) Do not load a battery into the remote control with the wrong side out.
 - c) Do not charge, heat, open, or short-circuit the batteries. Do not throw the batteries into a fire.
 - d) Do not leave a dead or exhausted battery in the remote control.

IMPORTANT SAFETY INSTRUCTIONS

- e) If you do not use the remote control for a long period of time, remove the battery to avoid possible damage from battery corrosion.
30. After unpacking coin-shaped batteries, store them in poly bags, etc. separately one by one when unused. If you leave them unwrapped, they may be short-circuited by contact with metal objects, resulting in battery leakage, heat or bursting. This may cause burns or injury.
The batteries must be completely discharged when they are deposited in collection containers for old batteries. If a charge remains, countermeasures to prevent short circuits must be taken.
31. To reduce the risk of fire or electric shock, do not expose this apparatus to rain or moisture.
32. Following mark means "CAUTION - RISK OF ELECTRIC SHOCK - DO NOT OPEN".



33. Vehicle adapter and operation in a car
- a) NEVER operate the apparatus or view a DVD Video while operating an automobile or other vehicle. Note: doing so is illegal in many jurisdictions.
NEVER place a apparatus within the eyesight of a driver while he/she is driving an automobile/vehicle. Note: an apparatus located in the front seating section of a vehicle is illegal in many jurisdictions.
Failure to observe the above instructions could result in the driver's inattention to and/or distraction from road hazards.
- b) NEVER place an apparatus in a location where it could interfere with the proper deployment and/or performance of an air bag. Failure to observe this instruction could result in the prevention of an air bag to properly and/or effectively deploy.
- c) Do not use a vehicle adapter other than the model supplied, to power the apparatus. Do not use the supplied vehicle adapter to power an apparatus other than this apparatus. Neglecting these may cause smoke, fire or electrical shock to human body.
- d) This adapter is intended for exclusive use in automobiles/vehicles with a DC 12V negative ground electrical system.
NEVER use this adapter with a DC 24V configured automobile/vehicle.
Consult your vehicle owner's manual before using this adapter.
- e) When handling, using or storing the adapter power cord NEVER:
- Place or locate near any apparatus that produces heat.
 - Disassemble, splice or extend the cord.
 - Pull, force or place any heavy objects on the cord.
 - Bend, twist or bind the cord.
- f) Keep away from the driving device (such as brake pedal, etc.) and the moving equipment (such as a seat rail, car windows, door, etc.).
- g) NEVER disassemble or alter this adapter in any manner.
- h) ALWAYS use caution when touching the adapter, cigarette lighter socket or power port. The adapter, lighter socket and power port may become heated after prolonged use.
- i) ALWAYS remove the adapter from the cigarette lighter socket or power port when not in use.
- j) Do not charge the battery pack which is attached to the apparatus by the adapter. Doing so may cause smoke, fire or electrical shock to human body. Whenever you use the adapter, be sure to remove the battery pack from the apparatus to prevent it from being charged by the adapter.
- k) Some cars may not have a compatible socket. NEVER modify this adapter to fit an incompatible cigarette lighter socket and/or power port. NEVER modify an incompatible cigarette lighter socket and/or power port to accept this adapter.
Failure to observe the above warnings could cause smoke, fire, burns and/or electric shock.
- l) ALWAYS locate the apparatus on a level and secure surface. If placed on an uneven, shaky, unsecured or unstable surface, apparatus may fall.
Failure to observe the above caution could result in the apparatus striking a person.
- m) When using the adapter, insert the plug of the adapter into the cigarette lighter socket or power port fully.
The incomplete insertion will cause smoke or fire.
- n) Do not touch the adapter with wet hands. Do Not expose the adapter to water or liquid.

Notes on handling

- Do not shock the LCD monitor. It may cause unit damage and malfunction.
- Do not use the player in a place subject to vibration. Neglecting this may cause malfunction of the player or damage to the disc.
- Do not leave the player in a vehicle. Rise or drop in temperature may result in malfunction of the player.
- When transporting the player, the original shipping carton and packing materials come in handy. For maximum protection, repack the unit as it was originally packaged at the factory.
- Do not use volatile liquids, such as insect spray, near the player. Do not leave rubber or plastic products in contact with the player for a long time. They will leave marks on the finish.
- The player may become warm after a long period of use. This is not a malfunction.
- When the player is not in use, be sure to remove the disc and turn off the power.
- If you do not use the player for a long period, the unit may not function properly in the future. Turn on and use the player occasionally.

Notes on locating

- When you place this player near a TV, radio, or VTR, the playback picture may become poor and the sound may be distorted. In this case, move the player away from the TV, radio, or VTR.

Notes on cleaning

- Use a soft, dry cloth for cleaning. Do not use any type of solvent, such as thinner and benzene, as they may damage the surface of the player. If you use a chemical saturated cloth to clean the unit, follow that product's instructions.
- When cleaning the LCD monitor, use a soft, dry cloth.

Notes on moisture condensation

Moisture condensation damages the player. Please read the following carefully.

Moisture condensation occurs, for example, when you pour a cold drink into a glass on a warm day. Drops of water form on the outside of the glass. In the same way, moisture may condense on the optical pick-up lens inside this unit, one of the most crucial internal parts of the player.

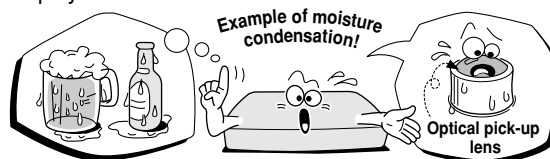

■ **Moisture condensation occurs during the following cases.**

- When you transport the player directly from a cold place to a warm place.
- When you use the player in a room where you just turned on the heater, or a place where the cold air from the air conditioner directly hits the unit.
- In summer, when you use the player in a hot and humid place just after you move the unit from an air conditioned room.
- When you use the player in a humid place.

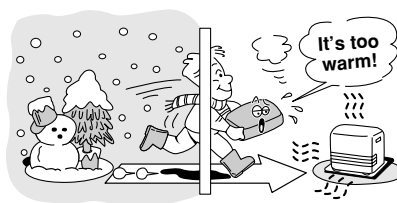

■ **Do not use the player when moisture condensation may occur.**

If you use the player in such a situation, it may damage discs and internal parts. Remove the disc, connect the AC adapter, turn on the player, and leave it for two or three hours. After two or three hours, the player will have warmed up and evaporated any moisture.



Notes and Information

Structure of disc contents

Normally, DVD video discs are divided into titles, and the titles are sub-divided into chapters. VIDEO CDs/ audio CDs are divided into tracks.

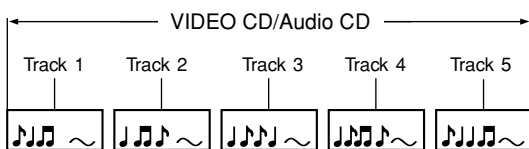
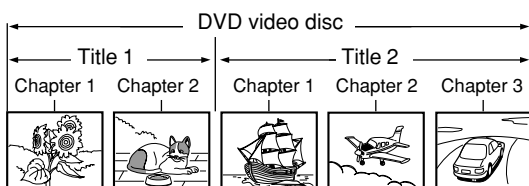

Each title, chapter, or track is assigned a number, which is called "title number", "chapter number" or "track number" respectively. There may be discs that do not have these numbers.

On handling discs

- Do not touch the playback side of the disc.

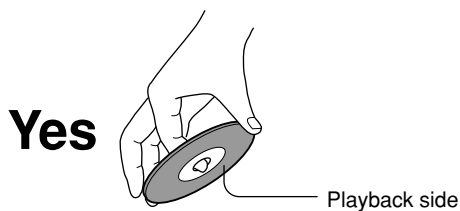

- Do not attach paper or tape to discs.



On cleaning discs

- Fingerprints and dust on the disc may cause picture and sound deterioration. Wipe the disc from the center outwards with a soft cloth. Always keep the disc clean.



- Do not use any type of solvent such as thinner, benzene, commercially available cleaners or antistatic spray for vinyl LPs. It may damage the disc.

On storing discs

- Do not store discs in a place subject to direct sunlight or near heat sources.
- Do not store discs in places subject to moisture and dust such as a bathroom or near a humidifier.
- Store discs vertically in a case. Stacking or placing objects on discs outside of their case may cause warping.

Notes on copyright

It is forbidden by law to copy, broadcast, show, broadcast on cable, play in public, and rent copyrighted material without permission.

DVD video discs are copy protected, and any recordings made from these discs will be distorted.



This product incorporates copyright protection technology that is protected by method claims of certain U.S. patents and other intellectual property rights owned by Macrovision Corporation and other rights owners. Use of this copyright protection technology must be authorized by Macrovision Corporation, and is intended for home and other limited viewing uses only unless otherwise authorized by Macrovision Corporation. Reverse engineering or disassembly is prohibited.

About this owner's manual

This owner's manual explains the basic instructions of this player. Some DVD video discs are produced in a manner that allows specific or limited operation during playback. As such, the player may not respond to all operating commands. This is not a defect in the player. Refer to instruction notes of discs.









"Ⓢ" may appear on the screen during operation. A "Ⓢ" means that the operation is not permitted by the player or the disc.

Notes on region numbers

The region number of this player is 2. Region numbers, corresponding to specific geographical playback area, are printed on your DVD video disc. If you do not find  or , disc playback will not be allowed by the player. (In this case, the player will display a message on-screen.)

Playable discs

This player can play the following discs.

| Disc | Disc Mark | Disc Size | Contents | |
|----------------|---|-------------------------|--|---|
| DVD Video disc |   | 12cm/8cm | •Video(moving pictures)+Audio | |
| DVD-RW disc |  | 12cm | •Video+Audio(DVD VR(Video Recording) format)* •Video+Audio(DVD Video format)* *Finalized discs only. | |
| DVD-R disc |  | 12cm | •Video+Audio(DVD Video format)* *Finalized discs only. | |
| Video CDs |  | 12cm/8cm | •Video(moving pictures)+Audio | |
| Audio CDs |  | 12cm/ 8cm(CD single) | •Audio | |
| CD-ROM |  | 12cm | •Audio (MP3/WMA files) •Movie(DivX) •Photograph(JPEG files) | |
| CD-R/RW disc |  | 12cm | •Audio (CD-DA, MP3/WMA files) •Movie(DivX) •Photograph(JPEG files) | *CD-R/RW discs of CD-DA or VIDEO CD format Some of these discs may be incompatible. |

- You cannot play discs other than those listed above.
- You cannot play discs of DVD-RAM or non-standardized discs, etc., even if they may be labeled as above.
- This player uses the PAL/NTSC colour system, and cannot play DVD video discs recorded in any other colour system (SECAM, etc.).
- Depending on the data recording method or the disc status, playback on this player may not be possible, even if the disc is labeled as above. Toshiba cannot assure that all discs bearing the DVD or CD logos will operate as expected.

On VIDEO CDs

This player supports VIDEO CDs equipped with the PBC (Version 2.0) function. (PBC is an abbreviation for Playback Control.)







You can enjoy two playback variations depending on types of discs.

- VIDEO CD not equipped with PBC function (Version 1.1)
Sound and movie can be played on this player in the same way as an audio CD.
- VIDEO CD equipped with PBC function (Version 2.0)
In addition to operation of a VIDEO CD not equipped with the PBC function, you can enjoy playback of interactive software with search function by using the menu displayed on the screen (Menu Playback). Some functions described in this owner's manual may not work with all discs.

Notes and Information (continued)

Playable memory cards

This player can play the following memory cards.

| Card | Card Mark | Contents | |
|------------------------|---|--|--|
| SD Memory Card |  | <ul style="list-style-type: none"> • Audio (MP3/WMA) • Movie (DivX[®]) • Photograph (JPEG) | <ul style="list-style-type: none"> • SD is a trademark. • MMC and MultiMediaCard are trademarks of Infineon Technologies AG and licensed to MMCA (MultiMediaCard Association). • "Memory Stick" and  are trademarks of Sony Corporation. •  or xD-Picture Card[™] is a trademark of Fuji Photo Film Co. Ltd. • You cannot play back DivX DRM written to a memory card. |
| Multi Media Card |  | <ul style="list-style-type: none"> • Audio (MP3/WMA) • Movie (DivX[®]) • Photograph (JPEG) | |
| Memory Stick |  MEMORY STICK | <ul style="list-style-type: none"> • Audio (MP3/WMA) • Movie (DivX[®]) • Photograph (JPEG) | |
| xD- Picture Card |  xD-Picture Card [™] | <ul style="list-style-type: none"> • Audio (MP3/WMA) • Movie (DivX[®]) • Photograph (JPEG) | |

Notes on memory cards

Some memory cards may not be played back due to its capacity and/or manufacturer, etc.

Do not insert any memory card other than those memory cards referred to above. Failure to follow this instruction may cause a malfunction of the player and/or card.

■ Saving data

- It is recommended that you back up your memory card data. Toshiba is not liable for any damage caused by the use of any memory card with this DVD player. Toshiba will not compensate for any lost data or recording(s) caused by the use of such cards.
- For instructions on using your memory card, refer to the owner's manual for your memory card.
- Failure to take proper care of a memory card may prevent the display of pictures from the card. Such damage is not covered by your Toshiba Warranty.

■ Notices for use

- Ensure that you insert the memory card correctly into this player.
- Do not eject the memory card while it is in use. If ejected while in use information on the memory card may be lost.
- This memory card is a precision electrical instrument. Do not bend, drop or apply strong force to it.
- Do not use or store the memory card in an environment of high static electricity or electrical interference.
- Avoid using or storing in areas of high temperature and humidity.
- Be careful not to touch with your fingers, nor allow foreign objects to come in contact with nor dirt to accumulate on the metal area (gold-colored area) of the memory card. Wipe off any dirt with a soft, dry cloth.

- When carrying or storing the memory card always place it inside of its antistatic case to avoid any effects from static electricity. If there is a storage case, place the memory card in the antistatic area of the storage case.
- If you place a memory card that has been exposed to static electricity in this player, there is a chance that this player could malfunction.
- Do not place the memory card in your pants pocket. The memory card may break if any strong force is applied, such as when sitting.
- When ejecting the memory card after extended use it may feel warm to the touch. This is normal. The memory card is not malfunctioning.
- The memory card is designed to have a long life but after extended use you will not be able to delete from or write to it. Please purchase another.

■ Write Protection of SD Memory Card

- Switch the write protect tab at the side of the SD card to "LOCK".

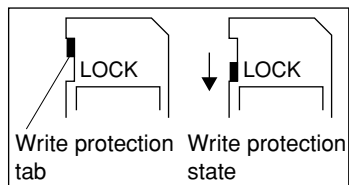

■ About Memory Stick

Magic Gate and high speed data transmission are not available on this player.

Table of Contents

Introduction

- SAFETY PRECAUTIONS 2
- IMPORTANT SAFETY INSTRUCTIONS ... 4
- Precautions 7
- Notes and Information 8
 - Notes on region numbers 9
- Identification of Controls 12
 - Main unit 12
 - Side view 13
 - Front view 13
 - Remote control 14
 - Loading the remote control battery 15
 - Operating with the remote control 15
- Power Connection 16

Basic playback

- Playing a Disc 18
 - Basic playback 18
- Variable Speed Playback 22
 - Playing in fast reverse or fast forward directions 22
 - Playing frame by frame 22
 - Playing in slow-motion 23
 - Resuming playback from the stopped location .. 23
- Locating a Specific Title, Chapter, or Track 24
 - Locating a title using the top menu 24
 - Locating a specific chapter or track 24
- Directly Accessing a Specific Location... 25
 - Entering the time counter of the desired location ... 25
- Playing MP3/WMA Audio or DivX® Video Files 26
 - Playing MP3/WMA audio or DivX® video files 26
- Viewing JPEG Files 27
 - Viewing JPEG Files 27

Advanced playback

- Repeat Play 32
 - Repeating a title, chapter, or track 32
 - Repeating a specific segment 32
- Playing in a Favorite Order 33
 - Setting titles, chapters, or tracks in a favorite order 33
- Playing in Random Order 34
 - Playing, chapters or tracks in random order ... 34
- Zooming a Picture 35
 - Zooming a picture 35

- Selecting the Sound Enhancement (E.A.M.*) .. 36
 - Selecting the sound enhancement 36
- Selecting a Camera Angle 37
 - Changing the camera angle 37
- Selecting Subtitles 38
 - Selecting a subtitle language 38
- Selecting a Language 39
 - Selecting a playback audio setting 39
- On-screen Display Mode 41
 - On-Screen Display 41
- Adjusting the Picture 43
 - Adjusting the picture 43

Function setup

- Customizing the Function Settings 46
 - Setting procedure 46
 - Setting details 48

Connections

- Connecting to a TV or audio system 54
 - Connecting to a TV 54
 - Connecting to an audio system 55
- Connecting to Headphones 56
- Viewing Pictures From Connected Video Equipment 56
- Connecting to Audio Equipment 57
 - Connecting to an amplifier equipped with a Dolby Digital decoder 58
 - Connecting to an amplifier equipped with a DTS decoder 58
 - Connecting to an amplifier equipped with an MPEG2 audio decoder 59
 - Connecting to an amplifier equipped with a digital audio input 59
- Using the Battery Pack 60
- Using the automobile/vehicle adapter or power port 62

Others

- Before Calling Service Personnel 66
- Specifications 68
- Customer Helpline 69

Identification of Controls

See the page in for details.

Main unit

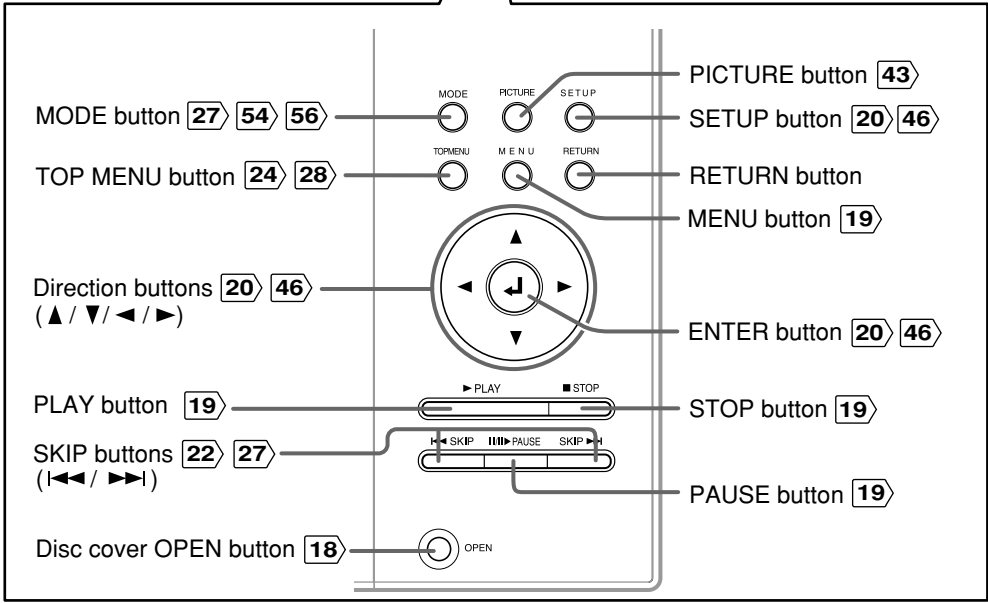
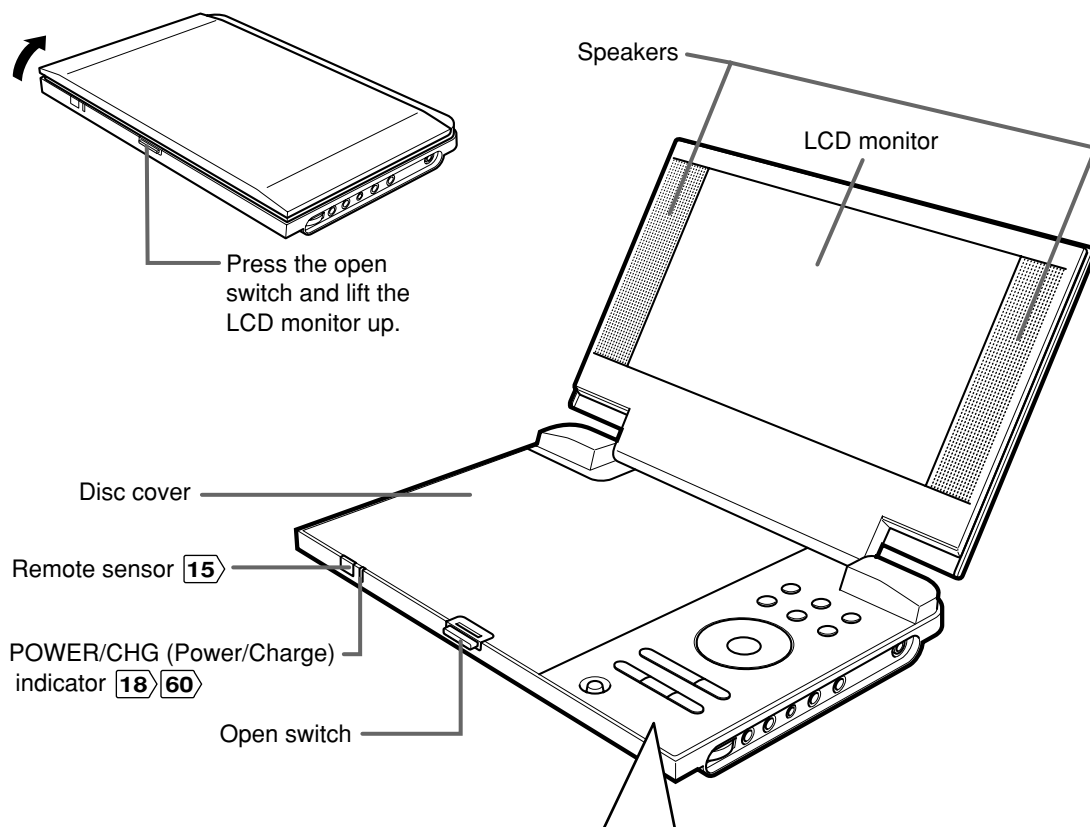

Side view

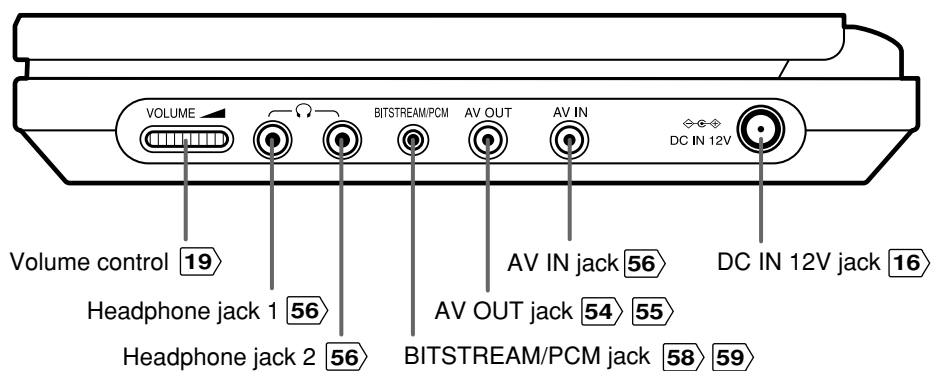
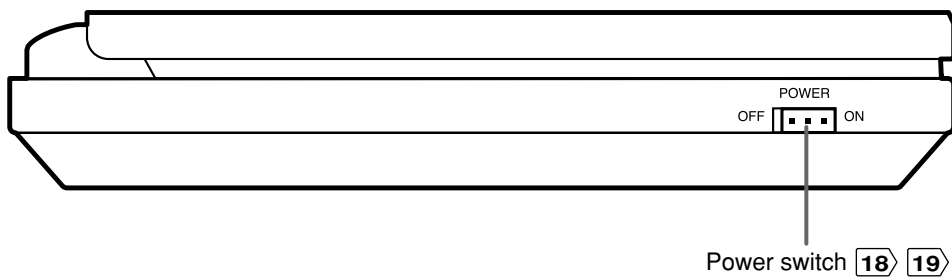

Front view

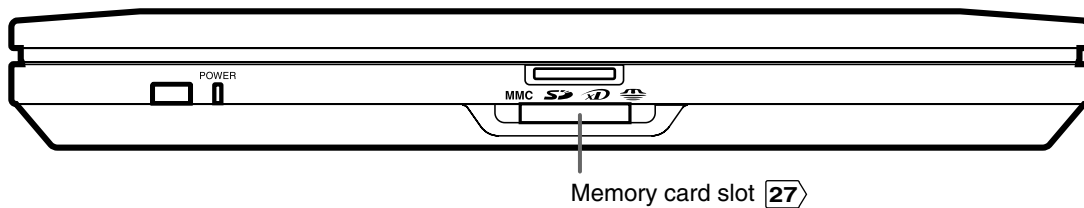

Identification of Controls (continued)

The instructions in this manual describe the functions of the remote control. See the page in for details.

Remote control

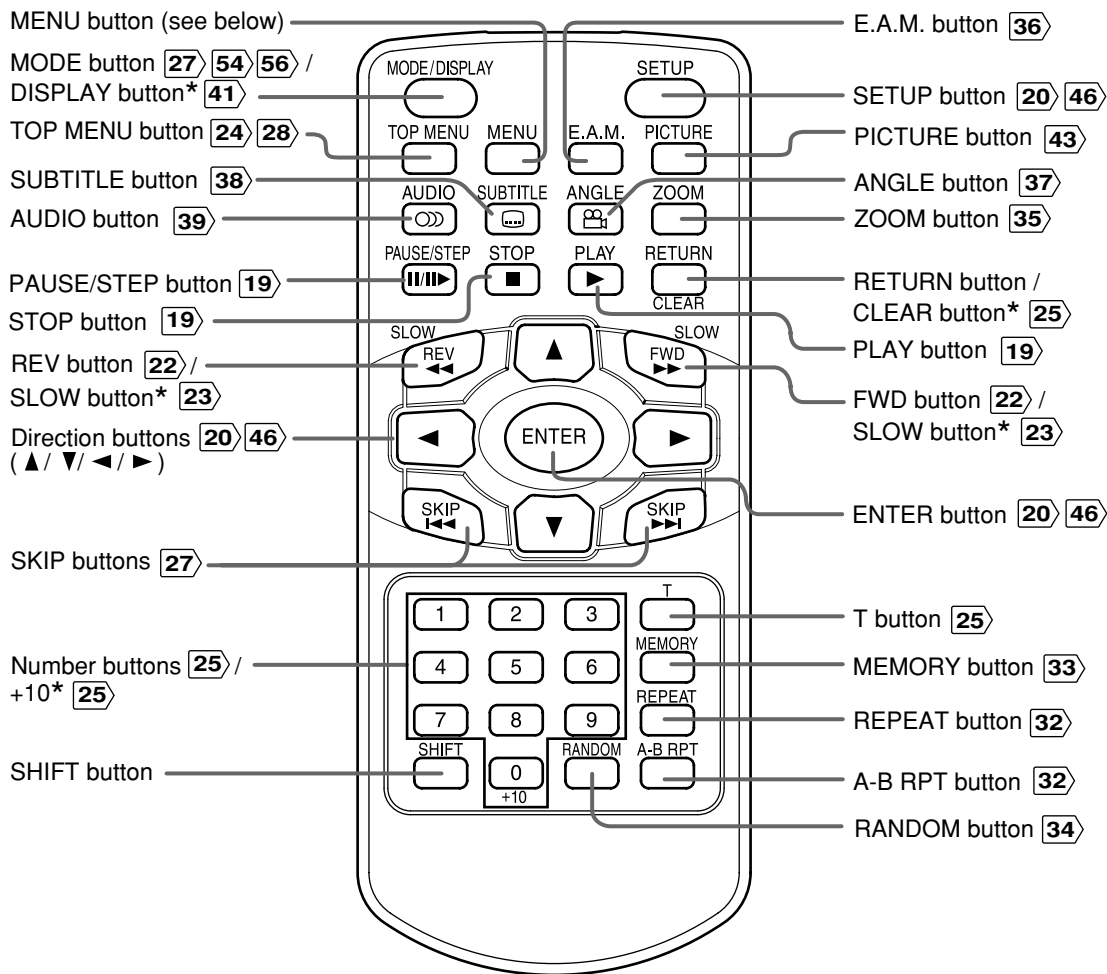

“ * ” buttons
Operate these buttons while simultaneously pressing the SHIFT button.

MENU button
Use the MENU button to display the menu included on many DVD video discs. To operate a menu, follow the instructions in “Locating a title using the top menu.” 24

Loading the remote control battery

- 1** Gently insert a fingernail in groove ① and pull out the holder in direction ②.

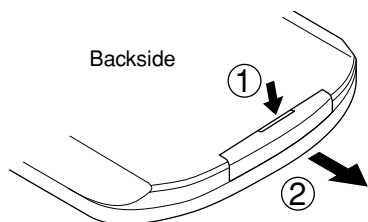

Take care not to break your fingernail.

- 2** Place a coin-shaped battery (CR2025) with the \oplus side up on the holder.

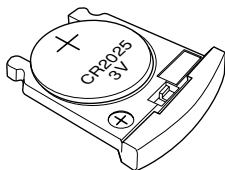

Keep the holder horizontal so that the battery does not fall through.

- 3** Push the holder back into its receptacle.

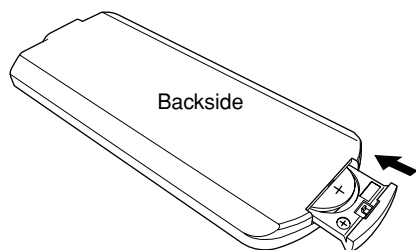

Notes on coin-shaped batteries

- If the remote control does not function correctly or if the operating range becomes reduced, replace the battery with new one.
- See [5] for safety use of coin-shaped batteries.
- Inserting a battery other than the specified one or an object may damage the remote control.

Operating with the remote control

- Point the remote control at the remote sensor on the player and press the buttons.

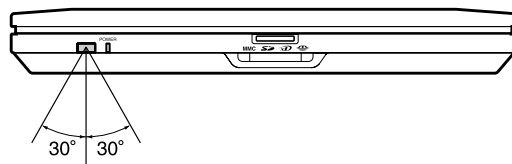

Within about 3 m (9.9 feet)

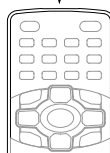

Distance: About 3 m (9.9 feet) from the front of the remote sensor

Angle: About 30° in each direction of the front of the remote sensor

- * Do not expose the remote sensor of the player to a strong light source such as direct sunlight or other illumination. If you do so, you may not be able to operate the player via the remote control.

Notes on the remote control

- Aim the remote control at the remote sensor of the player.
- Do not drop or give the remote control a shock.
- Do not leave the remote control near an extremely hot or humid place.
- Do not spill water or put anything wet on the remote control.
- Do not disassemble the remote control.

Power Connection

Connect the supplied AC adapter to power the player.
For mobile use, the battery pack (supplied) is also available.
When using the battery pack, follow the instructions on page 60.

CAUTION

- Do not connect the power plug to a power outlet other than that indicated on the label, as this can result in a risk of fire or electric shock.
- Do not connect or disconnect the power plug with wet hands. Doing so may cause electric shock.
- Do not use an AC adapter other than one specified, as it can cause a fire or damage to the player.
- When the AC adapter is in use, its temperature may increase. However, it is not a malfunction. Make sure that the power cord is disconnected and the temperature decreases before carrying it.

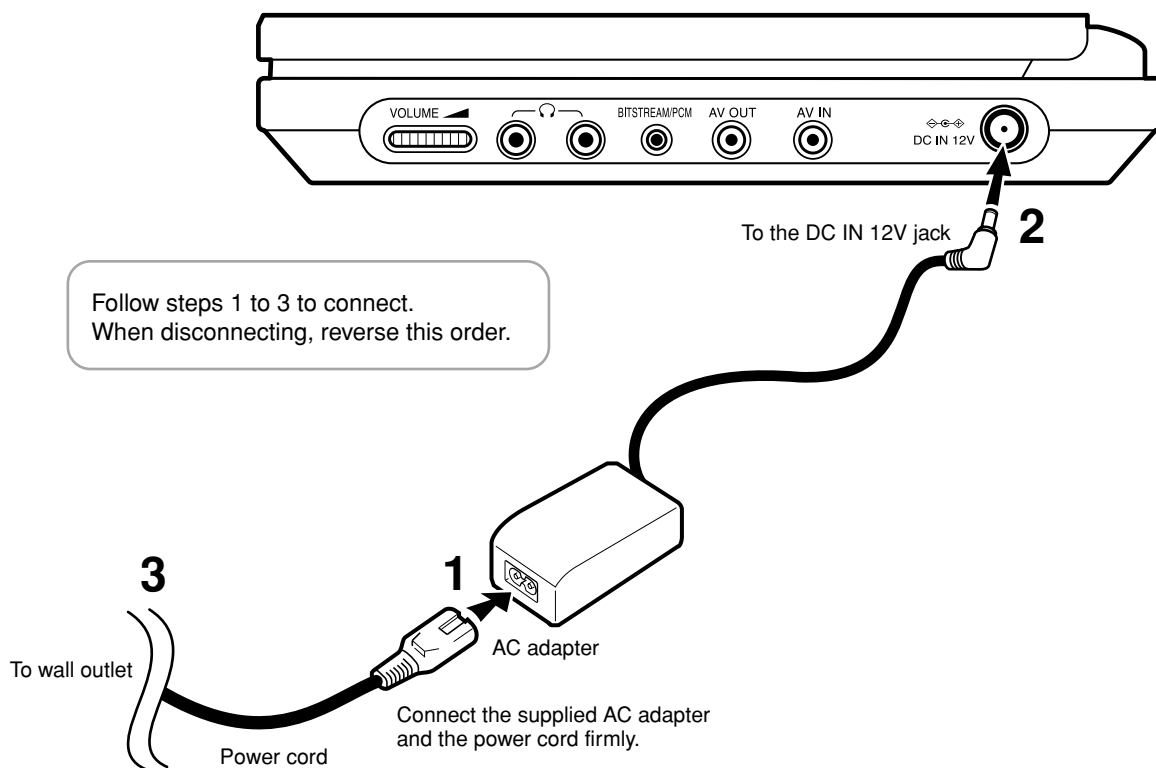

Power supply cord selection

If your line voltage is 220 to 240V, use one of the following types of cable.

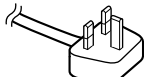
| Plug configuration | Plug type | Line voltage |
|---|-----------|--------------|
|  | EURO | 220 – 240V |
|  | UK | 220 – 240V |

Basic playback

Begin your operation.



- **Playing a Disc**
- **Variable Speed Playback**
- **Locating a Specific Title, Chapter, or Track**
- **Directly Accessing a Specific Location**
- **Playing MP3/WMA Audio or DivX® Video Files**
- **Viewing JPEG Files**

About this manual

Aside from the section "Playing a Disc", explanations of operations only include illustrations of the corresponding buttons on the remote control. The buttons sharing the same name on the main unit can also be used in an identical manner.

Playing a Disc

This section shows you the basics on how to play a disc.

 indicates a reference page of this manual.
See the page in  for details.







CAUTION

- Keep your fingers clear of the disc as it is spinning. Neglecting to may cause serious personal injury.
- Be careful not to catch your fingers in the disc holder.
- Do not use a cracked, deformed, or repaired disc.
- Do not tilt, shake or move the main unit while playing. It may damage the disc.

DVD-V
VCD CD

Basic playback

Preparations

- Connect the AC adapter  or the battery pack  to the player.
- When you want to view a disc on a connected TV or monitor , turn on the equipment and select the video input connected to the player.
- When you want to enjoy the sound of discs from an audio system , turn the audio system on and select the input connected to the player.
- If you use the supplied remote control, make sure that batteries are loaded in it. .
- If you use the headphones, see “Connecting to Headphones”. .
- Press the open switch to open the LCD monitor.
- Before using the player for the first time, remove the protective sheet beneath the disc cover.

Press the open switch and lift the LCD monitor up.

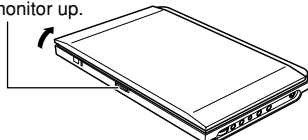

Do not forcibly open the LCD monitor to avoid damaging this panel.

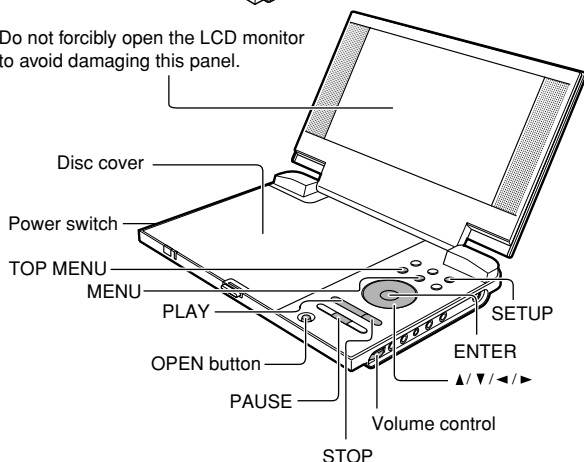

1 Turn on the power.

POWER Slide the power switch to “ON”.
OFF  ON

The player turns on and the POWER/CHG indicator on the player illuminates in green. The default setting for the language used to display the OSD of the player is English. You can change the language (English, French, Spanish, German, Polish). .

2 Open the disc cover.

 OPEN Press OPEN on the main unit. The disc cover opens.

The disc cover will not open over a certain range. Do not force the cover open further, as it may cause damage to the player.

3 Set a disc.

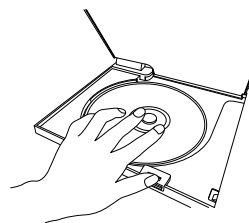

Place a disc with the playback side down, and push gently on the center of the disc to affix it to the spindle.

The player will be unable to recognize or correctly play the disc if it is not affixed to the spindle properly.

4 Close the disc cover.

Press CLOSE on the right corner.

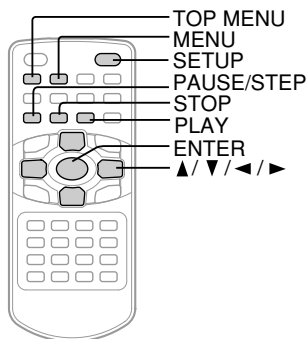

■ **To obtain a higher quality picture (When connected to a TV)**

Occasionally, some picture noise not usually visible during a normal broadcast may appear on the TV screen while playing a DVD video disc because the high resolution pictures on these discs include a lot of information. While the amount of noise depends on the TV you use with this player, you should generally reduce the sharpness adjustment on the connected TV when viewing DVD video discs.

■ **About DVD-V VCD CD**

The **DVD-V** **VCD** **CD** icons on the heading bar show the playable discs relevant to the function described under each heading.

DVD-V : DVD video discs.

CD : Audio CDs.

VCD : VIDEO CDs.

5 Start playback.

Press **PLAY**.



DVD-V If you select a DVD video disc that contains a top menu, or select a PBC (Playback Control)-featured VIDEO CD (**9**), a menu may appear. See "Locating a title using the top menu". **24**

- You may need to press the TOP MENU or MENU button to display the disc menu (depending on the actual DVD video disc.)

■ **To adjust the volume of the speakers or the connected headphones**

Turn volume control.



Right: Increase volume.
Left: Decrease volume.

■ **To pause playback (still mode)**

Press **PAUSE/STEP** during playback.



To resume normal playback, press **PLAY**.

- Sound is muted during still mode.



■ **To stop playback**

Press **STOP**.



The player memorizes the location where playback is stopped. To clear the memory, press the STOP button once again. **23**



■ **To turn off the power**

Slide the power switch to "OFF".



■ **To remove the disc**

Press the **OPEN** button on the main unit to open the disc cover.



Remove the disc from under the rim while gently pressing down on its center.
Close the disc cover after removing the disc.

■ **To start playback in the stop mode.**

Press **PLAY**.

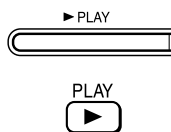

Notes

- Do not put any discs or any objects in the disc holder other than those disc types listed on page 9.
- In many instances, a menu screen will appear after playback of a movie is completed. If you have connected the DVD player to a television, and depending on the type of television that you have, prolonged display of an on-screen menu may result in the on-screen menu becoming permanently ingrained in the screen. This type of damage is not covered by your Toshiba Warranty. To avoid this, be sure to press the STOP button once the movie is completed.

NOTICE

Never operate the player in a moving vehicle. Vibration may prevent proper playback of the player or cause damage to the disc.

CAUTION

Do not touch the spindle immediately after prolonged play, as it may have become hot. Be careful in loading/removing a disc.

Playing a Disc (continued)

Basic playback (continued)

■ To change an on-screen language

1 Press **SETUP** during stop.



The following on-screen display appears.

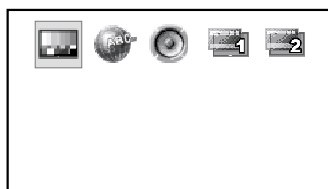

5 Press **SETUP**.



The on-screen display disappears.

2 Press ◀/▶ to select “ (LANGUAGE MENU)”, then press **ENTER**.



3 Press ▲/▼ to select “OSD Menu”, then press **ENTER**.



4 Select a language using ▲/▼, then press **ENTER**.

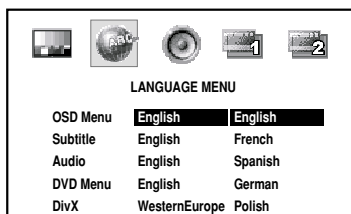

French= Français Spanish= Español
German=Deutsch Polish=Polski

■ About the screen saver

If 20 minutes elapse while the power is on and there is no disc in the player or while the disc is stopped, the screen saver is automatically displayed (when "Screen Saver" is set to "On" **[51]**). To turn off the screen saver, press any button on the main unit or remote control.

■ Automatic power LCD off function

If the player is stopped or the screen saver is engaged for approximately 20 minutes, the LCD power automatically turned off. To turn on the LCD monitor, press any button on the main unit or remote control.

■ About the LCD

- The LCD panel contained in this product is manufactured using an extremely high level of precision technology; however, there may be an occasional pixel (dot of light) that does not operate properly (does not light, remains constantly lit, etc.). This is a structural property of LCD technology, is not a sign of malfunction, and is not covered under your warranty. Such pixels are not visible when the picture is viewed from a normal viewing distance.
- The cold cathode fluorescent lamp in the LCD panel of this product, which illuminates the LCD panel from the inside, will deteriorate with use (standard length of life is approximately 10,000 hours of continuous use at normal temperature). When the LCD panel becomes dim, flickers, or does not illuminate, contact your consumer electronics dealer for replacement. The length of LCD panel life mentioned above is for reference purposes only; actual length of life of the LCD panel may vary.
- The brightness of the LCD monitor differs slightly depending on the viewing angles. Adjust the LCD monitor angle to obtain the best viewing. (The recommended viewing angle is 90 degrees to the monitor.)

Variable Speed Playback

You can play discs at various speeds, and resume playback from the location where you stopped playback.

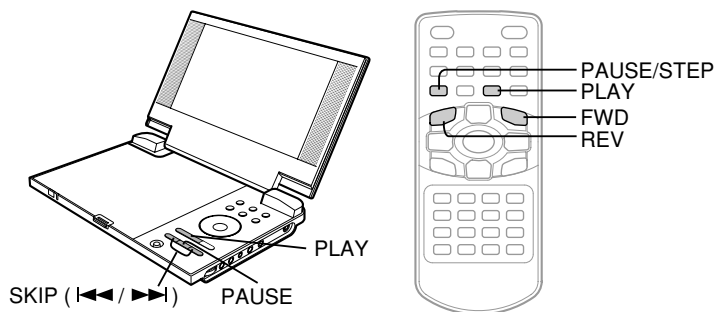

DVD-V VCD CD Playing in fast reverse or fast forward directions

Press REV or FWD on the remote control during playback.

 REV: Fast reverse playback
FWD: Fast forward playback

 Each time you press the REV or FWD button, the playback speed changes.

Press and hold SKIP (I<<</>>>I) on the main unit during playback.

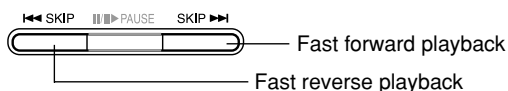

During the fast forward or fast reverse playback, you can vary the speed by holding down the button.

■ To resume normal playback

Press **PLAY**.



Notes

- The player mutes sound and omits subtitles during reverse and forward scan of DVD video discs.
- The playback speed may differ depending on the disc.

DVD-V VCD CD Playing frame by frame

Press PAUSE/STEP during still playback.

 Each time you press the PAUSE/STEP button, the picture advances one frame.

■ To resume normal playback

Press **PLAY**.



Note

The sound is muted during frame by frame playback.

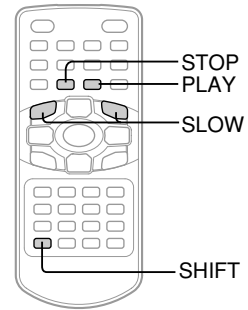
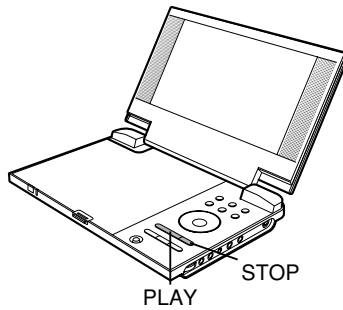

DVD-V
VCD **CD** **Playing in slow-motion**

Press SLOW while pressing SHIFT during playback.

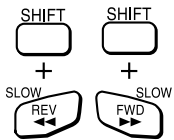

Each time you press the SLOW ►► button, the slow-motion speed changes.

If you press the SLOW ◄◄ button during playback, you can view the picture in reverse slow-motion. (Only when using a DVD video disc.)

Each time you press the SLOW ◄◄ button, the slow-motion speed changes.

■ **To resume normal playback**

Press **PLAY**.



Notes

- The sound is muted during slow-motion playback.
- The playback speed may differ depending on the disc.

DVD-V
VCD **CD** **Resuming playback from the stopped location**

1 Press STOP at the location where you want to interrupt playback.



The player memorizes the location where playback is stopped.

2 Press PLAY.



The player resumes playback from the location where you stopped playback.

2 Press **PLAY**.



DVD-V Playback starts from the beginning of the titles.

VCD Playback starts from the beginning of the disc.

CD

- If you want to return to the beginning of a DVD video disc, turn the power off and on by sliding the power switch to the ON position, and then start playback.

Notes

- The player's memory is also cleared when:
 - you use a PBC-featured VIDEO CD while "PBC" is set to "On" [51].
- There may be a difference in the location where playback resumes depending on the disc.

■ **To start playback from the beginning regardless of the location where you stopped playback**

1 Press **STOP** twice.



The player's memory is cleared.

Locating a Specific Title, Chapter, or Track

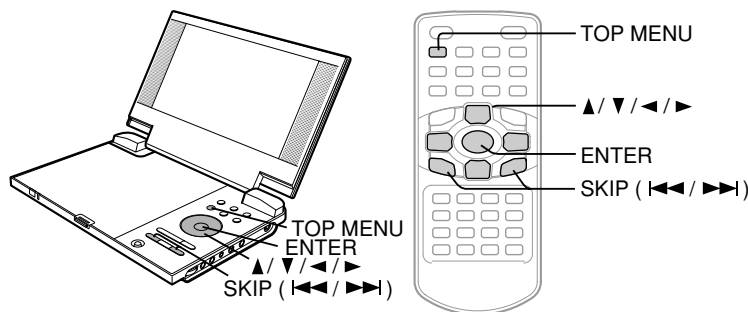

Normally, DVD video discs are divided into titles, and the titles are sub-divided into chapters. Contents of VIDEO CDs and audio CDs are divided into tracks. You can quickly locate any specific title, chapter, or track.

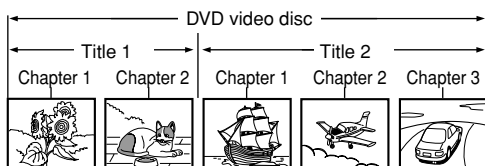

DVD-V VCD CD Locating a title using the top menu

1 Press TOP MENU.

TOP MENU The top menu appears.



e.g.

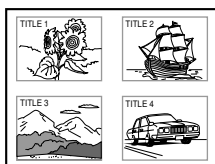

2 Press ▲/▼/◀/▶ to select the title you want.

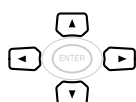

If the titles in the top menu are assigned a number, you can directly locate a specific title by pressing its designated number with the number buttons.

3 Press ENTER.



Playback starts from chapter 1 of the selected title.

Notes

- The instructions above describe basic procedures which may vary depending on the contents of the DVD video disc. If different instructions appear on the screen, follow those instructions.
- If you display the top menu during playback and press the TOP MENU button again without selecting any title, the player may resume playback from the point where you first pressed the TOP MENU button (depending on the actual DVD video disc.)
- This method of locating a title is available only on a disc that contains a top menu.
- Instruction notes of discs may refer to the button that displays the top menu as TITLE button.

DVD-V VCD CD Locating a specific chapter or track

Press SKIP (I<<</>>>I) repeatedly to locate the chapter or track you want.

Playback starts from the selected chapter or track.



To locate succeeding chapters or tracks.



Playback starts from the beginning of the current chapter or track. When you press twice, playback starts from the beginning of the preceding chapter or track.

Directly Accessing a Specific Location

You can access a specific location by entering its corresponding time (hours, minutes, seconds).

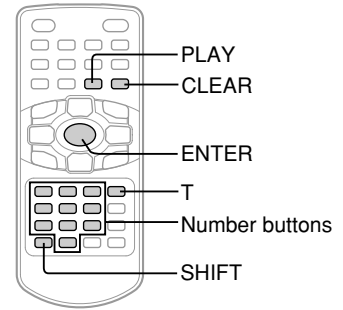

DVD-V VCD CD Entering the time counter of the desired location

1 Press T several times.

The display changes each time this button is pressed.

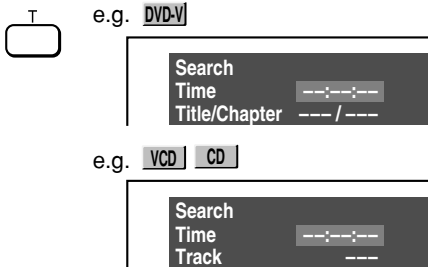

2 Press the number buttons to enter the time.

e.g.

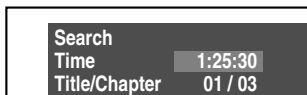
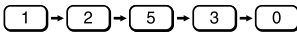

Playback starts from the desired location. You can locate a specific title/chapter or track. Use ▲ / ▼ to highlight Title/Chapter or Track and enter a number.

3 Press PLAY or ENTER.

Playback starts from the selected section.

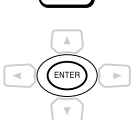

■ Using the bookmark function

You can register a bookmark for your favorite scene and jump from any other scene to that location to play the scene. You can register up to three bookmarks.

1 Play the disc and press **PAUSE/STEP** at the scene you want to bookmark.



2 Press **T** several times to display Bookmark. The Register Bookmark menu appears.

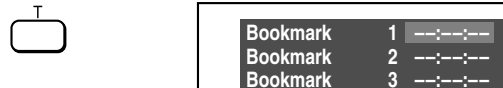

3 Select any of bookmarks 1 to 3 and press **ENTER**.

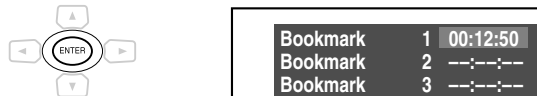

The location of the selected scene is registered to the bookmark.

- If you want to change a registered bookmark, select the bookmark, press **CLEAR** while pressing **SHIFT** to delete the bookmark information for the scene and then register a new scene.

To start playback from a registered bookmark, select the desired bookmark after Step 2 and press **ENTER**.

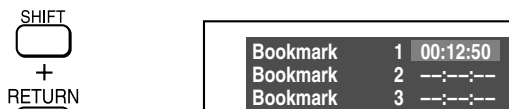

SHIFT + CLEAR



Playback starts from the scene of the selected bookmark.

Notes

- Pressing the CLEAR button while pressing the SHIFT button resets the numbers.
- This location display will disappear in a few seconds if no further operation is made.
- Some discs may not respond to this process.
- Some scenes may not be located precisely as you specified.

Notes

- Bookmarks may not be able to be registered for some discs.
- Bookmarks may not be able to be registered for some scenes.
- If another disc is inserted or the power of the player is turned off, the registered bookmark information is cleared.

Playing MP3/WMA Audio or DivX® Video Files

You can play MP3/WMA or DivX® files on this player.

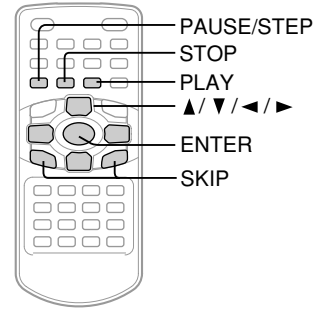

Playing MP3/WMA audio or DivX® video files

■ Playable files

MP3/WMA or DivX® disc compatibility with this player is limited as follows:

- Playable discs (MP3/WMA): CD-ROM, CD-R, CD-RW, DVD-R, SD Memory Card, Multi Media Card, Memory Stick, xD-Picture Card
- Playable discs (DivX): CD-R, CD-RW, DVD-R, SD Memory Card, Multi Media Card, Memory Stick, xD-Picture Card
- Sampling Frequency: 32 kHz, 44.1 kHz, 48 kHz
- Bit rate:
 - MP3: 32 kbps - 320 kbps (CBR)
 - WMA: 48 kbps - 192 kbps (CBR)
 - DivX: Less than 8 Mbps
- CD physical format: Mode 1
- MP3 File system: ISO9660, UDF without interleave
- DivX File system: ISO14496
- MP3/WMA File name: File names are limited to eight characters or less and must incorporate "MP3" or "WMA" extension. e.g. "*****.MP3", "*****.WMA"
File names cannot contain special characters such as "?!><+*}{[@];\ /,." etc.
Less than 50 bytes
- DivX File name: File names are limited to eight characters or less and must incorporate "DivX" extension. e.g. "*****.avi", "*****.divx"
File names cannot contain special characters such as "?!><+*}{[@];\ /,." etc.
Less than 50 bytes
- Total number of files: Less than 650
- DivX codec version: 3, 4, 5, 6 (Plays all versions of DivX® video (including DivX® 6) with standard playback of DivX® media files)
- DivX resolution: 720 × 576 (Less or equal)

1 Set a CD or insert a memory card that contains MP3/WMA or DivX® files.

For details on how to insert a memory card or switch to memory card mode, see [27](#). A menu appears.

2 Press ▲ / ▼ / ◀ / ▶ to select a file name you want to play.

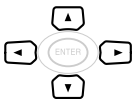

3 Press ENTER.

Playback starts.



■ To stop the playback

Press **STOP**.



■ To pause playback

Press **PAUSE/STEP** during playback.



To resume normal playback, press the **PLAY** button.

Notes

- You cannot play back DivX DRM written to a memory card.
- Some discs may not permit this operation.
- WMA tracks copy-protected cannot be played.
- The BITSTREAM/PCM jack outputs MP3/WMA or DivX® sounds in the linear PCM format regardless of the current "Digital Out" selection. [50](#)
- If you stop playback by pressing the STOP button, and then press the PLAY button, playback will start from the beginning of the track.
- The SKIP, REPEAT and RANDOM functions are also available.

This player requires discs/recordings to meet certain technical standards in order to achieve optimal playback quality. Pre-recorded DVDs are automatically set to these standards. There are many different types of recordable disc formats (including CD-R containing MP3/WMA or DivX® files). Given the fact that technology in this area is still maturing, Toshiba cannot guarantee that all genre of recordable discs will produce optimal playback quality. The technical criteria set out in this owner's manual are meant as a guide only.

You must obtain any required permission from copyright owners to download or use copyrighted content. Toshiba cannot and does not grant such permission.

Microsoft, Windows Media, and the Windows Logo are either trademarks or registered trademarks of Microsoft Corporation in the United States and/or other countries.



DivX and the DivX logo are registered trademarks of DivX, Inc.

Viewing JPEG Files

You can play JPEG files that have been recorded on a CD-R or memory card on this player.

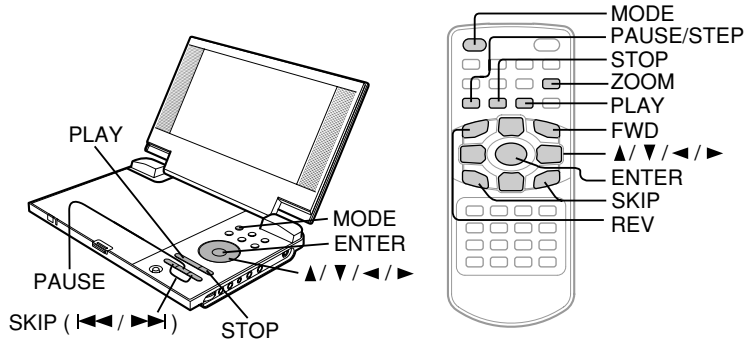

Viewing JPEG Files

■ Preparation

Prepare a compatible disc or memory card that contains JPEG files you want to view [29].

1 Insert a CD or memory card that contains JPEG files into the player.

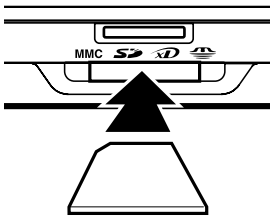

With a CD, close the disc cover.

Main unit:

For a memory card, press the MODE button to switch to the CARD mode.

MODE Each time the button is pressed, the mode will alternate as below.



Remote control:

For a memory card, press the MODE button to switch to the CARD mode.

MODE/DISPLAY Each time the button is pressed, the mode will alternate as below.

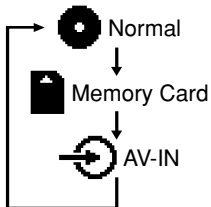

AV-IN mode: External AV input mode.

A menu appears.

If you insert a KODAK Picture CD, automatically starts the slide show. With a KODAK Picture CD, the menu is not displayed. (See the next page.)

Some of these discs and/or cards may be incompatible.

2 Press ▲/▼/◀/▶ to move the highlight bar to select a file.

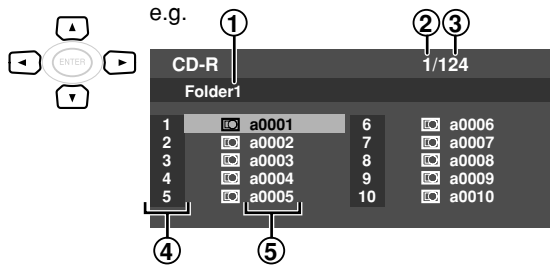

- ① Folder name
- ② Number of the last file selected
- ③ Total number of files on the disc (maximum of 1500)
- ④ File number
- ⑤ File name

3 Press PLAY or ENTER.

A slide show begins from the selected picture. Upon reaching the end, it will be back to the top menu.

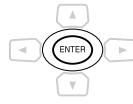

■ To stop the slide show

Press **STOP**.



■ To pause the slide show

Press **PAUSE/STEP** during playback.

PAUSE/STEP To resume the slide show, press the **PLAY** button.



■ To switch pictures

Press **SKIP (◀▶)** during playback.



◀▶: Switch to the previous picture



▶▶: Switch to the next picture

Note

Displaying a picture may take a while or may not be possible depending on the file size or disc.

Viewing JPEG Files (continued)

Viewing JPEG Files (continued)

■ To rotate a picture

Press ◀/▶ during playback.

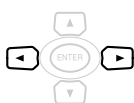

- ◀ : Rotate counterclockwise (by 90°).
- ▶ : Rotate clockwise (by 90°).

■ To zoom in a picture

Press **ZOOM** during playback.



You will enter the zoom mode.

x2 → x3 → x4 → Off

If you press ▲/▼/◀/▶ in the zoom in mode, the zoom point will be shifted.

Pressing the ZOOM button again exits the zoom mode.

■ Playing in a Favorite Order

You can select a combination of files and play them in a desired order. You can program up to 12 selections.

- 1 Press **MEMORY** during playback or while playback is stopped.

The programming display appears.

e.g.

| Program Input | | | |
|---------------|-------|-----------|--------|
| 1 --- | 4 --- | 7 --- | 10 --- |
| 2 --- | 5 --- | 8 --- | 11 --- |
| 3 --- | 6 --- | 9 --- | 12 --- |
| Play Program | | Clear All | |

- 2 Select the desired playback order using ▲/▼/◀/▶ and enter a number.
- 3 Use ▲/▼/◀/▶ to select "Play Program" and press **ENTER**.

Memory playback starts in the programmed order.

• To change the programmed selections

- 1 Use ▲/▼/◀/▶ to position the cursor to select the item you want to change on the screen.
- 2 Press **CLEAR** while pressing **SHIFT** to cancel a file number and then enter a new number.

• To cancel the programmed selections

- 1 Use ▲/▼/◀/▶ to position the cursor to select the item you want to cancel on the screen.
- 2 Press **CLEAR** while pressing **SHIFT**.
To cancel all file numbers, use ▲/▼/◀/▶ to select "Clear All" and press **ENTER**.

• To return to normal playback from memory playback

Press **STOP** twice to end memory playback.

Notes

- Some discs may not permit memory playback operation.
- The programmed selections will be cleared when you turn off the player.

■ Thumbnail mode

Press **TOP MENU** while stopped or during playback. The thumbnail mode is displayed.

e.g.

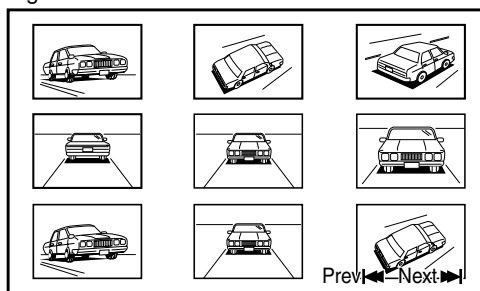

Press **PLAY**.

A slide show begins from the selected picture. A picture is selected by pressing ▲/▼/◀/▶.

Select [Prev ◀◀] and press **ENTER** or **PLAY**. The previous nine pictures will be displayed.

Select [Next ▶▶] and press **ENTER** or **PLAY**. The next nine pictures will be displayed.

Press **STOP**.

The menu mode will be entered.

■ To play a Kodak Picture CD

Set a Kodak Picture CD.
Automatically starts the slide show.

Upon reaching the end, it will enter the thumbnail mode.
Pressing the **TOP MENU** button will enter the thumbnail mode.

■ Eject the memory card.

Confirm the memory card is not in use now.
Lightly push in the memory card and then release. The memory card will partially eject. Pull the memory card out slowly and straight.
To play a disc, switch it to the Normal mode by pressing the **MODE** button.

Notes

- Do not eject the memory card while it is in use. If ejected while in use, information on the memory card may be lost.
- To view JPEG files contained in a memory card, the files must be of DCF format.
- When connected to an external output, AV-IN mode cannot be selected.
- Be sure to stop playing the disc before changing the mode.

JPEG files compatibility

Discs and pixels whose compatibility with this unit has been confirmed by TOSHIBA are as follows.

Kodak Picture CD

JPEG disc compatibility with this unit is limited as follows:

- Playable discs: CD-ROM, CD-R, CD-RW, SD Memory Card, MultiMediaCard, Memory Stick, xD-Picture Card
- File system: ISO9660, UDF without interleave
- File name: File names are limited to eight characters or less and must incorporate "JPG" extension. e.g. "*****.JPG"
File names cannot contain special characters such as "?!><+*}{[@]:\ / .," etc.
- File size: Unrestricted
- File format: BASELINE, PROGRESSIVE
- Resolution: Baseline JPG: 5760x3840
Progressive JPG: width
*(height + 128) < 3300000

Advanced playback

Customizing the performance of your player.

- **Repeat Play**
- **Playing in a Favorite Order**
- **Playing in Random Order**
- **Zooming a Picture**
- **Selecting the Sound Enhancement (E.A.M.)**
- **Selecting a Camera Angle**
- **Selecting Subtitles**
- **Selecting a Language**
- **On-screen Display Mode**
- **Adjusting the Picture**

Repeat Play

You can play a specific title, chapter, track, or segment repeatedly. (Title repeat, chapter/track repeat, A-B repeat)

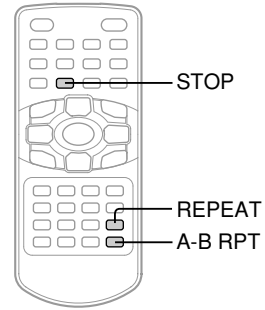
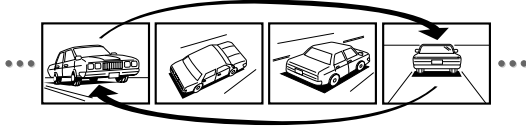

DVD-V VCD CD Repeating a title, chapter, or track

Press REPEAT.

REPEAT Each time you press the REPEAT button, the repeat mode changes as follows.

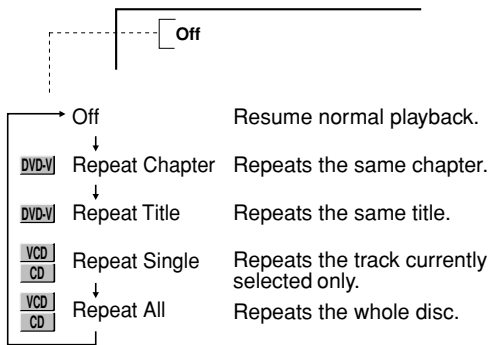

To resume normal playback

Press **REPEAT** repeatedly until "Off" appears for the repeat mode display.



If you press **STOP** twice, the Repeat function ends and playback stops.

Note

Some discs may not permit repeat operation.

DVD-V VCD CD Repeating a specific segment

1 Press A-B RPT at the beginning of the segment (point A) you want to play repeatedly.



2 Press A-B RPT again at the end of the segment (point B).

A-B RPT The player automatically returns to point A and starts repeat playback of the selected segment (A-B).

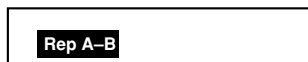

To resume normal playback

Press **A-B RPT** again.



If you press **STOP** twice, the A-B Repeat function ends and playback stops.

Notes

- Some discs may not permit A-B repeat operation.
- You can specify a segment only within the current title or track.
- There may be a slight difference between point A and the location where playback actually resumes depending on the disc.
- Functions other than STOP and A-B RPT may not be available during A-B Repeat playback.

Playing in a Favorite Order

You can combine your favorite titles, chapters, or tracks and play them in the order you determine. You can program up to 12 selections into the memory. (Memory playback)

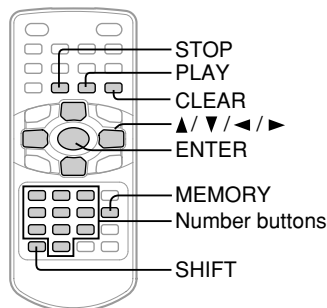

DVD-V VCD CD Setting titles, chapters, or tracks in a favorite order

1 Press MEMORY.

MEMORY The programming display appears.



e.g. DVD-V

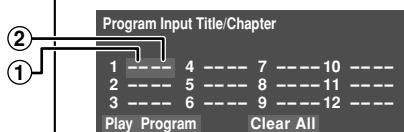

e.g. VCD CD

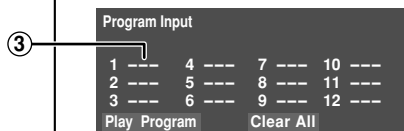

- ①: Title number
- ②: Chapter number
(A chapter cannot be entered when there are no chapters or the corresponding chapter number does not exist for the title you want to play.)
- ③: Track number
(A track number cannot be entered when the corresponding track number does not exist for the disc you want to play.)

2 Enter the number in the order wish to playback.

To enter another number, use ▲ / ▼ / ◀ / ▶ to move the highlight bar to the desired playback order and then enter a number.

3 Select "Play Program" using ▼ and press ENTER.



The player starts memory playback.

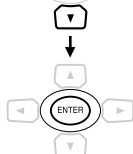

If you redisplay the memory playback programming display during memory playback, playback is paused.

■ To change the programmed selections

- 1 While the display appears on the screen, press ▲ / ▼ / ◀ / ▶ to move the highlighted bar to the item you want to change.
- 2 Change the selection following the instructions in step 2.

■ To cancel the programmed selections

- 1 While the display appears on the screen, press ▲ / ▼ / ◀ / ▶ to move the highlighted bar to the item you want to cancel.
- 2 Press **CLEAR** while pressing **SHIFT**.

If a programmed selection is changed or a number is cleared during memory playback, the original programmed selection cannot be played.

■ To resume normal playback from memory playback

- 1 Press **MEMORY** to display the programming display.
- 2 Since "Clear All" is selected, press **ENTER**.

If you press **STOP** twice, memory playback ends. However, the memory is not cleared.

Notes

- Some discs may not permit memory playback operation.
- The programmed selections will be cleared when you turn off the player.

Playing in Random Order

You can play chapters or tracks in random order.
(Random playback)

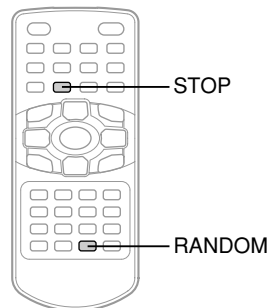

DVD-V
VCD CD

Playing chapters or tracks in random order

Press RANDOM.



Each time you press the RANDOM button, the random mode changes as follows.

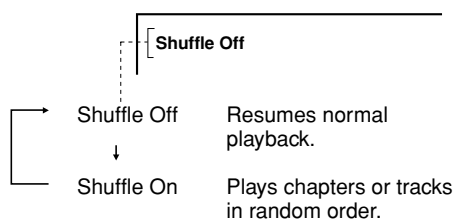

If you press the RANDOM button during playback, the player automatically starts random playback after finishing the current chapter or track.

■ To resume normal playback

Press **RANDOM** repeatedly until "Shuffle Off" appears for the random mode display.



You can also exit random playback by pressing **STOP** twice.

Note

Some discs may not permit random playback operation.

Zooming a Picture

You can magnify areas within a picture.

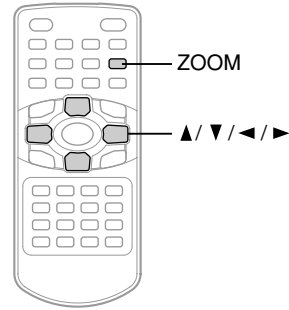
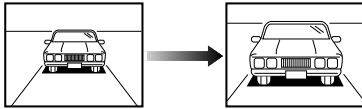

DVD-V VCD CD Zooming a picture

1 During normal, slow, still, fast reverse or fast forward playback, press ZOOM.



The player enters the zoom playback mode, and the zoom icon appears.

e.g.

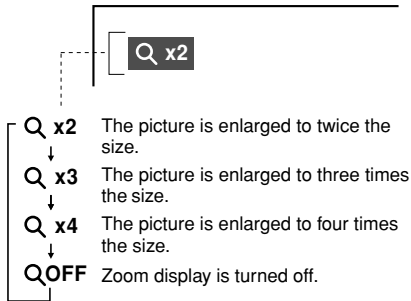

■ To exit zoom playback

Press **ZOOM** repeatedly until "OFF" appears.



Notes

- Some discs may not respond to zoom feature.
- During some scenes, the buttons may not work as described.
- Zooming does not work on characters selected on menus.

2 Select the zoom point and magnification level.

Magnification level

You can select from the following.

- Magnification (Q x2, x3, x4)
- Normal playback (Q OFF)



Press the **ZOOM** button repeatedly.

Zoom point

To shift:

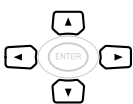

Press **▲ / ▼ / ◀ / ▶** in the zoom in mode.

Selecting the Sound Enhancement (E.A.M.*)

You can easily select a preferred audio enhancement.

*E.A.M.: Enhanced Audio Mode

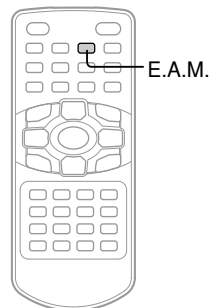

DVD-V
VCD CD

Selecting the sound enhancement

1 Press E.A.M.

E.A.M.



The sound enhancement menu appears.

3D Off

2 Select the sound enhancement by pressing E.A.M.

E.A.M.



If you press E.A.M. again after setting the sound enhancement, the current setting appears.

3D Off: Normal sound.

3D On: To obtain expansive virtual surround sound effects from just two speakers.

Notes

- Actual effects to sounds may vary depending on the speaker system. Make the selection to your preference.
- Actual effects to sounds may vary depending on the disc.

Selecting a Camera Angle

If a scene was recorded with multiple angles, you can easily change the camera angle of the scene you are viewing.

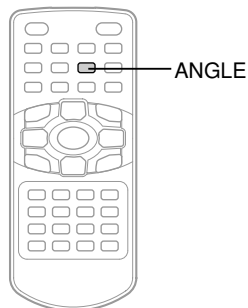
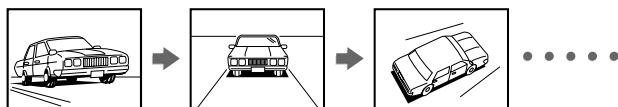

DVD-V VCD CD Changing the camera angle

1 Press ANGLE while playing a scene recorded with multiple angles.



While playing a scene recorded with multiple angles, the angle icon (ANGLE) appears on the screen. If you press ANGLE while the angle icon is displayed, the number of multiple angles with which the scene was recorded appears.

e.g.



If the disc being played includes scenes recorded at multiple angles, (ANGLE) and the number of multiple-angle recordings for each title appear. If you press ANGLE when the disc being played includes no scenes recorded at multiple angles, (NO) appears.

2 Selecting the camera angle by pressing ANGLE.



Each time you press the ANGLE button, the camera angle changes.

Notes

- After selecting angle, it will take a few moments to change the camera angle of the scene you are viewing.
- If you pause a picture immediately after changing a camera angle, the resumed playback picture may not display the new camera angle.

Selecting Subtitles

You can display subtitles on the screen and select a subtitle language from those included on the DVD video disc.

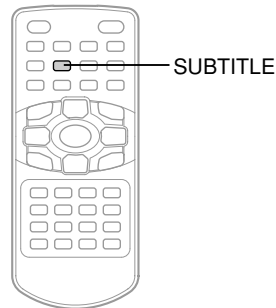

DVD-V Selecting a subtitle language

1 Press SUBTITLE during playback.



The current subtitle setting is displayed.

e.g.

2 Press SUBTITLE while the subtitle setting is displayed on the screen.



Each time you press the SUBTITLE button, the subtitle languages included on the DVD video disc change.

■ To turn subtitles on or off

Press SUBTITLE several times during playback until "Off" is displayed.



Notes

- Some DVD video discs display subtitles automatically, and you cannot turn them off even if you set the subtitle function to off.
- Some DVD video discs will allow you to make subtitle selections and turn subtitles on or off only via the disc menu.

Notes

- When you select a subtitle language which is not included on the disc, the player plays a prior language programmed on the disc.
- During some scenes, the subtitles may not appear immediately after you change the subtitle language.

Selecting a Language

You can select a preferred language and sound recording system from those included on the disc.

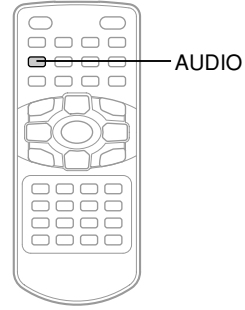
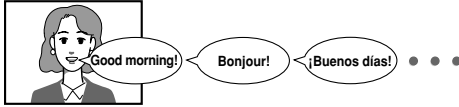

DVD-V VCD CD Selecting a playback audio setting

1 Press AUDIO during playback.



The current audio setting is displayed.

e.g.



2 Press AUDIO while the audio setting is displayed on the screen.



Each time you press the AUDIO button, the audio settings included on the DVD video disc change.

■ Selecting sound channels of VIDEO CDs

During playback, press **AUDIO** repeatedly to select the sound channel.



Notes

- Some discs allow you to change audio selections only via the disc menu. In such a case, press the MENU button and choose the appropriate language from the selections on the disc menu.
- If you select a sound track which is not included on the disc, the player plays a prior sound track programmed on the disc.

Selecting a Language (continued)



Selecting a playback audio setting (continued)

■ Output sound conversion table (sampling frequency/quantization bit)

| Discs | Sound recording system | Audio selection from the menu 46 50 and outputs | | | | | | |
|-----------------|------------------------|---|--------------------------------------|--------------------|--------------------------------------|--------------------|--------------------------------------|-----|
| | | "Bitstream" | | "Analog 2ch" | | "PCM" | | |
| | | BITSTREAM/PCM jack | Speakers/AV OUT jack/Headphone jacks | BITSTREAM/PCM jack | Speakers/AV OUT jack/Headphone jacks | BITSTREAM/PCM jack | Speakers/AV OUT jack/Headphone jacks | |
| DVD video discs | Dolby Digital | Bitstream | Yes | Bitstream | Yes | PCM | Yes | |
| | Linear PCM | 48 kHz | PCM | Yes | No | Yes | PCM | Yes |
| | | 96 kHz | PCM* | Yes | No | Yes | PCM* | Yes |
| | DTS | Bitstream | No | Bitstream | No | Bitstream | No | |
| | MPEG1, MPEG2 | Bitstream | Yes | Bitstream | Yes | PCM | Yes | |
| VIDEO CDs | MPEG1 | Bitstream | Yes | Bitstream | Yes | PCM | Yes | |
| AUDIO CDs | Linear PCM 44.1 kHz | PCM | Yes | PCM | Yes | PCM | Yes | |
| | DTS | Bitstream | No | Bitstream | No | Bitstream | No | |

*PCM: down sampling PCM

- Signals of 88.2 kHz or higher from the BITSTREAM/PCM jack are down converted to 44.1 kHz or 48 kHz when:
 - "3D On" is selected.
 - a copyright protected disc is played.
- Quantization will be limited to 16 bits in a copyright protected disc.

On-screen Display Mode

You can confirm the disc usage status and player operation information on the screen.

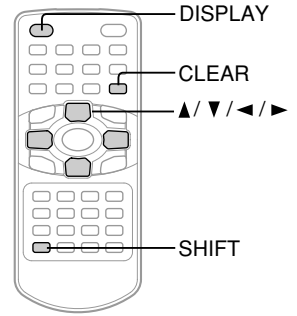

DVD-V VCD CD On-Screen Display

1 Press **DISPLAY** while pressing **SHIFT** during playback.

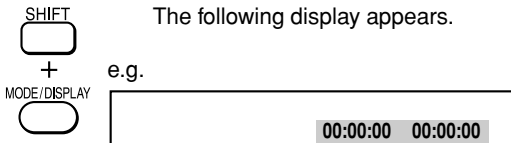

DVD 00:00:00 00:00:00
 Title 1/3 Chapter4/13 Angle 1/1
 Audio 1/3 2 ch ENG
 Subtitle 2/5 ENG
 Bitrate 6.912Mbps

The screen displayed varies depending on the disc.

■ When playing a DVD video or audio disc

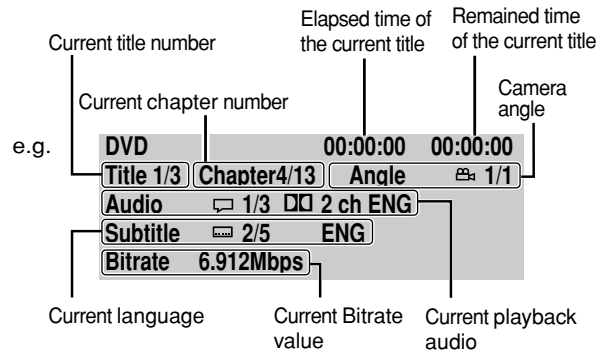

Note

Some discs may not be compatible with a set of these operations.

■ To turn off the display

Press **DISPLAY** or **CLEAR** while pressing **SHIFT**.

On-screen Display Mode (continued)

On-Screen Display (continued)

■ When playing a VIDEO CD or audio CD

| | Current track number | Elapsed time of the current track | Remained time of the current track |
|------|----------------------|--------------------------------------|---------------------------------------|
| e.g. | CD Track 1/11 | 00:00:00 | 00:00:00 |

Note

This may not be displayed for some discs.

Adjusting the Picture

You can easily select a preferred picture.

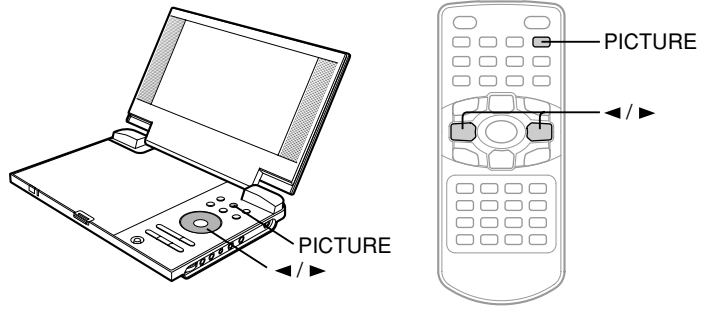

DVD-V VCD CD Adjusting the picture

1 Press PICTURE. Alternatively press PICTURE on the main unit.

(This function can only be set when you view pictures on the LCD of the player.)

PICTURE The picture setting display appears.



PICTURE

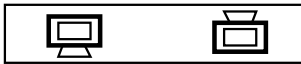

Each time you press the button, the setup items changes as follows.

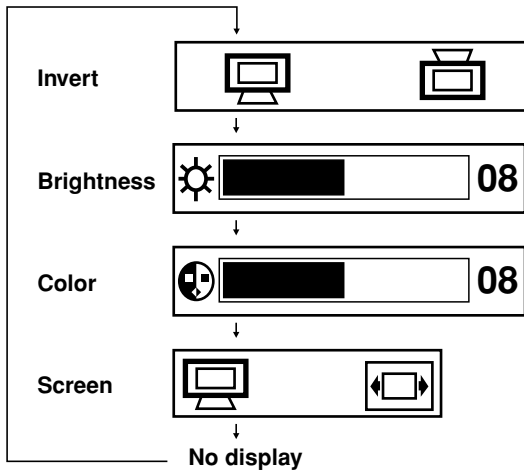

2 Press ◀/▶ to adjust the value.

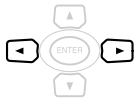

- Invert : → Normal
 - ↓
 - Invert (Vertical inverse)
- Brightness : 0 (Darker) to 16 (Brighter)
- Color : 0 (Paler) to 16 (Deeper)
- Screen : → Enhanced
 - ↓
 - Normal

Function setup

You can change the default settings to customize performance to your preference.

- **Customizing the Function Settings**

Customizing the Function Settings

You can change the default settings to customize performance to your preference.

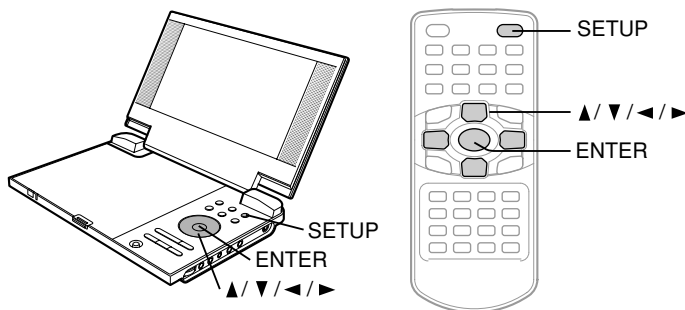

DVD-V VCD CD Setting procedure

1 Press SETUP during stop.



The following on-screen display appears.

e.g.

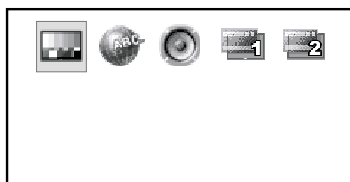

4 Change the selection by ▲ / ▼, by referring to the corresponding pages 47, then press ENTER.

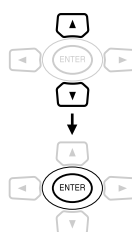

e.g.

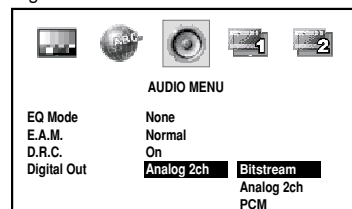

2 Press ◀ / ▶ to select the setting you want to change, then press ENTER.

(See the next page.)

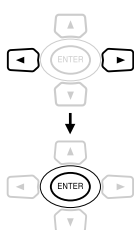

e.g.

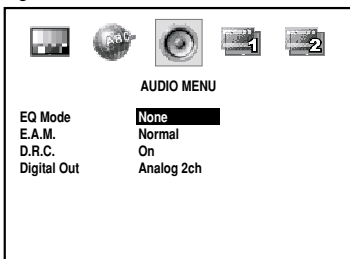

5 Press ENTER, then repeat steps 2 and 4 to change other settings.

6 Press SETUP.



The on-screen display disappears.

3 Press ▲ / ▼ to select the setting you want to change, then press ENTER.

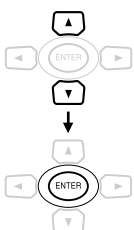

e.g.

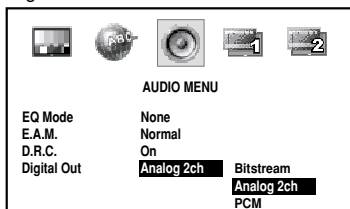

| | Setting | Details | Page |
|--|---------|---------|------|
|--|---------|---------|------|

TV MENU



| | | | |
|--|---|--|----|
| | TV Shape DVD-V | To select a picture size according to the aspect ratio of your TV. | 48 |
|--|---|--|----|

LANGUAGE MENU



| | | | |
|--|--|--|----|
| | OSD Menu DVD-V VCD CD | To select a preferred language for on-screen displays. | 48 |
| | Subtitle DVD-V | To select a preferred language for subtitles. | 48 |
| | Audio DVD-V | To select a preferred language for the sound track. | 48 |
| | DVD Menu DVD-V | To select a preferred language for disc menus. | 48 |
| | DivX DVD-V | To select the font for subtitles of the DivX file. | 49 |

AUDIO MENU



| | | | |
|--|---|--|----|
| | EQ Mode DVD-V VCD CD | You can select a preferred equalizer mode. | 49 |
| | E.A.M. DVD-V VCD CD | You can easily switch to a preferred audio enhancement. | 49 |
| | D.R.C. DVD-V | To turn on or off a function that makes faint sounds easier to hear even if you lower the volume during late hours playback. | 49 |
| | Digital Out DVD-V VCD CD | To select an output sound format corresponding to your system connection. | 50 |

OPERATION MENU-1



| | | | |
|--|---|--|----|
| | Parental DVD-V | To turn the parental lock function on or off. | 50 |
| | PBC VCD | To use the menu screen when playing a PBC-controllable VIDEO CD. | 51 |
| | Screen Saver DVD-V | To turn the screen saver on or off. | 51 |
| | Default DVD-V VCD CD | To restore all settings to the factory set. | 51 |

OPERATION MENU-2



| | | | |
|--|---|------------------------------------|----|
| | DivX registration DVD-V VCD CD | To display information about DivX. | 51 |
|--|---|------------------------------------|----|

Customizing the Function Settings (continued)

Setting details

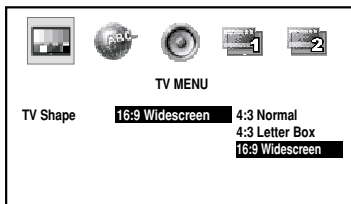

TV Shape DVD-V

4:3 Normal: Select when a standard 4:3 TV is connected.



Displays pictures cropped to fill your TV screen. Either or both sides of the picture are cut off.

4:3 Letterbox: Select when a standard 4:3 TV is connected.



Displays theatrical images with masking bars above and below the picture. When playing a source of 16:9 picture size.

16:9 Widescreen: Select when a 16:9 wide TV is connected.



Use this setting when using the player's LCD monitor.

Notes

- The displayable picture size is preset on the DVD video disc. Therefore, the playback picture of some DVD video discs may not conform to the picture size you select.
- When you play DVD video discs recorded in the 4:3 picture size only, the playback picture always appears in the 4:3 picture size regardless of the TV shape setting.
- If you select "16:9 Widescreen" and you own a 4:3 TV set, the DVD playback picture will be horizontally distorted during playback. Images will appear to be horizontally compressed. Always be sure that your TV shape conforms to the actual TV in use.

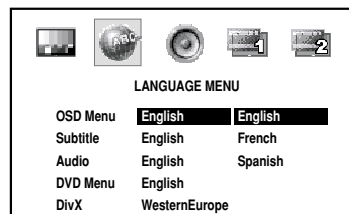

OSD Menu DVD-V | DVD-A | VCD | CD

English: To view on-screen displays in English.
 French: To view on-screen displays in French.
 Spanish: To view on-screen displays in Spanish.
 German: To view on-screen displays in German.
 Polish: To view on-screen displays in Polish.

Subtitle DVD-V

English: To display subtitles in English.
 French: To display subtitles in French.
 Spanish: To display subtitles in Spanish.
 German: To display subtitles in German.
 Polish: To display subtitles in Polish.
 Off: To display no subtitles.

Notes

- Some DVD video discs may be set to display subtitles in a different language than you selected. A prior subtitle language may be programmed on the disc.
- Some DVD video discs allow you to change subtitle selections only via the disc menu. If this is the case, press the MENU button and choose the appropriate subtitle language from the selection on the disc menu.

Audio DVD-V

English: To play sound tracks in English.
 French: To play sound tracks in French.
 Spanish: To play sound tracks in Spanish.
 German: To play sound tracks in German.
 Polish: To play sound tracks in Polish.

Note

Some DVD video discs may be played in a different language than you selected. A prior language may be programmed on the disc.

DVD Menu DVD-V

English: To display disc menus in English.
 French: To display disc menus in French.
 Spanish: To display disc menus in Spanish.
 German: To display disc menus in German.
 Polish: To display disc menus in Polish.

Note

Some DVD video discs may not include your pre-selected language. In this case, the player automatically displays disc menus consistent with the disc's initial language setting.

DivX DVD-V

- WesternEurope: To display subtitles in west European language.
- CentralEuropea: To display subtitles in Central European language.
- SlavonicCyrillic: To display subtitles in Slavonic Cyrillic language.

Notes

- Some DVD video discs may be set to display subtitles in a different language than you selected. A prior subtitle language may be programmed on the disc.
- Some DVD video discs allow you to change subtitle selections only via the disc menu. If this is the case, press the MENU button and choose the appropriate subtitle language from the selection on the disc menu.

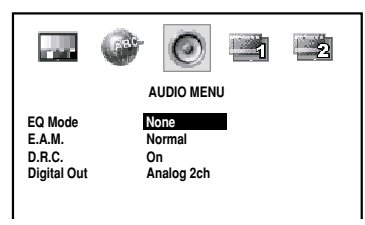

EQ Mode DVD-V VCD CD

You can select a preferred equalizer mode.

- None : Equalizer is not used.
- Jazz : Equalizer mode for Jazz.
- Hall : Equalizer mode for Hall.
- Stadium : Equalizer mode for Stadium.

E.A.M. DVD-V VCD CD

You can obtain expansive virtual surround sound effects from just two speakers.

Normal: Normal sound.

3D: To obtain expansive virtual surround sound effects from just two speakers.

Note

Pressing the E.A.M. button on the remote control also allows you to achieve the same setup. **36**

D.R.C. DVD-V

Turn on or off a function that makes faint sounds easier to hear even if you lower the volume during late hours playback.

D.R.C. = Dynamic Range Control

- On : Dynamic range is reduced.
- Off : Full dynamic range is maintained.

Notes

- This function works only during playback of Dolby Digital recorded discs.
- The level of Dynamic Range Control may differ depending on the DVD disc.

Customizing the Function Settings (continued)

Setting details

Digital Out DVD-V VCD CD

Select the output sound format corresponding to your system connection.

For details of sound recording systems, see [40](#).

Bitstream: Select when connected to an amplifier equipped with a Dolby Digital, DTS, MPEG1 or MPEG2 decoder. [58](#) [59](#)
The player outputs digital audio signal in the bitstream format when you play a DVD video disc recorded in the Dolby Digital, DTS, MPEG1 or MPEG2 recording system.

Analog 2ch: Select when connected to a TV or stereo system via the analog audio jacks. [54](#) [55](#)

PCM: Select when connected to a 2 channel digital stereo amplifier. [59](#)
The player outputs sounds in the PCM 2ch format when you play a DVD video disc recorded on the Dolby Digital, MPEG1 or MPEG2 recording system.

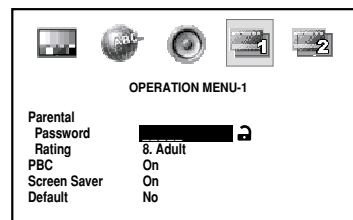
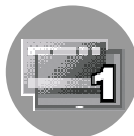

Parental DVD-V

DVD video discs equipped with the parental lock function are rated according to their content. The contents allowed by a parental lock level and the way a DVD video disc can be controlled may vary from disc to disc. For example, if the disc allowed you could edit out violent scenes unsuitable for children and replace them with more suitable scenes, or lock out playback of the disc altogether.

- DVD video discs may or may not respond to the parental lock settings. This is not a defect in the player. Make sure this function works with your DVD video discs.

■ To set the parental level

- 1) Press **ENTER** multiple time and select the parental level to set.

Rating 8: Adult
Rating 7: NC-17
Rating 6: R
Rating 5: PG-R
Rating 4: PG-13
Rating 3: PG
Rating 2: G
Rating 1: Kid Safe

- 2) Press **▲** / **▼** and select Password.
- 3) Press the number buttons to create a personal 5-digit security code.
- 4) Press **ENTER**.

 appears when the password is locked.

 appears when the lock is cancelled.

■ To change the parental lock level

Follow steps 2) - 4).

■ **To change your 5-digit security code**

1) After selecting password, press the 9 button five times.

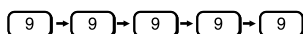

The 5-digit security code is cleared.

2) Press the number buttons to create a new 5-digit security code.

PBC VCD

For details of PBC, see 9.

On : To use the menu when playing a PBC-featured VIDEO CD.

Off : When playing a VIDEO CD without using the menu.

Screen Saver DVD-V

On : The screen saver operates.

Off : The screen saver is disengaged.

Default DVD-V VCD CD

No : To not restore the function settings to their default settings.

Yes : To restore the function settings to their default settings.

To restore both the function settings and picture settings to their default settings, press the **SETUP** button while pressing the **SHIFT** button on the remote control, then press the **CLEAR** button.

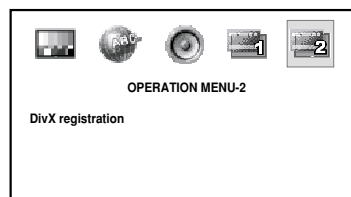

DivX registration DVD-V VCD CD

If you select "Display" and press ENTER, the DivX® information appears.

While it is displayed, press "Done" to return to the "OPERATION MENU-2" display.

Connections

You can connect the player to a TV or audio system. Also, you can connect a battery pack to power the player.

- **Connecting to a TV or audio system**
- **Connecting to Headphones**
- **Viewing Pictures From Connected Video Equipment**
- **Connecting to Audio Equipment**
- **Using the Battery Pack**
- **Using the automobile/vehicle adapter or power port**

Connecting to a TV or audio system

Connect the player to your TV or audio system.

For details of output sound, see [40](#).

Connecting to a TV

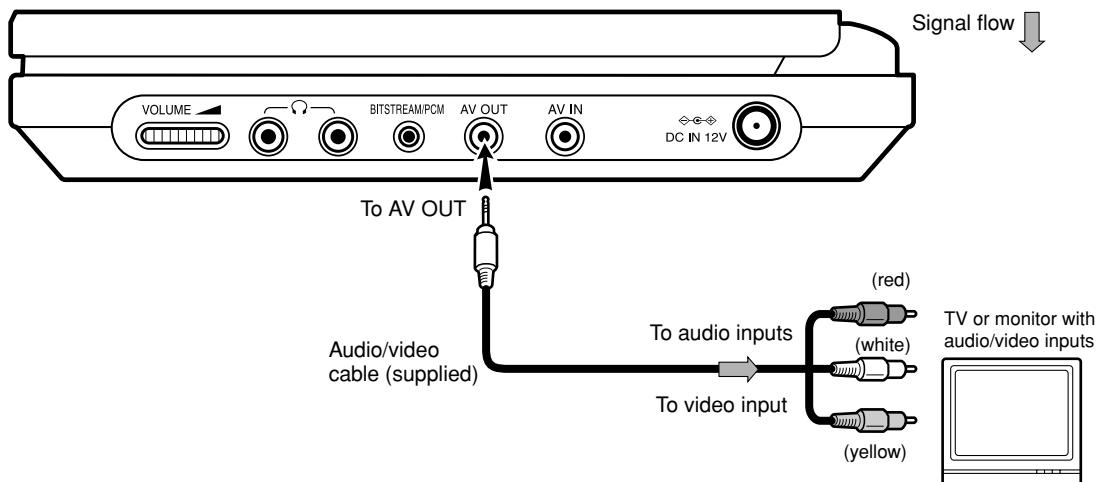

- Make the following setting.

| On-screen display | Select: | Page |
|-------------------|--------------|--------------------|
| "Digital Out" | "Analog 2ch" | 46 |
| | | 50 |

If you connect an audio/video cable (external output cord) to the AV-OUT jack, video is not displayed on the LCD of the player because the player switches to external output mode. Disconnect the audio/video cable when you want to display video on the LCD of the player.

Notes

- Refer to the owner's manual of the connected TV as well.
- When you connect the player to your TV, be sure to turn off the power and unplug both units from the wall outlet before making any connections.
- Connect the player directly to your TV. If you connect the player to a VTR, TV/VTR combination or video selector, the playback picture may be distorted as DVD video discs are copy protected.

■ To switch LCD screen / Memory Card / AV-IN

Select a mode other than AV-IN to output to an external device connected to the player.

Press **MODE** button on the player.

MODE Each time the button is pressed, the LCD will change as below.

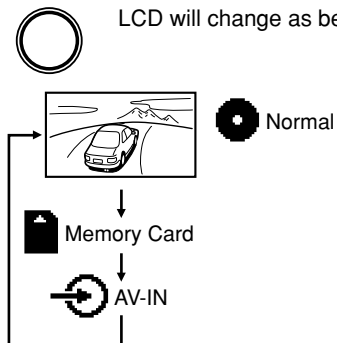

Normal: Outputs video and audio to the LCD of the player only.

Memory Card: To switch to the Memory Card mode.
AV-IN: Inputs video and audio from an external device such as a VTR connected to the LCD of the player, thus allowing you to view video on the LCD of the player.

Note

- Normal will be set the next time the player is turned on even if you turn the power of the player off while AV-IN is set.

Connecting to an audio system

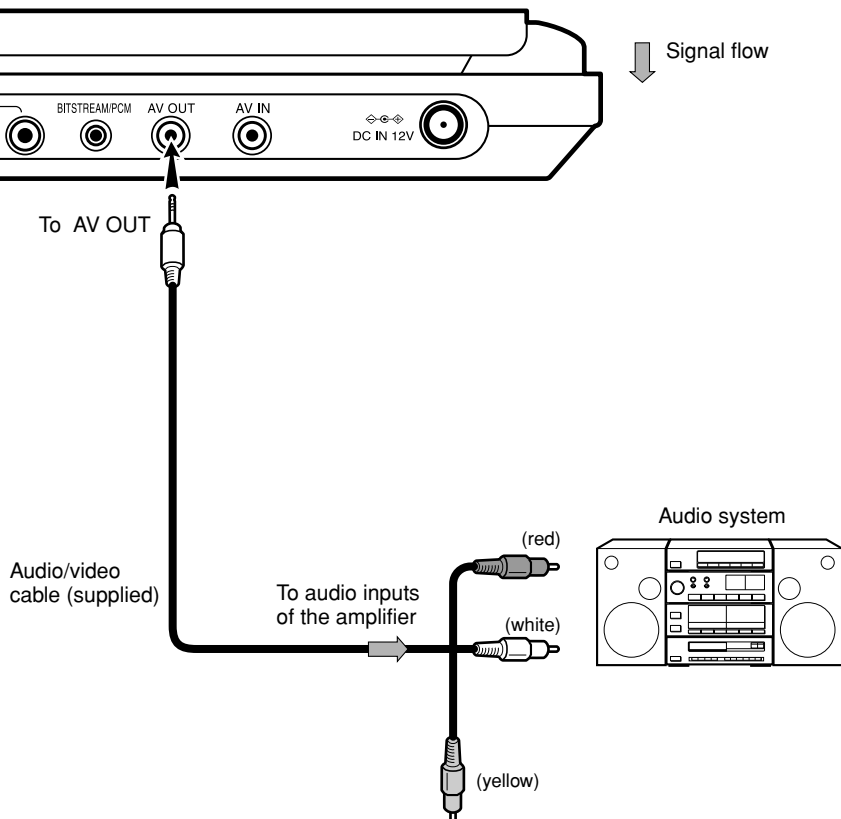

When the AV OUT or BITSTREAM/PCM jacks are connected to the audio input terminals of an audio system, sounds of discs can be heard on the connected audio system. For instructions on connections to audio systems, see [57](#).

- Make the following setting.

| On-screen display | Select: | Page |
|-------------------|----------------------------|--|
| "Digital Out" | "Bitstream" or "PCM" | 46 50 |

Notes

- Refer to the owner's manual of the connected equipment as well.
- When you connect the player to other equipment, be sure to turn off the power and unplug all of the equipment from the wall outlet before making any connections.
- If you place the player near a tuner or radio, the radio broadcast sound might be distorted. In this case, place the player away from the tuner and radio.
- The output sound of the player has a wide dynamic range. Be sure to adjust the receiver's volume to a moderate listening level. Otherwise, the speakers and your hearing may be damaged by a sudden high volume sound.
- Turn off the amplifier before you connect or disconnect the player's power cord. If you leave the amplifier power on, the speakers may be damaged.

Connecting to Headphones

You can listen to movies and music privately by connecting headphones.

CAUTION
When you use headphones, keep the volume at a moderate level. If you use the headphones continuously with high volume sound, it may cause hearing damage.

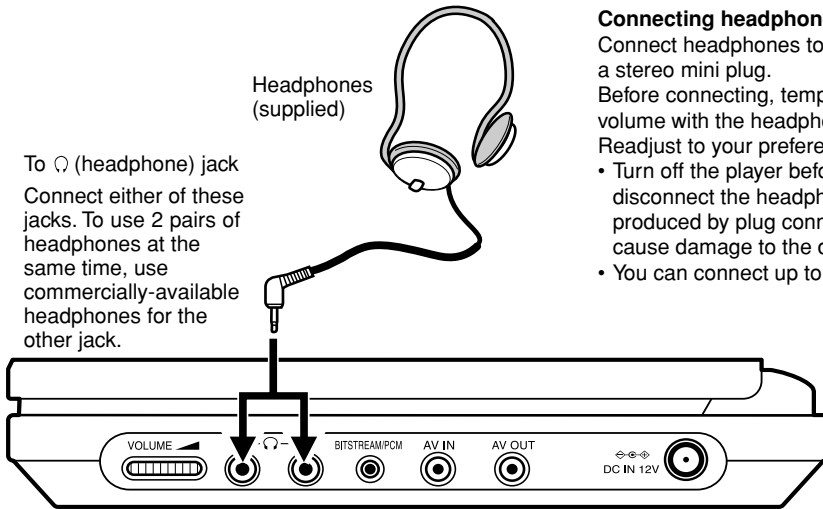

Connecting headphones

Connect headphones to the headphone jack using a stereo mini plug.
Before connecting, temporarily turn down the volume with the headphone volume control. Readjust to your preference when playback starts.

- Turn off the player before you connect or disconnect the headphone cable. Possible shakes produced by plug connecting/disconnecting may cause damage to the disc.
- You can connect up to 2 headphones.

Viewing Pictures From Connected Video Equipment

You can use the LCD of this player to monitor pictures of video equipment connected via the AV IN jack. To select the external AV input mode, press the MODE button. In the external AV input mode (AV-IN appears on the screen), screen saver function/auto power OFF function becomes ineffective.

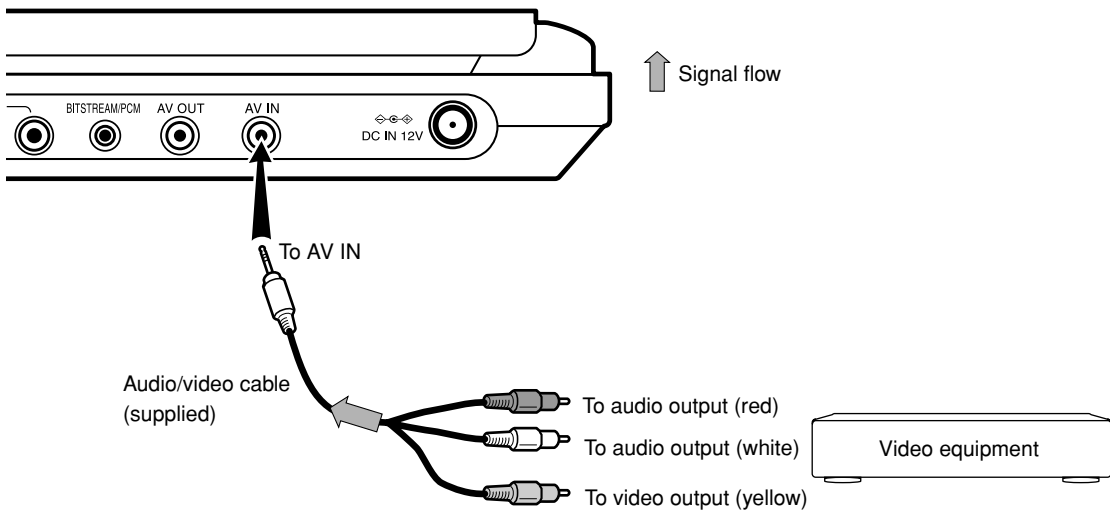

Notes

- When supplying non-standard signals such as playback images from a video deck or images from a game player, some images may be displayed incorrectly.
For example, shooting games, which shoots at a target on the screen with a light gun, may not work because of the LCD Color monitor properties.
- Normal will be set the next time the player is turned on even if you turn the power of the player off while AV-IN or Memory Card is set.
- The Video input (AV IN) jack is available only for the PAL signal.

Connecting to Audio Equipment

You can enjoy high quality dynamic sounds by connecting the player to audio equipment.

- For connection to your TV, see “Connecting to a TV” [54](#).
- For details of output sound, see [40](#).
- This section uses the following reference marks.

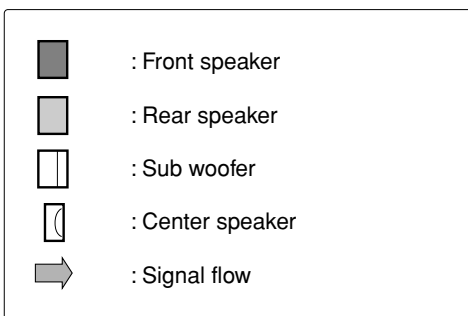

CAUTION

- When you are connecting (via the BITSTREAM/PCM jack) an AV decoder that does not have Dolby Digital, Digital Theater Systems (DTS) or MPEG2 decoding function, be sure to set “Digital Out” to “PCM” from the on-screen displays [46](#) [50](#). Otherwise, high volume sound may damage your hearing as well as the speakers.
- When playing DTS-encoded discs (audio CDs), excessive noise may be output from the analog audio output jacks. To avoid possible damage to the audio system, you should take proper precautions when the analog audio output jacks of the player are connected to an amplification system. To enjoy DTS Digital Surround® playback, an external 5.1 channel DTS Digital Surround® decoder system must be connected to the BITSTREAM/PCM jack of the player.

Notes

- DO NOT connect the BITSTREAM/PCM jack of the player to the AC-3 RF input of a Dolby Digital Receiver. This input on your A/V Receiver is reserved for Laserdisc use only and is incompatible with the BITSTREAM/PCM jack of the player.
- Connect the BITSTREAM/PCM jack of the player to the “DIGITAL (OPTICAL)” input of a Receiver or Processor.
- Refer to the owner’s manual of the connected equipment as well.
- When you connect the player to other equipment, be sure to turn off the power and unplug all of the equipment from the wall outlet before making any connections.
- The output sound of the player has a wide dynamic range. Be sure to adjust the receiver’s volume to a moderate listening level. Otherwise, the speakers may be damaged by a sudden high volume sound.
- Turn off the amplifier before you connect or disconnect the player’s power cord. If you leave the amplifier power on, the speakers may be damaged.

Connecting to Audio Equipment (continued)

Connecting to an amplifier equipped with a Dolby Digital decoder

Dolby Digital

Dolby Digital is the surround sound technology used in theaters showing the latest movies, and is now available to reproduce this realistic effect in the home. You can enjoy motion picture and live concert DVD video discs with this dynamic realistic sound by connecting the player to a 6 channel amplifier equipped with a Dolby Digital decoder or Dolby Digital processor.

Manufactured under license from Dolby Laboratories. "Dolby" and the double-D symbol are trademarks of Dolby Laboratories. Confidential Unpublished Works. © 1992-1997 Dolby Laboratories, Inc. All rights reserved.

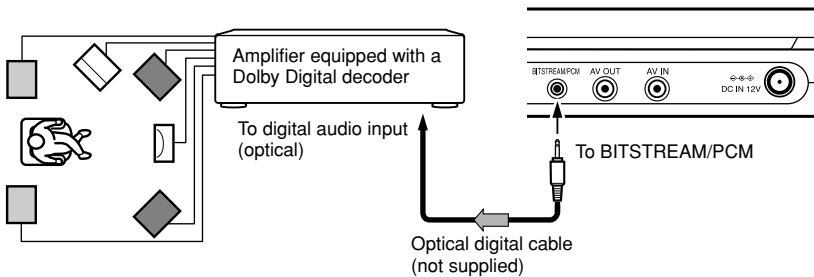

- Use DVD video discs encoded via the Dolby Digital recording system.
- Make the following setting.

| On-screen display | Select: | Page |
|-------------------|---------------|------------------------|
| "Digital Out" | "Bitstream" | 46 50 |
| Recording system | Dolby Digital | 40 |

Connecting to an amplifier equipped with a DTS decoder

Digital Theater Systems (DTS)

DTS is a high quality surround technology used in theaters and now available for home use, on DVD video discs or audio CDs. If you have a DTS decoder or processor, you can obtain the full benefit of 5.1 channel DTS encoded sound tracks on DVD video discs or audio CDs.

"DTS" and "DTS Digital Out" are trademarks of Digital Theater Systems, Inc.

- Use DVD video discs or audio CDs encoded via the DTS recording system.
- Make the following setting.

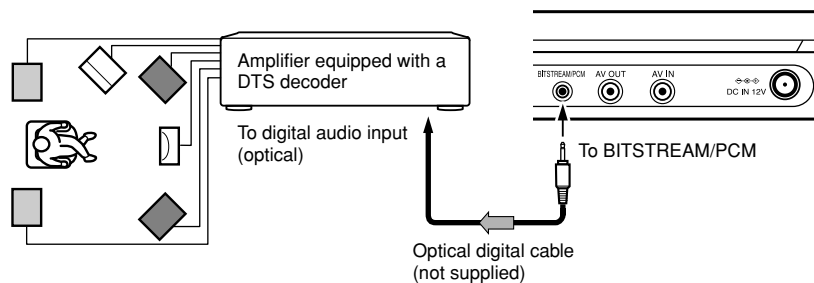

| On-screen display | Select: | Page |
|-------------------|-------------|------------------------|
| "Digital Out" | "Bitstream" | 46 50 |
| Recording system | DTS | 40 |

Connecting to an amplifier equipped with an MPEG2 audio decoder

MPEG2 sound

You can enjoy motion picture and live concert DVD video discs with dynamic realistic sound by connecting an amplifier equipped with an MPEG2 audio decoder or MPEG2 audio processor.

- Use DVD video discs encoded via the MPEG2 recording system.
- Make the following setting.

| On-screen display | Select: | Page |
|-------------------|-------------|------|
| "Digital Out" | "Bitstream" | 46 |
| | | 50 |
| Recording system | MPEG2 | 40 |

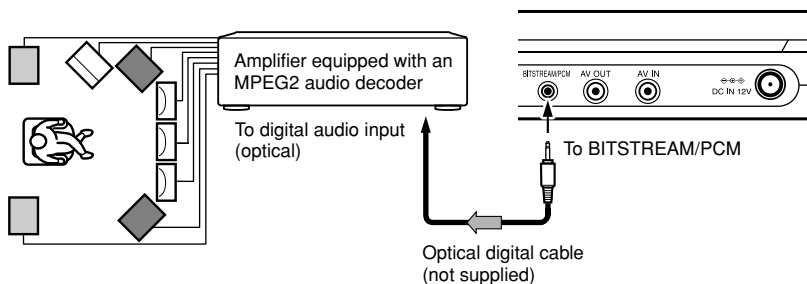

Connecting to an amplifier equipped with a digital audio input

2 channel digital stereo

You can enjoy the dynamic sound of 2 channel digital stereo by connecting an amplifier equipped with a digital audio input and speaker system (right and left front speakers).

- Make the following setting.

| On-screen display | Select: | Page |
|-------------------|---------|------|
| "Digital Out" | "PCM" | 46 |
| | | 50 |

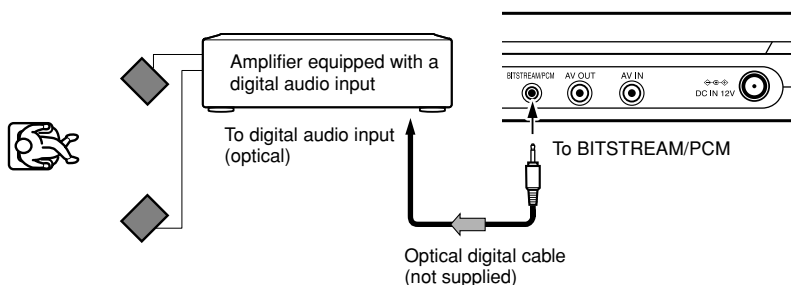

Using the Battery Pack

WARNING

- Do not use a battery pack other than one specified as it can result in a fire or damage to the unit.
- Do not heat, open, or short-circuit the battery pack. Do not throw the battery pack into a fire. Doing so may cause an explosion or a fire.
- Attach the battery pack properly following the explanation below. Make sure that the battery pack is attached firmly to the player when using it. Otherwise, the battery pack may become detached and cause personal injury.

Charge it before using.

■ Attaching the battery pack

First disconnect the AC adapter and the power cord from the player, then attach the battery pack.

- 1 Turn the player off.
- 2 Turn the player upside down.
- 3 Remove the connector cover on the bottom of the player.

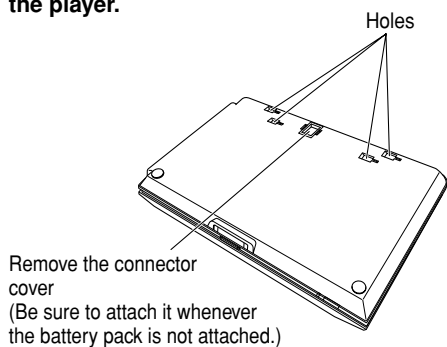

- 4 Turn the battery pack over and insert four catches into the player's corresponding holes ①. Then, slide the battery pack in the direction of the arrow ② until a "click" is heard.

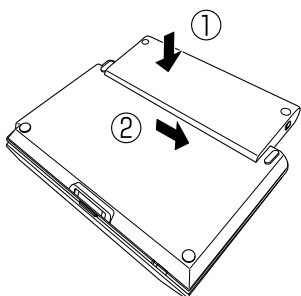

Note

Remove the battery pack from the player after being used.

61

■ Charging the battery pack

The battery indicator is shown in the upper left corner of the screen when the power in the battery pack is running low.

- 1 Turn the player off.
The battery pack will be charged only when the POWER to the player is turned OFF.
- 2 Attach the battery pack to the player.
- 3 Connect the supplied AC adapter and the power cord to the player. 16
Charging starts, and the POWER/CHG indicator illuminates in orange.
When the charging is completed, the POWER/CHG indicator turns off.

Notes

- While the charge is in progress, do not disconnect the AC adapter and the power cord until the POWER/CHG indicator turns off.
- The attached battery pack may get warm when you are charging it or operating the player. This is not a defect.
- Charge the battery pack with a surrounding temperature of +10°C to +30°C.

■ Charging time of a battery pack

Approximately 3.5 hours

The battery pack can be charged only when the player is turned OFF. Charging time depends on environmental conditions.

■ Continuous playback time while using the battery pack

Up to approximately 4 hours

This value is for reference purpose only, it is not guaranteed.
(Conditions: 25°C, output from the headphone, new battery pack in use.)

- Continuous playback time may vary depending on battery pack status, operational status and environment conditions.
- Low temperature will shorten the playback time.

■ Detaching the battery pack

- 1 Turn the player off.
- 2 Disconnect the AC adapter and the power cord from the player.
- 3 Turn the player upside down.
- 4 Slide the battery pack's lock switch in the direction of the arrow ①, then slide the battery pack in the direction of the arrow ② to remove it.

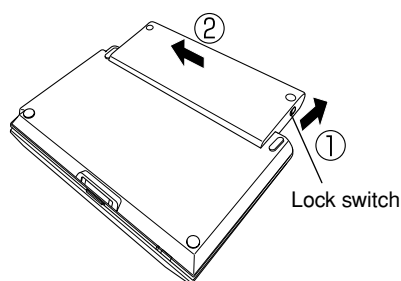

- 5 Attach the connector cover on the bottom of the player.

Note

Do not detach the battery pack while the POWER/CHG indicator illuminates in green or orange.

■ About battery pack life

Battery pack has a limited service life. The length of service life varies depending on product use and user settings. If you use the battery pack beyond its service life, you may notice that playback time becomes remarkably shorter, even if the battery pack is fully charged. If you notice that playback time has become remarkably shorter, even when the battery pack is fully charged, it is recommended that you replace the battery pack with battery pack model number SD-PBP18E.

Using the automobile/vehicle adapter or power port

For use of the DVD player in a car, this adapter can power the DVD player from the cigarette lighter socket.

WARNING

- NEVER operate the DVD player or view a DVD Video while operating an automobile or other vehicle. Note: doing so is illegal in many jurisdictions.
NEVER place a DVD player within the eyesight of a driver while he/she is driving an automobile/vehicle. Note: A DVD player located in the front seating section of a vehicle is illegal in many jurisdictions.
Failure to observe the above instructions could result in the driver's inattention to and/or distraction from road hazards.
- NEVER place a DVD player in a location where it could interfere with the proper deployment and/or performance of an air bag.
Failure to observe this instruction could result in the prevention of an air bag to properly and/or effectively deploy.
- Do not use an adapter other than the model supplied, to power the player. Do not use the supplied vehicle adapter to power an apparatus other than this player. Neglecting these may cause smoke, fire or electrical shock to human body.
- This adapter is intended for exclusive use in automobiles/vehicles with a DC 12V negative ground electrical system. NEVER use this adapter with a DC 24V configured automobile/vehicle.
Consult your vehicle owner's manual before using this adapter.
- ALWAYS use caution when touching the adapter, cigarette lighter socket or power port. The adapter, lighter socket and power port may become heated after prolonged use.
- Do not charge the battery pack which is attached to the DVD player by the adapter. Doing so may cause smoke, fire or electrical shock to human body. Whenever you use the adapter, be sure to remove the battery pack from the DVD player to prevent it being charged by the adapter.
- Do not touch the adapter with wet hands. Do not get liquid on the adapter.

Notes

- Never operate the player in a moving vehicle. Vibration may prevent proper playback of the player or cause damage to the disc.
- Do not leave the adapter in an unoccupied vehicle to avoid exposing it to unusually high ambient temperatures.
- Remove the adapter power plug from the cigarette lighter socket or power port before turning the engine off.
- When the DVD player is not in use be sure to remove the adapter power plug from the cigarette lighter socket or power port and the pin plug from the DVD player.
- Do not force the adapter into an incompatible lighter socket or power port.
- Avoid dropping the adapter or placing heavy objects on it.
- Do not pull the adapter power cord when removing it from a socket or power port.
Always grasp and pull the body.
Failure to do so could cause damage to and malfunction of the adapter.
- Do not operate the DVD player using the adapter for a prolonged period with the car engine off. The car battery may be too exhausted to turn the engine on.
- Depending on the vehicle model or the location of the cigarette lighter socket, this adapter may not be applied.

■ Instructions for Use

- 1 Turn off the DVD player.
- 2 Insert the pin plug of the adapter into the DC IN 12V jack of the DVD player.

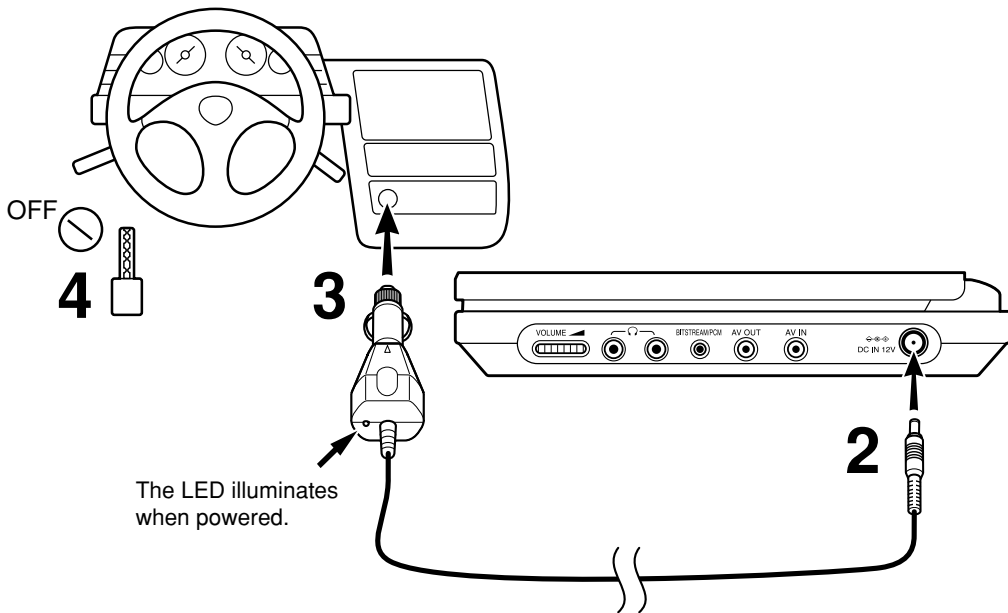

- 3 Insert the plug of the adapter into the cigarette lighter socket or power port fully.
- 4 Turn on the vehicle engine so that the cigarette lighter socket or power port is powered. In some vehicles the cigarette lighter socket or power port is powered even when the vehicle's engine is not running. It is important that the vehicle owner's manual be consulted.
- 5 When disconnecting the DVD player, first remove the adapter pin plug from the DVD player and then the power plug from the cigarette lighter socket or power port.

Specification

Operating temperature: 5 – 35°C
Operating humidity: 30 – 80%
Storage temperature: -10 – 60°C
Storage humidity: 20 – 80%

Others

- Before Calling Service Personnel
- Specifications
- Customer Helpline

Before Calling Service Personnel

Check the following guide for the possible cause of a problem before contacting service.

Symptoms and correction

| Symptom | Cause | Correction | Page |
|--|--|--|----------------------|
| No power. | • The AC adapter or power plug is disconnected. | • Connect the AC adapter or power plug securely. | 16 |
| | • The battery pack has been removed. | • Install the battery pack. | 60 |
| | • Battery empty. | • Re-charge the battery. | 60 |
| The LCD turned off by itself. | • The automatic LCD off function turned the LCD off. | • Press any button. | 21 |
| No picture. (Other than built-in LCD monitor) | • The connected TV is not set to receive DVD signal output. | • Select the appropriate video input mode on the TV so the picture from the player appears on the TV screen. | — |
| No sound. (Connected TV or audio system.) | • The equipment connected via the audio/video cable is not set to receive DVD signal output. | • Select the correct input mode of the audio receiver so you can listen to the sound from the player. | — |
| | • The volume is too low. | • Adjust the volume by turning the volume control. | 19 |
| | • The audio receiver or TV is turned off. | • Turn on the equipment connected with the audio/video cable. | — |
| | • The setting of output sound format is incorrect. | • Select the proper audio setting. | 40, 46 49 |
| The playback picture has occasional distortion. | • The disc is dirty. | • Eject the disc and clean it. | 8 |
| | • Player is in fast forward or fast reverse mode. | • Sometimes a small amount of picture distortion may appear. This is not a malfunction. | — |
| | • The player was moved or given a shock. | • Vibrating or shaking the player during playback may produce distortion. This is not a malfunction. If not restored to usual status, stop playback and start again. | — |
| | • The disc is not set firmly. | • Remove the disc and set it again. | 18 |
| Brightness is unstable or noises are present in the playback pictures. (Other than built-in LCD monitor) | • The effect of copy protection. | • Connect the player directly to the TV. Avoid connecting the player to a VTR or TV/VTR combination. | 54 |
| The player does not start playback. | • No disc is inserted. | • Insert a disc. | 18 |
| | • An unplayable disc is inserted. | • Insert a playable disc. (Check the disc type, color system and region number.) | 9, 10 |
| | • The disc is inserted upside down. | • Insert the disc with the playback side down. | 18 |
| | • The disc is not inserted securely. | • Insert the disc securely in the disc holder. | 18 |
| | • The disc is dirty. | • Clean the disc. | 8 |
| | • The parental lock function is set. | • Cancel the parental lock function or change the parental lock level. | 50 |
| | • The player is set to the external input mode (AV-IN). | • To play a disc with the player, Normal needs to be set. Press MODE repeatedly so that you can view playback picture. | 54 |
| Playback does not follow the course of the disc's program. | • It is in the repeat playback mode, memory playback, etc. | • These operations may prevent a proper progression of the contents. | — |
| Buttons do not work. | • Power supply fluctuations or other abnormalities such as static electricity may interrupt correct operation. | • Turn the power on or off with the POWER switch. Or disconnect the power plug and insert it into the wall outlet again. | — |

| Symptom | Cause | Correction | Page |
|--|---|---|------|
| The remote control does not work properly. | • The remote control is not pointed at the remote sensor of the player. | • Point the remote control at the remote sensor of the player. | 15 |
| | • The remote control is too far from the player. | • Operate the remote control within about 3 m. | 15 |
| | • The batteries in the remote control are exhausted. | • Replace the batteries with new ones. | 15 |
| | • The player's remote sensor is exposed to a strong light source such as direct sunlight or other illumination. | • Avoid the player from being exposed to a strong light source. | 15 |

Specifications

Player / Connectors / Liquid crystal display / Supplied accessories

Player

| | |
|----------------------|--|
| Power supply | DC 12 V (Rated current : 2 A (Maximum: during battery pack charging)) 100 – 240 V AC, 50/60 Hz (with the supplied AC adapter) |
| Mass | 850 g |
| External dimensions | 230 × 31.8 × 155 mm (W/H/D) |
| Signal system | PAL/3.58NTSC |
| Laser | Semiconductor laser, wavelength 650 nm / 795 nm |
| Frequency range | DVD linear sound : 48 kHz sampling 4 Hz to 22 kHz 96 kHz sampling 4 Hz to 44 kHz |
| Operating conditions | Temperature: 5 °C to 35 °C, Operation status: Horizontal |

Connectors

| | |
|------------------------------|---|
| AV output (AV OUT) | Ø3.5mm mini jack × 1 Video: 1.0 V (p-p), 75 Ω, negative sync., Audio: 2.0 V (rms), 100 Ω |
| AV input (AV IN) | Ø3.5mm mini jack × 1 Video: 1.0 V (p-p), 75 Ω, negative sync., Audio: 2.0 V (rms), 10k Ω |
| Audio output (BITSTREAM/PCM) | Optical connector (Ø3.5mm) × 1 |
| Headphone terminal | Ø3.5mm stereo mini jack × 2 |

* The Video input (AV IN) jack is available only for the PAL signal.

Liquid crystal display

| | |
|-------------------|--|
| Panel size | 20.3cm (8 inches diagonally measured) |
| Projection system | TN color transmission |
| Driving system | Amorphous silicon TFT active matrix |
| Resolution | 480 (H) × 234 (V) pixels (effective pixel rate : more than 99.99%) |

Supplied accessories

| | | |
|------------------------------------|---|--|
| Audio/video cable | 1 | |
| Remote control | 1 | |
| Coin-shaped battery (CR2025) | 1 | |
| AC adapter (ADPV16A) | 1 | |
| Power cord | 2 | |
| Battery pack (SD-PBP18E) | 1 | |
| Vehicle adapter (MEDC01AX) | 1 | |
| Headphone | 1 | |
| Carrying case | 1 | Use this for carrying, etc. of the player. |

Notes

- This model complies with the above specifications.
- Designs and specifications are subject to change without notice.
- This model may not be compatible with features and/or specifications that may be added in the future.

Customer Helpline

(This is only for U.K. customers.)

Should you experience any problems during the installation of this product or within the first 12 months of purchase* please call the **Toshiba Customer Helpline on 01159766958.**

To assist the Helpline when contacting them please have available.

- The Owners manual supplied with the Product,
- The Model Number,
- The Serial Number (generally on the bottom of the unit),
- A pen.

* Should you experience any problems after 12 months from date of purchase contact your original supplying dealer.







TOSHIBA

Printed in China

Free Manuals Download Website

<http://myh66.com>

<http://usermanuals.us>

<http://www.somanuals.com>

<http://www.4manuals.cc>

<http://www.manual-lib.com>

<http://www.404manual.com>

<http://www.luxmanual.com>

<http://aubethermostatmanual.com>

Golf course search by state

<http://golfingnear.com>

Email search by domain

<http://emailbydomain.com>

Auto manuals search

<http://auto.somanuals.com>

TV manuals search

<http://tv.somanuals.com>