

TOSHIBA

PORTABLE DVD PLAYER

SD-P1900SR

OWNER'S MANUAL



Introduction

Preparations

Playback

Function Settings

Connections

Others

H PX1D00001401

SAFETY PRECAUTIONS

WARNING: TO REDUCE THE RISK OF FIRE OR ELECTRIC SHOCK, DO NOT EXPOSE THIS APPLIANCE TO RAIN OR MOISTURE. DANGEROUS HIGH VOLTAGES ARE PRESENT INSIDE THE ENCLOSURE. DO NOT OPEN THE CABINET. REFER SERVICING TO QUALIFIED PERSONNEL ONLY.

CAUTION: This equipment employs a Laser System.

To ensure proper use of this product, please read this owner's manual carefully and retain for future reference. Should the unit require maintenance, contact an authorised service location - see service procedure.

Use of controls or adjustments or performance of procedures other than those specified herein may result in hazardous radiation exposure.

To prevent direct exposure to laser beam, do not try to open the enclosure.

Visible and invisible laser radiation when open and interlocks defeated.

DO NOT STARE INTO BEAM.

This equipment is categorized as "Class 1 Laser Product" in EN60825, the European common laser standard.

CLASS 1 LASER PRODUCT

In the spaces provided below, record the Model and Serial No. located on the bottom of your DVD player.

Model No. _____ Serial No. _____

Retain this information for future reference.

About disposal

The cold cathode fluorescent lamp in the LCD panel contains a small amount of mercury. Please follow local ordinances or regulations when you dispose of the product.

SAFETY PRECAUTIONS

Location of the required label

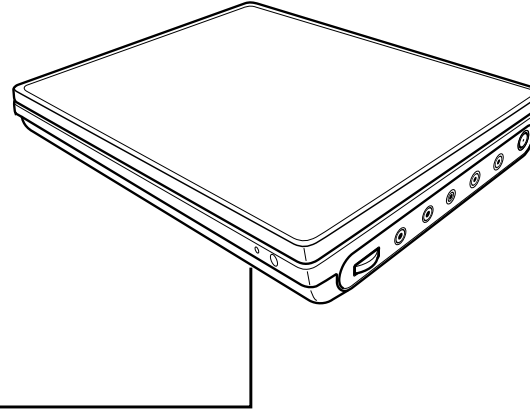

Following information is only for EU-member states:

The use of the symbol indicates that this product may not be treated as household waste. By ensuring this product is disposed of correctly, you will help prevent potential negative consequences for the environment and human health, which could otherwise be caused by inappropriate waste handling of this product. For more detailed information about recycling of this product, please contact your local city office, your household waste disposal service or the shop where you purchased the product.

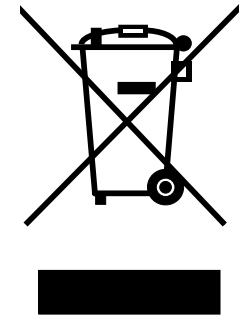

IMPORTANT SAFETY INSTRUCTIONS

CAUTION: PLEASE READ AND OBSERVE ALL WARNINGS AND INSTRUCTIONS GIVEN IN THIS OWNER'S MANUAL AND THOSE MARKED ON THE UNIT. RETAIN THIS BOOKLET FOR FUTURE REFERENCE.

This unit is fully transistorized and does not contain any parts that can be repaired by the user.

DO NOT REMOVE THE CABINET COVER, OR YOU MAY BE EXPOSED TO DANGEROUS VOLTAGE. REFER SERVICING TO QUALIFIED SERVICE PERSONNEL ONLY.

1. Read these instructions.
2. Keep these instructions.
3. Heed all warnings.
4. Follow all instructions.
5. Do not use this apparatus near water.
6. Clean only with dry cloth.
7. Do not install near any heat sources such as radiators, heat registers, stoves, or other apparatus (including amplifiers) that produce heat.
8. Protect the power cord from being walked on or pinched particularly at plugs, convenience receptacles, and the point where they exit from the apparatus.
9. Only use attachments/accessories specified by the manufacturer.
10. Unplug this apparatus during lightning storms or when unused for long periods of time. However, while it is thundering or lightning, do not touch the apparatus and any connected cable and/or equipment. This will prevent you from receiving the electric shock by an electric surge.
11. Refer all servicing to qualified service personnel. Servicing is required when the apparatus has been damaged in any way, such as power-supply cord or plug is damaged, liquid has been spilled or objects have fallen into the apparatus, the apparatus has been exposed to rain or moisture, does not operate normally, or has been dropped.

IMPORTANT SAFETY INSTRUCTIONS

ADDITIONAL SAFETY INSTRUCTIONS

12. When you use headphones, keep the volume at a moderate level. If you use the headphones continuously with high volume sound, it may cause hearing damaged.
13. Do not overload wall outlets; extension cords, or integral convenience receptacles as this can result in a risk of fire or electric shock.
14. Apparatus shall not be exposed to dripping or splashing and no objects filled with liquids, such as vases, shall be placed on the apparatus and/or around it.
15. Be careful not to catch your fingers in the disc holder when closing the lid. It may cause personal injury.
16. Do not put a vessel containing liquid such as a vase, or a metal object on the apparatus. If liquid or a foreign metal object is let into the apparatus, it may cause fires or electric shock.
17. Do not use a cracked, deformed, or repaired disc. These discs are easily broken and may cause serious personal injury and apparatus malfunction.
18. Do not touch a spinning disc. When you open the disc holder, the disc may have not stopped spinning. Touching a spinning disc may cause personal injury or damage to the product.
19. Do not rest the product on your lap or other parts of body. The product may become warm during use. Even low temperatures may cause personal injury when exposed to your skin for prolonged periods.
20. Use the supplied AC adapter to operate the product. Substitute devices not specified by the manufacturer may result in fire or product malfunction. Do not cover the AC adapter with a blanket or place it near heating or on electric carpet when it is in use.
21. When you use this product in an airplane, follow the instructions of the airline. Disregarding them may cause harmful interference to radio communication.
22. Do not stare at the pick-up lens or look at the laser beam. Doing so may cause damage to eyesight.

23. Do not use this product while walking or driving. Neglecting this may cause a traffic accident.
24. CAUTION: If the DVD player is dropped and the cabinet or enclosure surface has been damaged or the DVD player does not operate normally, take the following precautions:
- ALWAYS turn off the DVD player and unplug the power cord to avoid possible electric shock or fire.
 - NEVER allow your body to come in contact with any broken glass or liquid from the damaged DVD player. The LCD panel inside the DVD player contains glass and a toxic liquid. If the liquid comes in contact with your mouth or eyes, or your skin is cut by broken glass, rinse the affected area thoroughly with water and consult your doctor.
 - ALWAYS contact a service technician to inspect the DVD player any time it has been damaged or dropped.
25. Use the player in a location that facilitates the immediate removal of the plug if there is a malfunction or failure.
26. Battery Pack
- a) Never throw the battery pack into a fire, as that could cause the battery pack to explode. Never heat the battery pack, as that could cause leakage of alkaline solution or other electrolytic substance.
 - b) Never disassemble the battery pack, as that could cause leakage of alkaline solution or other electrolytic substance.
 - c) Never short-circuit the battery pack by either accidentally or intentionally bringing the terminals in contact with another metal object. This could cause personal injury or a fire, and could also damage the battery pack.
 - d) Never drive a nail into the battery pack. Never strike the battery pack with a hammer. Never step or tread on the battery pack.
 - e) If you ever smell an unusual odor, excessive heat, discoloration, or deformation of the battery pack, remove it from the player after confirming safety and discontinue use of it. Take the battery pack to an authorized Toshiba service provider.
 - f) Keep the battery pack away from heat or fire.

IMPORTANT SAFETY INSTRUCTIONS

- g) Never dispose of used battery packs with other ordinary solid wastes, since they contain toxic substances. Always dispose of used battery packs in accordance with community regulations that apply to the disposal of batteries. Cover the metal terminals with insulating tape, in order to prevent accidental short-circuiting.
 - h) Always confirm that the battery pack is compatible with your player, before attaching the battery pack to the player.
 - i) Never expose the terminals of the battery pack to any other metal object. Wrap the battery or place it in a protective plastic bag, whenever transporting it.
 - j) Always confirm that the temperature is between 5 and 35°C (41°F and 95°F) before you charge the battery. Leakage, excessive heat, or deterioration of the battery pack may occur if this caution is not heeded.
 - k) Never immerse the battery pack in any liquid.
 - l) Never expose the battery pack to direct sunlight. Never store or use the battery pack in a locked and unventilated vehicle. (where excessive internal temperatures may be encountered.)
 - m) Always keep the battery pack out of reach of infants or small children.
 - n) Never shock the battery pack by dropping or throwing it.
 - o) If the liquid contained within the battery pack leaks, use a large amount of water and immediately wash off any liquid which may accidentally contact any part of the body. Remove any liquid that has contacted your clothing by washing it immediately with a detergent.
 - p) Always confirm that a “click” sound has resulted, when attaching the battery pack to the player. This sound confirms that the battery pack has been properly attached.
- ## 27. Coin-shaped Battery
- a) Keep coin-shaped batteries out of children’s reach. Be careful not to ingest internally, especially by children, as doing so may cause poisoning.
 - b) Do not load a battery into the remote control with the wrong side out.
 - c) Do not charge, heat, open, or short-circuit the batteries. Do not throw the batteries into a fire.
 - d) Do not leave a dead or exhausted battery in the remote control.
 - e) If you do not use the remote control for a long period of time, remove the battery to avoid possible damage from battery corrosion.

28. After unpacking coin-shaped batteries, store them in poly bags, etc. separately one by one when unused. If you leave them unwrapped, they may be short-circuited by contact with metal objects, resulting in battery leakage, heat or bursting. This may cause burns or injury.

The batteries must be completely discharged when they are deposited in collection containers for old batteries. If a charge remains, countermeasures to prevent short circuits must be taken.

29. To reduce the risk of fire or electric shock, do not expose this apparatus to rain or moisture.

30. Following mark means "CAUTION - RISK OF ELECTRIC SHOCK - DO NOT OPEN".



31. Vehicle adapter and operation in a car

- a) NEVER operate the apparatus or view a DVD Video while operating an automobile or other vehicle. Note: doing so is illegal in many jurisdictions. NEVER place an apparatus within the eyesight of a driver while he/she is driving an automobile/vehicle. Note: an apparatus located in the front seating section of a vehicle is illegal in many jurisdictions.

Failure to observe the above instructions could result in the driver's inattention to and/or distraction from road hazards.

- b) NEVER place an apparatus in a location where it could interfere with the proper deployment and/or performance of an air bag. Failure to observe this instruction could result in the prevention of an air bag to properly and/or effectively deploy.
- c) Do not use a vehicle adapter other than the model supplied, to power the apparatus. Do not use the supplied vehicle adapter to power an apparatus other than this apparatus. Neglecting these may cause smoke, fire or electrical shock to human body.
- d) This adapter is intended for exclusive use in automobiles/vehicles with a DC 12V negative ground electrical system. NEVER use this adapter with a DC 24V configured automobile/vehicle. Consult your vehicle owner's manual before using this adapter.

IMPORTANT SAFETY INSTRUCTIONS

- e) When handling, using or storing the adapter power cord NEVER:
 - Place or locate near any apparatus that produces heat.
 - Disassemble, splice or extend the cord.
 - Pull, force or place any heavy objects on the cord.
 - Bend, twist or bind the cord.
- f) Keep away from the driving device (such as brake pedal, etc.) and the moving equipment (such as a seat rail, car windows, door, etc.).
- g) NEVER disassemble or alter this adapter in any manner.
- h) ALWAYS use caution when touching the adapter, cigarette lighter socket or power port. The adapter, lighter socket and power port may become heated after prolonged use.
- i) ALWAYS remove the adapter from the cigarette lighter socket or power port when not in use.
- j) Do not charge the battery pack which is attached to the apparatus by the adapter. Doing so may cause smoke, fire or electrical shock to human body. Whenever you use the adapter, be sure to remove the battery pack from the apparatus to prevent it from being charged by the adapter.
- k) Some cars may not have a compatible socket. NEVER modify this adapter to fit an incompatible cigarette lighter socket and/or power port. NEVER modify an incompatible cigarette lighter socket and/or power port to accept this adapter. Failure to observe the above warnings could cause smoke, fire, burns and/or electric shock.
- l) ALWAYS locate the apparatus on a level and secure surface. If placed on an uneven, shaky, unsecured or unstable surface, apparatus may fall. Failure to observe the above caution could result in the apparatus striking a person.
- m) When using the adapter, insert the plug of the adapter into the cigarette lighter socket or power port fully. The incomplete insertion will cause smoke or fire.
- n) Do not touch the adapter with wet hands. Do not expose the adapter to water or liquid.

Precautions

Notes on handling

- Do not shock the LCD monitor. It may cause unit damage and malfunction.
- Do not use the player in a place subject to vibration. Neglecting this may cause malfunction of the player or damage to the disc.
- Do not leave the player in a vehicle. Rise or drop in temperature may result in malfunction of the player.
- When transporting the player, the original shipping carton and packing materials come in handy. For maximum protection, repack the unit as it was originally packaged at the factory.
- Do not use volatile liquids, such as insect spray, near the player. Do not leave rubber or plastic products in contact with the player for a long time. They will leave marks on the finish.
- The player may become warm after a long period of use. This is not a malfunction.
- When the player is not in use, be sure to remove the disc and turn off the power.
- If you do not use the player for a long period, the unit may not function properly in the future. Turn on and use the player occasionally.

Notes on locating

- When you place this player near a TV, radio, or VTR, the playback picture may become poor and the sound may be distorted. In this case, move the player away from the TV, radio, or VTR.

Notes on cleaning

- Use a soft, dry cloth for cleaning. Do not use any type of solvent, such as thinner and benzine, as they may damage the surface of the player.
- When cleaning the LCD monitor, use a soft, dry cloth.

Precautions (continued)

Notes on moisture condensation

Moisture condensation damages the player. Please read the following carefully.

Moisture condensation occurs, for example, when you pour a cold drink into a glass on a warm day. Drops of water form on the outside of the glass. In the same way, moisture may condense on the optical pick-up lens inside this unit, one of the most crucial internal parts of the player.

■ **Moisture condensation occurs during the following cases.**

- When you transport the player directly from a cold place to a warm place.
- When you use the player in a room where you just turned on the heater, or a place where the cold air from the air conditioner directly hits the unit.
- In summer, when you use the player in a hot and humid place just after you move the unit from an air conditioned room.
- When you use the player in a humid place.

■ **Do not use the player when moisture condensation may occur.**

If you use the player in such a situation, it may damage discs and internal parts. Remove the disc, connect the AC adapter, turn on the player, and leave it for two or three hours. After two or three hours, the player will have warmed up and evaporated any moisture.

Notes on products incorporated laser system

- This product incorporates laser system. For proper and safety use of this product, read this owner's manual carefully, and keep near at hand for future reference.
When you need any repair of this product, consult your dealer where you purchased this product.
- Never disassemble or modify this product. Changes or modifications may result in exposure to laser radiation.

Exemptions

- Toshiba is not liable for any damage caused by fires, earthquake, etc., uses by a third person, accidents, owner's intentional or unintentional misuse, or uses in other improper conditions.
- Toshiba is not liable for incidental damages (such as profit loss or interruption in business, etc.) caused by use or unavoidable of this product.
- Toshiba is not liable for any damage caused by neglect of the instructions described in the owner's manual.
- Toshiba is not liable for any damage caused by misuse or malfunction through simultaneous use of this product and the connected equipment or software that Toshiba is not concerned with.

About this owner's manual

This owner's manual explains the basic instructions of this player. Some DVD video discs are produced in a manner that allows specific or limited operation during playback. As such, the player may not respond to all operating commands. This is not a defect in the player. Refer to instruction notes of discs.

“⊘” may appear on the screen during operation. A “⊘” means that the operation is not permitted by the player or the disc.

Notes on region numbers



The region number of this player is 5. Region numbers, corresponding to specific geographical playback area, are printed on your DVD video disc. If you do not find  or  , disc playback will not be allowed by the player. (In this case, the player will display a message on-screen.)

Table of contents

Introduction

SAFETY PRECAUTIONS	2
IMPORTANT SAFETY INSTRUCTIONS	5
Precautions	11
Identification of Controls	16
Accessories	19
Notes and Information	20
Playable discs	20

Preparations

Preparation of the remote control	24
Power connection	25
Using the battery pack	26
Powering on/off	29
Changing the AV mode	30

Playback

14 Loading a disc	32
--------------------------------	-----------

Connecting to headphones	33
Playing a disc	34
Pausing playback (Still mode).....	35
Adjusting the volume of the speakers or the connected headphones	35
Using the top menu.....	35
Changing a playback speed	37
Playing in fast reverse or fast forward	37
Playing frame by frame	37
Playing in slow-motion	37
Playing a desired scene	38
Skipping chapters or tracks	38
Locating by entering numbers	38
Marking the desired position to locate (Bookmark function).....	39
Playing in random order	40
Playing repeatedly	40
Repeating a specific segment.....	40
Repeating a title, chapter or track.....	41
Playing in a favorite order	42
Zooming a picture	43

Changing the camera angle.....	44
Selecting subtitles.....	44
Selecting a playback sound.....	45
Playing audio/video/picture files.....	46
Selecting the sound enhancement	50
Adjusting the picture.....	50
On-screen Display mode	51

Function Settings

Customizing the function settings.....	54
--	----

Connections

Viewing on a connected TV	62
Viewing pictures from connected video equipment.....	63
Connecting to audio equipment.....	64
Connecting to an AV amplifier (via digital audio input).....	64
Connecting to an audio system equipped with analog audio inputs.....	65

Using the automobile/vehicle adapter or power port.....	66
--	----

Others

Output sound conversion table.....	70
Before calling service personnel	71
Specifications	73

Identification of Controls

Instructions and actual buttons

Most instructions are based on remote control operation, unless otherwise noted. You can use the buttons on the remote control and those on the main unit as well when they have the same function. Some functions are available only from the remote control.

Main Unit

See page in  for details.

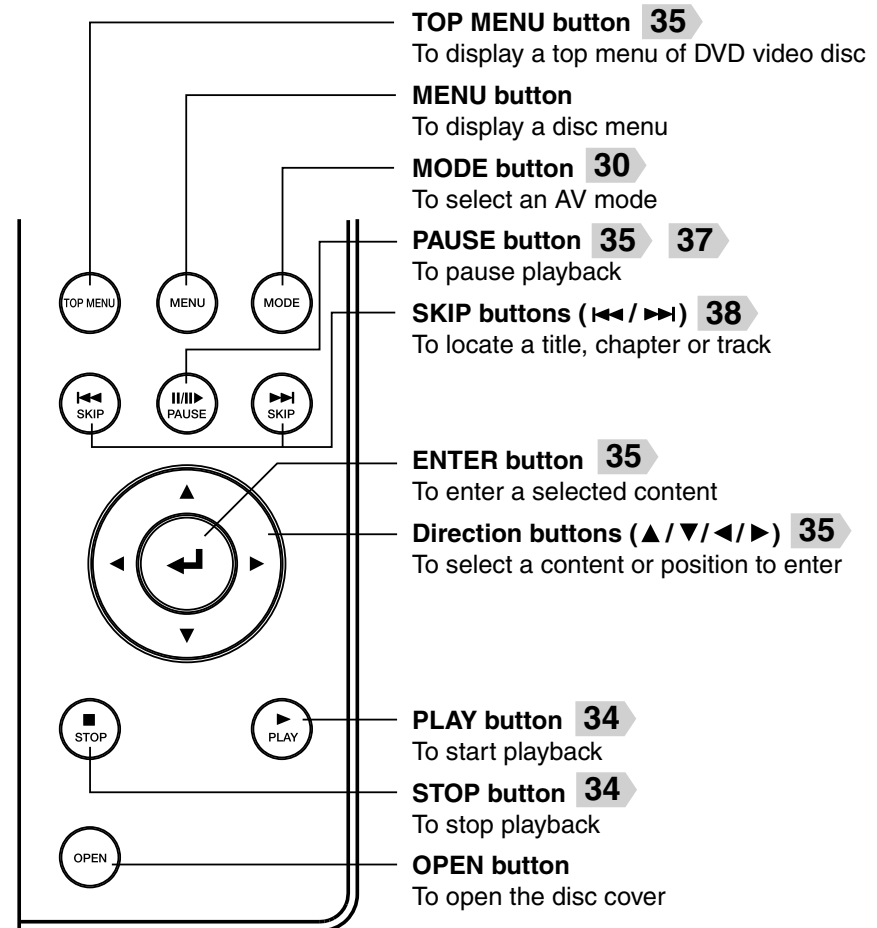
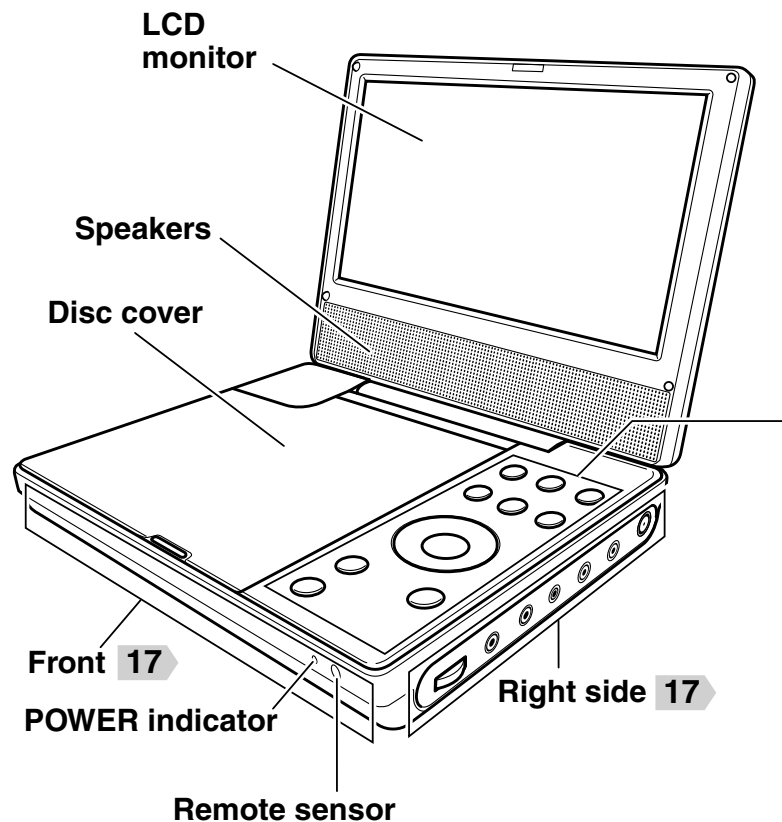

Right side

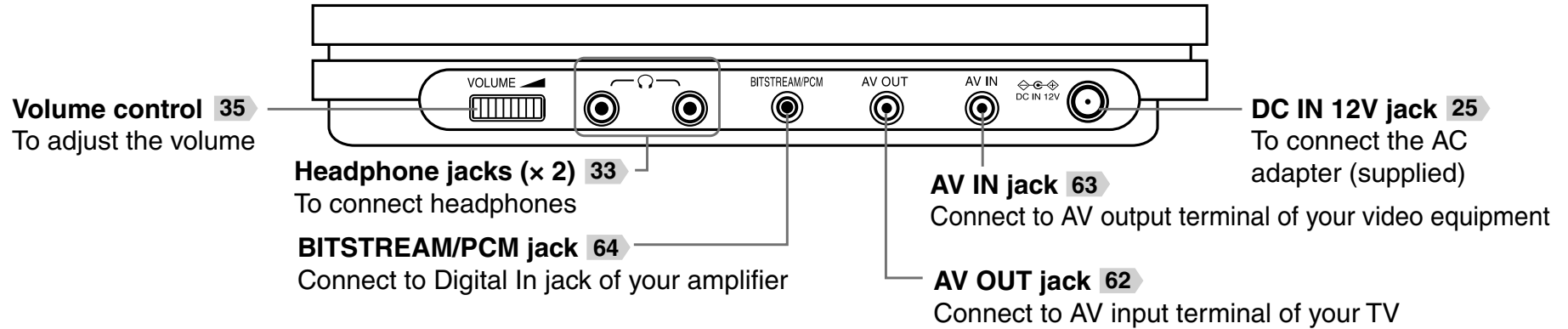

Left side

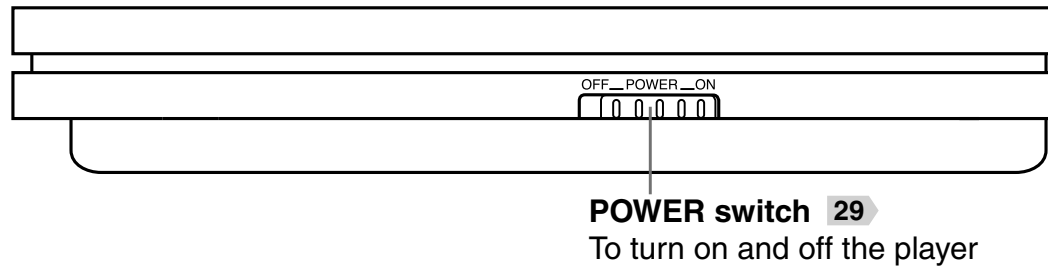

Front

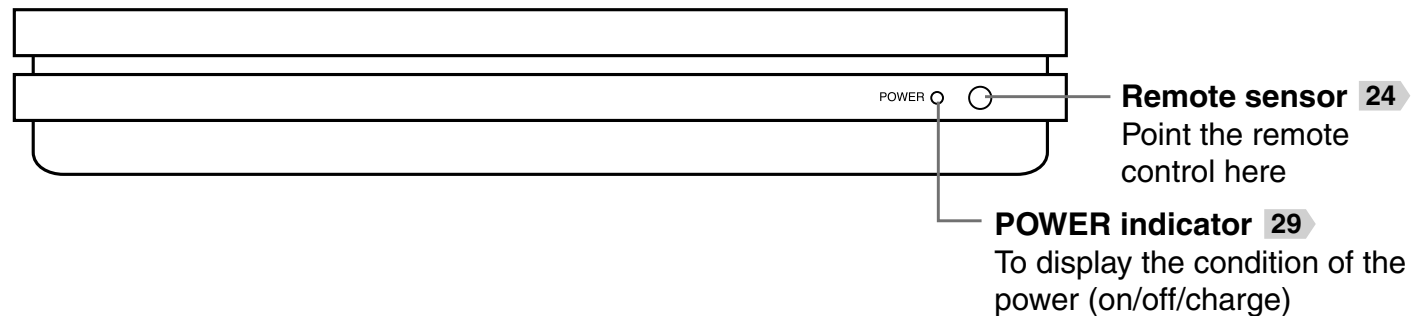

Identification of Controls (continued)

Remote control See page in  for details.

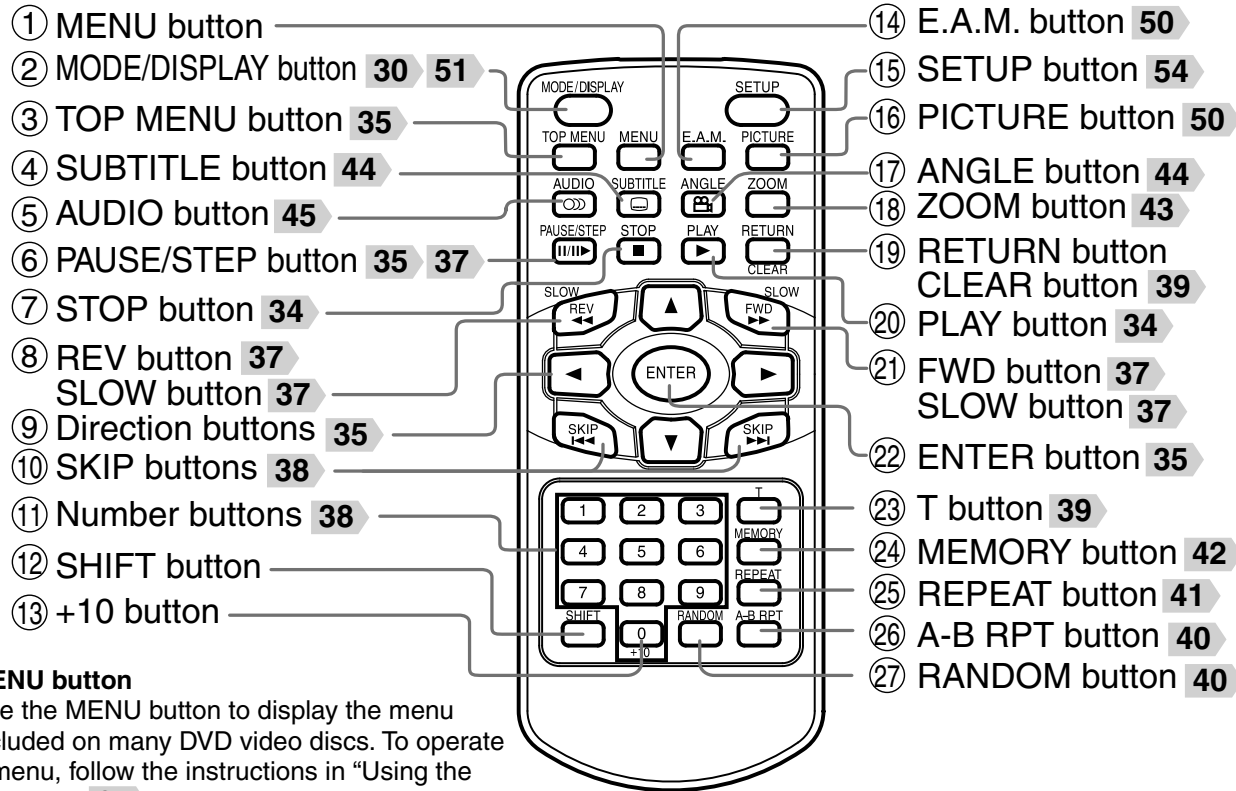

MENU button

Use the MENU button to display the menu included on many DVD video discs. To operate a menu, follow the instructions in "Using the top menu" **35**.

	Function
① MENU	To display a disc menu
② MODE	To select an AV mode
② DISPLAY	To display operation information
③ TOP MENU	To display a top menu
④ SUBTITLE	To select subtitles
⑤ AUDIO	To select the sound
⑥ PAUSE/STEP	To pause playback
⑦ STOP	To stop playback



	Function
⑧ REV	Fast reverse playback
⑧ SLOW	Slow motion playback
⑨ Direction buttons	To select a content or position to enter
⑩ SKIP	To locate a title, chapter or track
⑪ Number buttons	To enter numbers
⑫ SHIFT	To change functions
⑬ +10 button	To enter numbers for ten places

	Function
⑭ E.A.M.	To select the sound enhancement
⑮ SETUP	To display the setup menu
⑯ PICTURE	To adjust a picture quality or size
⑰ ANGLE	To select a camera angle
⑱ ZOOM	To zoom a picture
⑲ RETURN	Return to previous screen
⑲ CLEAR	To clear entered information
⑳ PLAY	To start playback
㉑ FWD	Fast forward playback
㉑ SLOW	Slow motion playback
㉒ ENTER	To enter a selected content
㉓ T	To display a preferred scene
㉔ MEMORY	To play in a favorite order
㉕ REPEAT	Repeat play
㉖ A-B RPT	Repeat play a specific segment
㉗ RANDOM	To play in random order

 : Operate these buttons while simultaneously pressing the SHIFT button.

Accessories

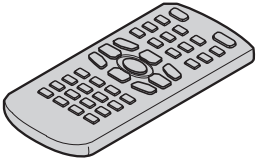
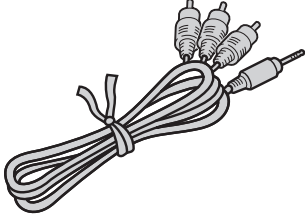
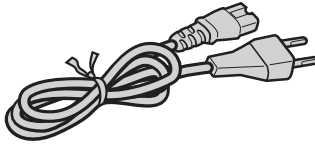
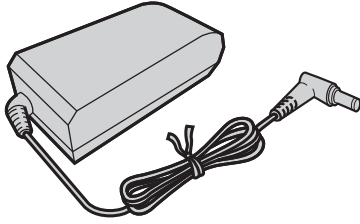
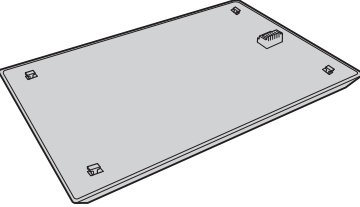

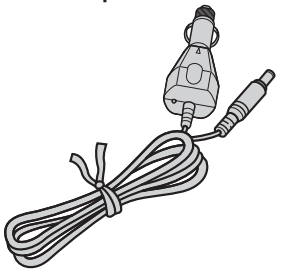
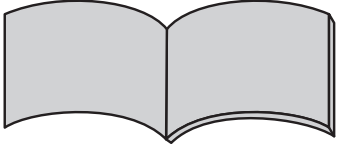



Check that the following accessories are supplied.

<p>Remote control (MEDR16UX) Coin-shaped battery (CR2025)</p> 	<p>Audio/video cable</p> 	<p>Power cord*</p> 	<p>AC adapter (ADPV16A)*</p> 
<p>Battery pack* (SD-PBP90R)</p> 	<p>Headphones</p> 	<p>Carrying case Use this for carrying, etc. of the player.</p> 	<p>Vehicle adapter*</p> 
<p>Owner's manual</p> 	<p>* Do not use an AC adapter, a power cord, a battery pack and a vehicle adapter other than one specified. Also, do not use these supplied accessories with any device other than this player.</p>		

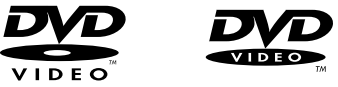
Notes and Information

Playable discs

This player can play the following discs.

Disc	Disc Mark	Disc Size	Contents
DVD Video disc		12cm/8cm	•Video(moving pictures)+Audio
DVD-RW		12cm	•Video+Audio(DVD VR(Video Recording) format)* •Video+Audio(DVD Video format)* *Finalized discs only.
DVD-R		12cm	•Video+Audio(DVD Video format)* *Finalized discs only.
Video CDs		12cm/8cm	•Video(moving pictures)+Audio
Audio CDs		12cm/ 8cm(CD single)	•Audio
CD-ROM		12cm	•Audio (MP3/WMA files) •Movie(DivX) •Photograph(JPEG files)
CD-R/RW		12cm	•Audio (CD-DA, MP3/WMA files) •Movie(DivX) •Photograph(JPEG files) *CD-R/RW discs of VIDEO CD format can also be played. Some of these discs may be incompatible.

 is a trademark of DVD Format/Logo Licensing Corporation.

Notes

- You cannot play discs other than those listed left.
- You cannot play discs of DVD-RAM or non-standardized discs, etc., even if they may be labeled as left.
- This player uses the PAL/NTSC colour system, and cannot play DVD video discs recorded in any other colour system (SECAM, etc.).
- Depending on the data recording method or the disc status, playback on this player may not be possible, even if the disc is labeled as left. Toshiba cannot assure that all discs bearing the DVD or CD logos will operate as expected.
- Because of problems and errors that can occur during the creation of DVD and CD software and/or the manufacture of DVD and CD discs, Toshiba cannot assure that this player will successfully play every disc bearing the DVD and CD logos. If you happen to experience any difficulty playing a DVD and/or CD disc on this player, please contact Toshiba Customer Service.

■ On VIDEO CDs

This player supports VIDEO CDs equipped with the PBC (Version 2.0) function. (PBC is an abbreviation for Playback Control.)

You can enjoy two playback variations depending on types of discs.

- VIDEO CD not equipped with PBC function (Version 1.1)
Sound and movie can be played on this player in the same way as an audio CD.
- VIDEO CD equipped with PBC function (Version 2.0)
In addition to operation of a VIDEO CD not equipped with the PBC function, you can enjoy playback of interactive software with search function by using the menu displayed on the screen (Menu Playback). Some functions described in this owner's manual may not work with all discs.

Notes and Information (continued)

On handling discs

- Do not touch the playback side of the disc.

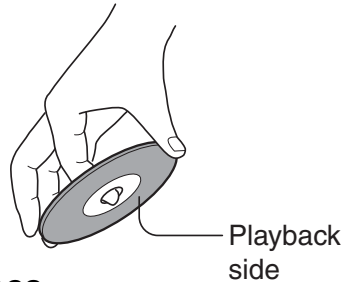

- Do not attach paper or tape to discs.

On cleaning discs

- Fingerprints and dust on the disc may cause picture and sound deterioration. Wipe the disc from the center outwards with a soft cloth. Always keep the disc clean.
- Do not use any type of solvent such as thinner, benzine, commercially available cleaners or antistatic spray for vinyl LPs. It may damage the disc.

On storing discs

- Do not store discs in a place subject to direct sunlight or near heat sources.
- Do not store discs in places subject to moisture and dust such as a bathroom or near a humidifier.

- Store discs vertically in a case. Stacking or placing objects on discs outside of their case may cause warping.

Notes on copyright

The unauthorized recording, use, distribution, or revision of copyrighted materials including, without limitation, television programs, videotapes, and DVDs, is prohibited under the Copyright Laws of the United States and other countries, and may subject you to civil and criminal liability.

This product incorporates copyright protection technology that is protected by method claims of certain U.S. patents and other intellectual property rights owned by Macrovision Corporation and other rights owners.

Use of this copyright protection technology must be authorized by Macrovision Corporation, and is intended for home and other limited viewing uses only unless otherwise authorized by Macrovision Corporation.

Reverse engineering or disassembly is prohibited.

Preparations

Preparations before using.

Preparation of the remote control

Power connection

Using the battery pack

Powering on/off

Changing the AV mode

Preparation of the remote control

Insert the specified battery to the remote control. See page 8, 9 for safety use of coin-shaped batteries.

- 1 Gently insert a fingernail in groove ① and pull out the holder in direction ②.

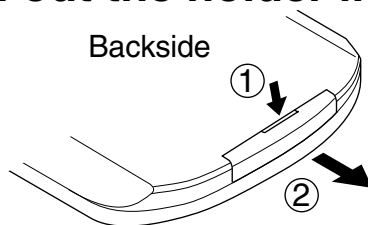

Take care not to break your fingernail.

- 2 Place a coin-shaped battery (CR2025) with the + side up on the holder.

Keep the holder horizontal so that the battery does not fall through.

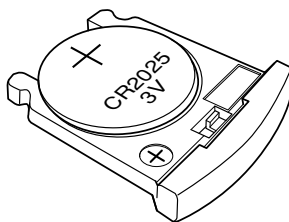

CAUTION: Danger of explosion if battery is incorrectly replaced. Replace only with the same or equivalent type.

- 3 Insert the holder into the remote control.

The remote control battery contains Perchlorate Material - special handling may apply.

<http://en.wikipedia.org/wiki/perchlorate>

Operating with the remote control

Point the remote control at the remote sensor and press the buttons.

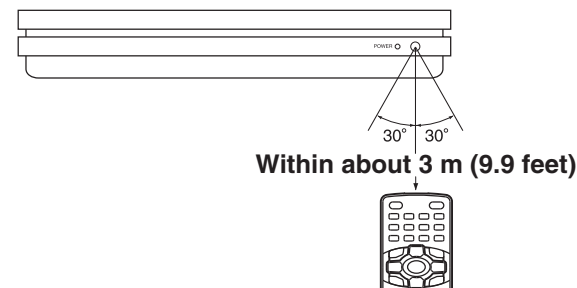

Distance: About 3 m (9.9 feet) from the front of the remote sensor

Angle: About 30° in each direction of the front of the remote sensor

Do not expose the remote sensor of the player to a strong light source such as direct sunlight or other illumination. If you do so, you may not be able to operate the player via the remote control.

- Aim the remote control at the remote sensor of the player.
- Do not drop or give the remote control a shock.
- Do not leave the remote control near an extremely hot or humid place.
- Do not spill water or put anything wet on the remote control.
- Do not disassemble the remote control.
- If the remote control does not function correctly or if the operating range becomes reduced, replace the battery with new one.
- Inserting a battery other than the specified one or an object may damage the remote control.

Power connection

Connect the supplied AC adapter to wall outlet as below.

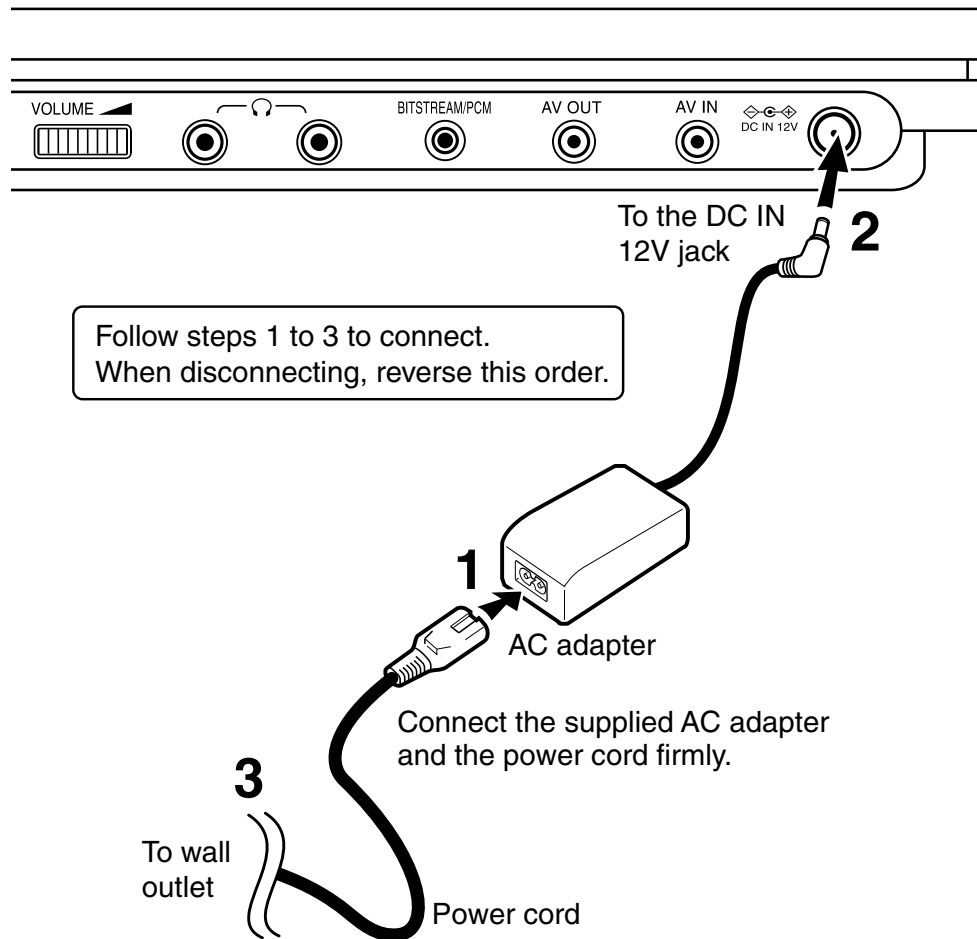

CAUTION

- Do not connect the power plug to a power outlet other than that indicated on the label, as this can result in a risk of fire or electric shock.
- Do not connect or disconnect the power plug with wet hands. Doing so may cause electric shock.
- Do not use an AC adapter other than one specified, as it can cause a fire or damage to the player.
- When the AC adapter is in use, its temperature may increase. However, it is not a malfunction. Make sure that the power cord is disconnected and the temperature decreases before carrying it.

Note

- Do not use the supplied AC adapter with any device other than this player.

Using the battery pack

The supplied battery pack can power the player for operation outdoors or in a place with no outlets.

WARNING

- Do not use a battery pack other than one specified as it can result in a fire or damage to the unit.
- Do not heat, open, or short-circuit the battery pack. Do not throw the battery pack into a fire. Doing so may cause an explosion or a fire.
- Attach the battery pack properly following the explanation below. Make sure that the battery pack is attached firmly to the player when using it. Otherwise, the battery pack may become detached and cause personal injury.

Attaching the battery pack

- 1 Turn the player off.
- 2 Disconnect all cables and cords from the player.
- 3 Turn the player upside down.

- 4 **Open the connector cover on the bottom of the player.**

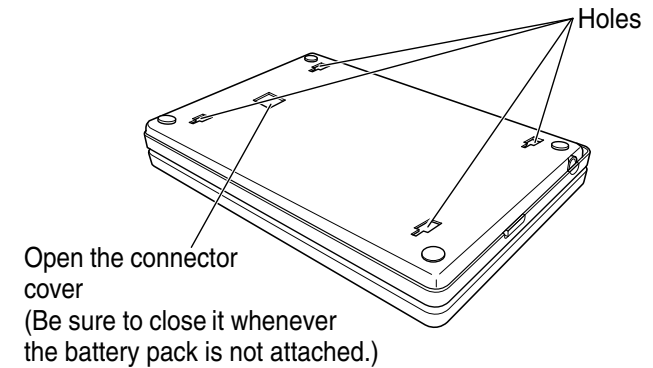

- 5 **Turn the battery pack over and insert four catches into the player's corresponding holes** ①.
Then, slide the battery pack in the direction of the arrow ② **until a “click” is heard.**

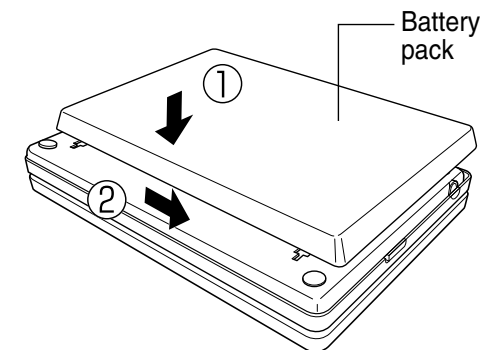

Important

- Detach the battery pack from the player after being used.

Charging the battery pack

The battery pack needs to be charged before use. (The battery indicator is shown in the upper left corner of the screen when the power in the battery pack is running low.) Perform a full charge before the first use.

- 1 Attach the battery pack to the player.**
- 2 Connect the supplied AC adapter and the power cord to the player.**

Charging starts, and the POWER indicator illuminates in orange.
When the charging is completed, the POWER indicator turns off.

Notes

- Charge the battery pack with a surrounding temperature of +10°C to +30°C (+50°F to +86°F).
- While the charge is in progress, do not disconnect the AC adapter and the power cord until the POWER indicator turns off.
- The attached battery pack may get warm when you are charging it or operating the player. This is not a defect.

Charging time of a battery pack	Approximately 5 hours (When the player is turned off.)
---------------------------------	---

- The battery pack can be charged when the player is turned on or off.
- This value is for reference only. Charging time may vary depending on battery pack status and environment.

Continuous playback time while using the battery pack	Up to approximately 5 hours
---	-----------------------------

- This value is for reference purpose only, it is not guaranteed. (Conditions: 25°C, output from the headphones, new battery pack in use.)
- Continuous playback time may vary depending on battery pack status, operational status and environment conditions.
- Low temperature will shorten the playback time.

Detaching the battery pack

- 1 Turn the player off.
- 2 Disconnect the AC adapter and the power cord from the player.
- 3 Turn the player upside down.
- 4 Slide the battery pack's lock switch in the direction of the arrow ①, then slide the battery pack in the direction of the arrow ② to remove it.

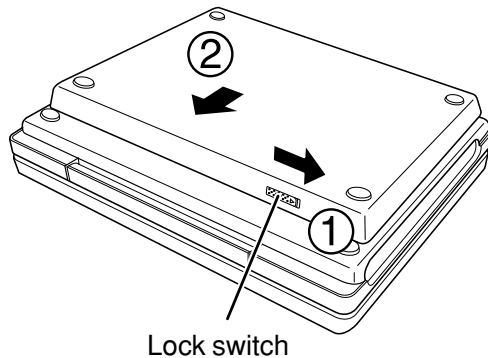

- 5 Close the connector cover on the bottom of the player.

Important

- After detaching the battery pack, be sure to close the battery cover in order to avoid a short-circuiting which may be caused by contact with metal objects to the connector.
- Do not detach the battery pack while the POWER indicator illuminates in green or orange.



About battery pack life

Battery pack has a limited service life. The length of service life varies depending on product use and user settings. If you use the battery pack beyond its service life, you may notice that playback time becomes remarkably shorter, even if the battery pack is fully charged. If you notice that playback time has become remarkably shorter, even when the battery pack is fully charged, it is recommended that you replace the battery pack with battery pack model number SD-PBP90R.

Powering on/off

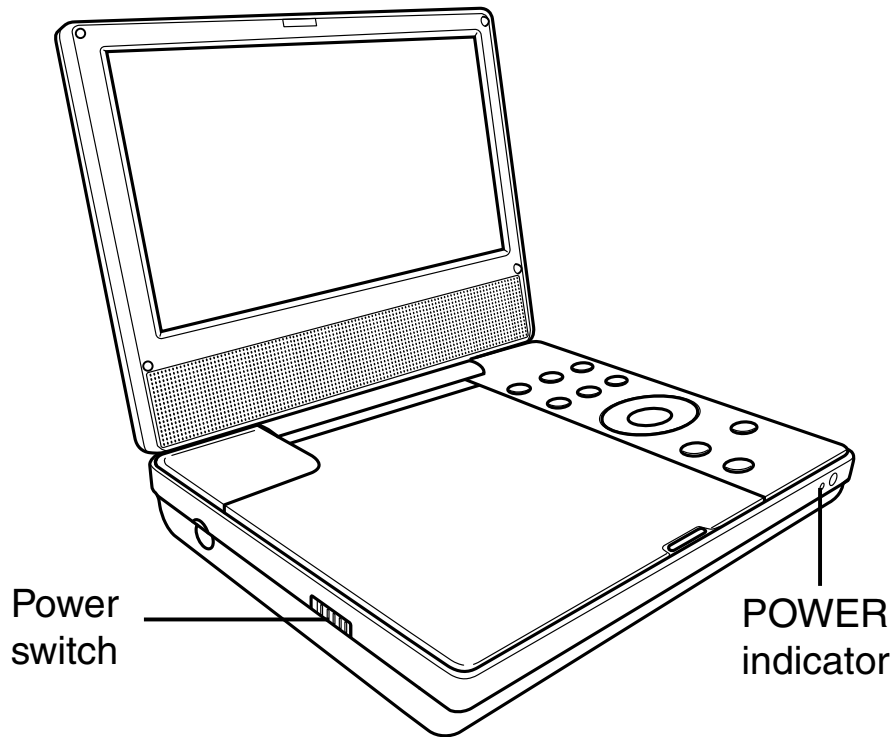
Slide the power switch to turn the power on or off.

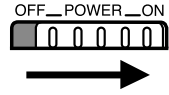
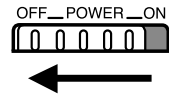

Condition	Power Switch	POWER indicator
On		Green
Off		Off
Charging		Orange

Changing the AV mode

You can enjoy various pictures of discs or connected equipments by changing the AV mode. Change it depending on your needs.

Press MODE repeatedly to select the AV mode.

Each time you press MODE, the AV mode changes on the screen as below.



(Normal)

Select when you want to view the picture of a disc on the LCD monitor of this player.

- Make sure that ● (Normal) is selected when you play a disc. Cannot be played any discs other than normal mode.



(AV in)

Select when you want to view the picture played using a VTR or other external equipment on the LCD monitor of this player.



(Back to ● (Normal))

Playback

Play your favorite disc.

Loading a disc

Connecting to headphones

Playing a disc

Changing a playback speed

Playing a desired scene

Playing in random order

Playing repeatedly

Playing in a favorite order

Zooming a picture

Changing the camera angle

Selecting subtitles

Selecting a playback sound

Playing audio/video/picture files

**Selecting the sound
enhancement**

Adjusting the picture

On-screen Display mode

Loading a disc

For disc compatibility information, see page 20 .

1 Open the LCD monitor.

No open buttons to open.
The LCD monitor is fixed by magnet.

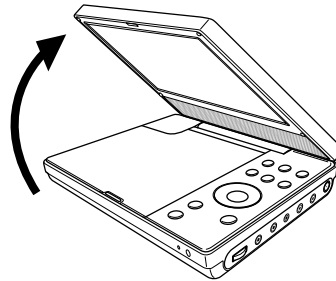

2 Press OPEN on the main unit.

The disc cover opens.

Before using the player for the first time, remove the protective sheet beneath the disc cover.

3 Set a disc.

Place a disc with the playback side down, and push gently on the center of the disc to affix it to the spindle.

The player will be unable to recognize or correctly play the disc if it is not affixed to the spindle properly.

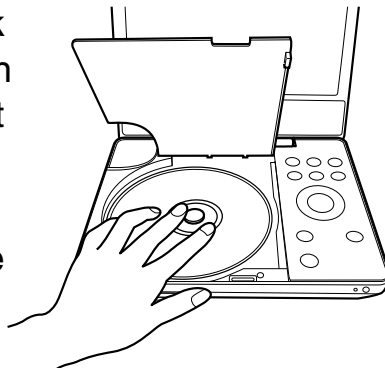

4 Close the disc cover.

Press the edge around "CLOSE".

To remove the disc

Press **OPEN** on the main unit to open the disc cover and remove the disc from under the rim while gently pressing down on its center.

Connecting to headphones

CAUTION

- Keep your fingers clear of the disc as it is spinning. Neglecting to may cause serious personal injury.
- Be careful not to catch your fingers in the disc holder.
- Do not use a cracked, deformed, or repaired disc.
- Do not tilt, shake or move the main unit while playing. It may damage the disc.
- Do not put any discs or any objects in the disc holder other than those disc types listed on page 20.
- Do not touch the spindle immediately after prolonged play, as it may have become hot. Be careful in loading/removing a disc.

You can connect headphones to the headphone jack using a stereo mini plug.

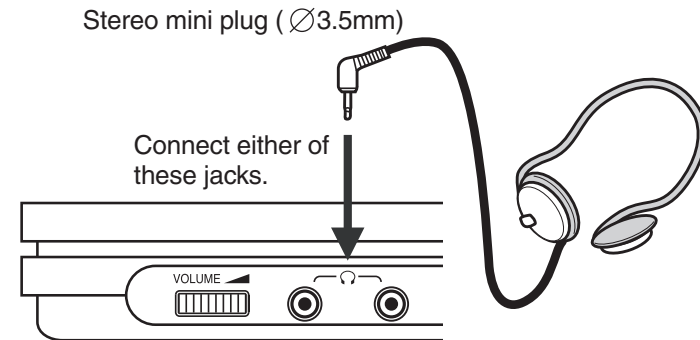

- Before connecting, temporarily turn down the volume with the headphone volume control. Readjust to your preference when playback starts.
- Turn off the player before you connect or disconnect the headphone cable. Possible shakes produced by plug connecting/disconnecting may cause damage to the disc.
- You can connect up to 2 headphones.

CAUTION

When you use headphones, keep the volume at a moderate level. If you use the headphones continuously with high volume sound, it may cause hearing damage.

Playing a disc

DVD-V

VCD

CD

Preparations

- Turn on the power of the player.
- Place a disc to the player.

Caution

Never operate the player in a moving vehicle.
Vibration may prevent proper playback of the player or cause damage to the disc.

1 Press **MODE** repeatedly to select  (Normal).

2 Press **PLAY**.

Playback starts.

- If you select a DVD video disc that contains a top menu, or select a PBC (Playback Control)-featured VIDEO CD, a menu may appear. See “Using the top menu” **35**.
- You may need to press the TOP MENU or MENU button to display the disc menu (depending on the actual DVD video disc.)
- When you play an audio CD, “menu” screen appears. See “Playing audio/video/picture files” about the operation.

3 Press **STOP** to stop playback.

About Resume playback function

The player memorizes the location where playback is stopped and resumes playback from the location where you stopped.

If you press PLAY after stopping playback, playback starts from the location where you stopped.

- The player memorizes the information for resume playback up to 5 discs. The oldest memory is deleted if 6th disc is inserted.
- If you want to return to the beginning of a DVD video disc, press STOP twice.

Notes

- The player’s memory is cleared when you use a PBC-featured VIDEO CD while “PBC” is set to “On”. (Refer to “Function Settings”.)
- There may be a difference in the location where playback resumes depending on the disc.

Pausing playback (Still mode)

Press **PAUSE/STEP** during playback.

The picture gets still and sound is muted.

To resume normal playback, press **PLAY**.

Adjusting the volume of the speakers or the connected headphones

Right: Increase volume.

Left: Decrease volume.

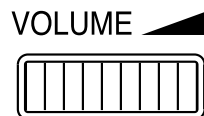

Note

- In many instances, a menu screen will appear after playback of a movie is completed. If you have connected the DVD player to a television, and depending on the type of television that you have, prolonged display of an on-screen menu may result in the on-screen menu becoming permanently ingrained in the screen. This type of damage is not covered by your Toshiba Warranty. To avoid this, be sure to press the **STOP** button once the movie is completed.

Using the top menu

DVD-V **VCD** **CD**

1 Press **TOP MENU**.

The top menu appears.

2 Press **▲ / ▼ / ◀ / ▶** to select the title you want.

If the titles in the top menu are assigned a number, you can select the title by pressing number buttons.

3 Press **ENTER**.

Playback starts from chapter 1 of the selected title.

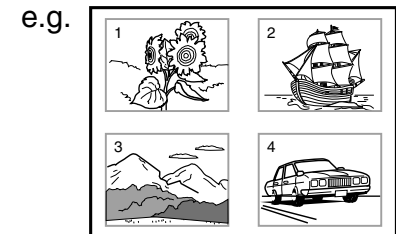

Notes

- This method of locating a title is available only on a disc that contains a top menu.
- Instruction notes of discs may refer to the button that displays the top menu as **TITLE** button.
- The instructions above describe basic procedures which may vary depending on the contents of the DVD video disc. If different instructions appear on the screen, follow those instructions.

About the screen saver

If 20 minutes elapse while the power is on and there is no disc in the player or while the disc is stopped, the screen saver is automatically displayed (when “Screen saver” (refer to “Function Settings”) is set to “On”). To turn off the screen saver, press any button on the main unit or remote control.

Automatic power off function

If the player is stopped or the screen saver is engaged for approximately 20 minutes, the LCD power automatically turned off. To turn on the LCD monitor, slide the power switch to off once and then turn the power on again.

About the LCD

- The LCD panel contained in this product is manufactured using an extremely high level of precision technology; however, there may be an occasional pixel (dot of light) that does not operate properly (does not light, remains constantly lit, etc.). This is a structural property of LCD technology, is not a sign of malfunction, and is not covered under your warranty. Such pixels are not visible when the picture is viewed from a normal viewing distance.
- The brightness of the LCD monitor differs slightly depending on the viewing angles. Adjust the LCD monitor angle to obtain the best viewing. (The recommended viewing angle is 90 degrees to the monitor.)

Changing a playback speed

Playing in fast reverse or fast forward

DVD-V **VCD** **CD**

Press **REV** or **FWD** on the remote control during playback.

◀◀: Fast reverse playback

▶▶: Fast forward playback

Each time you press the REV or FWD button, the playback speed changes.

Press **PLAY** to resume normal playback.

- Also, playback changes to fast reverse or fast forward when you press and hold SKIP on the main unit.

Notes

- The player mutes sound and omits subtitles during reverse and forward scan of DVD video discs.
- The playback speed may differ depending on the disc.
- This equipment supports playback of DVD-RW (VR mode) discs. However, playback or fast-forward/rewind may not function properly depending how the disc was created, the status of titles on the disc or the condition of the disc itself.

Playing frame by frame

DVD-V **VCD** **CD**

Press **PAUSE/STEP** repeatedly during playback.

The sound is muted during frame by frame playback.

Press **PLAY** to resume normal playback.

Playing in slow-motion

DVD-V **VCD** **CD**

Press **SLOW** (◀◀ / ▶▶) while pressing **SHIFT** during playback.

If you press the **SLOW** (◀◀) during playback, you can view the picture in reverse slow-motion. (Only when using a DVD video disc.)

Each time you press the **SLOW** (◀◀ / ▶▶) button, the slow-motion speed changes.

The sound is muted during slow-motion playback.

Press **PLAY** to resume normal playback.

Note

- The playback speed may differ depending on the disc.

Playing a desired scene

DVD-V VCD CD

Skipping chapters or tracks

1 Press SKIP (I◀◀ / ▶▶I) repeatedly to locate the chapter or track you want.

Playback starts from the selected chapter or track.

▶▶I : Playback starts from the beginning of the next chapter or track.

I◀◀ : Playback starts from the beginning of the current chapter or track.

When you press twice, playback starts from the beginning of the preceding chapter or track.

Locating by entering numbers

1 Press T several times to display “Search”.

The display changes each time this button is pressed.

e.g. DVD-V

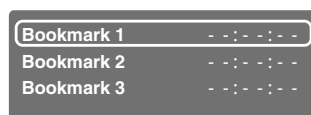
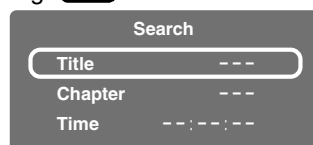

Off

2 Press ▲ / ▼ to select the category you want to search.

Category	To search by specifying:
Title*	Title number
Chapter*	Chapter number
Time	Elapsed time of the current track
Disc Time	Elapsed time in the entire disc

*: Not available in CD playback.

3 Press the number buttons to enter a number.

• e.g. To enter 25:

2 → 5

• e.g. To enter the time 1 hour 25 minutes 30 seconds:

1 → 2 → 5 → 3 → 0

4 Press PLAY or ENTER.

Playback starts from the selected section.

Notes

- Press the CLEAR button while pressing the SHIFT button resets the numbers.
- Some discs may not respond to this process.
- Some scenes may not be located precisely as you specified.

Marking the desired position to locate (Bookmark function)

First register a bookmark referring to “To register a bookmark” of the next paragraph, then operate these steps below.

1 During playback, press T repeatedly to display “Bookmark”.

The display changes each time this button is pressed.

e.g. DVD-V

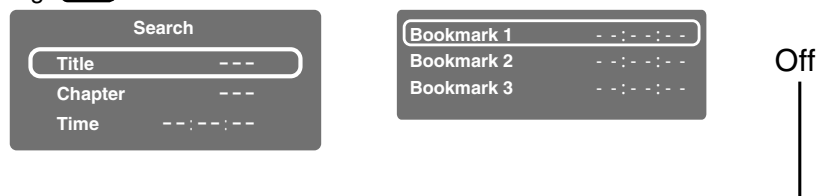

2 Press ▲ / ▼ to select a number (1, 2, 3) of “Bookmark”, then press ENTER.

Playback starts from the selected point.

To register a bookmark

You can register up to 3 bookmarks.

- 1 At a scene where you want to register a bookmark, press **PAUSE/STEP** to pause.
- 2 Press **T** repeatedly to display “Bookmark”.
- 3 Press **▲ / ▼** to select a number (1, 2, 3) of “Bookmark”, then press **ENTER**.

Select a vacant (“-- : -- : --”) number.

To cancel the procedure, press **T** to turn the display off.

To cancel your entry, press **CLEAR** while pressing **SHIFT** to erase the digits to return to “-- : -- : --”.

- 4 Press **ENTER**.

The scene is registered to the bookmark. (A registered bookmark information is cleared if another disc is inserted or the power of the player is turned off.)

Note

- Bookmarks may not be able to be registered for some discs or scenes.

Playing in random order

DVD-V VCD CD

1 During playback, press **RANDOM** to display “Shuffle on” on the screen.

Each time you press the button, the random mode “Shuffle on” and “Shuffle Off” alternate.

The mode on the screen will disappear in a few seconds if not operated.

If you display “Shuffle on”, random playback starts after finishing the current chapter or track.

To resume normal playback

Press **RANDOM** repeatedly until “Shuffle Off” appears.

Notes

- Some discs may not permit random playback.
- The random mode will be canceled when you:
 - turn off the power.
 - open the disc cover.
- If you press **STOP** twice, the random mode ends and playback stops.

Playing repeatedly

DVD-V VCD CD

Repeating a specific segment

1 Press **A-B RPT** at the beginning of the segment (point A) you want to play repeatedly.

“Rep A-” appears.

2 Press **A-B RPT** again at the end of the segment (point B).

“RepA-B” appears and the player automatically returns to point A and starts playback of the selected segment (A-B).

To resume normal playback

Press **A-B RPT** repeatedly until “Rep AB off” appears.

Notes

- If you press **STOP** twice, the A-B repeat function ends and playback stops.
- You can specify a segment only within the current title or track.
- There may be a slight difference between point A and the location where playback starts actually resumes depending on the disc.
- Functions other than **STOP** and **A-B RPT** may not be available during A-B repeat playback.

Repeating a title, chapter or track

1 During playback, press REPEAT repeatedly to select the repeat mode.

Each time you press the button, the repeat mode changes on the screen.

Repeat playback starts after finishing the current chapter or track.

Disc	Mode	Repeating range
DVD-V	Repeat Chapter	Current chapter
DVD-V	Repeat Title	Current title
VCD CD	Repeat Single	Current track
VCD CD	Repeat All	Whole disc
DVD-V VCD CD	Repeat Off	Returns to normal playback.

Notes

- Some discs may not permit repeat playback.
- The repeat mode will be canceled when you:
 - turn off the power.
 - open the disc cover.
- If you press STOP twice, the repeat mode ends and playback stops.

Playing in a favorite order

DVD-V

VCD

CD

1 During stop, press MEMORY.

The programming display appears.

e.g. DVD-V

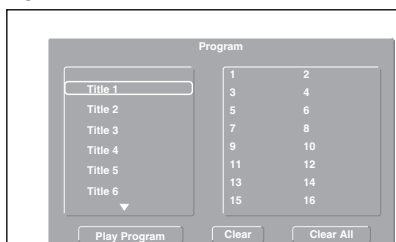

Enter a track number when using a video CD.

3 Press ► to select “Play Program” then press ENTER.

The player starts memory playback.

To cancel the programmed selections

- Select “Clear” on the screen and press **ENTER** to clear the programmed selection.
- Select “Clear All” on the screen and press **ENTER**. All of the programmed selections are cleared.

To stop memory playback

Press **STOP** twice.

(The programmed selection is cleared.)

Notes

- Some discs may not permit memory playback operation.
- The programmed selection will be cleared when you:
 - turn off the power.
 - open the disc cover.
- Memory playback pauses if you press MEMORY while being executed.

2 Setting the title, chapter or track in the order you wish to play.

- 1) Select the number of title you want to set using ▲ / ▼ then press **ENTER**.
 - 2) Select the number of chapter you want to set using ▲ / ▼ then press **ENTER**.
 - 3) Setting another memory, select [...] then press **ENTER**. After that the programming display appears.
Follow steps 1 to 2 for the setting.
- Some discs may not exist chapter or track number. If so chapter or track number cannot be entered.

Zooming a picture

DVD-V

VCD

CD

1 Press ZOOM during playback.

The zoom icon appears.

This operation is available also during slow, still, fast forward or fast reverse playback.



2 Select the zoom point and magnification level.

- **Magnification level:**
Press ZOOM repeatedly.

The magnification level changes as follows:

“Q X2” (Twice the size)

“Q X3” (Three times the size)

“Q X4” (Four times the size)

“OFF” (Normal size)

Zoom point:

Press ▲ / ▼ / ◀ / ▶ repeatedly.

To resume normal playback

Press **ZOOM** repeatedly until “OFF” appears.

Notes

- Some discs may not respond to zoom feature.
- Depending on scenes, the buttons may not work as described.
- Zooming does not work on characters selected on menus.
- Zoom playback will be canceled when you:
 - turn off the power.
 - open the disc cover.

Changing the camera angle

DVD-V

VCD

CD

1 Press ANGLE while playing a scene recorded with multiple camera angles.

The angle icon (📹) appears on the screen.

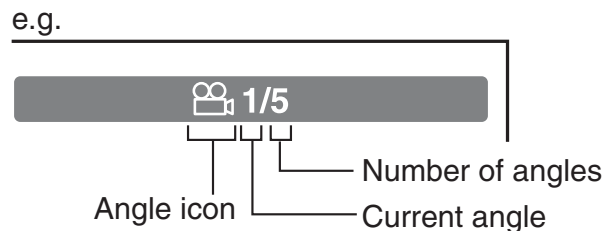

This display does not appear if the disc includes no scenes recorded with multiple angles.

If you press ANGLE while playing a scene not recorded with multiple angles, the angle selection is not possible.

2 Press ANGLE to select the camera angle.

Each time you press the button, the camera angle changes.

Notes

- After selecting angle, it will take a few moments to change the camera angle of the scene you are viewing.
- If you pause a picture immediately after changing a camera angle, the resumed playback picture may not display the new camera angle.

Selecting subtitles

DVD-V

VCD

CD

1 Press SUBTITLE during playback.

The current subtitle setting is displayed.

2 Press SUBTITLE while the subtitle setting is displayed on the screen.

Each time you press the SUBTITLE button, you can select a subtitle language from those included on the DVD video disc.

Notes

- When you select a subtitle language which is not included on the disc, the player plays a prior language programmed on the disc.
- Depending on scenes, the subtitles may not appear immediately after you change the subtitle language.
- Some discs may not include any subtitle languages.

To turn subtitles on or off

Press **SUBTITLE** several times during playback until "Off" is displayed.

Notes

- Some discs display subtitles automatically, and you cannot turn them off even if you set the subtitle function to off.
- Some discs will allow you to make subtitle selections and turn subtitles on or off only via the disc menu.

Selecting a playback sound

DVD-V

VCD

CD

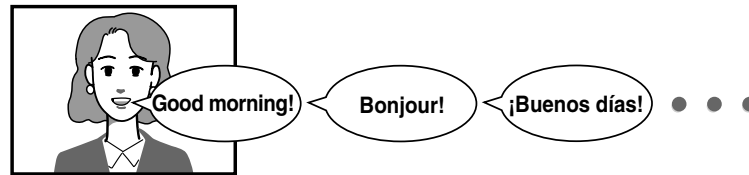

1 Press AUDIO during playback.

The current audio setting is displayed.

e.g.

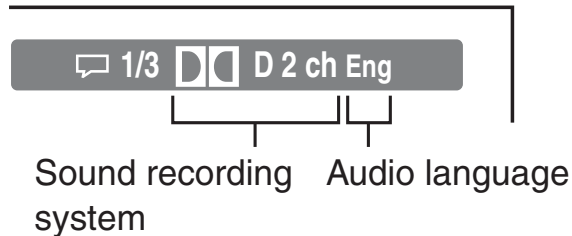

2 Press AUDIO while the audio setting is displayed on the screen.

Each time you press the button, you can select a preferred sound from those included on the DVD video disc.

Selecting sound channels of VIDEO CDs

During playback, press **AUDIO** repeatedly to select the sound channel.

Notes

- Some discs allow you to change audio selections only via the disc menu. In such a case, press MENU and choose the appropriate language from the selections on the disc menu.
- If you select a sound track which is not included on the disc, the player plays a prior sound track programmed on the disc.

Playing audio/video/picture files

DVD-V

VCD

CD

You can play audio CDs, MP3/WMA (audio), DivX[®] (video) or JPEG (picture) files on this player.

MP3/WMA or DivX[®] disc compatibility with this player

Playable discs	CD-ROM, CD-R, CD-RW, DVD-R
Sampling Frequency	32 kHz, 44.1 kHz, 48 kHz
Bit rate	MP3: 32 kbps - 320 kbps (CBR)
	WMA: 48 kbps - 192 kbps (CBR)
	DivX: Less than 8 Mbps
CD physical format	Mode 1
MP3 File system	ISO9660, UDF without interleave
DivX File system	ISO14496
MP3/WMA File name	File names are limited to eight characters or less and must incorporate "MP3" or "WMA" extension. e.g. "*****.MP3", "*****.WMA" File names cannot contain special characters such as "?!><+*}{[@];;¥ /.," etc. Less than 50 bytes
DivX File name	File names are limited to eight characters or less and must incorporate "DivX" extension. e.g. "*****.avi", "*****.Divx" File names cannot contain special characters such as "?!><+*}{[@];;¥ /.," etc. Less than 50 bytes
Total number of files	Less than 650
DivX codec version	3, 4, 5, 6 (Plays all versions of DivX [®] video (including DivX [®] 6) with standard playback of DivX [®] media files)
DivX resolution	720 x 576 (Less or equal)

This player requires discs/recordings to meet certain technical standards in order to achieve optimal playback quality. There are many different types of recordable disc formats (including CD-R containing MP3/WMA files). Not all recordable discs will operate or produce optimal playback quality. The technical criteria set forth in this owner's manual are meant only as a guide. Use of CD-RW for MP3 files is not recommended. You must obtain any required permission from copyright owners to download or use copyrighted content. Toshiba cannot and does not grant such permission.

JPEG disc compatibility with this player

Playable discs	CD-ROM, CD-R, CD-RW
File system	ISO9660, UDF without interleave
File name	File names are limited to eight characters or less and must incorporate "JPG" extension. e.g. "*****.JPG" File names cannot contain special characters such as "?!><+*}{[@];;¥ /.," etc.
Total number of files	Less than 650
File size	Unrestricted
File format	BASELINE, PROGRESSIVE
Resolution	Baseline JPG: 5760 x 4320 Progressive JPG 5760 x 4320

Microsoft, Windows Media, and the Windows Logo are either trademarks or registered trademarks of Microsoft Corporation in the United States and/or other countries.



DivX, DivX Certified, and associated logos are trademarks of DivX, Inc. and are used under license.

Note

- Some discs may not be played back due to its capacity and/or manufacturer, etc.

1 Insert a disc you want to play.

The menu appears.

e.g.

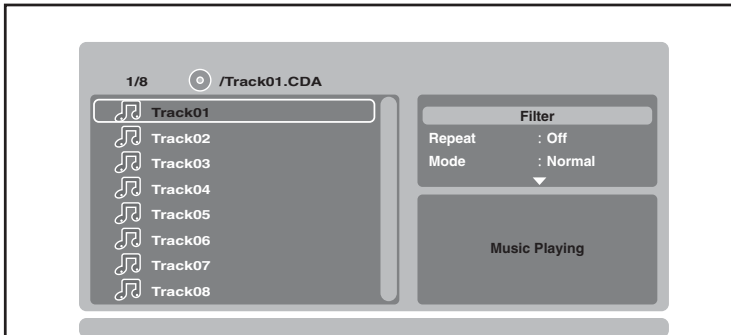

2 Select the track/file you want to play using ▲ / ▼ then press ENTER or PLAY.

Playback starts.

A slide show begins when playing JPEG file.

3 Press STOP to stop playback.

To select the category of file

1 Select “Filter” using ▲ / ▼ / ◀ / ▶ then press ENTER.

The screen appears as below.



2 Select the category using ▲ / ▼ / ◀ / ▶ then press ENTER.

The check mark (✓) appears next to the selected category.

Note

- When using a commercially available audio CD, this function cannot be used.

Playing audio/video/picture files (continued)

Playing repeatedly

Select “Repeat” on the screen using ▲ / ▼ / ◀ / ▶ during playback then press **ENTER**.

Each time you press ENTER, the repeat mode changes.

Off:	Resume to normal playback.
Single:	Repeats current track.
Folder:	Repeats current folder.

Notes

- Some discs may not permit playback.
- Some functions such as SKIP (◀◀ / ▶▶) can be operated from the remote control directly.

Notes of audio file playback

- WMA tracks copy-protected cannot be played.
- The BITSTREAM/PCM jack outputs MP3/WMA or DivX® sounds in the linear PCM format regardless of the current “Digital Out” selection. (Refer to “Function Settings”)

Playing in Random/Intro order

Select “Mode” on the screen using ▲ / ▼ / ◀ / ▶ during playback then press **ENTER**.

Each time you press ENTER, the playback mode changes.

Normal:	Resume to normal playback.
Shuffle on:	Plays in random order.
Music Intro:	Plays only music intro in order.

Playing in a favorite order

You can combine your favorite track/file and play in the order you determine.

- 1 Select “Edit mode” on the screen using ▲ / ▼ / ◀ / ▶ then press **ENTER**.
- 2 Position the cursor using ◀ to the screen displayed track/file.
- 3 Select track/file you want to play using ▲ / ▼ then press **ENTER**.

The check mark (✓) appears next to the selected track/file.

- 4 Select “Add to Program” using ▲ / ▼ / ◀ / ▶ then press **ENTER**.

The player memorizes the selected track/file.

- 5 Select “Program view” on the screen using ▲ / ▼ / ◀ / ▶ then press **ENTER**.

Programmed selections appear.

- 6 Press **PLAY**.

Playback starts in the order you programmed.

To display recorded track/file

Select “Browser view” on the screen then press **ENTER**.

The track/file list of the disc appears.

To cancel the programmed selections

- 1 Press **STOP** twice to stop playback.
- 2 Position the cursor using ◀ to the screen displayed track/file.
- 3 Select track/file you want to cancel then press **ENTER**.
The check mark (✓) appears next to the selected track/file.
- 4 Select “Clear Program” using ▲ / ▼ / ◀ / ▶ then press **ENTER**.

Program selections are cleared.

Note

- Some discs may not permit this function.

Selecting the sound enhancement

DVD-V VCD CD

1 Press E.A.M.*

The current sound enhancement setting appears.

* E.A.M. = Enhanced Audio Mode

2 Press E.A.M. repeatedly.

- [3D Off]
Normal sound.
- [3D On]
To obtain expansive virtual surround sound effects from just two speakers.

Notes

- Actual effects to sounds may vary depending on the speaker system. Make the selection to your preference.
- Actual effects to sounds may vary depending on the disc.

Adjusting the picture

DVD-V VCD CD

This function operates on the LCD of this player only. Cannot be effected on the screen of connected external equipment.

1 Press PICTURE.

The current picture setting appears.

2 Press PICTURE repeatedly to select the item.

Each time you press the button, the setup items changes as follows.

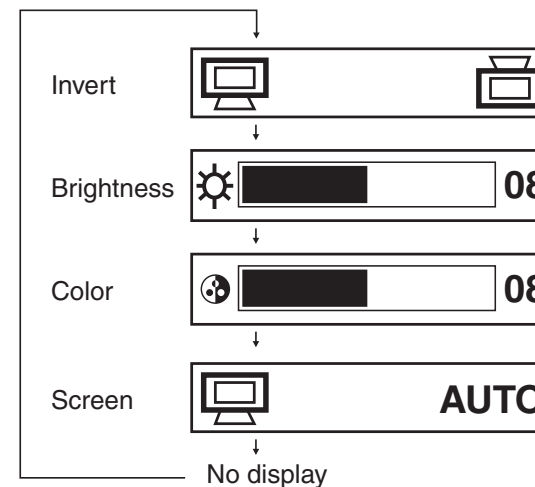

See the list of next page about items and set contents.

The setting screen will disappear in a few seconds if not operated.

On-screen Display mode

DVD-V

VCD

CD

3 Press ◀/▶ to adjust the value.

Invert	Invert the picture on the screen.
Brightness	0 (Darker) to 16 (Brighter)
Color	0 (Paler) to 16 (Deeper)
Screen	<p>4:3: The picture recorded on the DVD video disc will be played back in 4:3 picture format.</p> <p>16:9: 4:3 format picture will be played back in 16:9 picture format.</p> <p>AUTO: The picture will be played back in the format (4:3 or 16:9) recorded on the DVD video disc.</p>

1 Press DISPLAY while pressing SHIFT during playback.

The current instructional information appears.

e.g.: DVD video disc

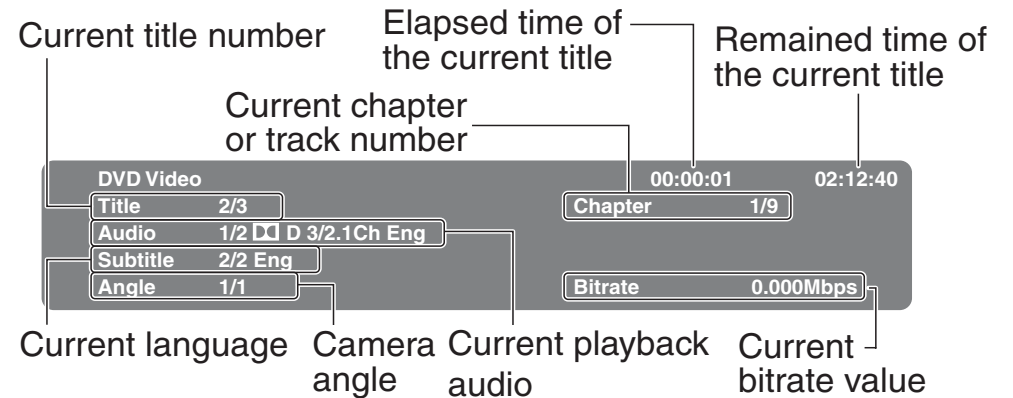

Playback

Press **DISPLAY** while pressing **SHIFT** to turn off the display.

Function Settings

You can change the default settings to customize performance to your preference.

Customizing the function settings

Customizing the function settings

DVD-V VCD CD

You can change the default settings to customize performance to your preference.

1 Press SETUP during stop.

The setting menu appears.

2 Press ▲ / ▼ to select the icon of the setting (listed below) to change, then press ►.

3 Press ▲ / ▼ to select the setting you want to change, then press ENTER.





4 Change the selection by ▲ / ▼ or other buttons, by referring to the corresponding pages 56, then press ENTER.

To change other settings, press ◀, then repeat steps 2 to 4.

5 Press SETUP.

The setting menu disappears, and the procedure finishes.

Icon	Setting	Disc	Details
	OSD Menu	DVD-V VCD CD	To select a preferred language for on-screen displays.
	Subtitle	DVD-V VCD CD	To select a preferred language for subtitles.
	Audio	DVD-V VCD CD	To select a preferred language for the sound track.
	DVD menu	DVD-V VCD CD	To select a preferred language for disc menus.
	DivX subtitle	—	To select the font for subtitles of the DivX file.

Video 	Aspect Ratio	DVD-V VCD CD	To select a picture size according to the aspect ratio of your TV, when connected to this player to monitor playback picture.
	View Mode	DVD-V VCD CD	To select a picture size of the LCD.
Audio 	E.A.M.	DVD-V VCD CD	You can easily switch to a preferred audio enhancement. (E.A.M. = Enhanced Audio Mode)
	D.R.C.	DVD-V VCD CD	To turn on or off a function that makes faint sounds easier to hear even if you lower the volume during late hours playback. (D.R.C. = Dynamic Range Control)
	Digital Out	DVD-V VCD CD	To select an output sound format corresponding to your system connection.
Rating 	Parental control	DVD-V VCD CD	To turn the parental lock function on or off.
	PBC	DVD-V VCD CD	To use the menu screen when playing a PBC-controllable VIDEO CD.
	Screen saver	DVD-V VCD CD	To turn the screen saver on or off.
Default 	Default	—	To restore all settings to the factory set.
	DivX® Registration	—	To display information about DivX.

Customizing the function settings (continued)

Language

OSD Menu **DVD-V** VCD CD

English: To view on-screen displays in English.

Français: To view on-screen displays in French.

Español: To view on-screen displays in Spanish.

Russian: To view on-screen displays in Russian.

Subtitle **DVD-V** VCD CD

English: To display subtitles in English.

French: To display subtitles in French.

Spanish: To display subtitles in Spanish.

Russian: To display subtitles in Russian.

Off: To display no subtitles.

Notes

- Some DVD video discs may be set to display subtitles in a different language than you selected. A prior subtitle language may be programmed on the disc.
- Some DVD video discs allow you to change subtitle selections only via the disc menu. If this is the case, press the MENU button and choose the appropriate subtitle language from the selection on the disc menu.

Audio **DVD-V** VCD CD

English: To play sound tracks in English.

French: To play sound tracks in French.

Spanish: To play sound tracks in Spanish.

Russian: To play sound tracks in Russian.

Note

- Some DVD video discs may be played in a different language than you selected. A prior language may be programmed on the disc.

DVD Menu **DVD-V** VCD CD

English: To display disc menus in English.

French: To display disc menus in French.

Spanish: To display disc menus in Spanish.

Russian: To display disc menus in Russian.

Note

- Some DVD video discs may not include your preselected language. In this case, the player automatically displays disc menus consistent with the disc's initial language setting.

DivX subtitle

- Western European:** To display subtitles in west European language.
- Central European:** To display subtitles in Central European language.
- Cyrillic:** To display subtitles in Cyrillic language.
- Hebrew:** To display subtitles in Hebrew language.

Notes

- Some DVD video discs may be set to display subtitles in a different language than you selected. A prior subtitle language may be programmed on the disc.
- Some DVD video discs allow you to change subtitle selections only via the disc menu. If this is the case, press the MENU button and choose the appropriate subtitle language from the selection on the disc menu.

Video

Aspect Ratio **DVD-V** **VCD** **CD**

- 4:3 :** Select when a standard 4:3 TV is connected.
- 16:9 :** Select when a 16:9 wide TV is connected.

Notes

- The displayable picture size is preset on the DVD video disc. Therefore, the playback picture of some DVD video discs may not conform to the picture size you select.
- When you play DVD video discs recorded in the 4:3 picture size only, the playback picture always appears in the 4:3 picture size regardless of the TV shape setting.
- If you select “16:9” and you own a 4:3 TV set, the DVD playback picture will be horizontally distorted during playback. Images will appear to be horizontally compressed. Always be sure that your TV shape conforms to the actual TV in use.

View Mode **DVD-V** **VCD** **CD**

- Fill:** Pictures are expanded horizontally and vertically to fit the shape of the screen. No picture cropping.
- Original:** Pictures are displayed in their original aspect ratios.
- Auto Fit:** Aspect ratios are automatically adjusted. Masking bars may appear on the top and bottom or left and right of picture.
- Pan Scan:** Pictures are cropped horizontally or vertically to fit the shape of the screen.

Note

- Actual views may depends on disc content or the TV. You may occasionally change the setting to your preference.

Customizing the function settings (continued)

Audio

E.A.M. DVD-V VCD CD

Normal:

Normal sound.

3D:

To obtain expansive virtual surround sound effects from just two speakers.

Note

- Pressing the E.A.M. button on the remote control also allows you to achieve the same setup.

D.R.C. DVD-V VCD CD

On :

Dynamic range is reduced.

Off :

Full dynamic range is maintained.

Notes

- This function works only during playback of Dolby Digital recorded discs.
- The level of Dynamic Range Control may differ depending on the DVD disc.

Digital Out DVD-V VCD CD

Bitstream:

Select when connected to an amplifier equipped with a Dolby Digital, DTS, MPEG1 or MPEG2 decoder. The player outputs digital audio signal in the bitstream format when you play a DVD video disc recorded in the Dolby Digital, DTS, MPEG1 or MPEG2 recording system.

Analog 2ch:

Select when connected to a TV or stereo system via the analog audio jacks.

PCM:

Select when connected to a 2 channel digital stereo amplifier.

The player outputs sounds in the PCM 2ch format when you play a DVD video disc recorded on the Dolby Digital, MPEG1 or MPEG2 recording system.

Rating

Parental control **DVD-V** VCD CD

DVD video discs equipped with the parental lock function are rated according to their content. The contents allowed by a parental lock level and the way a DVD video disc can be controlled may vary from disc to disc. For example, **if the disc allowed** you could edit out violent scenes unsuitable for children and replace them with more suitable scenes, or lock out playback of the disc altogether.

DVD video discs may or may not respond to the parental lock settings. This is not a defect in the player. Make sure this function works with your DVD video discs.

To set the parental level

- 1 Press **▲ / ▼ / ◀ / ▶** to select “Parental control” and then press **ENTER**.

The password setting display appears.

- 2 Press the number buttons to create a personal 5-digit security code then press **ENTER**.

The password sets.

- 3 Press **▲ / ▼** to select “Parental control” and enter the password you set then press **ENTER**.
- 4 Press **ENTER** while selecting “Parental control”.
- 5 Press **▲ / ▼** to select the parental level to set and then press **ENTER**.

8 : Adult	7 : NC-17	6 : R
5 : PG-R	4 : PG-13	3 : PG
2 : G	1 : Kid Safe	

To change the parental lock level

- 1 Press **▲ / ▼** to select “Set password”.
- 2 Press the number buttons to enter the 5-digit security code then press **ENTER**.

Follow the step “To set the parental level” to change the parental level.

Customizing the function settings (continued)

To change your 5-digit security code

- 1 After selecting “Set password”, press the **9** button five times then press **ENTER**.

The 5-digit security code is cleared.

- 2 After selecting “Set password”, press the number buttons to create a new 5-digit security code.

PBC DVD-V **VCD** CD

On :

To use the menu when playing a PBC-featured VIDEO CD.

Off :

When playing a VIDEO CD without using the menu.

Screen saver DVD-V VCD CD

On :

The screen saver operates.

Off :

The screen saver is disengaged.

Default

Default

No :

To not restore the function settings to their default settings.

Yes :

To restore the function settings to their default settings.

DivX[®] Registration

The DivX information appears.

Return to “Default” if you press ENTER while it is displayed.

Connections

You can connect the player to a TV or audio system.

Viewing on a connected TV

Viewing pictures from connected video equipment

Connecting to audio equipment

Using the automobile/vehicle adapter or power port

Viewing on a connected TV

You can connect a TV to this player to view playback picture on it.

1 Connect a TV to the AV OUT jack of this player.

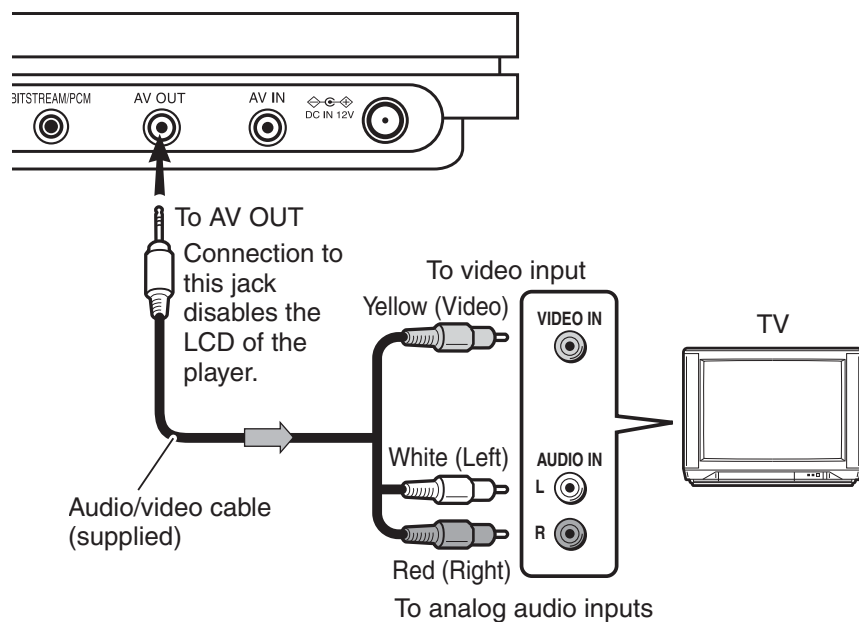

Notes

- Refer to the owner's manual of the connected TV as well.
- When you connect the player to your TV, be sure to turn off the power and unplug both units from the wall outlet before making any connections.
- Connect the player directly to your TV. If you connect the player to a VTR, TV/VTR combination or video selector, the playback picture may be distorted as DVD video discs are copy protected.

Make the following setting.	Setting	Select:	Page
	"Digital Out"	"Analog 2ch"	58

Viewing pictures from connected video equipment

You can use the LCD of this player to monitor pictures of connected video equipment.

1 Connect video equipment to the AV IN jack of this player.

2 Press MODE repeatedly so that “ (AV IN)” appears on the LCD.

The player is ready to display pictures of the connected equipment on the LCD. (AV input mode)

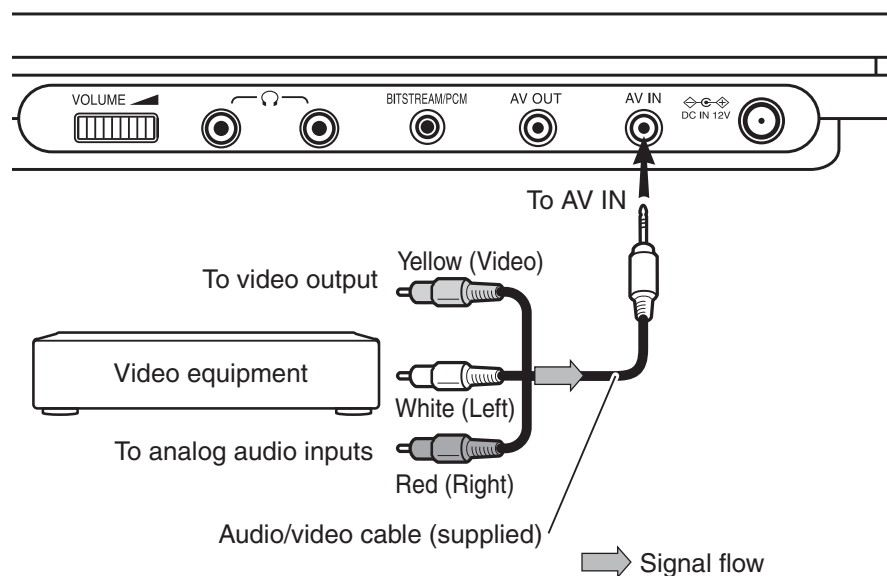

Notes

- When supplying non-standard signals such as playback images from a video deck or images from a game player, some images may be displayed incorrectly. For example, shooting games, which shoots at a target on the screen with a light gun, may not work because of the LCD Colour monitor properties.
- In the external AV input mode ( (AV-IN) appears on the screen), screen saver function/auto power OFF function becomes ineffective.

Connecting to audio equipment

You can enjoy high quality dynamic sounds by connecting the player to audio equipment.

The connecting method depends on the types of audio input, digital or audio.

Select the method according to the type of your equipment.

Caution

- When you connect the player to other equipment, be sure to turn off the power and unplug all of the equipment from the wall outlet before making any connections.
- Turn off the amplifier before you connect or disconnect the player's power cord. If you leave the amplifier power on, the speakers may be damaged.
- The output sound of the player has a wide dynamic range. Be sure to adjust the receiver's volume to a moderate listening level. Otherwise, the speakers may be damaged by a sudden high volume sound.

Notes

- Refer to the owner's manual of the connected equipment as well.
- If you place the player near a tuner or radio, the radio broadcast sound might be distorted. In this case, place the player away from the tuner and radio.

Connecting to an AV amplifier (via digital audio input)

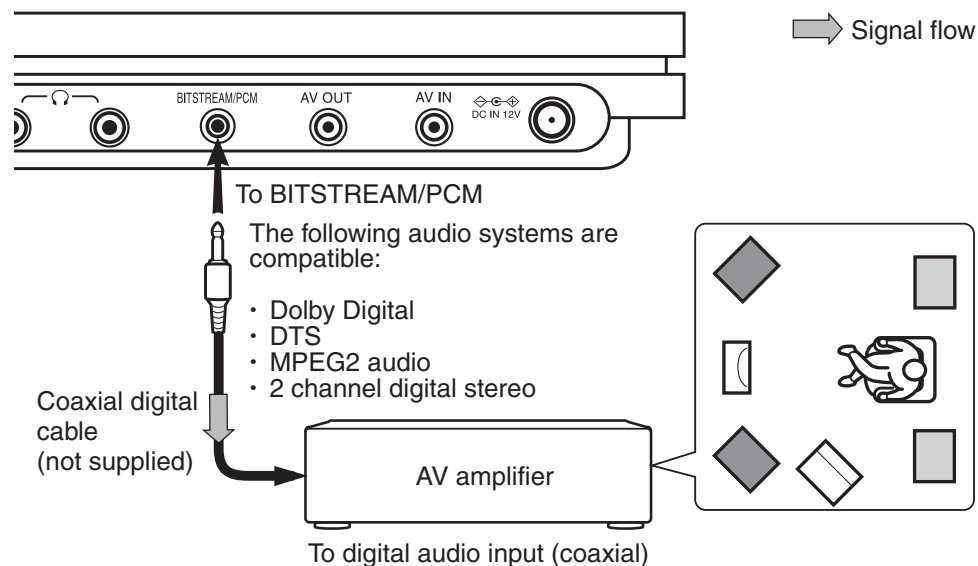

	Setting	Select:	Page
Make the following setting.	“Digital Out”	“Bitstream” or “PCM”	58 ➔

Manufactured under license from Dolby Laboratories. Dolby and the double-D symbol are trademarks of Dolby Laboratories. Confidential Unpublished Works. ©1992-1997 Dolby Laboratories, Inc. All rights reserved.

“DTS” and “DTS Digital Out” are registered trademarks of DTS, Inc.

Connecting to an audio system equipped with analog audio inputs

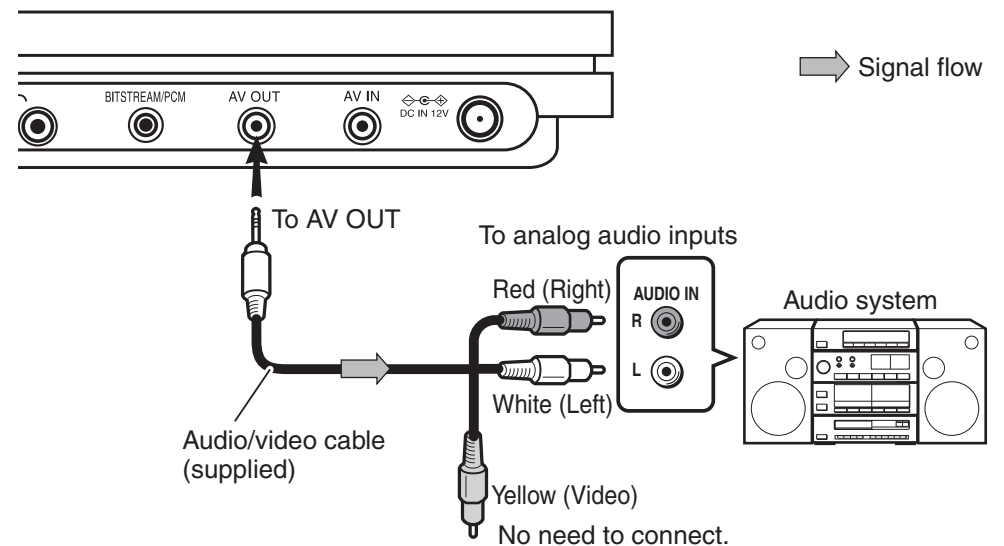

Make the following setting.	Setting	Select:	Page
		"Digital Out"	"Analog 2ch"

CAUTION

- When you are connecting (via the BITSTREAM/PCM jack) an AV decoder that does not have Dolby Digital, Digital Theater Systems (DTS) or MPEG2 decoding function, be sure to set "Digital Out" to "PCM" from the on-screen displays **58**. Otherwise, high volume sound may damage your hearing as well as the speakers.
- When playing DTS-encoded discs (audio CDs), excessive noise may be output from the analog audio output jacks. To avoid possible damage to the audio system, you should take proper precautions when the analog audio output jacks of the player are connected to an amplification system. To enjoy DTS Digital Surround[®] playback, an external 5.1 channel DTS Digital Surround[®] decoder system must be connected to the BITSTREAM/PCM jack of the player.

Note

- DO NOT connect the BITSTREAM/PCM jack of the player to the AC-3 RF input of a Dolby Digital Receiver. This input on your A/V Receiver is reserved for Laserdisc use only and is incompatible with the BITSTREAM/PCM jack of the player.

Using the automobile/vehicle adapter or power port

For use of the DVD player in a car, this adapter can power the DVD player from the cigarette lighter socket.

WARNING

- NEVER operate the DVD player or view a DVD Video while operating an automobile or other vehicle. Note: doing so is illegal in many jurisdictions.

NEVER place a DVD player within the eyesight of a driver while he/she is driving an automobile/vehicle. Note: A DVD player located in the front seating section of a vehicle is illegal in many jurisdictions.

Failure to observe the above instructions could result in the driver's inattention to and/or distraction from road hazards.

- NEVER place a DVD player in a location where it could interfere with the proper deployment and/or performance of an air bag.

Failure to observe this instruction could result in the prevention of an air bag to properly and/or effectively deploy.

- Do not use an adapter other than the model supplied, to power the player. Do not use the supplied vehicle adapter to power an apparatus other than this player. Neglecting these may cause smoke, fire or electrical shock to human body.
- This adapter is intended for exclusive use in automobiles/vehicles with a DC 12V negative ground electrical system. NEVER use this adapter with a DC 24V configured automobile/vehicle.

Consult your vehicle owner's manual before using this adapter.

- ALWAYS use caution when touching the adapter, cigarette lighter socket or power port. The adapter, lighter socket and power port may become heated after prolonged use.
- Do not charge the battery pack which is attached to the DVD player by the adapter. Doing so may cause smoke, fire or electrical shock to human body. Whenever you use the adapter, be sure to remove the battery pack from the DVD player to prevent it being charged by the adapter.
- Do not touch the adapter with wet hands. Do not get liquid on the adapter.

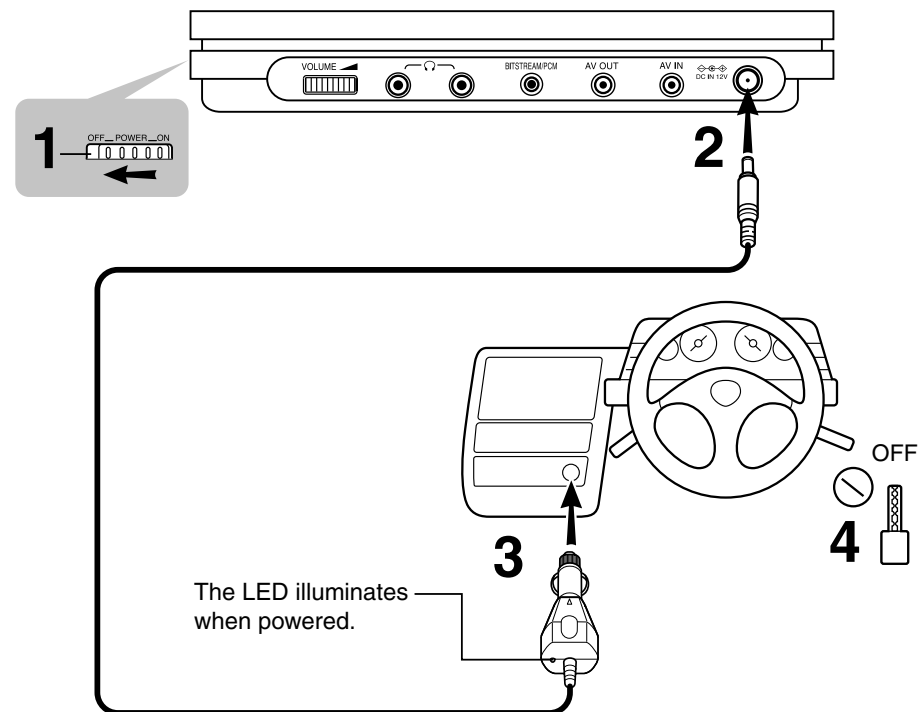

- 1 Turn off the DVD player.**
- 2 Insert the pin plug of the adapter into the DC IN 12V jack of the DVD player.**
- 3 Insert the plug of the adapter into the cigarette lighter socket or power port fully.**
- 4 Turn on the vehicle engine so that the cigarette lighter socket or power port is powered. In some vehicles the cigarette lighter socket or power port is powered even when the vehicle's engine is not running. It is important that the vehicle owner's manual be consulted.**
- 5 When disconnecting the DVD player, first remove the adapter pin plug from the DVD player and then the power plug from the cigarette lighter socket or power port.**

Specification

Operating temperature: 5 ~ 35°C (41 ~ 95°F)

Operating humidity: 30 ~ 80%

Storage temperature: -10 ~ 60°C (50 ~ 140°F)

Storage humidity: 20 ~ 80%

Notes

- Never operate the player in a moving vehicle. Vibration may prevent proper playback of the player or cause damage to the disc.
- Do not leave the adapter in an unoccupied vehicle to avoid exposing it to unusually high ambient temperatures.
- Remove the adapter power plug from the cigarette lighter socket or power port before turning the engine off.
- When the DVD player is not in use be sure to remove the adapter power plug from the cigarette lighter socket or power port and the pin plug from the DVD player.
- Do not force the adapter into an incompatible lighter socket or power port.
- Avoid dropping the adapter or placing heavy objects on it.
- Do not pull the adapter power cord when removing it from a socket or power port.
Always grasp and pull the body.
Failure to do so could cause damage to and malfunction of the adapter.
- Do not operate the DVD player using the adapter for a prolonged period with the car engine off. The car battery may be too exhausted to turn the engine on.
- Depending on the vehicle model or the location of the cigarette lighter socket, this adapter may not be applied.
- In some vehicles the cigarette lighter socket is powered even when the vehicle's engine is not running. Using the cigarette lighter socket for power when the engine is not running will drain the car's battery.

Others

Useful informations.

Output sound conversion table

Before calling service personnel

Specifications

Output sound conversion table

Discs	Sound recording system		Audio selection and outputs					
			"Bitstream"		"Analog 2ch"		"PCM"	
			BITSTREAM/PCM jack	Speakers/AV OUT jack/ Headphone jacks	BITSTREAM/PCM jack	Speakers/AV OUT jack/ Headphone jacks	BITSTREAM/PCM jack	Speakers/AV OUT jack/ Headphone jacks
DVD video discs	Dolby Digital		Bitstream	Yes	Bitstream	Yes	PCM	Yes
	Linear PCM	48 kHz	PCM	Yes	No	Yes	PCM	Yes
		96 kHz	PCM*	Yes	No	Yes	PCM*	Yes
	DTS		Bitstream	No	Bitstream	No	Bitstream	No
	MPEG1, MPEG2		Bitstream	Yes	Bitstream	Yes	PCM	Yes
VIDEO CDs	MPEG1		Bitstream	Yes	Bitstream	Yes	PCM	Yes
AUDIO CDs	Linear PCM 44.1 kHz		PCM	Yes	PCM	Yes	PCM	Yes
	DTS		Bitstream	No	Bitstream	No	Bitstream	No

*PCM: down sampling PCM

- Signals of 88.2 kHz or higher from the BITSTREAM/PCM jack are down converted to 44.1 kHz or 48 kHz when:
 - "3D On" is selected.
 - a copyright protected disc is played.
- Quantization will be limited to 16 bits in a copyright protected disc.

Before calling service personnel

Check the following guide for the possible cause of a problem before contacting service.

Symptom	Cause	Correction
No power.	• The AC adapter or power plug is disconnected.	• Connect the AC adapter or power plug securely.
	• The battery pack has been removed.	• Install the battery pack.
	• Battery empty.	• Re-charge the battery.
The LCD turned off by itself.	• The automatic LCD off function turned the LCD off.	• Turn on the player again.
No picture on the LCD monitor.	• The AV OUT jack is connected.	• When you use the LCD of the player, unplug the AV OUT jack.
No picture. (Other than built-in LCD monitor)	• The connected TV is not set to receive DVD signal output.	• Select the appropriate video input mode on the TV so the picture from the player appears on the TV screen.
No sound.	• The equipment connected via the audio/video cable is not set to receive DVD signal output.	• Select the correct input mode of the audio receiver so you can listen to the sound from the player.
	• The volume is too low.	• Adjust the volume by turning the volume control.
	• The audio receiver or TV is turned off.	• Turn on the equipment connected with the audio/video cable.
	• The setting of output sound format is incorrect.	• Select the proper audio setting.
The playback picture has occasional distortion.	• The disc is dirty.	• Eject the disc and clean it.
	• Player is in fast forward or fast reverse mode.	• Sometimes a small amount of picture distortion may appear. This is not a malfunction.
	• The player was moved or given a shock.	• Vibrating or shaking the player during playback may produce distortion. This is not a malfunction. If not restored to usual status, stop playback and start again.
	• The disc is not set firmly.	• Remove the disc and set it again.
Brightness is unstable or noises are present in the playback pictures. (Other than built-in LCD monitor)	• The effect of copy protection. If you connect the player to a VTR, TV/VTR combination or video selector, the playback picture may be distorted as DVD video discs are copy protected.	• Connect the player directly to the TV. Avoid connecting the player to a VTR or TV/VTR combination.

Before calling service personnel (continued)

Symptom	Cause	Correction
The player does not start playback.	• No disc is inserted.	• Insert a disc.
	• An unplayable disc is inserted.	• Insert a playable disc. (Check the disc type, colour system and region number.)
	• The disc is inserted upside down.	• Insert the disc with the playback side down.
	• The disc is not inserted securely.	• Insert the disc securely in the disc holder.
	• The disc is dirty.	• Clean the disc.
	• The parental lock function is set.	• Cancel the parental lock function or change the parental lock level.
	• The player is set to the external input mode (AV-IN).	• To play a disc with the player, Normal needs to be set. Press MODE repeatedly so that you can view playback picture.
Playback does not follow the course of the disc's program.	• It is in the repeat playback mode, memory playback, etc.	• These operations may prevent a proper progression of the contents.
Buttons do not work.	• Power supply fluctuations or other abnormalities such as static electricity may interrupt correct operation.	• Turn the power on or off with the POWER switch. Or disconnect the power cord and insert it into the wall outlet again.
The remote control does not work properly.	• The remote control is not pointed at the remote sensor of the player.	• Point the remote control at the remote sensor of the player.
	• The remote control is too far from the player.	• Operate the remote control within about 3 m (9.9 feet).
	• The batteries in the remote control are exhausted.	• Replace the batteries with new ones.
	• The player's remote sensor is exposed to a strong light source such as direct sunlight or other illumination.	• Avoid the player from being exposed to a strong light source.

Specifications

Player

Power supply

DC 12 V (Rated current : 2 A (Maximum: during battery pack charging))
100 – 240 V AC, 50/60 Hz (with the supplied AC adapter)

Mass

approximately 1.2 kg

External dimensions

240 × 32 × 170 mm (W/H/D)

Signal system

PAL/3.58NTSC

Laser

Semiconductor laser, wavelength 650 nm / 795 nm

Frequency range

DVD linear sound :
48 kHz sampling 4 Hz to 22 kHz
96 kHz sampling 4 Hz to 44 kHz

Operating conditions

Temperature: 5°C to 35°C (41°F to 95°F)
Operation status: Horizontal

Connectors

AV output (AV OUT)

ø3.5mm mini jack × 1
Video: 1.0 V (p-p), 75Ω, negative sync.,
Audio: 2.0 V (rms), 100Ω

AV input (AV IN)

ø3.5mm mini jack × 1
Video: 1.0 V (p-p), 75Ω, negative sync.,
Audio: 2.0 V (rms), 10kΩ

Audio output (BITSTREAM/PCM)

Coaxial digital terminal (ø3.5mm) × 1

Headphone terminal

ø3.5mm stereo mini jack × 2

Specifications (continued)

Liquid crystal display

Panel size 22.86cm (9 inches diagonally measured)
Projection system TN colour transmission
Driving system Amorphous silicon TFT active matrix
Resolution 480 (H) × 234 (V) pixels (effective pixel rate : more than 99.99%)

Supplied accessories

Audio/video cable	1
Remote control (MEDR16UX).....	1
Coin-shaped battery (CR2025).....	1
AC adapter (ADPV16A).....	1
Power cord.....	1
Battery pack (SD-PBP90R).....	1
Vehicle adapter (MEDC01AX).....	1
Headphones.....	1
Carrying case.....	1
Owner's Manual	1

- This model complies with the specifications.
- Designs and specifications are subject to change without notice.
- This model may not be compatible with features and/or specifications that may be added in the future.

TOSHIBA

Free Manuals Download Website

<http://myh66.com>

<http://usermanuals.us>

<http://www.somanuals.com>

<http://www.4manuals.cc>

<http://www.manual-lib.com>

<http://www.404manual.com>

<http://www.luxmanual.com>

<http://aubethermostatmanual.com>

Golf course search by state

<http://golfingnear.com>

Email search by domain

<http://emailbydomain.com>

Auto manuals search

<http://auto.somanuals.com>

TV manuals search

<http://tv.somanuals.com>