

TOSHIBA

OWNER'S MANUAL

Projection Television

COLORSTREAM®

**43A61, 43A62,
50A61, 50A62,
61A61, 61A62**



Owner's Record

The model number and serial number are on the back of your TV. Record these numbers in the spaces below. Refer to these numbers whenever you communicate with your Toshiba dealer about this TV.

Model number:

Serial number:

Introduction

Connecting your TV

Using the Remote Control

Setting up your TV

Using the TV's Features

Appendix

Index

Dear Customer,

Thank you for purchasing this Toshiba TV. This manual will help you use the many exciting features of your new TV.

Before operating the TV, please read this manual completely, and keep it nearby for future reference.

Safety Precautions

WARNING

TO REDUCE THE RISK OF FIRE OR ELECTRIC SHOCK, DO NOT EXPOSE THIS APPLIANCE TO RAIN OR MOISTURE.

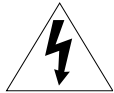

WARNING
RISK OF ELECTRIC SHOCK
DO NOT OPEN



WARNING: TO REDUCE THE RISK OF ELECTRIC SHOCK, DO NOT REMOVE COVER (OR BACK). NO USER-SERVICEABLE PARTS INSIDE. REFER SERVICING TO QUALIFIED SERVICE PERSONNEL.

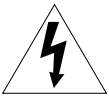

The lightning symbol in the triangle tells you that the voltage inside this product may be strong enough to cause an electric shock. **DO NOT TRY TO SERVICE THIS PRODUCT YOURSELF.**



The exclamation mark in the triangle tells you that important operating and maintenance instructions follow this symbol.

NOTE TO CATV INSTALLERS IN THE USA

This is a reminder to call the CATV system installer's attention to Article 820-40 of the NEC, which provides guidelines for proper grounding and, in particular, specifies that the cable ground shall be connected to the grounding system of the building, as close to the point of cable entry as practical. For additional antenna grounding information, see items 24 and 25 on page 4.

NOTICE OF POSSIBLE TV STAND INSTABILITY



DANGER: RISK OF SERIOUS PERSONAL INJURY OR DEATH!

Use this TV with the TOSHIBA TV stand recommended in the "Specifications" section only. Use with other stands may result in instability, causing possible injury or death.

NOTICE OF POSSIBLE ADVERSE EFFECTS ON TV PICTURE TUBE

If a fixed (non-moving) pattern remains on the TV screen for long periods of time, the image can become permanently engrained in the picture tube. **This type of damage is NOT COVERED BY YOUR WARRANTY.** See item 32 on page 4.

Child Safety

It Makes A Difference Where Your TV Stands



Congratulations on your purchase! As you enjoy your new TV, keep these safety tips in mind:

The Issue

- If you are like most Americans, you have a TV in your home. Many homes, in fact, have more than one TV.
- The home theater entertainment experience is a growing trend, and larger TVs are popular purchases; however, they are not always supported on the proper TV stands.
- Sometimes TVs are improperly secured or inappropriately situated on dressers, bookcases, shelves, desks, audio speakers, chests, or carts. As a result, TVs may fall over, causing unnecessary injury.

Toshiba Cares!

- The consumer electronics industry is committed to making home entertainment enjoyable and safe.
- The Consumer Electronics Association formed the Home Entertainment Support Safety Committee, comprised of TV and consumer electronics furniture manufacturers, to advocate children's safety and educate consumers and their families about television safety.

Tune Into Safety

- One size does NOT fit all! Use appropriate furniture large enough to support the weight of your TV (and other electronic components).
- Use appropriate angle braces, straps, and anchors to secure your furniture to the wall (but never screw anything directly into the TV).
- Carefully read and understand the other enclosed instructions for proper use of this product.
- Do not allow children to climb on or play with furniture and TVs.
- Avoid placing any item on top of your TV (such as a VCR, remote control, or toy) that a curious child may reach for.
- Remember that children can become excited while watching a program and can potentially push or pull a TV over.
- Share our safety message about this hidden hazard of the home with your family and friends. Thank you!



2500 Wilson Blvd.
Arlington, VA 22201 U.S.A.
Tel. 703-907-7600 Fax 703-907-7690
www.CE.org

CEA is the Sponsor, Producer and Manager of the International CES®

05/02.2

Important Safety Instructions

- 1) **Read these instructions.**
- 2) **Keep these instructions.**
- 3) **Heed all warnings.**
- 4) **Follow all instructions.**



- 5) **Do not use this apparatus near water.**



- 6) **Clean only with a dry cloth.**

- 7) **Do not block any ventilation openings.** Install in accordance with the manufacturer's instructions.

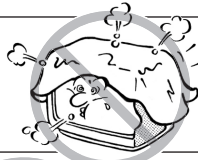

- 8) **Do not install near any heat sources** such as radiators, heat registers, stoves, or other apparatus (including amplifiers) that produce heat.

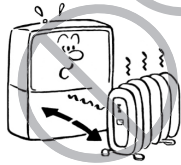

- 9) **Do not defeat the safety purpose of the polarized or grounding type plug.** A polarized plug has two blades with one wider than the other. A grounding type plug has two blades and a third grounding prong. The wide blade or the third prong are provided for your safety. If the provided plug does not fit into your outlet, consult an electrician for replacement of the obsolete outlet.

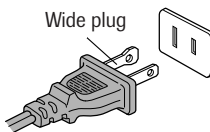

CAUTION: To reduce the risk of electric shock, do not use the polarized plug with an extension cord, receptacle, or other outlet unless the blades can be inserted completely to prevent blade exposure.

- 10) **Protect the power cord** from being walked on or pinched, particularly at plugs, convenience receptacles, and the point where it exits the apparatus.

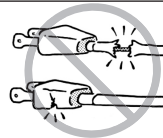

- 11) **Only use attachments/accessories specified by the manufacturer.**

- 12) **Use only with the cart, stand, tripod, bracket, or table specified by the manufacturer, or sold with the apparatus.** When a cart is used, use caution when moving the cart/apparatus combination to avoid injury from tip-over.



- 13) **Unplug this apparatus during lightning storms or when unused for long periods of time.**



- 14) **Refer all servicing to qualified service personnel.**

Servicing is required when the apparatus has been damaged in any way, such as power supply cord or plug is damaged, liquid has been spilled or objects have fallen into the apparatus, the apparatus has been exposed to rain or moisture, does not operate normally, or has been dropped.



05/02.2

Installation, Care, and Service

Installation

Follow these recommendations and precautions and heed all warnings when installing your TV:

- 15) Never modify this equipment. Changes or modifications may void: a) the warranty, and b) the user's authority to operate this equipment under the rules of the Federal Communications Commission.

- 16) **DANGER: RISK OF SERIOUS PERSONAL INJURY, DEATH, OR EQUIPMENT DAMAGE!** Never place the TV on an unstable cart, stand, or table. The TV may fall, causing serious personal injury, death, or serious damage to the TV.



- 17) Never place or store the TV in direct sunlight; hot, humid areas; areas subject to excessive dust or vibration; or locations with temperatures at or below 41°F (5°C).

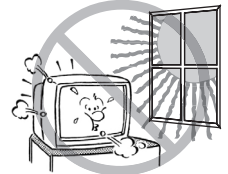

- 18) Always place the TV on the floor or a sturdy, level, stable surface that can support the weight of the unit.



- 19) Never place items such as vases, aquariums, or candles on top of the TV.



- 20) Never block or cover the slots or openings in the TV cabinet back, bottom, and sides. Never place the TV:
 - on a bed, sofa, rug, or similar surface;
 - too close to drapes, curtains, or walls; or
 - in a confined space such as a bookcase, built-in cabinet, or any other place with poor ventilation.

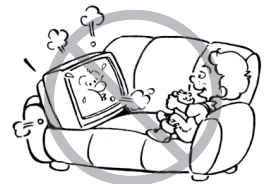

The slots and openings are provided to protect the TV from overheating and to help maintain reliable operation of the TV.

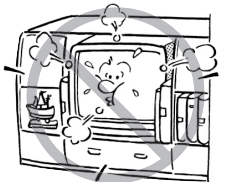

- 21) Never allow anything to rest on or roll over the power cord, and never place the TV where the power cord is subject to wear or abuse.

- 22) Never overload wall outlets and extension cords.



- 23) Always operate this equipment from a 120 VAC, 60 Hz power source only.



- 24) Always make sure the antenna system is properly grounded to provide adequate protection against voltage surges and built-up static charges (see Section 810 of the National Electric Code).

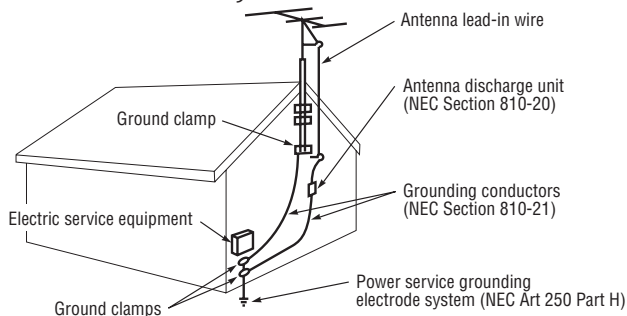

- 25) **! DANGER: RISK OF SERIOUS PERSONAL INJURY OR DEATH!**
- Use extreme care to make sure you are never in a position where your body (or any item you are in contact with, such as a ladder or screwdriver) can accidentally touch overhead power lines. Never locate the antenna near overhead power lines or other electrical circuits.
 - Never attempt to install any of the following during lightning activity:
 - a) an antenna system; or b) cables, wires, or any home theater component connected to an antenna or phone system.

Care

For better performance and safer operation of your TOSHIBA TV, follow these recommendations and precautions:

- 26) Always sit approximately 10–25 feet away from the TV and as directly in front of it as possible. The picture can appear dull if you sit too far to the left or right of the TV, or if sunlight or room lights reflect on the screen. Turn the TV off to check for reflections on the screen, and then remove the source of reflections while viewing the TV.

- 27) Always unplug the TV before cleaning. Never use liquid or aerosol cleaners.

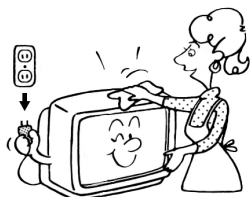

- 28) **! WARNING: RISK OF ELECTRIC SHOCK!** Never spill liquids or push objects of any kind into the TV cabinet slots.

- 29) [This item applies to projection TVs only.] If the air temperature rises suddenly (for example, when the TV is first delivered), condensation may form on the lenses. This can make the picture appear distorted or the color appear faded. If this happens, turn off the TV for 6 to 7 hours to allow the condensation to evaporate.

- 30) For added protection of your TV from lightning and power surges, always unplug the power cord and disconnect the antenna from the TV if you leave the TV unattended or unused for long periods of time.

- 31) During normal use, the TV may make occasional snapping or popping sounds. This is normal, especially when the unit is being turned on or off. If these sounds become frequent or continuous, unplug the power cord and contact a Toshiba Authorized Service Center.

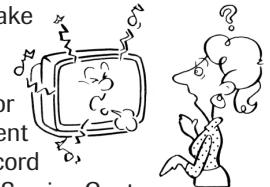

- 32) **Possible Adverse Effects on TV Picture Tube:** If a fixed (non-moving) pattern remains on the TV screen for long periods of time, the image can become permanently engrained in the picture tube and cause subtle but permanent ghost images. **This type of damage is NOT COVERED BY YOUR WARRANTY.** Never leave your TV on for long periods of time while it is displaying the following formats or images:

- **Fixed Images**, such as PIP/POP windows, stock tickers, video game patterns, TV station logos, and websites.
- **Special Formats** that do not use the entire screen. For example, viewing letterbox style (16:9) media on a normal (4:3) display (gray bars at top and bottom of screen); or viewing normal style (4:3) media on a widescreen (16:9) display (gray bars on left and right sides of screen).

Service

- 33) **! WARNING: RISK OF ELECTRIC SHOCK!** Never attempt to service the TV yourself. Opening and removing the covers may expose you to dangerous voltage or other hazards. Refer all servicing to a Toshiba Authorized Service Center.

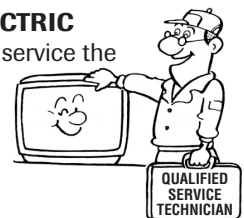

- 34) If you have the TV serviced:

- Ask the service technician to use only replacement parts specified by the manufacturer.
- Upon completion of service, ask the service technician to perform routine safety checks to determine that the TV is in safe operating condition.

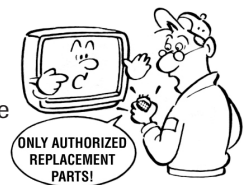

- 35) When the TV reaches the end of its useful life, ask a qualified service technician to properly dispose of the TV. Improper disposal may result in a picture tube implosion and possible personal injury.

Important Safety Information	2-4		
Introduction	5		
Welcome to Toshiba	5		
Exploring your new TV	5		
Connecting your TV	7		
Note regarding picture quality	7		
Connecting a VCR	7		
Connecting a cable converter box	8		
Connecting a cable converter box and a VCR	8		
Connecting a DVD player /satellite receiver and a VCR.....	9		
Connecting a DVD player with ColorStream® and a VCR.....	9		
Connecting two VCRs	10		
Connecting a camcorder	11		
Connecting an audio system	11		
Connecting an A/V receiver	12		
Using the remote control	13		
Preparing the remote control for use	13		
Installing the remote control batteries	13		
Using the remote control with a VCR or cable TV converter	13		
Programming the remote control for use with a non-Toshiba VCR or cable TV converter	14		
VCR code table	15		
Cable TV converter code table	16		
Learning about the remote control	17		
Setting up your TV	18		
Changing the on-screen display language	19		
Selecting the antenna input	19		
Adding channels to the TV's memory	20		
Programming channels automatically	20		
Adding and erasing channels manually	21		
Changing channels	21		
Changing channels using SpeedSurf	21		
Adjusting the color convergence	22		
Using the TV's features	23		
Adjusting the channel settings	23		
Switching between two channels	23		
Programming your favorite channels	23		
Labeling channels	24		
Watching picture-in-picture (PIP)	26		
Switching the main and small pictures	27		
Changing the position of the small picture	27		
Freezing the small picture	27		
Using the LOCKS menu	28		
Entering the PIN code	28		
		If you cannot remember your PIN code	28
		Using the V-CHIP menu	29
		ENABLE BLOCKING	29
		TV RATING (Independent rating system for broadcasters)	29
		MPAA RATING (Independent rating system for movies)	30
		BLOCKING OPTION	30
		Unlocking programs temporarily	31
		Locking channels	31
		Locking video inputs	32
		Locking the front panel buttons	32
		Adjusting the picture	33
		Selecting the picture modes	33
		Adjusting the picture quality	33
		Saving new preferences	34
		Using the flesh tone feature	34
		Using the noise reduction feature	34
		Selecting the color temperature	35
		Resetting your picture adjustments	35
		Watching video input	36
		Selecting the video input labels	36
		Using the closed caption feature	37
		Setting the sleep timer	38
		Setting the clock	38
		Adjusting the sound	39
		Muting the sound	39
		Selecting stereo/SAP broadcasts	39
		Using the surround sound feature	40
		Adjusting the sound quality	41
		Resetting your audio adjustments	41
		Using the sub-bass system (SBS)	42
		Turning off the built-in speakers	42
		Selecting the Audio OUT sound	43
		Using the StableSound® feature	43
		Selecting the background of the menu display	44
		Displaying on-screen information	44
		Viewing the demonstration mode	44
		Understanding the auto power off feature	45
		Understanding the last mode memory feature	45
		Appendix	46
		Specifications	46
		Troubleshooting	47
		Limited United States Warranty	48
		Limited Canada Warranty	49
		Index	50

Introduction

Welcome to Toshiba

Congratulations! You have purchased one of the finest projection TV's on the market. The goal of this manual is to guide you through setting up and operating your Toshiba TV as quickly as possible.

This manual applies to models 43A61, 43A62, 50A61, 50A62, 61A61, and 61A62. Before you start reading, check the model number by looking at the rear of the TV.

Models 50A61 and 50A62 are used in this manual for illustration purposes. Instructions are based on using the remote control. You can also use the controls on the TV if they have the same name as those on the remote control.

Please read all the safety and operating instructions carefully, and keep the manual for future reference.

Exploring your new TV

You can operate your TV using the buttons on the front panel or remote control. The back panel and front panel (behind the door) provide all the terminal inputs to connect other equipment to the TV.

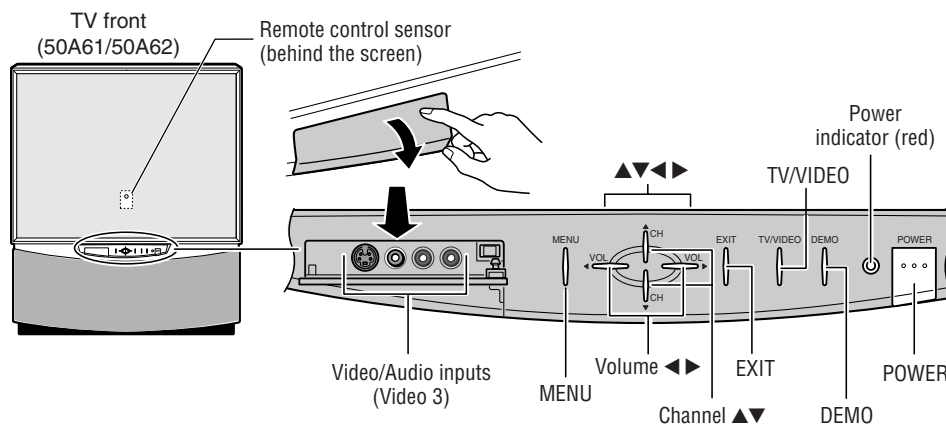

TV rear (50A61/50A62)

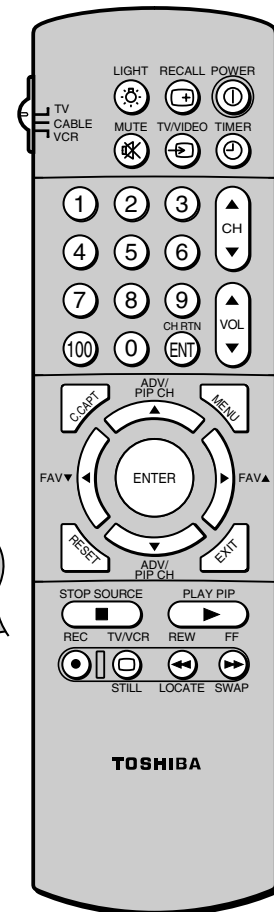
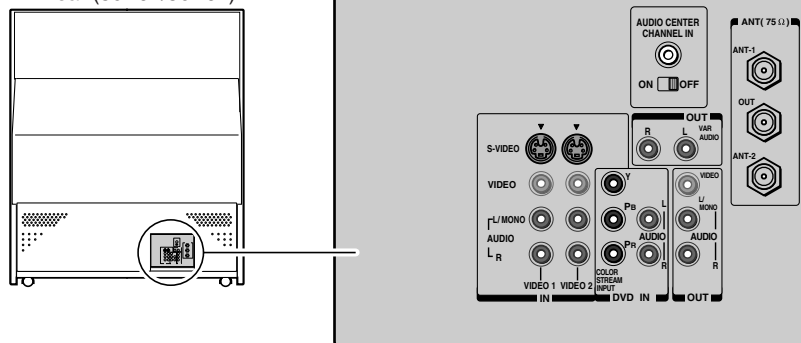

Connecting your TV

Note: Cables are not supplied with your TV.

- **Coaxial cable** is the cable that comes in from your antenna, cable TV service, or cable converter box. Coaxial cable uses "F" connectors.
- **Standard stereo A/V cables** usually come in sets of three, and are typically color-coded according to use: yellow for video, red for stereo right audio, and white for stereo left (or mono) audio. Your TV's standard A/V inputs are color-coded in the same manner as the cables.
- **S-Video cable** is for use with video equipment that has S-Video connectors.
- **Component video cables** come in sets of three (typically color-coded red, green, and blue), and are for use with video equipment that has component video connectors. Your TV's ColorStream® (component video) inputs are color-coded in the same manner as the cables.

NOTE REGARDING PICTURE QUALITY

When connecting video equipment to your Toshiba TV:

- **For GOOD picture quality:** Use a standard yellow video cable.
- **For BETTER picture quality:** If your equipment has S-video connectors, use an S-video cable *instead of* a standard yellow video cable. (You still must connect the standard red and white audio cables for full system connection, but *do not connect a standard yellow video cable at the same time* or the picture performance will be unacceptable.)
- **For BEST picture quality:** If your equipment has component video connectors, use component video cables *instead of* a standard yellow video cable or S-video cable. (You still must connect the standard red and white audio cables for full system connection.)

Connecting a VCR

This connection allows you to watch local channels and video programs, play or record on the VCR while watching TV, and record from one channel while watching another channel.

You will need:

- two coaxial cables (one or more may be provided by your cable company)
- one pair of audio cables (one single cable for a mono VCR)
- one video cable

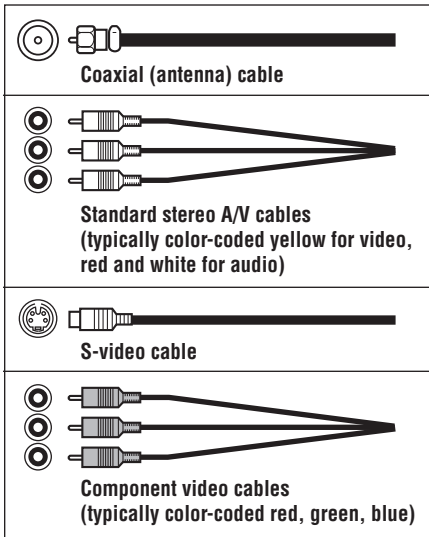
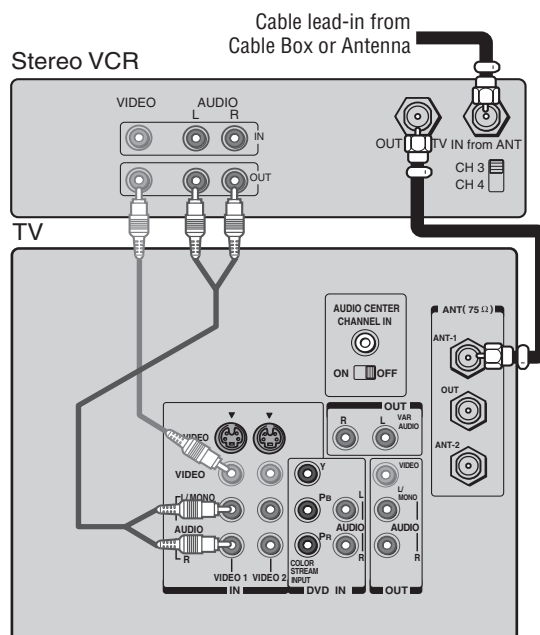

CAUTION: Do not plug in any power cords until you have finished connecting all equipment.

Note:

If you have a mono VCR, connect L/Mono to VCR Audio OUT using only one audio cable.

If you have an S-VHS VCR, use an S-video cable instead of a standard video cable for better picture performance.

Do not connect a standard video cable and an S-video cable to Video-1 (or Video-2) at the same time or the picture performance will be unacceptable.

The unauthorized recording, use, distribution, or revision of television programs, videotapes, DVDs, and other materials is prohibited under the Copyright Laws of the United States and other countries, and may subject you to civil and criminal liability.

Connecting a cable converter box

This connection allows you to view a different picture on your PIP if you use a converter box to view premium channels. Select ANT 2 and tune the TV to channel 3 or 4 (whichever channel is vacant in your area). Use the converter box to change channels.

You will need:

- three coaxial cables

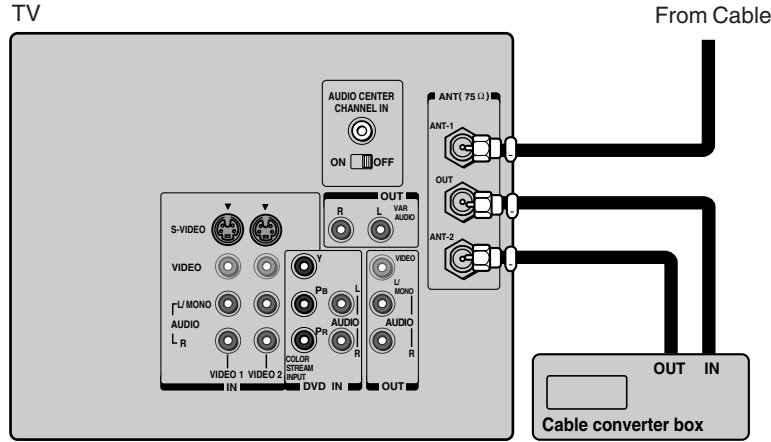

Note:

You cannot view premium channels in the PIP window.

PIP swap is not available with this connection.

Connecting a cable converter box and a VCR

This connection allows you to watch and record basic and premium cable channels, watch videotapes, and record one channel while watching another. To use the TV's features, select ANT-1. To view premium channels or record with the VCR, select ANT-2, tune the TV to channel 3 or 4 (whichever channel is vacant in your area), and use the converter box to change channels.

You will need:

- one cable splitter
- four coaxial cables (one or more may be provided by your cable company)
- one pair of audio cables (one single audio cable for a mono VCR)
- one video cable

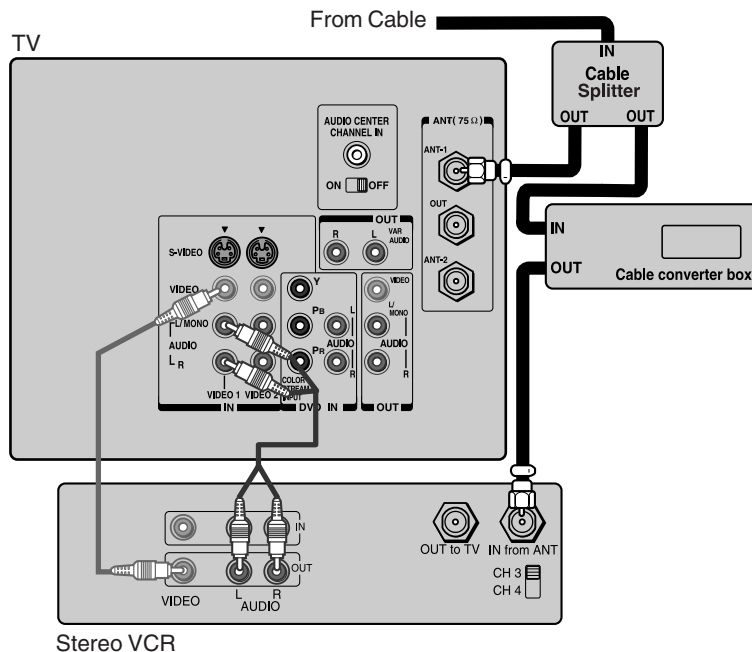

Note:

If you have a mono VCR, connect L/Mono to VCR Audio OUT using only one audio cable.

If you have an S-VHS VCR, use an S-video cable instead of a standard video cable for better picture performance.

Do not connect a standard video cable and an S-video cable to Video-1 (or Video-2) at the same time or the picture performance will be unacceptable.

The unauthorized recording, use, distribution, or revision of television programs, videotapes, DVDs, and other materials is prohibited under the Copyright Laws of the United States and other countries, and may subject you to civil and criminal liability.

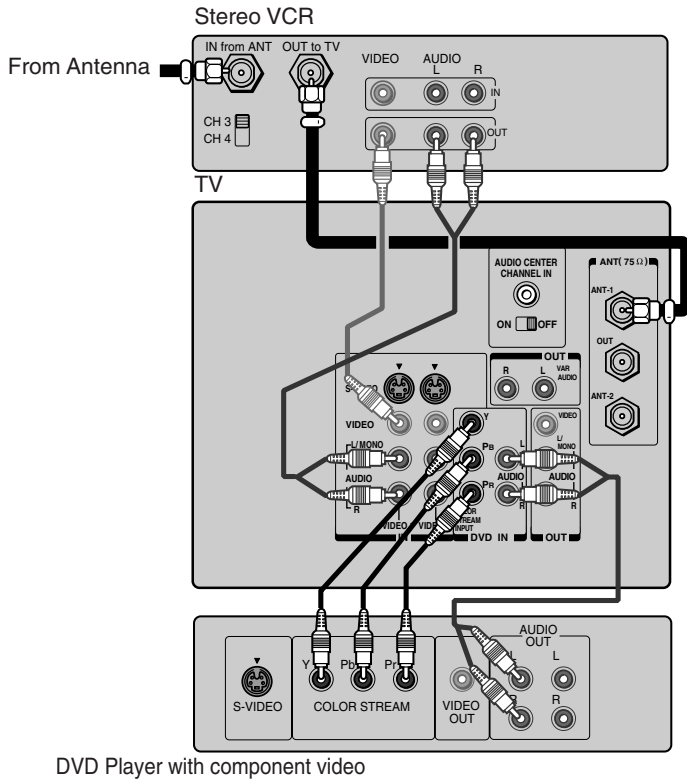

Note:
To play from the DVD player, the DVD player and TV must use ColorStream connections.

The unauthorized recording, use, distribution, or revision of television programs, videotapes, DVDs, and other materials is prohibited under the Copyright Laws of the United States and other countries, and may subject you to civil and criminal liability.

Connecting two VCRs

This connection allows you to record (dub/edit) from one VCR to another VCR while watching a video program. You will also be able to record from one TV channel while watching another channel.

You will need:

- two coaxial cables (one or more may be provided by your cable company)
- two pairs of audio cables (two single audio cables for mono VCRs)
- two video cables

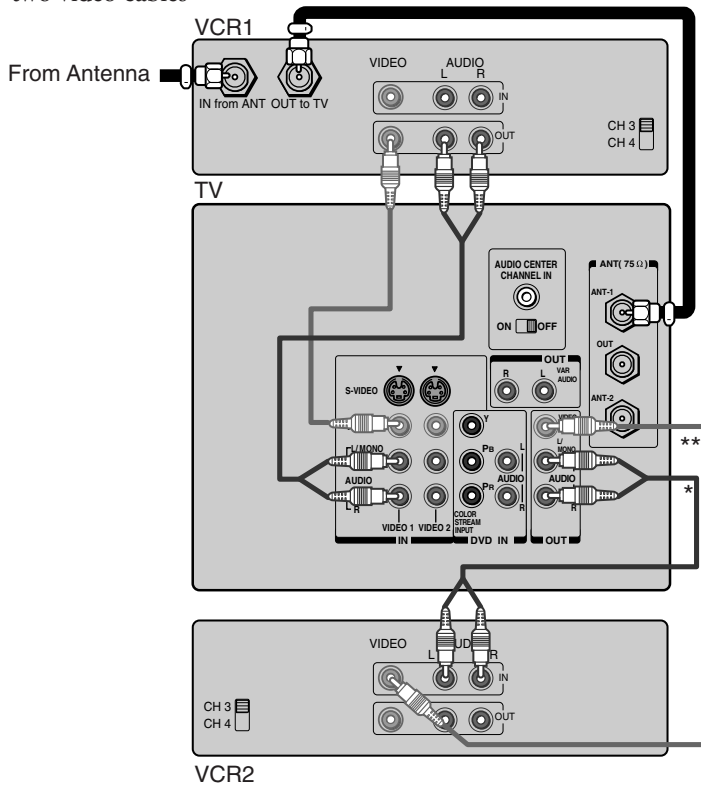

Note:
Do not connect the same VCR to the output and input jacks on the TV at the same time. If you are using an S-VHS VCR, use an S-video cable instead of a standard video cable for better picture performance. Do not connect a standard video cable and an S-video cable to Video-1 (or Video-2) at the same time or the picture performance will be unacceptable. To dub or edit, VCR 2 must select Line IN, and the TV must select Video-1.

* The Audio OUT jacks can output the sound of either the main or PIP picture (see "Selecting the Audio OUT sound" on page 43).

** The Video OUT jack does not output a PIP picture.

Connecting a camcorder

This connection allows you to watch video materials recorded on a camcorder.

You will need:

- one pair of audio cables
- one video cable

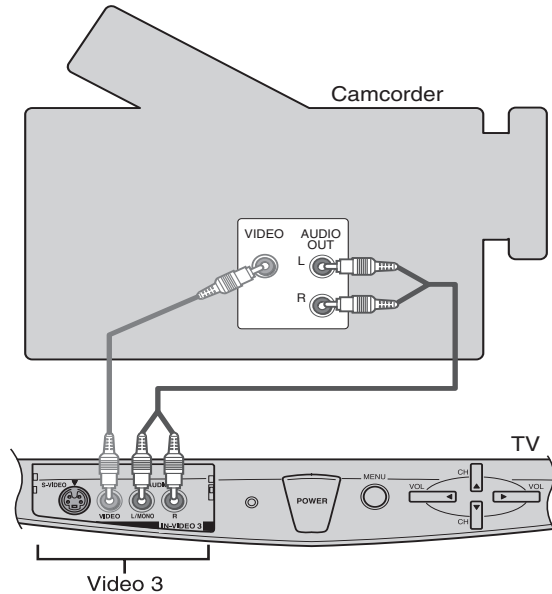

Note:

If you have an S-VHS camcorder, use an S-video cable (in the S-video jacks) instead of a standard video cable between the TV and camcorder.

Do not connect a standard video cable and an S-video cable to Video-3 at the same time or the picture performance will be unacceptable.

The unauthorized recording, use, distribution, or revision of television programs, videotapes, DVDs, and other materials is prohibited under the Copyright Laws of the United States and other countries, and may subject you to civil and criminal liability.

Connecting an audio system

This connection allows you to use an audio amplifier to adjust the audio level. This also allows you to use external speakers.

To control the audio, turn on the TV and the stereo amplifier, and turn off the built-in speakers (see "Turning off the built-in speakers" on page 42).

You will need:

- one coaxial cable (may be provided by your cable company)
- one pair of audio cables

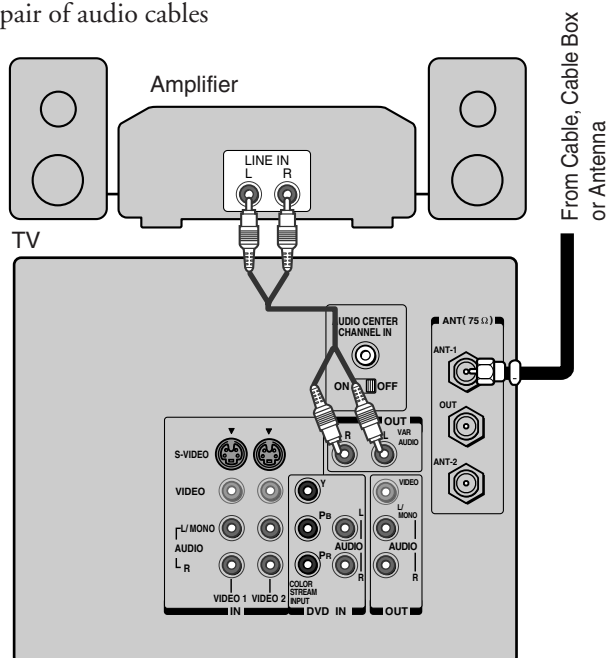

Note:

To hear sound, the volume of both the TV and the external audio amplifier must be set above 0 (zero).

Connecting an A/V receiver

This connection allows you to use an audio/video (A/V) receiver to enhance your TV's sound.

If you have a system with Dolby Pro Logic* surround sound, you can add to the realism of the sound by using the TV speakers as center channel speakers.

You will need:

- one coaxial cable (may be provided by your cable company)
- one pair of audio cables
- one video cable
- one audio cable for the audio center channel

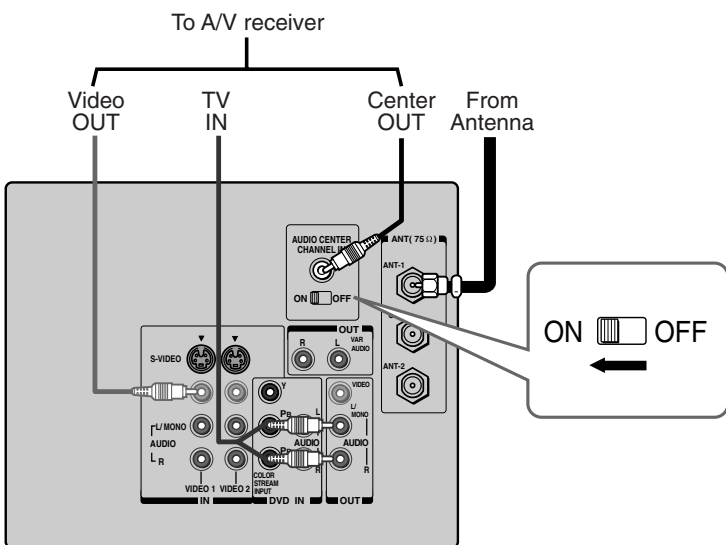

Caution:

To avoid damaging the speakers:

- Turn off the TV before connecting or disconnecting the Audio Center Channel cable.
- Do not connect from the A/V receiver's Center Speaker OUT (amplified signal) to the TV's Audio Center Channel IN.

Note:

Refer to the instructions provided with your A/V receiver for details about your surround sound system.

When the Audio Center Channel ON/OFF switch is ON, the TV speakers will function as center channel speakers only.

To adjust the center channel speaker volume, use the center level control on the A/V receiver.

To use the TV speakers as normal speakers, set the Audio Center Channel ON/OFF switch to the OFF position.

Connection example of Dolby Pro Logic surround system

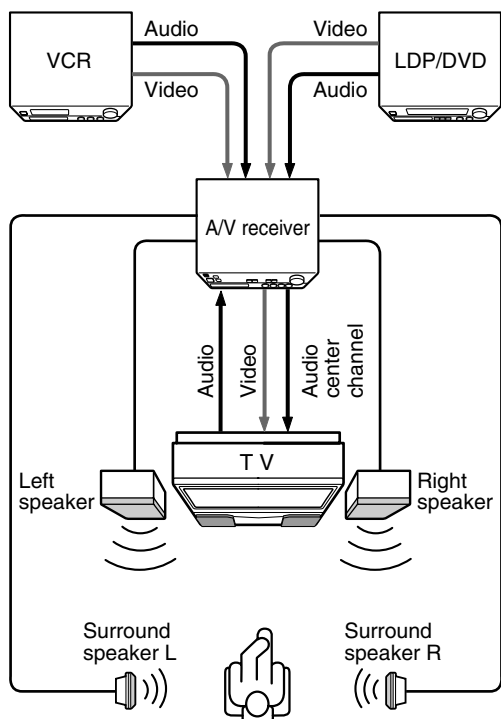

*"Dolby Pro Logic" is a trademark of Dolby Laboratories Licensing Corporation.

Using the remote control

Preparing the remote control for use

With the remote control, you can operate your TV, most VCR models, and cable TV converters together, even if they are different brands. If you will be using your TV with a Toshiba VCR, your remote control is already programmed and ready to use. If you own different brands of VCRs and/or converters, you first have to program your remote control. (See "Programming the remote control for use with a non-Toshiba VCR or a cable TV converter" on page 14.)

Installing the remote control batteries

To install the batteries:

1. Slide the battery cover off of the back of the remote control.

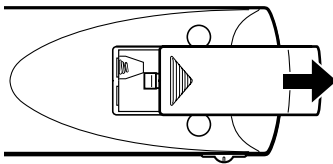

2. Install two "AA" size alkaline batteries. Match the + and - signs on the batteries to the signs on the battery compartment.

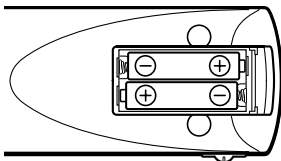

3. Slide the battery cover back on to the remote control until the lock snaps.

Using the remote control with a VCR or a cable TV converter

To control a VCR:

Set the TV/CABLE/VCR switch to the VCR position. The shaded buttons shown at right will control the VCR. The unshaded buttons will operate the TV as usual.

To control a cable TV converter:

Set the TV/CABLE/VCR switch to the CABLE position. The shaded buttons in the top part of the illustration at right will control the cable TV converter. The other buttons will operate the TV as usual.

If you own a non-Toshiba VCR or cable TV converter, see "Programming the remote control for use with a non-Toshiba VCR or a cable TV converter" on page 14.)

Note:

Your TV's remote control may or may not operate your VCR or cable TV converter.

Refer to the owner's manuals supplied with your other equipment to see which features are available. In addition, the original controllers may have features not available on this remote control. If you would like to continue to use these features, you may want to use the original remote control.

Caution:

- Dispose of batteries in a designated disposal area. Do not throw batteries into a fire.
- Do not mix battery types or combine used batteries with new ones.
- Remove dead batteries immediately to prevent battery acid from leaking into the battery compartment.
- If you do not intend to use the remote control for a long time, remove the batteries.

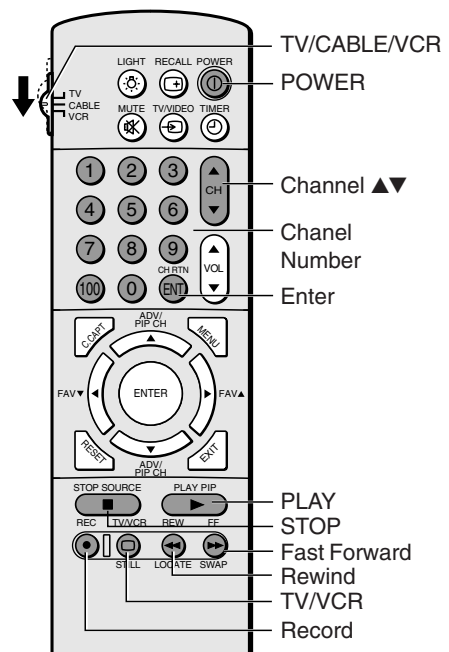

Programming the remote control for use with a non-Toshiba VCR or a cable TV converter

The TV remote control is preprogrammed to operate Toshiba VCRs and cable TV converters.

To use the remote control to operate a non-Toshiba VCR or cable converter:

1. Refer to the VCR and Cable TV converter code tables on pages 15–16 to find the corresponding code for your VCR or converter. If more than one code is listed, try each one separately until you find the one that works.
2. If you are programming the remote control to operate your:
 - **VCR**, set the TV/CABLE/VCR switch on the remote control to VCR.
 - **Cable converter**, set the TV/CABLE/VCR switch on the remote control to CABLE.
3. While holding down RECALL, press the Channel Number buttons (0–9) to enter the code for your brand of VCR or converter.
4. Point the remote control at the VCR or converter and press POWER to test the code.

If the VCR or converter responds, you have entered the correct code.

If the VCR or converter does not respond to the remote control, you may have entered the wrong code. Repeat steps 1–4 using another code.
5. To control the TV, set the TV/CABLE/VCR switch to TV.

For future reference, write down the codes you used:

VCR code _____

Cable TV converter code _____

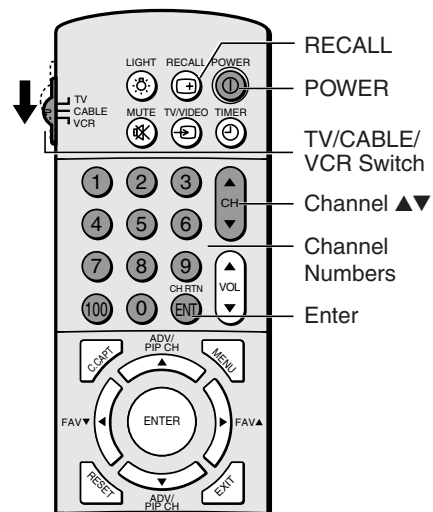

Note:

Every time you replace the batteries, you must reprogram the remote control.

Some newer VCRs are capable of working on either of two remote codes. These VCRs have a switch labeled "VCR1/VCR2." If your VCR has this kind of switch and does not respond to any of the codes for your VCR brand, set the switch to the other position (VCR1 or VCR2) and reprogram the remote control.

VCR code table

Brand name	Code number				
Adventura	019	Jensen	060	Quasar	054,096
Aiko	297	JVC	027,060,086	Radio Shack	019,056,344
Aiwa	019	Kenwood	057,060,086	Radix	056
Akai	060,068,080,125, 261	KLH	091	Randex	056
American High	054	Kodak	054,056	RCA	061,079,084,096, 124,125,168,221
Asha	259	Lloyd	019	Realistic	019,054,056,065, 066,067,081,085, 123,259
Audiovox	056	Lloyd's	227	Ricoh	053
Beaumark	259	Logik	091	Runco	058
Bell & Howell	123	LXI	056	Samsung	064,259
Brandt	206	Magnavox	054,058,100,129, 168	Sanky	058,067
Broksonic	140,203,230,314, 380	Magnin	259	Sansui	060,086
Calix	056	Marantz	054,100	Sanyo	065,066,123,259
Canon	054	Marta	056	Scott	062,064,140,203, 229,230,231
Capehart	039	Masushita	054	Sears	054,056,061,065, 066,073,085,123, 124
Carver	100	MEI	054	Sharp	067,081
CCE	091,297	Memorex	019,054,056,058, 065,066,067,123, 259	Shintom	091
Citizen	056,297	MGA	062,080	Shogun	259
Colt	091	MGN Technology	259	Singer	091
Craig	056,066,091,259	Minolta	061,124	Sony	051,052,053,054
Curtis Mathes	054,060,079	Mitsubishi	062,080,086,094, 192,233,261	STS	061
Cybernex	259	Motorola	054,067	Sylvania	019,054,062,100, 129
Daewoo	039,064,297	MTC	019,259	Symphonic	019,344
Daytron	039	Multitech	019,091	Tatung	060
Dynatech	019	Nad	077	Teac	019,060
Electrohome	056	NEC	057,059,060,069, 086	Technics	054,181
Electroponic	056	Nikko	056	Teknika	019,054,056,071
Emerex	051	Noblex	259	Telefunken	060,206
Emerson	019,021,056,062, 080,087,140,203, 227,228,230,231, 297,313,314,380, 498	Olympus	054	TMK	227,259
Fisher	066,073,085,123	Optimus	056,067,077,123	Toshiba	062,064,085,229, 231,385
Fuji	052,054	Optonica	081	Totevision	056,259
Funai	019,344	Orion	498	Unitech	259
Garrard	019,344	Panasonic	054,096,181,244	Vector	064
GE	054,079,084,221	Penney	054,056,057,059, 061,073,259	Vector Research	057,059
Go Video	251,298	Pentax	061,084,124	Video Concepts	059,064,080
Goldstar	037,056,057	Philco	054	Videosonic	259
Gradiente	019	Philips	054,081,100,129	Wards	019,054,061,066, 067,081,091,168, 231,259
Harley Davidson	019	Pilot	056	XR-1000	019,054,091
Harman/Kardon	057,094	Pioneer	077,086	Yamaha	057
Harwood	087,091	Portland	039	Zenith	052,053,058
Headquarter	065	Protec	091		
HI-Q	066	Pulsar	058		
Hitachi	060,061,084,124, 254	Quarter	065		
		Quartz	065		

Cable TV converter code table

Brand name	Code number		
ABC	020,022,026,027, 030,032,033,036, 066	Samsung	059,163
Antronix	041	Scientific Atlanta	025,027,036,296
Archer	041,058,172	Signal	034,059
Belcor	075	Signature	030
Cable Star	075	SL Marx	059
Cabletenna	041	Sprucer	040
Cableview	041	Standard	
Century	172	Components	174
Citizen	172	Starcom	022,034,066
Colour Voice	044,050	Stargate	034,059
Comtronics	059,079	Starquest	034
Contec	038	Sylvania	020
Dae Ryung	027	Teleview	059
Eastern	021	Texscan	020
Focus	419	Tocom	031,032,078
Garrard	172	Toshiba	019
GC Electronics	035,075	Tusa	034
Gemini	034,089	Unika	041,172
General Instrument	030,295	United Artists	026
GoldStar	059,163	United Cable	022
Hamlin	028,039,053,278, 292	Universal	041,058,075,096, 172,210
Hitachi	030	Viewstar	046,079,230
Hytex	026	Zenith	019
Jasco	172	Zentek	419
Jerrold	022,030,031,033, 034,043,066,295		
Macom	052		
Magnavox	046		
Memorex	019		
Movie Time	175		
NSC	089,175		
Oak	026,038,267		
Panasonic	019,040,126		
Paragon	019		
Philips	044,046,047,048, 049,050,172		
Pioneer	042,163,552		
Popular Mechanics	419		
Pulsar	019		
RCA	040		
Recoton	419		
Regal	039,278,292		
Regency	021		
Rembrandt	030,089		
Runco	019		

Learning about the remote control

POWER turns the TV on and off (pages 14, 38)

TIMER sets the TV to turn off automatically (page 38)

RECALL displays time, status, channel, and rating information on-screen (page 44)

TV/VIDEO selects the video input source (page 36)

MUTE turns off the sound (page 39)

LIGHT back-lights the remote control keys for 5 seconds

TV/CABLE/VCR switches between TV, Cable, and VCR modes (page 14)

Channel ▲▼ cycles through programmed channels (page 21)

Channel Numbers (0–9, 100) allow direct access to channels (page 21)

Volume ▲▼ adjusts the volume level

CH RTN returns to the last viewed channel (page 23)

ENT required by some VCRs and Cable TV converters to change the channel number

C.CAPT turns closed captioning on and off (page 37)

MENU accesses programming menus (page 18)

ENTER sets programmed menu information (pages 18, 22-25)

▲▼◀▶ selects or adjusts programming menus (page 18)

PIP Channel ▲▼ cycles through PIP channels (pages 26, 27)

RESET resets the picture and audio adjustments to the factory settings (pages 35, 41)

FAV ▼▲ cycles through your favorite channels (page 23)

EXIT exits programming menus (page 18)

PIP Buttons access PIP functions (pages 26, 27)

SOURCE selects the PIP signal source

PIP turns the PIP on and off

STILL freezes the PIP

LOCATE changes the position of the PIP

SWAP switches the main and PIP pictures

VCR Buttons allow access to VCR functions (play, stop, record, fast forward, rewind) (page 14)

TV/VCR toggles between the TV and VCR when viewing while recording

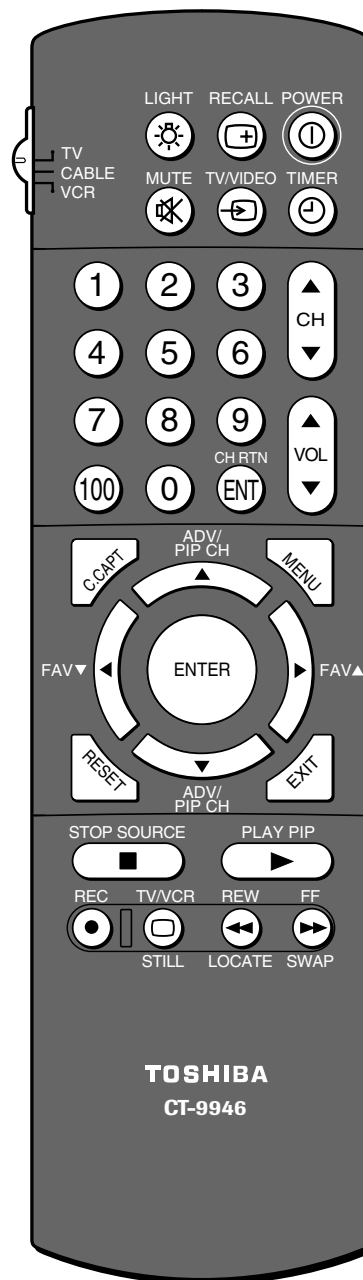

Setting up your TV

After you have installed the batteries and programmed the remote control, you need to set some preferences on the TV using the menu system. You can access the menus using the buttons on the TV or remote control.

1. Press MENU to display the menu system.
2. Press ◀ or ▶ to select a menu.
3. Press ▲ or ▼ to select an item.
4. Press ◀ or ▶ to select or adjust a setting.
5. Press ENTER to activate your setting adjustments. If you do not press ENTER, the menu will close automatically within a maximum of 15 seconds, except the Convergence, Clock Set, and Timer menus, which remain on-screen until a button is pressed.
6. Press EXIT to close an on-screen display instantly.

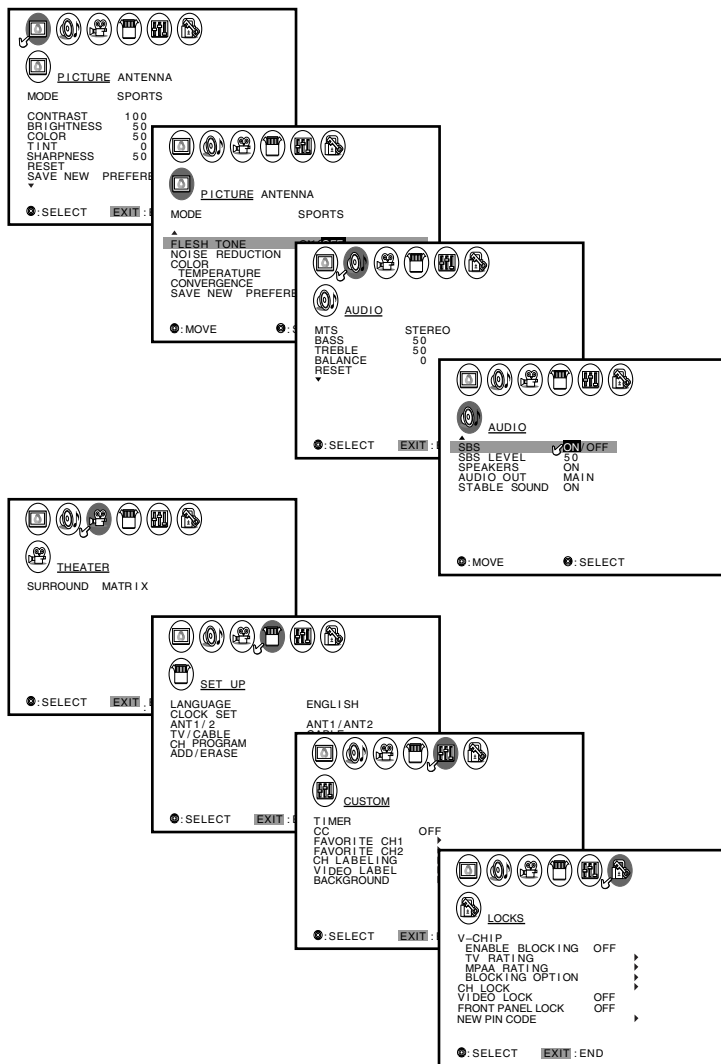
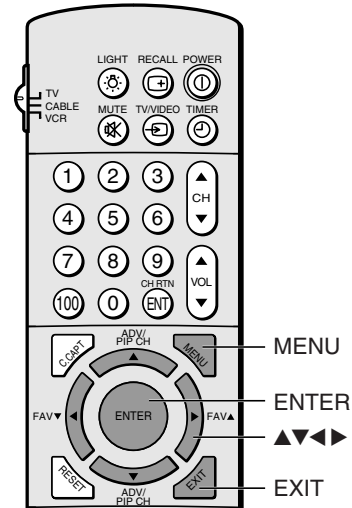
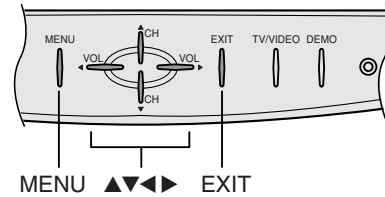

Note:
To change the menu background, see page 44.

Changing the on-screen display language

You can choose from three different languages (English, French and Spanish) for the on-screen display of adjustment menus and messages.

To select an on-screen display language:

1. Press MENU, and then press ◀ or ▶ until the SET UP menu appears.
2. Press ▲ or ▼ to highlight LANGUAGE.

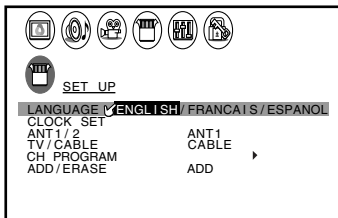

3. Press ◀ or ▶ to highlight your desired language.

Selecting the antenna input

You can connect to two different signal sources by choosing the antenna input (ANT 1 or ANT 2).

To select the antenna input using the menu system:

1. Press MENU, then use ◀ or ▶ to highlight the SET UP menu.
2. Press ▲ or ▼ to highlight ANT 1/2.

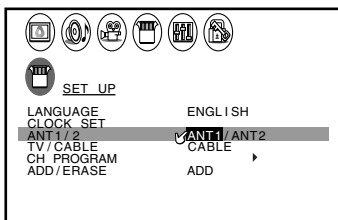

3. Press ◀ or ▶ to highlight either ANT 1 or ANT 2, depending on the antenna terminal you wish to use.

To select the antenna input using the TV/VIDEO button:

Press TV/VIDEO on the remote control or TV (see illustrations below) to highlight either ANT 1 or ANT 2, depending on the antenna terminal you wish to use. The current signal source displays in purple.

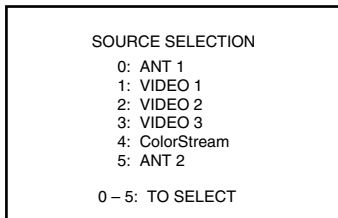

Pressing TV/VIDEO on the remote control displays this screen. To select, press 0-5.

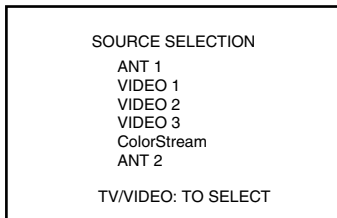

Pressing TV/VIDEO on the TV displays this screen. To select, press TV/VIDEO.

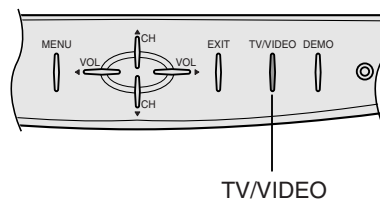
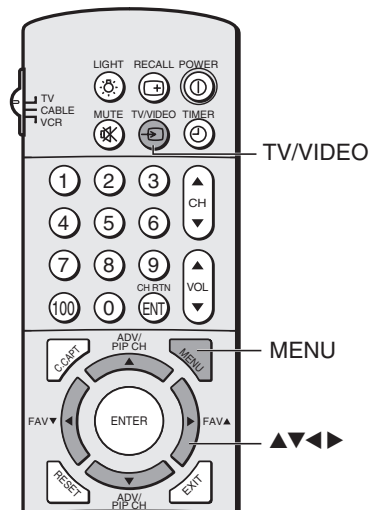

Adding channels to the TV's memory

When you press Channel ▲ or ▼, your TV will stop only on the channels stored in the TV's channel memory. Follow the steps below and on the next page to program channels into the TV's memory.

Programming channels automatically

Your TV can automatically detect all active channels and store them in its memory. After the TV has stored the channels in its memory, you can erase channels or add your favorite channels. If you use both ANT-1 and ANT-2 terminals, you must program channels for each input source.

To program channels automatically:

1. Press MENU, and then press ◀ or ▶ until the SET UP menu appears.
2. Press ▲ or ▼ until TV/CABLE is highlighted.
3. Press ◀ or ▶ to highlight either TV or CABLE, depending on which you use. If you use an antenna, highlight TV; if you use cable, highlight CABLE.

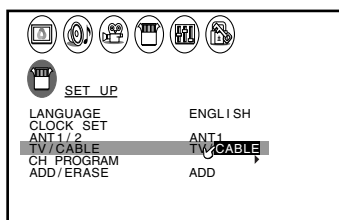

4. Press ▼ to select CH PROGRAM.

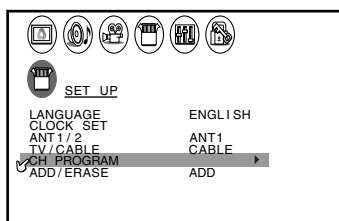

5. Press ◀ or ▶ to start channel programming. The TV will automatically cycle through all the TV or Cable channels (depending on which you selected), and store all active channels in the channel memory.

While the TV is cycling through the channels, the message "Programming Now—Please Wait" appears.

6. When channel programming is complete, the message "Completed" appears.
7. Press Channel ▲▼ to view the programmed channels.

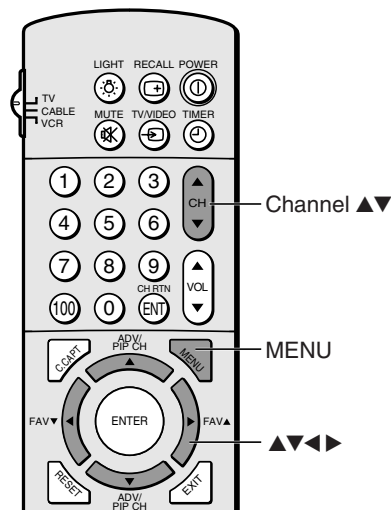

Adding and erasing channels manually

After you have programmed the channels automatically, you can manually add and erase specific channels.

To manually add or erase channels:

1. Select the channel you want to add or erase. If you are adding a channel, you must select the channel using the Channel Number buttons.
2. Press MENU, and then press ◀ or ▶ until the SET UP menu appears.
3. Press ▲ or ▼ to highlight ADD/ERASE.

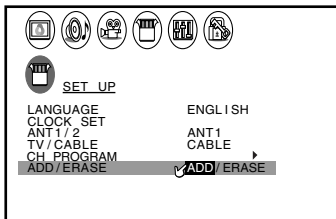

4. Press ◀ or ▶ to select Add or Erase, depending on the function you want to perform.
5. Repeat steps 1–4 for other channels you want to add or erase.

Changing channels

To change to the next programmed channel:

Press Channel ▲ or ▼ on the TV or remote control.

To change to a specific channel (programmed or unprogrammed):

Press the Channel Number buttons (0–9 and 100).

For channels 100 and higher, press 100 and the next two numbers. For example, to select channel 100, press 100, 0, 0. To select channel 125, press 100, 2, 5.

Changing channels using SpeedSurf

To use SpeedSurf to change to a specific programmed channel:

While no menu is on-screen, press and hold Channel ▲ or ▼ for about one second. The TV will enter SpeedSurf mode.

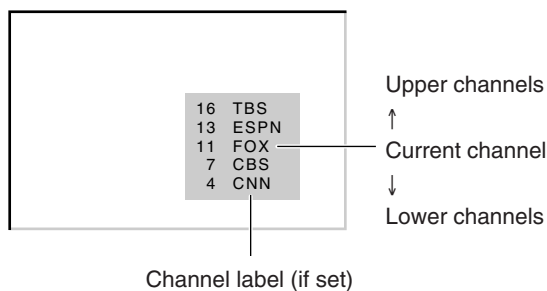

Repeatedly press or hold Channel ▲ or ▼ while the SpeedSurf mode is on-screen to scroll the channel list. Release the button to display the highlighted channel.

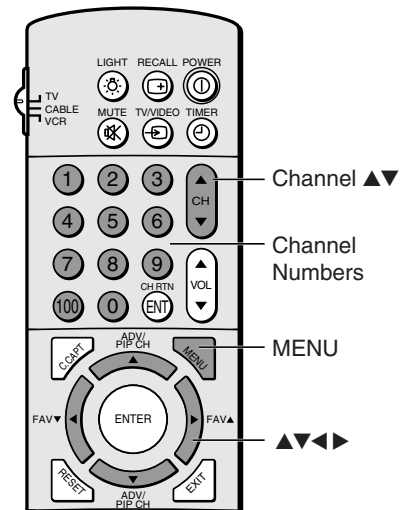

Adjusting the color convergence

This projection TV uses three separate TV tubes: red, green, and blue. The red, green, and blue images are projected onto the screen where they converge to form a full-color picture. You can see a clear picture only when the three images converge correctly. Convergence can drift over time or if you move the TV. If you can see clear images on your TV screen, skip this procedure.

Make this adjustment only after the TV has been on for at least 30 minutes.

To check and adjust the color convergence:

1. Press MENU, and then press ◀ or ▶ until the PICTURE menu appears.
2. Press ▲ or ▼ to highlight CONVERGENCE.

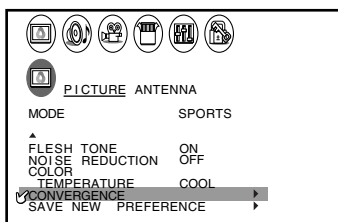

3. Press ◀ or ▶ to display the center convergence menu.

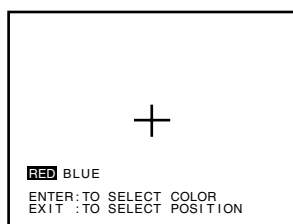

If you see separate color lines (red, blue, and green or white), you need to adjust the convergence.

4. Press ENTER to highlight RED or BLUE.
5. Press ▲ (up), ▼ (down), ◀ (left), or ▶ (right) to converge the red or blue line into the green (or white) line. When the convergence is adjusted correctly, you will see two single, crossed white lines.
6. Press EXIT to display the circumference convergence menu.
7. Press the corresponding Number button (1–4 and 6–9) to select the area of the screen you want to adjust.
8. Press ENTER to highlight RED or BLUE.

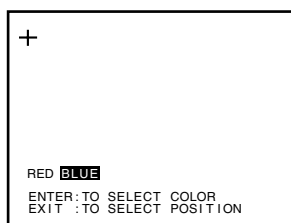
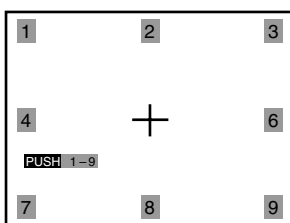

9. Press ▲▼◀▶ to converge the red or blue line into the green (or white) line.

Repeat steps 8 and 9 until you see two single, crossed white lines.

10. Press EXIT once to select another area to adjust in the circumference convergence menu, and then repeat steps 7–9.
11. Press EXIT twice to close the convergence menus.

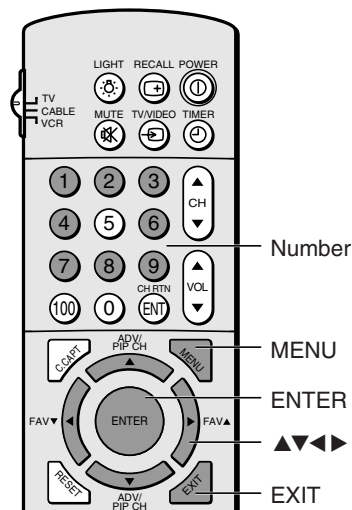

Using the TV's features

Adjusting the channel settings

Switching between two channels

You can switch between two channels without entering an actual channel number each time.

To switch between two channels:

1. Select the first channel you want to view.
2. Select a second channel with the Channel Number buttons (0-9, 100).
3. Press CH RTN. The previous channel will be displayed.

Each time you press CH RTN, the TV will switch back and forth between the two channels.

Programming your favorite channels

You can preset up to 9 of your favorite channels each for FAVORITE CH1 and FAVORITE CH2 modes using the Favorite Channel Programming feature. Because this feature scans through only your favorite channels, it allows you to skip other channels you do not normally watch.

You can still use Channel ▲▼ to scan through all the channels you programmed in the TV's memory.

To program your favorite channels:

1. Press MENU, then press ◀ or ▶ until the CUSTOM menu appears.
2. Press ▲ or ▼ to highlight FAVORITE CH1 (or FAVORITE CH2).

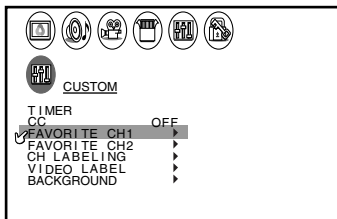

3. Press ◀ or ▶ to display the FAVORITE CH1 (or FAVORITE CH2) menu.

CH INPUT will be highlighted.

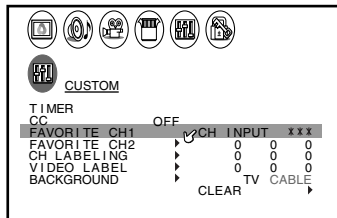

4. Press the Channel Number buttons to enter one of your favorite channels.
5. Press ENTER.
6. Repeat steps 4 and 5 for other channels.

To select your favorite channels:

Press FAV ▼ or ▲.

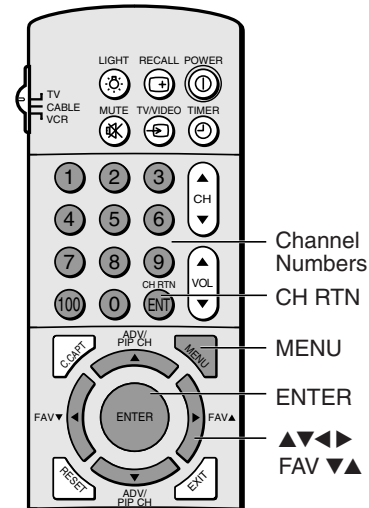

Note:

The FAV ▼▲ buttons will not function until you have programmed your favorite channels.

To clear your favorite channels:

1. Press MENU, and then press ◀ or ▶ until the CUSTOM menu appears.
2. Press ▲ or ▼ to highlight FAVORITE CH1 (or FAVORITE CH2).
3. Press ◀ or ▶ to display the FAVORITE CH1 (or FAVORITE CH2) menu.

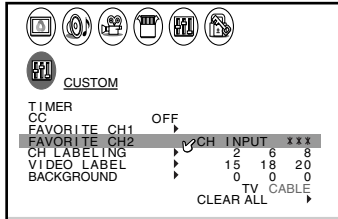

4. Press ▲ or ▼ to highlight CLEAR ALL, and then press ▶ or ◀ until "0" replaces the channel numbers you have programmed.

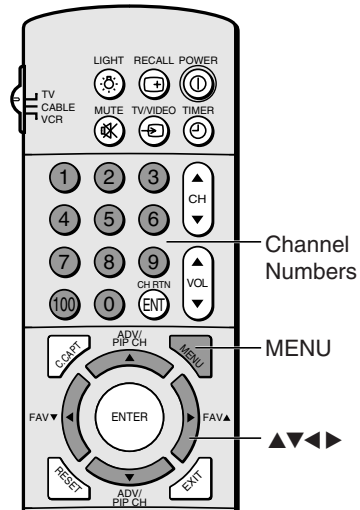
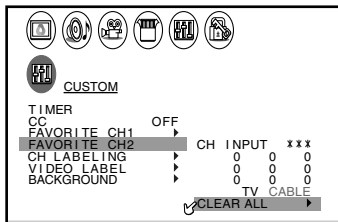

Labeling channels

Channel labels appear above the channel number display each time you turn on the TV, select a channel, or press RECALL. You can choose any four characters to identify a channel.

To create channel labels:

1. Press MENU, and then press ◀ or ▶ until the CUSTOM menu appears.
2. Press ▲ or ▼ to highlight CH LABELING.
3. Press ◀ or ▶ to display the CH LABELING menu.
CH INPUT will be highlighted.

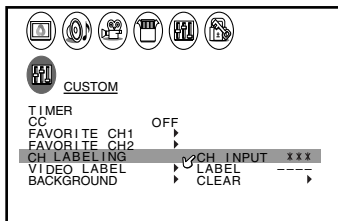

4. Press the Channel Number buttons to select the channel you want to label.

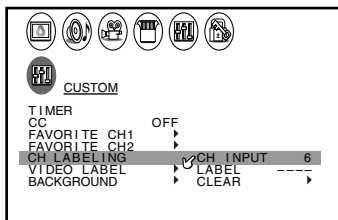

- Press ▼ to highlight LABEL.
- Repeatedly press ◀ or ▶ to select a character for the first space, and then press ENTER. If you want a blank space in the label name, you must select an empty space from the list of characters; otherwise, a dash will appear in that space.

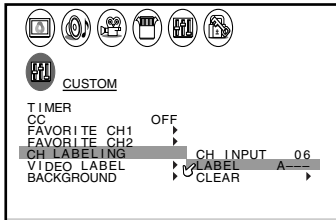

- Repeat step 6 to enter the rest of the characters.
- Repeat steps 4–6 for other channels. You can assign labels to a maximum of 32 channels.

To erase channel labels:

- Press MENU, and then press ◀ or ▶ until the CUSTOM menu appears.
- Press ▲ or ▼ to highlight CH LABELING.
- Press ◀ or ▶ to display the CH LABELING menu.
- Press ▼ to highlight CH INPUT, and then select the channel you want to clear with the Channel Number buttons.
- Press ▼ to highlight CLEAR.

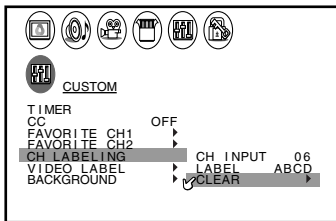

- Press ◀ or ▶ to erase the channel label.
- Repeat steps 4–6 to erase other channel labels.

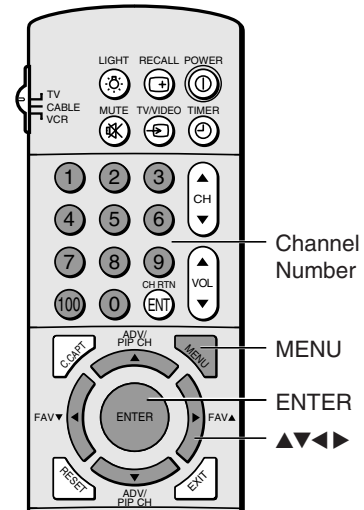

Watching picture-in-picture (PIP)

The picture-in-picture (PIP) feature allows you to watch two pictures at the same time. The smaller picture can come from a TV broadcast or an external source, such as a VCR.

To display a TV broadcast as a small picture:

1. Turn on the TV and select the program you want to watch.
2. Press PIP once to display a small picture. A window 1/9 the size of the screen will appear. Press PIP a second time to display a 1/16 size window.

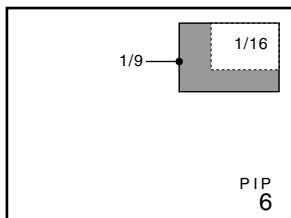

3. Press PIP CH ▲▼ to choose the program you want to be displayed as a small picture.

If the V-CHIP feature is active and you try to watch a TV program that exceeds the rating limits you set, the TV will enter into the program block mode. See “Using the V-CHIP menu” on page 29.

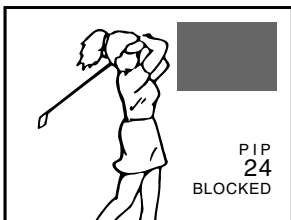

To display a picture from an external source as a small picture:

1. Make sure you have connected the external source equipment properly. For more information, see “Connecting your TV” on page 7.
2. Turn on the TV and select the program you want to watch.
3. Press PIP once to display a small picture. A window 1/9 the size of the screen will appear. Press PIP a second time to display a 1/16 size window.
4. Press SOURCE repeatedly to select the input source (VIDEO 1, VIDEO 2 or VIDEO 3) for the small picture. The selected source will be displayed in purple. ColorStream cannot be selected.

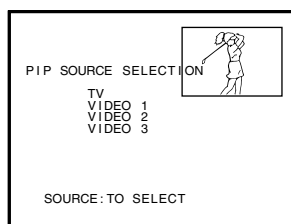

To turn PIP off:

Press PIP once or twice, depending on the size of the small picture screen you selected.

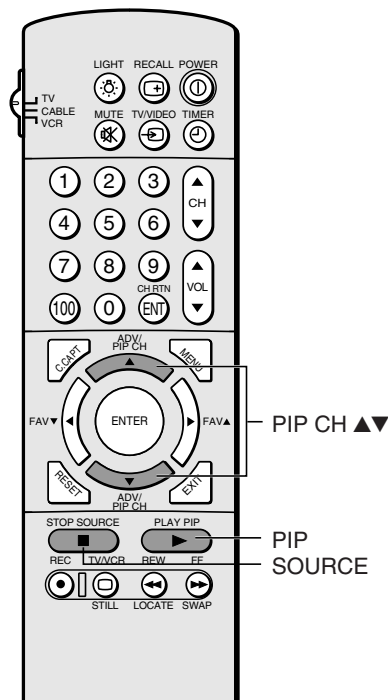

Note:

PIP cannot be turned on when ColorStream input is being viewed.

You cannot display the signal sources input through the ANT-2 terminal in the PIP window.

You can choose to hear the sound of either the PIP or main picture (see “Selecting the audio OUT sound” on page 43).

NOTICE OF POSSIBLE ADVERSE EFFECTS ON TV PICTURE TUBE

Avoid displaying stationary images on your TV screen for extended periods of time. Fixed (non-moving) images can become permanently engrained in the picture tube. **This type of damage is NOT COVERED BY YOUR WARRANTY because it is the result of misuse.** See item 32 on page 4.

Switching the main and small pictures

Press SWAP while you are using the PIP feature to switch the main and small pictures. The main and small pictures will switch each time you press the SWAP button.

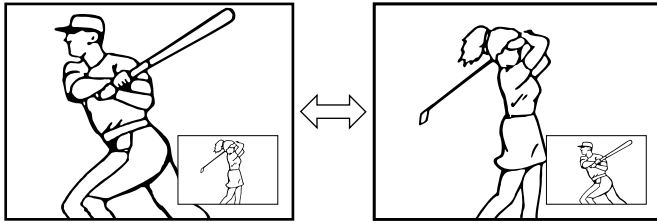

Changing the position of the small picture

Press LOCATE repeatedly while you are watching a small picture. The display position of the small picture will change in the following order:

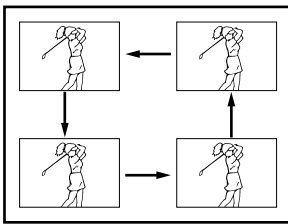

Freezing the small picture

Press STILL while you are watching a small picture. The small picture will become a still picture. To return to the moving picture, press STILL again.

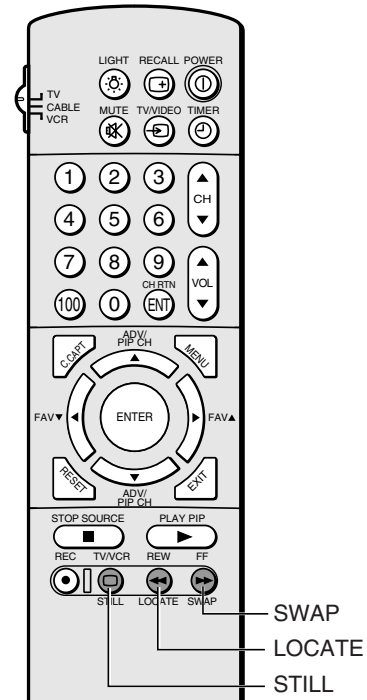
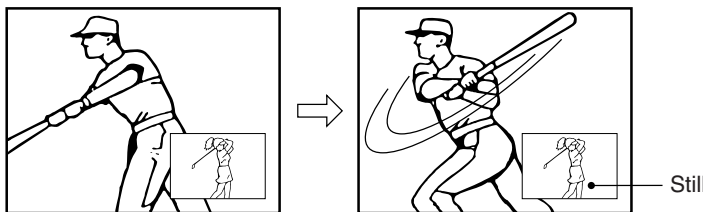

NOTICE OF POSSIBLE ADVERSE EFFECTS ON TV PICTURE TUBE

Avoid displaying stationary images on your TV screen for extended periods of time. Fixed (non-moving) images can become permanently engrained in the picture tube. **This type of damage is NOT COVERED BY YOUR WARRANTY because it is the result of misuse.** See item 32 on page 4.

Using the LOCKS menu

The LOCKS menu includes the V-chip, CH (channel) Lock, Video Lock, and New PIN Code functions. You can use these functions only after entering the correct PIN code.

Entering the PIN code

1. Press MENU, and then press ◀ or ▶ until the LOCKS menu appears.

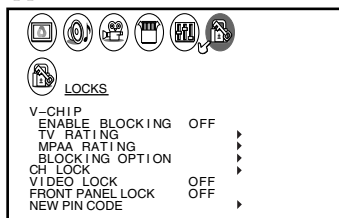

- Blocking reset status (to store a new PIN code):
Press the Channel Number buttons (0–9) to store a new 4-digit PIN code, and then press ENTER.
- When the PIN code is already stored:
Press the Channel Number buttons (0–9) to enter the PIN code you previously stored, and then press ENTER.

2. Press ▲ or ▼ to display the PIN code entering screen.



If the wrong PIN code is entered, the message “Incorrect” appears. Enter the code again, and then press ENTER.

If you cannot remember your PIN code

While the PIN code entering screen is displayed, press RECALL four times within 5 seconds. The PIN code will be released (blocking reset status).

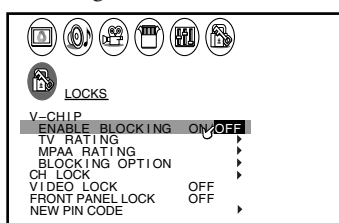

Continue to set each item following the steps on the next page.

Changing the PIN code

1. From the LOCKS menu, select NEW PIN CODE.
2. Press the Channel Number buttons (0–9) to enter a 4-digit code. The numbers you enter will replace the dashes in the display.

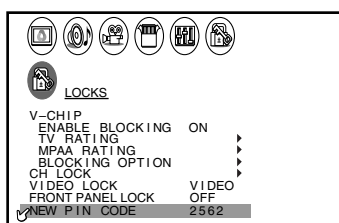

Note:

The V-Chip function is available only for the U.S. V-Chip system. The Canadian V-Chip system is not supported.

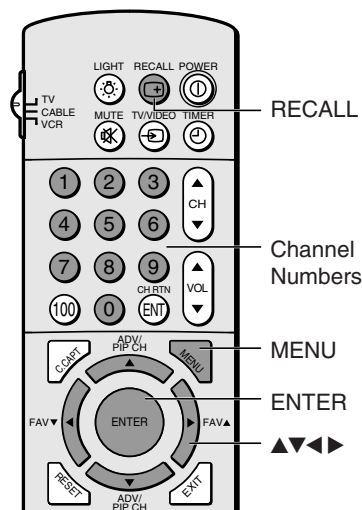

Using the V-CHIP menu

Some TV programs and movies include signals that classify the content of the program (violence, sex, dialog, language). The V-CHIP control feature in this TV detects the signals and blocks the programs according to your selections. To use this feature, perform the following setup.

ENABLE BLOCKING

1. From the LOCKS menu, select ENABLE BLOCKING.
2. Press ◀ or ▶ to select ON or OFF.
ON : To enable your settings (locks)
OFF: To release your settings (unlocks)

Note: The CH LOCK function is not affected by this selection.

TV RATING (Independent rating system for broadcasters)

1. From the LOCKS menu, select TV RATING.
2. Press ◀ or ▶ to display the TV RATING menu.

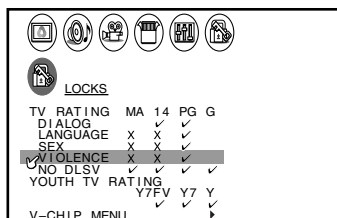
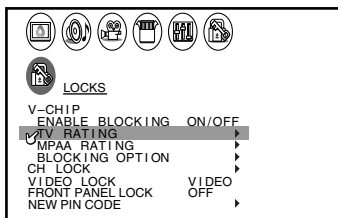

3. Press ▼ or ▲ to select an item.
4. Press ▶ to lock (displays X)
Press ◀ to unlock (displays ✓)
5. Repeat steps 3 and 4 to set the next item.

The TV age-based ratings and content themes you can lock are listed in the table below.

Ratings	Description and Content themes
MA	Mature Audience Only (This program is specifically designed to be viewed by adults and therefore may be unsuitable for children under 17.) L) Crude or indecent language S) Explicit sexual activity V) Graphic violence
14	Parents Strongly Cautioned (This program contains some material that many parents would find unsuitable for children under 14 years of age.) D) Intensely suggestive dialog L) Strong, coarse language S) Intense sexual situations V) Intense violence
PG	Parental Guidance Suggested (This program contains material that parents may find unsuitable for younger children.) D) Some suggestive dialog L) Infrequent coarse language S) Some sexual situations V) Moderate violence
G	General Audience (Most parents would find this program suitable for all ages.)
Y7, Y7FV	Directed to Older Children (This program is designed for children age 7 and above. Note: Programs in which fantasy violence is more intense or more combative than other programs in this category are designated Y7FV.)
Y	All Children (This program is designed to be appropriate for all children)

Note:

The V-Chip function is available only for the U.S. V-Chip system. The Canadian V-Chip system is not supported.

LOCKS menu

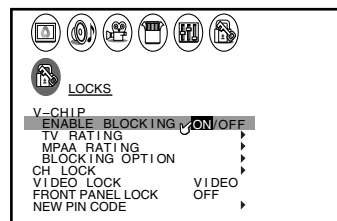

To select each item:

Press ▼ or ▲.

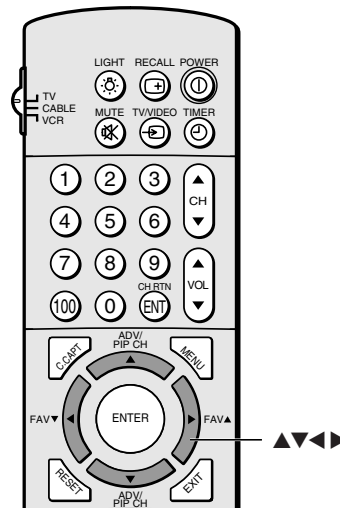

Press RECALL to display the rating of the current TV program.

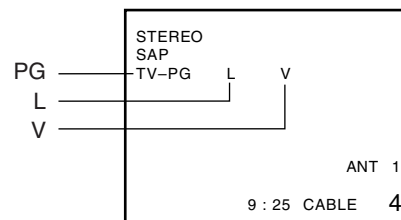

MPAA RATING (Independent rating system for movies)

1. From the LOCKS menu, select MPAA RATING.
2. Press ◀ or ▶ to display the MPAA RATING menu.
3. Press ▼ or ▲ to highlight MPAA RATING, and then press ◀ or ▶ to display the MPAA ratings.
4. Press ▶ to lock ("X") or ◀ to unlock ("✓").

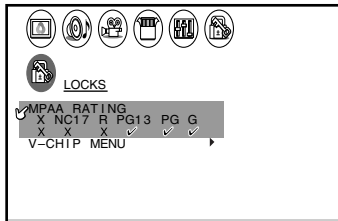

LOCKS menu

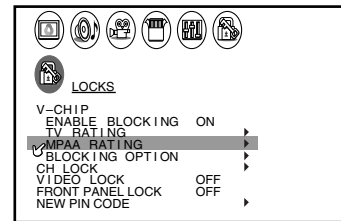

To select each item:
Press ▼ or ▲.

The movie ratings you can lock are described as follows:

- X : X-rated (For adults only)
- NC17: Not intended for anyone 17 and under
- R : Restricted (Under 17 requires accompanying parent or adult guardian.)
- PG13 : Parents Strongly Cautioned (Some material may be inappropriate for children under 13)
- PG : Parental Guidance Suggested (Some material may not be suitable for children)
- G : General Audience (Appropriate for all ages)

BLOCKING OPTION

1. From the LOCKS menu, select BLOCKING OPTION.
2. Press ◀ or ▶ to display the BLOCKING OPTION menu, and then press ▲ or ▼ to select an item, as described below:

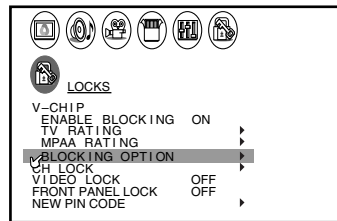

MPAA UNRATED:

Press ◀ or ▶ to select ON (locked) or OFF (unlocked) for unrated programs in the MPAA rating system.

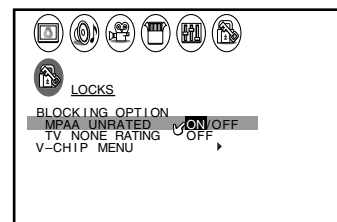

TV NONE RATING:

Press ◀ or ▶ to select ON (locked) or OFF (unlocked) for programs rated NONE in the TV PARENTAL GUIDELINES.

Note: The PIP is not locked even if ON is selected.

If you select ON, the note shown in the screen graphic below will be displayed, since emergency information may also be blocked.

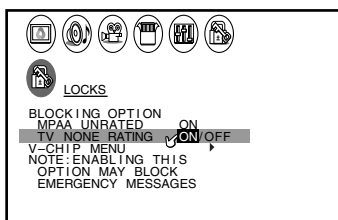

V-CHIP MENU:

Press ◀ or ▶ to return to the LOCKS menu.

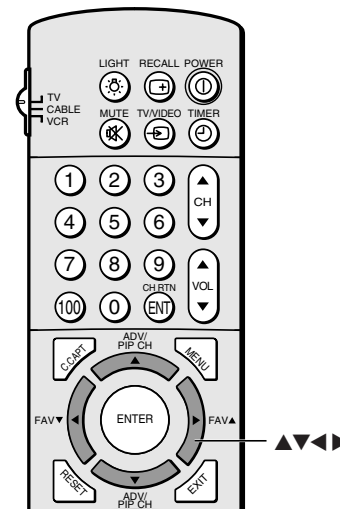

Unlocking programs temporarily

1. If you try to watch a TV program that exceeds the rating limits you set, the TV will enter into the program lock mode.

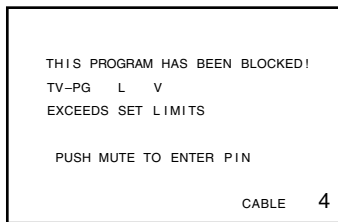

2. If you want to watch the locked program temporarily, press MUTE.
3. Press the Channel Number buttons (0–9) to enter the 4-digit PIN code you stored (see “Entering the PIN code” on page 28).

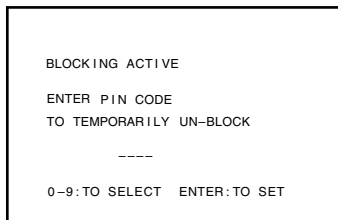

4. Press ENTER.

If the correct code is entered, the lock mode will be released and the normal picture will appear.

All locking is disabled until the TV is turned off, and will be enabled the next time the TV is turned on.

If the wrong PIN code is entered, the message “Incorrect PIN code” appears. Enter the code again.

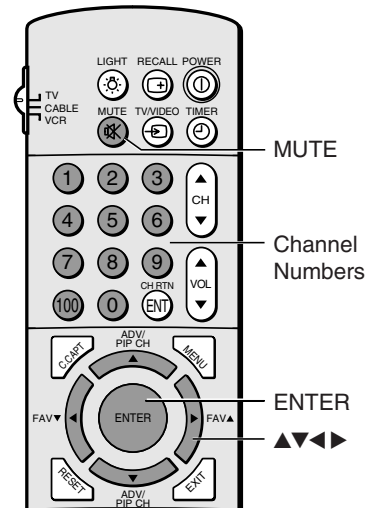

Locking channels

With the CH LOCK feature, you can lock specific channels. You will not be able to tune locked channels using the Channel ▲▼ or Channel Number buttons unless you clear the setting.

You can lock a maximum of 8 channels.

Note: The CH LOCK feature is not affected by the ENABLE BLOCKING setting (page 29).

To lock channels:

1. From the LOCKS menu, select CH LOCK.
2. Press ◀ or ▶ to display the CH LOCK menu.
3. Press the Channel Number buttons to enter the channel you want to lock.

Note: You cannot lock the current channel.

4. Press ENTER.

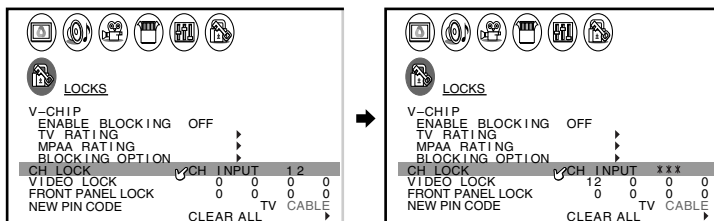

5. Repeat steps 3 and 4 for other channels.

(Continued on next page)

LOCKS menu

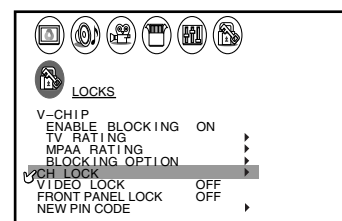

To select each item:

Press ▼ or ▲.

To unlock channels:

(You cannot unlock individual channels.)

1. From the LOCKS menu, select CH LOCK.
2. Press ◀ or ▶ to display the CH LOCK menu.
3. Press ▲ or ▼ to highlight CLEAR ALL.
4. Press ◀ or ▶ until "0" replaces the channel numbers you have locked.

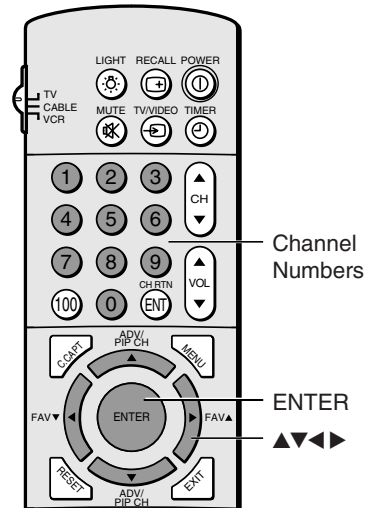
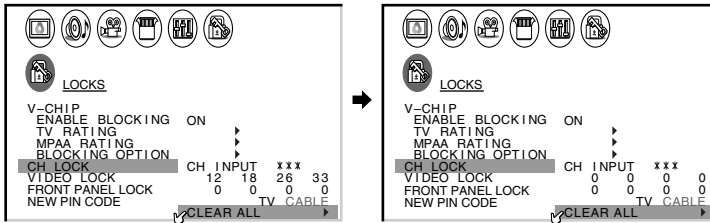

Locking video inputs

Use the VIDEO LOCK feature to lock the video inputs. With the video inputs locked, you cannot select the input sources using the TV/VIDEO button unless Video Lock is OFF.

To lock the video inputs:

1. From the LOCKS menu, select VIDEO LOCK.
2. Press ◀ or ▶ to highlight the level of video locking you want.
VIDEO: Locks the video inputs (VIDEO1, VIDEO2, VIDEO3, and ColorStream)
VIDEO+: Locks the video inputs and channels 3 and 4 (if you use the antenna terminal to play a videotape)
Note: Make sure the PIP is not on channel 3 or 4.
OFF: Unlocks all video inputs.

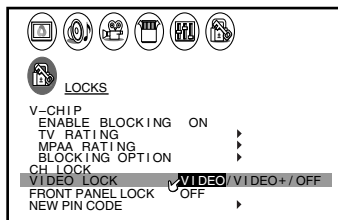

Locking the front panel buttons

Use the front panel lock feature to lock the buttons on the front panel of the TV to prevent accidental use (by children, for example). All buttons on the front panel, except POWER, are locked.

To lock the front panel buttons:

1. From the LOCKS menu, select FRONT PANEL LOCK.
2. Press ◀ or ▶ to highlight ON.

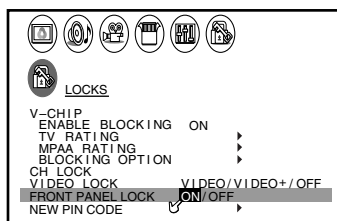

To unlock the front panel buttons:

Select OFF in step 2 above.

Adjusting the picture

Selecting the picture modes

Select your desired picture type from the following picture modes: Sports, Standard, Movie, and Preference.

Mode	Picture Quality
Sports	Bright and dynamic picture (factory set; reset default)
Standard	Standard picture setting (factory set)
Movie	Movie-like picture setting (factory set)
Preference	Your personal preferences*

*(see "Saving new preferences" on page 34.)

To select a picture mode:

1. Press MENU, and then press ◀ or ▶ until the PICTURE menu appears.
2. Press ▼ or ▲ to highlight MODE.
3. Press ◀ or ▶ to highlight the mode you prefer.

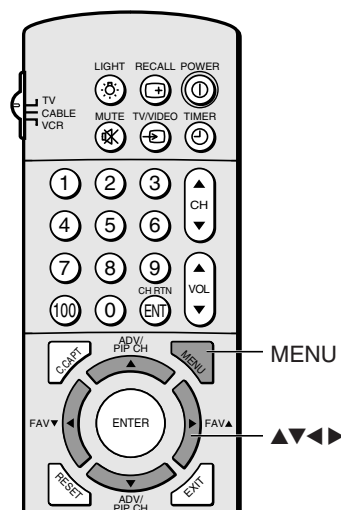
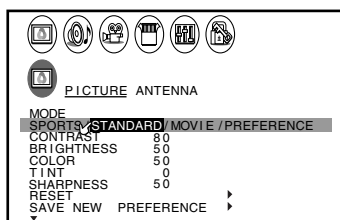

Adjusting the picture quality

You can adjust the picture quality to your personal preferences, including the contrast, brightness, color, tint, sharpness, flesh tone, noise reduction, and color temperature.

Selection	◀ Pressing	▶ Pressing
Contrast	lower	higher
Brightness	darker	lighter
Color	paler	deeper
Tint	reddish	greenish
Sharpness	softer	sharper

To adjust the picture quality:

1. Press MENU, and then press ◀ or ▶ until the PICTURE menu appears.
2. Press ▼ or ▲ to highlight the quality you want to adjust.
3. Press ◀ or ▶ to adjust the level.

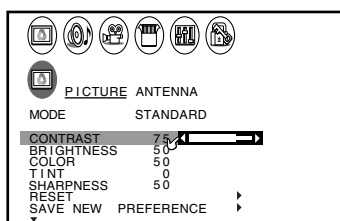

The PICTURE qualities you adjusted can be saved in the TV's memory with the Save New Preference feature (see page 34). You can select your preferences or one of the factory set modes (as described in "Selecting the picture mode" above).

Note:

If you select one of the factory-set picture modes (SPORTS, STANDARD, or MOVIE), and then change a picture quality setting (for example, increase the contrast), the picture mode automatically changes to PREFERENCE in the Picture menu.

To save your new picture quality settings, you must select SAVE NEW PREFERENCE (see page 34) before closing the Picture menu or the TV will return to the previous picture mode.

Saving new preferences

You can save the PICTURE qualities (contrast, brightness, color, tint, and sharpness) you adjusted in the Picture PREFERENCE mode.

To save your new preferences:

1. Press MENU, and then press ◀ or ▶ until the PICTURE menu appears.
2. Press ▲ or ▼ to highlight SAVE NEW PREFERENCE.
3. Press ◀ or ▶. When saved, the menu displays "DONE."

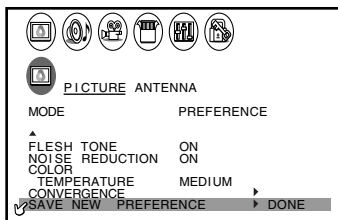

You can choose your saved preferences by selecting PREFERENCE in the picture mode (see "Selecting the picture mode" on page 33).

Using the flesh tone feature

This feature corrects the differences in tint among TV stations, to make flesh tones appear more natural on your TV screen.

To turn on the flesh tone feature:

1. Press MENU, and then press ◀ or ▶ until the PICTURE menu appears.
2. Press ▲ or ▼ to highlight FLESH TONE.
3. Press ◀ or ▶ to highlight ON.

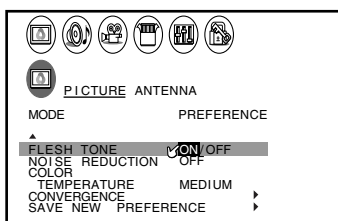

To turn off the flesh tone feature:

Highlight OFF in step 3 above.

Using the noise reduction feature

This feature allows you to reduce visible interference in your TV picture. This is useful when receiving a broadcast with a weak signal or playing a videotape or disk damaged by repeated use.

To turn on the noise reduction feature:

1. Press MENU, and then press ◀ or ▶ until the PICTURE menu appears.
2. Press ▲ or ▼ to highlight NOISE REDUCTION.
3. Press ◀ or ▶ to highlight ON.

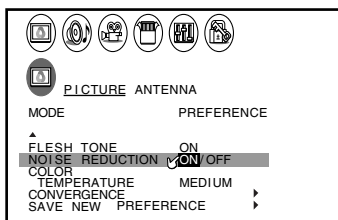

To turn off the noise reduction feature:

Highlight OFF in step 3 above.

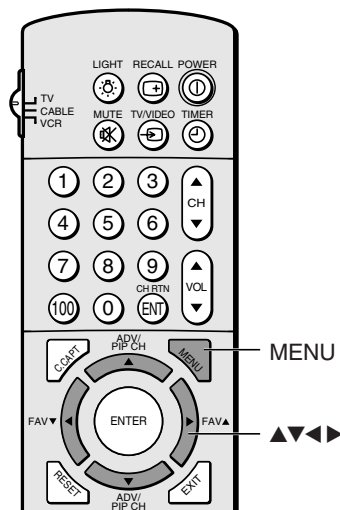

Selecting the color temperature

You can change the quality of the picture by selecting from three preset color temperatures: Cool, Medium, and Warm.

Mode	Picture Quality
Cool	Blueish
Medium	Neutral
Warm	Reddish

To select the color temperature:

1. Press MENU, and then press ◀ or ▶ until the PICTURE menu appears.
2. Press ▲ or ▼ to highlight COLOR TEMPERATURE.
3. Press ◀ or ▶ to highlight the mode you prefer.

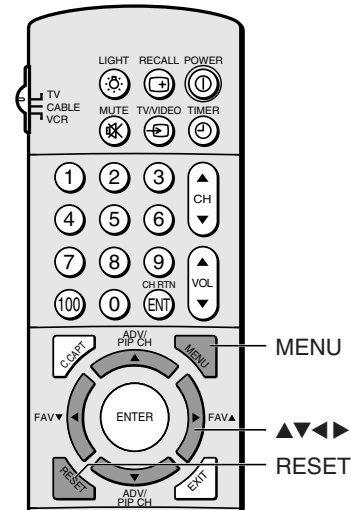
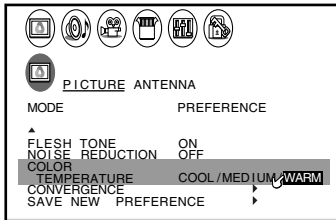

Resetting your picture adjustments

The RESET function returns the picture qualities to the following factory settings:

contrast	max (100)	color temperature	cool
brightness	center (50)	noise reduction	off
color	center (50)	picture mode	sports
tint	center (0)		
sharpness	center (50)		

To reset your picture adjustments:

1. Press MENU, and then press ◀ or ▶ until the PICTURE menu appears.
2. Press ▲ or ▼ to highlight RESET.
3. Press ◀ or ▶.

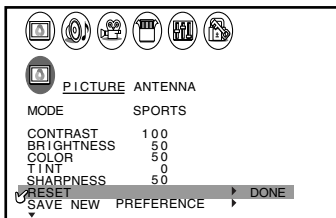

To reset both the picture and audio adjustments to the factory settings:

Press RESET on the remote control.

Watching video input

To view a signal from another device connected to the TV (such as a VCR or DVD player), press the TV/VIDEO button on the remote control or TV to change the video input (see illustrations below).

Select VIDEO 1, VIDEO 2, VIDEO 3, or ColorStream, depending on which input jack is used for connecting the specific device (see “Connecting your TV” on page 7).

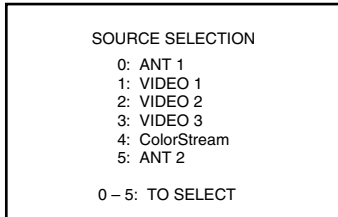

Pressing TV/VIDEO on the remote control displays this screen. To select, press 0-5.

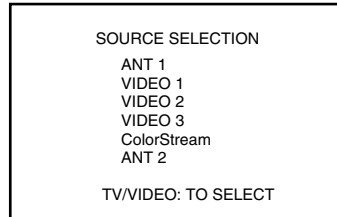

Pressing TV/VIDEO on the TV displays this screen. To select, press TV/VIDEO.

Note:

When ColorStream is selected, the video OUT signal will not have color.

To receive a color video OUT signal, a video or S-video IN jack must be used instead of the ColorStream connection.

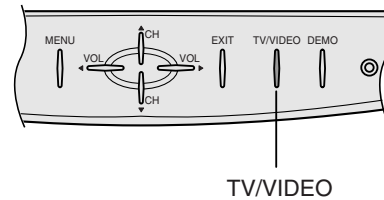

Selecting the video input labels

You can change the video label that displays on the screen when the TV/VIDEO button is pressed.

To label the video inputs:

1. Press MENU, and then press ◀ or ▶ until the CUSTOM menu appears.
2. Press ▲ or ▼ to highlight VIDEO LABEL.

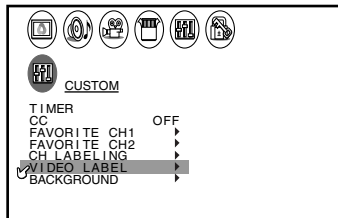

3. Press ◀ or ▶ to display the VIDEO LABEL menu.
4. Press ▲ or ▼ to highlight the video source you want to label.
5. Press ◀ or ▶ to select the appropriate label for that source: VCR, DVD, DTV, SAT (satellite), or CBL (cable). To use the original label (“VIDEO 1,” for example), select “—.”
6. To exit the menu, press EXIT.

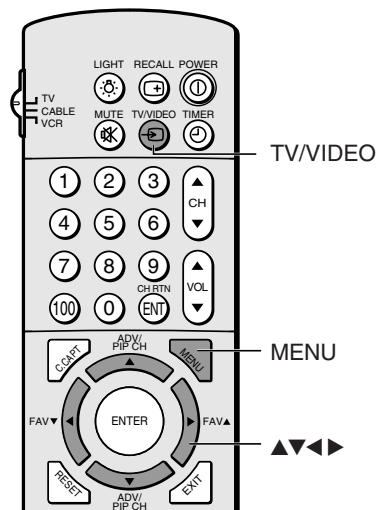
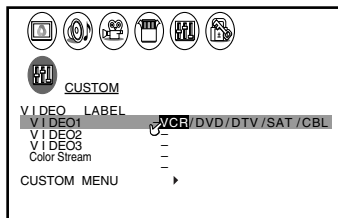

Using the closed caption feature

The closed caption feature has two options:

- Captions — An on-screen display of the dialogue, narration, and sound effects of programs and videos that are closed-captioned (usually identified as “CC” in program guides).
- Text — An on-screen display of information not related to the program, such as weather or stock data (when provided by individual stations).

To view captions or text:

1. Tune the TV to the desired program or video.
2. Press C.CAPT to cycle through the closed caption modes (C1 through C4, T1 through T4, and OFF). Each time C.CAPT is pressed, the closed caption mode changes.

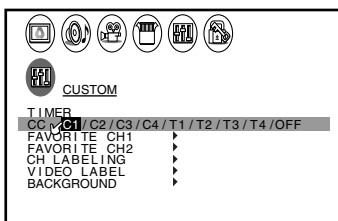

- To view captions, highlight C1, C2, C3, or C4 (C1 displays captions in the primary language in your area).

Note: If the program or video you are viewing is not closed-captioned, no captions will display on the screen.



- To view text, highlight T1, T2, T3, or T4.

Note: If text is not available, a black rectangle may appear on your screen. If this happens, set the closed caption feature to OFF.

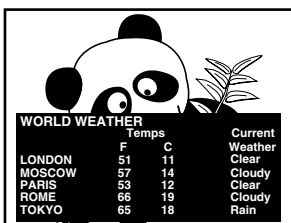

- To turn off the closed-caption feature, highlight OFF.

Note:

The closed caption feature can be also selected by pressing MENU and ◀▶ to display the Custom menu, ▲▼ to highlight CC, and then ◀▶ to select a closed caption mode.

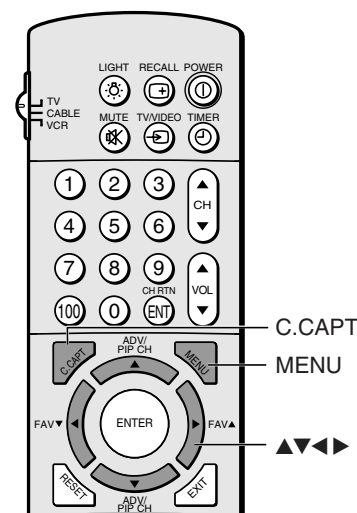

Note:

A closed caption signal may not be decoded in the following situations:

- when a videotape has been dubbed
- when the signal reception is weak
- when the signal reception is nonstandard

Setting the sleep timer

The sleep timer turns off the TV automatically.

To use the remote control to set the sleep timer:

Repeatedly press **TIMER** to set the number of minutes until the TV turns off automatically (in 10-minute increments, to a maximum of 180).

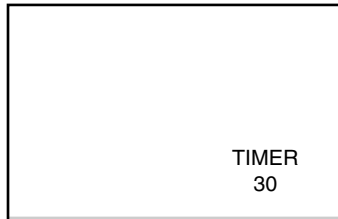

To use the menu system to set the sleep timer:

1. Press **TIMER** (or **MENU** and **◀▶**) to display the **CUSTOM** menu. **TIMER** will be highlighted.
2. After the number position starts to blink, use the channel numbers to enter the length of time until the TV turns off.
3. Press **ENTER** to start the timer.

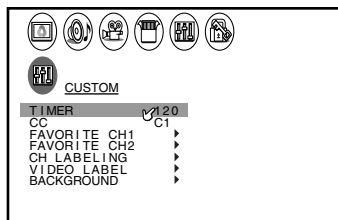

To cancel the sleep timer:

Press **TIMER** until the number is set to 0, use the menu system to set the timer to 0, or turn off the TV.

Setting the clock

To set the clock:

1. Press **MENU**, and then press **◀** or **▶** until the **SET UP** menu appears.
2. Press **▲** or **▼** to highlight **CLOCK SET**.
3. After the number position starts to blink, press the Number buttons (0–9) to enter the correct time. The clock operates on a 12-hour cycle.
4. Press **ENTER** to start the clock.

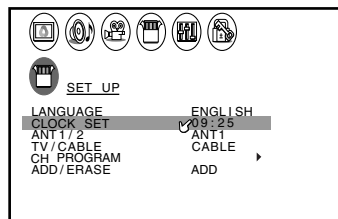

To display the time on-screen:

Press **RECALL**.

Note :

To display the amount of time until the TV turns off automatically, press **TIMER** once. To close the display, press **ENTER**.

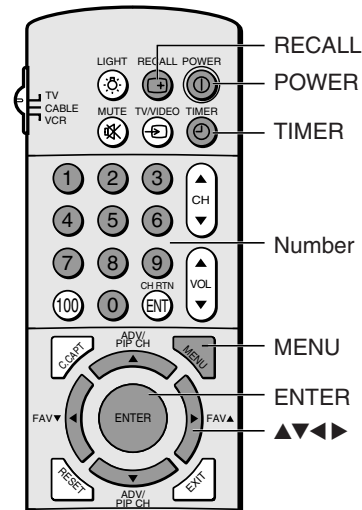

Note :

If the power source for the TV is interrupted (for example, if the power cord is unplugged or a power failure occurs), the clock will have to be reset.

Adjusting the sound

Muting the sound

Press MUTE to temporarily turn off the sound. While the sound is off, the screen will display the word MUTE in the lower right corner. To restore the sound, press MUTE again.

When you press the MUTE button, you automatically activate the closed caption feature. To deactivate this feature, press the MUTE button again. This feature only works when the closed caption mode is set to OFF. See "Using the closed caption feature" on page 37 for more information.

Selecting stereo/SAP broadcasts

The multi-channel TV sound (MTS) feature allows you to listen to high-fidelity stereo sound while you watch TV. MTS can also transmit a second audio program (SAP) containing a second language, music, or other audio information (when provided by individual stations).

When the TV receives a stereo or SAP broadcast, the word STEREO or SAP appears on-screen every time you turn the TV on, change the channel, or press RECALL.

The MTS feature is not available when the TV is in VIDEO mode.

To listen to stereo sound:

1. Press MENU, and then press ◀ or ▶ until the AUDIO menu appears.

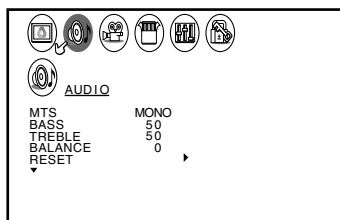

2. Press ▲ or ▼ to highlight MTS.
3. Press ◀ or ▶ to highlight STEREO.

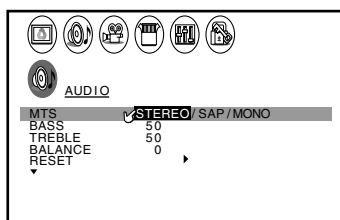

You can leave your TV in STEREO mode because it automatically outputs the type of sound being broadcast (stereo or monaural). If the stereo sound is noisy, select MONO to reduce the noise. The word STEREO or SAP displays in yellow in the menu when the TV receives the signal.

To listen to SAP (if available):

1. Press MENU, and then press ◀ or ▶ until the AUDIO menu appears.
2. Press ▲ or ▼ to highlight MTS.
3. Press ◀ or ▶ to highlight SAP. You will hear the station's second audio program (if available) from the speakers while viewing the original program's picture (see note at right).

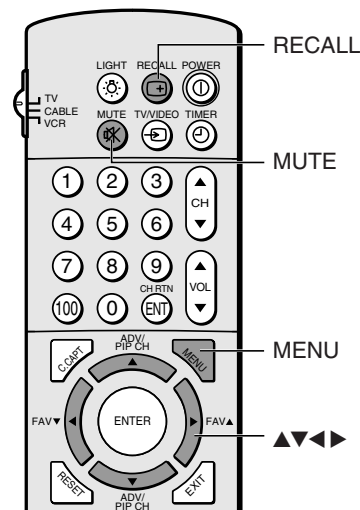

Note :

A second audio program (SAP) can be heard only on those TV stations that offer it. For example, some TV stations broadcast music as a second audio program. If you have SAP on, you will see the current program on the screen but hear music instead of the program's normal audio.

If you have SAP on, and the station you are watching is not currently broadcasting a second audio program, you will see the picture but not hear any sound. If this happens, but the TV is in STEREO mode so you can hear the station's normal audio.

Using the surround sound feature

The surround sound feature expands the audio listening field wider and deeper to create exceptional sound quality from the TV's speakers. The feature uses stereo signals from a TV broadcast or video input.

To turn on the surround sound feature:

1. Select STEREO mode (see "Selecting stereo/SAP broadcasts" on page 37).
2. Press MENU, and then press ◀ or ▶ until the THEATER menu appears.
3. Press ▲ or ▼ to highlight SURROUND.
4. Press ◀ or ▶ to highlight MATRIX.

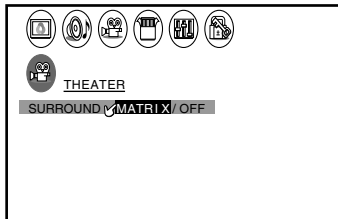

To turn off the surround sound feature:

Highlight OFF in step 4 above.

In general, you can leave your TV in MATRIX mode because it automatically outputs the type of sound being broadcast (stereo or monaural).

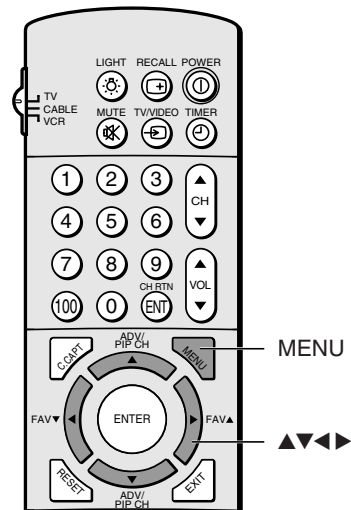

Note:

When MATRIX surround sound is selected, the StableSound® feature is automatically turned off. See page 43.

Adjusting the sound quality

You can change the quality of your TV's sound by adjusting the bass, treble, and balance.

To adjust the sound quality:

1. Press MENU, and then press ◀ or ▶ until the AUDIO menu appears.
2. Press ▲ or ▼ to highlight the item you want to adjust.

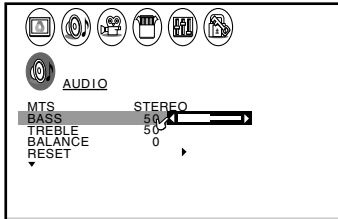

3. Press ◀ or ▶ to adjust the level:
 - ◀ makes the sound quality weaker or decreases the balance in the right channel, depending on the item selected.
 - ▶ makes the sound quality stronger or decreases the balance in the left channel, depending on the item selected.

Resetting your audio adjustments

The RESET function returns your audio adjustments to the following factory settings:

bass center (50)
treble center (50)
balance center (0)

To reset your audio adjustments:

1. Press MENU, and then press ◀ or ▶ until the AUDIO menu appears.
2. Press ▲ or ▼ to highlight RESET.
3. Press ◀ or ▶. When reset, the menu displays "DONE."

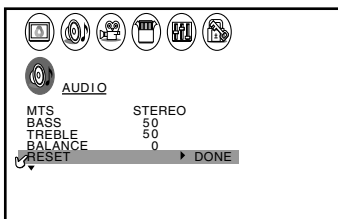

To reset both your audio and picture adjustments to the factory settings:

Press RESET on the remote control.

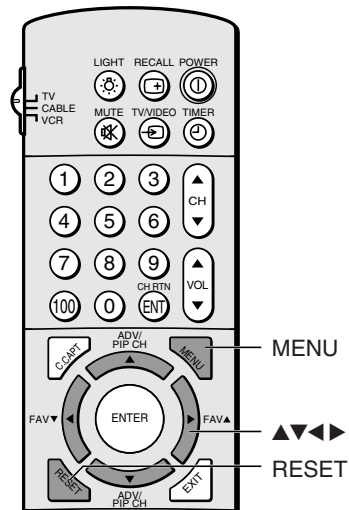

Using the sub-bass system (SBS)

The sub-bass system allows you to enhance bass performance (even when the sound volume is low).

To turn on the SBS:

1. Press MENU, and then press ◀ or ▶ until the AUDIO menu appears.
2. Press ▲ or ▼ to highlight SBS.
3. Press ◀ or ▶ to highlight ON.

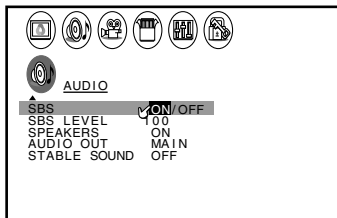

To adjust the SBS level:

4. Press ▲ or ▼ to highlight SBS LEVEL.
5. Press ◀ or ▶ to adjust the SBS level.

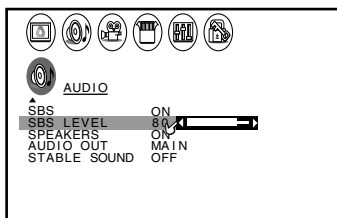

To turn off the SBS:

Highlight OFF in step 3 above.

Turning off the built-in speakers

Use this feature to turn the TV speakers off when you connect an audio system (see page 11).

To turn off the built-in speakers:

1. Press MENU, and then press ◀ or ▶ until the AUDIO menu appears.
2. Press ▲ or ▼ to highlight SPEAKERS.
3. Press ◀ or ▶ to highlight OFF.

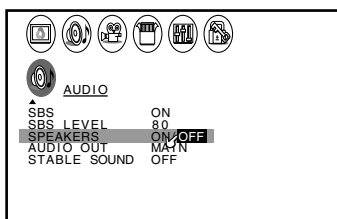

To turn on the built-in speakers:

Highlight ON in step 3 above.

Note:

The Sub-Bass System signal does not pass through the "Variable Audio OUT" jacks. (See page 9.)

However, the AUDIO menu will appear when the buttons are pressed.

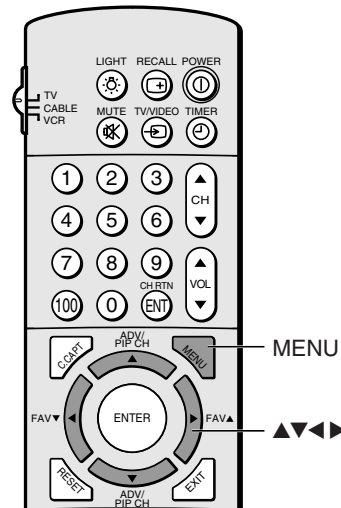

Selecting the Audio OUT sound

You can choose to output the sound of either the PIP or main picture from the Audio OUT jacks.

This is useful when amplifying or recording the PIP sound with external equipment while hearing the sound of the main picture through the built-in speakers.

To select the Audio OUT sound:

1. Press MENU, and then press ◀ or ▶ until the AUDIO menu appears.
2. Press ▲ or ▼ to highlight AUDIO OUT.
3. Press ◀ or ▶ to highlight MAIN or PIP.
 - MAIN: Main picture sound.
 - PIP: PIP sound.

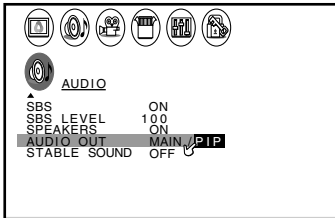

Using the StableSound® feature

The StableSound® feature limits the highest volume level to avoid extreme changes in volume when the signal source is changed.

To turn on the StableSound® feature:

1. Press MENU, and then press ◀ or ▶ until the AUDIO menu appears.
2. Press ▲ or ▼ to highlight STABLE SOUND.
3. Press ◀ or ▶ to highlight ON.

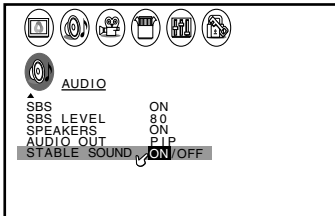

To turn off the StableSound® feature:

Highlight OFF in step 3 above.

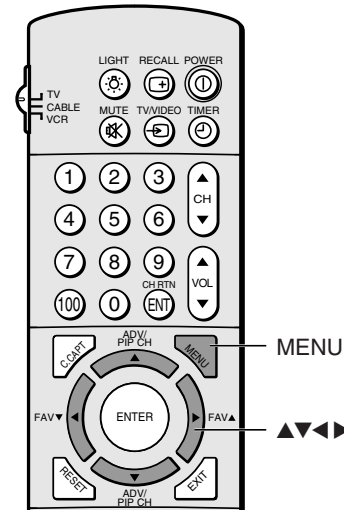

Note:

When the StableSound® feature is turned on, the surround sound feature is automatically turned off (see page 40).

Selecting the background of the menu display

You can change the background of the menu display by selecting from two preset types: shaded and solid (gray).

To select the background:

1. Press MENU, and then press ◀ or ▶ until the CUSTOM menu appears.
2. Press ▲ or ▼ to highlight BACKGROUND.
3. Press ◀ or ▶ to highlight either SHADED or SOLID.

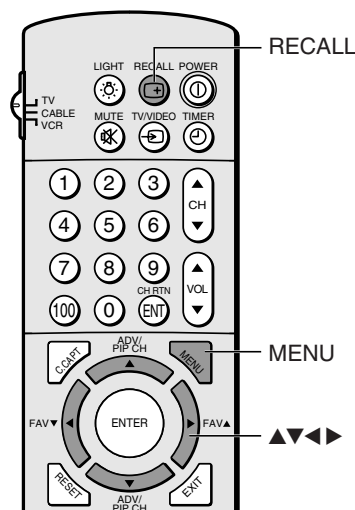
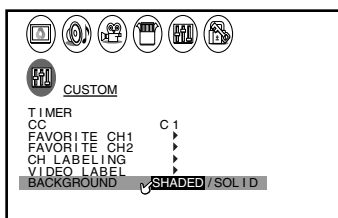

Displaying on-screen information

Press RECALL to display the following information on-screen:

- Antenna mode (when in TV mode)
- Channel number or VIDEO mode selected
- Time (if set)
- Channel label (if set)
- Stereo or SAP (second audio program) audio status
- V-CHIP rating status

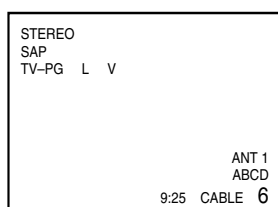

Viewing the demonstration mode

When you press DEMO on the TV, the TV will automatically display a variety of its on-screen menus and special features. This function is provided for demonstration purposes only.

To stop the demonstration mode:

Press DEMO again.

Understanding the auto power off feature

The TV will automatically turn itself off after approximately 15 minutes if it is tuned to a vacant channel or a station that completes its broadcast for the day. This feature does not work in VIDEO mode.

Understanding the last mode memory feature

If the power is cut off while you are viewing the TV, the last mode memory feature will turn the TV on automatically when the power is resupplied.

If the power is going to be off for a long time or you are going to be away from your TV, unplug the power cord to prevent the TV from turning on in your absence.

Appendix

Specifications

Television System	NTSC standard
Channel Coverage	VHF: 2 through 13 UHF: 14 through 69 Cable TV: Mid band (A-8 through A-1, A through I) Super band (J through W) Hyper band (AA through ZZ, AAA, BBB) Ultra band (65 through 94, 100 through 125)
Power Source	120 V AC, 60 Hz
Power Consumption	43A61, 43A62: 146 W; 50A61, 50A62, 61A61 and 61A62: 140 W
Audio Power	14 W + 14 W
Speaker Type	Two 6-1/4 inches (16 cm) round
Video/Audio Terminals	S-VIDEO INPUT Y-INPUT: 1 V(p-p), 75 ohm, negative sync. C-INPUT: 0.286 V(p-p) (burst signal), 75 ohm VIDEO/AUDIO INPUT VIDEO: 1 V(p-p), 75 ohm, negative sync. AUDIO: 150 mV(rms) (30% modulation equivalent, 47 kohm) ColorStream® (component video) INPUT Y: 1V(p-p), 75 ohm Pr (CR): 0.7 V(p-p), 75 ohm Pb (CB): 0.7 V(p-p), 75 ohm AUDIO: 150 mV(rms), 47 kohm VIDEO/AUDIO OUTPUT VIDEO: 1 V(p-p), 75 ohm, negative sync. AUDIO: 150 mV(rms) (30% modulation equivalent, 4.7 kohm) VARIABLE AUDIO OUTPUT 0–300 mV(rms) (30% modulation equivalent, 4.7 kohm) AUDIO CENTER CHANNEL INPUT 300 mV(rms) (30% modulation equivalent, 10 kohm)

Dimensions/Mass

Model	Dimension (W/H/D)	Mass
43A61 43A62	37-11/16 × 42-7/8 × 20-1/16 inches (957 × 1089 × 510 mm)	118 lbs (53,5 kg)
50A61 50A62	42-1/4 × 50-5/8 × 20-13/16 inches (1073 × 1284 × 529 mm)	217 lbs (98,6 kg)
61A61 61A62	51-1/16 × 57-3/16 × 25-9/16 inches (1297 × 1453 × 649 mm)	288 lbs (130,9 kg)

Toshiba Stand

43A61 and 43A62: ST4362
50A61 and 50A62: —
61A61 and 61A62: —

Supplied Accessories

Remote Control with 2 size “AA” alkaline batteries

Design and specifications are subject to change without notice.

Troubleshooting

Before calling a service technician, please check the following table for a possible cause of the problem and some solutions.

Problem	Solution
TV will not turn on	<ul style="list-style-type: none">• Make sure the power cord is plugged in, and then press POWER.• The remote control batteries may be dead. Replace the batteries.
No picture, no sound	<ul style="list-style-type: none">• Check the antenna/cable connections.• Press the TV/VIDEO button to check the main picture source.
No sound, picture OK	<ul style="list-style-type: none">• The sound may be muted. Press VOL ▲▼.• The station may have broadcast difficulties. Try another channel.• Make sure the SPEAKERS feature in the AUDIO menu is set correctly.
Poor sound, picture OK	<ul style="list-style-type: none">• The station may have broadcast difficulties. Try another channel.
Poor picture, sound OK	<ul style="list-style-type: none">• Check the antenna connections.• The station may have broadcast difficulties. Try another channel.• Adjust the PICTURE menu.
Poor reception of broadcast channels	<ul style="list-style-type: none">• Check the antenna connections.• The station may have broadcast difficulties. Try another channel.• If you are using a VCR, make sure the TV/VCR button is set correctly.
Cannot receive above channel 13	<ul style="list-style-type: none">• Make sure the TV/CABLE/VCR switch is set to the mode that corresponds with the signal source (cable or outside antenna).
Black box appears on the screen	<ul style="list-style-type: none">• The closed caption feature may be set to one of the Text modes (T1, T2, T3, or T4). Set closed captioning to OFF.
Unable to select a certain channel or VIDEO input	<ul style="list-style-type: none">• The channel may be locked out with the CH LOCK or VIDEO LOCK feature, or erased with the ADD/ERASE feature.
Multiple images	<ul style="list-style-type: none">• The station may have broadcast difficulties. Try another channel.• Antenna reception may be poor. Use a highly directional outdoor antenna.
Poor color or no color	<ul style="list-style-type: none">• The station may have broadcast difficulties. Try another channel.• Adjust the TINT and/or COLOR in the PICTURE menu.• The picture may suffer from color shading if you change the direction of the TV while it is on. Turn the TV off and allow it to cool for 30 minutes before turning it on again.
No stereo or SAP sound from a known MTS broadcast	<ul style="list-style-type: none">• Make sure the MTS feature is set properly.
The remote control does not operate	<ul style="list-style-type: none">• Make sure the TV/CABLE/VCR switch is set properly.• There may be an obstruction between the remote control and the remote control sensor. Remove the obstruction.• The remote control batteries may be dead. Replace the batteries.
Cannot access signal input sources (Video 1-2-3, ColorStream) and/or channels 3 and 4.	<ul style="list-style-type: none">• Check the VIDEO LOCK feature.

Limited United States Warranty

for 27" FST PURE® and All Larger Television Models

Toshiba America Consumer Products, Inc. ("TACP") and Toshiba Hawaii, Inc. ("THI") make the following limited warranties to original consumers in the United States. THESE LIMITED WARRANTIES EXTEND TO THE ORIGINAL CONSUMER PURCHASER OR ANY PERSON RECEIVING THIS TELEVISION AS A GIFT FROM THE ORIGINAL CONSUMER PURCHASER AND TO NO OTHER PURCHASER OR TRANSFEREE.

PRODUCTS PURCHASED IN THE U.S.A. AND USED IN CANADA ARE NOT COVERED BY THESE WARRANTIES.

PRODUCTS PURCHASED IN CANADA AND USED IN THE U.S.A. ARE NOT COVERED BY THESE WARRANTIES.

Limited One (1) Year Warranty on Parts and Labor*

TACP/THI warrant this television and its parts against defects in materials or workmanship for a period of one (1) year after the date of original retail purchase. DURING THIS PERIOD, TACP/THI WILL, AT TACP/THI'S OPTION, REPAIR OR REPLACE A DEFECTIVE PART WITH A NEW OR REFURBISHED PART WITHOUT CHARGE TO YOU FOR PARTS OR LABOR. TACP/THI Authorized Service Station personnel will come to your home when warranty service is required. Depending on the type of repair required, either the service will be performed in your home or the set will be taken to the TACP/THI Authorized Service Station for repair and returned to your home at no cost to you.

Limited Two (2) Year Warranty on Picture Tube*

TACP/THI further warrant the picture tube in this television against defects in materials or workmanship for a period of two (2) years after the date of original retail purchase. DURING THIS PERIOD, TACP/THI WILL, AT TACP/THI'S OPTION, REPAIR OR REPLACE A DEFECTIVE PICTURE TUBE WITH A NEW OR REFURBISHED PICTURE TUBE WITHOUT CHARGE TO YOU, EXCEPT THAT, IF A DEFECTIVE PICTURE TUBE IS REPAIRED OR REPLACED AFTER ONE (1) YEAR FROM THE DATE OF THE ORIGINAL RETAIL PURCHASE, YOU PAY LABOR CHARGES INVOLVED IN THE REPAIR OR REPLACEMENT.

Rental Units

The warranty for rental units begins with the date of first rental or thirty (30) days from the date of shipment to the rental firm, whichever comes first.

*Commercial Units

Televisions sold and used for commercial purposes have a limited ninety (90) day warranty for all parts, labor, and picture tubes.

Owner's Manual and Product Registration Card

Read this owner's manual thoroughly before operating this television. Complete and mail the enclosed product registration card within ten days after you, or the person who has given you this product as a gift, purchased this television. Returning the product registration card will enable TACP/THI to provide you with better customer service and improved product support. Failure to return the product registration card will not affect your rights under this warranty.

Your Responsibility

THE ABOVE WARRANTIES ARE SUBJECT TO THE FOLLOWING CONDITIONS:

- (1) You must provide your bill of sale or other proof of purchase.
- (2) All warranty servicing of this television must be made by an Authorized TACP/THI Service Station.
- (3) The warranties from TACP and THI are effective only if the television is purchased and operated in the U.S.A. or Puerto Rico.

- (4) Labor service charges for set installation, setup, adjustment of customer controls, and installation or repair of antenna systems are not covered by these warranties. Reception problems caused by inadequate antenna systems are your responsibility.
- (5) Warranties extend only to defects in materials or workmanship as limited above and do not extend to any television or parts that have been lost or discarded by you or to damage to television or parts caused by misuse, accident, Acts of God (such as lightning or fluctuations in electric power), improper installation, improper maintenance, or use in violation of instructions furnished by TACP/THI; or to units that have been modified or had the serial number removed, altered, defaced, or rendered illegible.

How to Obtain Warranty Services

If, after following all of the operating instructions in this manual and checking the "Troubleshooting" section, you find that service is needed:

- (1) To find the nearest TACP/THI Authorized Service Station:

For televisions purchased in the United States, except Hawaii, visit TACP's web site at www.toshiba.com/tacp, or call toll free 1-800-631-3811.

For televisions purchased in Hawaii, contact Toshiba Hawaii, Inc., 327 Kamakee Street, Honolulu, HI 96814, (808) 591-9281.

- (2) Present your bill of sale or other proof of purchase to the Authorized Service Station. Authorized TACP/THI Service Station personnel will come to your home when warranty service is required. Depending on the type of repair required, either the service will be performed in your home or the set will be taken to the Authorized Service Station for repair and returned to your home at no cost to you.

**For additional information, visit TACP's web site:
www.toshiba.com/tacp.**

ALL WARRANTIES IMPLIED BY THE LAW OF ANY STATE OF THE U.S.A., INCLUDING THE IMPLIED WARRANTIES OF MERCHANTABILITY AND FITNESS FOR A PARTICULAR PURPOSE, ARE EXPRESSLY LIMITED TO THE DURATION OF THE LIMITED WARRANTIES SET FORTH ABOVE. WITH THE EXCEPTION OF ANY WARRANTIES IMPLIED BY THE LAW OF ANY STATE OF THE U.S.A. AS HEREBY LIMITED, THE FOREGOING WARRANTY IS EXCLUSIVE AND IN LIEU OF ALL OTHER WARRANTIES, GUARANTEES, AGREEMENTS, AND SIMILAR OBLIGATIONS OF TACP OR THI WITH RESPECT TO THE REPAIR OR REPLACEMENT OF ANY PARTS. IN NO EVENT SHALL TACP OR THI BE LIABLE FOR CONSEQUENTIAL OR INCIDENTAL DAMAGES.

No person, agent, distributor, dealer, or company is authorized to change, modify, or extend the terms of these warranties in any manner whatsoever. The time within which action must be commenced to enforce any obligation of TACP or THI arising under this warranty or under any law of the United States or of any state thereof is hereby limited to 90 days from the date you discover, or should have discovered, the defect. This limitation does not apply to implied warranties arising under the law of any state of the U.S.A.

THIS WARRANTY GIVES YOU SPECIFIC LEGAL RIGHTS, AND YOU MAY ALSO HAVE OTHER RIGHTS, WHICH MAY VARY FROM STATE TO STATE IN THE U.S.A. SOME STATES OF THE U.S.A. DO NOT ALLOW LIMITATIONS ON THE DURATION OF AN IMPLIED WARRANTY, LIMITATIONS ON THE TIME WITHIN WHICH AN ACTION MAY BE BROUGHT, OR THE EXCLUSION OR LIMITATION OF INCIDENTAL OR CONSEQUENTIAL DAMAGES; THEREFORE, THE ABOVE LIMITATIONS OR EXCLUSIONS MAY NOT APPLY TO YOU UNDER SUCH CIRCUMSTANCES.

FST PURE® is a registered trademark of Toshiba America Consumer Products, Inc.
REV. MAR02

Limited Canada Warranty

for 27" FST PURE® and All Larger Television Models

Toshiba of Canada Limited ("TCL") makes the following limited warranties to original consumers in Canada.

THESE LIMITED WARRANTIES EXTEND TO THE ORIGINAL CONSUMER PURCHASER OR ANY PERSON RECEIVING THIS TELEVISION AS A GIFT FROM THE ORIGINAL CONSUMER PURCHASER AND TO NO OTHER PURCHASER OR TRANSFEREE.

PRODUCTS PURCHASED IN THE U.S.A. AND USED IN CANADA ARE NOT COVERED BY THESE WARRANTIES.

PRODUCTS PURCHASED IN CANADA AND USED IN THE U.S.A. ARE NOT COVERED BY THESE WARRANTIES.

Limited One (1) Year Warranty on Parts and Labor*

TCL warrants this television and its parts against defects in materials or workmanship for a period of one (1) year after the date of original retail purchase. DURING THIS PERIOD, TCL WILL, AT TCL'S OPTION, REPAIR OR REPLACE A DEFECTIVE PART WITH A NEW OR REFURBISHED PART WITHOUT CHARGE TO YOU FOR PARTS OR LABOR. TCL Authorized Service Depot personnel will come to your home when warranty service is required. Depending on the type of repair required, either the service will be performed in your home or the set will be taken to the TCL Authorized Service Depot for repair and returned to your home at no cost to you. IN-HOME SERVICE ONLY APPLIES WITHIN 100 KILOMETERS OF AN AUTHORIZED TCL SERVICE DEPOT.

Limited Two (2) Year Warranty on Picture Tube*

TCL further warrants the picture tube in this television against defects in materials or workmanship for a period of two (2) years after the date of original retail purchase. DURING THIS PERIOD, TCL WILL, AT TCL'S OPTION, REPAIR OR REPLACE A DEFECTIVE PICTURE TUBE WITH A NEW OR REFURBISHED PICTURE TUBE WITHOUT CHARGE TO YOU, EXCEPT THAT, IF A DEFECTIVE PICTURE TUBE IS REPAIRED OR REPLACED AFTER ONE (1) YEAR FROM THE DATE OF THE ORIGINAL RETAIL PURCHASE, YOU PAY LABOR CHARGES INVOLVED IN THE REPAIR OR REPLACEMENT.

Rental Units

The warranty for rental units begins with the date of first rental or thirty (30) days from the date of shipment to the rental firm, whichever comes first.

*Commercial Units

Televisions sold and used for commercial purposes have a limited ninety (90) day warranty for all parts, labor, and picture tubes.

Owner's Manual

Read this owner's manual thoroughly before operating this television.

Your Responsibility

THE ABOVE WARRANTIES ARE SUBJECT TO THE FOLLOWING CONDITIONS:

- (1) You must provide your bill of sale or other proof of purchase.
- (2) All warranty servicing of this television must be made by an Authorized TCL Service Depot.
- (3) The warranties from TCL are effective only if the television is purchased in Canada from an authorized TCL dealer and operated in Canada.

- (4) Labor service charges for set installation, setup, adjustment of customer controls, and installation or repair of antenna systems are not covered by these warranties. Reception problems caused by inadequate antenna systems are your responsibility.
- (5) Warranties extend only to defects in materials or workmanship as limited above and do not extend to any television or parts that have been lost or discarded by you or to damage to television or parts caused by misuse, accident, Acts of God (such as lightning or fluctuations in electric power), improper installation, improper maintenance, or use in violation of instructions furnished by TCL; or to units that have been modified or had the serial number removed, altered, defaced, or rendered illegible.

How to Obtain Warranty Services

If, after following all of the operating instructions in this manual and checking the "Troubleshooting" section, you find that service is needed:

- (1) To find the nearest TCL Authorized Service Depot, visit TCL's web site: www.toshiba.ca.
- (2) Present your bill of sale or other proof of purchase to the Authorized Service Depot. Authorized TCL Service Depot personnel will come to your home when warranty service is required. Depending on the type of repair required, either the service will be performed in your home or the set will be taken to the Authorized Service Depot for repair and returned to your home at no cost to you. IN-HOME SERVICE ONLY APPLIES WITHIN 100 KILOMETERS OF AN AUTHORIZED TCL SERVICE DEPOT.

**For additional information, visit TCL's web site:
www.toshiba.ca**

ALL WARRANTIES IMPLIED BY THE LAW OF ANY PROVINCE OF CANADA, INCLUDING THE IMPLIED WARRANTIES OF MERCHANTABILITY AND FITNESS FOR A PARTICULAR PURPOSE, ARE EXPRESSLY LIMITED TO THE DURATION OF THE LIMITED WARRANTIES SET FORTH ABOVE. WITH THE EXCEPTION OF ANY WARRANTIES IMPLIED BY THE LAW OF ANY PROVINCE OF CANADA AS HEREBY LIMITED, THE FOREGOING WARRANTY IS EXCLUSIVE AND IN LIEU OF ALL OTHER WARRANTIES, GUARANTEES, AGREEMENTS, AND SIMILAR OBLIGATIONS OF TCL WITH RESPECT TO THE REPAIR OR REPLACEMENT OF ANY PARTS. IN NO EVENT SHALL TCL BE LIABLE FOR CONSEQUENTIAL OR INCIDENTAL DAMAGES.

No person, agent, distributor, dealer, or company is authorized to change, modify, or extend the terms of these warranties in any manner whatsoever. The time within which action must be commenced to enforce any obligation of TCL arising under this warranty or under any law of Canada or of any province thereof, is hereby limited to 90 days from the date you discover, or should have discovered, the defect. This limitation does not apply to implied warranties arising under the law of any province of Canada.

THIS WARRANTY GIVES YOU SPECIFIC LEGAL RIGHTS, AND YOU MAY ALSO HAVE OTHER RIGHTS, WHICH MAY VARY FROM PROVINCE TO PROVINCE IN CANADA. SOME PROVINCES OF CANADA DO NOT ALLOW LIMITATIONS ON THE DURATION OF AN IMPLIED WARRANTY, LIMITATIONS ON THE TIME WITHIN WHICH AN ACTION MAY BE BROUGHT, OR THE EXCLUSION OR LIMITATION OF INCIDENTAL OR CONSEQUENTIAL DAMAGES; THEREFORE, THE ABOVE LIMITATIONS OR EXCLUSIONS MAY NOT APPLY TO YOU UNDER SUCH CIRCUMSTANCES.

FST PURE® is a registered trademark of Toshiba America Consumer Products, Inc.
REV. MAR02

Index

A

A/V receiver connection	12
ANT 1/2	19
Antenna cables	7
Audio cables	7
AUDIO OUT sound, selecting	43
Audio system connection	11
Auto power off	45

B

Back of the TV	6
BACKGROUND selection	44

C

Cable box connection	8
Camcorder connection	11
C.CAPT button	37
CH LABEL	24
CH LOCK	31
CH RTN button	23
Channel number buttons	23
Channel programming	
ADD/ERASE	21
Automatic programming	20
TV/CABLE selection	20
Channel ▲ ▼ buttons	21
Clock	38
Closed caption	37
ColorStream cables	7
Convergence adjustment	21
Color temperature	35

D

DEMO button	44
Demonstration mode	44
DVD connection	9

F

FAV ▲ ▼ buttons	24
FAVORITE CH	23
Front of the TV	6

L M

Language selection	19
Last mode memory	45
Locks menu	28
Menu system	18
MTS feature	39
MUTE button	39

P

Picture adjustments	
COLOR TEMPERATURE	35
FLESH TONE	34
NOISE REDUCTION	34

Picture mode	33
Picture quality	33
Picture in Picture (PIP)	
LOCATE button	27
PIP button	26
PIP CH ▲ ▼ buttons	26
SOURCE button	26
STILL button	27
SWAP button	27

R

RECALL button	44
Remote control	
Battery installation	13
CABLE code table	16
CABLE box control buttons	14
Learning about the buttons	17
Programming	14
VCR code table	15
VCR control buttons	13
RESET button	35, 41

S

SAP sound	39
Satellite receiver connection	9
Sleep timer	38
Sound quality adjustments	41
SPEAKERS on/off	42
Specifications	46
StableSound	43
Stereo sound	39
Sub-Bass System	42
Surround sound	40
S-video cables	7

T

TIMER button	38
Troubleshooting	47
TV/VIDEO button on remote	36
TV/VIDEO button on TV	19

V

V-CHIP	
BLOCKING OPTION	30
ENABLE BLOCKING	29
MPAA RATING	30
NEW PIN CODE	32
TV RATING	29
Unlocking programs	31
VCR connection	7-10
Video cables	7
VIDEO LABEL	36
VIDEO LOCK	32

W

Warranty, U.S.	48
Warranty, Canada	49

TOSHIBA AMERICA CONSUMER PRODUCTS, INC.

HEAD OFFICE/82 TOTOWA ROAD, WAYNE, NEW JERSEY 07470
NATIONAL SERVICE DIVISION:1420B TOSHIBA DRIVE, LEBANON, TN. 37087

TOSHIBA HAWAII, INC.

HEAD OFFICE/327 KAMAKEE STREET, HONOLULU, HAWAII 96814, U.S.A. TEL: (808) 591-9281

TOSHIBA OF CANADA LTD.

HEAD OFFICE/191 McNABB STREET MARKHAM, ONTARIO L3R 8H2, CANADA TEL: (905) 470-5400
SERVICE CENTERS/TORONTO: 191 McNABB STREET MARKHAM, ONTARIO L3R 8H2, CANADA TEL: (905) 470- 5400
MONTREAL: 1643, NORTH SERVICE RD., TRANS-CANADA HIGHWAY, DORVAL QUEBEC, H9P 1J1, CANADA
TEL: (514) 856-4100
VANCOUVER: 22171 FRASERWOOD WAY, RICHMOND, B.C. V6W 1J5, CANADA TEL: (604) 303-2500

MANUFACTURED BY
TOSHIBA AMERICA CONSUMER PRODUCTS, INC.

ColorStream and StableSound are registered trademarks of Toshiba America Consumer Products, Inc.

PRINTED IN USA
(02-07)B

TOSHIBA

Free Manuals Download Website

<http://myh66.com>

<http://usermanuals.us>

<http://www.somanuals.com>

<http://www.4manuals.cc>

<http://www.manual-lib.com>

<http://www.404manual.com>

<http://www.luxmanual.com>

<http://aubethermostatmanual.com>

Golf course search by state

<http://golfingnear.com>

Email search by domain

<http://emailbydomain.com>

Auto manuals search

<http://auto.somanuals.com>

TV manuals search

<http://tv.somanuals.com>