

TOSHIBA

OWNER'S MANUAL

Projection Television

COLORSTREAM™

50A10

Owner's Record

The model number and serial number are on the back of your TV. Record these numbers in the spaces below. Refer to these numbers whenever you communicate with your Toshiba dealer about this TV.

Model number:

Serial number:

Introduction

Connecting
your TV

Using the
Remote Control

Setting up
your TV

Using the TV's
Features

Appendix

Index

Important Information

WARNING

TO REDUCE THE RISK OF FIRE OR ELECTRIC SHOCK, DO NOT EXPOSE THIS APPLIANCE TO RAIN OR MOISTURE.

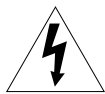
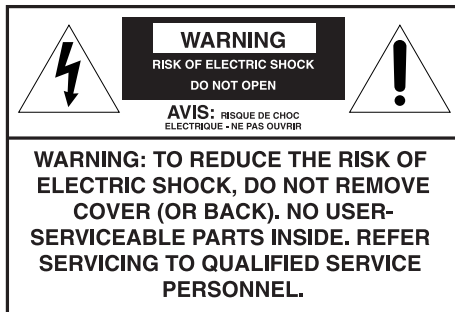

The lightning symbol in the triangle tells you that the voltage inside this product may be strong enough to cause an electric shock. **DO NOT TRY TO SERVICE THIS PRODUCT YOURSELF.**



The exclamation mark in the triangle tells you that important operating and maintenance instructions follow this symbol.

CAUTION

TO PREVENT ELECTRIC SHOCK, DO NOT USE THIS POLARIZED PLUG WITH AN EXTENSION CORD RECEPTACLE OR OTHER OUTLET UNLESS THE PRONGS CAN BE FULLY INSERTED INTO THE OUTLET TO PREVENT ANY EXPOSURE OF THE PRONGS ON THE POLARIZED PLUG.

ATTENTION

POUR PRÉVENIR LES CHOCs ÉLECTRIQUES NE PAS UTILISER CETTE FICHE POLARISÉE AVEC UN PROLONGATEUR, UNE PRISE DE COURANT OU UNE AUTRE SORTIE DE COURANT, SAUF SI LES LAMES PEUVENT ÊTRE INSÉRÉS À FOND SANS EN LAISSER AUCUNE PARTIE À DÉCOUVERT.

CAUTION

The plug has one prong wider than the other and will fit only one way into a standard electrical outlet (120 volt AC, 60 Hz). If the plug does not fit into the outlet, try turning it around. If the plug still does not fit, the outlet is probably non-standard and must be replaced by a qualified electrician. Do not tamper with the plug or try to force it into a non-standard outlet.

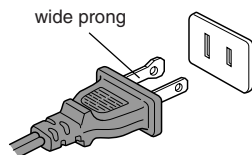

Note to CATV system installers in the USA

This reminder is provided to call the CATV system installer's attention to Article 820-40 of the NEC, which provides guidelines for proper grounding, and, in particular, specifies that the cable ground shall be connected to the grounding system of the building, as close to the point of cable entry as practical.

Precautions

Installing your TV

- Place the TV on the floor or on a sturdy platform. The mounting surface should be flat and steady. If you install the TV on a soft floor, make sure that the floor is not damaged by the weight of the TV.
- Place the TV far enough away from the walls to allow proper ventilation. This will prevent the TV from overheating and avoid possible damage to the TV. Avoid dusty areas too.
- Damage may occur if you leave the TV in direct sunlight or near a heater. Avoid areas subject to extremely high temperatures or humidity, and temperatures of 41°F(5°C) or lower.

Using your TV

- Do not stand or climb on the TV.
- Do not put any heavy object on top of the TV.
- Do not place containers with liquids such as drinks or cosmetics on the TV. If any foreign material or water leaks into the TV, unplug the AC cord and contact your dealer.
- If the room temperature suddenly rises, condensation may occur on the lenses resulting in picture distortion or color fading. In such a case, simply wait a while (with the power on) and the condensation will evaporate.
- Avoid displaying stationary images on your TV screen for extended periods of time. Stationary patterns generated by a picture-in-picture (PIP) display, computer displays, video games, stock market reports, etc., can become permanently engrained on the picture tube. This damage is not protected by your warranty because it is the result of misuse. If you wish to use your TV to display still images, reduce brightness and contrast settings. Never leave a PIP, computer, or video game display unattended.
- Sit approximately 10-25 feet away from the TV. Sitting too far to the left or right of the screen will cause the picture to appear dull as will direct sunlight and room lights. Turn the TV off to check for reflections on the screen. Then remove the source of any reflections while viewing.

Cleaning your TV

- Clean the TV with a soft dry, cloth. Never use strong solvents such as thinner or benzine which might damage the finish of the cabinet. If the cabinet is very dirty, use a damp cloth to wipe the cabinet clean, then finish with a dry cloth.

Introduction	4	ENABLE BLOCKING	26
Welcome to Toshiba	4	TV RATING	
Exploring your new TV	4	(Independent rating system for broadcasters)	26
Connecting your TV	5	MPAA RATING	
Connecting a VCR	5	(Independent rating system for movies)	27
Connecting a cable converter box	6	BLOCKING OPTION	27
Connecting a cable converter box and a VCR	6	Unlocking programs temporarily	28
Connecting a DVD/satellite receiver and a VCR	7	Locking channels	28
Connecting a DVD with ColorStream™ and a VCR	7	Locking video inputs	29
Connecting two VCRs	8	Changing the PIN code	29
Connecting a camcorder	9	Adjusting the picture	30
Connecting an audio system	9	Selecting the picture mode	30
Using the remote control	10	Adjusting the picture quality	30
Preparing the remote control for use	10	Saving new preference	31
Installing the remote control batteries	10	Using the flesh tone feature	31
Using the remote control with a VCR or		Using the noise reduction feature	31
a cable TV converter	10	Selecting the color temperature	32
Programming the remote control for use with a VCR or		Resetting your picture adjustments	32
a cable TV converter	11	Watching video input	33
VCR code table	12	Selecting the video label	33
Cable TV converter code table	13	Using the closed caption feature	34
Learning about the remote control	14	Setting the timer (sleep timer)	35
Setting up your TV	15	Setting the clock	35
Learning about the menu system	15	Adjusting the sound	36
Changing the on-screen display language	16	Muting the sound	36
Adding channels to the TV's memory	17	Selecting stereo/SAP broadcasts	36
Programming channels automatically	17	Using the surround sound feature	37
Adding and erasing channels manually	18	Adjusting the sound quality	38
Changing channels	18	Resetting your audio adjustments	38
Adjusting the color convergence	18	Using the Sub-Bass System (SBS)	39
Using the TV's features	20	Turning off the built-in speakers	39
Adjusting the channel settings	20	Selecting the Audio OUT sound	40
Switching between two channels	20	Selecting the background of the menu display	40
Programming your favorite channels	20	Displaying on-screen information	40
Labeling channels	21	Viewing the demonstration mode	41
Watching picture-in-picture (PIP)	23	Understanding the auto power off feature	41
Switching the main and small pictures	24	Understanding the last mode memory feature	41
Changing the position of the small picture	24	Appendix	42
Freezing the small picture	24	Specifications	42
Using the LOCKS menu	25	Troubleshooting	43
Entering the PIN code	25	Limited United States Warranty	44
Using the V-CHIP menu	26	Index	45

Introduction

Welcome to Toshiba

Congratulations! You have purchased one of the finest projection TVs on the market. The goal of this manual is to guide you through setting up and operating your Toshiba TV as quickly as possible.

Instructions in this manual are based on using the remote control. You can also use the controls on the TV if they have the same name as those on the remote control.

Please read all the safety and operating instructions carefully, and keep the manual for future reference.

Exploring your new TV

You can operate your TV using the buttons on the front panel or the remote control. The back panel and front panel (behind the door) provide all the terminal connections you will need to connect other equipment to your TV.

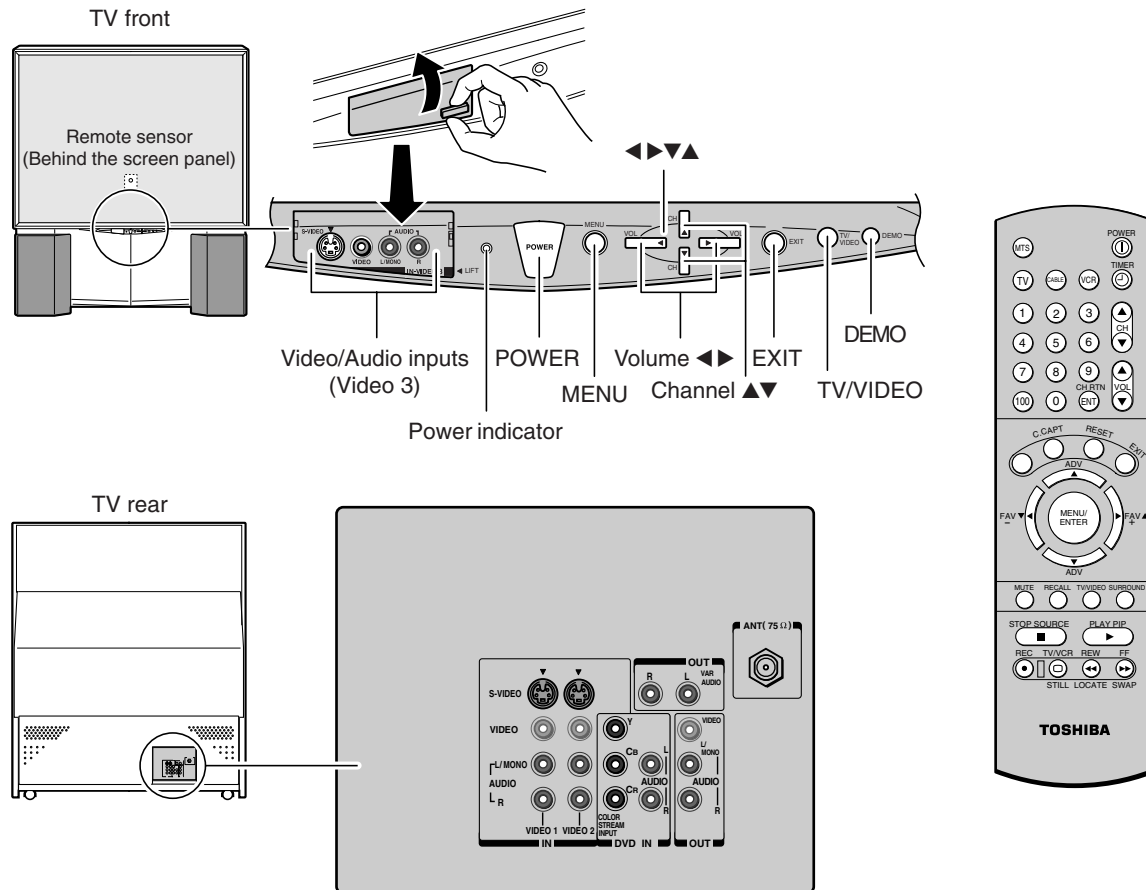

Connecting your TV

If you have not connected electronic equipment before, or you have been frustrated in the past, you may wish to read this section. (Cables are not supplied.)

- A coaxial cable is the standard cable that comes in from your antenna or cable converter box. Coaxial cables use "F" connectors.
- Audio and video cables are usually color coded according to use: yellow for video and red and white for audio. The red audio cable is for the stereo right channel, and the white audio cable is for the stereo (or mono) left channel. If you look at the rear panel of the TV, you will see that the terminals are color coded in the same manner as the cables.
- S-video cables provide better picture performance. S-video cables can only be used with S-video compatible components.
- ColorStream™ cables come in sets of three and provide the best picture performance. ColorStream cables can only be used with ColorStream compatible components.

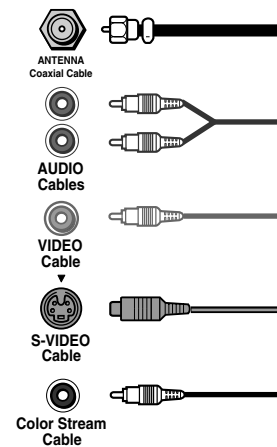

Caution:

Do not plug the TV in until you have finished connecting all of your equipment.

Connecting a VCR

This connection allows you to watch local channels and video programs, play or record on the VCR while watching TV, and record from one channel while watching another channel.

You will need:

- one coaxial cable
- one pair of audio cables (only one cable for a mono VCR)
- one video cable

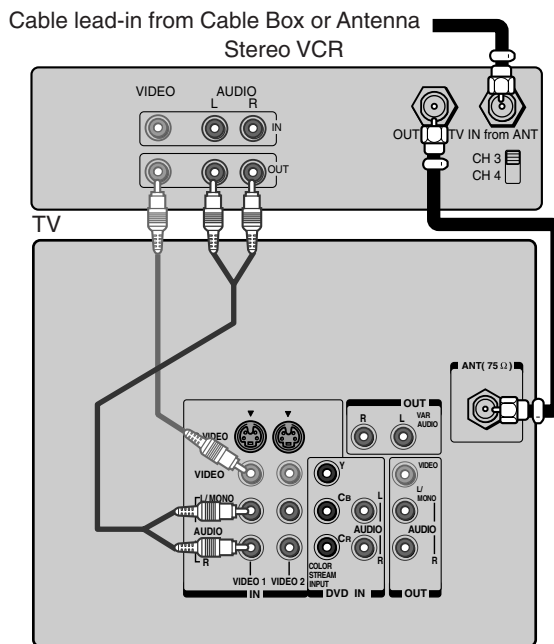

Caution:

If you have a mono VCR, connect L/Mono to VCR Audio OUT using only one audio cable.

If you have an S-VHS VCR, use the S-video connections and remove the video cable.

Do not connect the video cable and the S-video cable to Video-1 simultaneously.

Connecting a cable converter box

This connection allows you to watch cable and premium channels. You should place the A/B switch in the "A" position so that you can use the TV's features. When viewing premium channels, switch to "B" and tune the TV to channel 3 or 4 (whichever channel is vacant in your area), then use the converter box to change channels.

You will need:

- one two-way signal splitter (Not supplied)
- one A/B switch (Not supplied)
- four coaxial cables

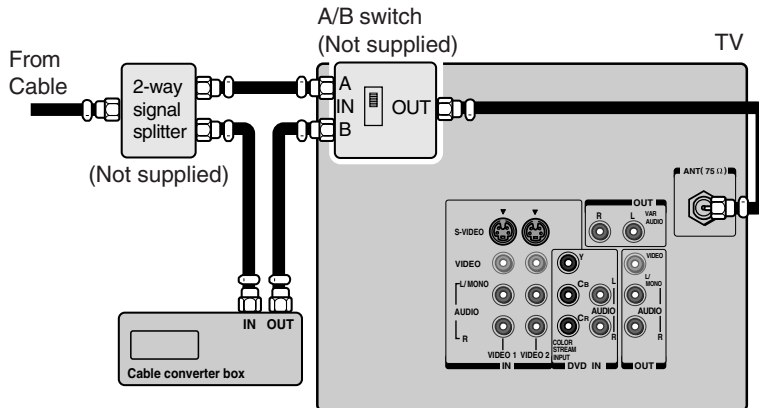

Note:

When you use a converter box with your TV, there may be features that you cannot program using the remote control, such as programming your favorite channels, labeling channels, and locking channels.

Connecting a cable converter box and a VCR

This connection allows you to watch and record basic and premium cable channels, as well as watch videotapes. You should keep your TV selected to TV so that you can use the TV's features. When viewing premium channels or recording with the VCR, select Video 1 (see page 33), turn on the VCR, set the VCR channel to 3 or 4 (whichever channel is vacant in your area), then use the cable converter box to change channels. To watch a basic cable channel while recording with the VCR, the TV should be left in TV mode.

You will need:

- one two-way signal splitter
- three coaxial cables
- one pair of audio cables (only one cable for a mono VCR)
- one video cable

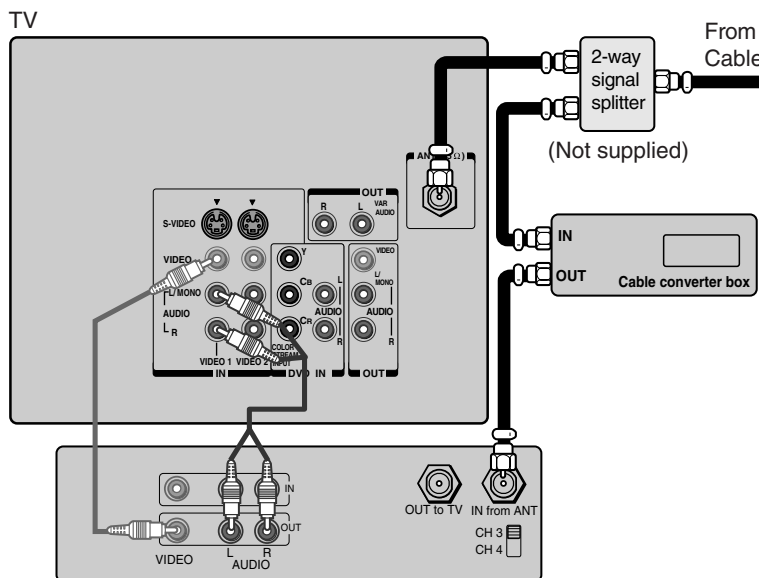

Caution:

If you have a mono VCR, connect L/Mono to VCR Audio OUT using only one audio cable.

If you have an S-VHS VCR, use the S-video connections and omit the video cable. Do not connect the video cable and the S-video cable to Video-1 simultaneously.

When you use a converter box with your TV, there may be features that you cannot program using the remote control, such as programming your favorite channels, labeling channels, and locking channels.

Connecting a DVD/satellite receiver and a VCR

This connection allows you to watch DVD/satellite, video and TV programs. You can record one TV channel while watching another channel.

You will need:

- one coaxial cable
- two pairs of audio cables (one single and one pair of audio cables for a mono VCR)
- one video cable
- one S-video cable

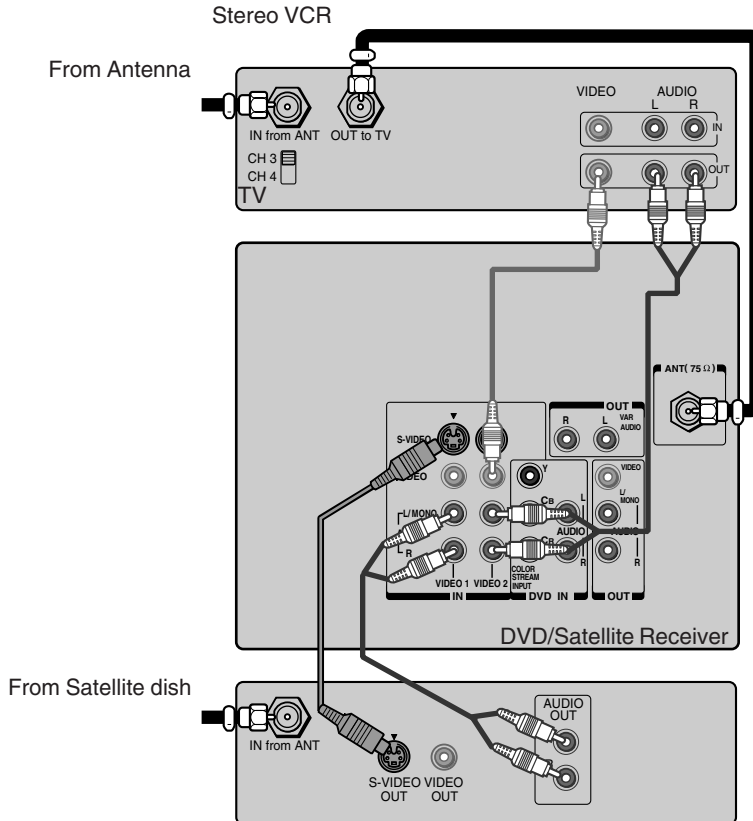

Caution:

You can use a video cable instead of the S-video cable, but the picture quality will decrease. If you use an S-video cable between the TV and DVD/satellite receiver, make the audio connections only and omit the video connection.

Do not connect the video cable and the S-video cable to Video-1 simultaneously.

The unauthorized recording of television programs, videotapes, and other materials may infringe upon the provisions of copyright laws.

Connecting a DVD with ColorStream™ and a VCR

This connection allows you to watch DVD, video, or TV programs and to record DVD or TV programs. You can record from one source and watch a program from another source. Your TV is capable of using ColorStream (component video). Connecting your TV to a ColorStream compatible DVD, such as a Toshiba DVD, can greatly enhance picture quality and performance.

You will need:

- one coaxial cable
- three pairs of audio cables (two single and one pair of audio cables for a mono VCR)
- two video cables
- one set of ColorStream video cables

(See illustration on next page)

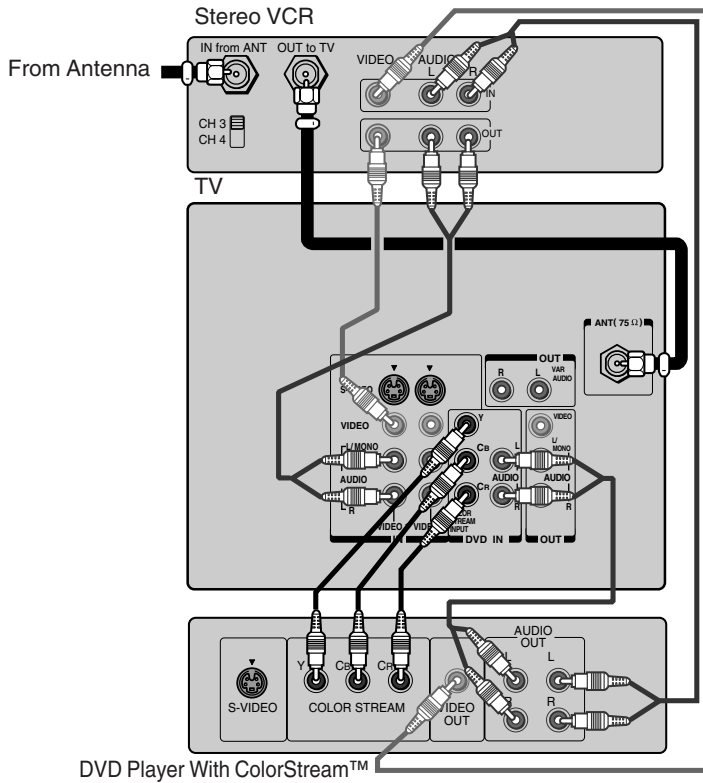

Caution:

To play from the DVD, the DVD and TV must use ColorStream connections. To record from the DVD, the VCR must select Line IN.

The unauthorized recording of television programs, videotapes, and other materials may infringe upon the provisions of copyright laws.

Connecting two VCRs

This connection allows you to record (dub/edit) from one VCR to another VCR while watching a video program. You also can record from one TV channel while watching another channel.

You will need:

- one coaxial cable
- two pairs of audio cables (two single cables for mono VCRs)
- two video cables

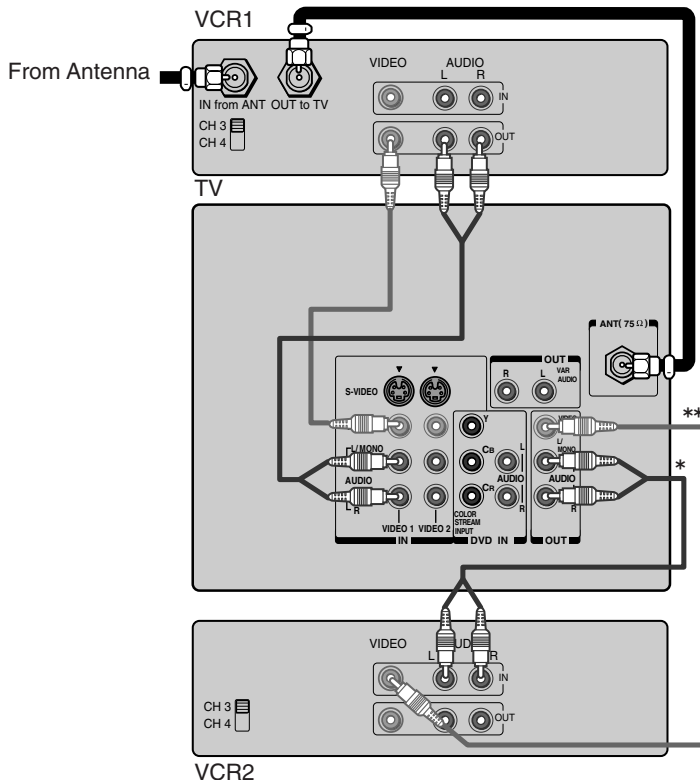

Caution:

Do not connect one VCR to the output and input jacks on the TV at the same time. If you are using an S-VHS VCR, use the S-video connections and omit the video cable. Do not connect the video cable and the S-video cable to Video-1 simultaneously.

The unauthorized recording of television programs, videotapes, and other materials may infringe upon the provisions of copyright laws.

Note:

- To dub or edit, VCR 2 must select Line IN, and the TV must select Video-1.
- * The Audio OUT jacks can output the sound of either the Main or PIP picture (see "Selecting the Audio OUT sound" on page 40.)
- ** The Video OUT jack does not output the PIP picture.

Connecting a camcorder

This connection allows you to watch video materials recorded on a camcorder.

You will need:

- one pair of audio cables
- one video cable

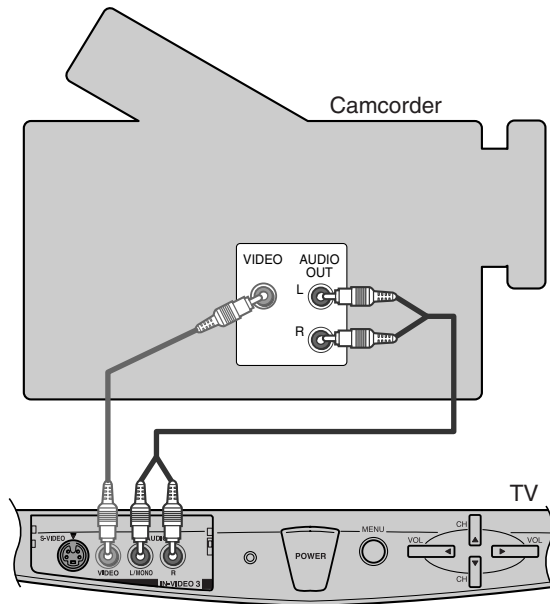

Caution:

If you are using an S-VHS camcorder with an S-video output, connect this to the S-video input on the TV and omit the video cable.

Do not connect the video cable and the S-video cable to Video-3 simultaneously.

Connecting an audio system

This connection allows you to use an audio amplifier to adjust the audio level. This also allows you to use external speakers.

To control the audio, turn on the TV and the stereo amplifier, then turn off the built-in speakers. (See “Turning off the built-in speakers” on page 39.)

You will need one pair of audio cables.

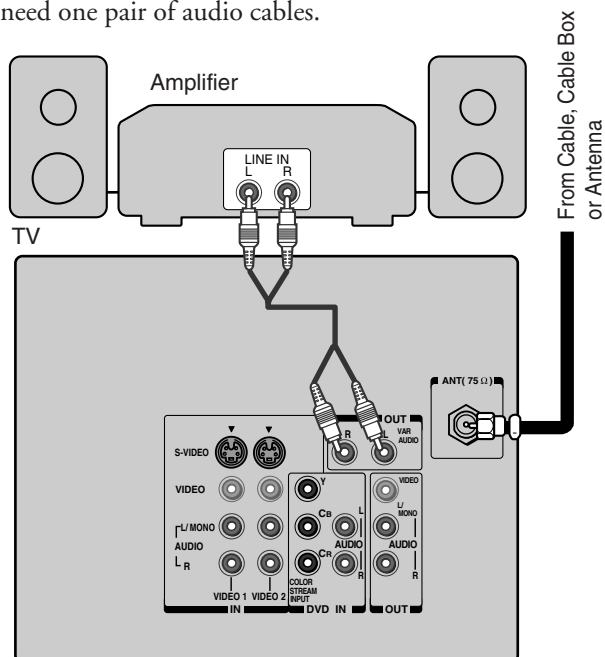

Note:

To hear the audio, the volume of both the TV and the external audio amplifier must be set above minimum (zero). For example, if you set the volume of the TV to zero, you will not be able to hear any audio, even if you adjust the volume of the amplifier to the maximum setting.

Using the remote control

Preparing the remote control for use

The remote control will operate your TV, most VCR models, and most cable TV converters together, even if they are different brands. If you will be using your TV with a Toshiba VCR, your remote control is already programmed and ready to use. If you own different brands of VCRs and/or converters, you first have to program your remote control. (See "Programming the remote control for use with a VCR or a cable TV converter" on page 11.)

Installing the remote control batteries

To install the batteries:

1. Slide the battery cover off the back of the remote control.

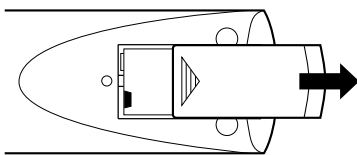

2. Install two "AA" size batteries. Match the + and - signs on the batteries to the signs on the battery compartment.

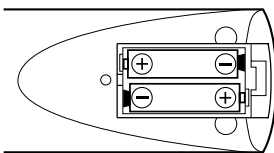

3. Slide the battery cover back on to the remote control until the lock snaps.

Using the remote control with a VCR or a cable TV converter

To control a Toshiba VCR:

Press the VCR button until it blinks. The shaded buttons in the illustration at right will then control the VCR. The unshaded buttons will operate the TV as usual.

If you own different brands of VCRs, program the remote control to recognize the brand of your VCR. (See "Programming the remote control for use with a VCR or a cable TV converter" on page 11.)

Note:

This remote control's functions may or may not operate your VCR or cable TV converter. Refer to the owner's manuals supplied with the equipment to see which features are available. In addition, the original controllers may have features not available on this remote control. If you would like to continue to use these features, you may want to use the original remote control.

Caution:

- Dispose of batteries in a designated disposal area. Do not throw batteries into a fire.
- Do not mix battery types or combine used batteries with new ones.
- Remove dead batteries immediately to prevent battery acid from leaking into the battery compartment.
- If you do not intend to use the remote control for a long time, remove the batteries.

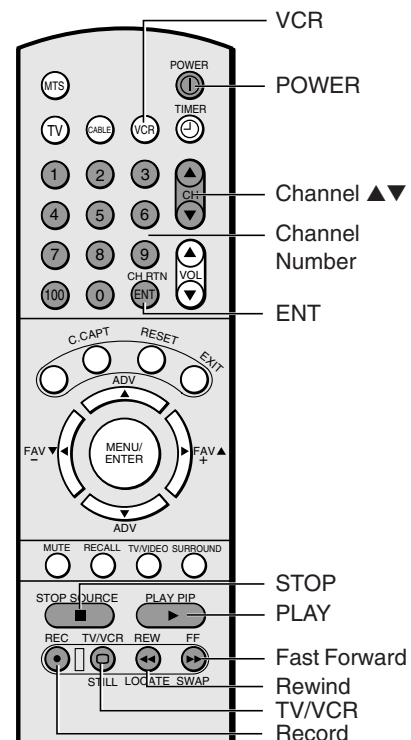

To control a cable TV converter:

Program the remote control to recognize the brand of your converter. The shaded buttons in the illustration at right will then control the cable TV converter.

Press the CABLE button when you want to control the cable TV converter.

Programming the remote control for use with a VCR or a cable TV converter

The remote control provided with your TV is preprogrammed to operate Toshiba brand VCRs. You can program your TV remote control to operate other brands of VCRs and cable TV converters as well.

To program your TV remote control to operate non-Toshiba VCRs and cable TV converters:

1. Refer to the VCR and cable TV converter code tables on pages 12–13 to find the corresponding code for your VCR or converter brand.

If more than one code is listed, try each one separately until you find the one that works.

2. Turn on the device (VCR or converter) whose code you are programming.
3. Press the corresponding device button (VCR or CABLE) and the ENT/CH RTN button at the same time. The device button will light up, indicating that it is in the program mode. Perform steps 4 and 5 while the button is lighted (about 20 seconds).
4. Point the remote control toward the VCR or converter, and press the Channel Number buttons to enter the three-digit code for your VCR or converter brand.

- If the correct code was entered, the VCR or converter will turn off.
- If the VCR or converter does not turn off, repeat steps 1–4 using another code.

When the correct code is entered, the lighted button will blink.

5. Press the corresponding device button (VCR or CABLE) to release the program mode.
6. Press TV to control the TV.

For future reference, write down the code numbers you used:

VCR code _____

Cable code _____

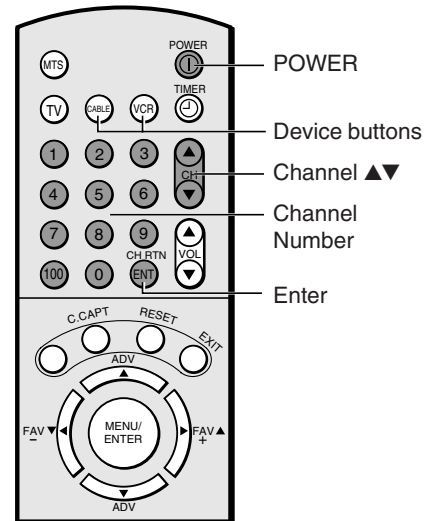

Note:

- Each time you replace the batteries, you must reprogram the remote control.
- Some newer VCRs are capable of working on either of two remote codes. These VCRs have a switch labeled "VCR1/VCR2."

If your VCR has this kind of switch and does not respond after programming to any of the codes for your VCR brand, set the switch to the other position (VCR1 or VCR2) and reprogram the remote control.

VCR code table

Brand name	Code number				
AIWA	034	MARTA	101	STS	013
AKAI	146, 043, 046, 124, 142, 016	MATSUI	202	SYLVANIA	031, 034, 067
ALBA	202	MEI	031	SYMPHONIC	034
AMPRO	072	MEMOREX	101, 003, 010, 014, 031, 034, 053, 072	TANDY	010, 034
ANAM	031	MGA	045, 046, 059	TATUNG	043
AUDIO		MINOLTA	013, 020	TEAC	034, 043
DYNAMICS	012, 023, 043	MITSUBISHI	059, 061, 046, 051, 142, 013, 020, 045	TECHNICS	031, 070
BRANDT	204	MTC	034, 040	TEKNIKA	031, 019, 034, 101
BROKSONIC	035, 037, 129, 203	MULTITECH	024, 034	TELEFUNKEN	204
CANON	031	NEC	012, 023, 043, 048	THOMAS	034
CRAIG	003, 040	NORDMENDE	043	TMK	006
CURTIS MATHES	031, 041	OPTONICA	053, 054	TOSHIBA	001, 112, 131, 008, 047, 059, 082, 013, 017
DAEWOO	010, 110, 111, 112, 017	ORION	202	TOTEVISION	040, 101
DBX	012, 023, 043	PANASONIC	070, 140, 201, 031	UNITECH	040
DYNATECH	034, 053	PENTAX	013, 020, 031, 063	VECTOR	
ELECTROHOME	059	PHILCO	031, 034, 067	RESEARCH	012
EMERSON	006, 029, 035, 025, 034, 036, 037, 046, 101, 129, 131, 138, 017, 031, 202, 203	PHILIPS	031, 067, 034, 101, 054	VIDEO	
FISHER	003, 008, 009, 010	PILOT	101	CONCEPTS	012, 046, 034, 141
FUNAI	034	PIONEER	021, 048, 013	VIDEOSONIC	040
GE	031, 072, 144, 147, 063, 107, 109, 205, 206, 207, 208	PULSAR	072	WARDS	013, 024, 031, 034, 040, 053, 054, 003, 017, 131
GO VIDEO	132, 136	QUARTZ	014	YAMAHA	012, 043, 034
GOLDSTAR	012, 013, 020, 101, 123	QUASAR	031	ZENITH	072, 080, 056, 048, 034, 101, 058
HARMAN		RCA	013, 020, 034, 041, 040, 107, 109, 140, 144, 147, 031, 205, 206, 207, 208		
KARDON	012, 045	REALISTIC	003, 008, 010, 014, 031, 034, 040, 053, 054, 101		
HITACHI	004, 026, 034, 043, 063, 047, 013	RICOH	058		
INSTANTREPLAY	031	RUNCO	072		
JCL	031	SALORA	014		
JCPENNY	012, 013, 040, 101, 031	SAMSUNG	040, 107, 109, 112, 017, 205, 206		
JENSEN	043	SANSUI	043, 048		
JVC	048, 043, 130, 152, 055, 060, 012, 031, 047	SANYO	003, 010, 014		
KENWOOD	014, 048, 043	SCOTT	017, 037, 129, 112, 131		
LLOYD	034	SEARS	003, 008, 010, 013, 014, 017, 101, 009, 031		
LXI	003, 009, 017, 034, 101, 013, 014	SHARP	031, 054, 053		
MAGIN	040	SHINTOM	024		
MAGNAVOX	067, 031, 034, 041	SONY	056, 057, 058, 003, 052, 031		
MARANTZ	031, 067, 012	SOUNDESIGN	034		

Cable TV converter code table

Brand name	Code number		
ABC	001, 004, 039, 045, 053, 003, 042	RCA	047
ANTRONIK	014	REGAL	049, 050
ARCHER	005, 007, 014, 024	REGENCY	057
CABLE STAR	026	REMBRANT	025
CENTURY	007	RK	091
CITIZEN	007	SAMSUNG	030, 068
COLOUR VOICE	065, 090	SCIENTIFIC	
COMBANO	080, 081	ATLANTA	003, 011, 041, 042, 043, 045, 046
COMTRONICS	019, 030, 202	SHERITECH	022
DIAMOND	023	SIGNAL	030
EAGLE	020, 030, 040	SIGNATURE	001
EASTERN	057, 062, 066	SL MARX	030
ELECTRICORD	032	SPRUCER	047, 078
GE	072	STANDARD	
GEMINI	008, 022, 025, 054	COMPONENTS	203
GI	001, 074	STARCOM	002, 004, 008, 009
GOLDEN		STARGATE	008, 030
CHANNEL	030	SYLVANIA	067
HAML IN	049, 050, 055, 204, 207	TADIRAN	030
HITACHI	001, 055	TANDY	017
HOSPITALITY	070, 077	TELECAPATION	021
JERROLD	002, 003, 004, 010, 001, 008, 009, 069, 074, 201	TEXSCAN	029, 067
M-NET	037	TOCOM	039, 040, 056
MACOM	033	TOSHIBA	052
MAGNAVOX	012, 079, 010, 064	UNIKA	007, 014, 024
MEMOREX	052	UNITED CABLE	004, 053
MOVIE TIME	028, 032	UNIVERSAL	007, 024, 027, 035, 005, 014, 026, 032
NSC	071, 073, 015, 028, 038	VIEWSTAR	086, 087, 088, 089, 012, 015, 018, 202, 205
OAK	016, 031, 037, 053	ZENITH	052, 060, 093
PANASONIC	044, 047		
PARAGON	052		
PHILIPS	020, 065, 006, 012, 013, 085, 090, 202		
PIONEER	034, 051, 001, 063, 076		
POPULAR			
MECHANICS	206		
POST NEWS			
WEEK	016		
PRUCER	059		
PTS	011, 048, 071, 072, 073, 074		
PULSAR	052		

Learning about the remote control

MTS displays the AUDIO menu (page 36)

POWER turns the TV on and off

TV controls the TV

CABLE controls the cable TV converter (page 11)

VCR controls the VCR (page 10)

TIMER displays the CUSTOM menu to set the sleep timer (page 35)

Channel Numbers [0-9,100] allow direct access to channels (page 18)

CH ▲▼ cycles through the programmed channels (page 18)

VOL ▲▼ adjusts the volume level (page 36)

CH RTN returns to the last viewed channel (page 20)

ENT required by some VCRs and cable TV converters to change channels

C. CAPT selects the closed caption mode (page 34)

RESET resets audio and picture adjustments to the factory settings (pages 32, 38)

EXIT exits the programming menus (page 15)

MENU [MENU/ENTER Button] allows access to programming menus (page 15)

ENTER [MENU/ENTER Button] sets programmed menu information (pages 15, 19-22)

▲▼ ◀▶ Buttons select or adjust programming menus (page 15)

FAV ▼▲ Buttons cycle through favorite channels (page 20)

MUTE mutes the sound (page 36)

RECALL displays on-screen information (page 40)

TV/VIDEO selects the video input source (page 33)

SURROUND turns the surround sound on and off (page 37)

PIP Buttons allow access to PIP functions (pages 23-24)

PIP turns PIP on and off

SOURCE selects the PIP input source

STILL freezes the PIP

LOCATE changes the position of the PIP

SWAP switches the main and PIP pictures

VCR Buttons allow access to VCR functions (page 10)

PLAY plays a videotape

STOP stops a videotape

REC starts recording a videotape

TV/VCR toggles between TV and VCR when viewing while recording

REW rewinds a videotape

FF fast forwards a videotape

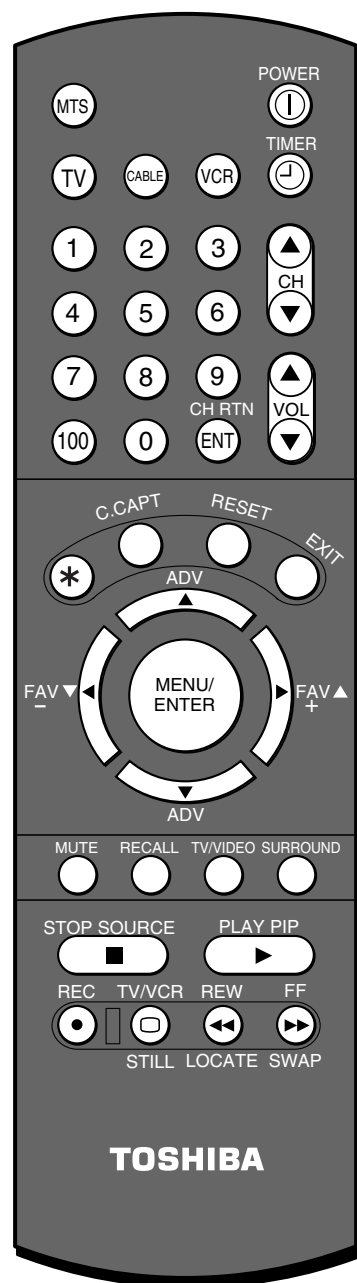

* Vacant button

Setting up your TV

Learning about the menu system

After you have installed the batteries and programmed the remote control, you will need to set some preferences on the TV using the menu. You can access the menu using the buttons on your TV or remote control.

1. Press MENU to display a menu.
2. Press ◀ or ▶ to select a menu.
3. Press ▲ or ▼ select an item.
4. Press ◀ or ▶ to select or adjust a setting.

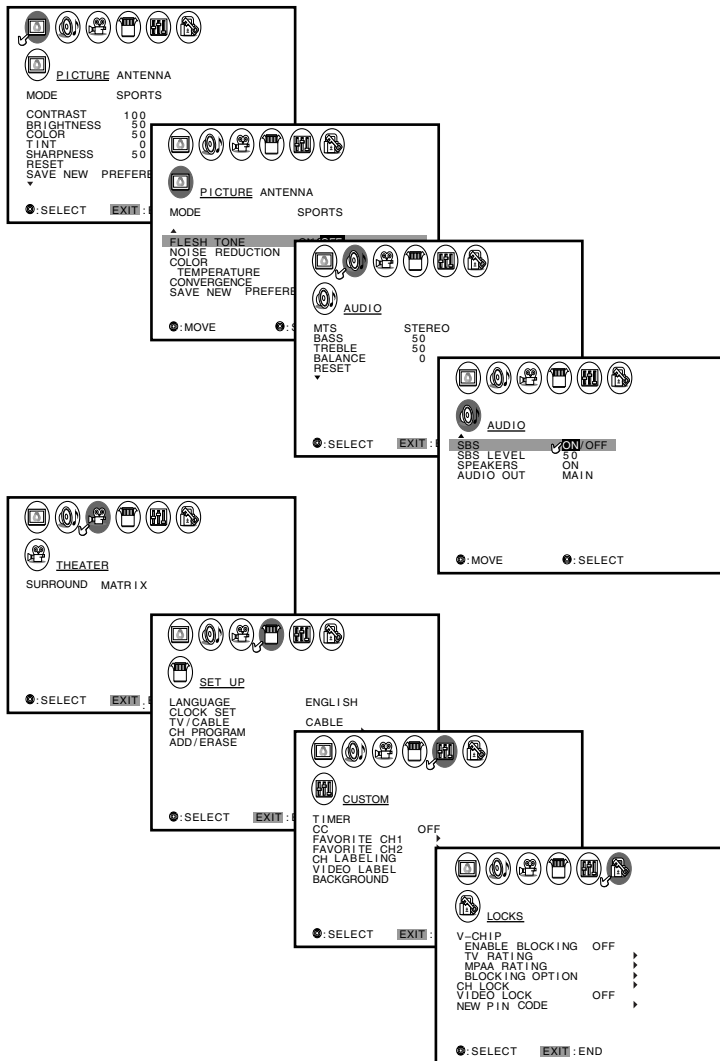

- Press ENTER to activate the function settings in the SET UP menu.
- The main menu display will disappear automatically if you do not make a selection within 15 seconds; the other displays will disappear automatically within 6 seconds (except the Convergence menu, which will remain until a button is pressed).
- If you want to close all the on-screen displays instantly, press EXIT.

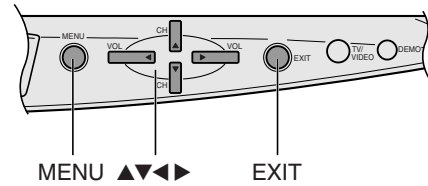

MENU ▲▲▲▶▶▶ EXIT

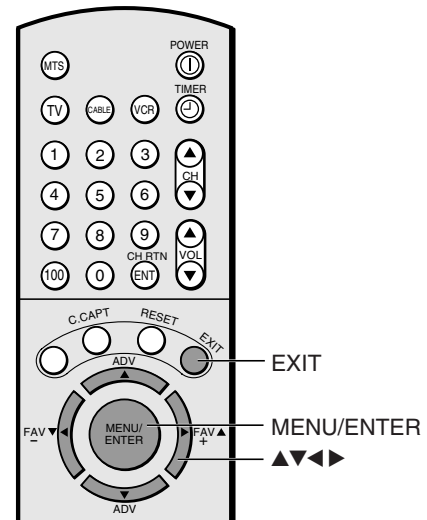

EXIT

MENU/ENTER

Notes:

- The menu illustrations in the following pages have been distorted for easy reference.
- You can change the background of the menu. See page 40 for details.

Changing the on-screen display language

You can choose from three different languages (English, French, and Spanish) for the on-screen displays. Adjustment menus and messages will appear in the language of your choice.

To select a language:

1. Press MENU, then press ◀ or ▶ until the SET UP menu appears.

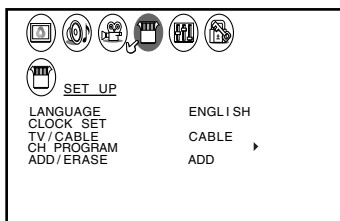

2. Press ▲ or ▼ to highlight LANGUAGE.

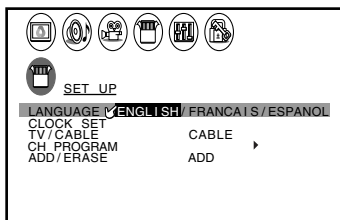

3. Press ◀ or ▶ to highlight your desired language.

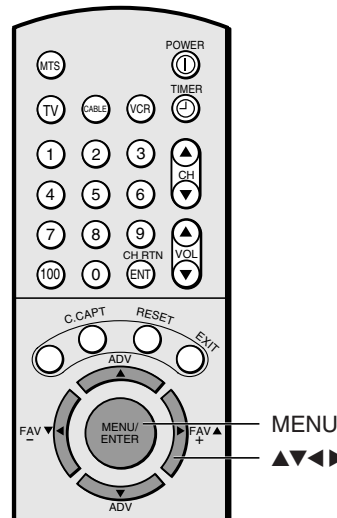
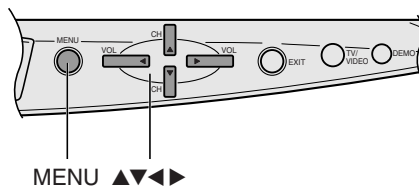
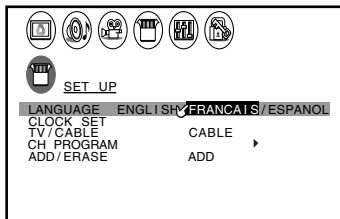

Adding channels to the TV's memory

When you press Channel ▲ or ▼, your TV will stop only on channels that are stored in the TV's channel memory.

Note: To tune the TV to a channel not programmed in the channel memory, use the Channel Number buttons on the remote control.

Follow the steps below and on the next page to program channels into the TV's memory.

Programming channels automatically

Your TV can automatically detect all active channels in your area and store them in its memory. After the channels are stored automatically, you can manually add or erase individual channels (see page 18).

To program channels automatically:

1. Press MENU, then press ◀ or ▶ until the SET UP menu appears.
2. Press ▲ or ▼ until the TV/CABLE is highlighted.
3. Press ◀ or ▶ to highlight either TV or CABLE, depending on which you use. If you use an antenna, highlight TV; if you use cable, highlight CABLE.

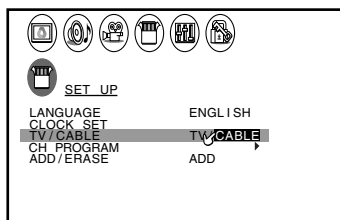

4. Press ▼ to select CH PROGRAM.

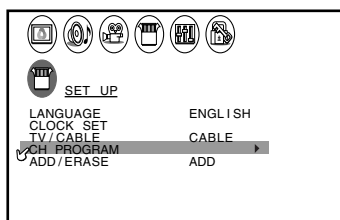

5. Press ◀ or ▶ to start channel programming. The TV will automatically cycle through all the TV or Cable channels (depending on which you selected), and store all active channels in the channel memory.

While the TV is cycling through the channels, the message "Programming Now—Please Wait" appears.

6. When channel programming is complete, the message "CH Programming Completed" appears.
7. Press Channel ▲ or ▼ to view the programmed channels.

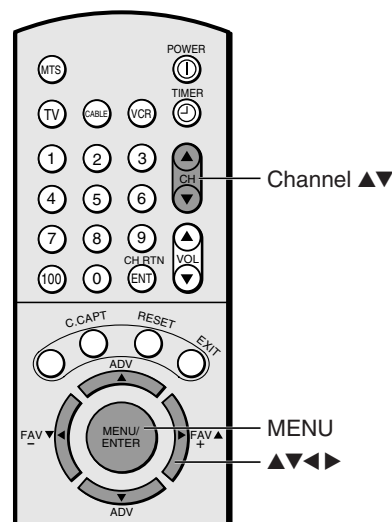

Adding and erasing channels manually

After you have automatically programmed the channels into the channel memory, you can manually add or erase specific channels.

To add or erase channels:

1. Select the channel you want to add or erase. If you are adding a channel, you must select the channel using the Channel Number buttons.
2. Press MENU, then press ◀ or ▶ until the SET UP menu appears.
3. Press ▲ or ▼ to highlight ADD/ERASE.

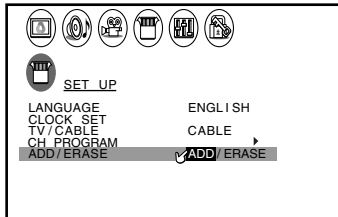

4. Press ◀ or ▶ to select ADD or ERASE, whichever function you want to perform.
5. Repeat steps 1–4 for other channels you want to add or erase.

Changing channels

To change to the next programmed channel:

Press Channel ▲ or ▼ on the TV or remote control.

To change to a specific channel (programmed or unprogrammed):

Press the Channel Number buttons (0–9 and 100).

For channels 100 and higher, press the 100 button, then the next two numbers. For example, to select channel 125, press 100–2–5.

Adjusting the color convergence

This projection TV uses three separate TV tubes: red, green, and blue. The separate red, green, and blue images are projected onto the screen where they converge to form a full-color picture. The picture will be clear only when the three images converge correctly. Convergence may drift over time or if you move the TV. If your TV's picture is clear, skip this procedure.

This adjustment should be made after the TV has been on for at least 30 minutes.

To check and adjust the color convergence:

1. Press MENU, then press ◀ or ▶ until the PICTURE menu appears.
2. Press ▲ or ▼ to highlight CONVERGENCE.

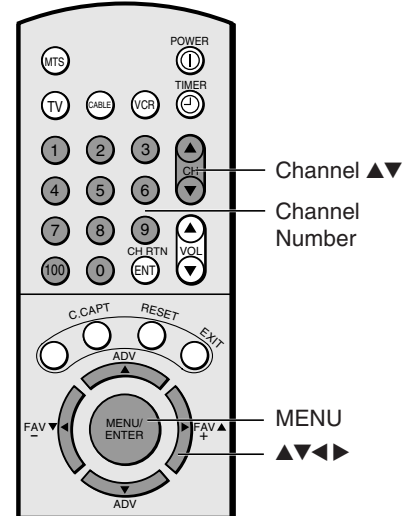
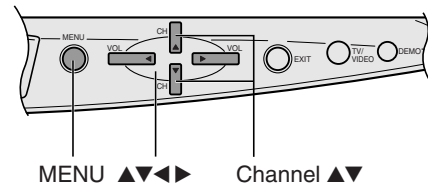
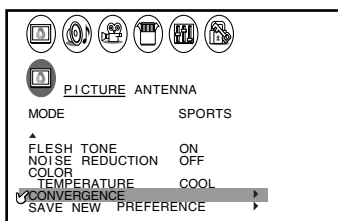

- Press ◀ or ▶ to display the center CONVERGENCE menu.

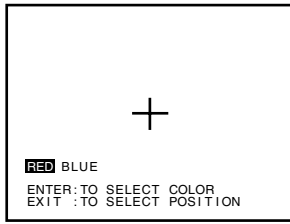

If you see separate red, blue, and green crossed lines (or red and blue shadows next to white lines), you need to adjust the convergence.

- Press ENTER to highlight RED or BLUE, depending on which color needs adjusting. If both red and blue need adjusting, you will need to perform steps 4 and 5 two times.
- Press ▲ (up), ▼ (down), ◀ (left), or ▶ (right) on the remote control to converge the red or blue lines into the green lines, which will become completely white when correctly adjusted.
- Press EXIT to display the circumference CONVERGENCE menu.
- Press the corresponding Number button (1–9) to select the area of the screen you want to adjust.

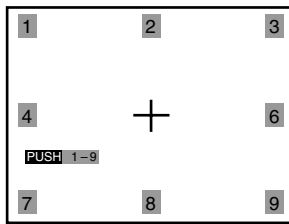

- Press ENTER to highlight RED or BLUE, depending on which color needs adjusting. If both red and blue need adjusting, you will need to perform steps 8 and 9 two times for the selected area.

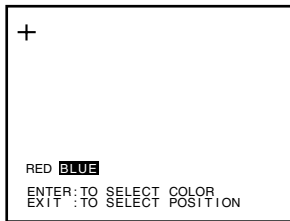

- Press ▲▼◀▶ to converge the red or blue lines into the green lines, which will become completely white when correctly adjusted.
- Press EXIT once to select another area to adjust, then repeat steps 7–9.
- Press EXIT two times to close the CONVERGENCE menu.

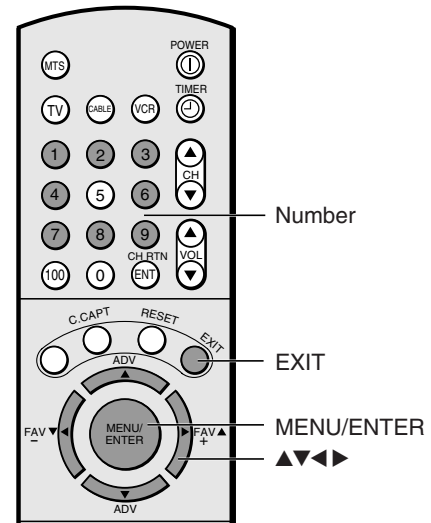

Using the TV's features

Adjusting the channel settings

Switching between two channels

You can switch between two channels without entering an actual channel number each time.

To switch between two channels:

1. Select the first channel you want to view.
2. Select a second channel with the Channel Number buttons (0–9, 100).
3. Press CH RTN. The previous channel will be displayed.

Each time you press CH RTN, the TV will switch back and forth between the two channels.

Programming your favorite channels

You can preset up to 9 of your favorite channels each for FAVORITE 1 and FAVORITE 2 modes using the Favorite Channel Programming feature. Because this feature scans through only your favorite channels, it allows you to skip other channels you do not normally watch.

You can still use Channel ▲▼ to scan through all the channels you programmed in the TV's memory.

To program your favorite channels:

1. Press MENU, then press ◀ or ▶ until the CUSTOM menu appears.
2. Press ▲ or ▼ to highlight FAVORITE CH1 or FAVORITE CH2.

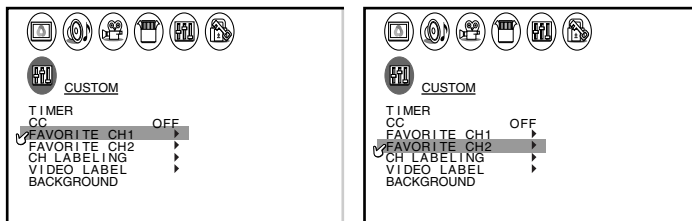

3. Press ◀ or ▶ to display the FAVORITE CH1 menu for example. CH INPUT will be highlighted.

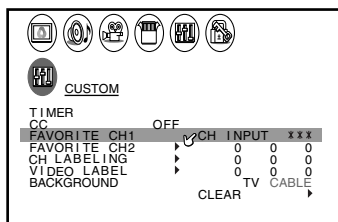

4. Press the Channel Number buttons to enter your favorite channel.
5. Press ENTER.
6. Repeat steps 4 and 5 for other channels.

To select your favorite channels:

Press FAV ▼ or ▲.

The FAV ▼▲ buttons will not operate until you have programmed your favorite channels.

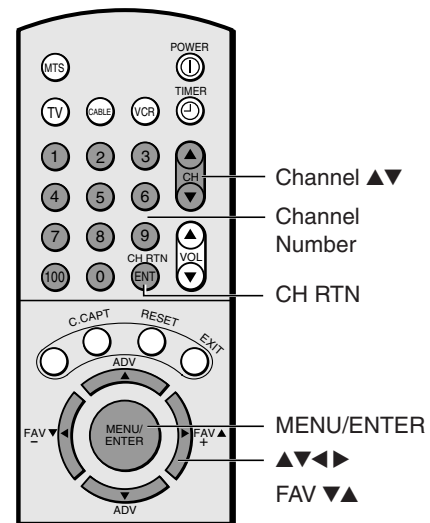

Note:

The FAV ▼▲ buttons will operate as the menu ◀▶ buttons while the menu display is on the screen.

To clear your favorite channels:

1. Press MENU, then press ◀ or ▶ until the CUSTOM menu appears.
2. Press ▲ or ▼ to highlight FAVORITE CH2 for example.
3. Press ◀ or ▶ to display the FAVORITE CH2 menu.

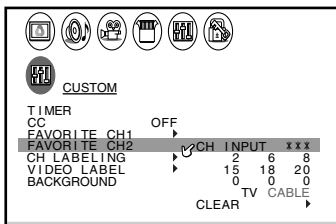

4. Press ▲ or ▼ to highlight CLEAR, then press ▶ or ◀ until "0" replaces the channel numbers you have programmed.

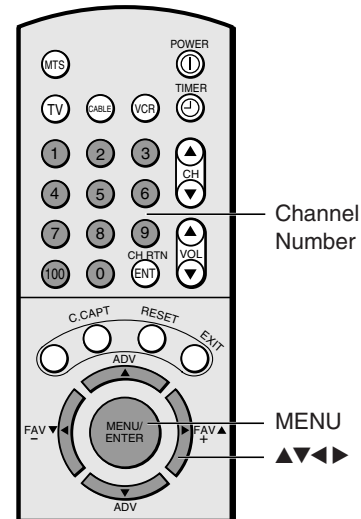
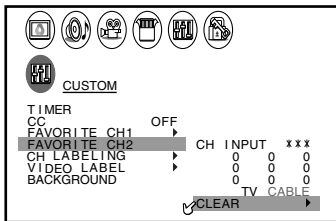

Labeling channels

Channel labels will appear over the channel number display each time you turn on the TV, select a channel, or press the RECALL button. You can choose any four characters to identify the channels.

To create channel labels:

1. Press MENU, then press ◀ or ▶ until the CUSTOM menu appears.
2. Press ▲ or ▼ to highlight CH LABELING.
3. Press ◀ or ▶ to display the CH LABELING menu.
CH INPUT will be highlighted.

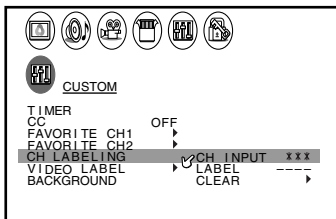

4. Press the Channel Number buttons to select a channel you want to label.

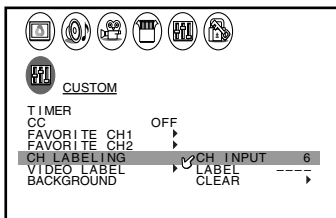

5. Press ▼ to highlight LABEL.

- Assign the label to the channel. Press ◀ or ▶ to enter a character in the first space. Press the button repeatedly until the character you want appears on the screen. Press ENTER.

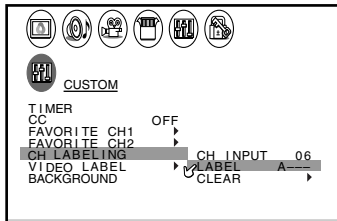

- Repeat step 6 to enter the rest of the characters. If you would like a blank space in the label name, you must choose an empty space from the list of characters. Otherwise, a dash “-” will appear in that space.
- Repeat steps 4–6 for other channels. You can assign labels to a maximum of 32 channels.

To erase channel labels:

- Press MENU, then press ◀ or ▶ until the CUSTOM menu appears.
- Press ▲ or ▼ to highlight CH LABELING.
- Press ◀ or ▶ to display the CH LABELING menu.
- Press ▼ to highlight CH INPUT, then select the channel you want to clear with the Channel Number buttons.
- Press ▼ to highlight CLEAR.

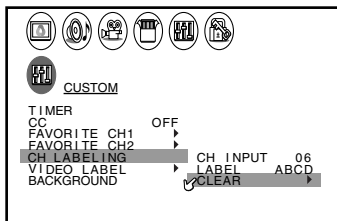

- Press ◀ or ▶ to erase the channel label.
- Repeat steps 4–6 to erase other channel labels.

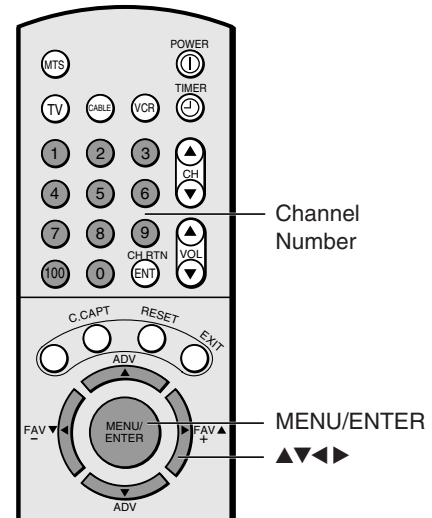

Watching picture-in-picture (PIP)

The picture-in-picture (PIP) feature allows you to watch two pictures at the same time. The smaller picture comes from an external source, such as a VCR.

To display a picture from an external source as a small picture:

1. Make sure you have connected the external source equipment properly. For more information, see "Connecting your TV" on page 5.
2. Turn on the TV and select the program you want to watch.
3. Press PIP once to display a small picture. A window 1/9 the size of the screen will appear. Press PIP a second time to display a 1/16-size window.

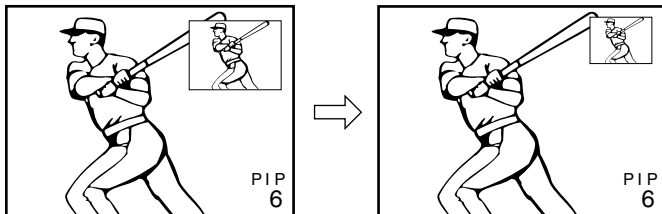

4. Press SOURCE repeatedly to select the input source (VIDEO 1, VIDEO 2 or VIDEO 3) for the small picture. The selected source will be displayed in purple. ColorStream cannot be selected.

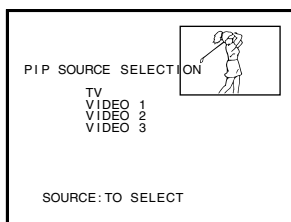

5. Select a channel for the small picture using the VCR's channel keys, or play a tape as the small picture.

To turn PIP off:

Press PIP once or twice, depending on the size of the small picture screen you selected.

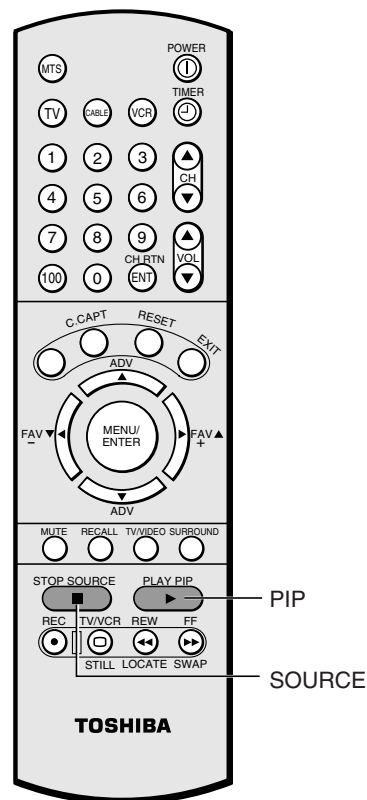

Note:

PIP cannot be turned on when the ColorStream input is being viewed.

Switching the main and small pictures

Press SWAP while you are using the PIP feature to switch the main and small pictures. The main and small pictures will switch each time you press the SWAP button.

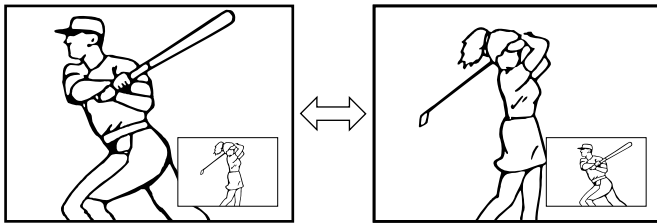

Changing the position of the small picture

Press LOCATE repeatedly while you are watching a small picture. The display position of the small picture will change in the following order:

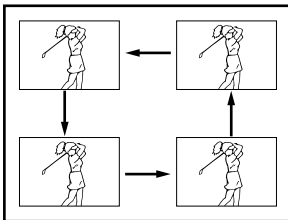

Freezing the small picture

Press STILL while you are watching a small picture. The small picture will become a still picture. To return to the moving picture, press STILL again.

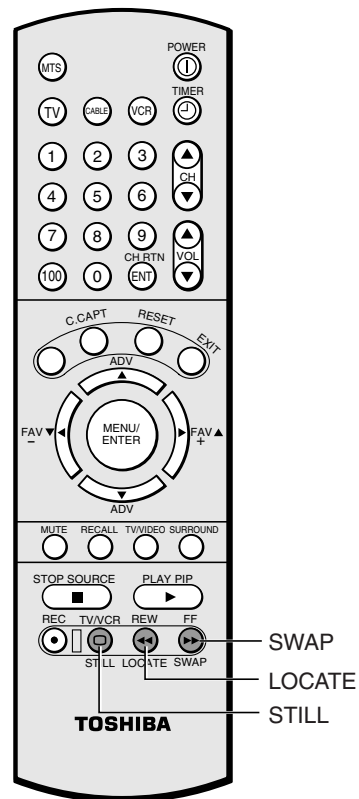
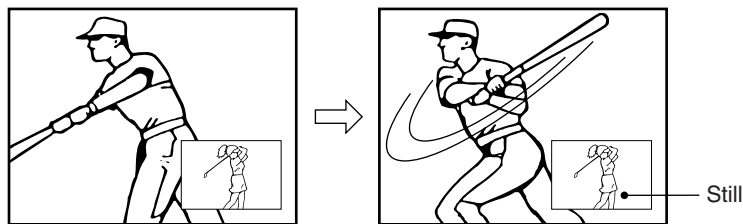

Using the LOCKS menu

The LOCKS menu includes the V-CHIP, CH LOCK, VIDEO LOCK, and NEW PIN CODE functions. You can use these functions after entering the correct PIN code.

Entering the PIN code

1. Press MENU, then press ◀ or ▶ until the LOCKS menu appears.

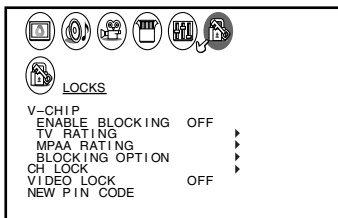

2. Press ▲ or ▼ to display the PIN code entering mode.

- Factory reset status:

Set your 4-digit code by pressing the Number buttons (0–9).



- When the PIN code is already stored:

Press the Number buttons (0–9) to enter the 4-digit PIN code used to block channels.

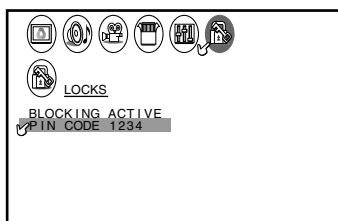

If the correct PIN code is not entered, the message “Incorrect PIN Code” will appear. Try to enter the correct code again.

If you cannot remember the PIN code you have stored, while in the PIN code entering mode, press RECALL four times within five seconds. The PIN code you have stored will be released (returned to factory reset status).

3. Press ENTER to display the LOCKS menu.

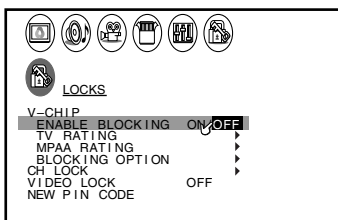

Continue to set each item following the steps on the next page.

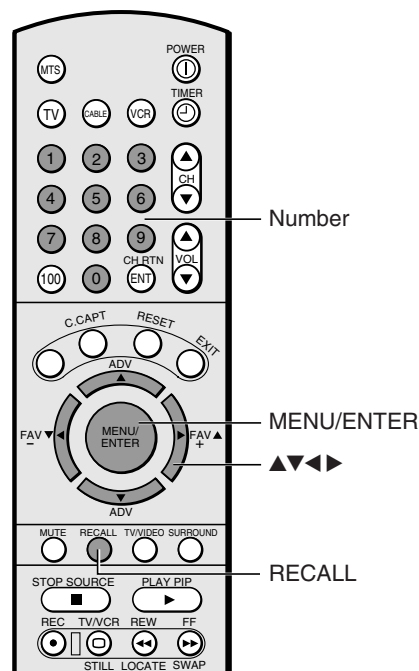

Using the V-CHIP menu

Some TV programs and movies include signals that classify the content of the program (violence, sex, dialog, language). The V-CHIP control feature in this TV detects the signals and blocks the programs according to your selections. To use this feature, perform the following setup.

ENABLE BLOCKING

1. From the LOCKS menu, select ENABLE BLOCKING.
2. Press ◀ or ▶ to select ON or OFF.
ON : To enable your setting (Lock)
OFF: To release your setting (Unlock)

Note: The CH LOCK function is not affected by this selection.

TV RATING (Independent rating system for broadcasters)

1. From the LOCKS menu, select TV RATING.
2. Press ◀ or ▶ to display the TV RATING menu.
3. Press ▼ or ▲ to select the item.
4. Press ▶ to lock (displays "X")
Press ◀ to unlock (displays "✓")
5. Repeat steps 3 and 4 to set the next item.

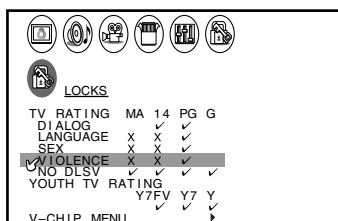

The TV age-based ratings and content themes you can lock are listed in the table below.

Ratings	Description and Content themes
MA	Mature Audience Only (This program is specifically designed to be viewed by adults and therefore may be unsuitable for children under 17.) L) Crude or indecent language S) Explicit sexual activity V) Graphic violence
14	Parents Strongly Cautioned (This program contains some material that many parents would find unsuitable for children under 14 years of age.) D) Intensely suggestive dialog L) Strong, coarse language S) Intense sexual situations V) Intense violence
PG	Parental Guidance Suggested (This program contains material that parents may find unsuitable for younger children.) D) Some suggestive dialog L) Infrequent coarse language S) Some sexual situations V) Moderate violence
G	General Audience (Most parents would find this program suitable for all ages.)
Y7, Y7FV	Directed to Older Children (This program is designed for children age 7 and above. Note: Programs in which fantasy violence may be more intense or more combative than other programs in this category are designated Y7FV.)
Y	All Children (This program is designed to be appropriate for all children)

LOCKS menu

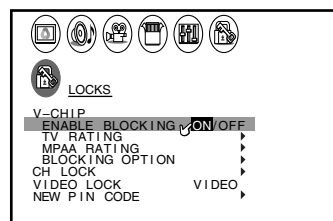

To select each item:
Press ▼ or ▲.

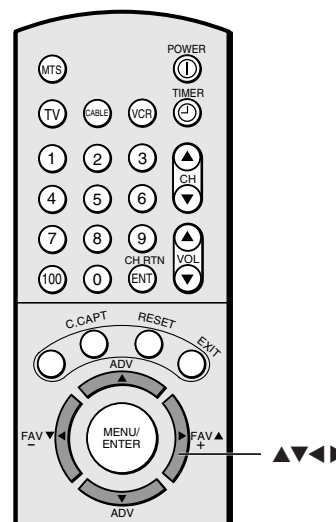

The rating of the TV programs you are now watching can be confirmed by pressing the RECALL button.

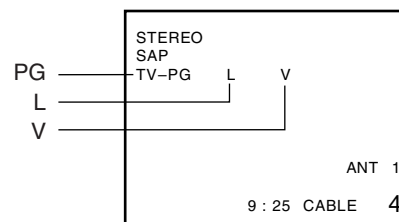

MPAA RATING (Independent rating system for movies)

1. From the LOCKS menu, select MPAA RATING.
2. Press ◀ or ▶ to display the MPAA RATING menu, then press ▼ or ▲ to highlight MPAA RATING.
3. Press ◀ or ▶ to display the MPAA RATING menu.

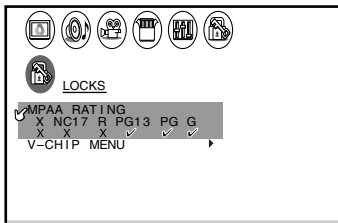

4. Press ▶ to lock “X” or press ◀ to unlock “✓.”

The movie ratings and description you can lock are as follows:

- X : X-rated (For adults only)
- NC17: Not intended for anyone 17 and under
- R : Restricted (Under 17 requires accompanying parent or adult guardian.)
- PG13 : Parents Strongly Cautioned (Some material may be inappropriate for children under 13)
- PG : Parental Guidance Suggested (Some material may not be suitable for children)
- G : General Audience (Appropriate for all ages)

BLOCKING OPTION

1. From the LOCKS menu, select BLOCKING OPTION.
2. Press ◀ or ▶ to display the BLOCKING OPTION menu, then press ▲ or ▼ to select item.

MPAA UNRATED:

Press ◀ or ▶ to select ON (Lock) or OFF (Unlock) for unrated programs on MPAA rating system.

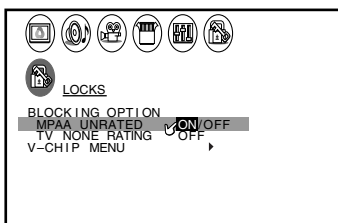

TV NONE RATING:

Press ◀ or ▶ to select ON (Lock) or OFF (Unlock) for programs rated NONE on TV PARENTAL GUIDELINES.

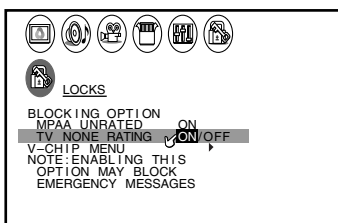

V-CHIP MENU:

Press ◀ or ▶ to return to the LOCKS menu.

LOCKS menu

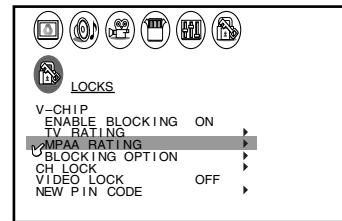

To select each item:

Press ▼ or ▲.

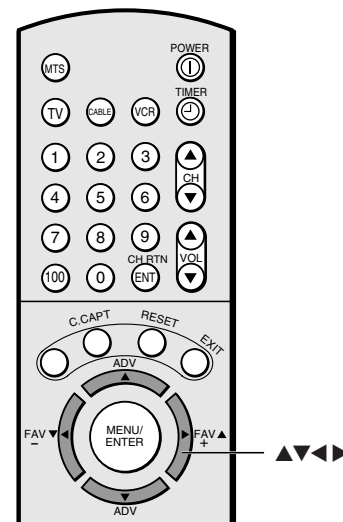

Caution:

Be aware that setting the TV None Rating to ON could cause emergency information (such as storm warnings) to be blocked as well. The menu will display the note, “Enabling this option may block emergency messages” to warn you of this possibility.

Note:

The picture-in-picture (PIP) is not locked even if the TV-None Rating is set to ON (locked).

Unlocking programs temporarily

1. If you try to watch a TV program that exceeds the rating limits you set, the TV will enter into the program lock mode.

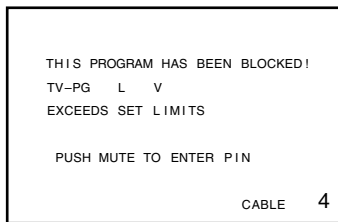

2. If you want to watch the locked program temporarily, press MUTE.
3. Press the Number buttons (0–9) to enter the 4-digit code you have stored.

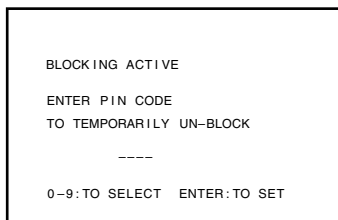

4. Press ENTER.

If the number is correct, the lock mode will be released and the normal picture will appear.

All locking is disabled until the TV is turned off.

It will be enabled when the power is reapplied.

If the correct PIN code is not entered, the message “Incorrect PIN Code” appears.

Try to enter the correct code again.

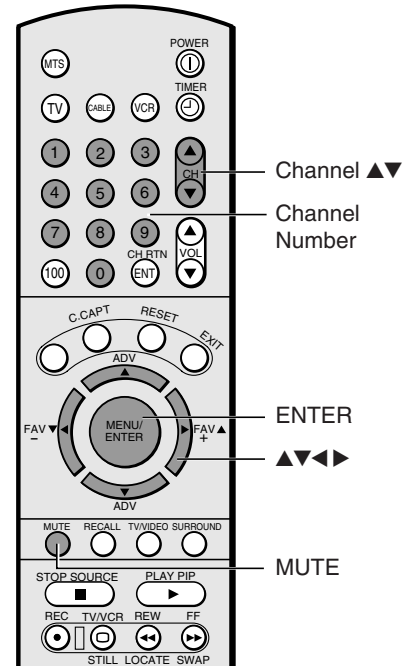

Locking channels

With the CH LOCK feature, you can lock specific channels. You will not be able to tune locked channels with the Channel ▲▼ buttons or Channel Number buttons unless you clear the setting.

You can lock a maximum of eight channels.

To lock channels:

1. From the LOCKS menu, select CH LOCK.
2. Press ◀ or ▶ to display the CH LOCK menu.
3. Press the Channel Number buttons to enter the channel you want to lock. (The channel you are currently watching cannot be locked.)
4. Press ENTER.

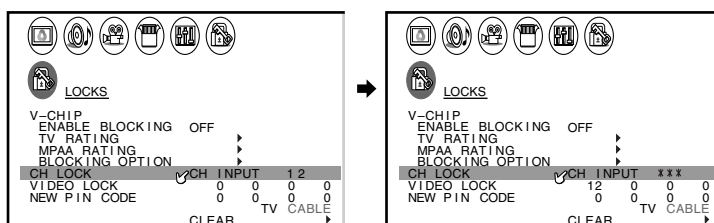

5. Repeat steps 3 and 4 for other channels.

LOCKS menu

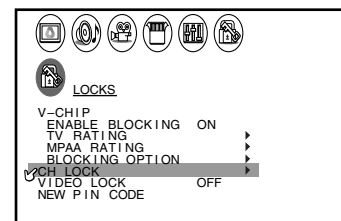

To select each item:

Press ▼ or ▲.

To unlock channels:

1. From the LOCKS menu, select CH LOCK.
2. Press ◀ or ▶ to display the CH LOCK menu.
3. Press ▲ or ▼ to highlight CLEAR.
4. Press ◀ or ▶ until "0" replaces the channel numbers you have locked. **Note:** This clears all locked channels at once. You cannot unlock individual channels.

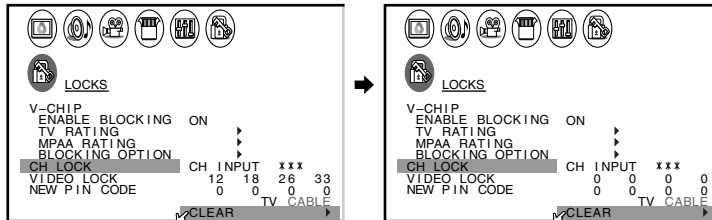

Locking video inputs

Use the VIDEO LOCK feature to lock out the input sources (Video 1, Video 2, Video 3, and ColorStream) and channels 3 and 4. You will not be able to select the input sources using the TV/VIDEO button or Channel Number buttons unless the Video Lock feature is OFF.

To set up the video lock:

1. From the LOCKS menu, select VIDEO LOCK.
2. Press ◀ or ▶ to highlight the desired level of video locking, as follows:
 - VIDEO: Locks Video 1, Video 2, Video 3 and ColorStream.
 - VIDEO+: Locks Video 1, Video 2, Video 3, ColorStream, and channels 3 and 4. This option should be used if you use the antenna terminal to play a video tape.

Note: Make sure the PIP is not on channel 3 or 4.

- OFF: Unlocks all video input sources.

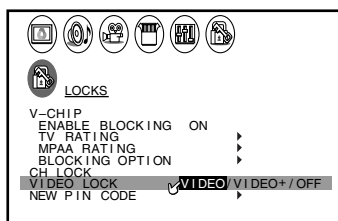

Changing the PIN code

1. From the LOCKS menu, select NEW PIN CODE.
2. Press the Number buttons (0–9) to enter a 4-digit code. The numbers you enter will replace the dashes in the display.

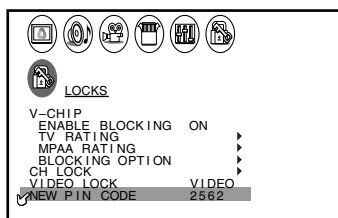

3. Press ENTER. The new PIN code is now active.

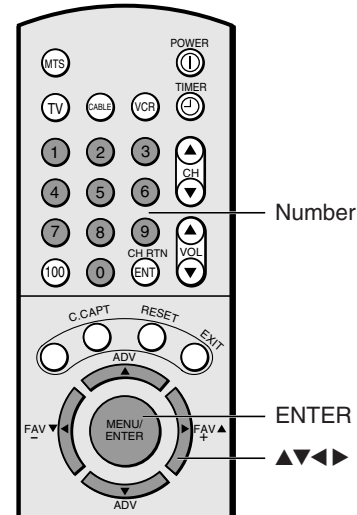

Adjusting the picture

Selecting the picture mode

You can select your desired picture type from four picture modes—sports, standard, movie, and preference—as described in the following table:

Mode	Picture Quality
sports	bright and dynamic picture (factory setting)
standard	standard picture setting
movie	movie-like picture setting
preference	your personal preference*

*(see “Saving new preference” on page 31.)

To select the picture mode:

1. Press MENU, then press ◀ or ▶ until the PICTURE menu appears.
2. Press ▼ or ▲ to select MODE.
3. Press ◀ or ▶ to highlight the mode you prefer.

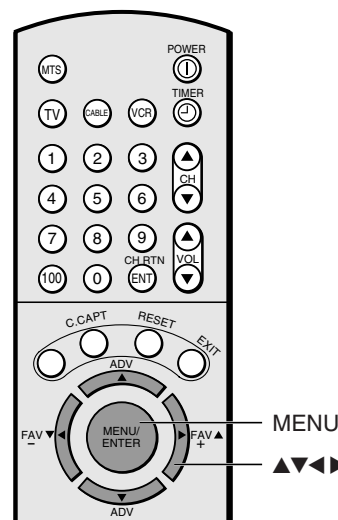
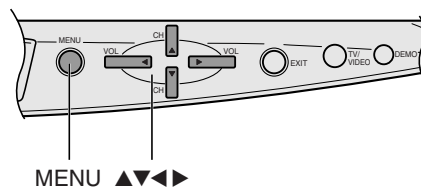
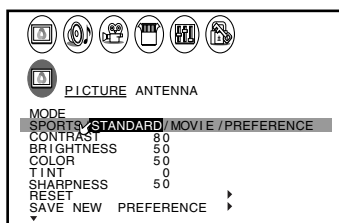

Adjusting the picture quality

You can adjust the picture quality to your personal preferences, including the contrast, brightness, color, tint, sharpness, flesh tone, noise reduction and color temperature. The qualities you choose will be stored by using the Save New Preference feature in your TV's memory so you can recall them at any time.

To adjust the picture quality:

1. Press MENU, then press ◀ or ▶ until the PICTURE menu appears.
2. Press ▼ or ▲ until the item you want to adjust is highlighted.
3. Press ◀ or ▶ to adjust the level.

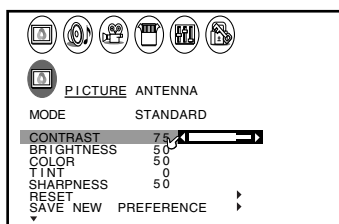

Selection	◀ Pressing ▶	
contrast	lower	higher
brightness	darker	lighter
color	paler	deeper
tint	reddish	greenish
sharpness	softer	sharper

The PICTURE items you have adjusted can be saved in the TV's memory by performing the Save New Preference feature (see page 31). You can keep these settings or choose preset options as described under “Selecting the picture mode” above.

Note:

Your new settings must be saved using the Save New Preference feature (see page 3). If the input source or channel is changed without saving your new preference, the settings will be lost.

Saving new preference

You can save the PICTURE qualities (contrast, brightness, color, tint, and sharpness) you adjusted in the picture preference mode.

To save your new preferences:

1. Press MENU, then press ◀ or ▶ until the PICTURE menu appears.
2. Press ▲ or ▼ to highlight SAVE NEW PREFERENCE.
3. Press ◀ or ▶.

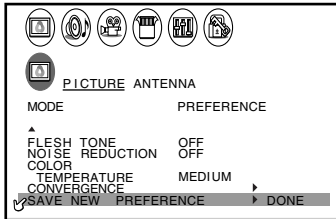

You can choose preset options by selecting the PREFERENCE mode in the picture mode feature (see page 30).

Using the flesh tone feature

This feature allows you to obtain natural flesh tones by correcting the differences in tint among the TV stations.

To turn on the flesh tone feature:

1. Press MENU, then press ◀ or ▶ until the PICTURE menu appears.
2. Press ▲ or ▼ to highlight FLESH TONE.
3. Press ◀ or ▶ to highlight ON.

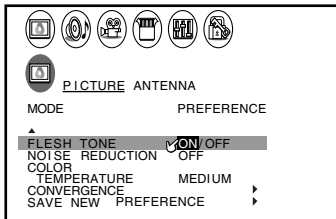

To turn off the flesh tone feature:

Highlight OFF in step 3 above.

Using the noise reduction feature

This feature allows you to reduce visible interference in your TV picture. This is useful when receiving a broadcast with a weak signal or playing a video cassette or disc damaged by repeated use.

To turn on the noise reduction feature:

1. Press MENU, then press ◀ or ▶ until the PICTURE menu appears.
2. Press ▲ or ▼ to highlight NOISE REDUCTION.
3. Press ◀ or ▶ to highlight ON.

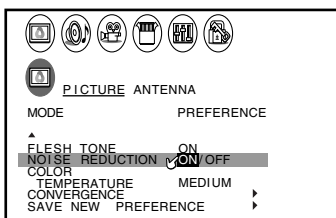

To turn off the noise reduction feature:

Highlight OFF in step 3 above.

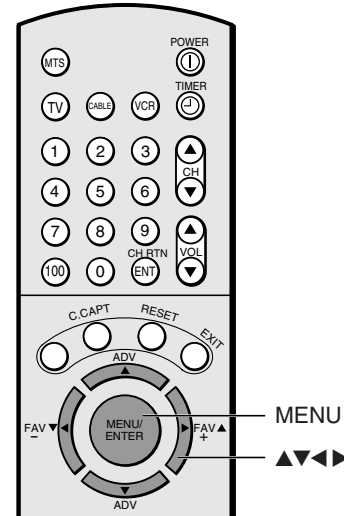

Selecting the color temperature

You can change the quality of the picture by selecting from three preset color temperatures: cool, medium, and warm.

Mode	Picture Quality
cool	blueish
medium	neutral
warm	reddish

To select the color temperature:

1. Press MENU, then press ◀ or ▶ until the PICTURE menu appears.
2. Press ▲ or ▼ to highlight COLOR TEMPERATURE.
3. Press ◀ or ▶ to highlight the mode you prefer.

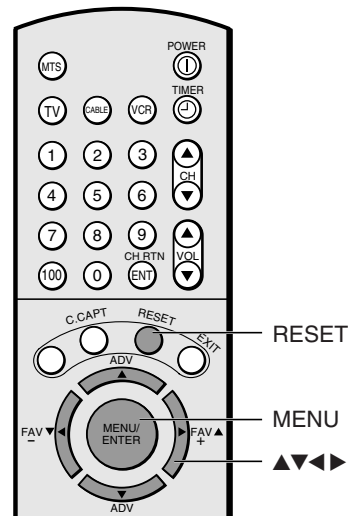
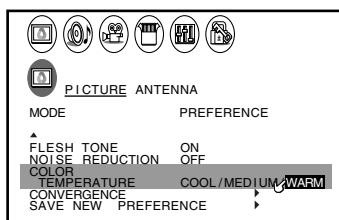

Resetting your picture adjustments

The RESET function resets the picture adjustments to the following factory settings:

contrast max (100)
 brightness center (50)
 color center (50)
 tint center (0)
 sharpness center (50)
 color temperature cool
 noise reduction off
 picture mode sports

To reset your picture adjustments:

1. Press MENU, then press ◀ or ▶ until the PICTURE menu appears.
2. Press ▲ or ▼ to highlight RESET.
3. Press ◀ or ▶.

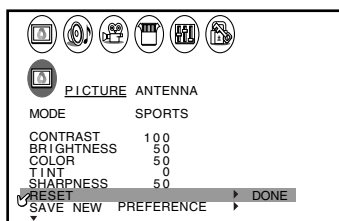

To reset the picture and audio adjustments to the factory settings simultaneously:

Press RESET on the remote control.

Watching video input

You can use the TV/VIDEO button on the remote control or TV to view a signal coming from other devices connected to your TV, such as VCRs or videodisc players. Select VIDEO 1, VIDEO 2, VIDEO 3, or ColorStream, depending on which input jacks are used for connecting the devices.

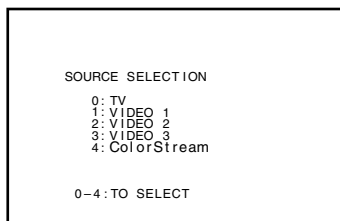

You can also select the desired video source directly by pressing the corresponding number buttons (1-4) while the above menu is on the screen.

Selecting the video label

The Video Label feature allows you to label each input source for your TV to one of the following preset labels:

- : uses the default label name
- VCR: Video Cassette Recorder
- DVD: DVD video player
- DTV: Digital TV set-top box
- SAT: Satellite box
- CBL: Cable box

To set up video labels:

1. Press MENU, then press ◀ or ▶ until the CUSTOM menu appears.
2. Press ▲ or ▼ to highlight VIDEO LABEL.

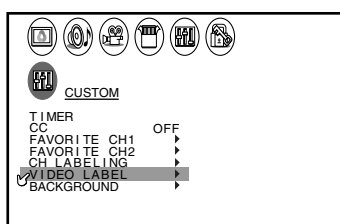

3. Press ◀ or ▶ to display the VIDEO LABEL menu.
4. Press ▲ or ▼ to highlight the video source you want to label.
5. Press ◀ or ▶ to select the desired label for that input source.

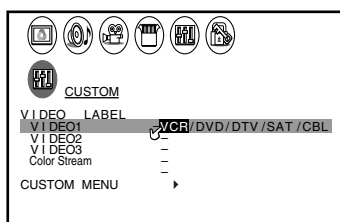

6. Finish labeling the other video sources as desired. To return to the previous menu, press ▲ or ▼ to highlight CUSTOM MENU, then press ◀ or ▶.

To exit the menu, press EXIT.

Note:

When ColorStream is selected, the video OUT signal will not have color.

To receive a color video OUT signal, a video or S-video IN jack must be used instead of the ColorStream connection.

If you press the TV/VIDEO button on the TV, the menu does not display the numbers (0-4).

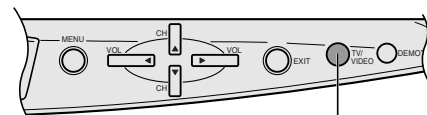

TV/VIDEO

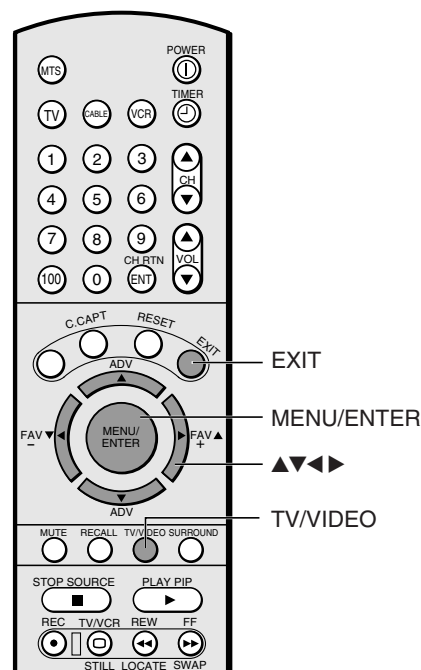

Using the closed caption feature

The Closed Caption feature has two options:

- Captions—An on-screen display of the dialogue, narration, and sound effects of programs and videos that are closed-captioned (usually identified in your local TV listing as “CC”).
- Text—An on-screen display of information not related to the program, such as weather or stock reports (if available in your area).

To view captions or text:

1. Tune the TV to the desired program or video.
2. Press C. CAPT (or MENU, then ▲ ▼) to display the CUSTOM menu. CC will be highlighted.

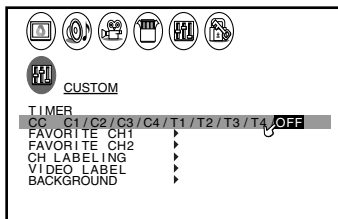

3. Press C. CAPT (or ◀▶) to highlight the Closed Caption mode.

- To view captions, select C1, C2, C3, or C4. Select C1 to display translation of the primary language in your area. If the program or video you selected is not closed-captioned, no captions will display on the screen.



- To view text, select T1, T2, T3, or T4. If text is not available in your area, a black rectangle may appear on your screen. If this occurs, turn the Closed Caption feature OFF.

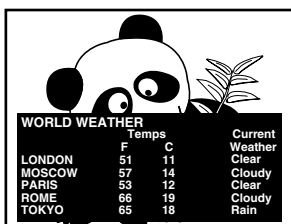

- To turn the Closed Caption feature off, select OFF.

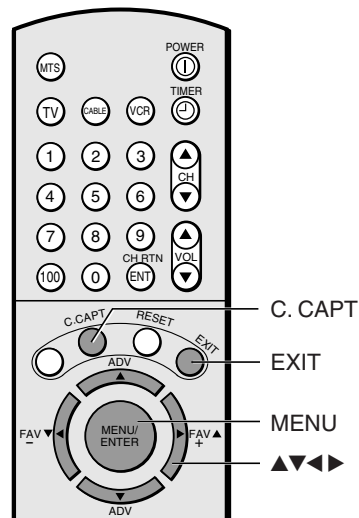
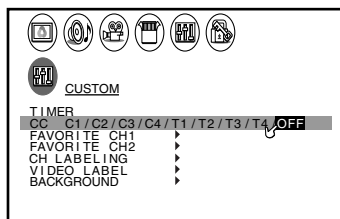

Note:

A closed caption signal may not be decoded in the following situations:

- when a videotape has been dubbed
- when the signal reception is weak
- when the signal reception is nonstandard

Setting the timer (sleep timer)

You can set the TV so it turns off automatically.

To set the off-timer:

1. Press **TIMER** (or **MENU** then **▲▼**) to display the **CUSTOM** menu. **TIMER** will be highlighted.
2. After the number position starts to blink, repeatedly press **TIMER** to enter the length of time until the TV turns off automatically (in 10-minute increments to a maximum of 180).

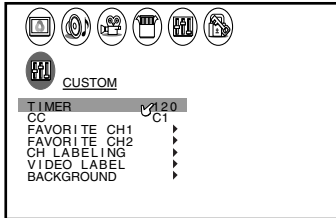

3. Press **ENTER** to start the timer.

To cancel the off-timer:

Press **POWER** twice, once to turn the TV off, and once to turn it on again.

Setting the clock

To set the clock

1. Press **MENU**, then press **◀** or **▶** until **SET UP** menu appears.
2. Press **▲** or **▼** to highlight **CLOCK SET**.
3. After the number position starts to blink, press the Number buttons (0–9) to enter the correct time.

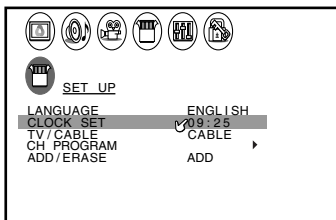

The clock operates on a 12-hour cycle.

4. Press **ENTER** to start the clock.

To display the time on-screen:

Press **RECALL**.

Note :

If you want to see how much time remains before the shut-off time, press **TIMER** once.

The remaining time will be displayed. To erase the display, press **EXIT**.

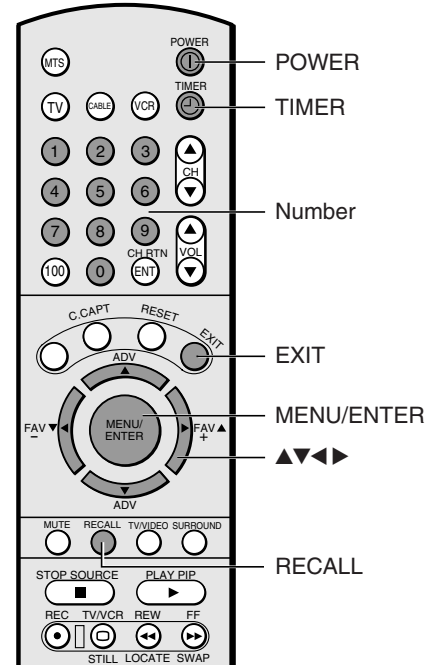

Note:

If the power source for the TV is interrupted (that is, the AC cord is unplugged or a power failure occurs), you will need to reset the clock.

Adjusting the sound

Muting the sound

Press MUTE to temporarily turn off the sound. While the sound is off, the screen will display the word MUTE in the lower right corner. To restore the sound, press MUTE again.

When you press the MUTE button, the Closed Caption feature is automatically activated. To deactivate this feature, press the MUTE button again. This feature works only when the closed caption mode is set to OFF. See "Using the closed caption feature" on page 34 for more information.

Selecting stereo/SAP broadcasts

The Multi-channel TV Sound (MTS) feature allows you to listen to high-fidelity stereo sound while watching your TV. MTS also can transmit a second audio program (SAP) containing a second language, music, or other audio information (when provided by individual stations).

When the TV receives a stereo or SAP broadcast, the word STEREO or SAP appears on-screen every time the TV is turned on, the channel is changed, or the RECALL button is pressed.

The MTS feature is not available in VIDEO mode.

To listen to stereo sound:

1. Press MTS (or MENU then ▲▼) to display the AUDIO menu. MTS will be highlighted.

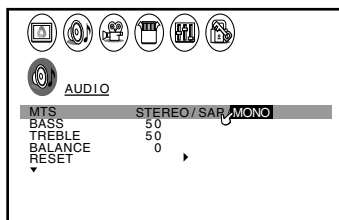

2. Press MTS (or ◀▶) to highlight STEREO. The word STEREO displays in yellow in the menu when the TV receives a stereo signal.

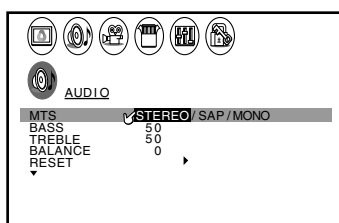

You can leave your TV in STEREO mode because it will automatically output stereo or monaural sound, depending on the broadcast type. If the stereo sound is noisy, select MONO to reduce the noise.

To listen to a second audio program (SAP):

1. Press MTS (or MENU then ▲▼) to display the AUDIO menu. MTS will be highlighted.
2. Press MTS (or ◀▶) to highlight SAP in the AUDIO menu. The word SAP displays in yellow in the menu when the TV receives an SAP signal.

While viewing a program in SAP mode, you will hear the station's second audio program (if available) instead of the program's normal audio (see note at right).

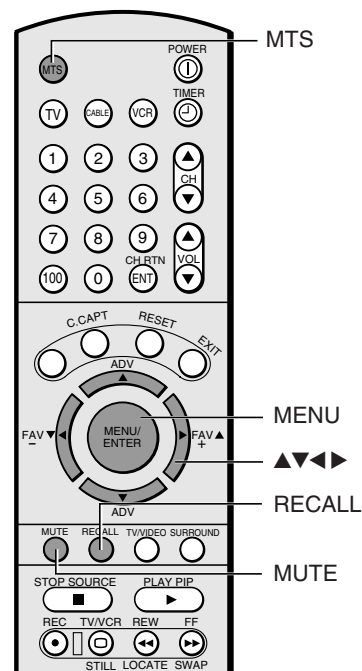
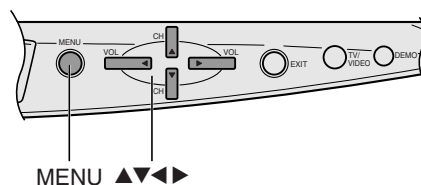

Note:

A second audio program (SAP) can be heard only on those TV stations that offer it.

For example, a station might broadcast the news as their second audio program. With SAP on, you would see the regular program on the screen but hear the news instead of the program's normal audio.

If you have SAP on, and the station you are watching also has SAP on but is not broadcasting any audio on their SAP, you will be able to see the picture but not hear any sound. If this occurs, put the TV in STEREO mode so you can hear the station's normal audio.

Using the surround sound feature

The surround sound feature expands the audio listening field wider and deeper to create exceptional sound quality from the TV's speakers. The feature uses stereo signals from a TV broadcast or video input.

To turn on the surround sound feature:

1. Select the stereo mode following the steps under "Selecting stereo/SAP broadcasts" on page 36.
2. Press SURROUND (or MENU then ▲▼) to display the THEATER menu.
3. Press SURROUND (or ◀▶) to highlight MATRIX.

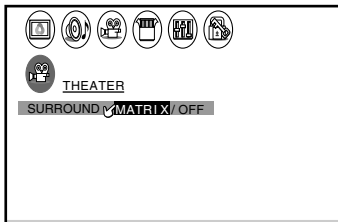

To turn off the surround sound feature:

Press SURROUND to highlight OFF in the THEATER menu.

In general, you can leave your TV set to MATRIX because it automatically produces surround stereo or monaural sound, depending on the broadcast type.

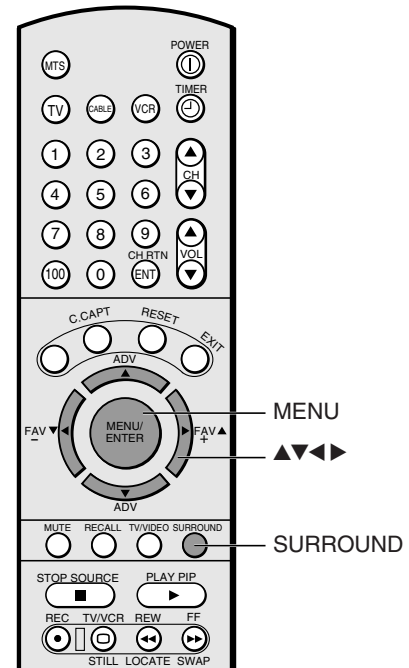

Adjusting the sound quality

You can change the quality of your TV's sound by adjusting the bass, treble, and balance.

To adjust the sound quality:

1. Press MENU, then press ◀ or ▶ until the AUDIO menu appears.
2. Press ▲ or ▼ to highlight the item you want to adjust.

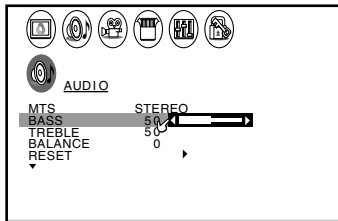

3. Press ◀ or ▶ to adjust the level.
 - ◀ makes the sound quality weaker or decreases the balance in the right channel, depending on the item selected.
 - ▶ makes the sound quality stronger or decreases the balance in the left channel, depending on the item selected.

Resetting your audio adjustments

The RESET function returns the audio to the following factory settings:

bass center (50)
treble center (50)
balance center (0)

To reset your audio adjustments:

1. Press MENU, then press ◀ or ▶ until the AUDIO menu appears.
2. Press ▲ or ▼ to highlight RESET.
3. Press ◀ or ▶.

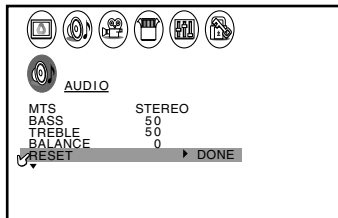

To reset the audio and picture adjustments to the factory settings simultaneously:

Press RESET on the remote control.

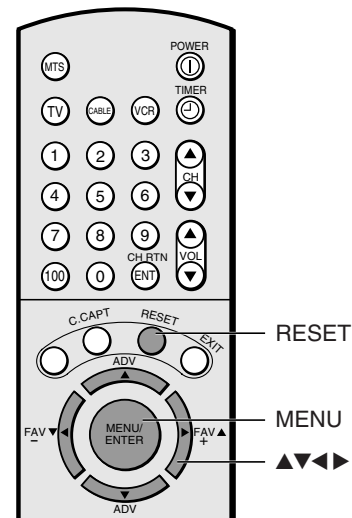

Using the Sub-Bass System (SBS)

The Sub-Bass System allows you to enhance bass performance, even when the sound volume is low.

To turn on the sub-bass system:

1. Press MENU, then press ◀ or ▶ until the AUDIO menu appears.
2. Press ▲ or ▼ to highlight SBS.
3. Press ◀ or ▶ to highlight ON.

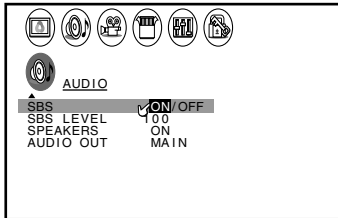

To adjust the SBS level:

4. Press ▲ or ▼ to highlight SBS LEVEL.
5. Press ◀ or ▶ to adjust the SBS level.

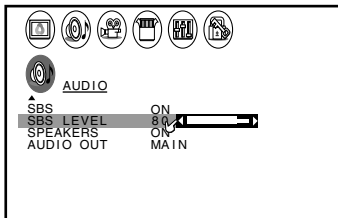

To turn off the Sub-Bass System:

Highlight OFF in step 3 above.

Turning off the built-in speakers

Use this feature to turn the TV speaker off when you connect an audio system (see "Connecting an audio system" on page 9.)

To turn off the built-in speakers:

1. Press MENU, then press ◀ or ▶ until the AUDIO menu appears.
2. Press ▲ or ▼ to highlight SPEAKERS.
3. Press ◀ or ▶ to highlight OFF.

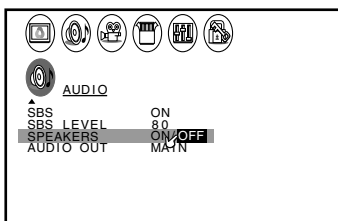

To turn on the built-in speakers:

Highlight ON in step 3 above.

Note:

The Sub-Bass System signal does not pass through the "Variable Audio OUT" jacks (see "Connecting an audio system" on page 9); however, the AUDIO menu will appear when the buttons are pressed.

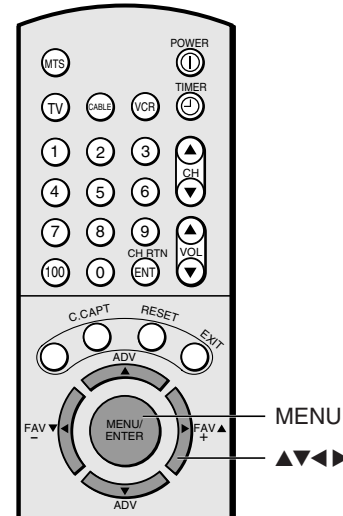

Note:

Make sure the volume control of your audio amplifier is set to a moderate listening level.

Selecting the Audio OUT sound

This feature allows you to select the sound source (MAIN or PIP) that is output from the Audio OUT jacks.

This is useful when amplifying or recording the PIP sound with the external equipment while hearing the sound of the main picture through the built-in speakers.

To select the Audio OUT sound:

1. Press MENU, then press ◀ or ▶ until the AUDIO menu appears.
2. Press ▲ or ▼ to highlight AUDIO OUT.
3. Press ◀ or ▶ to select MAIN sound or PIP sound.

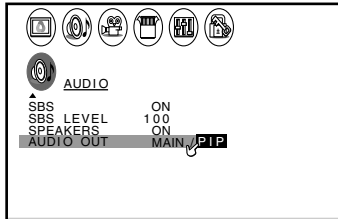

- MAIN: Main picture sound.
- PIP: Selected PIP sound.

Selecting the background of the menu display

You can change the background of the menu display by selecting from two preset types: shaded and solid (gray).

To select the background:

1. Press MENU, then press ◀ or ▶ until the CUSTOM menu appears.
2. Press ▲ or ▼ to highlight BACKGROUND.
3. Press ◀ or ▶ to select either background of SHADED or SOLID.

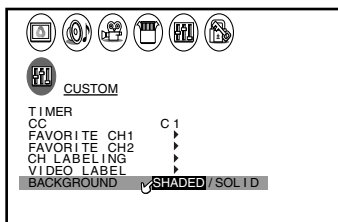

Displaying on-screen information

Press RECALL to display the following information on-screen:

- Channel number or VIDEO mode selected
- Time (if set)
- Channel label (if set)
- Stereo or SAP (second audio program) audio status
- V-CHIP rating status

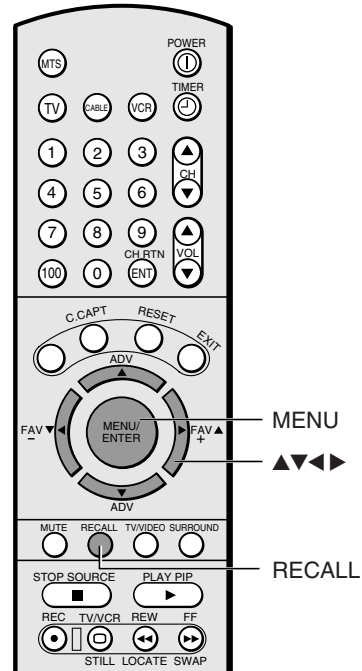
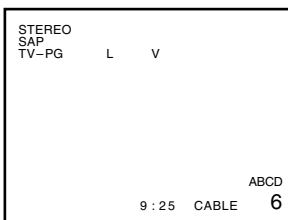

Viewing the demonstration mode

When you press DEMO on the TV, the TV automatically displays a variety of its on-screen menus and special features. This function is provided for demonstration purposes only.

To stop the demonstration mode:

Press DEMO again.

Understanding the auto power off feature

The TV will automatically turn itself off after approximately 15 minutes if it is tuned to a vacant channel or a station that completes its broadcast for the day. This feature does not work in VIDEO mode.

Understanding the last mode memory feature

If the power is cut off while you are viewing the TV, the Last Mode Memory feature turns the TV on automatically when the power is resupplied.

If the power is going to be off for a long time and you are going to be away from the TV, unplug the power cord to prevent the TV from turning on in your absence.

Appendix

Specifications

Television System	NTSC standard
Channel Coverage	VHF: 2 through 13 UHF: 14 through 69 Cable TV: Mid band (A-8 through A-1, A through I) Super band (J through W) Hyper band (AA through ZZ, AAA, BBB) Ultra band (65 through 94, 100 through 125)
Power Source	120 V AC, 60 Hz
Power Consumption	129 W (average)
Audio Power	14 W + 14 W
Speaker Type	Two 6-1/4 inches (16 cm) round
Video/Audio Terminals	S-VIDEO INPUT Y-INPUT: 1 V(p-p), 75 ohm, negative sync. C-INPUT: 0.286 V(p-p) (burst signal), 75 ohm VIDEO/AUDIO INPUT VIDEO: 1 V(p-p), 75 ohm, negative sync. AUDIO: 150 mV(rms) (30% modulation equivalent, 47 kohm) ColorStream™ (component video) INPUT Y : 1V(p-p), 75 ohm CR: 0.7 V(p-p), 75 ohm CB: 0.7 V(p-p), 75 ohm AUDIO: 150 mV(rms), 47 kohm VIDEO/AUDIO OUTPUT VIDEO: 1 V(p-p), 75 ohm, negative sync. AUDIO: 150 mV(rms) (30% modulation equivalent, 4.7 kohm) VARIABLE AUDIO OUTPUT 0–300 mV(rms) (30% modulation equivalent, 4.7 kohm)
Dimensions	Width : 42-1/4 inches (1,073 mm) Height : 50-5/8 inches (1,286 mm) Depth : 20-13/16 inches (529 mm)
Mass	217 lbs (98.6 kg)
Supplied Accessories	Remote Control with 2 size “AA” batteries

Design and specifications are subject to change without notice.

Troubleshooting

Before calling a service technician, please check the following table for a possible cause of the problem and some solutions.

Problem	Solution
TV will not turn on	<ul style="list-style-type: none">• Make sure the power cord is plugged in, then press POWER.• The remote control batteries may be dead. Replace the batteries.
No picture, no sound	<ul style="list-style-type: none">• Check the antenna/cable connections.
No sound, picture OK	<ul style="list-style-type: none">• The sound may be muted. Press VOLUME.• The station may have broadcast difficulties. Try another channel.• Check that the SPEAKERS function in the AUDIO menu is properly set.
Poor sound, picture OK	<ul style="list-style-type: none">• The station may have broadcast difficulties. Try another channel.
Poor picture, sound OK	<ul style="list-style-type: none">• Check the antenna connections.• The station may have broadcast difficulties. Try another channel.• Adjust the PICTURE menu.
Poor reception of broadcast channels	<ul style="list-style-type: none">• The station may have broadcast difficulties. Try another channel.• Check the antenna connections.• If you are using a VCR, make sure the TV/VCR button is set correctly.
Cannot receive above channel 13	<ul style="list-style-type: none">• Make sure TV/CABLE is set to the mode that corresponds to the signal source type (cable or antenna).
Black box appears on the screen	<ul style="list-style-type: none">• The Closed Caption/Text feature may be on.
Unable to select a certain channel	<ul style="list-style-type: none">• The channel may be locked out with the CH LOCK feature or erased with the ADD/ERASE feature.
Multiple images	<ul style="list-style-type: none">• The station may have broadcast difficulties. Try another channel.• Antenna reception may be poor. Use a highly directional outdoor antenna.
Poor color or no color	<ul style="list-style-type: none">• The station may have broadcast difficulties. Try another channel.• Adjust the TINT and/or COLOR in the PICTURE menu.
No stereo or SAP sound from a known MTS broadcast	<ul style="list-style-type: none">• Make sure the MTS feature is set properly.
The remote control does not operate	<ul style="list-style-type: none">• Press the appropriate device button (TV/CABLE/VCR).• There may be an obstruction between the remote control and the remote control sensor. Remove the obstruction.• The remote control batteries may be dead. Replace the batteries.

Limited United States Warranty

Toshiba America Consumer Products, Inc. ("TACP") and Toshiba Hawaii Inc. ("THI") make the following limited warranties. These limited warranties extend to the original consumer purchaser or any person receiving this set as a gift from the original consumer purchaser and to no other purchaser or transferee.

Limited One (1) Year Warranty

TACP and THI warrant this product and its parts against defects in materials or workmanship for a period of one (1) year after the date of original retail purchase. During this period, TACP and THI will repair or replace a defective part, at their option, with a new or refurbished part, without charge to you. TACP/THI Authorized Service Station personnel will come to your home when warranty service is required. Depending on the type of repair required, the service will either be performed in your home or the set will be taken to the TACP/THI authorized service station for repair and returned to your home at no cost to you.

Limited Two (2) Year Warranty of Picture Tube

TACP and THI further warrant the picture tube in this product against defects in materials or workmanship for a period of two (2) years after the date of original retail purchase. During this period, TACP and THI will repair or replace a defective picture tube at their option, with a new or refurbished picture tube, without charge to you, except that if a defective picture tube is replaced after one (1) year from the date of the original retail purchase, you pay labor charges involved in the replacement.

Rental Units

The warranty for rental units begins with the first rental or thirty (30) days from the date of shipment to the rental firm, whichever comes first.

Commercial Units

Products sold and used for commercial use have a limited ninety (90) day warranty for all parts, labor and picture tube.

How to Obtain Warranty Service

If after following all of the operating instructions in this manual and checking the section "BEFORE CALLING SERVICE PERSONNEL," you find that service is needed;

- (1) Call the TACP toll free number 1-800-631-3811 after you find a defective product or part to find the nearest TOSHIBA Authorized Service Station.
- (2) Please present your bill of sale or other proof to the Authorized Service Station. "Authorized TACP/THI service station personnel will come to your home when warranty service is required. Depending on the type of repair required, the service will either be performed in your home or the set will be taken to the TACP/THI Authorized service station for repair and returned to your home at no cost to you."

In the Continental United States call:



In Hawaii contact:

Toshiba Hawaii, Inc. 327 Kamakee Street, Honolulu, Hawaii 96814 (808) 591-8377

All warranties implied by state law, including the implied warranties of merchantability and fitness for a particular purpose, are expressly limited to the duration of the limited warranties set forth above. With the exception of any warranties implied by state law as hereby limited, the foregoing warranty is exclusive and in lieu of all other warranties, guarantees, agreements and similar obligations of manufacturer or seller with respect to the repair or replacement of any parts. In no event shall TACP or THI be liable for consequential or incidental damages.

No person, agent, distributor, dealer or company is authorized to change, modify or extend the terms of these warranties in any manner whatsoever. The time within which action must be commenced to enforce any obligation of TACP or THI arising under this warranty or under any state, or law of the United States or any state thereof, is hereby limited to 90 days from the date you discover or should have discovered, the defect. This limitation does not apply to implied warranties arising under state law.

This warranty gives you specific legal rights and you may also have other rights which may vary from state to state. Some states do not allow limitation on how long an implied warranty lasts, when an action may be brought, or the exclusion or limitation of incidental or consequential damages, so the above provisions may not apply to you.



ATTENTION CANADIAN CONSUMERS:

Canadian consumers are requested to complete the special Canadian "Warranty Registration Form" enclosed, and forward this completed form with a copy of bill of sale to TOSHIBA OF CANADA to "Register and Validate" their warranty.

Products purchased in the U.S.A. and used in Canada are not covered by these warranties.

Products Purchased in Canada and used in the U.S.A. are not covered by these warranties.

REV. 09-01

Index

A

Antenna cables	5
Audio cables	5
AUDIO OUT sound, selecting	40
Audio system connection	9
Auto power off	41

B

Back of the TV	4
BACKGROUND selection	40

C

Cable converter box connection	6
Camcorder connection	9
C. CAPT button	34
CH LABEL	21
CH LOCK	28
CH RTN button	20
Channel number buttons	18
Channel programming	
ADD/ERASE	18
Automatic programming	17
TV/CABLE selection	17
Channel ▲ ▼ buttons	18
CLOCK	35
Closed caption	34
ColorStream cables	5
Convergence adjustment	18
Color temperature	32

D

DEMO button	41
Demonstration mode	41
DVD connection	7

F

FAV ▼ ▲ buttons	20
FAVORITE CH	20
Front of the TV	4

L M

Labeling channels	20
Language selection	16
Last mode memory	41
Locking channels	28
Locks menu	25
Menu system	15
MTS	36
MUTE button	36

P

Picture adjustments	
COLOR TEMPERATURE	32
FLESH TONE	31

NOISE REDUCTION	31
Picture mode	30
Picture quality	30
Picture-in-Picture (PIP)	
LOCATE button	24
PIP button	23
SOURCE button	23
STILL button	24
SWAP button	24

R

RECALL button	40
Remote control	
Battery installation	10
CABLE code table	13
CABLE TV converter box control buttons	11
Learning about the buttons	14
Programming	11
VCR code table	12
VCR control buttons	10
RESET	32, 38

S

SAP sound	36
Satellite receiver connection	7
Sound quality adjustments	38
SPEAKERS on/off	39
Specifications	42
Stereo sound	36
Sub-Bass System	39
Surround sound	37
S-video cables	5

T

TIMER	35
Troubleshooting	43
TV/VIDEO button on remote	33
TV/VIDEO button on TV	33

V

V-CHIP	
BLOCKING OPTION	27
ENABLE BLOCKING	26
MPAA RATING	27
NEW PIN CODE	29
TV RATING	26
Unlocking programs	28
VCR connection	5-8
Video cables	5
VIDEO LABEL	33
VIDEO LOCK	29

W

Warranty	44
----------------	----

TOSHIBA AMERICA CONSUMER PRODUCTS, INC.

HEAD OFFICE/82 TOTOWA ROAD, WAYNE, NEW JERSEY 07470
FACTORY SERVICE CENTER:1420B TOSHIBA DRIVE, LEBANON, TN. 37087

TOSHIBA HAWAII, INC.

HEAD OFFICE/327 KAMAKEE STREET, HONOLULU, HAWAII 96814, U.S.A. TEL: (808) 591-8377

TOSHIBA OF CANADA LTD.

HEAD OFFICE/191 McNABB STREET MARKHAM, ONTARIO L3R 8H2, CANADA TEL: (905) 470-5400
SERVICE CENTERS/TORONTO: 191 McNABB STREET MARKHAM, ONTARIO L3R 8H2, CANADA TEL: (905) 470- 5400
MONTREAL: 1643, NORTH SERVICE RD., TRANS-CANADA HIGHWAY, DORVAL QUEBEC, H9P 1J1, CANADA
TEL: (514) 856-4100
VANCOUVER: 22171 FRASERWOOD WAY, RICHMOND, B.C. V6W 1J5, CANADA TEL: (604) 303-2500

MANUFACTURED BY
TOSHIBA AMERICA CONSUMER PRODUCTS, INC.

PRINTED IN USA
(00-07)B

TOSHIBA
23563969

Free Manuals Download Website

<http://myh66.com>

<http://usermanuals.us>

<http://www.somanuals.com>

<http://www.4manuals.cc>

<http://www.manual-lib.com>

<http://www.404manual.com>

<http://www.luxmanual.com>

<http://aubethermostatmanual.com>

Golf course search by state

<http://golfingnear.com>

Email search by domain

<http://emailbydomain.com>

Auto manuals search

<http://auto.somanuals.com>

TV manuals search

<http://tv.somanuals.com>