

TOSHIBA

OWNER'S MANUAL

Projection Television

16:9
WIDE COLOR STREAM[®] WOW[™]
by SRS[®] CO[®]

50HX81
57HX81
65HX81

Owner's Record

The model number and serial number are on the back of your TV. Record these numbers in the spaces below. Refer to these numbers whenever you communicate with your Toshiba dealer about this TV.

Model number:

Serial number:

Introduction

Connecting
your TV

Using the
Remote Control

Setting up
your TV

Using the TV's
Features

Appendix

Index

Important Information

WARNING

TO REDUCE THE RISK OF FIRE OR ELECTRIC SHOCK, DO NOT EXPOSE THIS APPLIANCE TO RAIN OR MOISTURE.

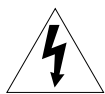
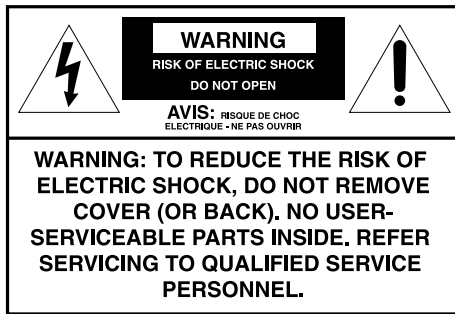

The lightning symbol in the triangle tells you that the voltage inside this product may be strong enough to cause an electric shock. **DO NOT TRY TO SERVICE THIS PRODUCT YOURSELF.**



The exclamation mark in the triangle tells you that important operating and maintenance instructions follow this symbol.

CAUTION

TO PREVENT ELECTRIC SHOCK, DO NOT USE THIS POLARIZED PLUG WITH AN EXTENSION CORD RECEPTACLE OR OTHER OUTLET UNLESS THE PRONGS CAN BE FULLY INSERTED INTO THE OUTLET TO PREVENT ANY EXPOSURE OF THE PRONGS ON THE POLARIZED PLUG.

ATTENTION

POUR PRÉVENIR LES CHOCs ÉLECTRIQUES NE PAS UTILISER CETTE FICHE POLARISÉE AVEC UN PROLONGATEUR, UNE PRISE DE COURANT OU UNE AUTRE SORTIE DE COURANT, SAUF SI LES LAMES PEUVENT ÊTRE INSÉRÉS À FOND SANS EN LAISSER AUCUNE PARTIE À DÉCOUVERT.

CAUTION

The plug has one prong wider than the other and will fit only one way into a standard electrical outlet (120 volt AC, 60 Hz). If the plug does not fit into the outlet, try turning it around. If the plug still does not fit, the outlet is probably non-standard and must be replaced by a qualified electrician. Do not tamper with the plug or try to force it into a non-standard outlet.

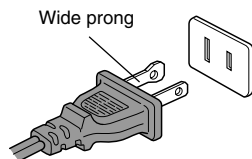

Note to CATV system installers in the USA

This reminder is provided to call the CATV system installer's attention to Article 820-40 of the NEC, which provides guidelines for proper grounding, and, in particular, specifies that the cable ground shall be connected to the grounding system of the building, as close to the point of cable entry as practical.

Precautions

Installing your TV

- Place the TV on the floor or on a sturdy platform. The mounting surface should be flat and steady. If you install the TV on a soft floor, make sure that the floor is not damaged by the weight of the TV.
- Place the TV far enough away from the walls to allow proper ventilation. This will prevent the TV from overheating and avoid possible damage to the TV. Avoid dusty areas too.
- Damage may occur if you leave the TV in direct sunlight or near a heater. Avoid areas subject to extremely high temperatures or humidity, and temperatures of 41°F(5°C) or lower.

Using your TV

- Do not stand or climb on the TV.
- Do not put any heavy object on top of the TV.
- Do not place containers with liquids such as drinks or cosmetics on the TV. If any foreign material or water leaks into the TV, unplug the AC cord and contact your dealer.
- If the room temperature suddenly rises, condensation may occur on the lenses resulting in picture distortion or color fading. In such a case, simply wait a while (with the power on) and the condensation will evaporate.
- Avoid displaying stationary images on your TV screen for extended periods of time. Stationary patterns generated by a POP double-window display, computer displays, video games, stock market reports, etc., can become permanently engrained on the picture tube. This damage is not protected by your warranty because it is the result of misuse. If you wish to use your TV to display still images, reduce brightness and contrast settings. Never leave a POP double-window, computer, or video game display unattended.
- Sit approximately 10-25 feet away from the TV. Sitting too far to the left or right of the screen will cause the picture to appear dull as will direct sunlight and room lights. Turn the TV off to check for reflections on the screen. Then remove the source of any reflections while viewing.

Cleaning your TV

- Clean the TV with a soft, dry cloth. Never use strong solvents such as thinner or benzene which might damage the finish of the cabinet. If the cabinet is very dirty, use a damp cloth to wipe the cabinet clean, then finish with a dry cloth.

Introduction	4	Using the LOCKS menu	36
Welcome to Toshiba	4	Entering the PIN code	36
Exploring your new TV	4	Using the V-CHIP menu	37
Connecting your TV	5	ENABLE BLOCKING	37
Connecting a VCR	5	TV RATING (Independent rating system for broadcasters)	37
Connecting a cable converter box	6	MPAA RATING (Independent rating system for movies)	38
Connecting a cable converter box and VCR	6	BLOCKING OPTION	38
Connecting a DVD player or satellite receiver and a VCR	7	Unlocking programs temporarily	39
Connecting a DVD player with ColorStream® and a VCR	8	Locking channels	39
Connecting a DTV receiver/set-top box with ColorStream® and a VCR	9	Locking video inputs	40
Connecting two VCRs	10	Using the front panel lock feature	41
Connecting a camcorder	10	Changing the PIN code	41
Connecting an audio system	11	Adjusting the picture	42
Connecting an A/V receiver	11	Selecting the picture mode	42
Using the remote control	12	Adjusting the picture quality	42
Preparing the remote control for use	12	Saving new preference	43
Installing the remote control batteries	12	Using the ALS (Automatic Light Sensor) feature	43
Remote Control functional key chart	13	Using the flesh tone feature	43
Programming the remote control for use with your audio/ video devices	15	Selecting the cinema mode	44
Device code setup	15	Using the Digital Noise Reduction (DNR) feature	44
Searching and sampling the code of a device (991)	15	Selecting the color temperature	45
Verifying the device code (990)	16	Resetting picture adjustments	45
Using the volume lock feature (993)	16	Selecting the video input source	46
Operational feature reset (980)	16	Labeling the video input sources	46
Device code table	17-20	Using the closed caption feature	47
Learning about the remote control	21	Setting the sleep timer	48
Setting up your TV	22	Setting the clock	48
Learning about the menu system	22	Adjusting the sound	49
Changing the on-screen display language	23	Muting the sound	49
Selecting the antenna input	23	Selecting stereo/SAP broadcasts	49
Adding channels to the TV's memory	24	Using the WOW™ surround sound feature	50
Programming channels automatically	24	Adjusting the sound quality	50
Adding and erasing channels manually	25	Resetting audio adjustments	51
Changing channels	25	Using the sub-bass system (SBS)	51
Adjusting the color convergence	26	Turning off the built-in speakers	52
Using the TV's features	28	Selecting the Audio OUT sound	52
Adjusting the channel settings	28	Using the StableSound™ feature	53
Switching between two channels	28	Selecting the background of the menu display	53
Programming your favorite channels	28	Displaying on-screen information	53
Labeling channels	29	Viewing the demonstration mode	54
Viewing the wide-screen picture formats	31	Understanding the auto power off feature	54
Selecting the picture size	31	Understanding the last mode memory feature	54
Scrolling the Theater Wide picture (Theater Wide 2 and 3 only)	33	Appendix	55
Using the POP double-window feature	34	Specifications	55
Switching the main and POP pictures	35	Troubleshooting	56
Freezing the POP picture	35	Limited United States Warranty	57
Using the favorite channel search function	35	Index	58

Introduction

Welcome to Toshiba

Congratulations! You have purchased one of the finest projection TVs on the market. The goal of this manual is to guide you through setting up and operating your Toshiba TV as quickly as possible.

This manual applies to models 50HX81, 57HX81, and 65HX81. Before you start reading, check your model number on the back of the TV.

Instructions in this manual are based on using the remote control. You can also use the controls on the TV if they have the same name as those on the remote control.

Please read all the safety and operating instructions carefully, and keep the manual for future reference.

Exploring your new TV

You can operate your TV using the buttons on the front panel or the remote control. The back panel and front panel (behind the door) provide all the terminal connections you will need to connect other equipment to your TV. See "Connecting your TV" on page 5.

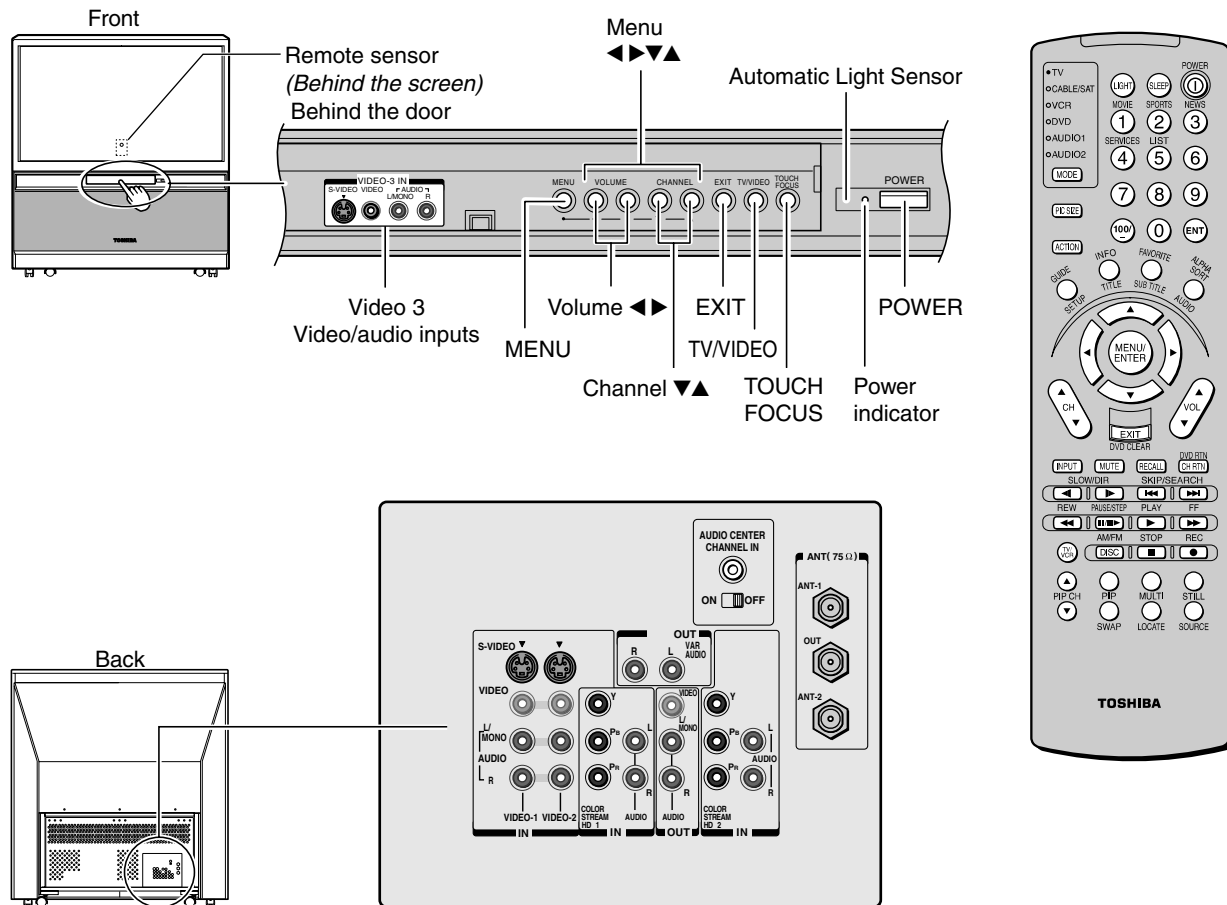

Please Note

On some models, the SET UP menu automatically appears on-screen the first time the TV is turned on.

To change the menu settings, see "Setting Up Your TV" on page 22.

To close the menu, either press EXIT or turn off the TV.

Connecting your TV

If you have not connected electronic equipment before, or you have been frustrated in the past, you may wish to read this section. (Cables are not supplied.)

- A coaxial cable is the standard cable that comes in from your antenna or cable converter box. Coaxial cables use "F" connectors.
- Audio and video cables are usually color-coded according to use: yellow for video and red and white for audio. The red audio cable is for the stereo right channel, and the white audio cable is for the stereo (or mono) left channel. If you look at the rear panel of the TV, you will see that the terminals are color-coded in the same manner as the cables.
- S-video cables provide better picture performance. S-video cables can only be used with S-video compatible components.
- ColorStream™ cables come in sets of three and provide the best picture performance. ColorStream cables can only be used with ColorStream compatible components.

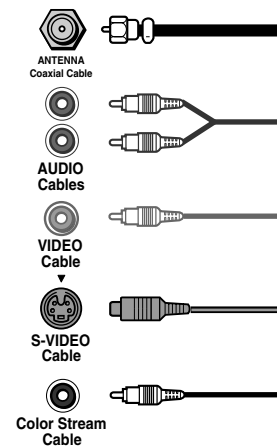

Caution:

Do not plug the TV in until you have finished connecting all of your equipment.

Connecting a VCR

This connection allows you to watch local channels and video programs, play or record on the VCR while watching TV, and record from one channel while watching another channel.

You will need:

- one coaxial cable
- one pair of audio cables (one single audio cable for a mono VCR)
- one video cable (one S-video cable for an S-VHS VCR)

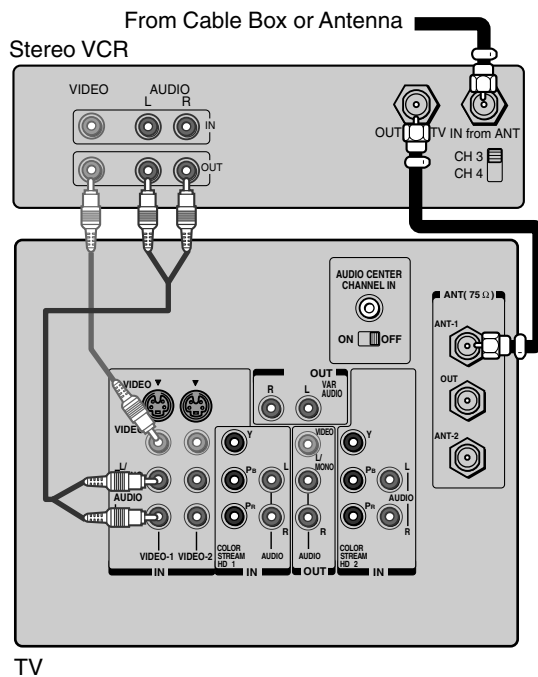

Note:

If you have a mono VCR, connect L/Mono to VCR Audio OUT using only one audio cable.

If you have an S-VHS VCR, use an S-video cable (in the S-video jacks) instead of the regular video cable.

Do not connect a regular video cable and an S-video cable to Video-1 (or Video-2) at the same time.

Connecting a cable converter box

This connection allows you to watch basic and premium cable channels.

To use the TV's features, select ANT-1. To view premium channels, select ANT-2, tune the TV to channel 3 or 4 (whichever channel is vacant in your area), and use the converter box to change channels.

You will need:

- two coaxial cables

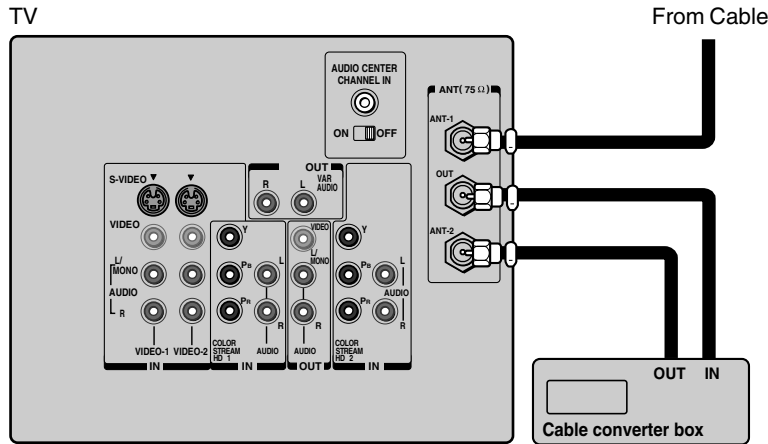

Note:

When you use a converter box with your TV, the remote control will not operate some features, such as programming your favorite channels, labeling channels, and locking channels.

Connecting a cable converter box and VCR

This connection allows you to watch and record basic and premium cable channels, watch videotapes, and record one channel while watching another channel. To use the TV's features, select ANT-1.

To view premium channels or record with the VCR, select ANT-2, tune the TV to channel 3 or 4 (whichever channel is vacant in your area), and use the converter box to change channels.

You will need:

- three coaxial cables
- one pair of audio cables (one single audio cable for a mono VCR)
- one video cable (one S-video cable for an S-VHS VCR)

Note:

If you have a mono VCR, connect L/Mono to VCR Audio OUT using only one audio cable.

If you have an S-VHS VCR, use an S-video cable (in the S-video jacks) instead of a regular video cable. Do not connect a regular video cable and an S-video cable to Video-1 (or Video-2) at the same time.

When you use a converter box with your TV, the remote control will not operate some features, such as programming your favorite channels, labeling channels, and locking channels.

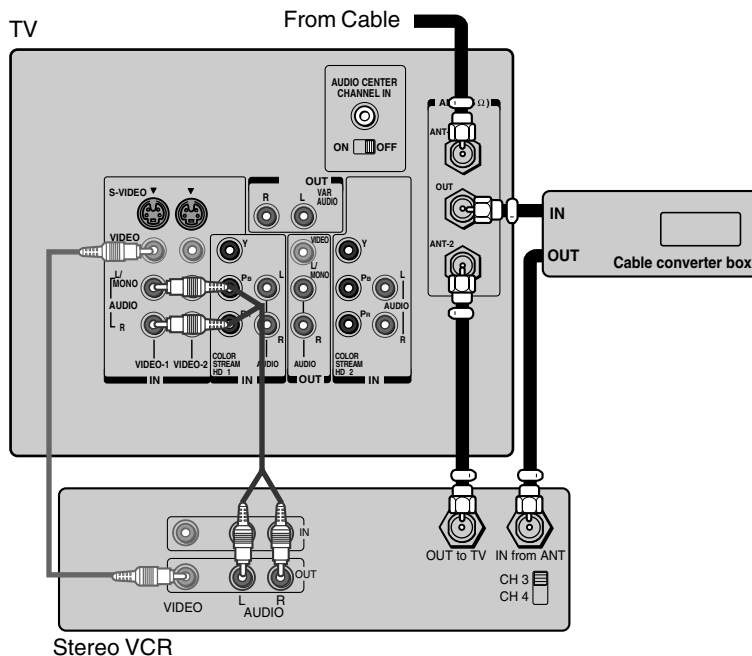

Connecting a DVD player or satellite receiver and a VCR

This connection allows you to watch DVD/satellite, VCR, and TV programs, and record one TV channel while watching another channel.

You will need:

- one coaxial cable
- two pairs of audio cables (one single and one pair of audio cables for a mono VCR)
- one video cable (between the TV and VCR)
- one S-video cable (between the TV and DVD player/satellite receiver)

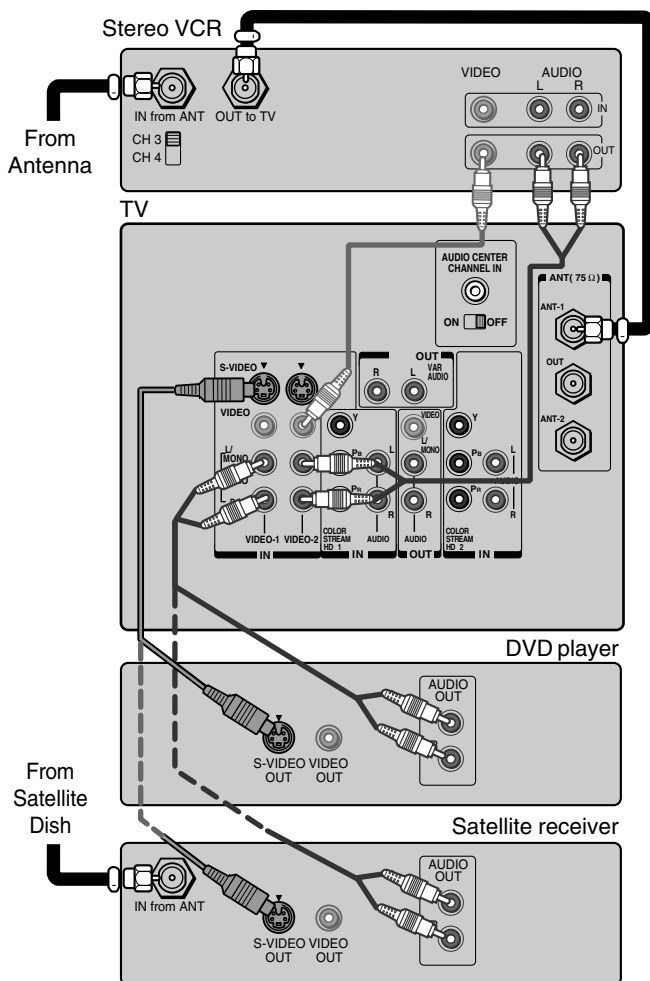

Note:

For the highest possible picture quality from a non-ColorStream DVD player/satellite receiver, you must use an S-video cable between the TV and DVD player/satellite receiver. (If your DVD player or satellite receiver is ColorStream-compatible, see page 8).

Do not connect both an S-video cable and a regular video cable between the TV and DVD player/satellite receiver at the same time. Doing so will distort the picture.

Do not connect the DVD player/satellite receiver and VCR to the same video channel on the TV. (See the illustrations, which show the DVD player/satellite receiver connected to Video-1 on the TV and the VCR connected to Video-2 on the TV.)

Caution:

The unauthorized recording of television programs, videotapes, and other materials may infringe upon the provisions of copyright laws.

Connecting a DVD player with ColorStream® and a VCR

This connection allows you to watch DVD, VCR, and TV programs, and record DVD and TV programs. You can record from one source while watching a program from another source.

Your TV has ColorStream® component video inputs. Connecting your TV to a ColorStream-compatible DVD player (such as a Toshiba ColorStream-equipped DVD player) can greatly enhance picture quality and realism.

You will need:

- one coaxial cable
- three pairs of audio cables (two single and one pair of audio cables for a mono VCR)
- two video cables
- one set of ColorStream video cables (one S-video cable for a non-ColorStream DVD player; see notes at right)

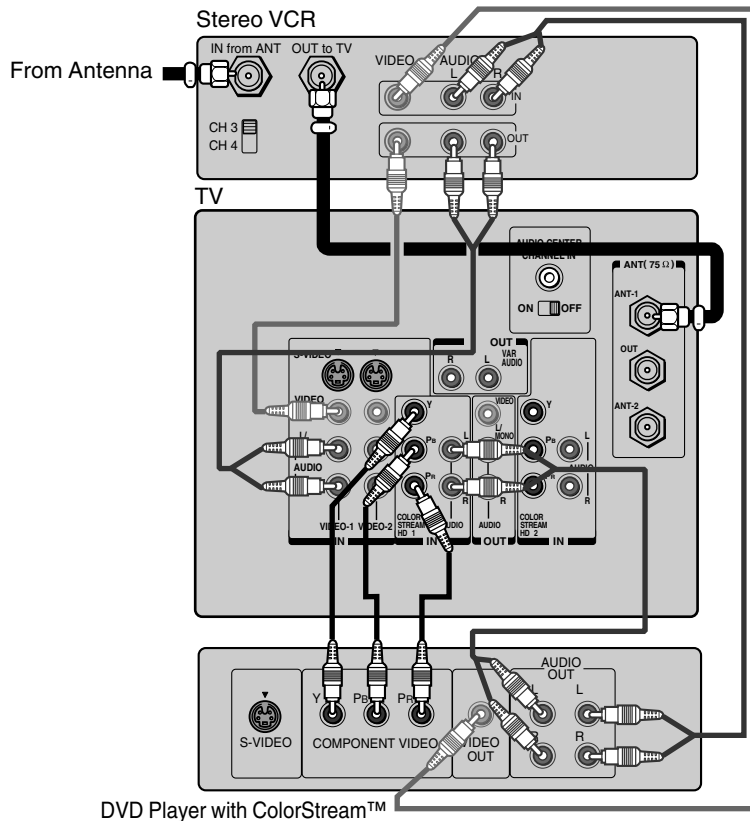

Note:

For the highest possible picture quality, you must use ColorStream video cables between the TV and DVD player. You can connect the ColorStream cables from the DVD player to either ColorStream jack on the TV (HD1 or HD2).

The ColorStream HD1 and HD2 jacks can be used with Progressive (480p) and Interlace (480i, 1080i) scan systems.

If your DVD player is not ColorStream-compatible, use the S-video connections (both audio and video) instead of the ColorStream connections. Do not connect both S-Video and ColorStream cables between the TV and DVD player at the same time.

To record from the DVD player, set the VCR to Line IN. To monitor recording from the DVD player, set the VCR to Line IN, and set the TV to Video-1.

Caution:

The unauthorized recording of television programs, videotapes, and other materials may infringe upon the provisions of copyright laws.

Connecting two VCRs

This connection allows you to record (dub/edit) from one VCR to another VCR while watching a videotape. You can also record from one TV channel while watching another TV channel.

You will need:

- one coaxial cable
- two pairs of audio cables (two single audio cables for mono VCRs)
- two video cables (two S-video cables for S-VHS VCRs)

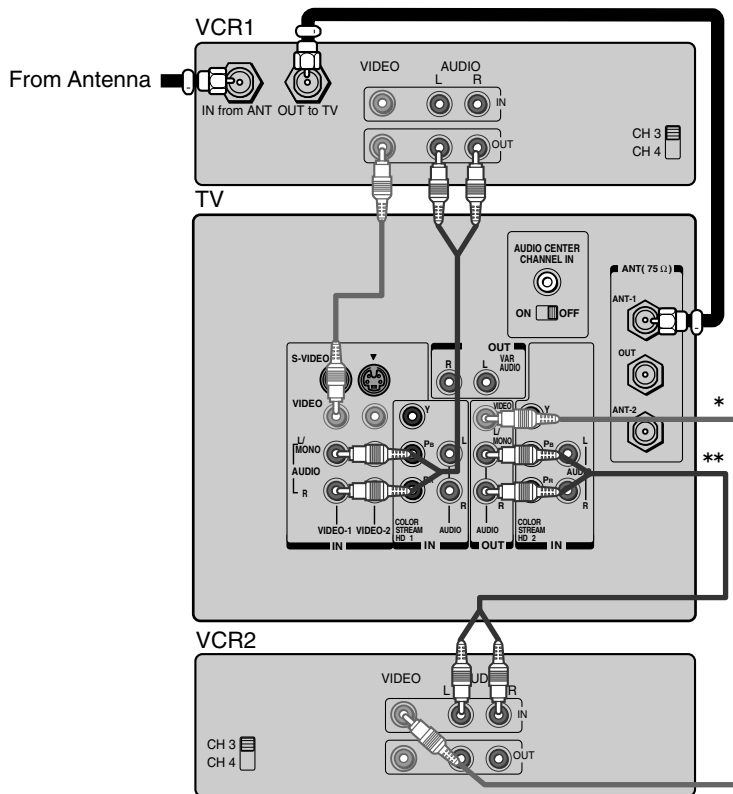

Caution:

The unauthorized recording of television programs, videotapes, and other materials may infringe upon the provisions of copyright laws.

Note:

If you have S-VHS VCRs, use S-video cables instead of regular video cables. Do not connect both a regular video cable and an S-video cable to Video-1 (or Video-2) at the same time.

Do not connect the same VCR to the output and input jacks on the TV at the same time.

To dub or edit, VCR 2 must select Line IN, and the TV must select Video-1.

* The Video OUT jack does not output the POP picture.

** The Audio OUT jacks can output the sound of either the Main or POP picture (see "Selecting the Audio OUT sound" on page 52).

Connecting a camcorder

This connection allows you to watch video materials recorded on a camcorder.

You will need:

- one pair of audio cables
- one video cable (one S-video cable for an S-VHS camcorder)

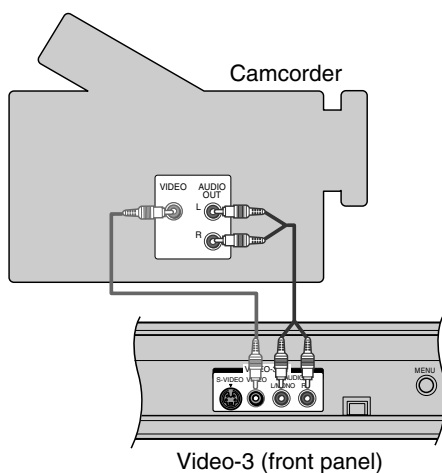

Caution:

If you have an S-VHS camcorder, use an S-video cable between the S-video jacks on the camcorder and TV. Do not connect both a regular video cable and an S-video cable at the same time.

Connecting an audio system

This connection allows you to use an audio amplifier to adjust the audio level. This also allows you to use external speakers.

To control the audio, turn on the TV and the stereo amplifier, and turn off the built-in speakers (see “Turning off the built-in speakers” on page 52).

You will need:

- one pair of audio cables

Note:

To hear sound when using an external audio amplifier, the volume of both the TV and the amplifier must be set above 0 (zero).

Connecting an A/V receiver

This connection allows you to use an audio/video (A/V) receiver to enhance your TV’s sound.

If you have a system with Dolby Pro Logic® surround sound, you can add to the realism of the sound by using the TV’s internal speakers as center channel speakers.

You will need:

- one pair of audio cables
- one single audio cable for the audio center channel
- one video cable

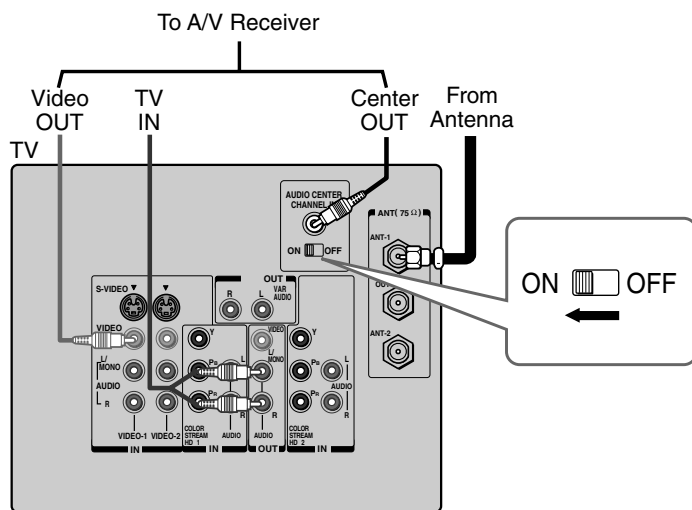

Note:

Refer to the instructions provided with your A/V receiver for details about your surround sound system.

When the Audio Center Channel ON/OFF switch is in the ON position, the TV speakers will function only as center channel speakers.

Adjust the volume for the center channel speakers using the center level control on the A/V receiver.

To use the TV speakers as normal speakers, set the Audio Center Channel ON/OFF switch to the OFF position.

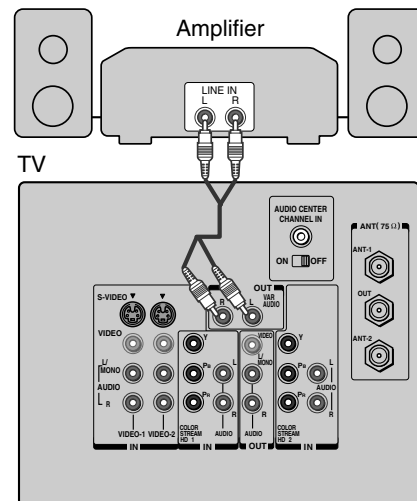

Caution:

To avoid damaging the speakers, turn the TV off before connecting or disconnecting the Audio Center Channel audio cable.

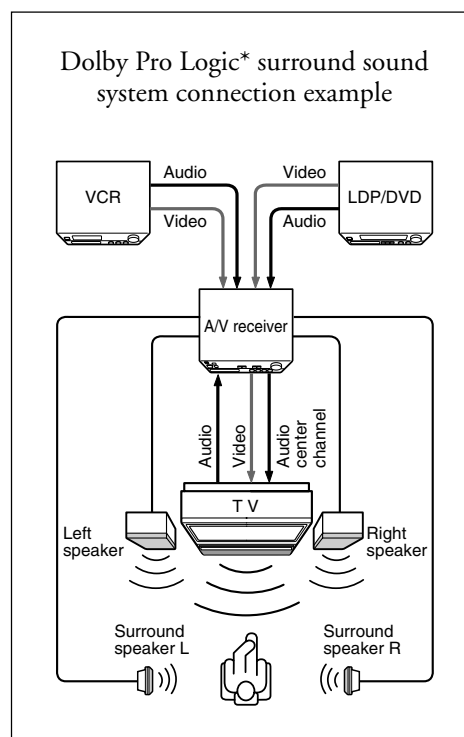

* Dolby Pro Logic is a registered trademark of Dolby Laboratories Licensing Corporation.

Using the remote control

Preparing the remote control for use

Your Toshiba TV remote control has one dedicated TV mode and five universal modes: VCR, Cable/SAT, DVD, Audio1, and Audio2. The target devices and default devices being programmed for each mode are as follows:

Target device/Mode mapping

Mode	Device
TV	Toshiba TV
CABLE/SAT	Universal Cable, Satellite
VCR	Universal VCR, DVD, LD, Cassette
DVD	Universal DVD, VCR, LD, Cassette
AUDIO1	Universal Audio: Amp., Tuner, Misc.Audio, CD/MD
AUDIO2	Universal Audio: CD/MD, Amp., Tuner, Misc.Audio

Default device codes

Mode	Default device
TV	Toshiba TV
CABLE/SAT	Toshiba Satellite receiver
VCR	Toshiba VCR
DVD	Toshiba DVD
AUDIO1	Pioneer Audio receiver
AUDIO2	Pioneer LD

Repeatedly press MODE to cycle among the modes. If you own different brands of audio/video devices, you must first program your remote control (see “Programming the remote control for use with your audio/video devices” on page 15).

Installing the remote control batteries

To install the batteries:

- Slide the battery cover off the back of the remote control.

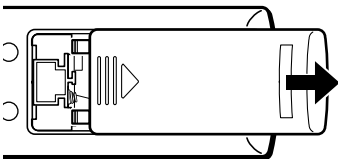

- Install two “AA” size alkaline batteries. Match the + and – signs on the batteries to the signs on the battery compartment.

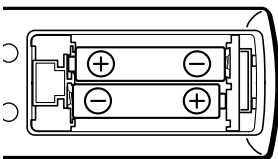

- Slide the battery cover back on to the remote control until the lock snaps.

Note:

Your TV's remote control may not operate certain features on your VCR, cable TV converter, or other electronic device.

Refer to the owner's manuals for your other devices to determine their available features. If your TV's remote control does not operate a specific feature on a device, use the remote control that came with the device.

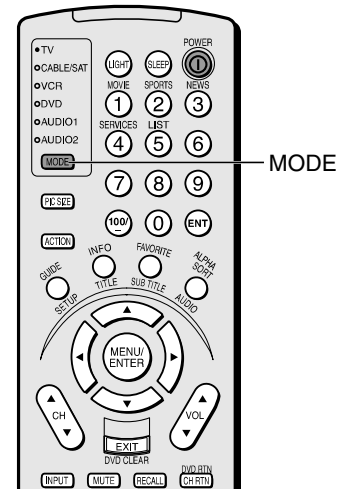

Caution:

- Dispose of batteries in a designated disposal area. Do not throw batteries into a fire.
- Do not mix battery types or combine used batteries with new ones.
- If the batteries are dead or if you will not use the remote control for a long time, remove the batteries to prevent battery acid from leaking into the battery compartment.

Note:

- Battery life expectancy is about one year with normal use.

Remote Control functional key chart

Key Label	Toshiba TV (TV)	Cable (CBL/SAT)	Satellite (CBL/SAT)	VCR	DVD/LD	Receiver (AUDIO)	CD/MD (AUDIO)	Cassete (VCR)
LIGHT	Lights the remote key, and toggles between enabled and disabled Illumination mode.							
SLEEP	Sleep timer	---	---	---	---	---	---	---
POWER	Power	Power	Power	Power	Power	Power	Power	Power
1/MOVIE	Digit 1	Digit 1	Digit 1	Digit 1	Digit 1	AV input 1	Digit 1	Digit 1
2/SPORTS	Digit 2	Digit 2	Digit 2	Digit 2	Digit 2	AV input 2	Digit 2	Digit 2
3/NEWS	Digit 3	Digit 3	Digit 3	Digit 3	Digit 3	AV input 3	Digit 3	Digit 3
4/SERVICES	Digit 4	Digit 4	Digit 4	Digit 4	Digit 4	AV input 4	Digit 4	Digit 4
5/LIST	Digit 5	Digit 5	Digit 5	Digit 5	Digit 5	CD	Digit 5	Digit 5
6	Digit 6	Digit 6	Digit 6	Digit 6	Digit 6	Tuner	Digit 6	Digit 6
MODE	Remote control device mode selection							
PIC SIZE	Selects the picture size.	This button is not available for other devices connected to this TV.						
7	Digit 7	Digit 7	Digit 7	Digit 7	Digit 7	Phono	Digit 7	Digit 7
8	Digit 8	Digit 8	Digit 8	Digit 8	Digit 8	Cassette	Digit 8	Digit 8
9	Digit 9	Digit 9	Digit 9	Digit 9	Digit 9	Aux	Digit 9	Digit 9
ACTION	---	Menu	Action, Menu	Menu	Menu	---	---	---
100/-	100	100	100	100	100	100	100	100
0	Digit 0	Digit 0	Digit 0	Digit 0	Digit 0	Digit 0	Digit 0	Digit 0
ENT	---	CH Enter	CH Enter	CH Enter	---	---	---	---
GUIDE/SETUP	---	Guide	Guide	Program	DVD setup	Program	Program	---
INFO/TITLE	---	---	INFO	---	TITLE= Top menu	---	---	---
FAVORITE/ SUBTITLE	Favorite CH	---	Favorite CH	---	Subtitle	---	---	---
ALPHASORT/ AUDIO	---	---	Alphasort	---	Audio	---	---	---
MENU/ ENTER	Menu open/ Enter	Select	Select	Enter	Enter	---	---	---
▲▼	Menu select	Menu select	Menu select	Menu select	Menu select	---	---	---
◀▶/(FAV) ▶▶	Menu select/ (FAV) ▶▶	Menu select	Menu select	Menu select	Menu select	---	---	---
VOL ▲▼	Volume up/down*	Volume up/down*	Volume up/down*	Volume up/down*	Volume up/down*	Volume up/down*	Volume up/down*	---
EXIT/ DVD CLEAR	Exit	Exit	Exit	Exit	DVD clear	Exit/Clear	Exit/Clear	Exit/Clear
CH ▲▼	Channel up/down	Channel up/down	Channel up/down	Channel up/down	---	Channel up/down	---	---
INPUT	TV/Video select	← TV	← TV	VCR input	← TV	Input	← TV	← TV
MUTE	Sound mute*	Sound mute*	Sound mute*	Sound mute*	Sound mute*	Sound mute*	Sound mute*	---
RECALL	On-screen display	On-screen display	On-screen display	On-screen display	On-screen display	---	---	---
CH RTN/ DVD RTN	Previous channel	Previous channel	Previous channel	Previous channel	DVD return	---	---	---
SLOW/ DIR	▶ ▲	---	---	Forward ---	Forward Reverse	---	---	---
SKIP/ SEARCH	▶ ▲	---	---	---	Forward Reverse	CH forward CH reverse	Forward Reverse	Forward Reverse
REW	VCR →	VCR →	VCR →	Rewind	Rewind	Rewind	Rewind	Rewind
PAUSE/STEP	VCR →	VCR →	VCR →	Pause	Pause	Pause	Pause	Pause
PLAY	VCR →	VCR →	VCR →	Play	Play	Play	Play	Play
FF	VCR →	VCR →	VCR →	F. Forward	F. Forward	F. Forward	F. Forward	F. Forward

Key Label	Toshiba TV (TV)	Cable (CBL/SAT)	Satellite (CBL/SAT)	VCR	DVD/LD	Receiver (AUDIO)	CD/MD (AUDIO)	Cassete (VCR)
TV/VCR	VCR →	Bypass A/B	TV/SAT	TV/VCR	---	---	---	---
AM/FM DISC	---	---	---	---	Disc shift	AM/FM	Disc shift	Deck side A/B switch
STOP	VCR →	VCR →	VCR →	Stop	Stop	Stop	Stop	Stop
REC	VCR →	VCR →	VCR →	Record	---	Record	Record	Record
PIP CH ▲▼	POP channel up/down	← TV	← TV	← TV	← TV	← TV	← TV	← TV
PIP	POP on/off	← TV	← TV	← TV	← TV	← TV	← TV	← TV
MULTI	This button is not available for this TV model or any other device connected to this TV.							
STILL	POP Still	← TV	← TV	← TV	← TV	← TV	← TV	← TV
SWAP	POP Swap	← TV	← TV	← TV	← TV	← TV	← TV	← TV
LOCATE	This button is not available for this TV model or any other device connected to this TV.							
SOURCE	POP Source	← TV	← TV	← TV	← TV	← TV	← TV	← TV

Notes:

- "—" will send nothing.
 - "← TV" will jump to TV.
 - "→ VCR" will jump to last active VCR or DVD. Active VCR/DVD is defined as the mode that remains for a minimum of 5 seconds, or if a key is pressed in that mode.
- * The VOLUME and MUTE will jump to "TV" by default. When the volume is unlocked, all the devices will have their own volume. The AUDIO1/2 (Receiver, CD) modes will have their own volume even if Volume Lock is on TV, CABLE/SAT, VCR, or DVD. See "Using the Volume Lock feature" on page 16.

Programming the remote control for use with your audio/video devices

Device code setup

1. Refer to the Device code table on pages 17–20 to find the code for the brand of your device.
If more than one number is listed, try each one separately until you find the one that works.
2. Press MODE until the Mode indicator of the device (CABLE/SAT, VCR, DVD, AUDIO1, AUDIO2) lights up.
3. While holding down the RECALL button, press the Channel Number buttons to enter the four-digit code of your brand of device. If a valid code is entered, the mode indicator will blink twice. If an invalid code is entered, the mode indicator will blink one long blink.
4. Point the remote control at the device and press POWER to test the code.
If the device turns on, you have entered the correct code.
If the device does not respond to the remote control, you may have entered the wrong code. Repeat steps 3 and 4 using another code.
5. Press MODE to select the TV mode to control the TV.

Searching and sampling the code of a device (991)

If you do not know the device code for a particular target unit, you can cycle the remote control through the available codes for that device mode and sample the functions to find the code that properly operates the target device. The keys available to be sampled, provided they are applicable to that mode, are 0, 1, 2, 3, POWER, VOL ▲, CH ▲, PLAY, and STOP. Invalid keys will be ignored while in program mode.

To cycle through each available device code and sample its functions:

1. Press MODE to select the mode you want to set up.
2. While holding down the RECALL button, press 9 –9 –1.
The remote control will enter program mode.
3. Point the remote control at the target device and press POWER (or other function buttons that are available to be sampled).
4. If the device responds to the remote control:
Press RECALL to store the device code.
The mode indicator will blink twice and the remote control will exit the program mode.
If the device does not respond to the remote control:
Press ▲, and then press POWER.
Repeat this step until the device responds to the remote control, and then press RECALL.

Note: When a search cycle is completed, the mode indicator will blink three times. The remote control will begin to cycle through the available codes again. If no key is pressed within 10 seconds while programming, the remote control will exit the program mode and return to the previous code.

Note:

- Every time you replace the batteries, you must reprogram the remote control.
- Some newer VCRs are capable of working on either of two remote codes. These VCRs have a switch labeled "VCR1/VCR2."
If your VCR has this kind of switch and does not respond to any of the codes for your VCR brand, set the switch to the other position (VCR1 or VCR2) and reprogram the remote control

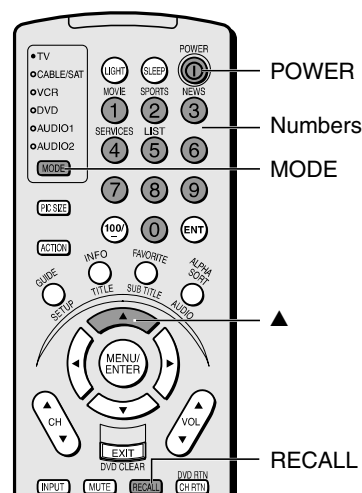

Verifying the device code (990)

Use this feature to verify the codes for your other devices. The number of blinks after pressing the 1, 2, 3, and 4 buttons is the 4-digit code set up for that mode.

For example, to verify the device code of the VCR:

1. Press MODE to select the VCR mode.
2. While holding down the RECALL button, press 9 –9 –0.
3. Press 1 → 0 blinks.
4. Press 2 → 3 blinks.
5. Press 3 → 8 blinks.
6. Press 4 → 5 blinks.

This verifies that the device code of the VCR mode is “0385.”

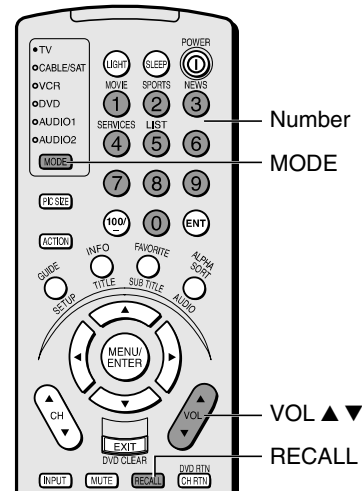

Using the volume lock feature (993)

For the TV, CABLE/SAT, VCR, and DVD modes, the volume controls (VOL ▲▼ and MUTE) can be programmed (locked) to the selected device mode. This feature does not apply to the AUDIO1/2 modes.

For example, to lock the volume controls to always jump to the CABLE/SAT mode:

1. Repeatedly press MODE to select the CABLE/SAT mode.
 2. While holding down the RECALL button, press 9 –9 –3.
 3. Press VOL ▲.
- The Mode indicator will blink two times (locked).

The following table describes in more detail the Volume Lock implementation.

Volume Locked to	TV	CBL/SAT	VCR	DVD	AUD1	AUD2
TV (default)	TV	TV	TV	TV	AUD1	AUD2
CBL/SAT	CBL/SAT	CBL/SAT	CBL/SAT	CBL/SAT	AUD1	AUD2
VCR	VCR	VCR	VCR	VCR	AUD1	AUD2
DVD	DVD	DVD	DVD	DVD	AUD1	AUD2
AUD1	AUD1	AUD1	AUD1	AUD1	AUD1	AUD1
AUD2	AUD2	AUD2	AUD2	AUD2	AUD2	AUD2

To reset the volume controls to the original device code:

1. While holding down the RECALL button, press 9 –9 –3.
 2. Press VOL ▼.
- The Mode indicator will blink four times (unlocked).

Operational feature reset (980)

This feature clears all setup features not related to “Device code set up” and resets the Volume Lock to “TV.”

To reset the features:

- While holding down the RECALL button, press 9 –8 –0.
- The Mode indicator will blink two times, and then pause and blink two more times.

Device code table

Cable box setup codes

Brand	Code
ABC	0020, 0022, 0026, 0027, 0030, 0032, 0033, 0036
Allegro	0172, 0334
Americast	0918
Antronix	0041, 0226
Archer	0041, 0172, 0226, 0816
BBT	0286
Belcor	0075
Bell & Howell	0033
Bell South	0918
Cable Star	0075
Cabletenna	0041
Cableview	0041
Century	0172
Citizen	0172, 0334
Colour Voice	0044, 0050
Comtronics	0059
Contec	0038
Digi	0656
Eastern	0021
Emerson	0816
Everquest	0034, 0059
Focus	0419
GC Electronics	0075, 0226
Garrard	0172
Gemini	0034, 0089, 0816
General Instrument	0030, 0295, 0495, 0829
GoldStar	0059, 0163
Goodmind	0816
Hamlin	0028, 0039, 0053, 0278, 0292
Hitachi	0030
Hytex	0026
Jasco	0034, 0172, 0334
Jerrold	0022, 0030, 0031, 0033, 0034, 0043, 0295, 0495, 0829
Linsay	0459
Magnavox	0046
Memorex	0019
Movie Time	0082, 0175
NSC	0082, 0089, 0175
Novaplex	0637
Oak	0026, 0038
Optimus	0040
Panasonic	0019, 0040, 0126
Panther	0656
Paragon	0019
Philips	0044, 0046, 0050, 0172
Pioneer	0042, 0163, 0552, 0896
Popular Mechanics	0419
Prelude	0789
Pulsar	0019
Quasar	0019
RCA	0040
Radio Shack	0034, 0334, 0816, 0902
Realistic	0226
Recoton	0419
Regal	0039, 0278, 0292
Regency	0021
Rembrandt	0030, 0089
Runco	0019

SL Marx	0059
Samsung	0059, 0163
Scientific Atlanta	0027, 0036, 0496, 0896
Seam	0529
Signal	0034, 0059
Signature	0030
Sprucer	0040
StarSight	0441, 0561
Starcom	0022, 0034
Stargate	0034, 0059, 0789, 0816
Starquest	0034
Sylvania	0020
TFC	0329
TV86	0082
Tandy	0277
TeleCaption	0240
Teleview	0059
Texscan	0020
Timeless	0437
Tocom	0031, 0032
Toshiba	0019
Tusa	0034
Unika	0041, 0172, 0226
United Artists	0026
Universal	0041, 0075, 0172, 0210, 0226
Viewstar	0046, 0082, 0277
Zenith	0019, 0073, 0544, 0918
Zentek	0419

Satellite Receiver setup codes

Brand	Code
AlphaStar	0791
Chaparral	0072, 0235
Curtis Mathes	0080
Echostar	0288, 0299, 0794, 1024
Expressvu	0794
General Instrument	0380, 0646, 0888
HTS	0794
Hitachi	0838
Homecable	0257
Hughes Network Systems	0768
IQ	0229
IQ Prism	0229
JVC	0794
Jerrold	0380, 0646
Legend	0288
Macom	0080
Magnavox	0741, 0743
Memorex	0288, 0743
Next Level	0888
Panasonic	0720
Philips	0741, 0743
Primestar	0380, 0646
RCA	0162, 0411, 0585, 0874
Radio Shack	0888
Realistic	0071
STS	0229
Sony	0658
Star Choice	0888
Toshiba	0080, 0101, 0768, 0809, 1071, 1072, 1073
Uniden	0071, 0093, 0257, 0741, 0743
Zenith	0080, 0875

Device code table

VCR setup codes

Brand	Code	Brand	Code	Brand	Code
Admiral	0067, 0228	Kenwood	0057, 0060, 0086, 0403	Radix	0056
Adventura	0019			Randex	0056
Aiko	0297	Kodak	0054, 0056	Realistic	0019, 0054, 0056, 0065, 0066, 0067, 0081, 0085, 0123
Aiwa	0019, 0056, 0326	LXI	0056	ReplayTV	0633, 0635
Akai	0060, 0072, 0080, 0125	Lloyd's	0019, 0227	Ricoh	0053, 0272
America Action	0297	Logik	0091	Runco	0058
American High	0054	MEI	0054	STS	0061
Asha	0259	MGA	0062, 0080, 0259	Samsung	0064, 0070, 0072, 0259
Audiovox	0056	MGN Technology	0259	Sanky	0058, 0067
Beaumarck	0259	MTC	0019, 0259	Sansui	0019, 0060, 0086, 0228, 0290, 0498
Bell & Howell	0123	Magnasonic	0297	Sanyo	0065, 0066, 0123, 0259
Broksonic	0021, 0140, 0203, 0228, 0314, 0380, 0498	Magnavox	0019, 0054, 0058, 0100, 0129, 0168	Scott	0062, 0064, 0140, 0203, 0229, 0231
CCE	0091, 0297	Magnin	0259	Sears	0019, 0054, 0056, 0061, 0065, 0066, 0073, 0076, 0085, 0123, 0124
Calix	0056	Marantz	0054, 0100	Semp	0064
Canon	0054	Marta	0056	Sharp	0067, 0081
Capehart	0039	Matsushita	0054, 0181, 0473	Shintom	0091
Carver	0100	Memorex	0019, 0054, 0056, 0058, 0065, 0066, 0067, 0123, 0181, 0228, 0259, 0326, 0473, 1056, 1181, 1281	Shogun	0070, 0259
Cineral	0297	Minolta	0061, 0124	Singer	0091
Citizen	0056, 0297	Mitsubishi	0062, 0067, 0080, 0086	Sony	0019, 0051, 0052, 0053, 0054, 0272, 1051
Colt	0091	Motorola	0054, 0067	Sunpak	0272
Craig	0056, 0066, 0091, 0259, 0290	Multitech	0019, 0091	Sylvania	0019, 0054, 0062, 0100, 0129
Curtis Mathes	0054, 0060, 0079, 0181	NAD	0077	Symphonic	0019
Cybernex	0070, 0259	NEC	0057, 0059, 0060, 0086, 0123	TMK	0055, 0227, 0259
Daewoo	0039, 0064, 0297, 0580	Nikko	0056	Tatung	0060
Daytron	0039	Nikon	0053, 0272	Teac	0019, 0060
Denon	0061	Noblex	0259	Technics	0054, 0181
Dynatech	0019	Olympus	0054	Teknika	0019, 0054, 0056
Electrohome	0056	Optimus	0056, 0067, 0077, 0123, 0181, 0451, 0473, 1067, 1081, 1181, 1281	Thomas	0019
Electrohome	0056	Optonica	0081	Tivo	0637
Emerex	0051	Orion	0021, 0203, 0228, 0314, 0498	Toshiba	0062, 0064, 0076, 0085, 0229, 0231, 0385
Emerson	0019, 0021, 0055, 0056, 0062, 0080, 0087, 0107, 0140, 0203, 0227, 0228, 0231, 0297, 0313, 0314, 0380, 0498, 0580	Panasonic	0054, 0096, 0181, 0244, 0473, 0635, 1081, 1181, 1281	Totevision	0056, 0259
Fisher	0066, 0073, 0085, 0123	Penney	0054, 0056, 0057, 0059, 0061, 0073, 0259	Unitech	0259
Fuji	0052, 0054	Pentax	0061, 0124	Vector	0064
Funai	0019	Philco	0054, 0228, 0498	Vector Research	0057, 0059
GE	0054, 0067, 0079, 0221, 0259	Philips	0054, 0081, 0100, 0129, 0637, 1100, 1200	Video Concepts	0059, 0064, 0080
Garrard	0019	Pilot	0056	Videosonic	0259
Go Video	0451, 0545, 0662	Pioneer	0077, 0086	Wards	0019, 0054, 0061, 0066, 0067, 0079, 0081, 0091, 0100, 0168, 0231, 0259
GoldStar	0056, 0057	Portland	0039	White Westinghouse	0228, 0297
Gradiente	0019, 0027	Profitronic	0259	XR-1000	0019, 0054, 0091
HI-Q	0066	Proscan	0079, 0221	Yamaha	0057
Harley Davidson	0019	Protec	0091	Zenith	0019, 0052, 0053, 0058, 0228, 0498, 0656
Harman/Kardon	0057, 0100	Pulsar	0058, 0070		
Harwood	0087, 0091	Quarter	0065		
Headquarter	0065	Quartz	0065		
Hitachi	0019, 0060, 0061, 0124	Quasar	0054, 0096, 0181, 0473, 1181		
Hughes Network Systems	0061	RCA	0054, 0061, 0067, 0079, 0096, 0124, 0125, 0168, 0221, 0259		
JVC	0027, 0060, 0086, 0403	Radio Shack	0019, 1056		
Jensen	0060				
KEC	0056, 0297				
KLH	0091				

Device code table

DVD setup codes

Brand	Code
Aiwa	0660
Denon	0509, 0653
GE	0541
Harman/Kardon	0601
JVC	0577, 0642
Kenwood	0553
Magnavox	0522
Marantz	0558
Mitsubishi	0540
Onkyo	0522, 0646
Optimus	0590
Panasonic	0509, 0651
Philips	0522, 0558
Pioneer	0544, 0590, 0651
Proscan	0541
RCA	0541
Samsung	0592
Sharp	0649
Sherwood	0652
Sony	0552
Technics	0509
Theta Digital	0590
Toshiba	0522
Yamaha	0509, 0564
Zenith	0522, 0610

Laser Disc setup codes

Brand	Code
Aiwa	0222
Carver	0083, 0213, 0342
Denon	0078, 0191
Disco Vision	0042
Funai	0222
Harman/Kardon	0213
Hitachi	0042
Magnavox	0213, 0236
Marantz	0083, 0213
Mitsubishi	0078
NAD	0078
Optimus	0078
Panasonic	0223
Philips	0083, 0213
Pioneer	0042, 0078
Quasar	0223
Realistic	0222
Samsung	0342
Sega	0042
Sony	0212, 0220
Technics	0223
Theta Digital	0213
Yamaha	0236

CD Player setup codes

Brand	Code
ADC	0037
Adcom	0174, 0253
Aiwa	0143, 0176
Akai	0175
Audio Alchemy	0213
Audio-Technica	0189
BSR	0213, 0264
Burmester	0439
California Audio Labs	0048, 0322
Carrera	0213
Carver	0176, 0198, 0318, 0456
DAK	0264
DKK	0019
Denon	0022, 0892
Emerson	0174, 0183, 0324, 0488
Fisher	0107, 0193, 0198, 0361
GE	0028
Garrard	0264, 0299, 0412, 0439
Genexxa	0051, 0183, 0324
Harman/Kardon	0176, 0192, 0445
Hitachi	0051, 0174
JVC	0091
Kenwood	0047, 0056, 0209, 0645, 0700, 0845
Kodak	0306
Krell	0176
Kyocera	0037
LXI	0324
Linn	0176
Luxman	0112
MCS	0048
MTC	0439
Magnavox	0176, 0324
Marantz	0048, 0176, 0199
McIntosh	0306
Mission	0176
NAD	0038, 0318
NEC	0253
NSM	0176
Nikko	0183, 0189, 0193
Onkyo	0120, 0887
Optimus	0019, 0051, 0056, 0106, 0164, 0198, 0213, 0215, 0299, 0324, 0361, 0439, 0445, 0456, 0487, 1082
Panasonic	0048, 0322, 0386, 0771
Parasound	0213, 0439
Philips	0176, 0306, 0645
Pioneer	0051, 0263, 0324, 0487, 1082
Proton	0176
QED	0176
Quasar	0048
RCA	0028, 0072, 0174, 0198, 0324, 0783
Realistic	0174, 0183, 0198, 0199, 0439
Rotel	0176, 0439
SAE	0176
STS	0037
Sansui	0176, 0221, 0324
Sanyo	0106, 0198
Scott	0174, 0183, 0324
Sears	0324
Sharp	0056, 0199, 0880
Sherwood	0199, 0215, 0445, 1086
Sony	0019, 0204, 0509, 0623, 0624
Soundesign	0164
Tascam	0439
Teac	0193, 0199, 0412, 0439
Technics	0048, 0322
Toshiba	0038, 0318
Vector Research	0213
Victor	0091
Wards	0072, 0176
Yamaha	0055, 0189, 0206
Yorx	0480

Device code table

Amplifier setup codes

Brand	Code
Aiwa	0425
Carver	0288
Curtis Mathes	0319
Denon	0179
GE	0097
Harman/Kardon	0911
JVC	0350
Linn	0288
Magnavox	0288
Marantz	0288
Optimus	0319, 0414
Panasonic	0327
Philips	0288, 0911
Pioneer	0032, 0319
Realistic	0414
Sony	0239, 0708
Soundesign	0097
Technics	0327
Toshiba	0372
Victor	0350
Wards	0032, 0097
Yamaha	0373

Cassette Player setup codes

Brand	Code
Aiwa	0048, 0216, 0219
Akai	0302
Carver	0048
Denon	0095
Fisher	0093
Garrard	0327, 0458
Harman/Kardon	0048, 0201
JVC	0263, 0292
Kenwood	0089
Magnavox	0048
Marantz	0028, 0048
Mitsubishi	0302
Onkyo	0154, 0155, 0301
Optimus	0046, 0239, 0356, 0458
Panasonic	0248
Philips	0048
Pioneer	0046, 0118, 0239
Revox	0209
Sansui	0028, 0048
Sherwood	0356
Sony	0189, 0262, 0310
Teac	0327
Technics	0248
Toshiba	0360, 0361
Victor	0292
Wards	0046
Yamaha	0113, 0116

Misc. Audio setup codes

Brand	Code
Aiwa	0029, 0178, 0423
Fisher	0071
Harman/Kardon	0496
JBL	0496
JVC	0092
Jerrold	0478, 0539
Nikko	0395
Paramount Pictures	0336
RCA	0075
SSI	0336
Schneider	0395
Scientific Atlanta	0479
Sony	0029, 0178, 0595
Soundesign	0395
Starcom	0478
Yorx	0395

Receiver setup codes

Brand	Code
ADC	0550
Adcom	0635
Aiwa	0140, 0177, 0208, 0424, 1108, 1424
Akai	0095, 0243
Capetronic	0550
Carver	0027, 0061, 0208, 0379, 1108, 1208
Casio	0214
Clarinette	0214
Curtis Mathes	0099
Denon	0023, 0292, 0790, 1123, 1179
Emerson	0443
Fisher	0061, 0238, 0379
Garrard	0443, 0482
Harman/Kardon	0129, 0208, 0910
Inkel	0081
JBL	0129
JVC	0093
Kenwood	0046, 0061, 0096, 0205, 0332, 0333, 1046, 1071, 1332, 1588
Koss	0443
LXI	0200
Linn	0208
Lloyd's	0214
MCS	0058, 0365
Magnavox	0147, 0208, 0214, 0410, 0550, 1108, 1208
Marantz	0058, 0147, 0208, 1108, 1208
Modulaire	0214
NAD	0339
NEC	0254
Nakamichi	0116, 0366
Onkyo	0119, 0154, 0399
Optimus	0061, 0099, 0196, 0200, 0205, 0238, 0550, 0689, 0757, 0820, 1042
Panasonic	0058, 0328, 0537, 1537
Penney	0214
Philips	0208, 0410, 1108, 1208

Pioneer	0033, 0099, 0169, 0550, 0649, 1042, 1273
Proscan	1273
Quasar	0058
RCA	0073, 0365, 0379, 0549, 0550, 1173, 1273
Realistic	0182, 0200, 0214
Sansui	0208, 0212, 0365, 1108
Sanyo	0238, 0820
Scott	0182, 0341
Sharp	0205
Sherwood	0081, 0510, 0521
Sony	0177, 0187, 0493, 1061, 1077, 1177, 1277
Soundesign	0689
Sunfire	0332, 0333, 1071, 1332
Teac	0182, 0482
Technics	0058, 0227, 0328, 0537, 1327, 1328, 1537
Thorens	1208
Victor	0093
Wards	0033, 0073, 0099, 0177, 0208
Yamaha	0195, 0205, 1195
Yorx	0214
Zenith	0876

Learning about the remote control

The buttons used for operating the TV only are described here. For a complete list of the remote control's functions, see the "Remote Control functional key chart" on pages 13–14.

POWER turns the TV on and off

SLEEP allows access to the automatic TV shut-off function (page 48)

LIGHT The first press of the LIGHT button lights the keypad and turns on the Illumination mode. With the Illumination mode on, pressing any other key lights the keypad for 5 seconds (10 seconds if you're in programming mode). Subsequent presses of the LIGHT button toggle between turning the Illumination mode on and off.

Channel Numbers (0-9, 100) allow direct access to channels (page 25)

MODE cycles through the six device modes: TV, CABLE/SAT, VCR, DVD, AUDIO1, and AUDIO2. The mode indicator light will remain lit for 10 seconds (page 15).

PIC SIZE cycles through the five picture sizes: Normal, Theater Wide 1, 2, 3 and Full (page 31)

FAVORITE allows access to the favorite channel search function (page 35)

MENU allows access to on-screen programming menus (page 22)

ENTER sets programming menu information (page 22)

▲▼◀▶ select or adjust programming menus (page 22)

(FAV) ◀▶ cycles through favorite channels (page 28)

CH ▲▼ cycles through programmed channels (page 25)

VOL ▲▼ adjusts the volume level

EXIT exits the programming menus (page 22)

INPUT selects the video input source (page 46)

MUTE mutes the sound (page 49)

RECALL displays on-screen information (page 53)

CH RTN returns to the last viewed channels (page 28)

PIP CH ▲▼ selects the POP (picture-out-picture) channel (page 34)

PIP turns the POP feature on and off (page 34)

STILL freezes the POP picture (page 35)

SWAP switches the main and POP pictures (page 35)

SOURCE selects the POP picture source (page 34)

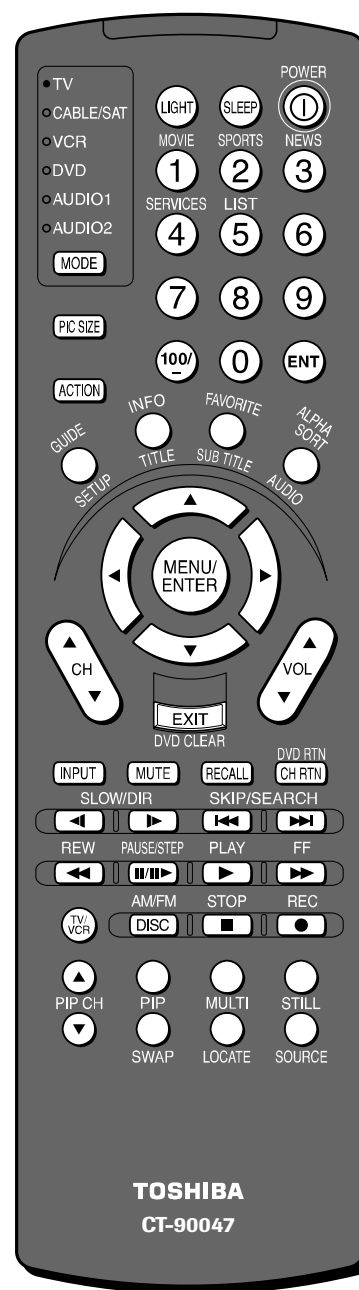

Setting up your TV

Learning about the menu system

After you have installed the batteries and programmed the remote control, you will need to set some preferences on the TV using the menu. You can access the menu using the buttons on your TV or remote control.

1. Press MENU to display the menu system.
2. Press ◀ or ▶ to select menu.
3. Press ▲ or ▼ select an item.
4. Press ◀ or ▶ to select or adjust a setting.

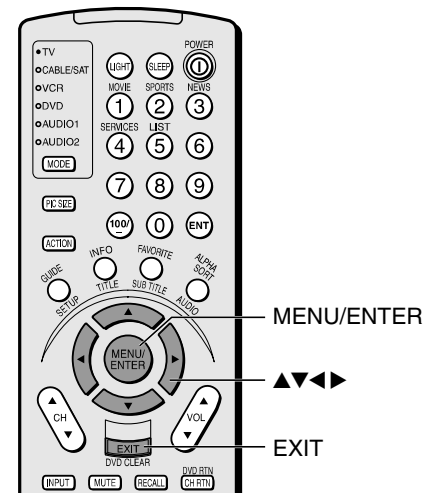
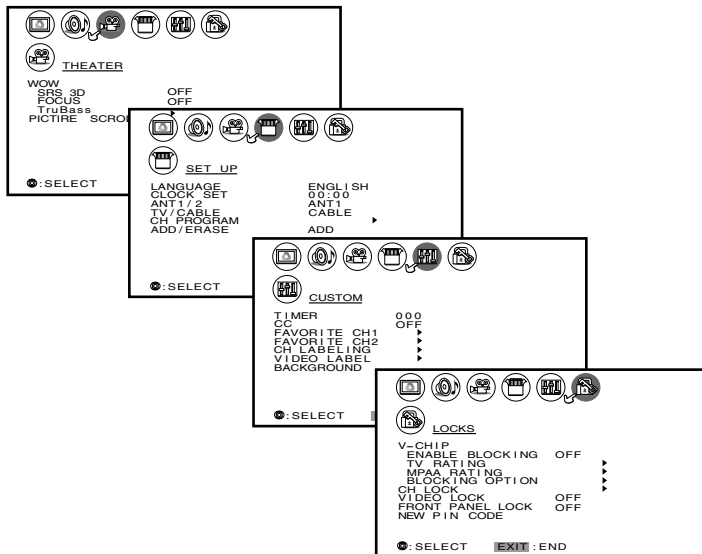
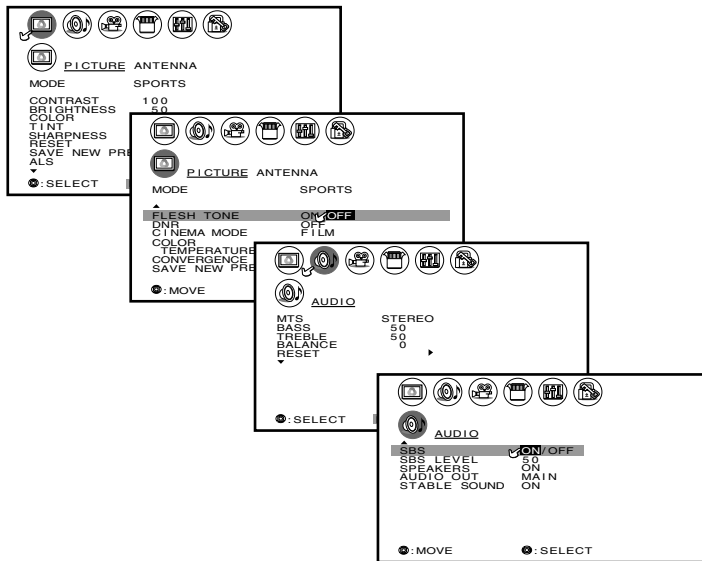
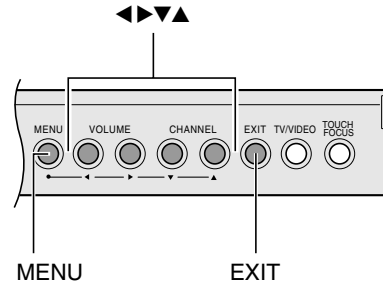

Note:

You can change the background of the menu. See page 53 for details.

- Press ENTER to activate the function settings in the CUSTOM menu etc.
- If you do not make a selection within 15 seconds, the main menu display disappears automatically; the other displays disappear automatically within 6 seconds (except the Convergence menu, which will remain until a button is pressed).
- If you want to close all the on-screen displays instantly, press EXIT.

Changing the on-screen display language

You can choose from three different languages (English, French and Spanish) for the on-screen display of adjustment menus and messages.

To select a language:

1. Press MENU, and then press ◀ or ▶ until the SET UP menu appears.
2. Press ▲ or ▼ to highlight LANGUAGE.

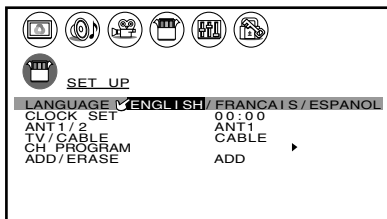

3. Press ◀ or ▶ to highlight your desired language.

Selecting the antenna input

You can connect to two different antenna input sources (ANT 1 or ANT 2).

To select the antenna input using the menu system:

1. Press MENU, and then press ◀ or ▶ to highlight the SET UP menu.
2. Press ▲ or ▼ to highlight ANT 1/2.

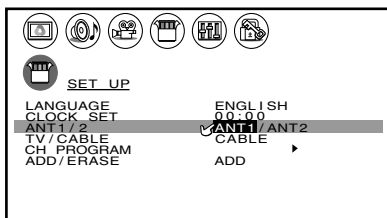

3. Press ◀ or ▶ to highlight either ANT 1 or ANT 2, depending on the antenna terminal you wish to use.

To select the antenna input using the INPUT or TV/VIDEO button:

1. Press INPUT on the remote control or TV/VIDEO on the TV (see illustrations below). The current signal source displays in purple.
2. Continue pressing INPUT or TV/VIDEO button to select ANT 1 or ANT 2.

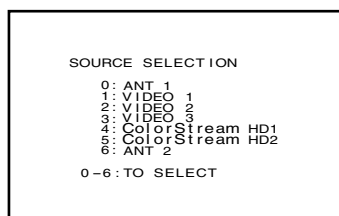

Pressing INPUT on the remote control displays the current signal source (press INPUT again or 0-6 to change)

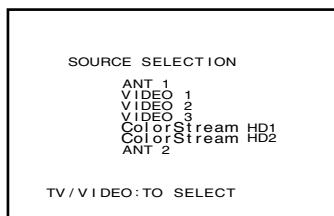

Pressing TV/VIDEO on the TV changes the current signal source

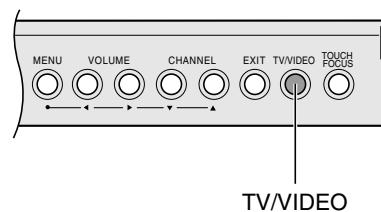
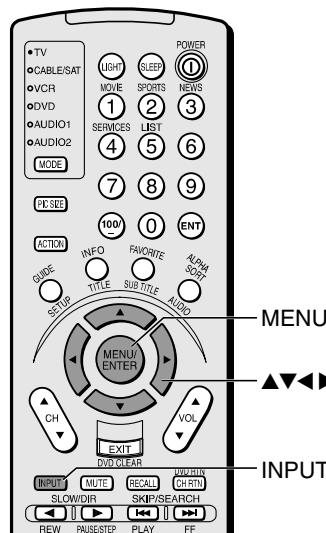
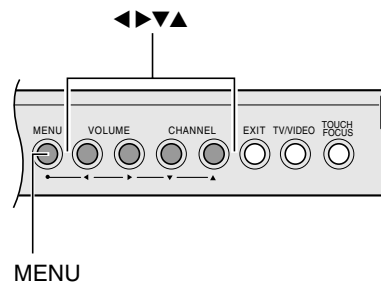

Adding channels to the TV's memory

When you press Channel ▲ or ▼, your TV will stop only on the channels stored in the TV's channel memory.

Follow the steps below and on the next page to program all active channels into the TV's memory.

Programming channels automatically

Your TV can automatically detect all active channels in your area and store them in its memory. After the channels are stored automatically, you can manually add or erase individual channels (see page 25).

To program channels automatically:

1. Press MENU, and then press ◀ or ▶ until the SET UP menu appears.
2. Press ▲ or ▼ until TV/CABLE is highlighted.
3. Press ◀ or ▶ to highlight either TV or CABLE, depending on which you use. If you use an antenna, highlight TV; if you use cable, highlight CABLE.

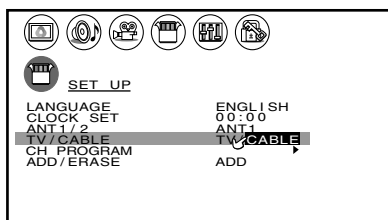

4. Press ▼ to select CH PROGRAM.

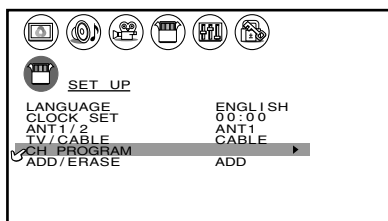

5. Press ◀ or ▶ to start channel programming. The TV will automatically cycle through all the TV or Cable channels (depending on which you selected), and store all active channels in the channel memory.

While the TV is cycling through the channels, the message "Programming Now—Please Wait" appears.

6. When channel programming is complete, the message "Completed" appears.

7. Press Channel ▲ or ▼ to view the programmed channels.

Note:

To tune the TV to a channel not programmed in the channel memory, you must use the Channel Number buttons on the remote control.

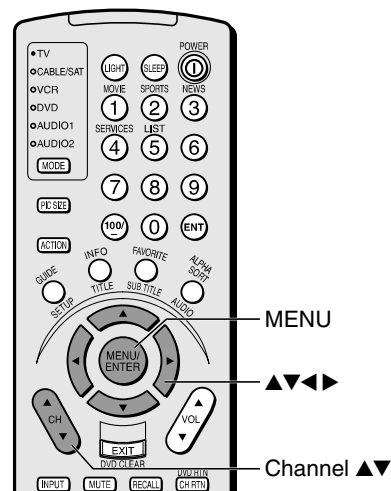

Adding and erasing channels manually

After you have programmed the channels automatically, you can manually add or erase specific channels.

To add or erase channels:

1. Select the channel you want to add or erase. If you are adding a channel, you must select the channel using the Channel Number buttons.
2. Press MENU, and then press ◀ or ▶ until the SET UP menu appears.
3. Press ▲ or ▼ to highlight ADD/ERASE.

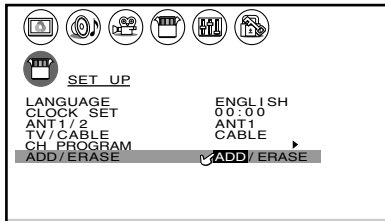

4. Press ◀ or ▶ to select ADD or ERASE, depending on the function you want to perform.
5. Repeat steps 1–4 for other channels you want to add or erase.

Changing channels

To change to the next programmed channel:

Press Channel ▲ or ▼ on the TV or remote control.

To change to the specific programmed channel:

Press and hold Channel ▲ or ▼ for about one second. The TV will enter the channel surf mode.

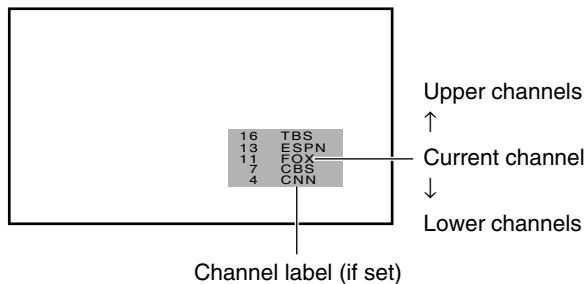

Repeatedly press or hold channel ▲ or ▼ while the channel surf mode is on-screen to scroll the channel list. Release the button to display the highlighted channel.

To change to a specific channel (programmed or unprogrammed):

Press the Channel Number buttons (0–9 and 100).

For channels 100 and higher, press the 100 button, and then the next two numbers. For example, to select channel 125, press 100, 2, 5.

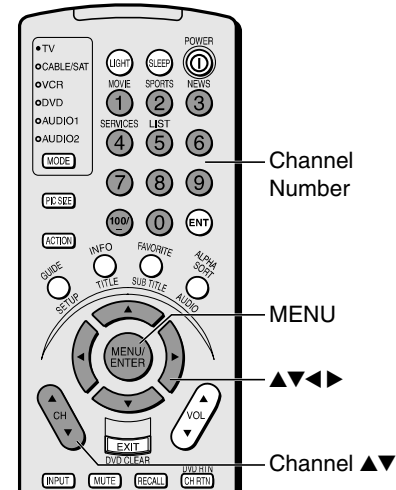
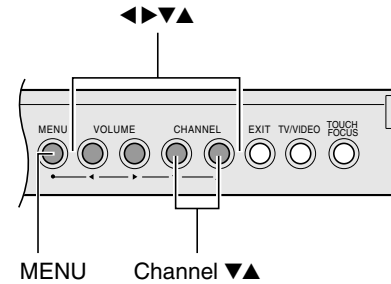

Adjusting the color convergence

This projection TV uses three separate TV tubes: red, green, and blue. The red, green, and blue images are projected onto the screen where they converge to form a full-color picture. You can see a clear picture only when the three images converge correctly. Convergence may drift over time or if you move the TV. If you can see clear images on your TV screen, skip this procedure.

This adjustment should be made only after the TV has been on for at least 30 minutes.

To use the TOUCH FOCUS (Auto convergence) button:

Press TOUCH FOCUS on the TV once. The TV will enter the auto convergence mode and correctly adjust convergence automatically.

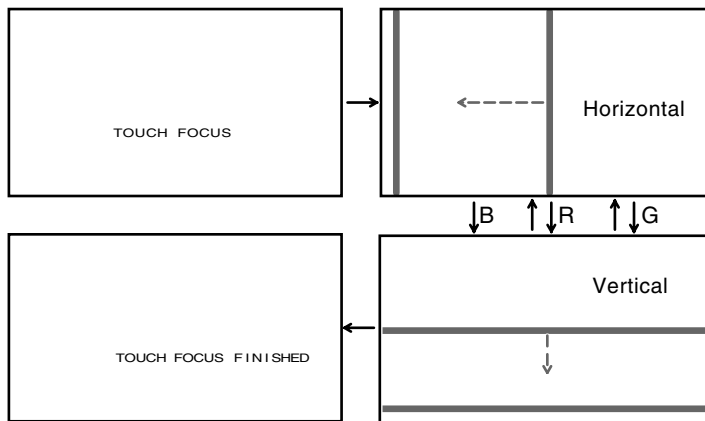

When the adjustment is complete, normal picture will reappear.

If error message "Touch Focus Error" appears, retry the TOUCH FOCUS adjustment or adjust the convergence manually, as described below.

To check and adjust the color convergence manually:

1. Press MENU, and then press ◀ or ▶ until the PICTURE menu appears.
2. Press ▲ or ▼ to highlight CONVERGENCE.

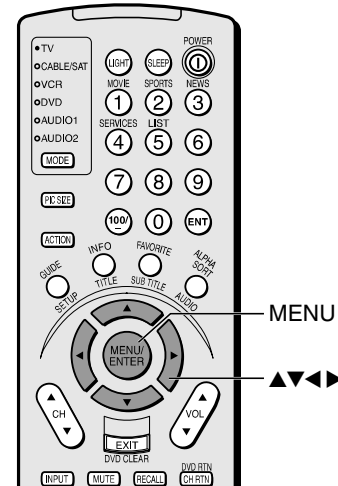
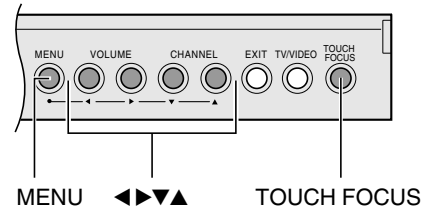
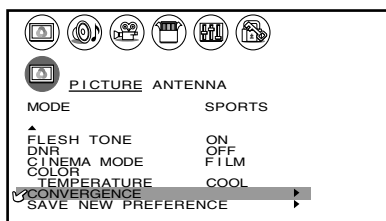

3. Press ◀ or ▶ to display the Center Convergence menu.

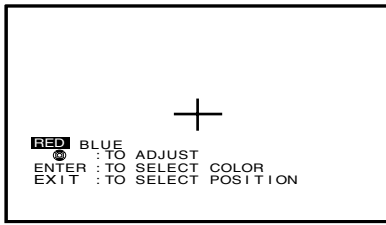

If you see separate red, blue, or green crossed lines (or red or blue shadows next to white lines), you need to adjust the convergence.

4. Press ENTER to highlight RED or BLUE, depending on which color needs adjusting. If both red and blue need adjusting, you will need to perform steps 4 and 5 twice.
5. Press ▲ (up), ▼ (down), ◀ (left), or ▶ (right) on the remote control to converge the red or blue line into the green line, which will turn completely white when correctly adjusted. When color convergence is correctly adjusted, you will see two single crossed white lines.
6. Press EXIT to display the Circumference Convergence menu.
7. Press the corresponding Number button (1–4 and 6–9) to select the area you want to adjust.

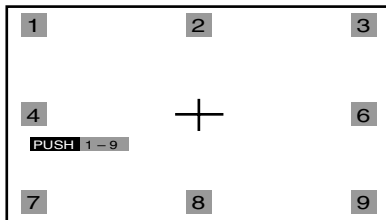

8. Press ENTER to highlight RED or BLUE, depending on which color needs adjusting. If both red and blue need adjusting, you will need to perform steps 8 and 9 twice for the selected area.

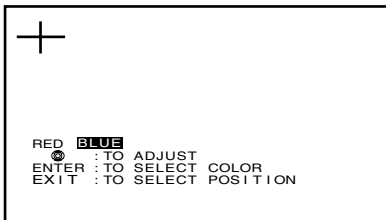

9. Press ▲▼◀▶ to converge the red or blue line into the green line, which will turn completely white when correctly adjusted. Repeat steps 8 and 9 until you see two single crossed white lines.
10. Press EXIT once to select another area to adjust, and then repeat steps 7–9.
11. Press EXIT twice to close the Convergence menu.

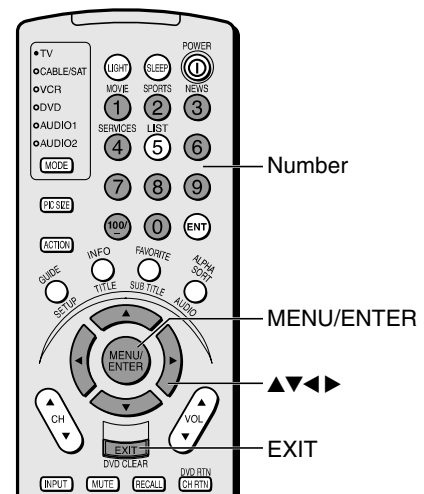

Using the TV's features

Adjusting the channel settings

Switching between two channels

You can switch between two channels without entering an actual channel number each time.

To switch between two channels:

1. Select the first channel or video mode you want to view.
2. Select a second channel with the Channel Number buttons (0-9, 100).
3. Press CH RTN. The previous channel will be displayed.

Each time you press CH RTN, the TV will switch back and forth between the two channels.

Programming your favorite channels

You can preset up to 9 of your favorite channels each for FAVORITE CH1 and FAVORITE CH2 modes using the Favorite Channel Programming feature. Because this feature scans through only your favorite channels, it allows you to skip other channels you do not normally watch.

To program your favorite channels:

1. Press MENU, and then press ◀ or ▶ until the CUSTOM menu appears.
2. Press ▲ or ▼ to highlight FAVORITE CH1 or FAVORITE CH2.

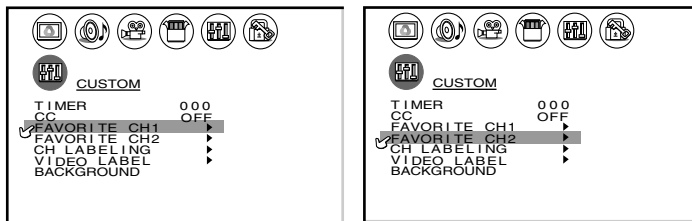

3. Press ◀ or ▶ to display the FAVORITE CH1 menu, for example. CH INPUT will be highlighted.

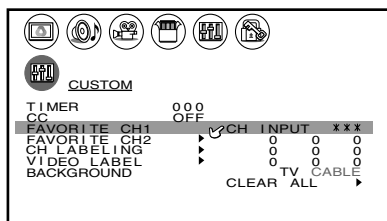

4. Press the Channel Number buttons to enter one of your favorite channels.
5. Press ENTER.
6. Repeat steps 4 and 5 for other channels.

To select your favorite channels:

Press (FAV) ◀ or ▶.

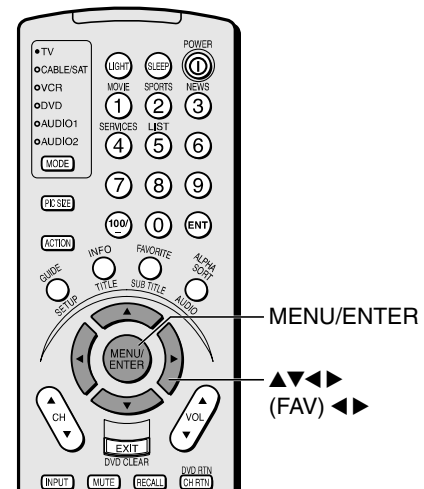
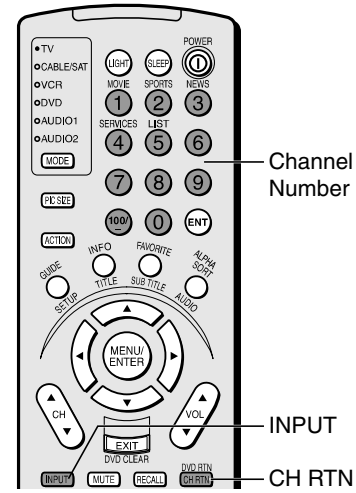

Notes:

- The (FAV) ◀ ▶ buttons operate as menu ◀ ▶ buttons when a menu display is on the screen.
- The favorite channel feature is not available in ANT2 mode.

To quickly scan through your favorite channels in a 9-picture multi-window:

Press FAVORITE (see page 35).

To clear your favorite channels:

1. Press MENU, and then press ◀ or ▶ until the CUSTOM menu appears.
2. Press ▲ or ▼ to highlight FAVORITE CH2, for example.
3. Press ◀ or ▶ to display the FAVORITE CH2 menu.

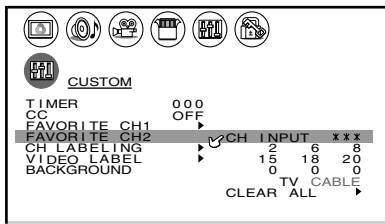

4. Press ▲▼◀▶ to highlight the channel you want to clear, then press ENTER.

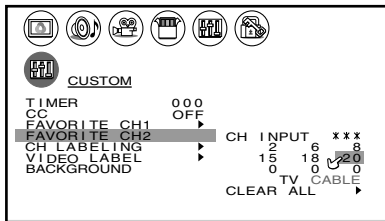

5. Repeat step 4 for other channels.
6. Otherwise, press ▲ or ▼ to highlight CLEAR ALL, then press ▶ or ◀, to clear all favorite channels at once.

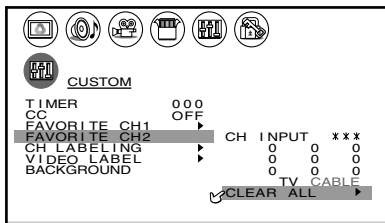

Labeling channels

Channel labels appear above the on-screen channel number display each time you turn on the TV, change the channel, or press RECALL. You can choose any four characters to identify a channel.

To create channel labels:

1. Press MENU, and then press ◀ or ▶ until the CUSTOM menu appears.
2. Press ▲ or ▼ to highlight CH LABELING.
3. Press ◀ or ▶ to display the CH LABELING menu.
CH INPUT will be highlighted.

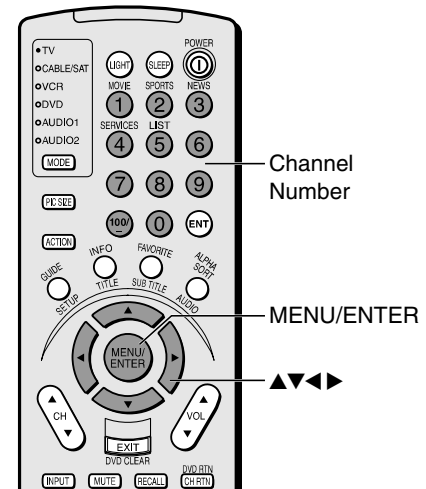
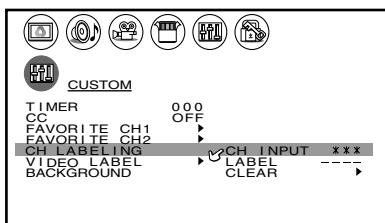

- Press the Channel Number buttons to select a channel you want to label.

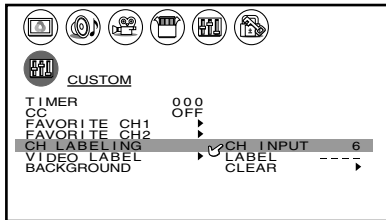

- Press ▼ to highlight LABEL.
- Press ◀ or ▶ repeatedly to select a character for the first space, and then press ENTER.

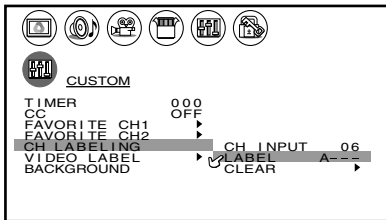

- Repeat step 6 to enter the rest of the characters. If you would like a blank space in the label name, you must choose an empty space from the list of characters. Otherwise, a dash “-” will appear in that space.
- Repeat steps 4–6 for other channels. You can assign labels to a maximum of 32 channels.

To erase channel labels:

- Press MENU, and then press ◀ or ▶ until the CUSTOM menu appears.
- Press ▲ or ▼ to highlight CH LABELING.
- Press ◀ or ▶ to display the CH LABELING menu.
- Press ▼ to highlight CH INPUT, then select the channel you want to clear with the Channel Number buttons.
- Press ▼ to highlight CLEAR.

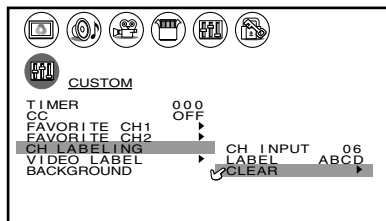

- Press ◀ or ▶ to erase the channel label.
- Repeat steps 4–6 to erase other channel labels.

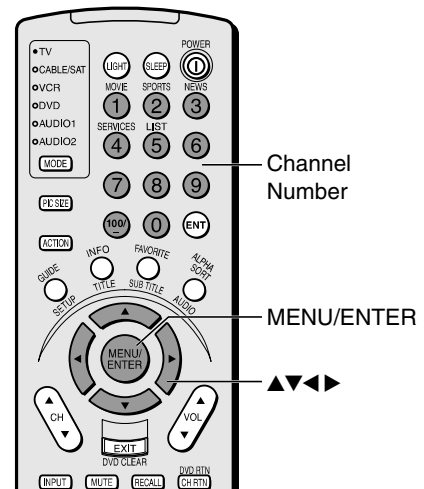

Viewing the wide-screen picture formats

You can view programs that have the conventional TV picture format (4:3 aspect ratio) and the wide-screen format (16:9 aspect ratio) in a variety of picture sizes.

Selecting the picture size

Repeatedly press PIC SIZE to select either Normal, Theater Wide 1, Theater Wide 2, Theater Wide 3, or Full picture size, as described below.

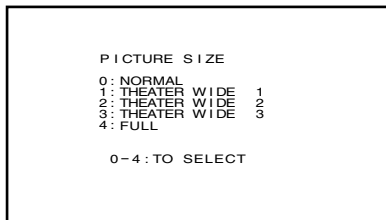

While the above menu is on the screen, you can select the desired picture size by pressing the corresponding number button (0–4).

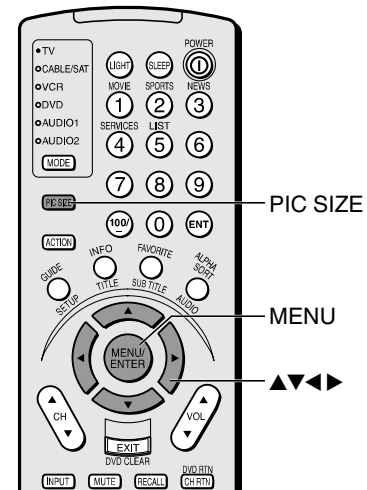

Normal

The Normal picture size displays the picture in the conventional 4:3 aspect ratio, with bars at the left and right.

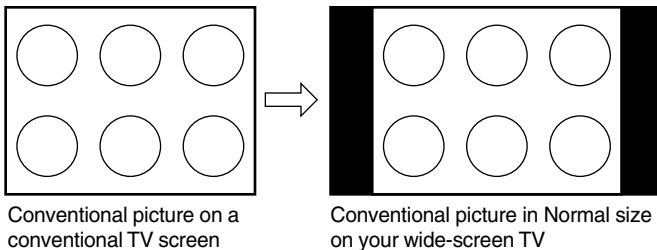

Theater Wide 1, 2, 3

The Theater Wide picture size enlarges the picture to fill the screen (see note at right).

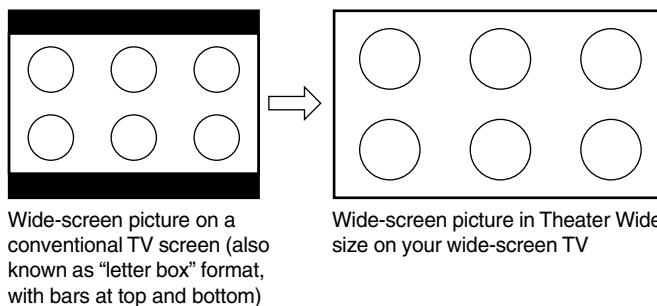

Note:

If you select Theater Wide 2 or 3 for conventional size programs, the top and bottom edges of the picture may be hidden. To see the hidden edges, either scroll the picture (see page 33) or select Theater Wide 1, which displays all of the picture (see page 32).

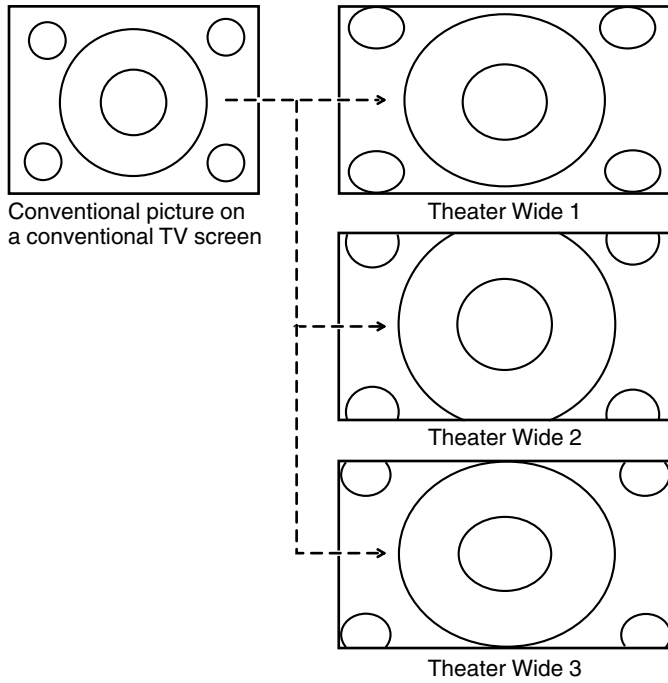

Theater Wide 1 (recommended mode):

- The picture is non-uniformly enlarged—the center of the picture remains close to its true proportion, but the left and right edges are stretched wider to fill the screen.
- None of the picture is hidden.

Theater Wide 2:

- The entire picture is uniformly enlarged—it is stretched the same amount both wider and taller (retains its true proportion).
- Part of the picture at the top and bottom is hidden. To view the hidden areas, see “Scrolling the Theater Wide picture” on page 33.

Theater Wide 3:

- The picture is non-uniformly enlarged—it is stretched wider to fill the width of the screen, but only slightly stretched taller.
- A small part of the picture at the top and bottom is hidden. To view the hidden areas, see “Scrolling the Theater Wide picture” on page 33.

Full

Full picture size stretches the picture to fill the screen width (distorts the picture).

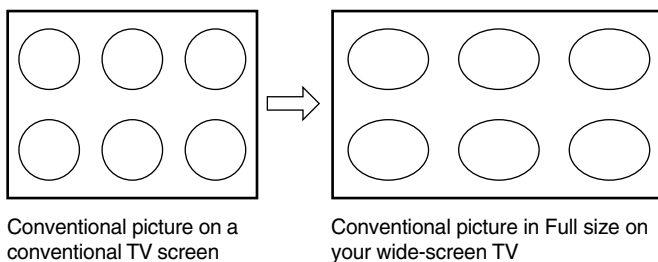

Scrolling the Theater Wide picture (Theater Wide 2 and 3 only)

1. Press PIC SIZE to select the Theater Wide 2 or 3 mode.
2. Press MENU, and then press ◀ or ▶ until THEATER menu appears.
3. Press ▲ or ▼ to highlight PICTURE SCROLL.

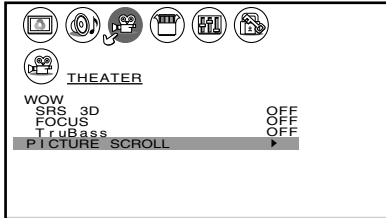

4. Press ◀ or ▶ to display the Scroll Adjustment mode.

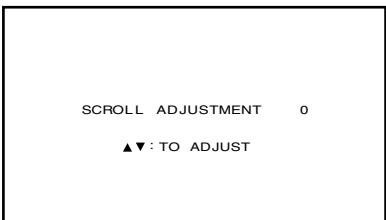

5. Press ▲ or ▼ to adjust the vertical position of the picture.

- Normal (center) position

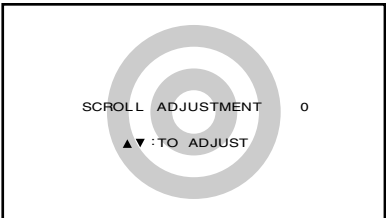

- To raise the picture, press ▲.

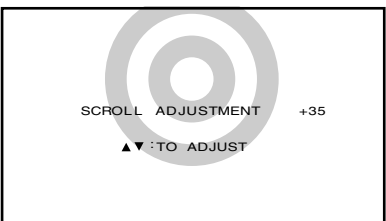

- To lower the picture, press ▼.

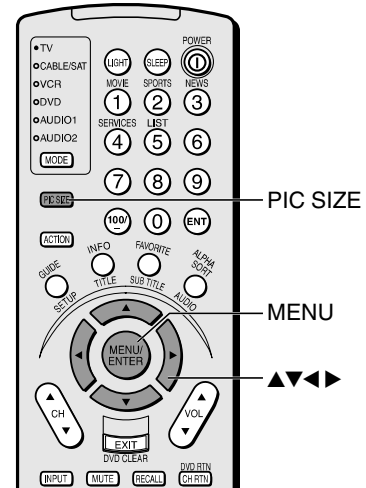
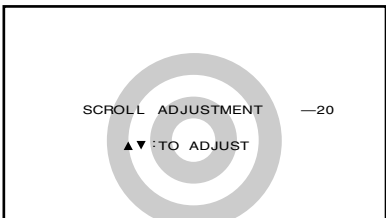

Note:

You can scroll the picture in Theater Wide 2 and Theater Wide 3 only. The scroll amounts are as follows:

- 480i signal source:
 - Wide 1: Not adjustable
 - Wide 2: +45 to -20
 - Wide 3: +45 to -20
- 480p signal source:
 - Wide 1: Not adjustable
 - Wide 2: +30 to -20
 - Wide 3: +30 to -20

Using the POP double-window feature

The POP (picture-out-picture) feature splits the screen into a double window that allows you to watch two programs at the same time. The POP program can come from a TV broadcast or an external source, such as a VCR.

To display a TV broadcast in the POP window:

1. Press PIP to display the POP window.

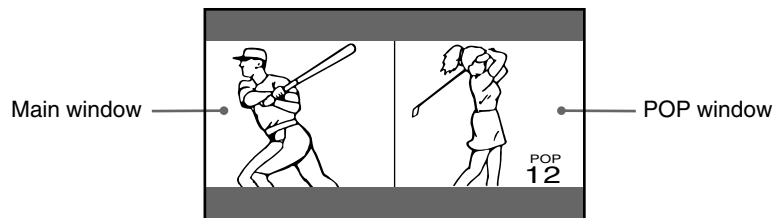

2. Press PIP CH ▲▼ to change the channel of the POP window. If the V-CHIP feature is active and you try to watch a TV program that exceeds your set rating limits, the program will be blocked (see “Using the V-CHIP menu” on page 37).

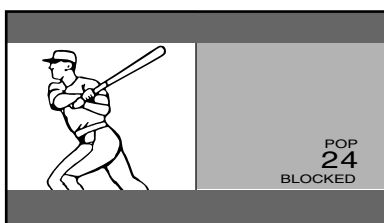

To display a picture from an external source in the POP window:

1. Connect the external source equipment (see “Connecting your TV” on page 5).
2. Select the TV program you want to watch in the main window.
3. Press PIP to display the POP window.
4. Repeatedly press SOURCE to select the input source for the POP window (VIDEO 1, VIDEO 2, or VIDEO 3 only; you cannot select ColorStream in POP mode). The current source will display in purple.
5. You can play a tape as the POP picture, or select a channel for the POP window using the VCR's channel keys.

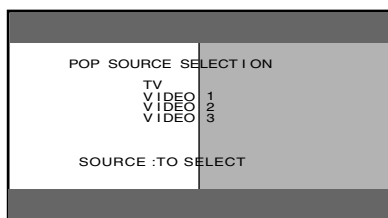

To close the POP window:

Press PIP again.

Note:

- The PIP buttons on the remote control operate the TV's POP features.
- You cannot access POP features when viewing ColorStream HD1 or HD2 input.
- You cannot display the ANT-2 signal source in the POP window.
- You can choose to hear the sound of either the main or POP program (see “Selecting the Audio OUT sound” on page 52).

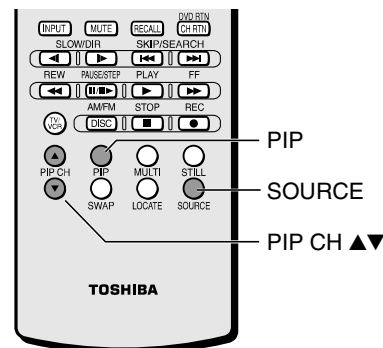

Switching the main and POP pictures

Press SWAP while you are using the POP feature to switch the main and POP pictures.

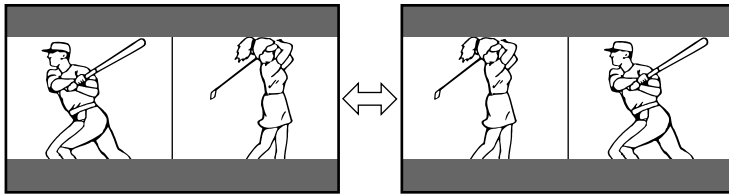

Freezing the POP picture

Press STILL while you are using the POP feature. The POP picture will become a still picture. To return to the moving picture, press STILL again.

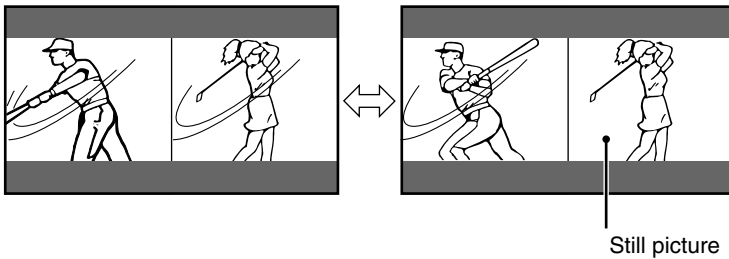

Using the favorite channel search function

You can use the favorite channel search function to quickly scan your favorite channels. (See "Programming your favorite channels" on page 28.)

1. Press FAVORITE.
The TV automatically enters POP mode, and begins a nine-picture scan of your favorite channels in the POP window. The first of the nine windows will display as a moving picture.

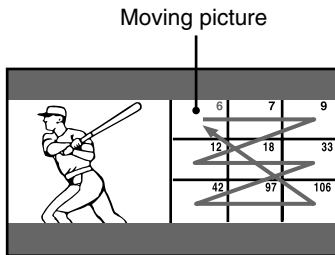

2. Press ▲▼◀▶ to select one of the nine pictures (becomes a moving picture).
3. Press ENTER to display the channel you selected in step 2 as a normal picture.

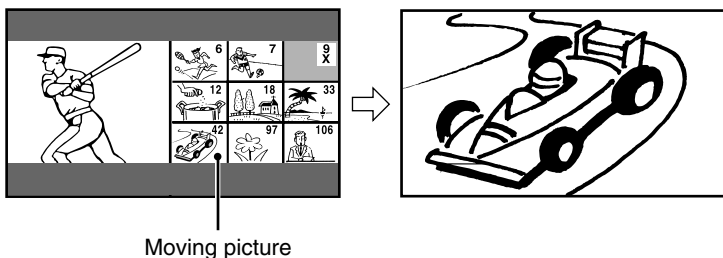

Every time you press FAVORITE, the POP window scans your favorite channels in the following order:

FAVORITE CH1 — FAVORITE CH2 — Off

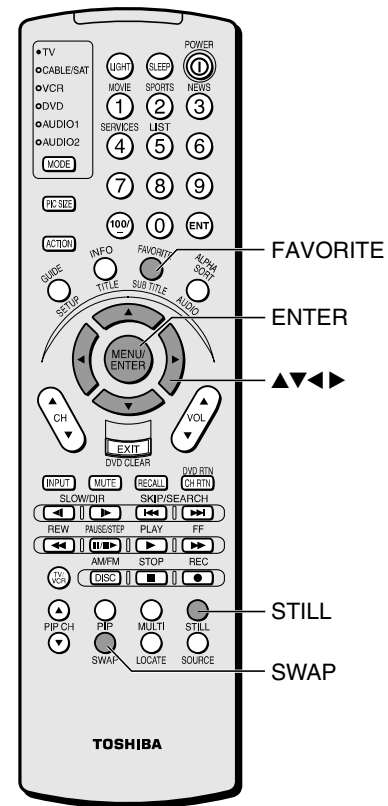

Using the LOCKS menu

The LOCKS menu includes the V-Chip, CH Lock, Video Lock, and New PIN Code functions. You can use these functions after entering the correct PIN code.

Entering the PIN code

1. Press MENU, and then press ◀ or ▶ until the LOCKS menu appears.

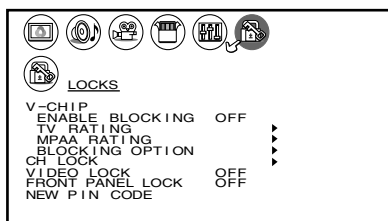

2. Press ▲ or ▼ to display the PIN code entering mode.

- Blocking Reset status: Set your 4-digit code by pressing the Number buttons (0-9), and then press ENTER.
- When the PIN code is already stored: Press the Number buttons (0-9) to enter the 4-digit PIN code used for blocking channels, and then press ENTER.



If the wrong PIN code is entered, the message “Incorrect” appears. Enter the code again, and then press ENTER.

If you cannot remember the PIN code, while in the PIN code entering mode, press the RECALL button four times within five seconds. The PIN code will be released (Blocking Reset status restored).

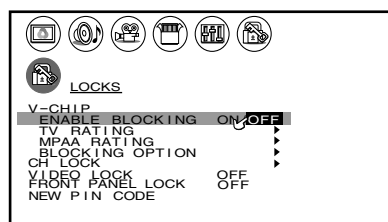

Continue to set each item following the steps on the next page.

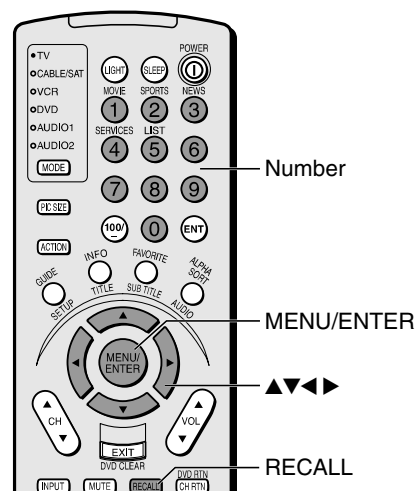

Using the V-CHIP menu

Some TV programs and movies include signals that classify the content of the program (violence, sex, dialog, language). The V-CHIP control feature in this TV detects the signals and blocks the programs according to your selections. To use this feature, perform the following setup.

ENABLE BLOCKING

1. From the LOCKS menu, select ENABLE BLOCKING.
2. Press ◀ or ▶ to select ON or OFF.
ON : To enable your setting (Lock)
OFF: To release your setting (Unlock)

Note: The CH LOCK function is not affected with this selection.

TV RATING (Independent rating system for broadcasters)

1. From the LOCKS menu, select TV RATING.
2. Press ◀ or ▶ to display the TV RATING menu.
3. Press ▼ or ▲ to select item.
4. Press ▶ to lock (display "X")
Press ◀ to unlock (display "✓")
5. Repeat steps 3 and 4 to set the next item.

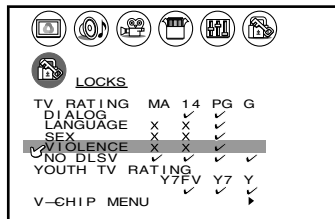

The TV age-based ratings and content themes you can lock are listed in the table below.

Ratings	Description and Content themes
MA	Mature Audience Only (This program is specifically designed to be viewed by adults and therefore may be unsuitable for children under 17.) L) Crude or indecent language S) Explicit sexual activity V) Graphic violence
14	Parents Strongly Cautioned (This program contains some material that many parents would find unsuitable for children under 14 years of age.) D) Intensely suggestive dialog L) Strong, coarse language S) Intense sexual situations V) Intense violence
PG	Parental Guidance Suggested (This program contains material that parents may find unsuitable for younger children.) D) Some suggestive dialog L) Infrequent coarse language S) Some sexual situations V) Moderate violence
G	General Audience (Most parents would find this program suitable for all ages.)
Y7, Y7FV	Directed to Older Children (This program is designed for children age 7 and above. Note: Programs in which fantasy violence may be more intense or more combative than other programs in this category are designated Y7FV.)
Y	All Children (This program is designed to be appropriate for all children)

LOCKS menu

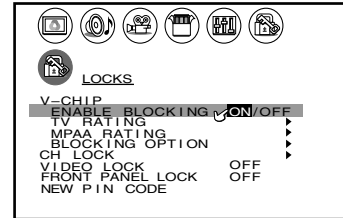

To select each item:

Press ▼ or ▲.



Press RECALL to display the rating of the TV program you are currently watching.

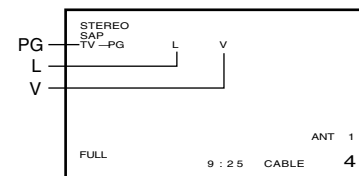

MPAA RATING (Independent rating system for movies)

1. From the LOCKS menu, select MPAA RATING.
2. Press ◀ or ▶ to display the MPAA RATING menu, then press ▼ or ▲ to highlight MPAA RATING.
3. Press ◀ or ▶ to display the MPAA RATING menu.

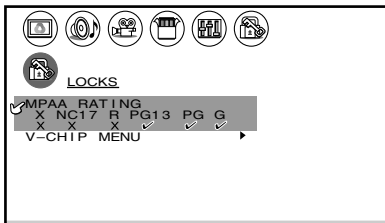

4. Press ▶ to lock (“X”) or press ◀ to unlock (“✓”).

The movie ratings you can lock are described as follows:

- X : X-rated (For adults only)
- NC17: Not intended for anyone 17 and under
- R : Restricted (Under 17 requires accompanying parent or adult guardian.)
- PG13 : Parents Strongly Cautioned (Some material may be inappropriate for children under 13)
- PG : Parental Guidance Suggested (Some material may not be suitable for children)
- G : General Audience (Appropriate for all ages)

BLOCKING OPTION

1. From the LOCKS menu, select BLOCKING OPTION.
2. Press ◀ or ▶ to display the BLOCKING OPTION menu, then press ▲ or ▼ to select item.

MPAA UNRATED:

Press ◀ or ▶ to select ON (Lock) or OFF (Unlock) for unrated programs in the MPAA rating system.

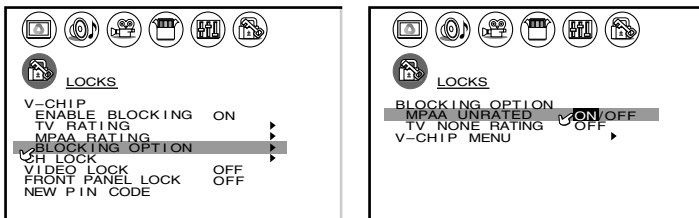

TV NONE RATING

Press ◀ or ▶ to select ON (Lock) or OFF (Unlock) for programs rated NONE in the TV PARENTAL GUIDELINES.

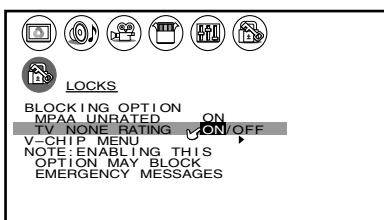

V-CHIP MENU:

Press ◀ or ▶ to return to the LOCKS menu.

LOCKS menu

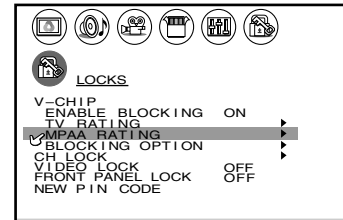

To select each item:

Press ▼ or ▲.

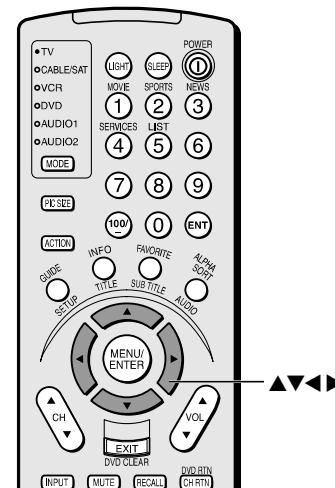

Caution

Setting the TV None Rating to ON may block the broadcast of emergency information. The menu will display the note, “Enabling this option may block emergency messages” to warn you of this possibility.

Unlocking programs temporarily

1. If you try to watch a TV program that exceeds the rating limits you set, the TV enters program lock mode. After 4 seconds, the TV starts the favorite channel search function (see page 35). You can either unlock the program temporarily (see steps 2–4) or select a non-locked program to watch.

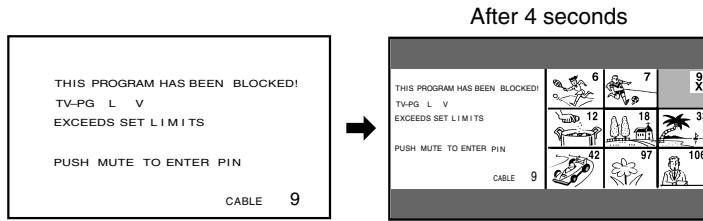

2. To temporarily unlock the program, press MUTE.
3. Press the Number buttons (0-9) to enter your 4-digit PIN code.

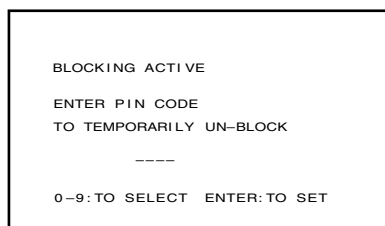

4. Press ENTER.

If the correct code is entered, the program lock mode is released and the normal picture appears.

All locking is disabled until the TV is turned off, and will be enabled when the TV is turned on again.

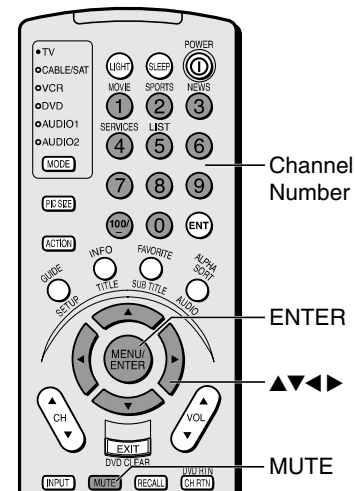

Locking channels

With the CH LOCK feature, you can lock specific channels. The TV will not be able to tune locked channels with the Channel \blacktriangle \blacktriangledown buttons or Channel Number buttons, unless you clear the setting.

You can lock a maximum of nine channels.

To lock channels:

1. From the LOCKS menu, select CH LOCK. CH INPUT will be highlighted.
2. Press \blacktriangleleft or \blacktriangleright to display the CH LOCK menu.
3. Press the Channel Number buttons to enter the channel you want to lock. (The channel you are currently watching cannot be locked.)
4. Press ENTER.

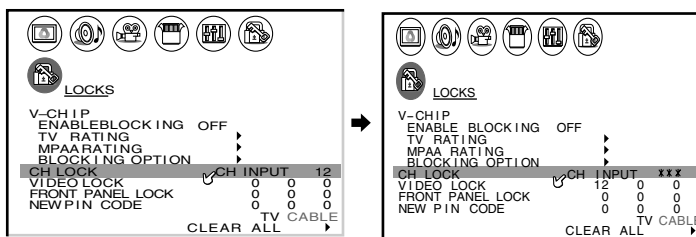

5. Repeat steps 3 and 4 for other channels.

LOCKS menu

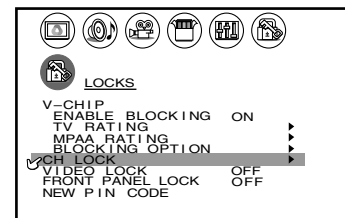

To select each item:

Press \blacktriangledown or \blacktriangle .

To unlock channels:

1. From the LOCKS menu, select CH LOCK.
2. Press ◀ or ▶ to display the CH LOCK menu.
3. Press ▲▼◀▶ to highlight the channel you want to unlock, then press ENTER.

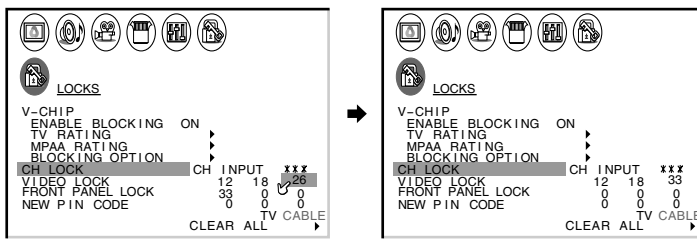

4. Repeat step 3 for other channels.
5. Otherwise, to clear all locked channels at once, press ▲ or ▼ to highlight CLEAR ALL, then press ▶ or ◀.

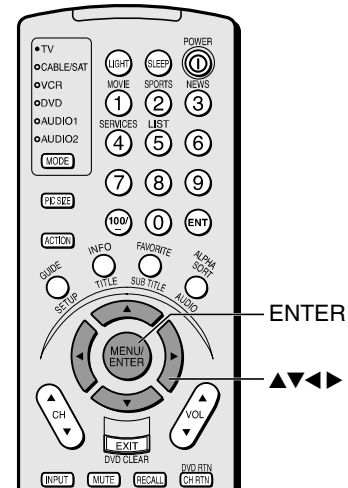
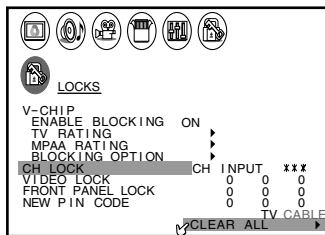

Locking video inputs

With the VIDEO LOCK feature, you can lock out the input sources (Video 1, Video 2, Video 3, ColorStream HD1, ColorStream HD2) and channels 3 and 4.

You will not be able to select the input sources with the TV/VIDEO button or Channel buttons unless you clear the setting.

To set up the video lock:

1. From the LOCKS menu, select VIDEO LOCK.
2. Press ◀ or ▶ to highlight the level of video locking you want (Video, Video+, or Off), as follows:
 - VIDEO : Locks Video 1, Video 2, Video 3, ColorStream HD1 and HD2.
 - VIDEO+ : Locks Video 1, Video 2, Video 3, ColorStream, HD1/HD2, and channels 3 and 4. This option should be used if you use the antenna terminal to play a video tape.
 - OFF : Unlocks all video input sources.

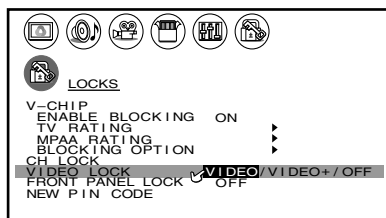

Using the front panel lock feature

Lock the front panel buttons to prevent the buttons from being pressed accidentally (by children, for example). When the front panel lock is in ON mode, all control buttons on the TV front panel (except POWER) do not operate.

To lock the front panel:

1. From the LOCKS menu, select FRONT PANEL LOCK.
2. Press ◀ or ▶ to highlight ON.

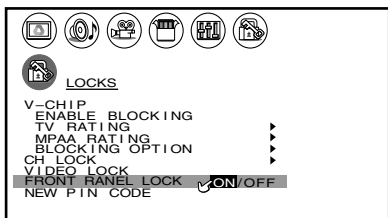

If a button on the front panel is pressed, the message “Not Available” appears.

To unlock the front panel:

Highlight OFF in step 2 above.

Changing the PIN code

1. From the LOCKS menu, select NEW PIN CODE.
2. Press the Number buttons (0-9) to enter a 4-digit code. The numbers you enter will replace the dashes in the display.

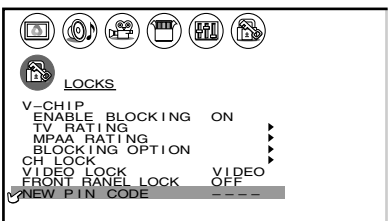

3. Press ENTER. The new PIN code is now active.

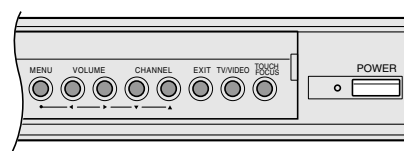

Buttons to be locked

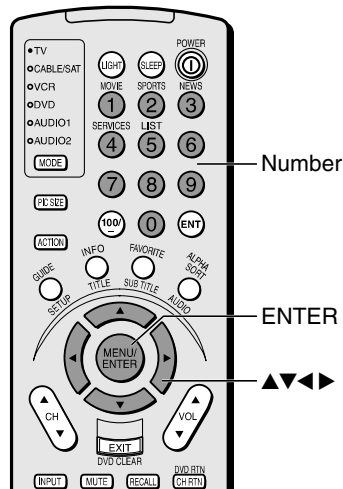

Adjusting the picture

Selecting the picture mode

You can select from four picture modes: Sports, Standard, Movie, and Preference.

Mode	Picture Quality
Sports	Bright and dynamic picture (factory setting)
Standard	Standard picture setting (factory setting)
Movie	Movie-like picture setting (factory setting)
Preference	Your personal preferences*

*(see "Saving new preference" on page 43.)

To select the picture mode:

1. Press MENU, and then press ◀ or ▶ until the PICTURE menu appears.
2. Press ▼ or ▲ to select MODE.
3. Press ◀ or ▶ to highlight the mode you prefer.

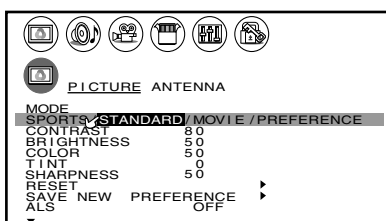

Note:

If you select one of the factory-set picture modes (SPORTS, STANDARDS, or MOVIE) and then change a picture quality setting (for example, increase the contrast), the picture mode automatically changes to PREFERENCE in the Picture menu.

To save your new picture quality settings, you must select SAVE NEW PREFERENCE (see page 43) before closing the Picture menu or the TV will return to the previous picture mode.

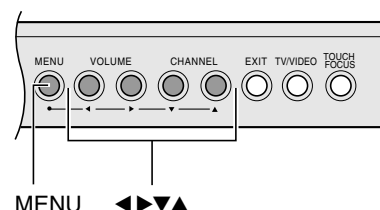

Adjusting the picture quality

You can adjust the picture quality to your personal preferences, including the contrast, brightness, color, tint, sharpness, flesh tone, noise reduction and color temperature.

Selection	◀ Pressing ▶	
contrast	lower	higher
brightness	darker	lighter
color	paler	deeper
tint	reddish	greenish
sharpness	softer	sharper

To adjust the picture quality:

1. Press MENU, and then press ◀ or ▶ until the PICTURE menu appears.
2. Press ▼ or ▲ until the item you want to adjust is highlighted.
3. Press ◀ or ▶ to adjust the level.

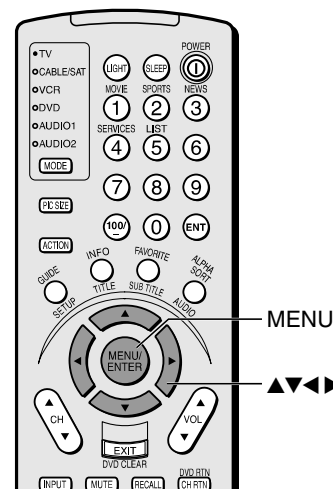
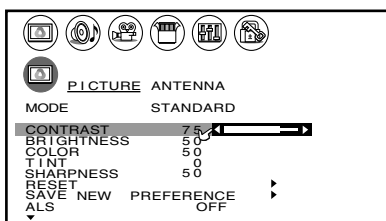

The PICTURE qualities you adjusted can be saved in the TV's memory with the SAVE NEW PREFERENCE feature (see page 43). You can keep these settings or choose factory set options, as described under "Selecting the picture mode" above.

Saving new preference

You can save the PICTURE qualities (contrast, brightness, color, tint, and sharpness) you adjusted in the picture preference mode.

To save your new preferences:

1. Press MENU, and then press ◀ or ▶ until the PICTURE menu appears.
2. Press ▲ or ▼ to highlight SAVE NEW PREFERENCE.
3. Press ◀ or ▶. When complete, the menu displays “DONE.”

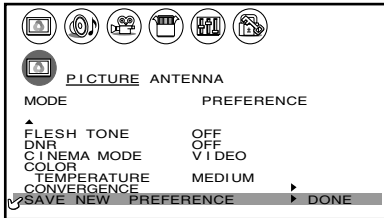

You can choose your saved preferences by selecting PREFERENCE (see “Selecting the picture mode” on page 42).

Using the ALS (Automatic Light Sensor) feature

ALS senses the room ambient light and automatically adjusts the picture contrast for varying light conditions. ALS is energized when the ALS menu is set to ON.

To activate the ALS:

1. Press MENU, and then press ◀ or ▶ until the PICTURE menu appears.
2. Press ▲ or ▼ to highlight ALS.
3. Press ◀ or ▶ to highlight ON.

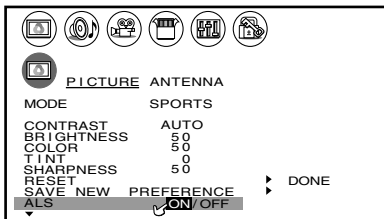

To deactivate the ALS:

Highlight OFF in step 3 above.

Using the flesh tone feature

This feature displays natural flesh tones by correcting the tint.

To turn on the flesh tone feature:

1. Press MENU, and then press ◀ or ▶ until the PICTURE menu appears.
2. Press ▲ or ▼ to highlight FLESH TONE.
3. Press ◀ or ▶ to highlight ON.

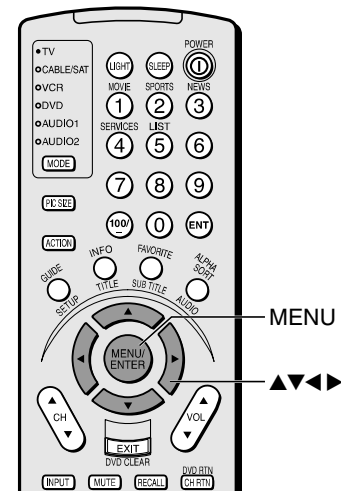
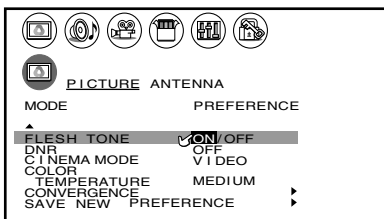

Note:

Do not cover the ALS sensor on the front panel of the TV.

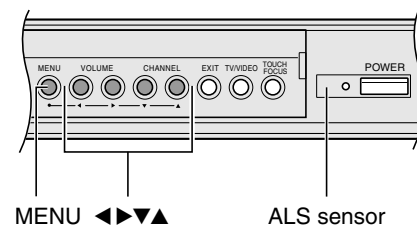

Selecting the cinema mode

When you view a DVD movie (3-2 pulldown processed) from a DVD player connected to the ColorStream (component video) inputs on the TV, smoother and more natural motion can be obtained by setting the CINEMA MODE to FILM (auto).

To select the cinema mode:

1. Press MENU, and then press ◀ or ▶ until the PICTURE menu appears.
2. Press ▲ or ▼ to highlight CINEMA MODE.
3. Press ◀ or ▶ to select FILM (auto) or VIDEO (off).

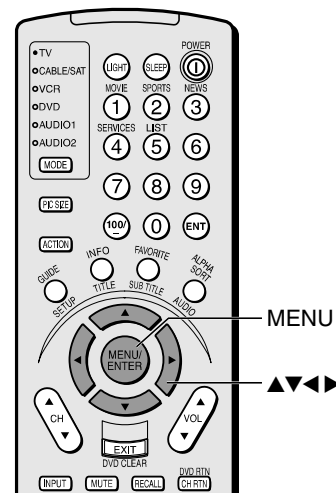
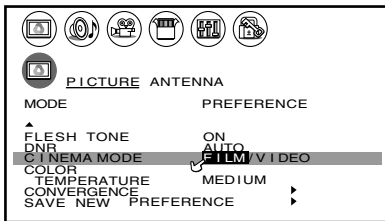

To set the CINEMA MODE to VIDEO (off):

Press ◀ or ▶ to select VIDEO in step 3 above.

Using the Digital Noise Reduction (DNR) feature

This feature allows you to reduce visible interference in your TV picture. This is useful when receiving a broadcast with a weak signal or playing back a video cassette or disc damaged by repeated use.

To turn on the DNR feature:

1. Press MENU, and then press ◀ or ▶ until the PICTURE menu appears.
2. Press ▲ or ▼ to highlight DNR.
3. Press ◀ or ▶ to highlight AUTO.

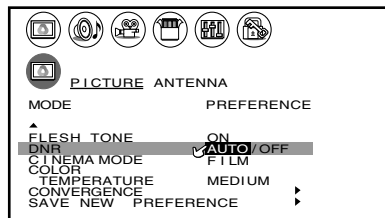

To turn off the DNR feature:

Highlight OFF in step 3 above.

Selecting the color temperature

You can change the quality of the picture by selecting from three preset color temperatures: cool, medium, and warm.

Mode	Picture Quality
cool	blueish
medium	neutral
warm	reddish

To select the color temperature:

1. Press MENU, and then press ◀ or ▶ until the PICTURE menu appears.
2. Press ▲ or ▼ to highlight COLOR TEMPERATURE.
3. Press ◀ or ▶ to highlight the mode you prefer.

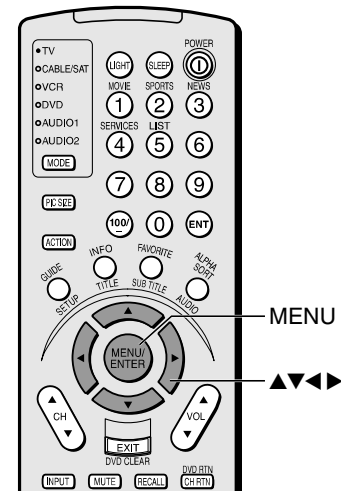
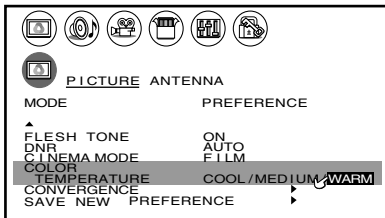

Resetting picture adjustments

The RESET function adjusts the picture qualities to the following factory settings:

Contrast	max (100)	Color temperature	cool
Brightness	center (50)	DNR	auto
Color	center (50)	Mode	sports
Tint	center (0)		
Sharpness	center (50)		

To reset the picture adjustments:

1. Press MENU, and then press ◀ or ▶ until the PICTURE menu appears.
2. Press ▲ or ▼ to highlight RESET.
3. Press ◀ or ▶. The menu displays "DONE".

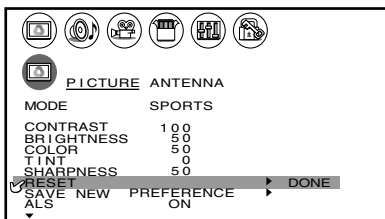

Selecting the video input source

Press **INPUT** on the remote control or **TV/VIDEO** on the TV to view a signal coming from another device connected to your TV, such as a VCR or video disc player (see illustrations below). You can select **ANT 1**, **VIDEO 1**, **VIDEO 2**, **VIDEO 3**, **ColorStream HD1**, **ColorStream HD2**, or **ANT 2** depending on which input jacks are used for connecting the devices (see “Connecting your TV” on page 5.)

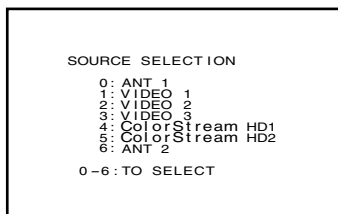

Pressing **INPUT** on the remote control displays the current signal source (press **INPUT** again or 0-6 to change)

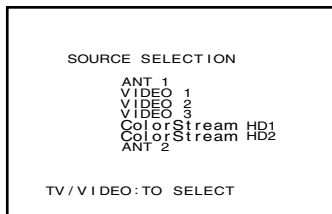

Pressing **TV/VIDEO** on the TV changes the current signal source

Note:

- When **ColorStream HD 1** or **HD 2** is selected, the video **OUT** jack does not output a signal. To receive a video **OUT** signal, use a video or **S-video IN** connection instead of the **ColorStream** connection.
- If you select **ColorStream HD1** or **HD2** while the **POP** picture is active, the **POP** window will close.

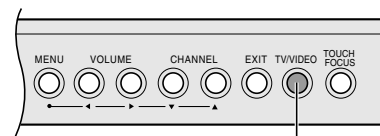

TV/VIDEO

Labeling the video input sources

The video label feature allows you to label each input source for your TV from the following preset list of labels:

- : Uses the default label name
- VCR : Video cassette recorder
- DVD : DVD video
- DTV : Digital TV set-top box
- SAT : Satellite box
- CBL : Cable box

To label the video input sources:

- Press **MENU**, and then press ◀ or ▶ until the **CUSTOM** menu appears.
- Press ▲ or ▼ to highlight **VIDEO LABEL**.

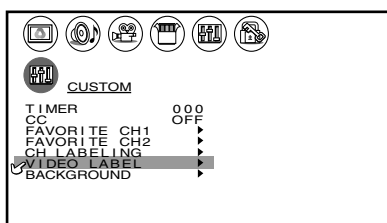

- Press ◀ or ▶ to display the **VIDEO LABEL** menu.
- Press ▲ or ▼ to highlight the video source you want to label.
- Press ◀ or ▶ to select the desired label for that input source.

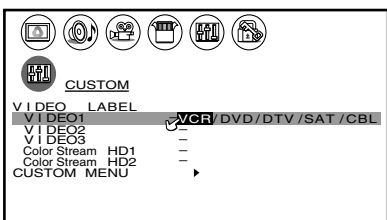

- Finish labeling the other video sources as desired. To return to the previous menu, press ▲ or ▼ to highlight **CUSTOM MENU**, and then press ◀ or ▶.
- To exit the menu, press **EXIT**.

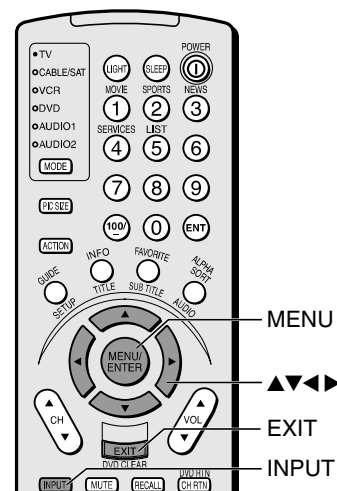

Using the closed caption feature

The closed caption feature has two options:

- Captions—An on-screen display of the dialogue, narration, and sound effects of TV programs and videos that are closed captioned (usually marked as “CC” in TV listings).
- Text—An on-screen display of information not related to the current program, such as weather or stock data (when provided by individual stations).

To view captions or text:

1. Tune the TV to the desired program.
2. Press MENU, and then press ◀ or ▶ until the CUSTOM menu appears.
3. Press ▼ or ▲ to highlight CC.

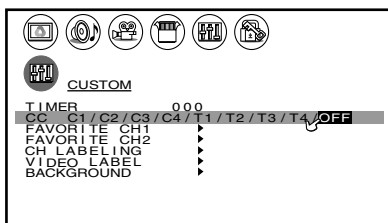

4. Press ◀ or ▶ to highlight the desired closed caption mode, as follows:

- To view captions, highlight C1, C2, C3, or C4 (C1 displays translation of the primary language in your area).

Note: If the program or video you selected is not closed captioned, no captions will display on the screen.



- To view text, highlight T1, T2, T3, or T4.

Note: If text is not available in your area, a black rectangle may appear on your screen. If this happens, turn the Closed Caption feature OFF.

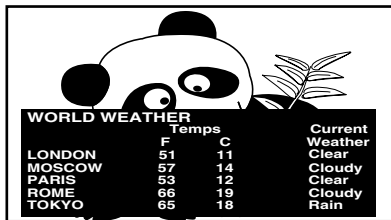

To turn off the Closed Caption feature:

Highlight OFF in step 4.

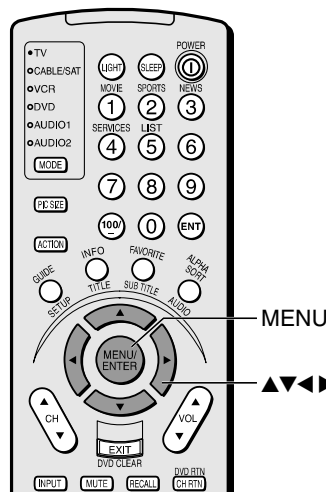

Note:

A closed caption signal may not display in the following situations:

- when a videotape has been dubbed
- when the signal reception is weak
- when the signal reception is nonstandard

Setting the sleep timer

To set the sleep timer to turn the TV off automatically:

1. Press SLEEP to set the length of time until the TV turns off.

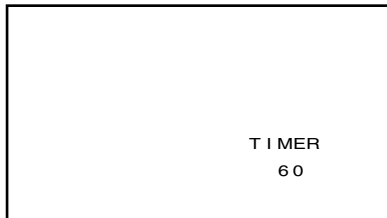

Every time you press the button, the time display will increase by 10 minutes, up to 180 minutes.

10 → 20 → 30 → 40 → 50 → 60 → 70 → 80 → 90 → 100 → 110 → 120 → 130 → 140 → 150 → 160 → 170 → 180 → 0 → 10 MIN.

To cancel the sleep timer:

Press SLEEP until it is set to 0.

The timer can also be set using the on-screen menu:

1. Press MENU, and then press ◀ or ▶ until the SETUP menu appears.
2. Press ▲ or ▼ to highlight TIMER.
3. After the number position starts to blink, press the Number buttons (0-9) to enter the length of time until the TV turns off automatically.
4. Press ENTER to start the timer.

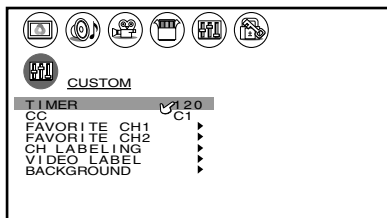

Setting the clock

To set the clock:

1. Press MENU, and then press ◀ or ▶ until the SET UP menu appears.
2. Press ▲ or ▼ to highlight CLOCK SET.
3. After the number position starts to blink, press the Number buttons (0-9) to enter the correct time. The clock operates on a 12-hour cycle.
4. Press ENTER to start the clock.

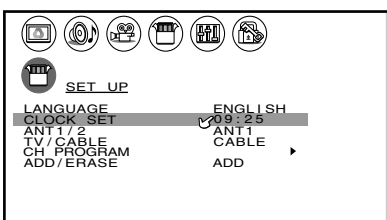

To display the time on-screen:

Press RECALL.

Note :

To display the amount of time left until the TV turns off automatically, press SLEEP once.

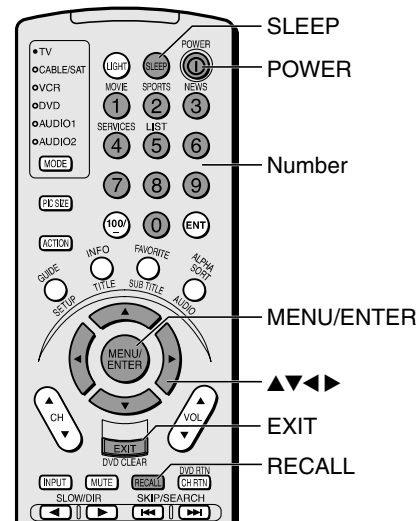

Note :

If the TV's power source is interrupted (the power cord is unplugged or a power failure occurs), the clock must be reset.

Adjusting the sound

Muting the sound

Press MUTE to temporarily turn off the sound. While the sound is off, the screen will display the word “1/2 MUTE” or “MUTE” in the lower right corner. Every time you press the button, the mute mode will change in the following order.

→ Normal → 1/2 MUTE → MUTE →

When you select “MUTE” mode, the closed caption feature is automatically activated. To deactivate this feature, press MUTE again. This feature works only when the closed caption mode is set to OFF. See “Using the closed caption feature” on page 47 for more information.

Selecting stereo/SAP broadcasts

The multi-channel TV sound (MTS) feature allows you to listen to high-fidelity stereo sound while watching TV. MTS can also transmit a second audio program (SAP) containing a second language, music, or other audio information (when provided by individual stations).

When the TV receives a stereo or SAP broadcast, the word STEREO or SAP appears on-screen every time the TV is turned on, the channel is changed, or the RECALL button is pressed.

The MTS feature is not available when the TV is in VIDEO mode.

To listen to stereo sound:

1. Press MENU, and then press ◀ or ▶ until the AUDIO menu appears.
2. Press ▲ or ▼ to highlight MTS.
3. Press ◀ or ▶ to highlight STEREO.

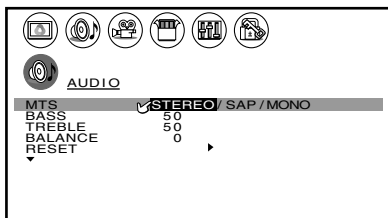

You can leave your TV in STEREO mode because it will automatically output the type of sound being broadcast (stereo or monaural). The word “STEREO” or “SAP” displays in yellow in the menu when the TV receives the signal.

If the stereo sound is noisy, select MONO to reduce the noise.

To listen to SAP (if available):

1. Press MENU, and then press ◀ or ▶ until the AUDIO menu appears.
2. Press ▲ or ▼ to highlight MTS.
3. Press ◀ or ▶ to highlight SAP. You will hear the station's second audio program (if available) from the speakers, while viewing the original program's picture (see note at right).

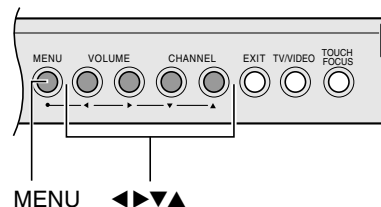
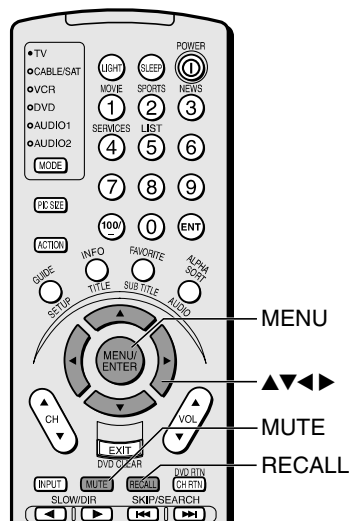

Note :

A second audio program (SAP) can be heard only on those TV stations that offer it.

For example, a station might broadcast music as a second audio program. If you have SAP on, you will see the current program on the screen but hear music instead of the program's normal audio.

However, if you have SAP on, and the station you are watching is not currently broadcasting a second audio program, you will see the picture but not hear any sound. If this happens, put the TV in STEREO mode so you can hear the station's normal audio.

Using the WOW™ surround sound feature

The WOW™ surround sound feature expands the audio listening field wider and deeper to create exceptional sound quality from the TV's speakers. WOW consists of the three features: SRS 3D, FOCUS and TruBass, being turned on. The feature uses stereo signals from a TV broadcast or video input.

To adjust the WOW feature:

1. Select STEREO mode (see “Selecting stereo/SAP broadcasts” on page 49).
2. Press MENU, and then press ◀ or ▶ until the THEATER menu appears.
3. Press ▲ or ▼ to highlight the desired WOW feature you want to adjust, then press ◀ or ▶ to adjust the item.

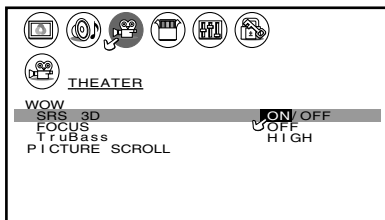

- SRS 3D — To turn on or off the surround sound effect.
- FOCUS — To turn on or off the vocal emphasis effect.
- TruBass — To select your desired bass expansion level from among HIGH, LOW or OFF.

Adjusting the sound quality

You can change the quality of your TV's sound by adjusting the bass, treble, and balance.

To adjust the sound quality:

1. Press MENU, and then press ◀ or ▶ until the AUDIO menu appears.
2. Press ▲ or ▼ to highlight the item you want to adjust.

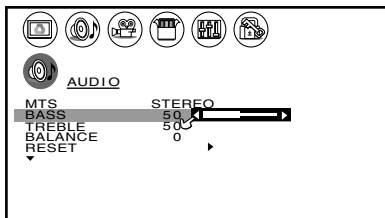

3. Press ◀ or ▶ to adjust the level.
 - ◀ makes the sound quality weaker or decreases the balance in the right channel, depending on the item selected.
 - ▶ makes the sound quality stronger or decreases the balance in the left channel, depending on the item selected.

Note:

If the broadcast is monaural, the SRS 3D effect does not work.

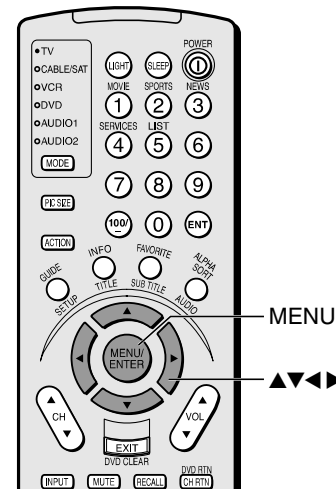

Resetting audio adjustments

The RESET function returns the audio adjustments to the following factory settings:

- Bass center (50)
- Treble center (50)
- Balance center (0)

To reset the audio adjustments:

1. Press MENU, and then press ◀ or ▶ until the AUDIO menu appears.
2. Press ▲ or ▼ to highlight RESET.
3. Press ◀ or ▶. The menu displays "DONE".

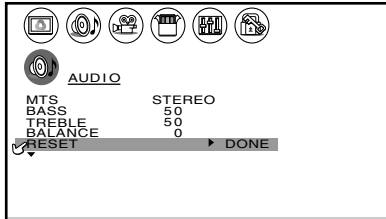

Using the sub-bass system (SBS)

The sub-bass system allows you to enhance bass performance, even when the sound volume is low.

To turn on the SBS:

1. Press MENU, and then press ◀ or ▶ until the AUDIO menu appears.
2. Press ▲ or ▼ to highlight SBS.
3. Press ◀ or ▶ to highlight ON.

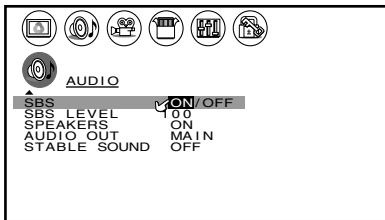

To adjust the SBS level:

4. Press ▲ or ▼ to highlight SBS LEVEL.
5. Press ◀ or ▶ to adjust the SBS level.

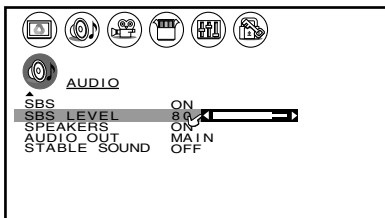

To turn off the SBS:

Highlight OFF in step 3 above.

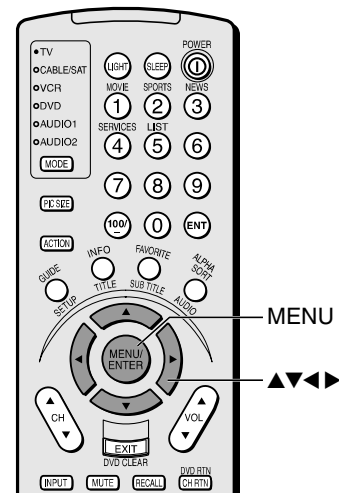

Note:

The SBS signal does not pass through the "Variable Audio OUT" jacks (see "Connecting an audio system" on page 11); however, the AUDIO menu will appear when the buttons are pressed.

Turning off the built-in speakers

Use this feature to turn the TV speakers off when you connect an audio system (see “Connecting an audio system” on page 11).

To turn off the built-in speakers:

1. Press MENU, then press ◀ or ▶ until AUDIO menu appears.
2. Press ▲ or ▼ to highlight SPEAKERS.
3. Press ◀ or ▶ to highlight OFF.

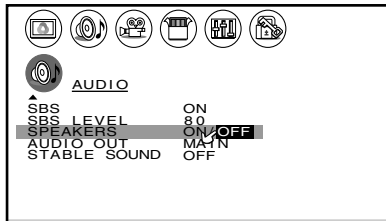

To turn on the built-in speakers:

Highlight ON in step 3 above.

Selecting the Audio OUT sound

This feature allows you to select the sound source (MAIN or POP) that is output from the Audio OUT jacks.

This is useful when amplifying or recording the POP sound with external equipment while hearing the sound of the main picture through the built-in speakers.

To select the Audio OUT sound:

1. Press MENU, and then press ◀ or ▶ until the AUDIO menu appears.
2. Press ▲ or ▼ to highlight AUDIO OUT.
3. Press ◀ or ▶ to select MAIN or POP.

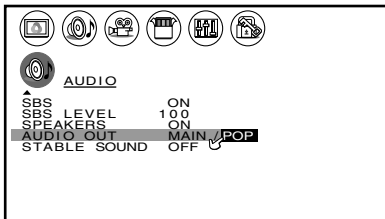

- MAIN : Outputs the sound of the main program.
- POP : Outputs the sound of the POP program.

Note:

Make sure the volume control of your audio amplifier is set to a moderate listening level.

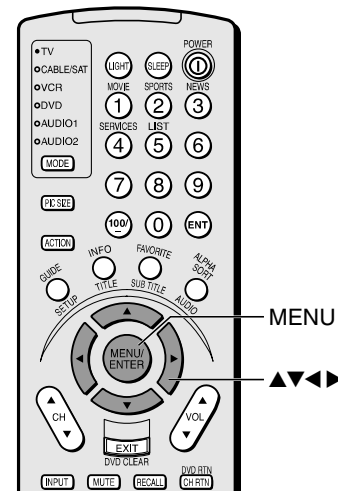

Using the StableSound™ feature

When the signal source is changed, the stable sound feature limits the high volume level to prevent extreme changes in volume (for example, to prevent the sudden increase in volume that often happens when a TV program switches to a commercial).

To turn on the StableSound feature:

1. Press MENU, and then press ◀ or ▶ until the AUDIO menu appears.
2. Press ▲ or ▼ to highlight STABLE SOUND.
3. Press ◀ or ▶ to select ON.

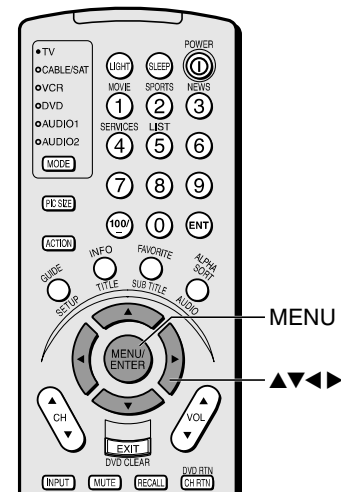
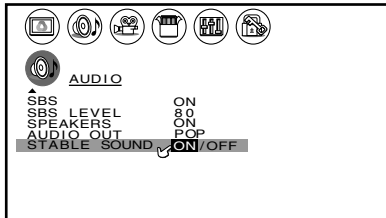

Selecting the background of the menu display

You can change the background of the menu display by selecting from two preset types: shaded and solid (gray).

To select the background:

1. Press MENU, and then press ◀ or ▶ until the CUSTOM menu appears.
2. Press ▲ or ▼ to highlight BACKGROUND.
3. Press ◀ or ▶ to select either a SHADED or SOLID background.

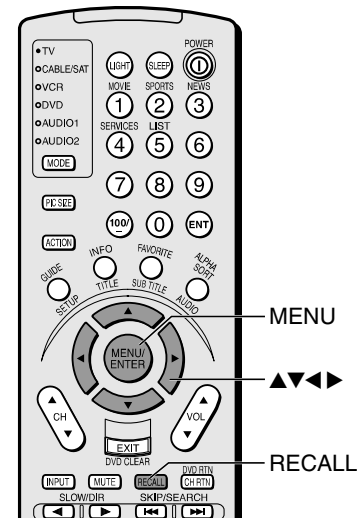
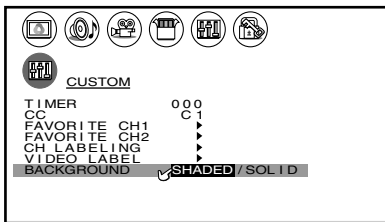

Displaying on-screen information

Press RECALL to display the following information on-screen:

- Antenna mode (when in TV mode)
- Channel number or VIDEO mode selected
- Time (if set)
- Channel label (if set)
- Stereo or SAP audio status
- V-CHIP rating status
- Picture size

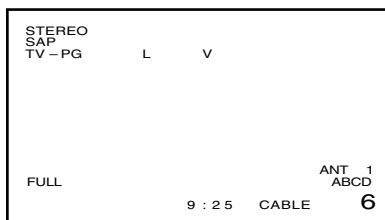

Viewing the demonstration mode

The demonstration mode is an option available in the MENU button on the TV front panel that will demonstrate several of your TV's features.

To start the demo:

Press and hold MENU on the TV for 4 seconds.

To stop the demo:

Press RECALL, EXIT, or POWER.

Understanding the auto power off feature

The TV will automatically turn itself off after approximately 15 minutes if it is tuned to a vacant channel or a station that completes its broadcast for the day. This feature does not work in VIDEO mode.

Understanding the last mode memory feature

If the power is cut off while you are viewing the TV, the Last Mode Memory feature turns the TV on automatically when the power is resupplied.

If the power is going to be off for a long time and you are going to be away from your TV, unplug the power cord to prevent the TV from turning on in your absence.

Appendix

Specifications

Television System

NTSC standard

Channel Coverage

VHF: 2 through 13

UHF: 14 through 69

Cable TV: Mid band (A-8 through A-1, A through I)

Super band (J through W)

Hyper band (AA through ZZ, AAA, BBB)

Ultra band (65 through 94, 100 through 125)

Power Source

120 V AC, 60 Hz

Power Consumption

188 W

Audio Power

15 W + 15 W

Speaker Type

Two 6-5/16 inch (16 cm) round

Two 50x50, 15 W tweeters

Video/Audio Terminals

S-VIDEO INPUT

Y : 1 V(p-p), 75 ohm, negative sync.

C : 0.286 V(p-p) (burst signal), 75 ohm

VIDEO/AUDIO INPUT

VIDEO: 1 V(p-p), 75 ohm, negative sync.

AUDIO: 150 mV(rms) (30% modulation equivalent, 47 kohm)

ColorStream™ (component video) INPUT

Y : 1V(p-p), 75 ohm

PR: 0.7 V(p-p), 75 ohm

PB: 0.7 V(p-p), 75 ohm

AUDIO: 150 mV(rms), 47 kohm

VIDEO/AUDIO OUTPUT

VIDEO: 1 V(p-p), 75 ohm, negative sync.

AUDIO: 150 mV(rms) (30% modulation equivalent, 4.7 kohm)

VARIABLE AUDIO OUTPUT

0–300 mV(rms) (30% modulation equivalent, 4.7 kohm)

AUDIO CENTER CHANNEL INPUT

300 mV(rms) (30% modulation equivalent, 10 kohm)

Dimensions

50HX81: Width 46-3/16 inches (1173 mm)

Height 50-3/8 inches (1279 mm)

Depth 21-7/8 inches (556 mm)

57HX81: Width 52-3/16 inches (1325 mm)

Height 55-3/4 inches (1415 mm)

Depth 26 inches (670 mm)

65HX81: Width 59-1/2 inches (1507 mm)

Height 61 inches (1547 mm)

Depth 28-3/8 inches (730 mm)

Mass

50HX81: 198 lbs (89.8 kg)

57HX81: 240 lbs (109 kg)

65HX81: 278 lbs (126 kg)

Supplied Accessories

Remote Control with 2 size “AA” alkaline batteries

Design and specifications are subject to change without notice.

Troubleshooting

Before calling a service technician, please check the following table for a possible cause of the problem and some solutions.

Problem	Solution
TV will not turn on	<ul style="list-style-type: none">• Make sure the power cord is plugged in, then press POWER.• The remote control batteries may be dead. Replace the batteries.
No picture, no sound	<ul style="list-style-type: none">• Check the antenna/cable connections.
No sound, picture OK	<ul style="list-style-type: none">• The sound may be muted. Press VOLUME.• The station may have broadcast difficulties. Try another channel.• Check that the SPEAKERS function in AUDIO menu is set properly.
Poor picture, sound OK	<ul style="list-style-type: none">• Check the antenna connections.• The station may have broadcast difficulties. Try another channel.• Adjust the PICTURE menu.
Poor reception of broadcast channels	<ul style="list-style-type: none">• The station may have broadcast difficulties. Try another channel.• Check the antenna connections.• If you are using a VCR, make sure the TV/VCR button is set correctly.
Cannot receive above channel 13	<ul style="list-style-type: none">• Make sure the TV/CABLE switch is set to the mode that corresponds with the signal source type (cable company or outside antenna).
Black box appears on the screen	<ul style="list-style-type: none">• The closed caption feature may be set to one of the Text modes (T1, T2, T3, or T4). Turn closed captioning OFF.
Unable to select a certain channel	<ul style="list-style-type: none">• The channel may be locked out with the CH LOCK feature, or erased with the ADD/ERASE feature.
Multiple images	<ul style="list-style-type: none">• The station may have broadcast difficulties. Try another channel.• Antenna reception may be poor. Use a highly directional outdoor antenna.
Poor color or no color	<ul style="list-style-type: none">• The station may have broadcast difficulties. Try another channel.• Adjust the TINT and/or COLOR in the PICTURE menu.
No stereo or SAP sound from a known MTS broadcast	<ul style="list-style-type: none">• Make sure the MTS feature is set properly.
The front panel buttons do not operate	<ul style="list-style-type: none">• Check the FRONT PANEL LOCK feature.
The remote control does not operate	<ul style="list-style-type: none">• Check whether the appropriate device mode is selected.• Remove all obstructions between the remote control and the remote control sensor in the TV.• The remote control batteries may be dead. Replace the batteries.
Cannot access signal input sources (Video1, Video2, Video3, ColorStream HD1/HD2) and/or Channels 3 and 4.	<ul style="list-style-type: none">• Check the VIDEO LOCK feature.

Limited United States Warranty

Toshiba America Consumer Products, Inc. ("TACP") and Toshiba Hawaii Inc. ("THI") make the following limited warranties. These limited warranties extend to the original consumer purchaser or any person receiving this set as a gift from the original consumer purchaser and to no other purchaser or transferee.

Limited One (1) Year Warranty

TACP and THI warrant this product and its parts against defects in materials or workmanship for a period of one (1) year after the date of original retail purchase. During this period, TACP and THI will repair or replace a defective part, at their option, with a new or refurbished part, without charge to you. TACP/THI Authorized Service Station personnel will come to your home when warranty service is required. Depending on the type of repair required, the service will either be performed in your home or the set will be taken to the TACP/THI authorized service station for repair and returned to your home at no cost to you.

Limited Two (2) Year Warranty of Picture Tube

TACP and THI further warrant the picture tube in this product against defects in materials or workmanship for a period of two (2) years after the date of original retail purchase. During this period, TACP and THI will repair or replace a defective picture tube at their option, with a new or refurbished picture tube, without charge to you, except that if a defective picture tube is replaced after one (1) year from the date of the original retail purchase, you pay labor charges involved in the replacement.

Rental Units

The warranty for rental units begins with the first rental or thirty (30) days from the date of shipment to the rental firm, whichever comes first.

Commercial Units

Products sold and used for commercial use have a limited ninety (90) day warranty for all parts, labor and picture tube.

Owner's Manual and Demographic Card

You should read this owner's manual thoroughly before operating this product. You should complete and mail the enclosed Demographic card within ten days after you, or the person who has given you this product as a gift, purchased this product. This is one way to enable TACP/THI to provide you with better customer service and improved products. Failure to return the Demographic card will not affect your rights under this warranty.

Your Responsibility

The above warranties are subject to the following conditions;

- (1) You must retain your bill of sale or provide other proof of purchase.
- (2) All warranty servicing of this product must be made by an Authorized TACP/THI Service Station.
- (3) These warranties are effective only if the product is purchased and operated in the U.S.A. or Puerto Rico.
- (4) Labor service charges for set installation, set up, adjustment of customer controls and installation or repair of antenna systems are not covered by this warranty. Reception problems caused by inadequate antenna systems are your responsibility.
- (5) Warranties extend only to defects in materials or workmanship as limited above and do not extend to any product or parts which have been lost or discarded by you or to damage to products or parts caused by misuse, accident, damage caused by Acts of God, such as lightning or fluctuations in electric power, improper installation, improper maintenance or use in violation of instructions furnished by us; or to units which have been modified or had the serial number removed, altered, defaced or rendered illegible.

How to Obtain Warranty Service

If, after following all of the operating instructions in this manual and checking the "Troubleshooting" section, you find that service is needed:

- (1) Call the TACP toll-free number 1-800-631-3811 to find the nearest TOSHIBA Authorized Service Station. In Hawaii, contact Toshiba Hawaii, Inc. 327 Kamakee Street, Honolulu, Hawaii 96814 (808) 591-9281
- (2) Present your bill of sale or other proof to the Authorized Service Station. "Authorized TACP/THI service station personnel will come to your home when warranty service is required. Depending on the type of repair required, the service will either be performed in your home or the set will be taken to the TACP/THI Authorized service station for repair and returned to your home at no cost to you."

**For additional information,
visit our web site:
www.toshiba.com**

All warranties implied by state law, including the implied warranties of merchantability and fitness for a particular purpose, are expressly limited to the duration of the limited warranties set forth above. With the exception of any warranties implied by state law as hereby limited, the foregoing warranty is exclusive and in lieu of all other warranties, guarantees, agreements and similar obligations of manufacturer or seller with respect to the repair or replacement of any parts. In no event shall TACP or THI be liable for consequential or incidental damages.

No person, agent, distributor, dealer or company is authorized to change, modify or extend the terms of these warranties in any manner whatsoever. The time within which action must be commenced to enforce any obligation of TACP or THI arising under this warranty or under any state, or law of the United States or any state thereof, is hereby limited to 90 days from the date you discover or should have discovered, the defect. This limitation does not apply to implied warranties arising under state law.

This warranty gives you specific legal rights and you may also have other rights which may vary from state to state. Some states do not allow limitation on how long an implied warranty lasts, when an action may be brought, or the exclusion or limitation of incidental or consequential damages, so the above provisions may not apply to you.



ATTENTION CANADIAN CONSUMERS:

Canadian consumers are requested to complete the special Canadian "Warranty Registration Form" enclosed, and forward this completed form with a copy of bill of sale to TOSHIBA OF CANADA to "Register and Validate" their warranty.

Products purchased in the U.S.A. and used in Canada are not covered by these warranties.

Products Purchased in Canada and used in the U.S.A. are not covered by these warranties.

REV. 09-01

Index

A

A/V receiver connection	11
ANT 1/2	23
Antenna cables	5
Audio cables	5
AUDIO OUT sound, selecting	52
Audio system connection	11
Auto convergence	26
Automatic light sensor (ALS)	43
Auto power off	54

B

BACKGROUND selection	53
Back of the TV	4

C

Cable converter box connection	6
Camcorder connection	10
CH ▲▼ buttons	25
Channel surf mode	25
CH LABEL	29
CH LOCK	39
CH RTN button	28
Channel Number buttons	25
Channel programming	
ADD/ERASE	25
Automatic programming	24
TV/CABLE selection	24
Cinema mode	44
Clock, setting	48
Closed caption	47
ColorStream® cables	5
Convergence adjustment	26
Color temperature	45

D

Demonstration mode	54
Double-window ("POP") feature	34
DNR (Digital Noise Reduction)	44
DTV receiver connection	9
DVD connection	7, 8

F I

(FAV) ◀▶ buttons	28
FAVORITE button	35
Favorite channels	28
Front of the TV	4
Front panel lock	41
FOCUS feature	50
INPUT button	23, 46

L M

Labeling channels	29
Labeling video inputs	46
Language selection	23
Last mode memory	54
Locking channels	39
Locking video inputs	40
Locks menu	36
Menu system	22
MTS feature	49
MUTE button	49

P

Picture adjustments	
COLOR TEMPERATURE	45

FLESH TONE	43
Picture mode	42
Picture quality	42
Picture-out-picture (POP)	
PIP button	34
PIP CH ▲▼ buttons	34
SOURCE button	34
STILL button	35
SWAP button	35
Picture scroll	33
Picture size selection	31

R

RECALL button	53
Remote control	
Battery installation	12
Device code table	17-20
Functional key chart	13-14
Learning about the buttons	21
Operational feature reset	16
Programming	15
Searching and sampling the code	15
Verifying the device code	16
Volume Lock feature	16
RESET	45, 51

S

SAP sound	49
Satellite receiver connection	7
Scrolling the Theater Wide picture	33
Set-top box	9
Sleep timer	48
Sound quality adjustments	50
SPEAKERS on/off	52
Specifications	55
SRS 3D surround	50
StableSound™	53
Stereo sound	49
Sub-bass system (SBS)	51
S-video cables	5

T

Theater wide picture	31, 32
TOUCH FOCUS	26
Troubleshooting	56
TruBass feature	50
TV/VIDEO button	23

V

V-CHIP	
BLOCKING OPTION	38
ENABLE BLOCKING	37
MPAA RATING	38
NEW PIN CODE	41
TV RATING	37
Unlocking programs temporarily	39
VCR connection	5-10
Video cables	5
VIDEO LABEL	46
VIDEO LOCK	40

W

Warranty	57
WOW feature	50

TOSHIBA AMERICA CONSUMER PRODUCTS, INC.

HEAD OFFICE/82 TOTOWA ROAD, WAYNE, NEW JERSEY 07470
NATIONAL SERVICE DIVISION:1420B TOSHIBA DRIVE, LEBANON, TN. 37087

TOSHIBA HAWAII, INC.

HEAD OFFICE/327 KAMAKEE STREET, HONOLULU, HAWAII 96814, U.S.A. TEL: (808) 591-9281

TOSHIBA OF CANADA LTD.

HEAD OFFICE/191 McNABB STREET MARKHAM, ONTARIO L3R 8H2, CANADA TEL: (905) 470-5400
SERVICE CENTERS/TORONTO: 191 McNABB STREET MARKHAM, ONTARIO L3R 8H2, CANADA TEL: (905) 470- 5400
MONTREAL: 1643, NORTH SERVICE RD., TRANS-CANADA HIGHWAY, DORVAL QUEBEC, H9P 1J1, CANADA
TEL: (514) 856-4100
VANCOUVER: 22171 FRASERWOOD WAY, RICHMOND, B.C. V6W 1J5, CANADA TEL: (604) 303-2500

MANUFACTURED BY
TOSHIBA AMERICA CONSUMER PRODUCTS, INC.

ColorStream is a registered trademark of Toshiba Corporation. StableSound is a trademark of Toshiba America Consumer Products, Inc.

PRINTED IN USA
(01-07) B

TOSHIBA
23565298

Free Manuals Download Website

<http://myh66.com>

<http://usermanuals.us>

<http://www.somanuals.com>

<http://www.4manuals.cc>

<http://www.manual-lib.com>

<http://www.404manual.com>

<http://www.luxmanual.com>

<http://aubethermostatmanual.com>

Golf course search by state

<http://golfingnear.com>

Email search by domain

<http://emailbydomain.com>

Auto manuals search

<http://auto.somanuals.com>

TV manuals search

<http://tv.somanuals.com>