



# TOSHIBA



Introduction

Connecting your TV

Using the Remote Control

Setting up your TV

Using the TV's Features

Appendix

Index

# OWNER'S MANUAL

## DLP™ Projection Television

COLORSTREAM®

SRS WOW

VIRTUAL DOLBY DIGITAL

THEATERWIDE HD

HDTV MONITOR

# 52HMX84

# 62HMX84



### Owner's Record

The model number and serial number are on the back of your TV. Record these numbers in the spaces below. Refer to these numbers whenever you communicate with your Toshiba dealer about this TV.

Model:

Serial No.:

23566348

© 2004 TOSHIBA CORPORATION  
All Rights Reserved

## Dear Customer,

Thank you for purchasing this Toshiba TV. This manual will help you use the many exciting features of your new TV. **Before operating the TV, please read this manual completely,** and keep it nearby for future reference.

## Safety Precautions

**WARNING: TO REDUCE THE RISK OF FIRE OR ELECTRIC SHOCK, DO NOT EXPOSE THIS APPLIANCE TO RAIN OR MOISTURE.**



**WARNING: TO REDUCE THE RISK OF ELECTRIC SHOCK, DO NOT REMOVE COVER (OR BACK). NO USER-SERVICEABLE PARTS INSIDE. REFER SERVICING TO QUALIFIED SERVICE PERSONNEL.**

 The lightning symbol in the triangle tells you that the voltage inside this product may be strong enough to cause an electric shock. **DO NOT TRY TO SERVICE THIS PRODUCT YOURSELF.**

 The exclamation mark in the triangle tells you that important operating and maintenance instructions follow this symbol.

## Lamp Unit Replacement

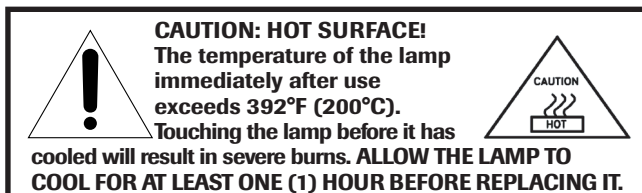

The lamp in this product has a limited service life. The length of service life varies depending on product use and user settings. If you use the lamp beyond its service life:

- you may notice a reduction in the colors and/or brightness of the picture, at which time you should replace the lamp unit; and
- the strength of the quartz glass in the lamp will be reduced and the lamp may rupture. If the lamp ruptures, the TV will not operate until the lamp unit is replaced.

**Note:** The lamp unit is designed so broken lamp glass remains securely inside the lamp unit.

See "Appendix" on pages 60–64.

- Dispose of the used lamp unit by the approved method for your area.

 **Note:** The lamp unit contains mercury. Disposal of mercury may be regulated due to environmental considerations. For disposal or recycling information, contact your local authorities or the Electronics Industries Alliance ([www.eiae.org](http://www.eiae.org)).



ENERGY STAR® qualified TV. Products that earn the ENERGY STAR prevent green house gas emissions by meeting strict energy efficiency guidelines set by the U.S. Environmental Protection Agency and the U.S. Department of Energy. ENERGY STAR and the ENERGY STAR mark are registered U.S. marks.

 **NOTE: NEVER CONNECT THIS TV TO A PERSONAL COMPUTER (PC).** THIS TV IS NOT INTENDED FOR USE WITH A PC.

## NOTICE OF POSSIBLE TV STAND INSTABILITY



**CAUTION: This television is for use only with the Toshiba stand listed below.** Use with other carts or stands is capable of resulting in instability causing possible injury.

Television	Stand Model
52HMx84	ST5284, ST5294
62HMx84	ST6284, ST6294

In Canada, please contact your authorized Toshiba dealer or visit the Toshiba Canada web site at [www.toshiba.ca](http://www.toshiba.ca) to determine the appropriate stand for your television.

## NOTE TO CATV INSTALLERS IN THE U.S.A.

This is a reminder to call the CATV system installer's attention to Article 820-40 of the NEC, which provides guidelines for proper grounding and, in particular, specifies that the cable ground shall be connected to the grounding system of the building, as close to the point of cable entry as practical. For additional antenna grounding information, see items 27 and 28 on page 4.

## Child Safety

**It Makes A Difference Where Your TV Stands**

**Congratulations on your purchase!**

**As you enjoy your new TV, keep these safety tips in mind:**



### The Issue

- If you are like most consumers, you have a TV in your home. Many homes, in fact, have more than one TV.
- The home theater entertainment experience is a growing trend, and larger TVs are popular purchases; however, they are not always supported on the proper TV stands.
- Sometimes TVs are improperly secured or inappropriately situated on dressers, bookcases, shelves, desks, audio speakers, chests, or carts. As a result, TVs may fall over, causing unnecessary injury.

### We Care!

- The consumer electronics industry is committed to making home entertainment enjoyable and safe.
- The Consumer Electronics Association formed the Home Entertainment Support Safety Committee, comprised of TV and consumer electronics furniture manufacturers, to advocate children's safety and educate consumers and their families about television safety.

### Tune Into Safety

- One size does NOT fit all! Use appropriate furniture large enough to support the weight of your TV (and other electronic components).
- Use appropriate angle braces, straps, and anchors to secure your furniture to the wall (but never screw anything directly into the TV).
- Carefully read and understand the other enclosed instructions for proper use of this product.
- Do not allow children to climb on or play with furniture and TVs.
- Avoid placing any item on top of your TV (such as a VCR, remote control, or toy) that a curious child may reach for.
- Remember that children can become excited while watching a program and can potentially push or pull a TV over.
- Share our safety message about this hidden hazard of the home with your family and friends. Thank you!



2500 Wilson Blvd.  
Arlington, VA 22201 U.S.A.  
Tel. 703-907-7600 Fax 703-907-7690  
[www.CE.org](http://www.CE.org)

CEA is the Sponsor, Producer and Manager of the International CES®

## Important Safety Instructions

- 1) **Read these instructions.**
- 2) **Keep these instructions.**
- 3) **Heed all warnings.**
- 4) **Follow all instructions.**



- 5) **Do not use this apparatus near water.**
- 6) **Clean only with dry cloth.**
- 7) **Do not block any ventilation openings.** Install in accordance with the manufacturer's instructions.

- 8) **Do not install near any heat sources** such as radiators, heat registers, stoves, or other apparatus (including amplifiers) that produce heat.

- 9) **Do not defeat the safety purpose of the polarized or grounding type plug.** A polarized plug has two blades with one wider than the other. A grounding type plug has two blades and a third grounding prong. The wide blade or the third prong are provided for your safety. If the provided plug does not fit into your outlet, consult an electrician for replacement of the obsolete outlet.

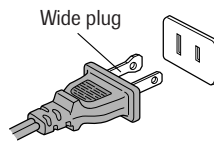

- 10) **Protect the power cord** from being walked on or pinched, particularly at plugs, convenience receptacles, and the point where it exits the apparatus.

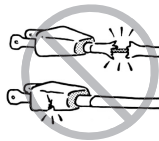

- 11) **Only use attachments/accessories specified by the manufacturer.**

- 12) **Use only with the cart, stand, tripod, bracket, or table specified by the manufacturer, or sold with the apparatus.** When a cart is used, use caution when moving the cart/apparatus combination to avoid injury from tip-over.



- 13) **Unplug this apparatus during lightning storms or when unused for long periods of time.**

- 14) **Refer all servicing to qualified service personnel.** Servicing is required when the apparatus has been damaged in any way, such as power-supply cord or plug is damaged, liquid has been spilled or objects have fallen into the apparatus, or the apparatus has been exposed to rain or moisture, does not operate normally, or has been dropped. **This applies to all items except those specified on pages 60–64 of this manual.**

- 15) **CAUTION:** To reduce the risk of electric shock, do not use the polarized plug with an extension cord, receptacle, or other outlet unless the blades can be inserted completely to prevent blade exposure.

- 16) **WARNING: This product contains a lamp to project the picture, and requires special safety precautions:**
  - See pages 60–64 for instructions on lamp unit replacement.
  - **DO NOT attempt to service this product except as specified on pages 60–64.** The only user-serviceable item in this product is the lamp unit.

## Installation, Care, and Service

### Installation

Follow these recommendations and precautions and heed all warnings when installing your TV:

- 17) Never modify this equipment. Changes or modifications may void: a) the warranty, and b) the user's authority to operate this equipment under the rules of the Federal Communications Commission.

- 18) **DANGER: RISK OF SERIOUS PERSONAL INJURY, DEATH, OR EQUIPMENT DAMAGE!** Never place the TV on an unstable cart, stand, or table. The TV may fall, causing serious personal injury, death, or serious damage to the TV.



- 19) Never place or store the TV in direct sunlight; hot, humid areas; areas subject to excessive dust or vibration; or locations with temperatures at or below 41°F (5°C).

- 20) Always place the TV on the floor or a sturdy, level, stable surface that can support the weight of the unit.

- 21) Never expose the apparatus to dripping or splashing or place items such as vases, aquariums, any other item filled with liquid, or candles on top of the TV.

- 22) Always place the back of the television at least one (1) inch away from any vertical surface (such as a wall) to allow proper ventilation.

- 23) Never block or cover the slots or openings in the TV cabinet back, bottom, and sides. Never place the TV:
  - on a bed, sofa, rug, or similar surface;
  - too close to drapes, curtains, or walls; or
  - in a confined space such as a bookcase, built-in cabinet, or any other place with poor ventilation.

The slots and openings are provided to protect the TV from overheating and to help maintain reliable operation of the TV.

- 24) Never allow anything to rest on or roll over the power cord, and never place the TV where the power cord is subject to wear or abuse.

- 25) Never overload wall outlets and extension cords.

- 26) Always operate this equipment from a 120 VAC, 60 Hz power source only.

(continued on next page)

## Installation (cont. from previous page)

- 27) Always make sure the antenna system is properly grounded to provide adequate protection against voltage surges and built-up static charges (see Section 810 of the National Electric Code).

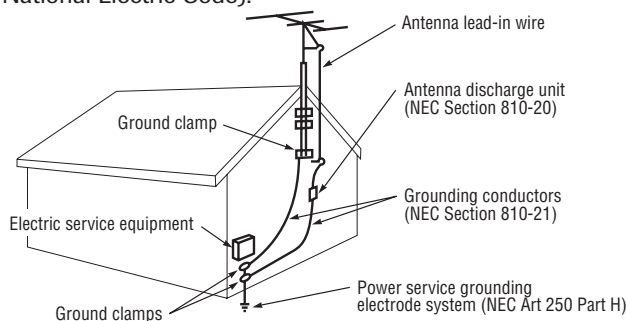



- 28)  **DANGER: RISK OF SERIOUS PERSONAL INJURY OR DEATH!**
- Use extreme care to make sure you are never in a position where your body (or any item you are in contact with, such as a ladder or screwdriver) can accidentally touch overhead power lines. Never locate the antenna near overhead power lines or other electrical circuits.
  - Never attempt to install any of the following during lightning activity:
    - a) an antenna system; or b) cables, wires, or any home theater component connected to an antenna or phone system.

## Care

For better performance and safer operation of your TOSHIBA TV, follow these recommendations and precautions:

- 29) Always sit approximately 10–25 feet away from the TV and as directly in front of it as possible. The picture can appear dull if you sit too far to the left or right of the TV, or if sunlight or room lights reflect on the screen. Turn the TV off to check for reflections on the screen, and then remove the source of reflections while viewing the TV.

- 30) Always unplug the TV before cleaning. Never use liquid or aerosol cleaners. Clean only with a dry cloth. Do not spray volatile compounds such as insecticide on the cabinet. This may cause a discoloration or damage of the cabinet.

- 31)  **WARNING: RISK OF ELECTRIC SHOCK!** Never spill liquids or push objects of any kind into the TV cabinet slots. 

- 32) If the air temperature rises suddenly (for example, when the TV is first delivered), condensation may form on the lenses. This can make the picture appear distorted or the color appear faded. If this happens, turn off the TV for 6 to 7 hours to allow the condensation to evaporate.

## Care (cont. from previous column)

- 33) For added protection of your TV from lightning and power surges, always unplug the power cord and disconnect the antenna from the TV if you leave the TV unattended or unused for long periods of time.

- 34) During normal use, the TV may make occasional snapping or popping sounds. This is normal, especially when the unit is being turned on or off. If these sounds become frequent or continuous, unplug the power cord and contact a Toshiba Authorized Service Center.

### 35) Special care for DLP™ (digital light processing) units:

- **Lamp**—The lamp in this product has a limited service life. The length of service life varies depending on product use or user settings. If you use the lamp beyond its service life:

- you may notice a reduction in the colors and/or brightness of the picture, at which time you should replace the lamp unit; and
- the strength of the quartz glass in the lamp will be reduced and the lamp may rupture. If the lamp ruptures, the TV will not operate until the lamp unit is replaced.

See “Appendix” on pages 60–64.

#### Note:



- The lamp unit is designed so broken lamp glass remains securely inside the lamp unit.



- The lamp unit contains mercury. Disposal of mercury may be regulated due to environmental considerations. For disposal or recycling information, please contact your local authorities or the Electronics Industries Alliance ([www.eiae.org](http://www.eiae.org)).

- Dispose of the used lamp unit by the approved method for your area.

## Service

- 36)  **WARNING: RISK OF ELECTRIC SHOCK!** Never attempt to service the TV yourself,  except as specified on pages 60–64.

Opening and removing the covers may expose you to dangerous voltage or other hazards. Failure to follow this WARNING may result in death or serious injury. Refer all servicing not specified in this manual to a Toshiba Authorized Service Center.

- 37) If you have the TV serviced:

- Ask the service technician to use only replacement parts specified by the manufacturer.
- Upon completion of service, ask the service technician to perform routine safety checks to determine that the TV is in safe operating condition.

- 38) When the TV reaches the end of its useful life, ask a qualified service technician to properly dispose of the TV.

**Note:** The lamp unit contains mercury. Disposal of mercury may be regulated due to environmental considerations. Dispose of the used lamp unit by the approved method for your area. For disposal or recycling information, please contact your local authorities or the Electronics Industries Alliance ([www.eiae.org](http://www.eiae.org)).



## Important notes about your DLP™ projection TV

- 1) The light source for this TV is a projection lamp unit with a limited service life. When the lamp wears out, the picture may become dark or black, or the lamp may fail, at which time you must replace the lamp unit. See "Lamp unit replacement" on pages 60-64.
- 2) Each time you turn on the TV, it may take up to several seconds to go from no picture to full picture brightness.
- 3) The display on this TV is manufactured using a chip that may contain up to 1.3 million microscopic mirrors. Each of these micromirrors measures less than one-fifth the width of a human hair and represents a single pixel on the television display. These micromirrors are mounted on tiny hinges that enable them to tilt either toward the light source (ON) or away from it (OFF). Occasionally, one of these mirrors may become inoperative, creating a light or dark pixel on the projection surface. This is a structural property of DLP™ projection TV technology, and is not a sign of malfunction. Such pixels are not visible when the picture is viewed from a normal viewing distance (see item 29 on page 4).
- 4) Depending on the media you are viewing, it is possible, although unlikely, that a limited number of viewers may see a "rainbow effect" on the screen, which can, in rare instances, result in eye fatigue. This is a rare occurrence related to technology of this type, and is not a sign of TV malfunction.
- 5) Always sit approximately 10-25 feet away from the TV and as directly in front of it as possible. The picture quality may be affected by your viewing position and length of viewing time. If you sit too closely to the TV for too long, you may suffer from eye fatigue. See item 29 on page 4.
- 6)  This TV contains several cooling fans to moderate the internal temperature. You may be able to hear the fans for several minutes after the TV is turned off. This is a function of the Quick Restart standby mode and is not a sign of TV malfunction. You can set the Quick Restart feature to stop the fans as soon as the TV is turned off. See "Selecting the Quick Restart" on page 28.
- 7) The green and red LED lights on the control touchpad (on the lower right corner of the TV screen) indicate your TV's current status. If either light flashes, see "LED indications" on page 64 for details.
- 8) Review all safety and operating information in this owner's manual before you use your TV.

The DLP logo and DLP medallion are trademarks of Texas Instruments.



<b>Important Safety Information .....</b>	<b>2-5</b>
<b>Introduction .....</b>	<b>7</b>
Welcome to Toshiba .....	7
Exploring your new TV .....	7
<b>Connecting your TV .....</b>	<b>8</b>
Connecting an antenna or cable TV .....	8
Connecting a VCR .....	9
Connecting a cable converter box .....	9
Connecting a cable converter box and VCR .....	10
Connecting a DVD player or satellite receiver and a VCR .....	11
Connecting a DVD player with ColorStream® (component video) and a VCR .....	12
Connecting a DTV receiver/set-top box with ColorStream® (component video) and a VCR .....	13
Connecting two VCRs .....	14
Connecting a camcorder .....	14
Connecting an HDMI™ or a DVI device to the HDMI inputs .....	15
Connecting an audio system .....	16
<b>Using the remote control .....</b>	<b>17</b>
Preparing the remote control for use .....	17
Installing the remote control batteries .....	17
Remote Control functional key chart .....	18
Programming the remote control for use with your audio/video devices .....	20
Device code setup .....	20
Searching and sampling the code of a device [8500] .....	20
Using the volume lock feature [8000] .....	21
Operational feature reset [8900] .....	21
Device code table .....	22
Learning about the remote control .....	24
<b>Setting up your TV .....</b>	<b>25</b>
Learning about the menu system .....	25
Changing the on-screen display language .....	26
Selecting the antenna input .....	26
Adding channels to the TV's memory .....	27
Programming channels automatically .....	27
Adding and erasing channels manually .....	28
Changing channels .....	28
Selecting the Quick Restart .....	28
<b>Using the TV's features .....</b>	<b>29</b>
Adjusting the channel settings .....	29
Switching between two channels using Channel Return .....	29
Switching between two channels using SurfLock™ .....	29
Programming your favorite channels .....	29
Labeling channels .....	31
Viewing the wide-screen picture formats (480i, 480p and 1080i signals only) .....	32
Selecting the picture size .....	32
Scrolling the TheaterWide® picture (TheaterWide 2 and 3 only) .....	34
Using the AUTO ASPECT feature .....	35
Using the POP double-window feature .....	36
Switching the main and POP pictures .....	37
Switching the speaker audio (main or POP) .....	37
Double-Window aspect ratio .....	38
Using the programmed channel search function .....	38
Using the favorite channel search function .....	39
About the auto favorite feature .....	39
Using the LOCKS menu .....	40
Entering the PIN code .....	40
If you cannot remember your PIN code .....	40
Using the V-CHIP menu .....	40
ENABLE BLOCKING .....	41
TV RATING (Independent rating system for broadcasters) .....	41
MPAA RATING (Independent rating system for movies) .....	42
BLOCKING OPTION .....	42
Unlocking programs temporarily .....	43
Locking channels .....	43
Locking the video inputs .....	45
Changing the PIN code .....	45
Adjusting the picture .....	46
Selecting the picture mode .....	46
Adjusting the picture quality .....	46
Saving your new preferences .....	47
Selecting the color temperature .....	47
Using the CableClear™ DNR feature .....	48
Resetting picture adjustments .....	48
Selecting the lamp mode .....	49
Selecting the cinema mode .....	49
Selecting the video input source .....	50
Labeling the video input sources .....	50
Using the closed caption feature .....	51
Setting the ON timer .....	52
Setting the sleep timer .....	52
Setting the clock .....	53
Adjusting the sound .....	54
Muting the sound .....	54
Selecting stereo/SAP broadcasts .....	54
Using the WOW™ surround sound feature .....	55
Adjusting the sound quality .....	55
Enjoying the Dolby Virtual sound feature .....	56
Resetting your audio adjustments .....	57
Using the StableSound® feature .....	57
Turning off the built-in speakers .....	58
Selecting the AUDIO OUT sound .....	58
Selecting the background of the menu display .....	59
Displaying on-screen information .....	59
Understanding the auto power off feature .....	59
Understanding the last mode memory feature .....	59
<b>Appendix .....</b>	<b>60</b>
Lamp unit replacement .....	60
When to replace the lamp unit .....	60
How to replace the lamp unit .....	61
Lamp unit disposal .....	64
LED indications .....	64
Specifications .....	65
Troubleshooting .....	66
Limited United States Warranty .....	67
Limited Canada Warranty .....	68
<b>Index .....</b>	<b>69</b>

# Introduction

## Welcome to Toshiba

Thank you for purchasing this Toshiba TV, one of the most innovative DLP™ projection TVs on the market. The goal of this manual is to guide you through setting up and operating your Toshiba TV as quickly as possible.

This manual applies to models 52HMX84 and 62HMX84. The model and serial numbers are on the back of your TV. Write these numbers in the space provided on the front cover of this manual for your records.

Instructions in this manual are based on using the remote control. You can also use the controls on the TV if they have the same name as those on the remote control.

Please read all the safety and operating instructions carefully, and keep the manual for future reference.

## Exploring your new TV

You can operate your TV using the control touchpad on the TV front or the remote control. The back panel and side panel (behind the door) provide terminals for connecting other equipment to your TV. See "Connecting your TV" on page 8.

Model 52HMX84 is used in this manual for illustration purpose.

See "Important notes about your DLP™ projection TV" on page 5.

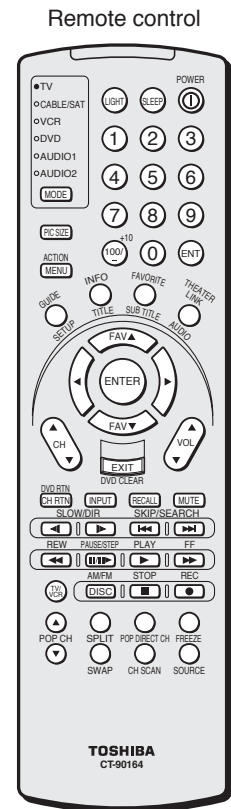
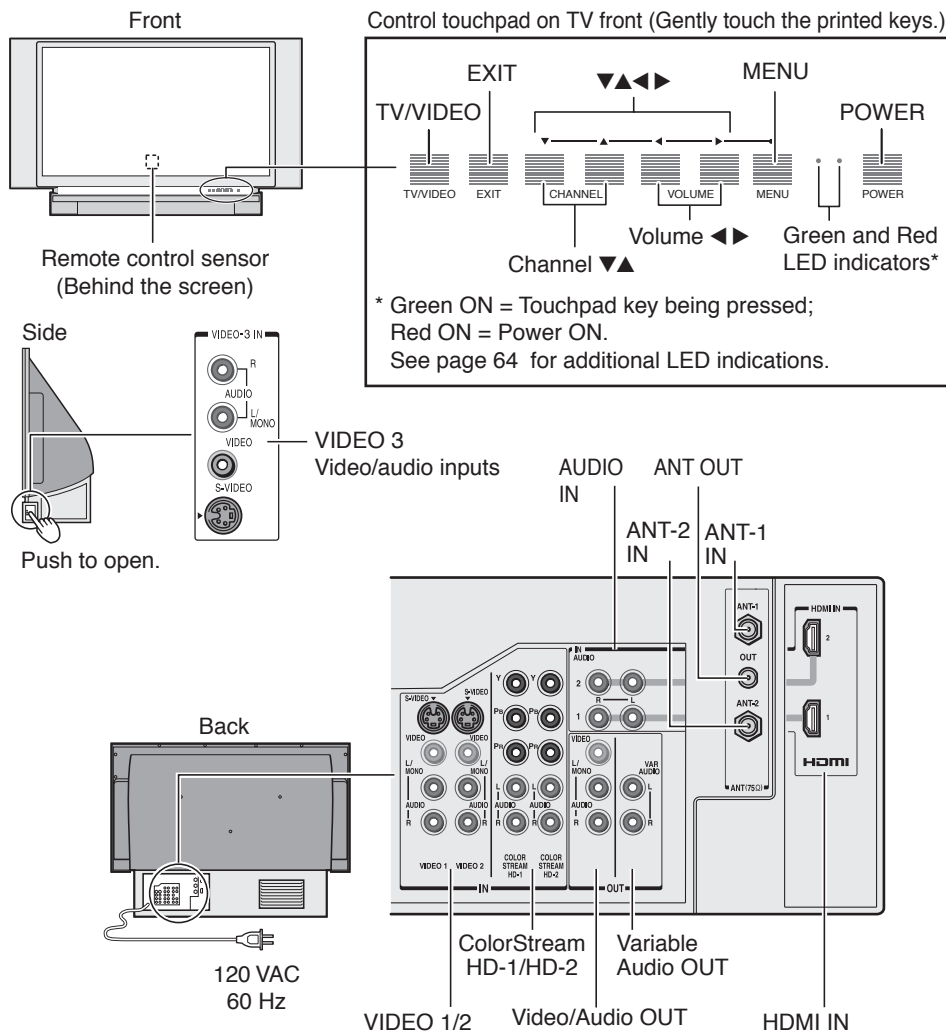

Introduction

Connecting your TV

Using the Remote Control

Setting up your TV

Using the TV's Features

Appendix

Index

## Connecting your TV

**Note:** Cables are not supplied with your TV.

- **Coaxial cable** is the cable that comes in from your antenna, cable TV service, or cable converter box. Coaxial cable uses “F” connectors.
- **Standard A/V (audio/video) cables** usually come in sets of three, and are typically color-coded according to use: yellow for video, red for stereo right audio, and white for stereo left (or mono) audio.  
On your TV's back panel, the standard A/V inputs are color-coded in the same manner as the cables.
- **S-Video cable** is for use with video equipment that has S-Video output.
- **Component video cables** come in sets of three, and are for use with video equipment that has component video output. (ColorStream® is Toshiba's brand of component video.)
- **HDMI** is for use with video equipment that has HDMI output (type A connector) (see page 15).



**NOTE: NEVER CONNECT THIS TV TO A PERSONAL COMPUTER (PC).**  
THIS TV IS NOT INTENDED FOR USE WITH A PC.

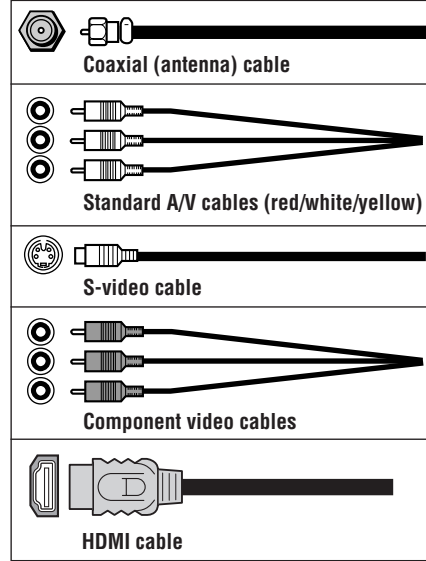

## Connecting an antenna or cable TV

This connection allows you to watch TV programs or basic cable channels.



**CAUTION: RISK OF EQUIPMENT DAMAGE !**

Never plug in any power cords until you have finished connecting all equipment.

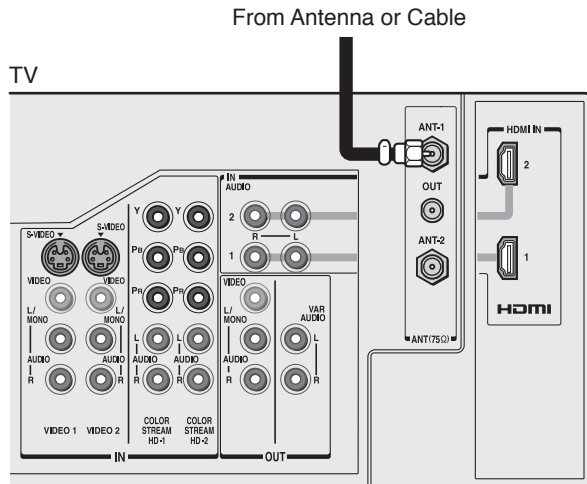



## Connecting a VCR

This connection allows you to watch local channels and video programs, play or record on the VCR while watching TV, and record from one channel while watching another channel.

You will need:

- two coaxial cables
- one set of standard A/V cables

From Cable Box or Antenna

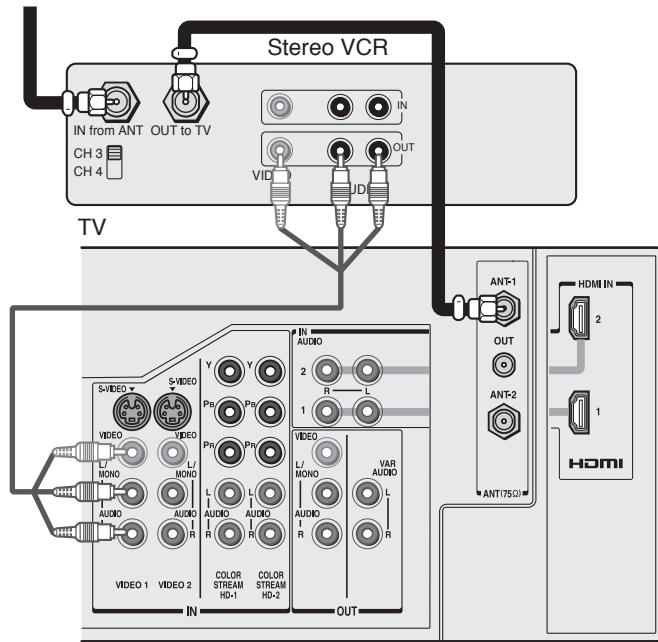

### Note:

If you have a mono VCR, connect L/Mono to VCR Audio OUT using only one audio cable.

If you have a VCR with S-video, use an S-video cable (in the S-video jacks) instead of a standard video cable.

Do not connect a standard video cable and an S-video cable to Video-1 (or Video-2) at the same time, or the picture performance will be unacceptable.

The unauthorized recording, use, distribution, or revision of television programs, videotapes, DVDs, and other materials is prohibited under the Copyright Laws of the United States and other countries, and may subject you to civil and criminal liability.

## Connecting a cable converter box

This connection allows you to watch basic and premium cable channels.

To watch basic cable and use the TV's features, select ANT-1. To view premium channels, select ANT-2, tune the TV to channel 3 or 4 (whichever channel is vacant in your area), and use the converter box to change channels.

You will need:

- three coaxial cables

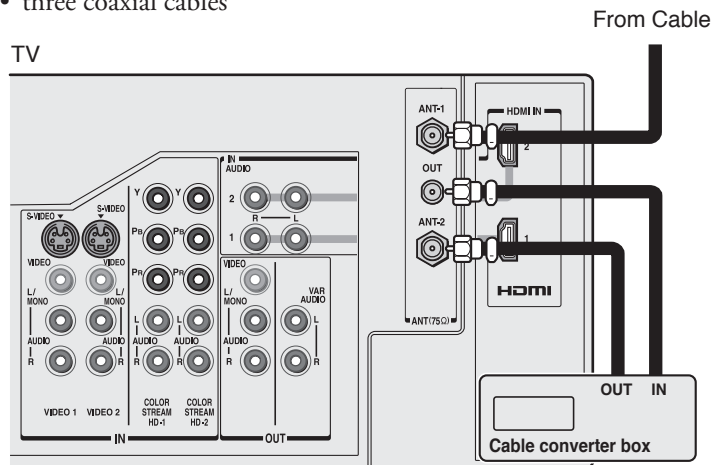

### Note:

When you use a converter box with your TV, the remote control will not operate some features, such as programming your favorite channels, labeling channels, and locking channels.

## Connecting a cable converter box and VCR

This connection allows you to watch and record basic and premium cable channels, watch videotapes, and record one channel while watching another channel. To watch basic cable and use the TV's features, select ANT-1.

To view premium channels or record with the VCR, select ANT-2, tune the TV and VCR to channel 3 or 4 (whichever channel is vacant in your area), and use the converter box to change channels.

You will need:

- four coaxial cables
- one set of standard A/V cables

### Note:

If you have a mono VCR, connect L/Mono to VCR Audio OUT using only one audio cable.

If you have a VCR with S-video, use an S-video cable (in the S-video jacks) instead of a standard video cable. Do not connect a standard video cable and an S-video cable to Video-1 (or Video-2) at the same time, or the picture performance will be unacceptable.

When you use a converter box with your TV, the remote control will not operate some features, such as programming your favorite channels, labeling channels, and locking channels.

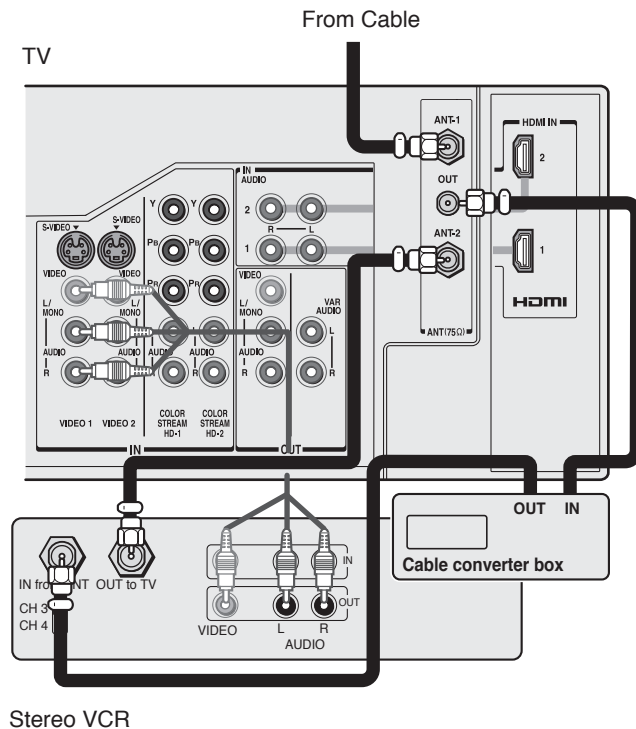

The unauthorized recording, use, distribution, or revision of television programs, videotapes, DVDs, and other materials is prohibited under the Copyright Laws of the United States and other countries, and may subject you to civil and criminal liability.

## Connecting a DVD player or satellite receiver and a VCR

This connection allows you to watch DVD/satellite, VCR, and TV programs, and record one TV channel while watching another channel.

You will need:

- two (or three, if satellite receiver is used) coaxial cables
- one set of standard A/V cables
- one S-video cable
- one pair of standard audio cables

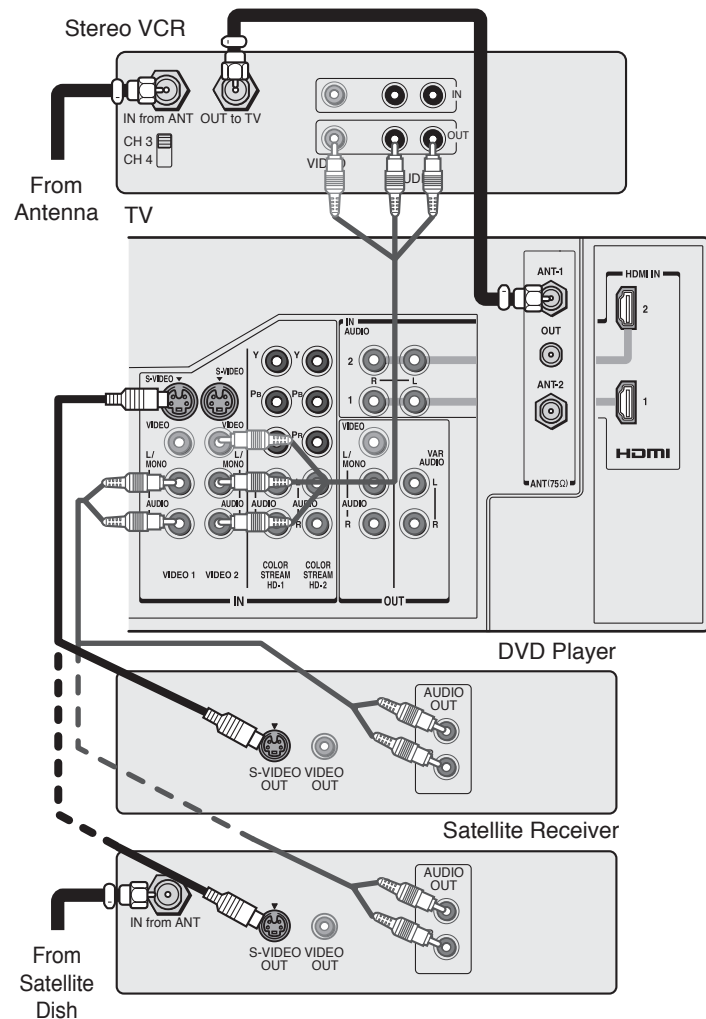

### Note:

For the highest possible picture quality from a DVD player or satellite receiver without component video or HDMI, use an S-video cable. (If your DVD player has component video, see page 12. If your DVD player or satellite receiver has HDMI or DVI, see page 15.)

Do not connect both an S-video cable and a standard video cable between the TV and DVD player/satellite receiver at the same time or the picture performance will be unacceptable.

Do not connect the DVD player/satellite receiver and VCR to the same set of Video inputs on the TV. (See the illustration, which shows the DVD player/satellite receiver connected to VIDEO 1 on the TV, and the VCR connected to VIDEO 2 on the TV.)

The unauthorized recording, use, distribution, or revision of television programs, videotapes, DVDs, and other materials is prohibited under the Copyright Laws of the United States and other countries, and may subject you to civil and criminal liability.

## Connecting a DVD player with ColorStream® (component video) and a VCR

This connection allows you to watch DVD, VCR, and TV programs, and record TV programs.

Your TV has ColorStream® (component video) inputs. Connecting your TV to a DVD player with component video (such as a Toshiba DVD player with ColorStream®) can greatly enhance picture quality and realism.

- To record one TV program while watching another TV program, tune the VCR to the channel to record, and tune the TV to the channel to watch.
- To record a TV program while watching a DVD, tune the VCR to the channel to record, and select ColorStream HD1 on the TV (see “Selecting the antenna input” on page 26).

You will need:

- two coaxial cables
- one set of standard A/V cables
- one pair of standard audio cables
- one set of component video cables

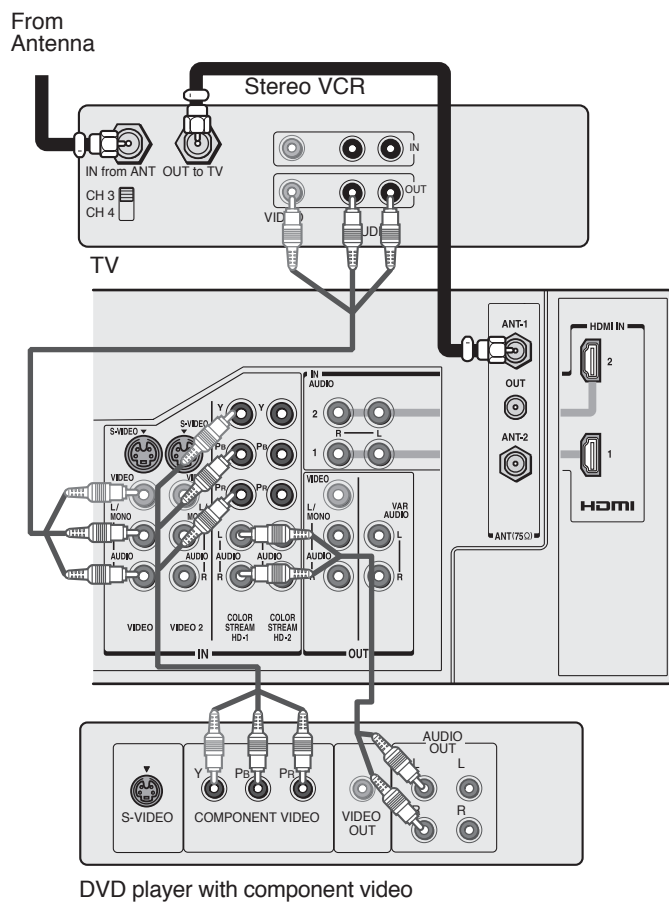

### Note:

For the highest possible picture quality, use component video cables (or an HDMI cable) between the TV and DVD player.

You can connect the component video cables to either set of ColorStream inputs on the TV (HD1 or HD2).

For HDMI or DVI connection, see page 15.

The ColorStream HD1/HD2 and HDMI1/2 inputs can be used with Progressive (480p, 720p) and Interlaced (480i, 1080i) scan systems; however, a 1080i signal will provide the best picture performance.

If your DVD player is not compatible with component video, HDMI, or DVI, use the S-video connections (plus the standard audio connections) instead (see page 11).

The unauthorized recording, use, distribution, or revision of television programs, videotapes, DVDs, and other materials is prohibited under the Copyright Laws of the United States and other countries, and may subject you to civil and criminal liability.

## Connecting a DTV receiver/set-top box with ColorStream® (component video) and a VCR

This connection allows you to watch DTV (digital TV), VCR, and TV programs, and record DTV (composite video only) and TV programs.

Your TV has ColorStream (component video) inputs. Connecting your TV to a DTV receiver with component video can greatly enhance picture quality and realism.

- To record and watch a DTV program, select LINE IN on the VCR, and select ColorStream HD2 (or VIDEO 1 for a non-ColorStream connection) on the TV (see "Selecting the antenna input" on page 26).
- To record a TV program while watching a DTV program, tune the VCR to the channel to record, and select ColorStream HD2 on the TV.
- To record and watch the same TV program, tune the VCR to the channel to record, and select VIDEO 1 on the TV.
- To record one TV program while watching another TV program, tune the VCR to the channel to record, and tune the TV to the channel to watch.

You will need:

- three coaxial cables
- two sets of standard A/V cables
- one pair of standard audio cables
- one set of component video cables

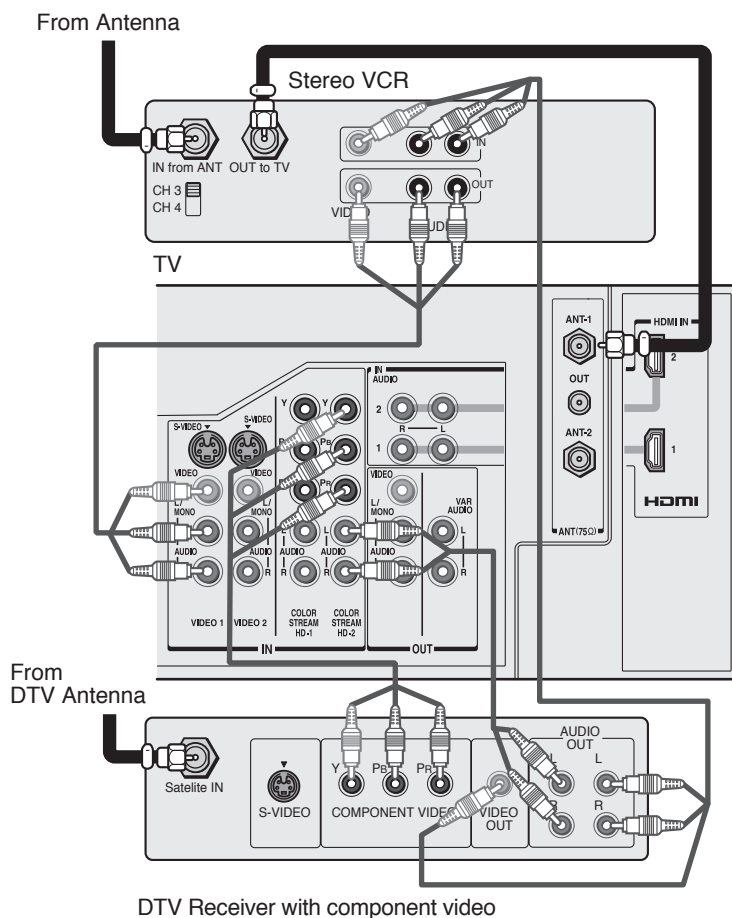

### Note:

For the highest possible picture quality, use component video cables (or an HDMI cable) between the TV and DTV receiver/set-top box.

You can connect component video cables to either set of ColorStream inputs on the TV (HD1 or HD2).

For HDMI or DVI connection, see page 15.

The ColorStream HD1/HD2 and HDMI1/2 inputs can be used with Progressive (480p, 720p) and Interlaced (480i, 1080i) scan systems; however, a 1080i signal will provide the best picture performance.

If your DTV receiver or set-top box is not compatible with component video or HDMI, use the S-video connections (plus the standard audio connections) instead (see page 11).

The unauthorized recording, use, distribution, or revision of television programs, videotapes, DVDs, and other materials is prohibited under the Copyright Laws of the United States and other countries, and may subject you to civil and criminal liability.



## Connecting two VCRs

This connection allows you to record (dub/edit) from one VCR to another VCR while watching a videotape. You also can record from one TV channel while watching another TV channel.

You will need:

- two coaxial cables
- two sets of standard A/V cables

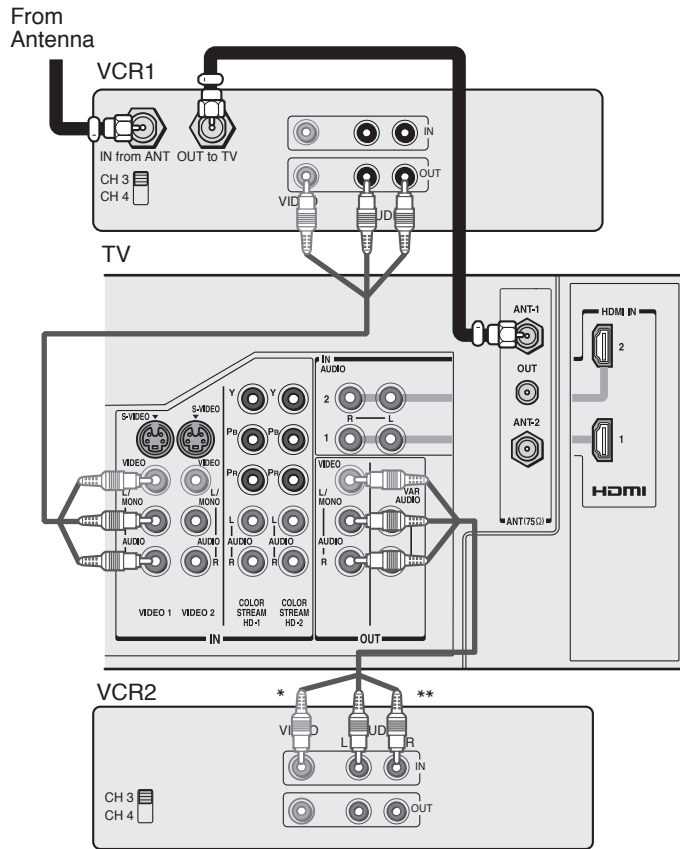

### Note:

If you have VCRs with S-video, use S-video cables instead of standard video cables for better picture performance. Do not connect both a standard video cable and an S-video cable to Video-1 (or Video-2) at the same time, or the picture performance will be unacceptable.

Do not connect the same VCR to the output and input jacks on the TV at the same time. To dub or edit, VCR 2 must select Line IN, and the TV must select VIDEO 1 (see "Selecting the antenna input" on page 26).

\* The VIDEO OUT jack does not output the POP picture.

\*\* The AUDIO OUT jacks can output the sound of either the Main or POP picture (see "Selecting the AUDIO OUT sound" on page 58).

The unauthorized recording, use, distribution, or revision of television programs, videotapes, DVDs, and other materials is prohibited under the Copyright Laws of the United States and other countries, and may subject you to civil and criminal liability.

## Connecting a camcorder

This connection allows you to watch video materials recorded on a camcorder.

You will need:

- one set of standard A/V cables

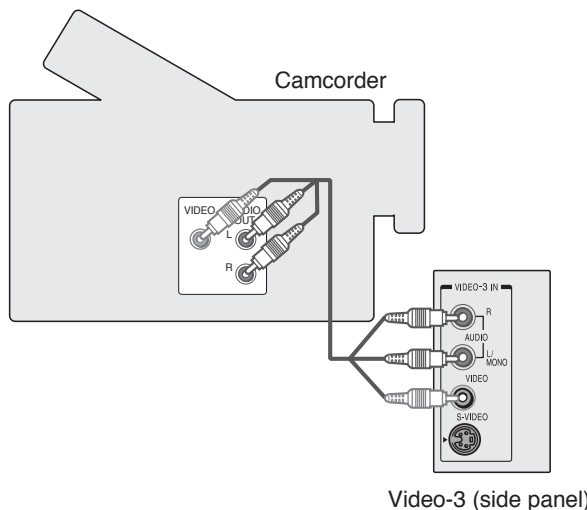

Video-3 (side panel)

### Note:

If you have a camcorder with S-video, use an S-video cable instead of a standard video cable for better picture performance. Do not connect both a standard video cable and an S-video cable at the same time, or the picture performance will be unacceptable.

## Connecting an HDMI™ or a DVI device to the HDMI inputs

The HDMI<sup>[1]</sup> inputs on your TV receive digital audio and uncompressed digital video from an HDMI device or uncompressed digital video from a DVI<sup>[2]</sup> device.

These inputs are designed to accept HDCP<sup>[3]</sup> program material in digital form from EIA/CEA-861/861B-compliant<sup>[4]</sup> consumer electronic devices (such as a set-top box or DVD player with HDMI or DVI output).

The HDMI inputs are designed for best performance with 1080i high-definition video signals, but will also accept and display 480i, 480p, and 720p signals.



**NOTE: NEVER CONNECT THIS TV TO A PERSONAL COMPUTER (PC).** THIS TV IS NOT INTENDED FOR USE WITH A PC.

### To connect an HDMI device, you will need:

- one HDMI cable (type A connector)

For proper operation, it is recommended that you use a short HDMI cable. You should not encounter difficulty if you use an HDMI cable that is shorter than 16.4 ft (5m).

HDMI cable transfers both video and audio. Separate analog audio cables are not required (see illustration below). Some CDVs (Video CDs) may not output digital audio signals. In that case, you may hear sound by connecting analog audio cables. However, if you connect analog audio cables with this connection, the HDMI terminal on the TV will not receive the HDMI digital audio signal and you will hear analog audio only.

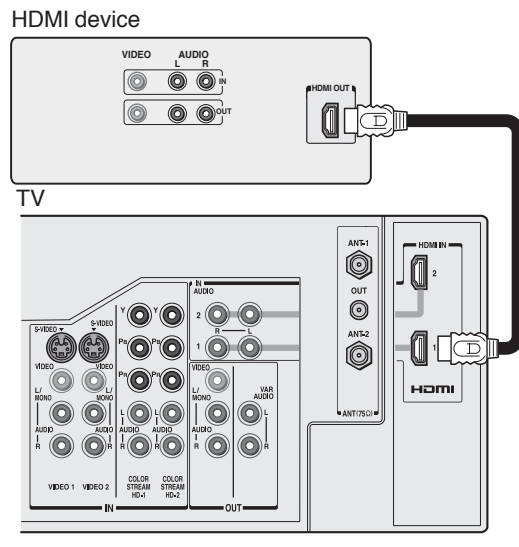

You can connect an HDMI cable or an HDMI-to-DVI adapter cable to either HDMI1 or HDMI2 input on the TV.

See "Selecting the video input source" on page 50.

HDMI, the HDMI logo, and High-Definition Multimedia Interface are trademarks or registered trademarks of HDMI Licensing, LLC.

[1] HDMI = High-Definition Multimedia Interface.

[2] DVI = Digital Video Interface.

[3] HDCP = High-bandwidth Digital Content Protection.

[4] EIA/CEA-861/861B compliance covers the transmission of uncompressed digital video with high-bandwidth digital content protection, which is being standardized for reception of high-definition video signals. Because this is an evolving technology, it is possible that some devices may not operate properly with the TV.

To ensure that the HDMI or DVI device is reset properly, it is recommended that you follow these procedures:

- When turning on your electronic components, **turn on the TV first**, and then the HDMI or DVI device.
- When turning off your electronic components, **turn off the HDMI or DVI device first**, and then the TV.

### To connect a DVI device, you will need:

- one HDMI-to-DVI adapter cable (HDMI type A connector)

For proper operation, the length of an HDMI-to-DVI adapter cable should not exceed 9.8 ft (3m). The recommended length is 6.6 ft (2m).

- one pair of standard analog audio cables

An HDMI-to-DVI adapter cable transfers only video. Separate analog audio cables are required (see illustration below).

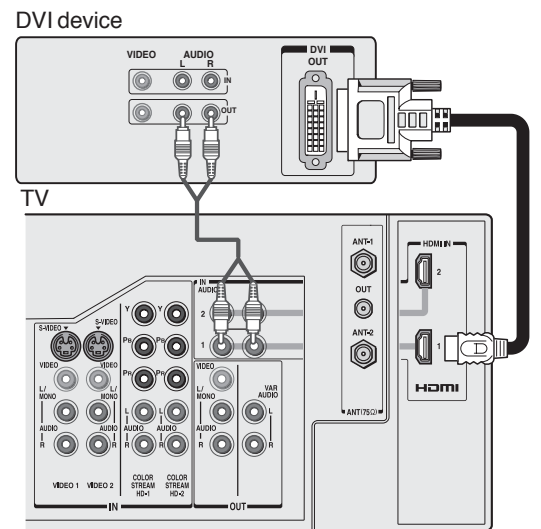

## Connecting an audio system

This connection allows you to use an audio amplifier and external speakers, and adjust the audio level by using the TV's remote control.

To control the audio, turn on the TV and the stereo amplifier, and turn off the built-in speakers (see "Turning off the built-in speakers" on page 58).

You will need:

- one pair of standard audio cables

**Note:**

*To hear sound when using an external audio amplifier, the volume of both the TV and the amplifier must be set above 0 (zero).*

*For example, if the volume of the TV is set to 0, you will not be able to hear any sound, even the volume of the amplifier is at its highest level.*

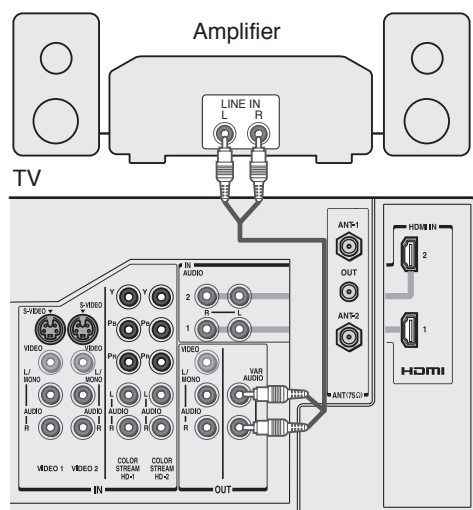

## Using the remote control

### Preparing the remote control for use

Your Toshiba TV remote control has one dedicated TV mode and five universal modes: VCR, Cable/SAT, DVD, Audio1, and Audio2. The target devices and default devices being programmed for each mode are as follows:

Target device/Mode mapping

Mode	Device
TV	Toshiba TV
CABLE/SAT	Universal Cable, Satellite
VCR	Universal VCR, DVD, LD, Cassette
DVD	Universal DVD, VCR, LD, Cassette
AUDIO1	Universal Audio: Amp., Tuner, Misc.Audio, CD/MD
AUDIO2	Universal Audio: CD/MD, Amp., Tuner, Misc.Audio

Default device codes

Mode	Default device
TV	Toshiba TV
CABLE/SAT	Toshiba Satellite receiver
VCR	Toshiba VCR
DVD	Toshiba DVD
AUDIO1	Pioneer Audio receiver
AUDIO2	Pioneer LD

Repeatedly press MODE to cycle among the modes. If you own different brands of audio/video devices, you must first program your remote control (see "Programming the remote control for use with your audio/video devices" on page 20).

### Installing the remote control batteries

To install the batteries:

1. Slide the battery cover off the back of the remote control.

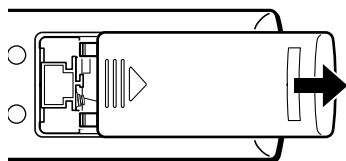

2. Install two "AA" size alkaline batteries. Match the + and - signs on the batteries to the signs on the battery compartment.

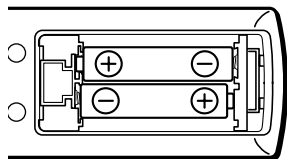

3. Slide the battery cover back on to the remote control until the lock snaps.

#### Note:

Your TV's remote control may not operate certain features on your VCR, cable TV converter, or other electronic device.

Refer to the owner's manuals for your other devices to determine their available features. If your TV's remote control does not operate a specific feature on a device, use the remote control that came with the device.

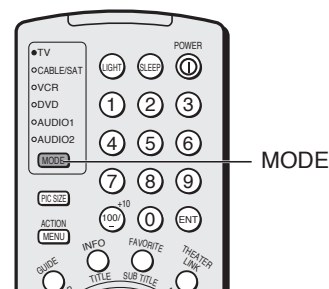

#### Remote control effective range:

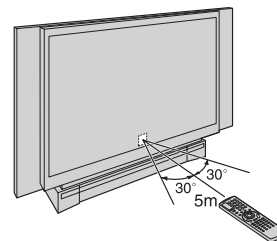

#### Caution:

- Do not throw batteries into a fire.

#### Note:

- If your Toshiba TV remote control does not operate all the features of your other device, use the original remote control for that device.
- Dispose of batteries in a designated disposal area.
- Do not mix battery types or combine used batteries with new ones.
- If the remote control does not operate correctly, or if the operating range becomes reduced, replace both batteries with new ones.
- If the batteries are dead or if you will not use the remote control for a long time, remove the batteries to prevent battery acid from leaking into the battery compartment.

### Remote Control functional key chart

Key Label	Toshiba TV (TV)	Cable (CBL/SAT)	Satellite (CBL/SAT)	VCR	DVD/LD	Receiver (AUDIO)	CD/MD (AUDIO)	Cassette (VCR)
LIGHT	Lights the remote key, and toggles between enabled and disabled Illumination mode.							
SLEEP	Sleep timer	---	---	---	---	---	---	---
POWER	Power	Power	Power	Power	Power	Power	Power	Power
1	Digit 1	Digit 1	Digit 1	Digit 1	Digit 1	AV input 1	Digit 1	Digit 1
2	Digit 2	Digit 2	Digit 2	Digit 2	Digit 2	AV input 2	Digit 2	Digit 2
3	Digit 3	Digit 3	Digit 3	Digit 3	Digit 3	AV input 3	Digit 3	Digit 3
4	Digit 4	Digit 4	Digit 4	Digit 4	Digit 4	AV input 4	Digit 4	Digit 4
5	Digit 5	Digit 5	Digit 5	Digit 5	Digit 5	CD	Digit 5	Digit 5
6	Digit 6	Digit 6	Digit 6	Digit 6	Digit 6	Tuner	Digit 6	Digit 6
MODE	Remote control device mode selection							
PIC SIZE	Selects the image shape.	← TV	← TV	← TV	← TV	← TV	← TV	← TV
7	Digit 7	Digit 7	Digit 7	Digit 7	Digit 7	Phono	Digit 7	Digit 7
8	Digit 8	Digit 8	Digit 8	Digit 8	Digit 8	Cassette	Digit 8	Digit 8
9	Digit 9	Digit 9	Digit 9	Digit 9	Digit 9	Aux	Digit 9	Digit 9
ACTION	---	---	Action, Menu	---	Menu	---	---	---
100/-	100	---	100/-	---	+10	---	---	---
0	Digit 0	Digit 0	Digit 0	Digit 0	Digit 0	Digit 0	Digit 0, 10	Digit 0
ENT (CH Enter)	---	CH Enter	---	---	---	---	---	---
GUIDE/SETUP	---	---	Guide	---	DVD setup	---	---	---
INFO/TITLE	---	---	INFO	---	TITLE= Top menu	---	---	---
FAVORITE/ SUBTITLE	Favorites	---	Favorites	---	Subtitle	---	---	---
THEATERLINK/ AUDIO	---	---	---	---	Audio	---	---	---
MENU/ ACTION	Menu	---	Action, Menu	---	Menu	---	---	---
▲▼ (FAV ▲▼)	Menu select FAV ▲▼	---	Menu select	---	Menu select	---	---	---
◀▶	Menu select	---	Menu select	---	Menu select	---	---	---
ENTER	Enter	---	Select	---	Enter	---	---	---
VOL ▲▼	Volume up/down*	Volume up/down*	Volume up/down*	Volume up/down*	Volume up/down*	Volume up/down*	Volume up/down*	Volume up/down*
EXIT/ DVD CLEAR	Exit	---	Exit	---	DVD clear	---	---	---
CH ▲▼	Channel up/down	Channel up/down	Channel up/down	Channel up/down	---	Channel up/down	---	---
INPUT	TV/Video select	← TV	← TV	VCR input	← TV	---	← TV	← TV
MUTE	Sound mute*	Sound mute*	Sound mute*	Sound mute*	Sound mute*	Sound mute*	Sound mute*	Sound mute*
RECALL	On-screen display	On-screen display	On-screen display	On-screen display	On-screen display	---	---	---
CH RTN/ DVD RTN	Previous channel	Previous channel	Previous channel	---	DVD return	---	---	---
SLOW/ DIR	▶ ▲	---	---	Slow FWD ---	Slow FWD Slow REV	---	---	---
SKIP/ SEARCH	▶ ▲	---	---	---	Skip FWD Skip REV	---	Skip FWD Skip REV	---
REW	VCR →	VCR →	VCR →	Rewind	Rewind	---	Rewind	Rewind
PAUSE/STEP	VCR →	VCR →	VCR →	Pause	Pause	---	Pause	Pause
PLAY	VCR →	VCR →	VCR →	Play	Play	---	Play	Play
FF	VCR →	VCR →	VCR →	Fast FWD	Fast FWD	---	Fast FWD	Fast FWD



Key Label	Toshiba TV (TV)	Cable (CBL/SAT)	Satellite (CBL/SAT)	VCR	DVD/LD	Receiver (AUDIO)	CD/MD (AUDIO)	Cassette (VCR)
TV/VCR	VCR →	---	TV/SAT	TV/VCR	---	---	---	Reverse
AM/FM DISC	---	---	---	---	Disc shift	AM/FM	Disc shift	Deck side A/B switch
STOP	VCR →	VCR →	VCR →	Stop	Stop	---	Stop	Stop
REC**	VCR →	VCR →	VCR →	Record**	---	---	---	Record**
POP CH ▲▼	POP channel up/down	← TV	← TV	← TV	← TV	← TV	← TV	← TV
SPLIT	POP Split	← TV	← TV	← TV	← TV	← TV	← TV	← TV
POP DIRECT CH	POP Direct ch	← TV	← TV	← TV	← TV	← TV	← TV	← TV
FREEZE	Still picture	← TV	← TV	← TV	← TV	← TV	← TV	← TV
SWAP	POP Swap	← TV	← TV	← TV	← TV	← TV	← TV	← TV
CH SCAN	Ch scan	← TV	← TV	← TV	← TV	← TV	← TV	← TV
SOURCE	POP Source	← TV	← TV	← TV	← TV	← TV	← TV	← TV

**Notes:**

- "—" will send nothing.
- "← TV" will jump to TV.
- "→VCR" will jump to last active VCR or DVD. Active VCR/DVD is defined as the mode that remains for a minimum of 5 seconds, or if a key is pressed in that mode.
- \* The VOLUME and MUTE will jump to "TV" by default. When the volume is unlocked, all the devices will have their own volume. The AUDIO1/2 (Receiver, CD) modes will have their own volume even if Volume Lock is on TV, CABLE/SAT, VCR, or DVD. See "Using the volume lock feature" on page 21.
- \*\* Press the REC button twice within 5 seconds to record each audio/video source.

## Programming the remote control for use with your audio/video devices

### Device code setup

1. Refer to the Device code table on pages 22 – 23 to find the code for the brand of your device.  
If more than one number is listed, try each one separately until you find the one that works.
2. Press MODE until the Mode indicator of the device (CABLE/SAT, VCR, DVD, AUDIO1, AUDIO2) lights up.
3. While holding down the RECALL button, press the Channel Number buttons to enter the four-digit code of your brand of device. If a valid code is entered, the mode indicator will blink twice. If an invalid code is entered, the mode indicator will blink one long blink.
4. Point the remote control at the device and press POWER to test the code.  
If the device turns on, you have entered the correct code.  
If the device does not respond to the remote control, you may have entered the wrong code. Repeat steps 3 and 4 using another code.
5. Press MODE to select the TV mode to control the TV.

### Note:

- Every time you replace the batteries, you must reprogram the remote control.
- Some newer VCRs are capable of working on either of two remote codes. These VCRs have a switch labeled "VCR1/VCR2."

If your VCR has this kind of switch and does not respond to any of the codes for your VCR brand, set the switch to the other position (VCR1 or VCR2) and reprogram the remote control.

### Searching and sampling the code of a device (8500)

If you do not know the device code for a particular target unit, you can cycle the remote control through the available codes for that device mode and sample the functions to find the code that properly operates the target device. The keys available to be sampled, provided they are applicable to that mode, are POWER, 1, VOL ▲, CH ▲, and PLAY. Invalid keys will be ignored while in program mode.

To cycle through each available device code and sample its functions:

1. Press MODE to select the mode you want to set up.
2. While holding down the RECALL button, press 8 –5 –0 –0.  
The remote control will enter program mode.
3. Point the remote control at the target device and press POWER (or other function buttons that are available to be sampled).
4. If the device responds to the remote control:  
Press RECALL to store the device code.  
The mode indicator will blink twice and the remote control will exit the program mode.

If the device does not respond to the remote control:

- Press ▲, and then press POWER.  
Repeat this step until the device responds to the remote control, and then press RECALL.

**Note:** When a search cycle is completed, the mode indicator will blink three times. The remote control will begin to cycle through the available codes again. If no key is pressed within 10 seconds while programming, the remote control will exit the program mode and return to the previous code.

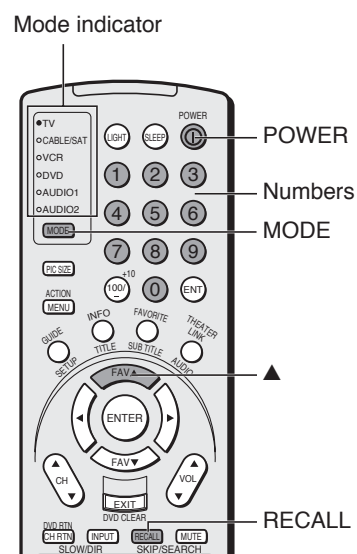

## Using the volume lock feature (8000)

For the TV, CABLE/SAT, VCR, and DVD modes, the volume controls (VOL ▲▼ and MUTE) can be programmed (locked) to the selected device mode. This feature does not apply to the AUDIO1/2 modes.

For example, to lock the volume controls to always jump to the CABLE/SAT mode:

1. Repeatedly press MODE to select the CABLE/SAT mode.
  2. While holding down the RECALL button, press 8 -0 -0 -0.
  3. Press VOL ▲.
- The Mode indicator will blink two times (locked).

The following table describes in more detail the Volume Lock implementation.

Volume Locked to	TV	CBL/SAT	VCR	DVD	AUD1	AUD2
TV (default)	TV	TV	TV	TV	AUD1	AUD2
CBL/SAT	CBL/SAT	CBL/SAT	CBL/SAT	CBL/SAT	AUD1	AUD2
VCR	VCR	VCR	VCR	VCR	AUD1	AUD2
DVD	DVD	DVD	DVD	DVD	AUD1	AUD2
AUD1	AUD1	AUD1	AUD1	AUD1	AUD1	AUD1
AUD2	AUD2	AUD2	AUD2	AUD2	AUD2	AUD2

To reset the volume controls to the original device code:

1. While holding down the RECALL button, press 8 -0 -0 -0.
  2. Press VOL ▼.
- The Mode indicator will blink four times (unlocked).

## Operational feature reset (8900)

This feature clears all setup features not related to “Device code set up” and resets the Volume Lock to “TV.”

To reset the features:

- While holding down the RECALL button, press 8 -9 -0 -0.  
The Mode indicator will blink two times, and then pause and blink two more times.

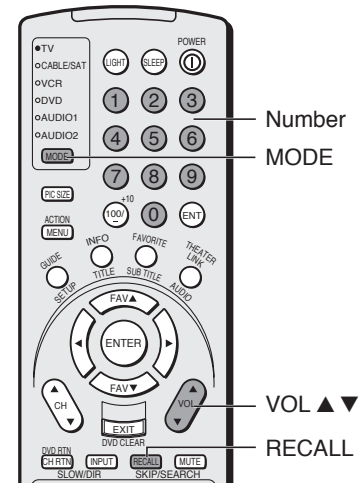

## Device code table

### VCR setup codes

Brand	Code
ADMIRAL	0135
AIWA	0127, 0132, 0181
AKAI	0129, 0114, 0115, 0116
AUDIO DYNAMIC	0139, 0111
BELL&HOWELL	0105, 0113
BROKSONIC	0120, 0126, 0180
CANON	0123, 0125
CCE	0143
CITIZEN	0106
CRAIG	0105, 0129, 0106
CURTIS MATHES	0145, 0124, 0127
DAEWOO	0143, 0101, 0124, 0175
DBX	0139, 0110, 0111
DIMENSIA	0145
EMERSON	0143, 0126, 0119, 0103, 0125, 0142, 0120, 0118
FISHER	0105, 0108, 0109, 0107, 0113, 0165
FUNAI	0127, 0126, 0120, 0134
GE	0133, 0145, 0124
GO VIDEO	0137, 0151, 0163, 0149, 0150, 0182
GOLDSTAR	0106
GRADIENTE	0170, 0171, 0168, 0134, 0156
HITACHI	0123, 0145, 0100, 0127, 0168
INSTANT REPLAY	0124, 0123
JENSEN	0139
JVC	0139, 0110, 0111, 0134, 0157, 0158, 0184, 0185
KENWOOD	0139, 0110, 0106, 0111
LG	0159
LXI	0127, 0106, 0100, 0107, 0108, 0105, 0109
MAGNAVOX	0131, 0123, 0124, 0173
MARANTZ	0139, 0110, 0111
MARTA	0106
MEMOREX	0124, 0109
MGA	0138, 0140, 0147, 0148, 0141, 0142
MINOLTA	0100, 0145
MITSUBISHI	0138, 0140, 0147, 0148, 0141, 0142, 0161, 0164
MULTITECH	0147, 0127, 0104
NEC	0139, 0110, 0111, 0134
OLYMPIC	0124, 0123
OPTIMUS	0128, 0121, 0135, 0106
ORION	0126, 0120, 0132
PANASONIC	0123, 0124, 0121, 0122
PENNEY	0124, 0100, 0145, 0105, 0139, 0110, 0111
PENTAX	0100, 0111, 0145

### Cable box setup codes

Brand	Code
ABC	1124
ARCHER	1132, 1125
CABLEVIEW	1105, 1132
CITIZEN	1122, 1105
CURTIS	1112, 1113
DIAMOND	1124, 1132, 1125
EAGLE	1129
EASTERN	1134
GCBRAND	1132, 1105
GEMINI	1122, 1143
G.I./JERROLD	1119, 1124, 1125, 1126, 1127, 1120, 1121, 1122, 1111, 1123, 1152
HAMLIN	1140, 1141, 1142, 1145, 1118, 1112
HITACHI	1103, 1124
MACOM	1103, 1104, 1105, 1108
MAGNAVOX	1133
MEMOREX	1130
MOVIE TIME	1132, 1105
OAK	1139, 1137, 1102
PANASONIC	1109, 1110, 1114, 1151, 1153
PHILIPS	1128, 1129, 1130, 1106, 1107, 1150, 1131
PIONEER	1101, 1116
PULSAR	1105, 1132
PUSER	1132
RCA	1115
REALISTIC	1132
REGAL	1112, 1118, 1140, 1141, 1142, 1145, 1149
REGENCY	1134
REMBRANT	1137, 1132, 1105, 1138
SAMSUNG	1105
S.A.	1111, 1112, 1113
SLMARK	1105, 1101
SPRUCER	1105, 1110
STARGATE	1132, 1105
TELECATION	1148
TELEVIEW	1101, 1105
TEXSCAN	1144
TOCOM	1135, 1136, 1147
TOSHIBA	1104, 1146
UNIKA	1132, 1125
UNIVERSAL	1122, 1132
VIDEOWAY	1106
VIEWSTAR	1129, 1130
ZENITH	1117, 1100
ZENITH/DRAKE	
SATELLITE	1100
PHILCO	0131, 0124, 0127, 0123, 0126, 0120, 0143
PHILIPS	0131, 0123, 0124, 0173
PIONEER	0123
PROSCAN	0145, 0100, 0123, 0124, 0131, 0146, 0101, 0102, 0133, 0174
QUASAR	0121, 0122, 0123, 0124
RADIO SHACK	0133, 0124, 0105, 0136, 0109, 0140, 0127
RCA	0133, 0145, 0100, 0123, 0124, 0131, 0146, 0101, 0102, 0170, 0172, 0174, 0176, 0183
REALISTIC	0124, 0105, 0136, 0109, 0140, 0127
SAMSUNG	0137, 0102, 0104, 0133
SAMTRON	0163
SANSUI	0139, 0126, 0120, 0152
SANYO	0105, 0109, 0113
SCOTT	0101, 0102, 0104, 0109, 0138, 0140, 0147, 0148, 0126, 0120
SEARS	0105, 0106, 0107, 0108, 0100
SHARP	0135, 0136, 0167, 0162
SHINTOM	0117
SIGNATURE 2000	0127, 0135
SINGER	0117
SONY	0128, 0129, 0130, 0153, 0154, 0155
SV2000	0127
SYLVANIA	0131, 0123, 0124, 0127, 0178
SYMPHONIC	0127, 0168, 0177
TASHIRO	0106
TATUNG	0139, 0110, 0111
TEAC	0139, 0110, 0127, 0111
TECHNICS	0121, 0122, 0123, 0124
TEKNICA	0124, 0127, 0112
THOMSON	0179, 0183
TOSHIBA	0101, 0146, 0166, 0160
VECTOR RESEARCH	0111
WARDS	0135, 0136, 0109, 0144, 0106
YAMAHA	0105, 0139, 0110, 0111
ZENITH	0144, 0106, 0169, 0180

## Device code table

### CD Player setup codes

Brand	Code
ADMIRAL	6126
AIWA	6133, 6135
CARVER	6129
DENON	6142, 6151
EMERSON	6139
FISHER	6105, 6106
GARRARD	6117
HARMAN KARDON	6120, 6121, 6123, 6119
HITACHI	6107
JENSEN	6134
JVC	6140, 6141, 6145, 6148, 6151
KENWOOD	6100, 6101, 6111, 6145
LXI	6136
MAGNAVOX	6129, 6132
MARANTZ	6129
MCINTOSH	6121
NAKAMICHI	6110
ONKYO	6114, 6115
OPTIMUS	6108, 6118, 6120, 6122
PANASONIC	6124, 6125, 6127, 6150
PHILIPS	6129, 6130, 6149
PIONEER	6108
QUASAR	6125, 6127, 6124
RCA	6147, 6137, 6138, 6131, 6152
SANSUI	6110, 6146, 6113
SANYO	6105
SCOTT	6110, 6146
SHARP	6142, 6143
SHERWOOD	6120
SONY	6128
SOUNDE-SIGH	6144
TEAC	6112, 6116, 6118
TECHNICS	6127, 6124, 6125
VICTOR	6140, 6141, 6145
YAMAHA	6102, 6103, 6104

### Receiver setup codes

Brand	Code
ADMIRAL	4120
AIWA	4125, 4126, 4146
DENON	4134, 4135, 4136, 4143
FISHER	4104
GARRARD	4113
HARMAN KARDON	4115, 4123, 4145
JENSEN	4129
JVC	4132, 4133, 4140, 4144
KENWOOD	4100, 4108, 4141, 4142, 4147
MAGNAVOX	4127, 4128
MARANTZ	4124
MCINTOSH	4116
MITSUBISHI	4148
NAKAMICHI	4106, 4117
ONKYO	4109, 4114
OPTIMUS	4103, 4127, 4131, 4130
PANASONIC	4119, 4118, 4121
PHILIPS	4123
PIONEER	4105, 4107, 4150

QUASAR	4119, 4118, 4121
RCA	4103, 4105, 4127, 4131, 4130, 4149
SANSUI	4103, 4111, 4139
SHARP	4134, 4137
SONY	4122
SOUNDE-SIGH	4138
TEAC	4112, 4113, 4111, 4110
TECHNICS	4121, 4118, 4119
VICTOR	4132, 4133
YAMAHA	4101, 4102

### Cassette Player setup codes

Brand	Code
AIWA	7123, 7124, 7125
DENON	7131
FISHER	7103
JENSEN	7114
JVC	7129, 7130, 7132, 7133
KENWOOD	7100, 7107
MARANTZ	7102
NAKAMICHI	7105
ONKYO	7108, 7109, 7113
PANASONIC	7116, 7118
PHILIPS	7122, 7121
PIONEER	7104, 7106
RCA	7126, 7127, 7128, 7134, 7135
SANSUI	7105, 7110, 7112
SHARP	7131
SONY	7119, 7120
TEAC	7110, 7111, 7115
TECHNICS	7116, 7118, 7117
YAMAHA	7101, 7102

### Laser Disc setup codes

Brand	Code
DENON	5114
HITACHI	5100
KENWOOD	5102, 5103
MAGNAVOX	5101
MARANTZ	5114
MITSUBISHI	5114, 5118, 5119
NEC	5114
PANASONIC	5104, 5105, 5106, 5115
PHILIPS	5111
PIONEER	5114
PROSCAN	5114
QUASAR	5104, 5105, 5106, 5115
RCA	5114
SAMSUNG	5112
SANYO	5114, 5117
SHARP	5113, 5116
SONY	5107, 5108, 5109, 5110
TEAC	5114
TOSHIBA	5114
YAMAHA	5101

### DVD setup codes

Brand	Code
AIWA	3123
APEX	3120
DENON	3100, 3117
FERGUSON	3101
HITACHI	3111
JVC	3109
KENWOOD	3115, 3129
KONKA	3119
MITSUBISHI	3105
NORDMENDE	3101
ONKYO	3121
ORITRON	3124
PANASONIC	3100
PHILIPS	3103, 3116
PIONEER	3102
RAITE	3113
RCA	3101, 3106
SABA	3101
SAMPO	3114
SAMSUNG	3110
SHARP	3108
SILVANIA	3132, 3118
SMC	3125
SONY	3104, 3126, 3127, 3128
TECHNICS	3100
THOMSON	3101
TOSHIBA	3103
WAVE	3122
YAMAHA	3100, 3130
ZENITH	3107, 3112
VIALTA	3131
FUNAI	3132, 3118

### Satellite Receiver setup codes

Brand	Code
DISH NETWORK (Echostar)	2105, 2115, 2116, 2117
ECHOSTAR	2105
EXPRESS VU	2105, 2115
G.E.	2106
G.I. (GENERAL INSTRUMENT)	2108
GRADIENTE	2114
HITACHI	2103, 2111, 2112
HNS (Hughes)	2103
MAGNAVOX	2101, 2102
PANASONIC	2104
PHILIPS	2101, 2102, 2118
PRIMESTAR	2108
PROSCAN	2106, 2109, 2110, 2113
RCA	2106, 2109, 2110, 2113
SONY	2107
STAR CHOICE	2103, 2108
TOSHIBA	2100, 2103, 2119, 2120, 2121
UNIDEN	2101, 2102

Introduction

Connecting your TV

Using the Remote Control

Setting up your TV

Using the TV's Features

Appendix

Index



## Learning about the remote control

The buttons used for operating the TV only are described here. For a complete list of the remote control's functions, see the "Remote Control functional key chart" on pages 18 – 19.

**POWER** turns the TV on and off.

Press **POWER** to turn the TV on. The Red LED indicator will be illuminated. Press **POWER** again to turn the TV off.

**Note:**

If the Quick Restart feature is in OFF mode, it can take up to several seconds for the picture to appear. See page 28 for details.

**SLEEP** allows access to the automatic TV shut-off function (page 52)

**LIGHT** The first press of the **LIGHT** button lights the keypad and turns on the Illumination mode. With the Illumination mode on, pressing any other key lights the keypad for 5 seconds (10 seconds if you're in programming mode). Subsequent presses of the **LIGHT** button toggle between turning the Illumination mode on and off.

**Channel Numbers (0-9, 100)** allow direct access to channels (page 28)

**MODE** cycles through the six device modes: TV, CABLE/SAT, VCR, DVD, AUDIO1, and AUDIO2. The mode indicator light will remain lit for a few seconds (page 20).

**PIC SIZE** cycles through the five pictures sizes: Natural, TheaterWide 1, 2, 3, and Full (page 32)

**FAVORITE** allows access to the favorite channel search function (page 39)

**MENU** allows access to on-screen programming menus (page 25)

**ENTER** sets programming menu information (page 25)

**▲▼◀▶** select or adjust programming menus (page 25)

**FAV ▲▼** cycles through favorite channels (page 30)

**CH ▲▼** cycles through programmed channels (page 27)

**VOL ▲▼** adjusts the volume level

**EXIT** exits the programming menus (page 25)

**INPUT** selects the video input source (page 50)

**MUTE** mutes the sound (page 54)

**RECALL** displays on-screen information (page 59)

**CH RTN** returns to the last viewed channels (page 29)

**POP CH ▲▼** selects the POP (picture-out-picture) channel (page 36)

**SPLIT** turns the POP feature on and off (page 36)

**CH SCAN** allows access to the programmed channel search function (page 38)

**FREEZE** freezes the picture. Press again to restore the picture.

**SWAP** switches the main and POP pictures (page 37)

**POP DIRECT CH** allows direct access to POP channels (page 36)

**SOURCE** selects the POP picture source (page 36)

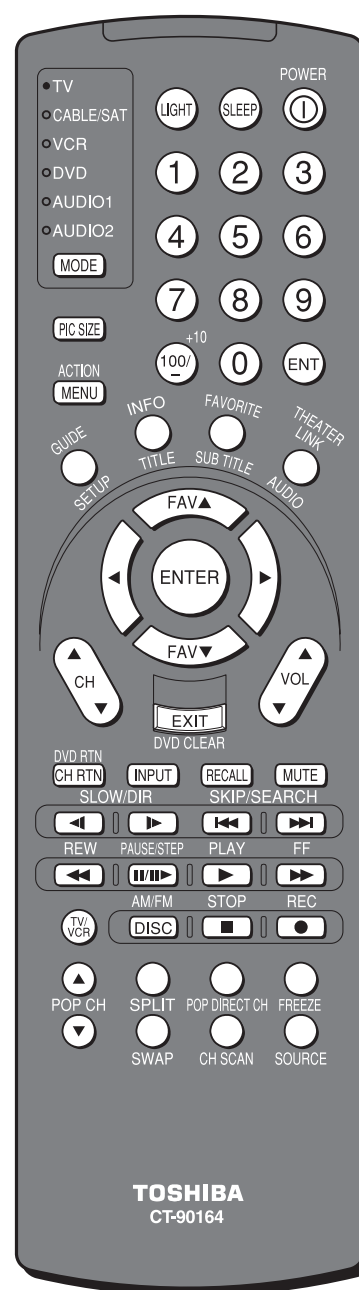

**Note:**

The error message "Not Available" will appear if you press a key for a function that is not available.

# Setting up your TV

## Learning about the menu system

After you have installed the batteries and programmed the remote control, you will need to set some preferences on the TV by using the menu system. You can access the menu system by using the control touchpad on the TV front or the remote control.

1. Press MENU to display the menu system.
2. Press ◀ or ▶ to select a menu.
3. Press ▲ or ▼ to select an item, then press ENTER.
4. Press ▲ or ▼ to select or adjust a setting.
5. Press ENTER to activate the settings.
6. To close the menu, press EXIT.

If you do not make a selection within 15 seconds, the menu display will disappear automatically.

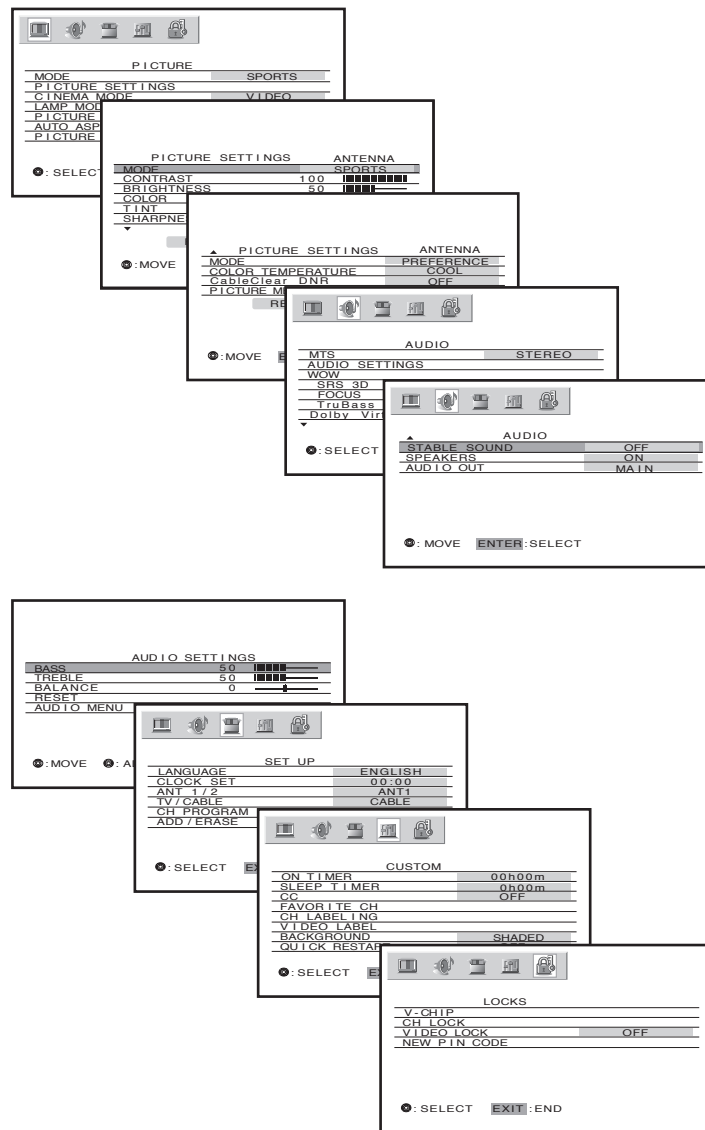

Control touchpad on TV front

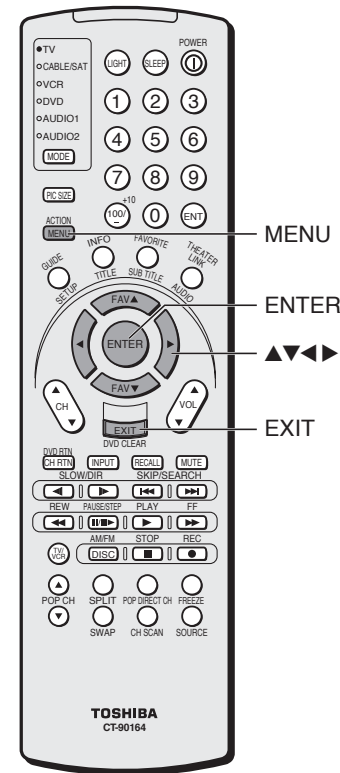
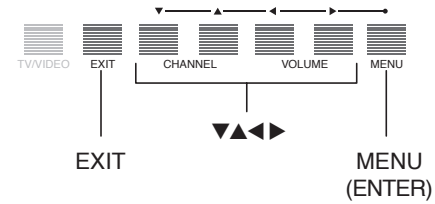

### Note:

You can change the background of the menu. See page 59 for details.

## Changing the on-screen display language

You can choose from three different languages (English, French and Spanish) for the on-screen display of adjustment menus and messages.

To select a language:

1. Press MENU, and then press ◀ or ▶ until the SET UP menu appears.
2. Press ▲ or ▼ to highlight LANGUAGE, and then press ENTER to display the pull-down menu.

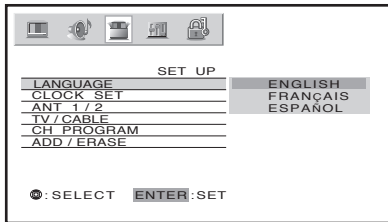

3. Press ▲ or ▼ to highlight your desired language.

## Selecting the antenna input

You can connect to two different antenna input sources (ANT 1 or ANT 2).

To select the antenna input using the menu system:

1. Press MENU, and then press ◀ or ▶ to highlight the SET UP menu.
2. Press ▲ or ▼ to highlight ANT 1/2, and then press ENTER to display the pull-down menu.

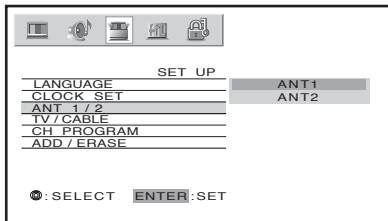

3. Press ▲ or ▼ to highlight either ANT 1 or ANT 2, depending on the antenna terminal you wish to use.

To select the antenna input using the INPUT or TV/VIDEO button:

1. Press the INPUT button on the remote control or TV/VIDEO on the TV. SOURCE SELECTION menu appears and the current signal source displays in purple.
2. Continue pressing the INPUT or TV/VIDEO button to select ANT 1 or ANT 2.

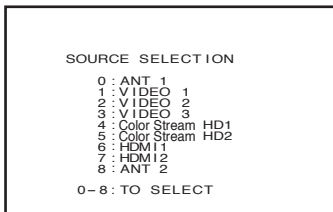

Pressing INPUT on the remote control displays the current signal source (press INPUT again or 0-8 to change)

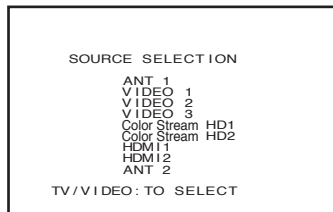

Pressing TV/VIDEO on the TV changes the current signal source

Control touchpad on TV front

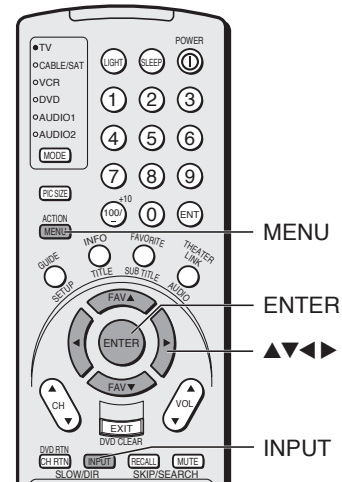
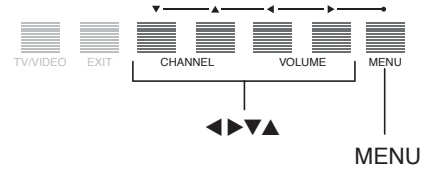

Control touchpad on TV front

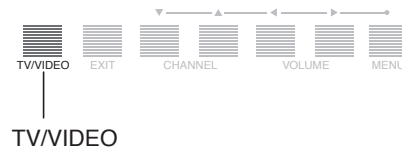

## Adding channels to the TV's memory

When you press Channel ▲ or ▼, your TV will stop only on the channels stored in the TV's channel memory.

Follow the steps below and on the next page to program all active channels into the TV's memory.

### Programming channels automatically

Your TV can automatically detect all active channels in your area and store them in its memory. After the channels are stored automatically, you can manually add or erase individual channels (see page 28).

To program channels automatically:

1. Press MENU, and then press ◀ or ▶ until the SET UP menu appears.
2. Press ▲ or ▼ until TV/CABLE is highlighted, and then press ENTER to display the pull-down menu.
3. Press ▲ or ▼ to highlight either TV or CABLE, depending on which you use. If you use an antenna, highlight TV; if you use cable channels, highlight CABLE.

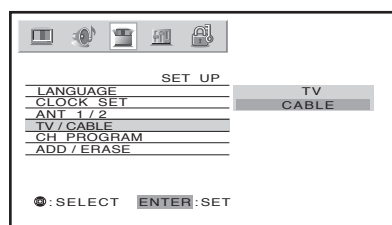

4. Press ENTER.
5. Press ▼ to select CH PROGRAM.

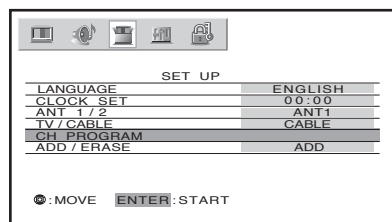

6. Press ENTER to start channel programming. The TV will automatically cycle through all the TV or Cable channels (depending on which you selected), and store all active channels in the channel memory.

While the TV is cycling through the channels, the message "Programming Now—Please Wait" appears.

7. When channel programming is complete, the message "Completed" appears.
8. Press Channel ▲ or ▼ to view the programmed channels.

### Note:

To tune the TV to a channel not programmed in the channel memory, you must use the Channel Number buttons on the remote control.

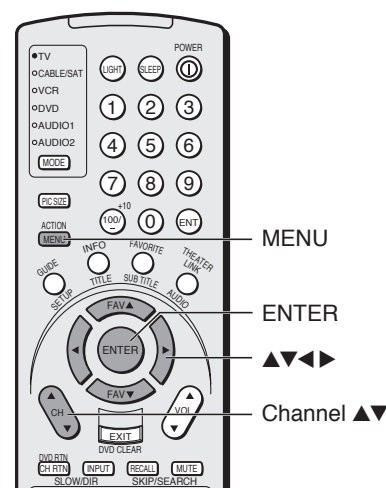

## Adding and erasing channels manually

After you have programmed the channels automatically, you can manually add or erase specific channels.

To add or erase channels:

1. Select the channel you want to add or erase. If you are adding a channel, you must select the channel using the Channel Number buttons.
2. Press MENU, and then press ◀ or ▶ until the SET UP menu appears.
3. Press ▲ or ▼ to highlight ADD/ERASE, and then press ENTER to display the pull-down menu.

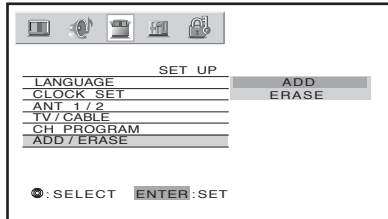

4. Press ▲ or ▼ to select ADD or ERASE, depending on the function you want to perform.
5. Repeat steps 1–4 for other channels you want to add or erase.

## Changing channels

To change to a specific channel (programmed or unprogrammed):

Press the Channel Number buttons (0–9 and 100).

For channels 100 and higher, press the 100 button, and then the next two numbers. For example, to select channel 125, press 100, 2, 5.

To change to the next programmed channel:

Press Channel ▲ or ▼ on the TV or remote control.

## Selecting the Quick Restart

With the Quick Restart feature set to ON, the TV stays in the standby mode for several minutes after the TV is turned off.

If the TV is turned on from the standby mode, the full picture appears immediately.

1. Press MENU, and then press ◀ or ▶ until the CUSTOM menu appears.
2. Press ▲ or ▼ to highlight QUICK RESTART, and then press ENTER.
3. Press ▲ or ▼ to select ON or OFF, and then press ENTER.

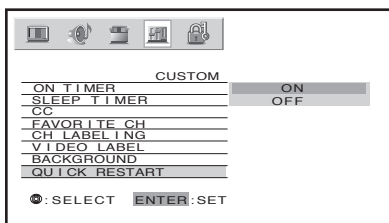

Control touchpad on TV front

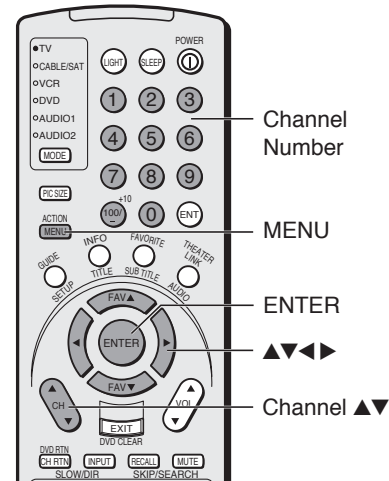
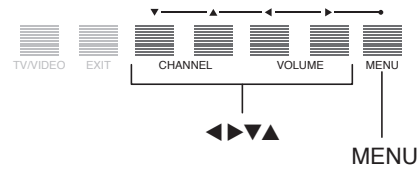

### Note:

If Quick Restart is set to OFF and you turn off the TV, it can take up to several seconds for the picture to appear when you turn on the TV again.

If Quick Restart is set to ON and you turn off the TV, the following will occur for a few minutes:

- The screen (lamp) lights dimly.
- The fans continue to run.

This is a function of the Quick Restart standby mode and is not a TV malfunction. If you do not prefer this, set the Quick Restart feature to OFF.

When the Quick Restart feature is set to OFF, if you repeatedly turn the TV on and off in a short period of time, the useful service life for the lamp may be shorter than the average useful service life. See page 60.

## Using the TV's features

### Adjusting the channel settings

#### Switching between two channels using Channel Return

The Channel Return feature allows you to switch between two channels without entering an actual channel number each time.

1. Select the first channel (or video mode) you want to view.
2. Select a second channel using the Channel Number buttons (0–9, 100).
3. Press CH RTN. The previous channel will display.

Each time you press CH RTN, the TV will switch back and forth between the last two channels that were selected.

#### Switching between two channels using SurfLock™

The SurfLock™ feature temporarily stores one channel in the CH RTN button, so you can return to that channel quickly from any other channel by pressing CH RTN.

To store a channel in the CH RTN button:

1. Tune the TV to the channel you want to store in the CH RTN button.
2. Press and hold CH RTN for about 2 seconds until the message "Channel Memorized" appears on the screen. The channel has been stored in the CH RTN button.
3. Continue to change channels until your desired channel is selected.
4. Press CH RTN. The stored channel will be selected.

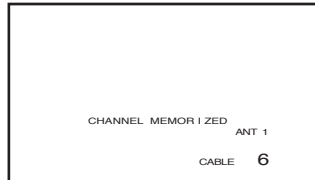

The TV will return to the stored channel one time only. Once you press CH RTN and then change channels again, the CH RTN button memory will be cleared and the button will function as Channel Return, by switching back and forth between the last two channels that were selected.

#### Programming your favorite channels

You can preset up to 12 of your favorite channels using the Favorite Channel Programming feature. Because this feature scans through only your favorite channels, it allows you to skip other channels you do not normally watch.

To program your favorite channels:

1. Press MENU, and then press ◀ or ▶ until the CUSTOM menu appears.
2. Press ▲ or ▼ to highlight FAVORITE CH.

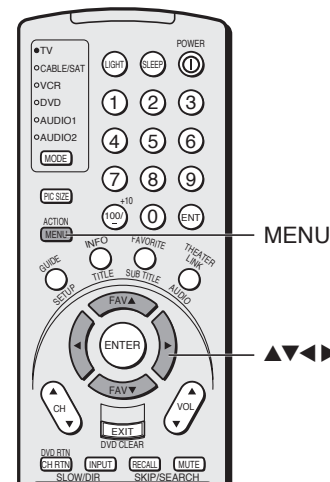
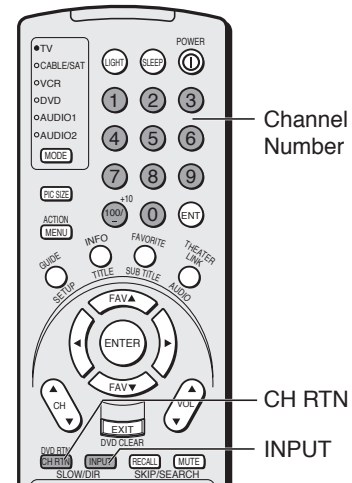
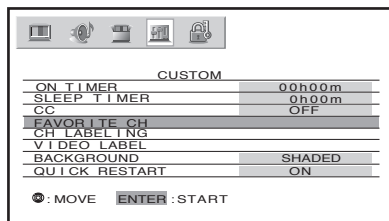

(continued on next page)



- Press ENTER to display the FAVORITE CH menu. CH INPUT will be highlighted.

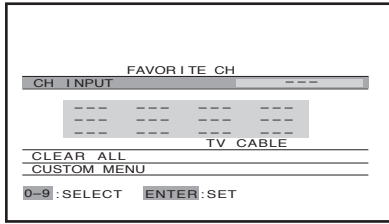

- Press the Channel Number buttons to enter one of your favorite channels.
- Press ENTER.
- Repeat steps 4 and 5 for your other favorite channels.

To select your favorite channels:

Press FAV ▼ or ▲.

To quickly scan through your favorite channels in a twelve-picture multi-window:

Press FAVORITE (see page 39 for details).

To clear a favorite channel:

- Press MENU, and then press ◀ or ▶ until the CUSTOM menu appears.
- Press ▲ or ▼ to highlight FAVORITE CH.
- Press ENTER to display the FAVORITE CH menu.
- Press ▲▼◀▶ to highlight the channel you want to clear, then press ENTER.

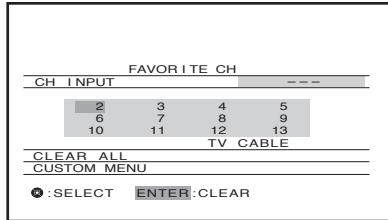
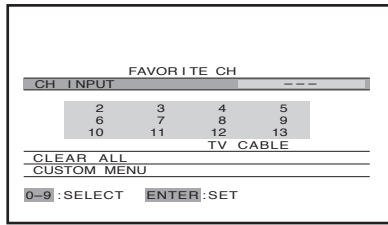

- Repeat step 4 for other favorite channels you want to clear.

To clear all favorite channels at once:

Press ▲ or ▼ to highlight CLEAR ALL in step 4 above, and then press ENTER to clear all favorite channels at once.

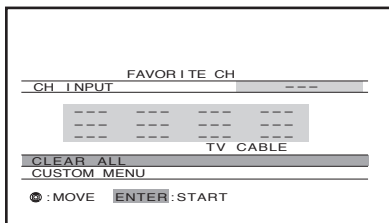

**Note:**

- The FAV ▼▲ buttons operate as MENU ▼▲ buttons when a menu is on-screen.
- The favorite channel feature is not available in ANT2 mode.

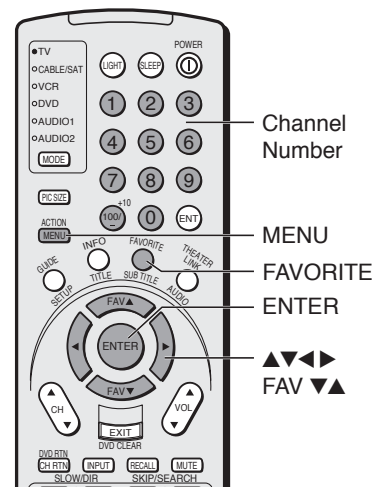

## Labeling channels

Channel labels appear above the on-screen channel number display each time you turn on the TV, change a channel, or press RECALL. You can choose any four characters to identify a channel.

To create channel labels:

1. Press MENU, and then press ◀ or ▶ until the CUSTOM menu appears.
2. Press ▲ or ▼ to highlight CH LABELING.
3. Press ENTER to display the CH LABELING menu. CH INPUT will be highlighted.

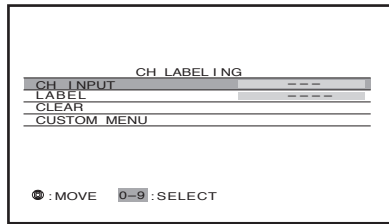

4. Press the Channel Number buttons to select a channel you want to label.
5. Press ▼ to highlight LABEL.
6. Press ◀ or ▶ repeatedly to select a character for the first space, and then press ENTER.

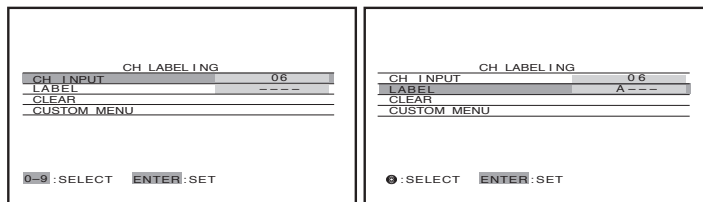

7. Repeat step 6 to enter the rest of the characters. If you would like a blank space in the label name, you must choose an empty space from the list of characters. Otherwise, a dash “-” will appear in that space.
8. Repeat steps 4–7 to label other channels. You can assign labels to a maximum of 32 channels.

To erase channel labels:

1. Press MENU, and then press ◀ or ▶ until the CUSTOM menu appears.
2. Press ▲ or ▼ to highlight CH LABELING.
3. Press ENTER to display the CH LABELING menu.
4. Press ▼ to highlight CH INPUT, then select the channel you want to clear with the Channel Number buttons.
5. Press ▼ or ▲ to highlight CLEAR.
6. Press ENTER to erase the channel label.
7. Repeat steps 4–6 to erase other channel labels.

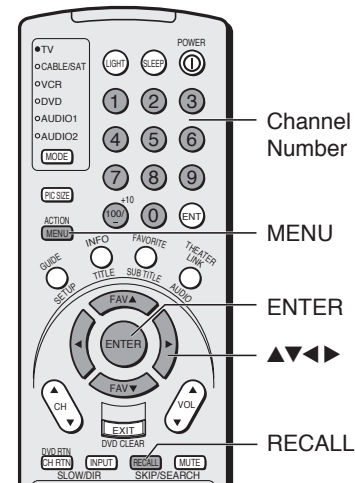
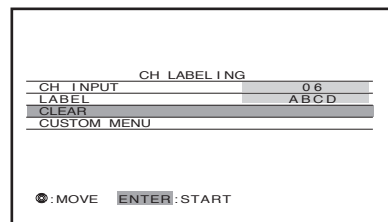

## Viewing the wide-screen picture formats (480i, 480p, and 1080i signals only)

You can view 480i, 480p, and 1080i format programs in a variety of picture sizes—Natural, TheaterWide 1, TheaterWide 2, TheaterWide 3, and Full. (The Full picture size is not selectable for 1080i format programs.)

The way the image displays in any of the picture sizes will vary depending on the format of the program you are viewing. Select the picture size that displays the current program the way that looks best to you.

### Selecting the picture size

1. Press PIC SIZE on the remote control.
2. Press the corresponding number button (0-4) to select the desired picture size, as described below and on the next page.

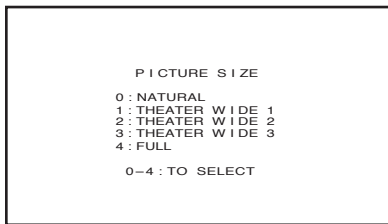

### Natural picture size

- The image is displayed close to its originally formatted proportion. Some program formats will display with side bars and/or bars at the top and bottom.

Natural picture size example: The way the image displays will vary depending on the format of the program you are currently watching.

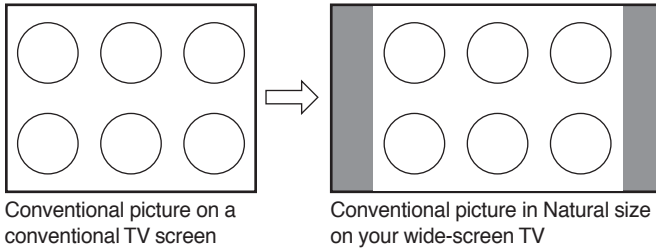

(continued on next page)

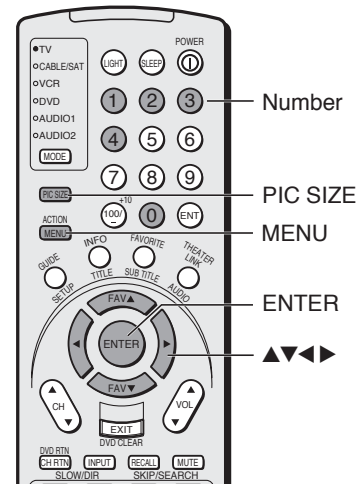

### Note:

You also can change the picture size by selecting PICTURE SIZE in the PICTURE menu.

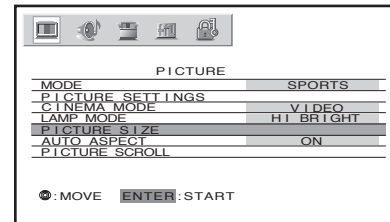

### TheaterWide 1 picture size (For 4:3 format programs)

- The picture is non-uniformly enlarged—the center of the picture remains close to its original proportion, but the left and right edges are stretched wider to fill the screen.
- A small part of the picture at the top and bottom is hidden; however, this mode cannot be scrolled.

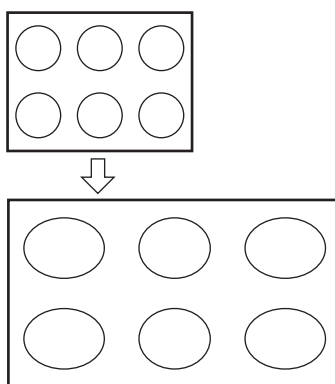

TheaterWide 1 picture size example

#### Note:

- To select the picture size, press **PIC SIZE** on the remote control or select **PICTURE SIZE** in the **PICTURE** menu.
- The **PICTURE SIZE** feature is not available for some program formats (such as 720p). Such formats will display in **Natural** picture size (see page 32).
- If you select **TheaterWide 2** or **3**, the top and bottom edges of the picture may be hidden. To see the hidden edges, either scroll the picture (see page 34) or try viewing the program in **Full** picture size.

### TheaterWide 2 picture size (For Letter box programs)

- The entire picture is uniformly enlarged—it is stretched the same amount both wider and taller (retains its original proportion).
- Part of the picture at the top and bottom is hidden. To view the hidden areas, see “Scrolling the TheaterWide picture” on page 34.

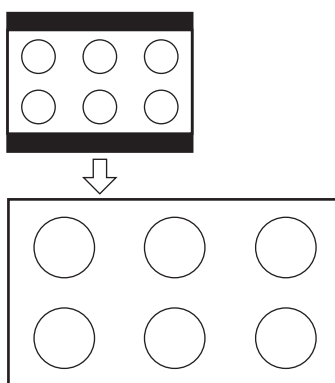

TheaterWide 2 picture size example

### TheaterWide 3 picture size (For Letter box programs with subtitles)

- The picture is non-uniformly enlarged—it is stretched wider to fill the width of the screen, but only slightly stretched taller.
- A small part of the picture at the top and bottom is hidden. To view the hidden areas (such as subtitles or captions), see “Scrolling the TheaterWide picture” on page 34.

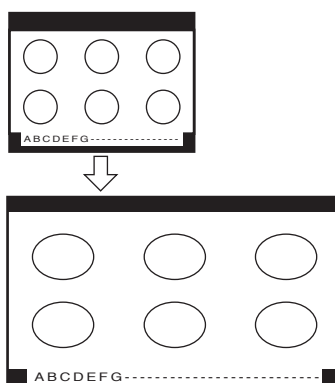

TheaterWide 3 picture size example

#### Note:

Using these functions to change the picture size (i.e., changing the height/width ratio) for any purpose other than your private viewing may be prohibited under the Copyright Laws of the United States and other countries, and may subject you to civil and criminal liability.

### Full picture size (For 16:9 format programs)

- The picture is non-uniformly enlarged. If you are receiving a 4:3 format program, it is stretched wider to fill the width of the screen, but not stretched taller.
- None of the picture is hidden.

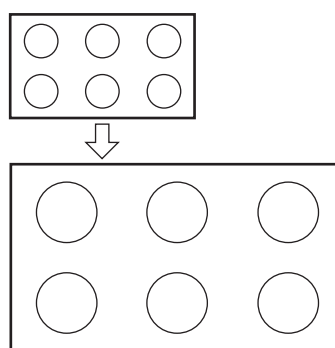

Full picture size example

## Scrolling the TheaterWide® picture (TheaterWide 2 and 3 only)

1. Press PIC SIZE to select the TheaterWide 2 or 3 mode.
2. Press MENU, and then press ◀ or ▶ until PICTURE menu appears.
3. Press ▲ or ▼ to highlight PICTURE SCROLL.

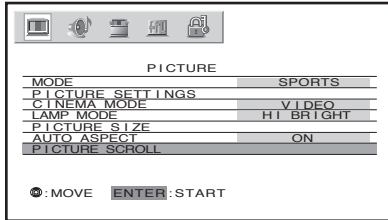

4. Press ENTER to display the Scroll Adjustment mode.

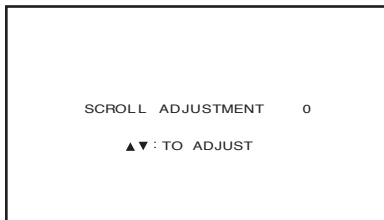

5. Press ▲ or ▼ to adjust the vertical position of the picture.

- Normal (center) position

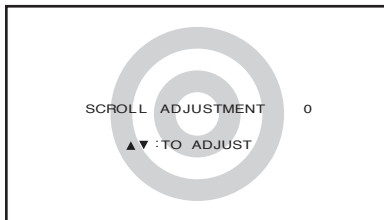

- To raise the picture, press ▲.

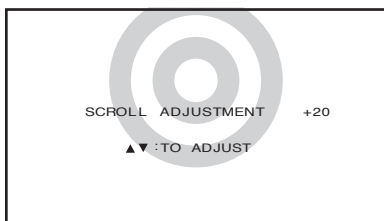

- To lower the picture, press ▼.

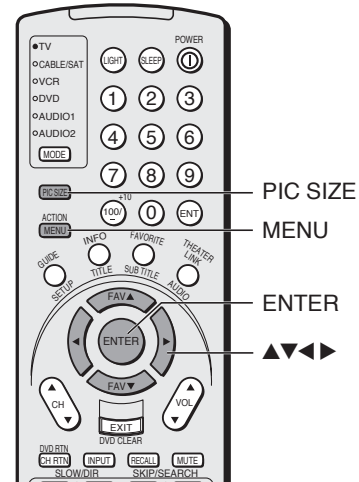
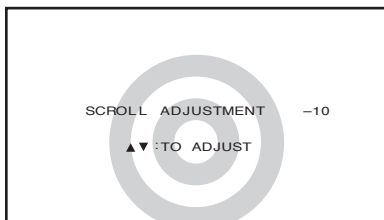

### Note:

You can scroll the picture in TheaterWide 2 and TheaterWide 3 only. The scroll amounts are as follows:

- 480i/480p/1080i signal source:
  - TheaterWide 1: Not adjustable
  - TheaterWide 2: -10 to +20
  - TheaterWide 3: -10 to +20

## Using the AUTO ASPECT feature

When the AUTO ASPECT feature is set to ON and the TV receives a 480i signal, the picture size is automatically selected (as described in the following table).

Aspect ratio of signal source	Automatic aspect size (automatically selected when AUTO ASPECT is ON)
4:3 Normal	Natural
16:9 Full	Full
4:3 Letter box	TheaterWide 2
Not defined (no ID-1 data)*	User-set mode

\*If the signal does not include aspect information, the picture size you selected on pages 32–33 is displayed.

To turn on the AUTO ASPECT feature:

1. Press MENU, and then press ◀ or ▶ until the PICTURE menu appears.

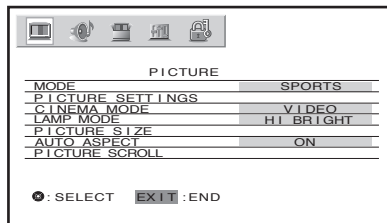

2. Press ▲ or ▼ to highlight AUTO ASPECT, and then press ENTER.

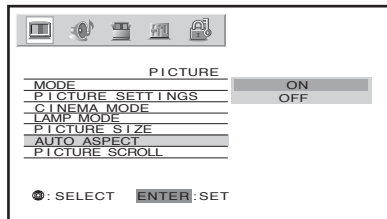

3. Press ▲ or ▼ to select ON, and then press ENTER.

### Note:

The AUTO ASPECT feature is available for additional formats when viewing HDMI sources because AUTO ASPECT operates based on information found in the digital HDMI signal (not ID-1 signal).

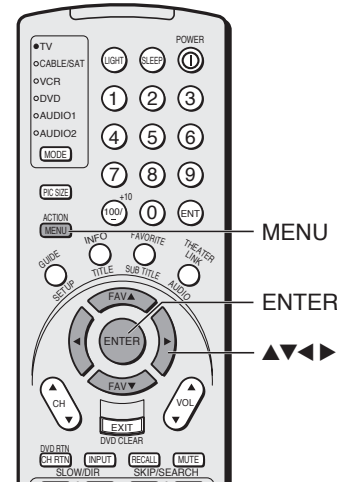



## Using the POP double-window feature

The POP (picture-out-picture) feature splits the screen into a double window that allows you to watch two programs at the same time. The POP program can come from a TV broadcast or an external source, such as a VCR.

To display a TV broadcast in the POP window:

1. Press SPLIT to display the POP window.

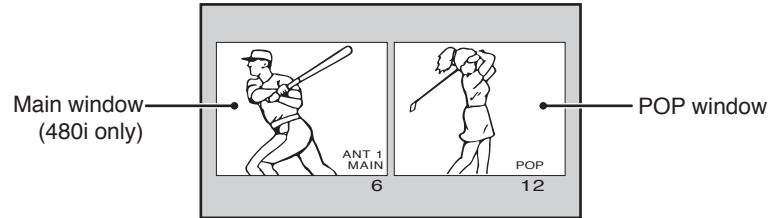

2. Select POP channels in the following two ways:

- To change to a specific channel, press POP DIRECT CH. While "POP" is on the screen, press the Channel Number buttons (0–9 and 100).
- To change to the next programmed channel, press POP CH ▼▲.

If the V-CHIP feature is active and you try to watch a TV program that exceeds your set rating limits, the program will be blocked (see "Using the V-CHIP menu" on page 40).

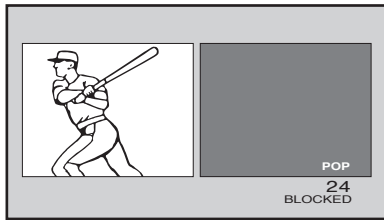

To display a picture from an external source in the POP window:

1. Connect the external source equipment (see "Connecting your TV" on page 8).
2. Select the TV program you want to watch in the main window.
3. Press SPLIT to display the POP window.
4. Repeatedly press SOURCE to select the input source for the POP window (VIDEO 1, VIDEO 2, VIDEO 3, ColorStream HD1, ColorStream HD2, HDMI1 or HDMI2). The current source will display in purple.

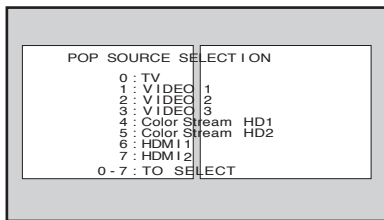

While the above menu is on the screen, you can select the desired signal input source by pressing the corresponding number button (0–7).

To close the POP window:

Press SPLIT again or EXIT.

### Note:

- The SPLIT buttons on the remote control operate the TV's POP features.
- You can display only 480i format program in the main window. Only the audio signal is output.
- You cannot display the ANT-2 signal source in the POP window.
- You can choose to output the sound of either the main or POP program through the AUDIO OUT jacks (see "Selecting the AUDIO OUT sound" on page 58).
- You can choose to hear either the main or POP audio through the TV speakers. (See "Switching the speaker audio (main or POP)" on page 37.)
- HDMI, 720p ColorStream, 480p ColorStream, and 1080i ColorStream signals will only display in the POP (right) window. These signals will not display in the main (left) window when the TV is in double-window mode.
- If an HDMI or ColorStream source is being viewed when you open the POP double-window feature, the HDMI or ColorStream source will default to the POP (right) window.

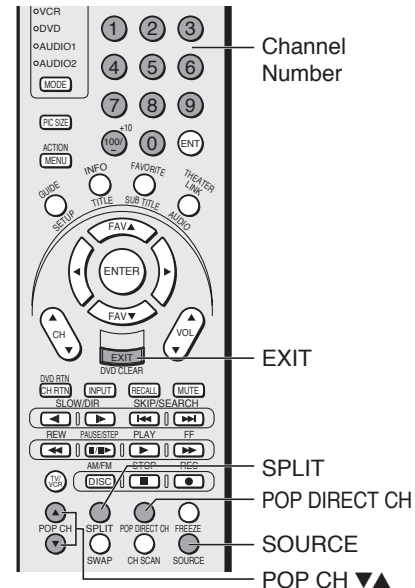

## Switching the main and POP pictures

Press SWAP while you are using the POP feature to switch the main and POP pictures.

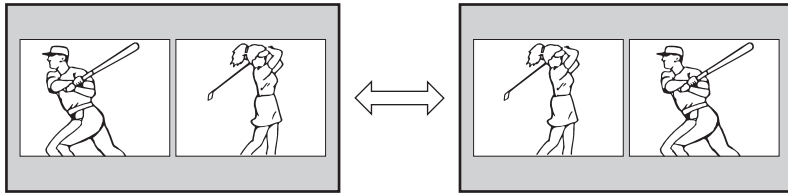

## Switching the speaker audio (main or POP)

Press ◀ or ▶ while you are using the POP feature to switch the sound (main or POP) from the speakers. The POP sound in the TV mode is monaural only.

The selected audio source indicator is displayed in purple.

Example: Press ◀

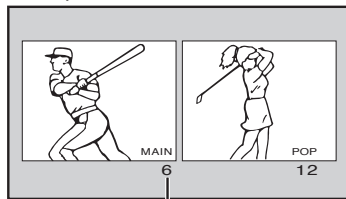

purple

Example: Press ▶

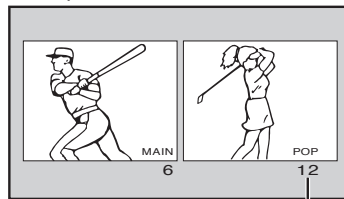

purple

### Note:

- If the POP program is not 480i format, it will not display in the main window when you press SWAP.
- The SAP channel will not be decoded when the speaker source is switched to POP. Even if SAP is selected in the menu (page 54), the main audio channel will be heard when the speaker sound is switched to POP.
- The VARIABLE AUDIO OUT jacks will switch with the speaker sound; however, the source of the regular AUDIO OUT jacks is determined by the AUDIO OUT menu setting (page 58). The regular AUDIO OUT jacks do not switch with the speaker sound.

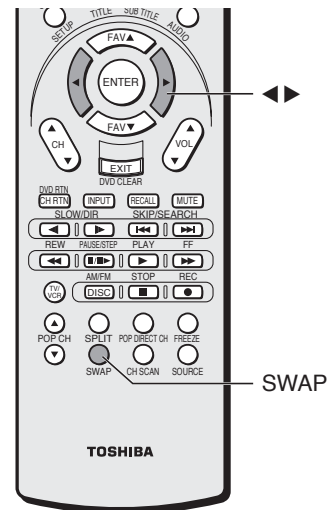

## Double-Window aspect ratio

The Double-Window feature displays each picture according to its input signal aspect ratio, as illustrated below.

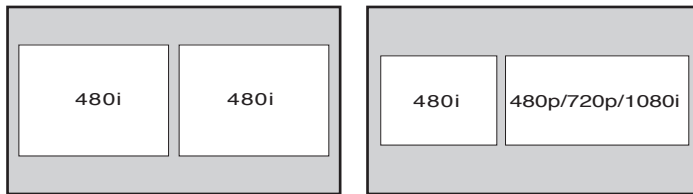

## Using the programmed channel search function

You can use the programmed channel search function to quickly scan the channels you programmed into the TV's memory (page 27).

1. Press CH SCAN.  
The TV automatically enters multi-window mode, and begins a twelve-picture scan of your programmed channels in the multi-window.

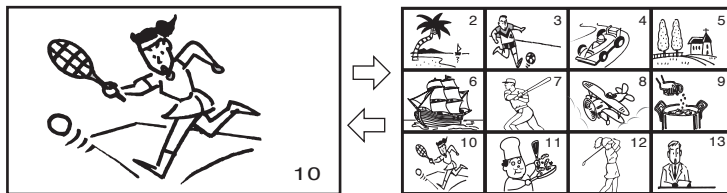

2. Press the Channel Number buttons to select one of the twelve pictures.

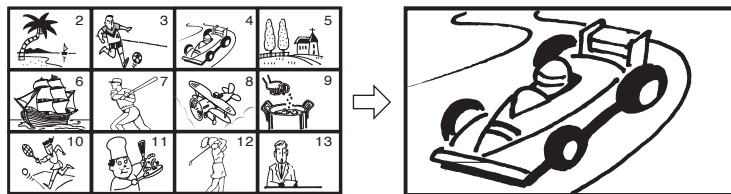

### Note:

- The AUTO ASPECT feature (page 35) does not operate in double-window mode.
- Aspect ratio is the ratio of width to height of the picture.



### Note:

During the programmed channel search, the multi-window pictures display in 4:3 aspect ratio, regardless of the signal format. The sound is not output.

## Using the favorite channel search function

You can use the favorite channel search function to quickly scan your favorite channels (see “Programming your favorite channels” on page 29).

1. Press FAVORITE.  
The TV automatically enters multi-window mode, and begins a twelve-picture scan of your favorite channels in the multi-window. (Press FAVORITE again to return to a normal picture.)

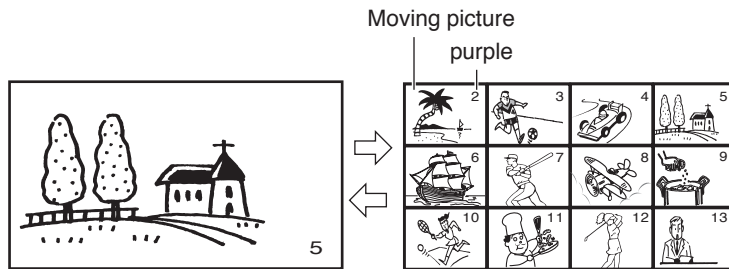

2. Press ▲▼◀▶ to select one of the twelve pictures (becomes a moving picture). The selected channel number is in purple and the monaural sound of the selected channel is output.
3. Press ENTER to display the channel you selected in step 2 as a normal picture.

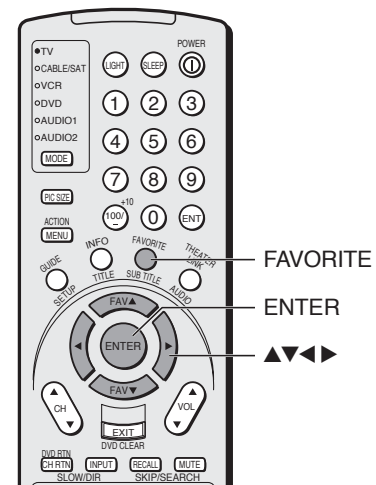
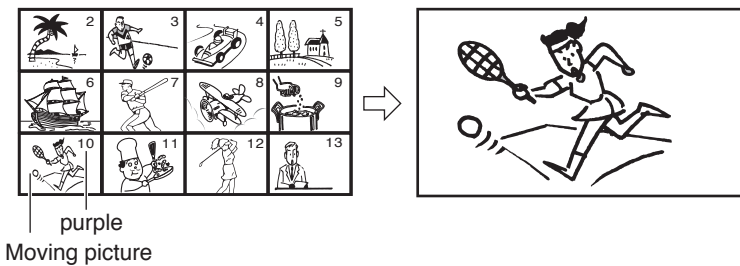

## About the auto favorite feature

If your TV is in the program lock mode (page 43), after 4 seconds the TV starts the auto favorite channel search function.



## Using the LOCKS menu

The LOCKS menu includes the V-Chip, CH Lock, Video Lock, and New PIN Code functions. You can use these functions after entering the correct PIN code.

### Entering the PIN code

1. Press MENU, and then press ◀ or ▶ until the LOCKS menu appears.

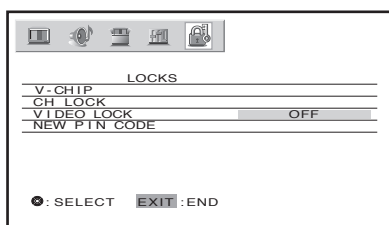

2. Press ▲ or ▼ to display the PIN code entering mode.
  - Blocking Reset status: Set a new 4-digit code by pressing the Number buttons (0–9).
  - When the PIN code is already stored: Press the Number buttons (0–9) to enter your 4-digit PIN code.

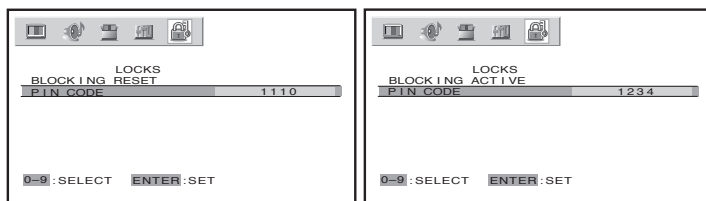

If the wrong PIN code is entered, the message “Incorrect” appears. Enter the code again, and then press ENTER.

### If you cannot remember your PIN code

1. While the PIN code entering screen is displayed, press RECALL four times within five seconds. The PIN code will be released (Blocking Reset status restored).
2. Enter a new 4-digit code, and then press ENTER. The LOCKS menu appears.

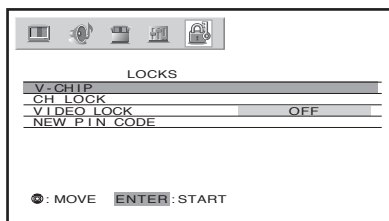

Continue to set each item following the steps on pages 41.

## Using the V-CHIP menu

Some TV programs and movies include signals that classify the content of the program (violence, sex, dialog, language). The V-CHIP control feature in this TV detects the signals and blocks the programs according to your selections. To use this feature, perform the following setup.

### Note:

The V-Chip function is available for the U.S. V-Chip system only. The Canadian V-Chip system is not supported.

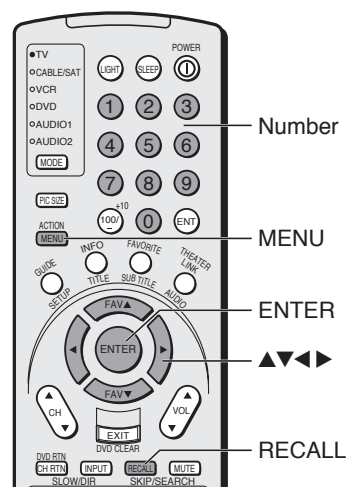

## ENABLE BLOCKING

- From the LOCKS menu, press ▼ or ▲ to highlight V-CHIP, and then press ENTER.

The V-CHIP menu appears.

- Press ▼ or ▲ to highlight ENABLE BLOCKING, and then press ENTER.

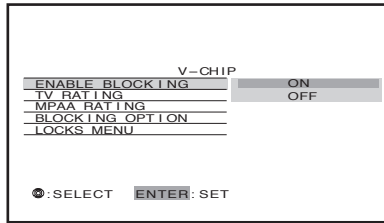

- Press ▲ or ▼ to select ON or OFF.  
ON : To enable your setting (Lock)  
OFF: To release your setting (Unlock)

**Note:** The CH LOCK function is not affected by this setting.

## TV RATING (Independent rating system for broadcasters)

- From the V-CHIP menu, press ▼ or ▲ to highlight TV RATING, and then press ENTER.

The TV RATING menu appears.

- Press ▼ or ▲ to select an item.
- Press ► to lock (displays "X").  
Press ◀ to unlock (displays "✓").
- Repeat steps 2 and 3 to set the next item.

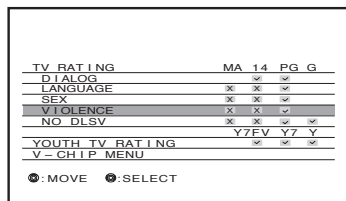

The TV age-based ratings and content themes you can lock are listed in the table below.

Ratings	Description and Content themes
MA	Mature Audience Only (This program is specifically designed to be viewed by adults and therefore may be unsuitable for children under 17.) <b>L) Crude or indecent language S) Explicit sexual activity V) Graphic violence</b>
14	Parents Strongly Cautioned (This program contains some material that many parents would find unsuitable for children under 14 years of age.) <b>D) Intensely suggestive dialog L) Strong, coarse language S) Intense sexual situations V) Intense violence</b>
PG	Parental Guidance Suggested (This program contains material that parents may find unsuitable for younger children.) <b>D) Some suggestive dialog L) Infrequent coarse language S) Some sexual situations V) Moderate violence</b>
G	General Audience (Most parents would find this program suitable for all ages.)
Y7, Y7FV	Directed to Older Children (This program is designed for children age 7 and above. Note: Programs in which fantasy violence may be more intense or more combative than other programs in this category are designated Y7FV.)
Y	All Children (This program is designed to be appropriate for all children.)

## LOCKS menu

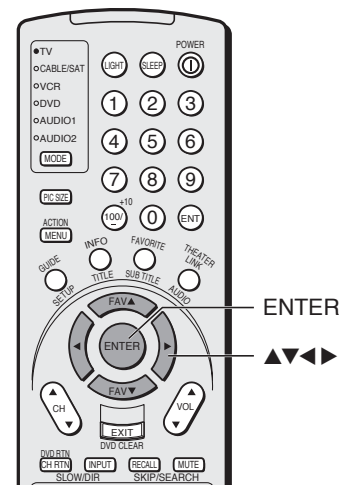
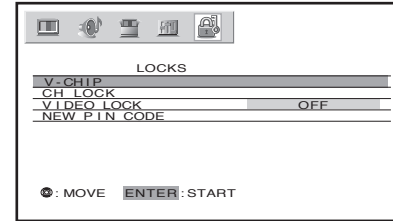

Press RECALL to display the rating of the TV program you are currently watching.

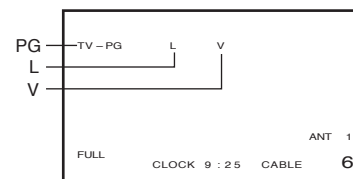



## MPAA RATING (Independent rating system for movies)

- From the V-CHIP menu, press ▼ or ▲ to highlight MPAA RATING, and then press ENTER. MPAA RATING menu appears.
- Press ▲ or ▼ to highlight MPAA RATING.
- Press ► to lock ("X") or press ◀ to unlock ("✓").

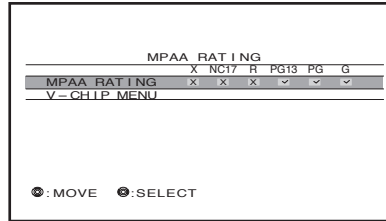

V-CHIP menu

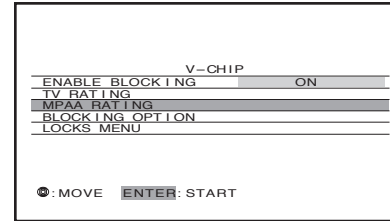

The movie ratings you can lock are described as follows:

- X : X-rated (For adults only)
- NC17: Not intended for anyone 17 and under
- R : Restricted (Under 17 requires accompanying parent or adult guardian.)
- PG13 : Parents Strongly Cautioned (Some material may be inappropriate for children under 13.)
- PG : Parental Guidance Suggested (Some material may not be suitable for children.)
- G : General Audience (Appropriate for all ages)

## BLOCKING OPTION

- From the V-CHIP menu, press ▼ or ▲ to highlight BLOCKING OPTION, and then press ENTER. The BLOCKING OPTION menu appears.
- Press ▲ or ▼ to select item.

### MPAA UNRATED :

- Highlight MPAA UNRATED, and then press ENTER.
- Press ▲ or ▼ to select ON (Lock) or OFF (Unlock) for unrated programs in the MPAA rating system, and then press ENTER.

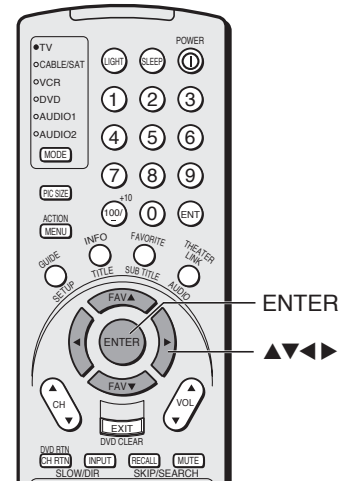
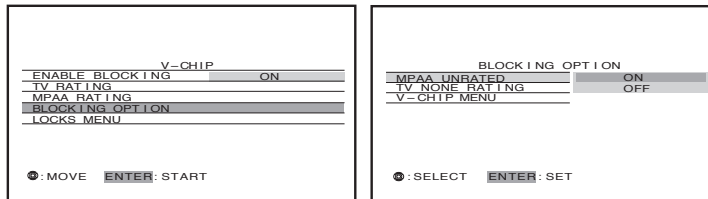

### TV NONE RATING :

- Highlight TV NONE RATING, and then press ENTER.
- Press ▲ or ▼ to select ON (Lock) or OFF (Unlock) for programs rated NONE in the TV PARENTAL GUIDELINES, then press ENTER.

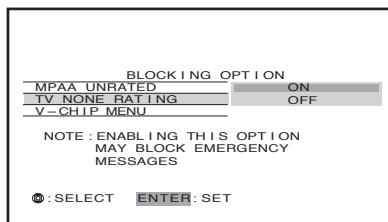

### Caution

Be aware that setting the TV None Rating to ON may block the broadcast of emergency information. The menu will display the note, "Enabling this option may block emergency messages" to warn you of this possibility.

### V-CHIP MENU :

Highlight V-CHIP MENU, then press ENTER to return to the V-CHIP menu.

## Unlocking programs temporarily

1. If you try to watch a TV program that exceeds the rating limits you set, the TV enters program lock mode. After 4 seconds, the TV starts the auto favorite channel search function (page 39). You can either unlock the program temporarily (see steps 2–4 below) or select a non-locked program to watch.

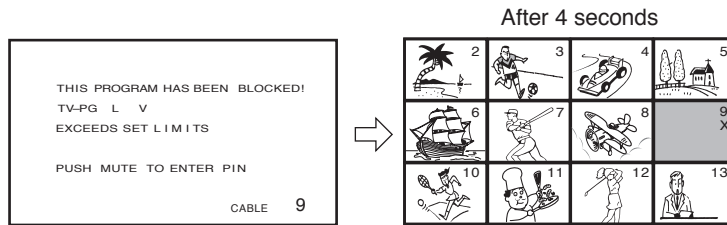

2. To temporarily unlock the program, press MUTE while the message is on the screen.
3. Press the Number buttons (0–9) to enter your 4-digit PIN code.

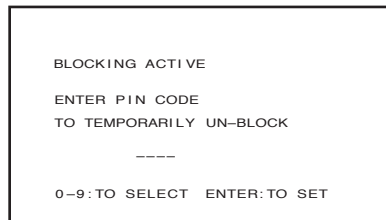

4. Press ENTER.  
If the correct code is entered, the program lock mode is released and the normal picture appears.  
All locking is disabled until the TV is turned off, and will be enabled when the TV is turned on again.

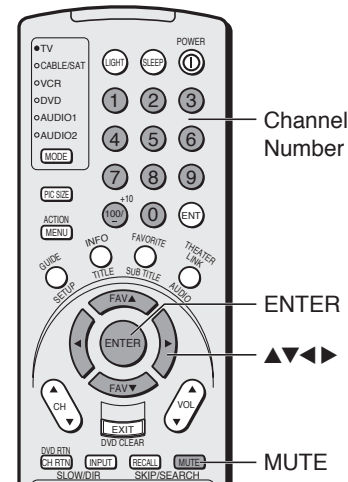

## Locking channels

With the CH LOCK feature, you can lock specific channels. The TV will not be able to tune locked channels with the Channel ▲▼ buttons or Channel Number buttons, unless you clear the setting.

You can lock a maximum of nine channels.

To lock channels:

1. From the LOCKS menu, press ▲ or ▼ to highlight CH LOCK, and then press ENTER.  
CH LOCK menu appears, and CH INPUT will be highlighted.
2. Press the Channel Number buttons to enter the channel you want to lock.
3. Press ENTER.

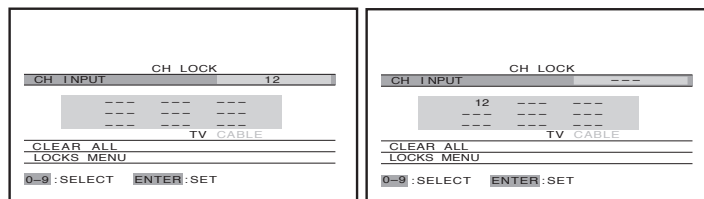

4. Repeat steps 2 and 3 for other channels.

### LOCKS menu

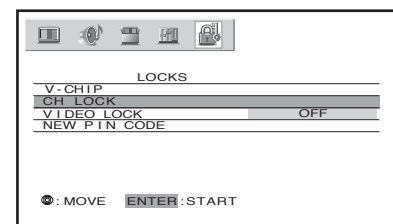

### Note:

After programming CH LOCK, change the channel before turning off the TV.

To unlock individual channels:

1. From the LOCKS menu, press ▲ or ▼ to highlight CH LOCK, then press ENTER.  
CH LOCK menu appears.
2. Press ▲▼◀▶ to highlight the channel you want to unlock, and then press ENTER.



3. Repeat step 2 for other channels.

To unlock all locked channels at once:

Press ▲ or ▼ to highlight CLEAR ALL, and then press ENTER.

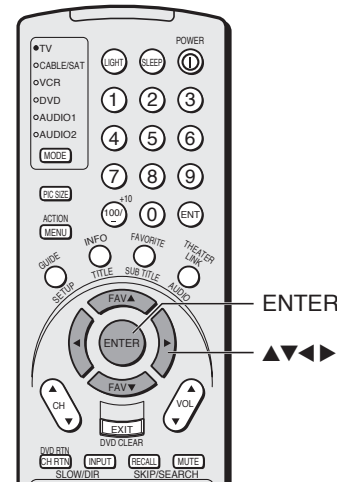
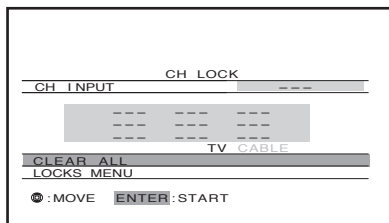

## Locking the video inputs

With the VIDEO LOCK feature, you can lock the input sources (Video 1, Video 2, Video 3, ColorStream HD1, ColorStream HD2, HDMI1, HDMI2) and channels 3 and 4.

You will not be able to select the input sources with the TV/VIDEO, INPUT, or Channel buttons unless you clear the setting.

To set up the video lock:

- From the LOCKS menu, press ▲ or ▼ to highlight VIDEO LOCK, then press ENTER.
- Press ▲ or ▼ to highlight the level of video locking you want (Video, Video+, or Off), as follows:  
 VIDEO : Locks Video 1, Video 2, Video 3, ColorStream HD1/HD2, HDMI1 and HDMI2.  
 VIDEO+ : Locks Video 1, Video 2, Video 3, ColorStream HD1/HD2, HDMI1, HDMI2 and channels 3 and 4.  
 This option should be used if you use the antenna terminal to play a video tape.

**Note:** Make sure the POP is not on channel 3 or 4.

OFF : Unlocks all video input sources.

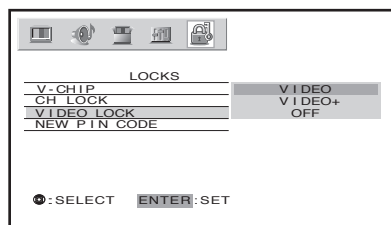

- Press ENTER.

## Changing the PIN code

- From the LOCKS menu, press ▲ or ▼ to highlight NEW PIN CODE.
- Press the Number buttons (0–9) to enter a 4-digit code. The numbers you enter will replace the dashes in the display.

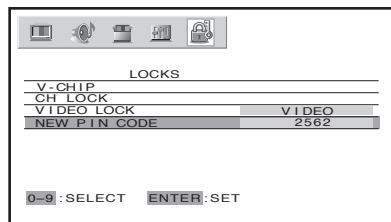

- Press ENTER. The new PIN code is now active.

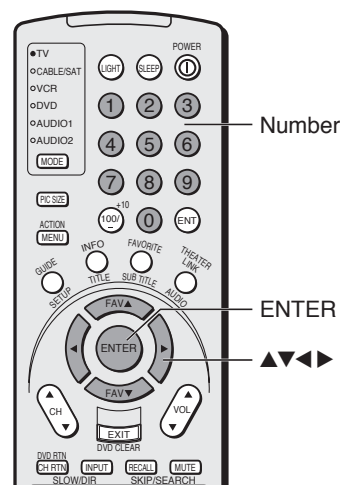
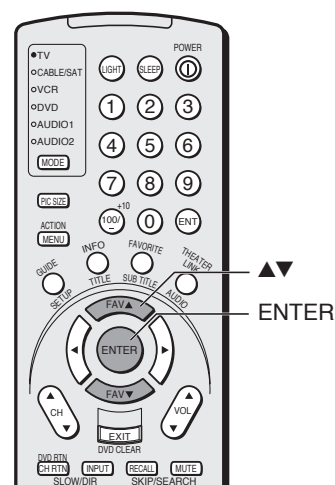

## Adjusting the picture

### Selecting the picture mode

You can select your desired picture type from four picture modes: Sports, Standard, Movie, and Preferences.

Mode	Picture Quality
Sports	Bright and dynamic picture (factory setting)
Standard	Standard picture setting (factory setting)
Movie	Movie-like picture setting (factory setting)
Preference	Your personal preferences*

\*(see "Saving your new preferences" on page 47.)

To select the picture mode:

1. Press MENU, and then press ◀ or ▶ until the PICTURE menu appears.
2. Press ▼ or ▲ to highlight MODE, and then press ENTER.
3. Press ▼ or ▲ to select the mode you prefer, then press ENTER.

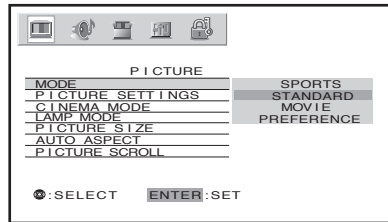

### Note:

If you select one of the factory-set picture modes (SPORTS, STANDARDS, or MOVIE) and then change a picture quality setting (for example, increase the contrast), the picture mode automatically changes to PREFERENCE in the PICTURE menu.

To save your new picture quality settings, you must select SAVE before closing the PICTURE menu or the TV will return to the previous picture mode. See "Saving your new preferences" on page 47.

### Control touchpad on TV front

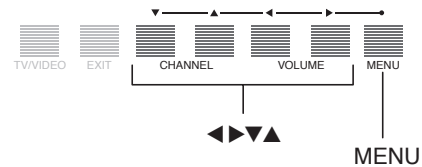

### Adjusting the picture quality

You can adjust the picture quality to your personal preferences, including the contrast, brightness, color, tint, sharpness, and color temperature.

Selection	◀ Pressing ▶
contrast	lower higher
brightness	darker lighter
color	paler deeper
tint	reddish greenish
sharpness	softer sharper
color temperature	cool medium warm

To adjust the picture quality:

1. Press MENU, and then press ◀ or ▶ until the PICTURE menu appears.
2. Press ▼ or ▲ to highlight PICTURE SETTINGS, then press ENTER. The PICTURE SETTINGS menu appears.
3. Press ▲ or ▼ until the item you want to adjust is highlighted, then press ENTER.
4. Press ◀ or ▶ to adjust the level.

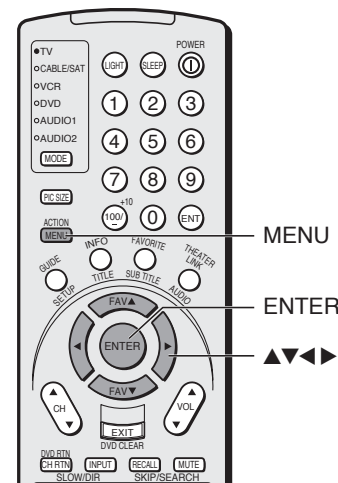
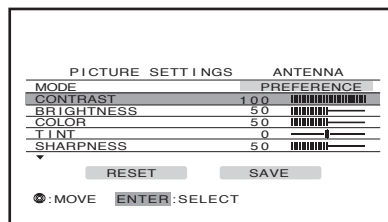

The picture qualities you adjusted can be saved in the TV's memory (see page 47).

You can keep these settings or choose factory set options, as described under "Selecting the picture mode" above.

## Saving your new preferences

You can save the picture qualities you adjusted (contrast, brightness, color, tint, sharpness, color temperature and CableClear DNR) in the picture PREFERENCE mode.

To save your new preferences:

1. Press MENU, and then press ◀ or ▶ until the PICTURE menu appears.
2. Press ▲ or ▼ to highlight PICTURE SETTINGS, and then press ENTER.  
The PICTURE SETTINGS menu appears.
3. Press ▲▼◀▶ to highlight SAVE, and then press ENTER.  
When complete, SAVE changes to “DONE.”

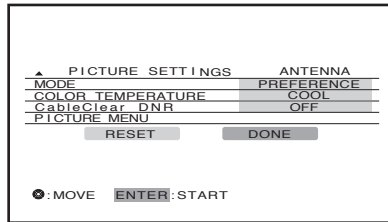

The picture mode automatically changes to PREFERENCE (see “Selecting the picture mode” on page 46).

## Selecting the color temperature

You can change the quality of the picture by selecting from three preset color temperatures: cool, medium, and warm.

To select the color temperature:

1. Press MENU, and then press ◀ or ▶ until the PICTURE menu appears.
2. Press ▲ or ▼ to highlight PICTURE SETTINGS, and then press ENTER.  
The PICTURE SETTINGS menu appears.
3. Press ▲ or ▼ to highlight COLOR TEMPERATURE, and then press ENTER.

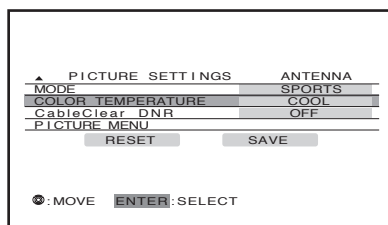

4. Press ◀ or ▶ to select the mode you prefer.

Mode	Picture Quality
cool	bluish
medium	neutral
warm	reddish

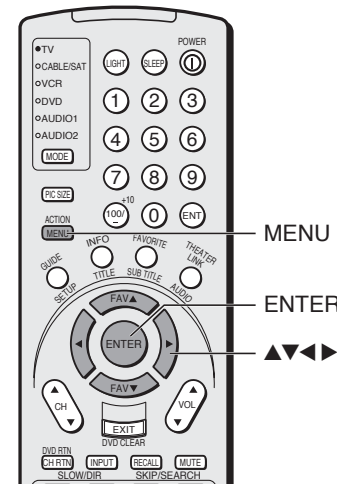



### Using the CableClear™ DNR feature

CableClear™ DNR reduces visible interference in your TV picture. This is useful when receiving a broadcast with a weak signal (especially a Cable channel) or playing a video cassette or disc damaged by repeated use.

To turn on CableClear™ DNR:

1. Press MENU, and then press ◀ or ▶ until the PICTURE menu appears.
2. Press ▲ or ▼ to highlight PICTURE SETTINGS, and then press ENTER.  
The PICTURE SETTINGS menu appears.
3. Press ▲ or ▼ to highlight CableClear DNR, and then press ENTER.

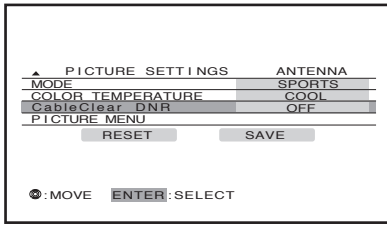

4. Press ◀ or ▶ to select AUTO.

To turn off CableClear DNR:

Select OFF in step 4 above.

### Resetting picture adjustments

The RESET function adjusts the picture qualities to the following factory settings:

Mode .....	sports	Tint .....	center (0)
Contrast .....	max (100)	Sharpness .....	center (50)
Brightness .....	center (50)	Color temperature .....	cool
Color .....	center (50)	CableClear DNR .....	auto

To reset the picture adjustments:

1. Press MENU, and then press ◀ or ▶ until the PICTURE menu appears.
2. Press ▲ or ▼ to highlight PICTURE SETTINGS, and then press ENTER. The PICTURE SETTINGS menu appears.
3. Press ▲ or ▼ to highlight RESET.
4. Press ENTER until the RESET changes to "DONE."

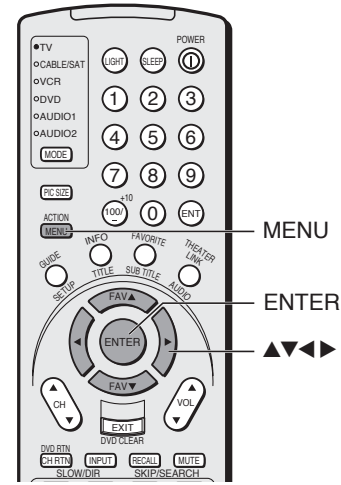
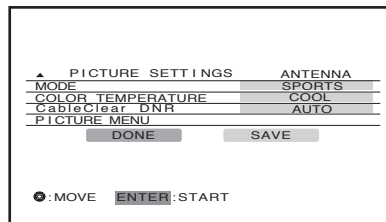

#### Note:

- When in ColorStream or HDMI mode, "CableClear DNR" will change to "DNR" in the menu.
- DNR is not selectable in the HDMI mode.

## Selecting the Lamp mode

You can select either the HI BRIGHT or LOW POWER mode. The HI BRIGHT mode is useful for situations where additional picture brightness is desired (such as in a room with bright lighting). The LOW POWER mode reduces wear on the projection lamp. Using this mode should result in longer lamp life. See “Lamp unit replacement” on page 60.

1. Press MENU, and then press ◀ or ▶ until the PICTURE menu appears.
2. Press ▲ or ▼ to highlight LAMP MODE, and then press ENTER.
3. Press ▲ or ▼ to select HI BRIGHT or LOW POWER, whichever you prefer.

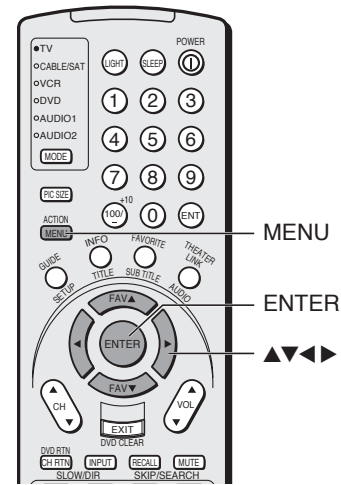
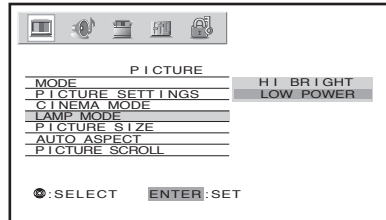

## Selecting the cinema mode

When you view a DVD movie (3:2 pulldown processed) from a DVD player connected to the ColorStream (component video) inputs on the TV, smoother and more natural motion can be obtained by setting the CINEMA MODE to FILM.

To set the CINEMA MODE to FILM:

1. Press MENU, and then press ◀ or ▶ until the PICTURE menu appears.
2. Press ▲ or ▼ to highlight CINEMA MODE, and then press ENTER.
3. Press ▲ or ▼ to select FILM.

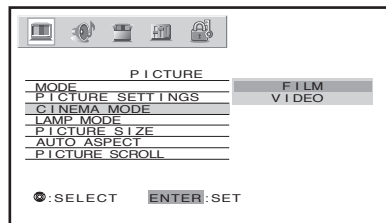

To set the CINEMA MODE to VIDEO (off):

Press ▲ or ▼ to select VIDEO in step 3 above.

## Selecting the video input source

Press the INPUT on the remote control or TV/VIDEO on the TV to view a signal from another device connected to your TV, such as a VCR or DVD player. You can select ANT 1, VIDEO 1, VIDEO 2, VIDEO 3, ColorStream HD1, ColorStream HD2, HDMI1, HDMI2 or ANT 2 depending on which input jacks are used for connecting the devices (see "Connecting your TV" on page 8).

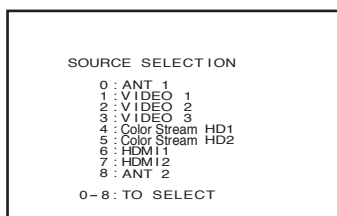

Pressing INPUT on the remote control displays the current signal source (press INPUT again or 0-8 to change)

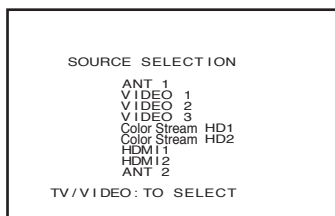

Pressing TV/VIDEO on the TV changes the current signal source

### Note:

- When HDMI1 or 2 is selected the VIDEO OUT jack does not output a signal.
- When ColorStream HD1 or HD2 is selected, the VIDEO OUT jack does not output a signal. To receive a VIDEO OUT signal, use a standard video or S-video IN connection instead of the ColorStream connection.
- In POP double-window mode, the main window will display 480i signals only. If you select ColorStream HD1/HD2 or HDMI1/2 while the POP picture is active, the message "Not Available" will display.

### Please note the following regarding the HDMI source selection:

**This TV is not intended for connection to and should not be used with a PC (personal computer). See "Connecting an HDMI or DVI device to the HDMI inputs" on page 15 for details.**

## Labeling the video input sources

The video label feature allows you to label each input source for your TV from the following preset list of labels:

- : Uses the default label name
- VCR : Video cassette recorder
- DVD : DVD video
- DTV : Digital TV set-top box
- SAT : Satellite box
- CBL : Cable box

To label the video input sources:

- Press MENU, and then press ◀ or ▶ until the CUSTOM menu appears.
- Press ▲ or ▼ to highlight VIDEO LABEL.
- Press ENTER to display the VIDEO LABEL menu.
- Press ▲ or ▼ to highlight the video source you want to label and then press ENTER.
- Press ▲ or ▼ to select the desired label for that input source.
- Finish labeling the other video sources as desired. To return to the previous menu, press ▲ or ▼ to highlight CUSTOM MENU, and then press ENTER.
- To exit the menu, press EXIT.

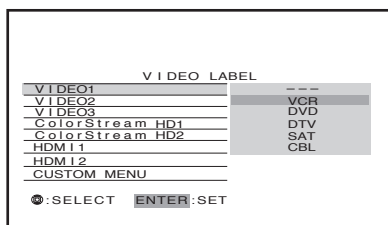
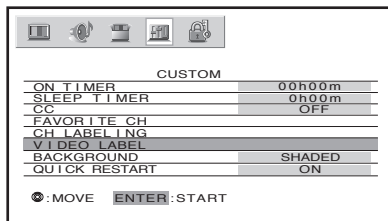

Control touchpad on TV front

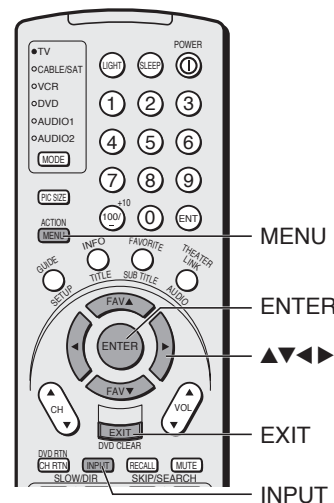
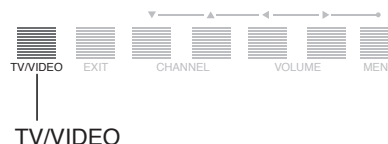

## Using the closed caption feature

The closed caption feature has two options:

- Captions—An on-screen display of the dialogue, narration, and sound effects of TV programs and videos that are closed captioned (usually marked as “CC” in TV listings).
- Text—An on-screen display of information not related to the current program, such as weather or stock data (when provided by individual stations).

To view captions or text:

1. Tune the TV to the desired program.
2. Press MENU, and then press ◀ or ▶ to display CUSTOM menu.
3. Press ▲ or ▼ to highlight CC, and then press ENTER.

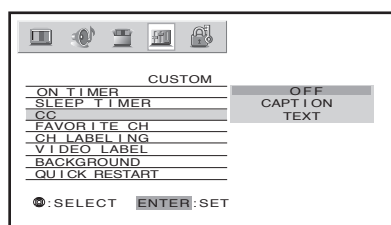

4. Press ▲ or ▼ to highlight C1, C2, C3, or C4 (C1 displays translation of the primary language in your area).

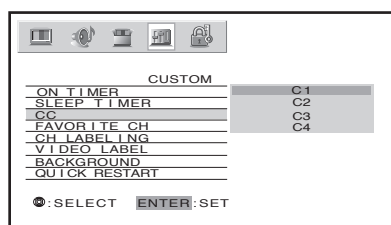

- To view captions, highlight C1, C2, C3, or C4 (C1 displays translation of the primary language in your area).

**Note:** If the program or video you selected is not closed captioned, no captions will display on the screen.



- To view text, highlight T1, T2, T3, or T4.

**Note:** If text is not available in your area, a black rectangle may appear on your screen. If this happens, turn the Closed Caption feature OFF.

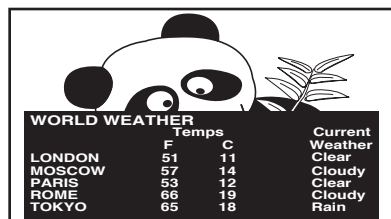

To turn off the Closed Caption feature:  
Highlight OFF in step 4.

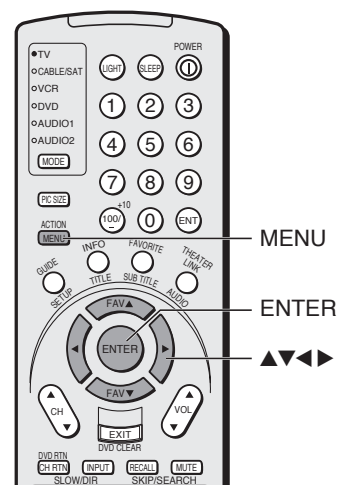

### Note:

A closed caption signal may not display in the following situations:

- when a videotape has been dubbed
- when the signal reception is weak
- when the signal reception is nonstandard

## Setting the ON timer

To set the ON timer to turn on the TV automatically:

1. Press MENU, and then press ◀ or ▶ until the CUSTOM menu appears.
2. Press ▲ or ▼ to highlight ON TIMER, and then press ENTER.
3. Press the Number buttons (0–9) to enter the length of time until the TV turns on automatically.  
You can set the ON timer in 10-minute increments, up to 12h00m.
4. Press ENTER. (The ON timer will start.)

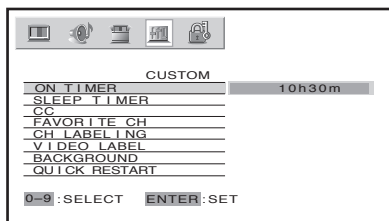

5. Press POWER to turn off the TV.  
The TV will turn on automatically after the length of time you set in the ON Timer.

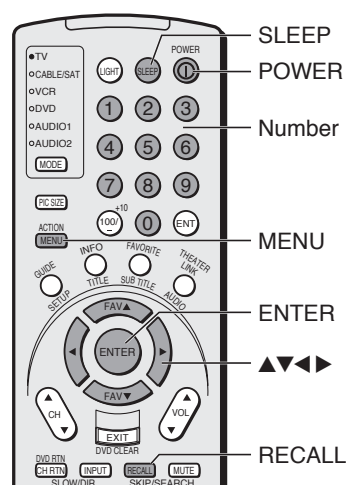

## Setting the sleep timer

To set the sleep timer to turn off the TV automatically:

1. Press SLEEP to set the length of time until the TV turns off.

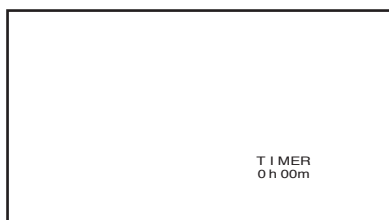

Every time you press the button, the time display will increase by 10 minutes, up to 3 hours.

0h00m → 0h10m → 0h20m - - - - - → 2h50m → 3h00m → 0h00m

To cancel the sleep timer:

Press SLEEP until it is set to 0h00m.

The timer also can be set using the on-screen menu:

1. Press MENU, and then press ◀ or ▶ until the CUSTOM menu appears.
2. Press ▲ or ▼ to highlight SLEEP TIMER, and then press ENTER.
3. Press the Number buttons (0–9) to enter the length of time until the TV turns off automatically.
4. Press ENTER to start the timer.

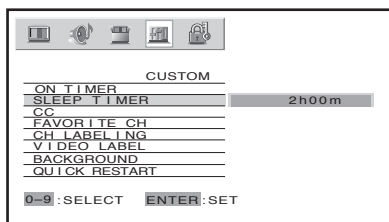

### Note :

- When an instant power failure occurs, the ON timer and sleep timer settings may be cleared.
- To display the amount of time left until the TV turns on or off automatically, press RECALL.

## Setting the clock

To set the clock:

1. Press MENU, and then press ◀ or ▶ until the SET UP menu appears.
2. Press ▲ or ▼ to highlight CLOCK SET, and then press ENTER.
3. Press the Number buttons (0–9) to enter the correct time. The clock operates on a 24-hour cycle.
4. Press ENTER to start the clock.

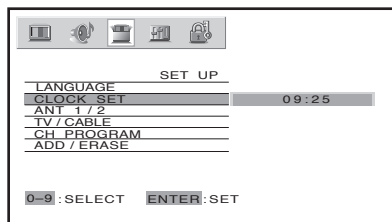

To display the time on-screen:  
Press RECALL.

### Note :

If the TV's power source is interrupted (the power cord is unplugged or a power failure occurs), the clock must be reset.

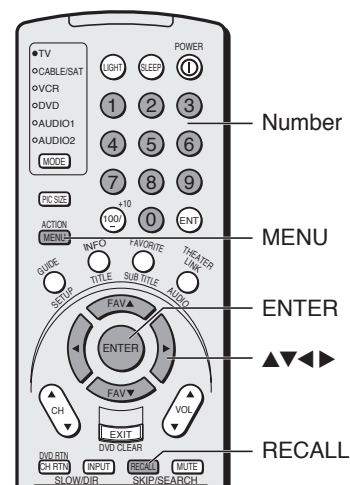

Introduction

Connecting your TV

Using the Remote Control

Setting up your TV

Using the TV's Features

Appendix

Index

## Adjusting the sound

### Muting the sound

Press MUTE to temporarily reduce (1/2 MUTE) or turn off (MUTE) the sound. While the sound is off, the screen will display “1/2 MUTE” or “MUTE” in the lower right corner. Every time you press MUTE, the mute mode will change in the following order.

→ Normal → 1/2 MUTE → MUTE →

When you select “MUTE” mode, the closed caption feature is automatically activated. To deactivate this feature, deactivate MUTE. This feature works only when the closed caption mode is set to OFF. See “Using the closed caption feature” on page 51 for more information.

### Selecting stereo/SAP broadcasts

The multi-channel TV sound (MTS) feature allows you to listen to high-fidelity stereo sound while watching TV. MTS can also transmit a second audio program (SAP) containing a second language, music, or other audio information (when provided by individual stations).

When the TV receives a stereo or SAP broadcast, the word STEREO or SAP appears on-screen every time the TV is turned on, the channel is changed, or the RECALL button is pressed.

The MTS feature is not available when the TV is in VIDEO mode.

To listen to stereo sound:

1. Press MENU, and then press ◀ or ▶ until the AUDIO menu appears.
2. Press ▲ or ▼ to highlight MTS, and then press ENTER.
3. Press ▲ or ▼ to highlight STEREO, and then press ENTER.

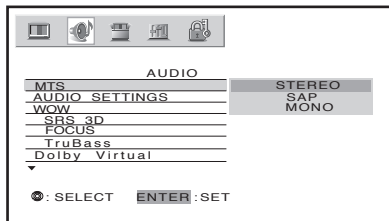

You can leave your TV in STEREO mode because it will automatically output the type of sound being broadcast (stereo or monaural). The word “STEREO” or “SAP” displays in yellow in the menu when the TV receives the signal.

If the stereo sound is noisy, select MONO to reduce the noise.

To listen to SAP (if available):

1. Press MENU, and then press ◀ or ▶ until the AUDIO menu appears.
2. Press ▲ or ▼ to highlight MTS, and then press ENTER.
3. Press ▲ or ▼ to highlight SAP, and then press ENTER. You will hear the station's second audio program (if available) from the speakers, while viewing the original program's picture (see note at right).

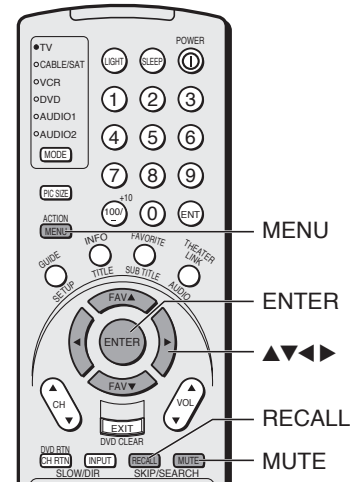

Control touchpad on TV front

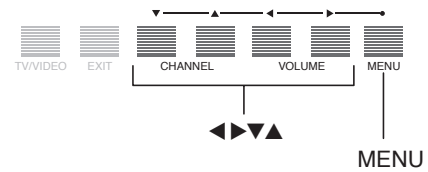

#### Note :

A second audio program (SAP) can be heard only on those TV stations that offer it.

For example, a station might broadcast music as a second audio program. If you have SAP on, you will see the current program on the screen but hear music instead of the program's normal audio.

However, if you have SAP on and the station you are watching is not currently broadcasting a second audio program, the station's normal audio will be output.

Occasionally there is no sound at all in SAP mode. If this happens, set the MTS feature to STEREO mode.



## Using the WOW™ surround sound feature

WOW is a special combination of SRS Labs audio technologies that creates a thrilling surround sound experience with deep, rich bass from stereo sound sources. Your TV's audio will sound fuller, richer, and wider. WOW consists of three features: SRS 3D, FOCUS, and TruBass.

To adjust the WOW feature:

1. Select STEREO mode (see “selecting stereo/SAP broadcasts” on page 54).
2. Press MENU, and then press ◀ or ▶ until the AUDIO menu appears.
3. Press ▲ or ▼ to highlight the desired WOW feature you want to adjust, then press ENTER.
  - SRS 3D — To turn on or off the surround sound effect.
  - FOCUS — To turn on or off the vocal emphasis effect.
  - TruBass — To select your desired bass expansion level (HIGH, LOW or OFF).

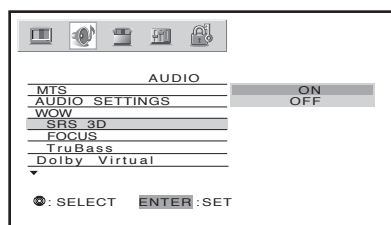

4. Press ▲ or ▼ to adjust the item, then press ENTER.

## Adjusting the sound quality

You can change the quality of your TV's sound by adjusting the bass, treble, and balance.

To adjust the sound quality:

1. Press MENU, and then press ◀ or ▶ until the AUDIO menu appears.
2. Press ▲ or ▼ to highlight AUDIO SETTINGS, and then press ENTER. The AUDIO SETTINGS menu appears.

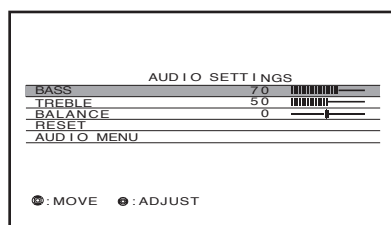

3. Press ▲ or ▼ to highlight the item you want to adjust.
4. Press ◀ or ▶ to adjust the level.
  - ◀ makes the sound quality weaker or increases the balance in the left channel, depending on the item selected.
  - ▶ makes the sound quality stronger or increases the balance in the right channel, depending on the item selected.

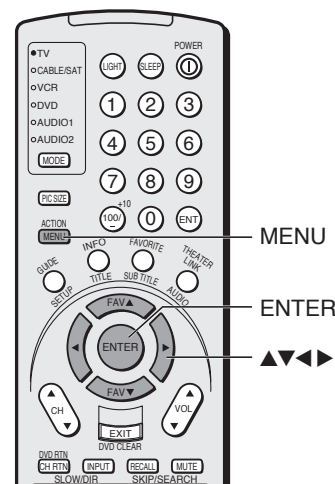

### Note:

If the broadcast is monaural, the WOW SRS 3D surround sound effect will not work.



## Enjoying the Dolby Virtual sound feature

The Dolby® Virtual sound feature allows you to enjoy virtual surround sound from the TV's speakers.

- If you connect a device (a game console, a DVD player or a DTV receiver, etc.) with analog audio output to standard (analog) audio terminals on the TV, and the input source is encoded with Dolby Surround  sound or Dolby Digital  sound, the Dolby Virtual operates as Virtual Dolby Surround  (VDS). VDS simulates Dolby Surround sound from the TV's speakers.

To turn on the Dolby Virtual sound feature:

1. Press MENU, and then press ◀ or ▶ until the AUDIO menu appears.
2. Press ▲ or ▼ to highlight Dolby Virtual, and then press ENTER.
3. Press ▲ or ▼ to highlight ON, and then press ENTER.

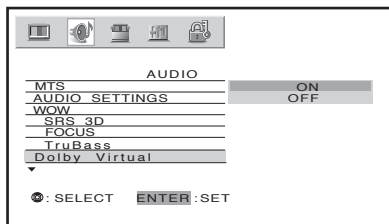

To turn off the Dolby Virtual sound feature:

Highlight OFF in step 3 above.

### Note:

The Dolby Virtual and WOW/SRS 3D features cannot be on at the same time.

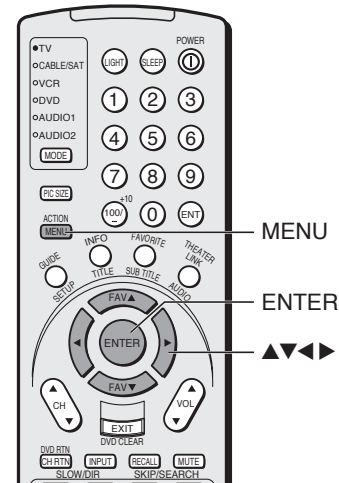

## Resetting your audio adjustments

The RESET function returns your audio adjustments to the following factory settings:

- Bass ..... center (50)
- Treble ..... center (50)
- Balance ..... center (0)

To reset your audio adjustments:

1. Press MENU, and then press ◀ or ▶ until the AUDIO menu appears.
2. Press ▲ or ▼ to highlight AUDIO SETTINGS, and then press ENTER. The AUDIO SETTINGS menu appears.
3. Press ▲ or ▼ to highlight RESET, and then press ENTER.

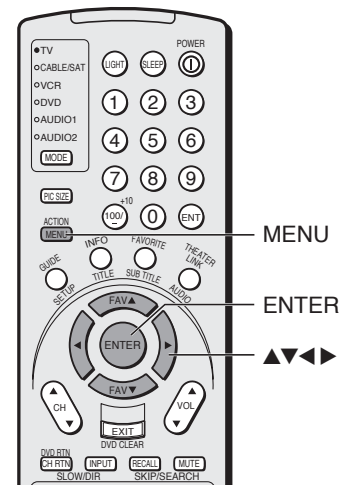
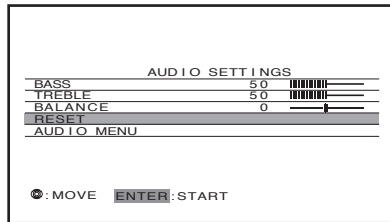

## Using the StableSound® feature

When the signal source is changed, the StableSound feature limits the highest volume level to prevent extreme changes in volume (for example, to prevent the sudden increase in volume that often happens when a TV program switches to a commercial).

To turn on the StableSound feature:

1. Press MENU, and then press ◀ or ▶ until the AUDIO menu appears.
2. Press ▲ or ▼ to highlight STABLE SOUND, and then press ENTER.
3. Press ▲ or ▼ to select ON, and then press ENTER.

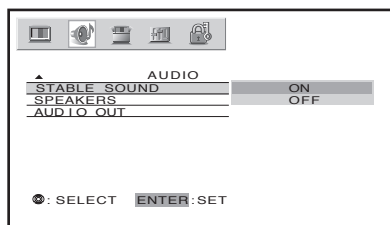

To turn off the StableSound feature:

Select OFF in step 3 above.

## Turning off the built-in speakers

Use this feature to turn off the TV speakers when you connect an audio system (see “Connecting an audio system” on page 16).

To turn off the built-in speakers:

1. Press MENU, then press ◀ or ▶ until the AUDIO menu appears.
2. Press ▲ or ▼ to highlight SPEAKERS, and then press ENTER.
3. Press ▲ or ▼ to select OFF, and then press ENTER.

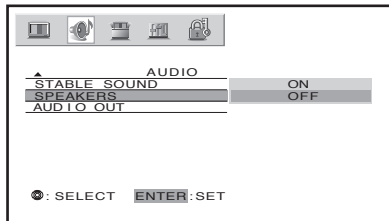

To turn on the built-in speakers:

Select ON in step 3 above.

## Selecting the AUDIO OUT sound

This feature allows you to select the sound source (MAIN or POP) that is output from the AUDIO OUT terminals (for example, see “Connecting two VCRs” on page 14).

This is useful when amplifying or recording the POP sound with external equipment while listening to the sound of the main picture through the TV's speakers.

To select the AUDIO OUT sound:

1. Press MENU, and then press ◀ or ▶ until the AUDIO menu appears.
2. Press ▲ or ▼ to highlight AUDIO OUT, and then press ENTER.
3. Press ▲ or ▼ to select MAIN or POP, and then press ENTER.

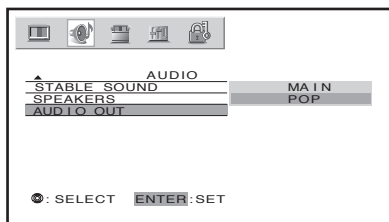

- MAIN: Outputs the sound of the main (left window) program through the AUDIO OUT terminals.
- POP: Outputs the sound of the POP (right window) program through the AUDIO OUT terminals.

### Note:

Make sure the volume control of your audio amplifier is set to a moderate listening level.

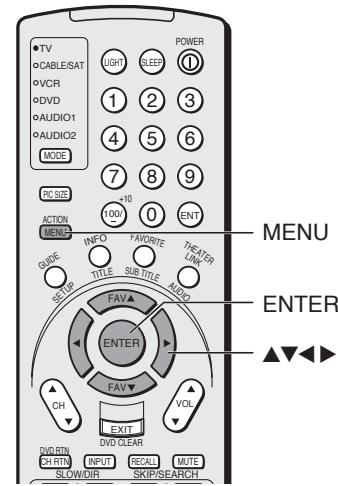

### Note:

When the POP window is closed, the sound of the main program is output through the AUDIO OUT terminals, even if POP is selected in the AUDIO OUT menu.

## Selecting the background of the menu display

You can change the background of the menu display by selecting from two preset types: shaded and solid (gray).

To select the background:

1. Press MENU, and then press ◀ or ▶ until the CUSTOM menu appears.
2. Press ▲ or ▼ to highlight BACKGROUND, and then press ENTER.
3. Press ▲ or ▼ to select either a SHADED or SOLID background, and then press ENTER.

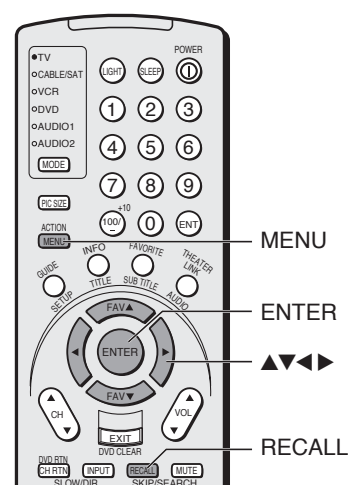
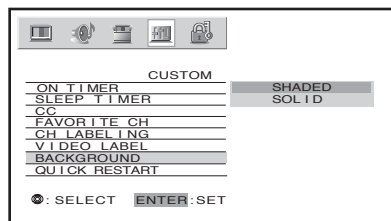

## Displaying on-screen information

Press RECALL to display the following information on-screen:

- Antenna mode (when in TV mode)
- Channel number or VIDEO mode selected
- Time (if set)
- Remaining time of ON/SLEEP timer (if set)
- Channel label (if set)
- Video label (when in video mode)
- Stereo or SAP audio status
- V-CHIP rating status
- Picture size
- Lamp mode selected (when in the HI BRIGHT mode)

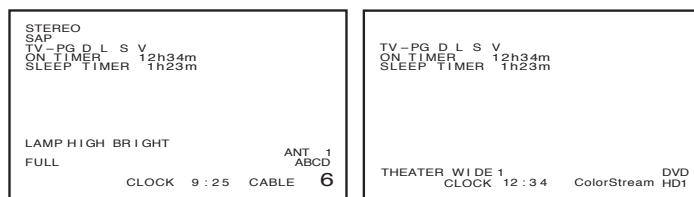

## Understanding the auto power off feature

The TV will automatically turn itself off after approximately 15 minutes if it is tuned to a vacant channel or a station that completes its broadcast for the day. This feature does not work in VIDEO mode.

## Understanding the last mode memory feature

If the power is cut off while you are viewing the TV, the Last Mode Memory feature turns on the TV automatically when the power is resupplied.

If the power is going to be off for a long time and you are going to be away from your TV, unplug the power cord to prevent the TV from turning on in your absence.

## Appendix

### Lamp unit replacement (User-replaceable component)

The light source for this TV is a mercury lamp with internal atmospheric pressure that increases during use. The lamp has a limited service life that varies depending on product use and user settings. As is generally the case with all projection TVs that use projection lamps as a light source, the brightness of the lamp in this TV may vary somewhat over the expected service life and will generally decrease over time. The average useful service life for the lamp is approximately 8,000 hours in LOW POWER mode or 6,000 hours in HI BRIGHT mode. See "Selecting the Lamp mode" on page 49 for information on switching the lamp mode. Because these are averages, some lamps will require earlier replacement.

If you use the lamp beyond its service life:

- you may notice a reduction in the colors and/or brightness of the picture; and
- the strength of the quartz glass in the lamp will be reduced and the lamp may rupture (often making a loud noise when this happens). If the lamp ruptures, the TV will not operate until the lamp unit is replaced.

**Note:** The lamp unit is designed so broken lamp glass remains securely inside the lamp unit.



**CAUTION: Always handle the lamp unit with care.** The lamp unit in this TV was designed for safe replacement by consumers; however, if the lamp unit is subjected to intentional abuse (such as excessive mechanical abuse or handling by children or pets), the unit may break, exposing sharp edges or pinch points.



**WARNING: RISK OF ELECTRIC SHOCK!** 

TO REDUCE THE RISK OF ELECTRIC SHOCK, **NEVER REMOVE TV COVERS, EXCEPT AS SPECIFIED HEREIN.** REFER ALL SERVICING NOT SPECIFIED IN THIS MANUAL TO QUALIFIED SERVICE PERSONNEL. Failure to follow this WARNING may result in death or serious injury.

**Note :**

The lamp is warranted only for the periods and to the extent set forth in the Limited Warranty applicable to this set, which is a substantially shorter period of time than the average useful service period. See "Limited United States Warranty" on page 67 or "Limited Canada Warranty" on page 68, as applicable.

### When to replace the lamp unit

You should replace the lamp unit:

- if the picture darkens and/or colors fade;
- if the screen (lamp) does not light (LED Indication 3); or
- if you hear a loud noise and the picture goes black, which may indicate a lamp rupture (LED Indication 3). See "LED indications" on page 64.

To obtain a replacement lamp unit:

- In the U.S.:

	Web	Contact
In warranty	<a href="http://www.tacp.toshiba.com/service">www.tacp.toshiba.com/service</a>	Call toll-free 1-800-631-3811.
Out of warranty	<a href="http://www.ceaccessories.toshiba.com">www.ceaccessories.toshiba.com</a>	Consult your consumer electronics dealer for availability.

- In Canada, contact a Toshiba parts distributor by directing your web browser to [www.toshiba.ca](http://www.toshiba.ca). Click "Home Entertainment," and then click "Support."

Use the replacement lamp unit model listed below only. Using any other lamp may cause damage to the TV and/or lamp.



**CAUTION: Always replace with same type lamp unit: Model No. TB25-LMP (Stock no. 23311083)**



## How to replace the lamp unit

**Required tool:** Manual Phillips screwdriver; gloves.  
**Optional tool:** 5/32" or 4mm Allen wrench.

1. Turn off the TV and unplug the power cord.



 **WARNING: Eye damage may result from directly viewing the light produced by this lamp.** Always turn off the TV and unplug the power cord before opening the lamp unit door.

2. **STOP! Allow the lamp to cool for at least one (1) hour before replacing it.**

 **CAUTION: HOT SURFACE**  The temperature of the lamp immediately after use exceeds 392°F (200°C). Touching the lamp before it has cooled will result in severe burns. **ALLOW THE LAMP TO COOL FOR AT LEAST ONE (1) HOUR BEFORE REPLACING IT.**

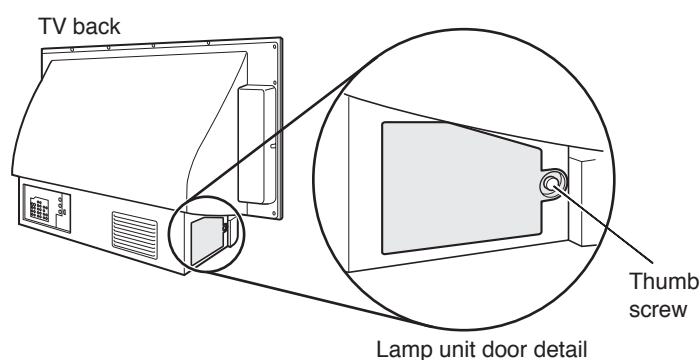
3. On the lamp unit door on the side of the TV, loosen the thumb screw by hand or by using a 5/32" or 4mm Allen wrench, and then remove the lamp unit door.



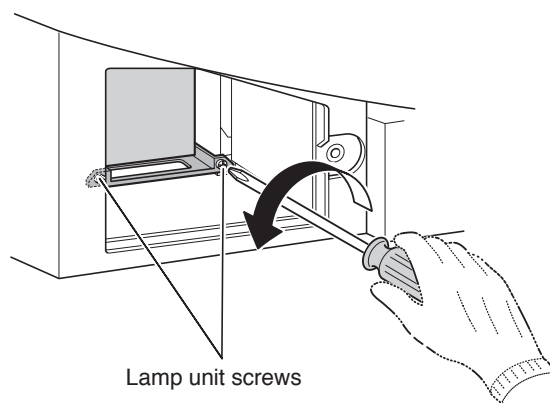

 **WARNING: RISK OF ELECTRIC SHOCK!**  The lamp unit door is provided with an interlock to reduce the risk of electric shock and excessive ultraviolet radiation. **Never defeat its purpose or attempt to service without removing the lamp unit door completely.** Failure to follow this WARNING may result in death or serious injury.

4. Using a manual Phillips screwdriver, loosen the two screws on the lamp unit.



(Continued on next page)

 **WARNING: RISK OF ELECTRIC SHOCK!**   
TO REDUCE THE RISK OF ELECTRIC SHOCK, **NEVER REMOVE TV COVERS, EXCEPT AS SPECIFIED HEREIN.** REFER ALL SERVICING NOT SPECIFIED IN THIS MANUAL TO QUALIFIED SERVICE PERSONNEL. Failure to follow this WARNING may result in death or serious injury.



## How to replace the lamp unit (continued)

5. Grasp the lamp unit handle and gently pull the lamp unit straight out of the TV. Set the old lamp unit aside (see "Lamp unit disposal" on page 64).



6. Carefully insert the new lamp unit straight into the TV until it is fully seated.

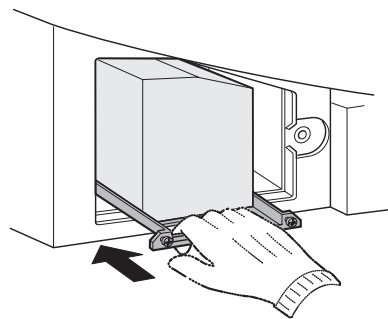

**Note :**

- Never subject the lamp unit to excessive shock.
- Never touch the lamp unit glass or otherwise get it dirty. Doing so may affect the image quality and reduce the service life of the lamp. See "Cleaning the lamp unit glass" at right.

7. Using a manual Phillips screwdriver, tighten the two lamp unit screws.

**Note: Hand-tighten only.** Do not use an electric screwdriver.

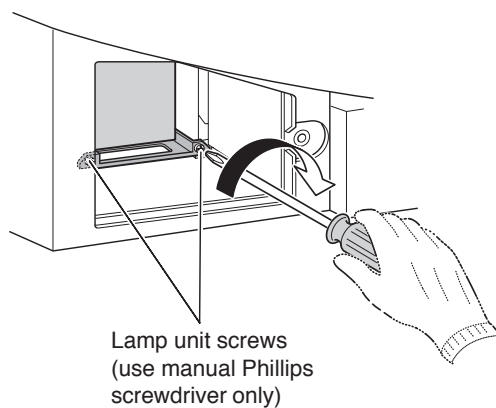

**NOTE :** Make sure the lamp unit and screws are installed securely; otherwise, the TV may not turn on and the lamp life may be shortened.

### Cleaning the lamp unit glass

If you accidentally touch the lamp unit glass or otherwise get it dirty, wipe it with a lint-free lens cleaning cloth (such as a cloth for cleaning camera lenses or eyeglasses).



**CAUTION: NEVER clean a hot lamp with any type of flammable liquid or aerosol cleaning agent.** Many ordinary cleaning agents (such as glass cleaners) contain chemicals that may be flammable at certain temperatures. If the lamp unit is not allowed to cool for at least one (1) hour, such chemicals may ignite.

## How to replace the lamp unit (continued)

8. Reattach the lamp unit door, making sure to insert the hooks on the left side of the lamp unit door inside the opening in the TV cabinet.

Insert the hooks inside the TV cabinet opening.

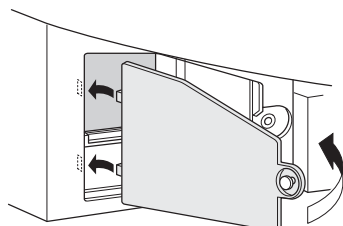

Lamp unit door

9. Replace the thumb screw and hand-tighten.

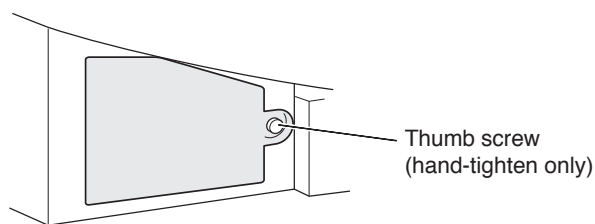

Lamp unit door



**NOTE :** Make sure the lamp unit door is installed securely; otherwise, the TV may not turn on.

10. Plug in the power cord and turn on the TV. After the initial warmup period (which may take up to several seconds for full picture brightness), the TV should operate normally. If any of the following conditions exist, turn off the TV, unplug the power cord, and repeat steps 1–9 to ensure that the lamp unit and lamp unit door are installed correctly:

- No picture
- Dark picture
- TV will not turn on

If, after repeating steps 1–9, the problem still exists:

- In the U.S., call Customer Service at 1-800-631-3811.
- In Canada, locate the nearest Toshiba authorized service depot by directing your web browser to [www.toshiba.ca](http://www.toshiba.ca); click “Home Entertainment,” and then click “Support.”

## Lamp unit disposal

- Place the used lamp unit in the empty box from the new lamp unit.
- Keep the lamp unit out of reach of children and pets.

 **CAUTION: Always handle the lamp unit with care.**  
The lamp unit in this TV was designed for safe replacement by consumers; however, if the lamp unit is subjected to intentional or accidental abuse (such as excessive mechanical abuse or handling by children or pets), the unit may break, exposing sharp edges or pinch points.

- Dispose of the used lamp unit by the approved method for your area.

 **NOTE :** The lamp unit contains mercury. Disposal of mercury may be regulated due to environmental considerations. For disposal or recycling information, contact your local authorities or the Electronics Industries Alliance ([www.eiae.org](http://www.eiae.org)).

## LED indications

The green and red LED lights on the TV control touchpad (on the lower right corner of the TV screen) indicate the TV's current status, as follows:

- Green ON = Control touchpad being pressed.
- Red ON = Power ON.
- Green and/or Red blinking (see table below for condition and solution).

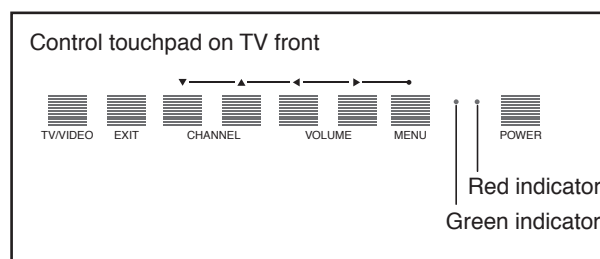

LED Indication	Condition	Solution
1) Green lights solid; Red blinks at 0.5-second intervals.	The lamp unit door is not seated properly.	Turn the POWER OFF and unplug the power cord. Review "How to replace the lamp unit" on pages 61–63 to ensure that the lamp unit door is installed securely. If the problem persists, contact a Toshiba Authorized Service Center.
2) Green blinks at 0.3-second intervals; Red lights solid.	The lamp is not working properly.	The TV automatically will try to restart itself eight times.
3) Green and Red blink at 1-second intervals.	The lamp is not working properly after the eighth automatic restart (see item #2).	Turn the POWER OFF and then ON again. If the problem persists, replace the lamp unit (see pages 61–63). If the problem still persists, contact a Toshiba Authorized Service Center.
4) Green is off; Red blinks.	For service personnel only.	Turn the POWER OFF and unplug the power cord. If the problem persists, contact a Toshiba Authorized Service Center.
5) Green and Red blink three times.	An abnormal temperature increase has occurred.	Do not block or cover the slots or openings in the TV cabinet. If the problem persists, contact a Toshiba Authorized Service Center.

## Specifications

**Note:** This model complies with the specifications listed below. Designs and specifications are subject to change without notice. This model may not be compatible with features and/or specifications that may be added in the future.



### **WARNING: RISK OF ELECTRIC SHOCK !**

**Never attempt to service the TV yourself. Opening and removing the covers may expose you to dangerous voltage or other hazards. Refer all servicing to a Toshiba Authorized Service Center.**

#### Television System

NTSC standard

#### Channel Coverage

VHF: 2 through 13

UHF: 14 through 69

Cable TV: Mid band (A-8 through A-1, A through I)

Super band (J through W)

Hyper band (AA through ZZ, AAA, BBB)

Ultra band (65 through 94, 100 through 125)

#### Power Source

120 V AC, 60 Hz

#### Power Consumption

190 W (average)

#### Audio Power

20 W + 20 W

#### Speaker Type

Main: Two 4 inches (10 cm) round

Tweeter: Two 1-5/8 inches (4 cm) round

#### Video/Audio Terminals

##### S-VIDEO INPUT

Y : 1 V(p-p), 75 ohms, negative sync.

C : 0.286 V(p-p) (burst signal), 75 ohms

##### VIDEO/AUDIO INPUT

VIDEO: 1 V(p-p), 75 ohms, negative sync.

AUDIO: 150 mV(rms) (30% modulation equivalent,  
22 k ohms or greater)

##### ColorStream® (component video) INPUT

Y : 1V(p-p), 75 ohms

PR: 0.7 V(p-p), 75 ohms

PB: 0.7 V(p-p), 75 ohms

AUDIO: 150 mV(rms), 22 k ohms or greater

##### VIDEO/AUDIO OUTPUT

VIDEO: 1 V(p-p), 75 ohms, negative sync.

AUDIO: 150 mV(rms) (30% modulation equivalent,  
2.2 k ohms or less)

##### VARIABLE AUDIO OUTPUT

0–300 mV(rms) (30% modulation equivalent,

2.2 k ohms or less)

##### HDMI INPUT:

HDMI compliant (type A connector)

HDCP compliant

E-EDID\* compliant

Suggested scan rates: 1080i, 480p, 480i, 720p

HDMI Audio: 2-channel PCM

32/44.1/48 kHz sampling frequency

16/20/24 bits per sample

#### Dimensions

52HMX84: Width 58-3/8 inches (1,483 mm)

Height 35-1/16 inches (890 mm)

Depth 15-1/4 inches (387 mm)

62HMX84: Width 67-1/16 inches (1,703 mm)

Height 40-15/16 inches (1,040 mm)

Depth 18-1/4 inches (464 mm)

#### Mass

52HMX84: 88 lbs (40.0 kg)

62HMX84: 107 lbs (48.5 kg)

#### Supplied Accessories

Remote Control with 2 size “AA” alkaline batteries

Owner’s Manual (this book)

Important notes sheet

#### Optional TV Stand

52HMX84: ST5284, ST5294

62HMX84: ST6284, ST6294

#### Operating condition

Temperature: 41°F–95°F (5°C–35°C)

Introduction

Connecting  
your TV

Using the  
Remote Control

Setting up  
your TV

Using the TV's  
Features

Appendix

Index

\* E-EDID = Enhanced-Extended Display Identification

## Troubleshooting

Before calling a service technician, please check the following table for a possible cause of the symptom and some solutions.

Symptom	Solution
TV will not turn on	<ul style="list-style-type: none"><li>• Make sure the power cord is plugged in, then press POWER.</li><li>• The remote control batteries may be dead. Replace the batteries.</li><li>• If you have recently replaced the lamp unit, make sure the lamp unit and lamp unit door are installed properly.</li><li>• The lamp unit may need to be replaced. (See “LED indications” on page 64.)</li></ul>
No picture or too dark	<ul style="list-style-type: none"><li>• The lamp unit may need to be replaced.</li></ul>
No picture, no sound	<ul style="list-style-type: none"><li>• Check the antenna/cable connections.</li></ul>
No sound, picture OK	<ul style="list-style-type: none"><li>• The sound may be muted. Press VOLUME.</li><li>• The station may have broadcast difficulties. Try another channel.</li><li>• Make sure the SPEAKERS function in the AUDIO menu is set properly.</li></ul>
Poor picture, sound OK	<ul style="list-style-type: none"><li>• Check the antenna connections.</li><li>• The station may have broadcast difficulties. Try another channel.</li><li>• Adjust the PICTURE menu.</li></ul>
Poor reception of broadcast channels	<ul style="list-style-type: none"><li>• The station may have broadcast difficulties. Try another channel.</li><li>• Check the antenna connections.</li><li>• If you are using a VCR, make sure the TV/VCR button is set correctly.</li></ul>
Cannot receive above channel 13	<ul style="list-style-type: none"><li>• Make sure the TV/CABLE switch is set to the mode that corresponds with the signal source type (cable company or outside antenna).</li></ul>
Black box appears on the screen	<ul style="list-style-type: none"><li>• The closed caption feature may be set to one of the Text modes (T1, T2, T3, or T4). Turn closed captioning OFF.</li></ul>
Unable to select a certain channel	<ul style="list-style-type: none"><li>• The channel may be locked with the CH LOCK feature, or erased with the ADD/ERASE feature.</li></ul>
Multiple images	<ul style="list-style-type: none"><li>• The station may have broadcast difficulties. Try another channel.</li><li>• Antenna reception may be poor. Use a highly directional outdoor antenna.</li></ul>
Poor color or no color	<ul style="list-style-type: none"><li>• The station may have broadcast difficulties. Try another channel.</li><li>• Adjust the TINT and/or COLOR in the PICTURE menu.</li><li>• The lamp unit may need to be replaced.</li></ul>
No stereo or SAP sound from a known MTS broadcast	<ul style="list-style-type: none"><li>• Make sure the MTS feature is set properly.</li></ul>
The screen lights dimly and the fan continues to run when the power is OFF.	<ul style="list-style-type: none"><li>• The Quick Restart feature may be in ON mode. Set to OFF if you do not prefer this.</li></ul>
The remote control does not operate	<ul style="list-style-type: none"><li>• Make sure the appropriate device mode is selected.</li><li>• Remove all obstructions between the remote control and the remote control sensor in the TV.</li><li>• The remote control batteries may be dead. Replace the batteries.</li></ul>
Cannot access signal input sources (Video1, Video2, Video3, ColorStream HD1/HD2, HDMI1/2) and/or Channels 3 and 4.	<ul style="list-style-type: none"><li>• Check the VIDEO LOCK feature. (See page 45.)</li></ul>

# Limited United States Warranty for DLP Television Models

Toshiba America Consumer Products, L.L.C. ("TACP") makes the following limited warranties to original consumers in the United States.

THESE LIMITED WARRANTIES EXTEND TO THE ORIGINAL CONSUMER PURCHASER OR ANY PERSON RECEIVING THIS DLP TELEVISION AS A GIFT FROM THE ORIGINAL CONSUMER PURCHASER AND TO NO OTHER PURCHASER OR TRANSFEREE.

PRODUCTS PURCHASED IN THE U.S.A. AND USED IN CANADA ARE NOT COVERED BY THESE WARRANTIES.

PRODUCTS PURCHASED IN CANADA AND USED IN THE U.S.A. ARE NOT COVERED BY THESE WARRANTIES.

### Limited One (1) Year Warranty on Parts and Labor\*

TACP warrants this DLP television and its parts against defects in materials or workmanship for a period of one (1) year after the date of original retail purchase. DURING THIS PERIOD, TACP WILL, AT TACP'S OPTION, REPAIR OR REPLACE A DEFECTIVE PART WITH A NEW OR REFURBISHED PART WITHOUT CHARGE TO YOU FOR PARTS OR LABOR. TACP Authorized Service Station personnel will come to your home when warranty service is required. Depending on the type of repair required, either the service will be performed in your home or the set will be taken to the TACP Authorized Service Station for repair and returned to your home at no cost to you.

### Limited One (1) Year Warranty on Lamp Unit\*

TACP warrants the lamp unit in this DLP television against defects in materials or workmanship for a period of one (1) year after the date of original retail purchase. DURING THIS PERIOD, TACP WILL, AT TACP'S OPTION, EXCHANGE A DEFECTIVE LAMP UNIT WITH A NEW OR REFURBISHED LAMP UNIT WITHOUT CHARGE TO YOU. LABOR CHARGES FOR LAMP UNIT REPLACEMENT ARE NOT COVERED UNDER WARRANTY. The lamp unit is a user-replaceable component.

### Rental Units

The warranty for rental units, including the lamp units contained therein, begins with the date of first rental or thirty (30) days from the date of shipment to the rental firm, whichever comes first.

### \*Limited Warranty for Commercial Units

TACP warrants DLP televisions, including the lamp units contained therein, sold and used for commercial purposes as follows: all parts are warranted against defects in materials or workmanship for a period of ninety (90) days after the date of original purchase. DURING THIS PERIOD, TACP WILL, AT TACP'S OPTION, REPAIR OR REPLACE A DEFECTIVE PART WITH A NEW OR REFURBISHED PART WITHOUT CHARGE TO YOU.

### Owner's Manual and Product Registration

Read this owner's manual thoroughly before operating this DLP television.

Complete and mail the enclosed product registration card or register your product online at [www.tacp.toshiba.com/service](http://www.tacp.toshiba.com/service) as soon as possible. By registering your product you will enable TACP to provide you with better customer service and improved product support. Failure to register your product does not diminish your rights under this warranty.

### Your Responsibility

THE ABOVE WARRANTIES ARE SUBJECT TO THE FOLLOWING CONDITIONS:

- (1) You must provide your bill of sale or other proof of purchase.
- (2) All warranty servicing of this DLP television must be performed by an Authorized TACP Service Station.
- (3) These warranties from TACP are effective only if the DLP television is purchased and operated in the U.S.A. or Puerto Rico.
- (4) Labor charges for installation, setup, adjustment of customer controls, and installation or repair of antenna systems are not covered by these warranties. Reception problems caused by inadequate antenna systems are your responsibility.
- (5) Warranties extend only to defects in materials or workmanship as limited above, and do not extend to any DLP television or parts that have been lost or discarded by you or to damage to the DLP television or parts caused by fires, misuse, accident, Acts of God (such as lightning or fluctuations in electric power), improper installation, improper maintenance, or use in violation of instructions furnished by TACP; use or malfunction through simultaneous use of this product and connected equipment; or to units that have been modified or had the serial number removed, altered, defaced, or rendered illegible.

### How to Obtain Warranty Services

If, after following all of the operating instructions in this manual and checking the "Troubleshooting" section, you find that service is needed:

- (1) To find the nearest TACP Authorized Service Station, visit TACP's web site at [www.tacp.toshiba.com/service](http://www.tacp.toshiba.com/service) or call toll free 1-800-631-3811.
- (2) Present your bill of sale or other proof of purchase to the Authorized Service Station.

**For additional information, visit TACP's web site:  
[www.tacp.toshiba.com](http://www.tacp.toshiba.com).**

ALL WARRANTIES IMPLIED BY THE LAW OF ANY STATE OF THE U.S.A., INCLUDING THE IMPLIED WARRANTIES OF MERCHANTABILITY AND FITNESS FOR A PARTICULAR PURPOSE, ARE EXPRESSLY LIMITED TO THE DURATION OF THE LIMITED WARRANTIES SET FORTH ABOVE. WITH THE EXCEPTION OF ANY WARRANTIES IMPLIED BY THE LAW OF ANY STATE OF THE U.S.A. AS HEREBY LIMITED, THE FOREGOING WARRANTY IS EXCLUSIVE AND IN LIEU OF ALL OTHER WARRANTIES, GUARANTEES, AGREEMENTS, AND SIMILAR OBLIGATIONS OF TACP WITH RESPECT TO THE REPAIR OR REPLACEMENT OF ANY PARTS. IN NO EVENT SHALL TACP BE LIABLE FOR CONSEQUENTIAL OR INCIDENTAL DAMAGES (INCLUDING, BUT NOT LIMITED TO, LOST PROFITS, BUSINESS INTERRUPTION, OR MODIFICATION OR ERASURE OF RECORDED DATA CAUSED BY USE, MISUSE, OR INABILITY TO USE THIS PRODUCT).

No person, agent, distributor, dealer, or company is authorized to change, modify, or extend the terms of these warranties in any manner whatsoever. The time within which action must be commenced to enforce any obligation of TACP arising under this warranty or under any law of the United States or of any state thereof is hereby limited to 90 days from the date you discover, or should have discovered, the defect. This limitation does not apply to implied warranties arising under the law of any state of the U.S.A.

THIS WARRANTY GIVES YOU SPECIFIC LEGAL RIGHTS, AND YOU MAY ALSO HAVE OTHER RIGHTS, WHICH MAY VARY FROM STATE TO STATE IN THE U.S.A. SOME STATES OF THE U.S.A. DO NOT ALLOW LIMITATIONS ON THE DURATION OF AN IMPLIED WARRANTY, LIMITATIONS ON THE TIME WITHIN WHICH AN ACTION MAY BE BROUGHT, OR THE EXCLUSION OR LIMITATION OF INCIDENTAL OR CONSEQUENTIAL DAMAGES; THEREFORE, THE ABOVE LIMITATIONS OR EXCLUSIONS MAY NOT APPLY TO YOU UNDER SUCH CIRCUMSTANCES.

060904

Introduction

Connecting  
your TV

Using the  
Remote Control

Setting up  
your TV

Using the TV's  
Features

Appendix

Index



# Limited Canada Warranty

## for DLP Television Models

Toshiba of Canada Limited ("TCL") makes the following limited warranties to original consumers in Canada.

THESE LIMITED WARRANTIES EXTEND TO THE ORIGINAL CONSUMER PURCHASER OR ANY PERSON RECEIVING THIS DLP TELEVISION AS A GIFT FROM THE ORIGINAL CONSUMER PURCHASER AND TO NO OTHER PURCHASER OR TRANSFEREE.

PRODUCTS PURCHASED IN THE U.S.A. AND USED IN CANADA ARE NOT COVERED BY THESE WARRANTIES.

PRODUCTS PURCHASED IN CANADA AND USED IN THE U.S.A. ARE NOT COVERED BY THESE WARRANTIES.

### Limited One (1) Year Warranty on Parts and Labor\*

TCL warrants this DLP television and its parts against defects in materials or workmanship for a period of one (1) year after the date of original retail purchase. DURING THIS PERIOD, TCL WILL, AT TCL'S OPTION, REPAIR OR REPLACE A DEFECTIVE PART WITH A NEW OR REFURBISHED PART WITHOUT CHARGE TO YOU FOR PARTS OR LABOR. TCL Authorized Service Depot personnel will come to your home when warranty service is required. Depending on the type of repair required, either the service will be performed in your home or the set will be taken to the TCL Authorized Service Depot for repair and returned to your home at no cost to you. **IN-HOME SERVICE ONLY APPLIES WITHIN 100 KILOMETERS OF AN AUTHORIZED TCL SERVICE DEPOT.**

### Limited One (1) Year Warranty on Lamp Unit\*

TCL warrants the lamp unit in this DLP television against defects in materials or workmanship for a period of one (1) year after the date of original retail purchase. DURING THIS PERIOD, TCL WILL, AT TCL'S OPTION, EXCHANGE A DEFECTIVE LAMP UNIT WITH A NEW OR REFURBISHED LAMP UNIT WITHOUT CHARGE TO YOU. LABOR CHARGES FOR LAMP UNIT REPLACEMENT ARE NOT COVERED UNDER WARRANTY. The lamp unit is a user-replaceable component.

### Rental Units

The warranty for rental units, including the lamp units contained therein, begins with the date of first rental or thirty (30) days from the date of shipment to the rental firm, whichever comes first.

### \*Limited Warranty for Commercial Units

TCL warrants DLP televisions, including the lamp units contained therein, sold and used for commercial purposes as follows: all parts are warranted against defects in materials or workmanship for a period of ninety (90) days after the date of original purchase. DURING THIS PERIOD, TCL WILL, AT TCL'S OPTION, REPAIR OR REPLACE A DEFECTIVE PART WITH A NEW OR REFURBISHED PART WITHOUT CHARGE TO YOU. **ON-SITE SERVICE ONLY APPLIES WITHIN 100 KILOMETERS OF AN AUTHORIZED TCL SERVICE DEPOT.**

### Owner's Manual and Product Registration

Read this owner's manual thoroughly before operating this DLP television.

Register your product online at [www.toshiba.ca](http://www.toshiba.ca) as soon as possible. By registering your product you will enable TCL to provide you with better customer service and improved product support. Failure to register your product does not diminish your rights under this warranty.

### Your Responsibility

THE ABOVE WARRANTIES ARE SUBJECT TO THE FOLLOWING CONDITIONS:

- (1) You must provide your bill of sale or other proof of purchase.
- (2) All warranty servicing of this DLP television must be performed by an Authorized TCL Service Depot.
- (3) These warranties from TCL are effective only if the DLP television is purchased in Canada from an authorized TCL dealer and operated in Canada.
- (4) Labor charges for installation, setup, adjustment of customer controls, and installation or repair of antenna systems are not covered by these warranties. Reception problems caused by inadequate antenna systems are your responsibility.
- (5) Warranties extend only to defects in materials or workmanship as limited above, and do not extend to any DLP television or parts that have been lost or discarded by you or to damage to the television or parts caused by fires, misuse, accident, Acts of God (such as lightning or fluctuations in electric power), improper installation, improper maintenance, or use in violation of instructions furnished by TCL; use or malfunction through simultaneous use of this product and connected equipment; or to units that have been modified or had the serial number removed, altered, defaced, or rendered illegible.

### How to Obtain Warranty Services

If, after following all of the operating instructions in this manual and checking the "Troubleshooting" section, you find that service is needed:

- (1) To find the nearest TCL Authorized Service Depot, visit TCL's web site at [www.toshiba.ca](http://www.toshiba.ca).
- (2) Present your bill of sale or other proof of purchase to the Authorized Service Depot.

**For additional information, visit TCL's web site:  
[www.toshiba.ca](http://www.toshiba.ca)**

ALL WARRANTIES IMPLIED BY THE LAW OF ANY PROVINCE OF CANADA, INCLUDING THE IMPLIED WARRANTIES OF MERCHANTABILITY AND FITNESS FOR A PARTICULAR PURPOSE, ARE EXPRESSLY LIMITED TO THE DURATION OF THE LIMITED WARRANTIES SET FORTH ABOVE. WITH THE EXCEPTION OF ANY WARRANTIES IMPLIED BY THE LAW OF ANY PROVINCE OF CANADA AS HEREBY LIMITED, THE FOREGOING WARRANTY IS EXCLUSIVE AND IN LIEU OF ALL OTHER WARRANTIES, GUARANTEES, AGREEMENTS, AND SIMILAR OBLIGATIONS OF TCL WITH RESPECT TO THE REPAIR OR REPLACEMENT OF ANY PARTS. IN NO EVENT SHALL TCL BE LIABLE FOR CONSEQUENTIAL OR INCIDENTAL DAMAGES (INCLUDING, BUT NOT LIMITED TO, LOST PROFITS, BUSINESS INTERRUPTION, OR MODIFICATION OR ERASURE OF RECORDED DATA CAUSED BY USE, MISUSE, OR INABILITY TO USE THIS PRODUCT).

No person, agent, distributor, dealer, or company is authorized to change, modify, or extend the terms of these warranties in any manner whatsoever. The time within which action must be commenced to enforce any obligation of TCL arising under this warranty or under any law of Canada or of any province thereof is hereby limited to 90 days from the date you discover, or should have discovered, the defect. This limitation does not apply to implied warranties arising under the law of any province of Canada.

THIS WARRANTY GIVES YOU SPECIFIC LEGAL RIGHTS, AND YOU MAY ALSO HAVE OTHER RIGHTS, WHICH MAY VARY FROM PROVINCE TO PROVINCE IN CANADA. SOME PROVINCES OF CANADA DO NOT ALLOW LIMITATIONS ON THE DURATION OF AN IMPLIED WARRANTY, LIMITATIONS ON THE TIME WITHIN WHICH AN ACTION MAY BE BROUGHT, OR THE EXCLUSION OR LIMITATION OF INCIDENTAL OR CONSEQUENTIAL DAMAGES; THEREFORE, THE ABOVE LIMITATIONS OR EXCLUSIONS MAY NOT APPLY TO YOU UNDER SUCH CIRCUMSTANCES.

060904



## Index

### A

A/V cables (standard) .....	8
ANT 1/2 .....	26
Antenna cables (coaxial) .....	8
AUDIO OUT sound, selecting .....	58
Audio system connection .....	16
Auto aspect .....	35
Auto favorite .....	39, 43
Auto power off .....	59

### B

BACKGROUND selection .....	59
Back of the TV .....	7

### C

CableClear™ DNR .....	48
Cable converter box connection .....	10
Camcorder connection .....	14
CH ▲▼ buttons .....	28
Channel Return .....	29
CH LABELING .....	31
CH LOCK .....	43
CH RTN button .....	29
Channel Number buttons .....	28
Channel programming	
ADD/ERASE .....	28
Automatic programming .....	27
TV/CABLE selection .....	27
Cinema mode .....	49
Clock, setting .....	53
Closed caption .....	51
Color temperature .....	47
ColorStream (component) cables .....	8

### D

Dolby Virtual Sound .....	56
Double-window ("POP") feature .....	36
DTV receiver connection .....	13
DVD connection .....	11, 12

### F G H

FAV ▲▼ buttons .....	30
FAVORITE button .....	39
Favorite channels, programming .....	29
Front of the TV .....	7
HDMI™ connection .....	15

### L M

Labeling channels .....	31
Labeling video inputs .....	50
Lamp mode .....	49
Lamp unit replacement .....	60-64
Language selection .....	26
Last mode memory .....	59
Locking channels .....	43
Locking video inputs .....	45
Locks menu .....	40
Menu system .....	25
MTS feature .....	54
MUTE button .....	54

### O P

ON timer .....	52
Picture adjustments	
COLOR TEMPERATURE .....	47
Picture mode .....	46
Picture quality .....	46
Picture-out-picture (POP)	
CH SCAN button .....	38
POP CH ▲▼ buttons .....	36
POP DIRECT CH button .....	36
SOURCE button .....	36
SPLIT button .....	36
SWAP button .....	37
Picture scroll .....	34
Picture size selection .....	32
POP Window .....	36
POWER button .....	24

### Q R

Quick restart .....	28
RECALL button .....	59
Remote control	
Battery installation .....	17
Learning about the buttons .....	24
Programming .....	20
RESET .....	48, 57

### S

SAP sound .....	54
Satellite receiver connection .....	11
Scrolling the TheaterWide® picture .....	34
Set-top box .....	13
Sleep timer .....	52
Sound quality adjustments .....	55
SPEAKERS on/off .....	58
Specifications .....	65
SRS 3D surround .....	55
StableSound® .....	57
Stereo sound .....	54
SurfLock™ .....	29
S-video cables .....	8

### T

TheaterWide picture .....	33
Troubleshooting .....	66
TV/VIDEO button .....	26, 50

### V

V-CHIP	
BLOCKING OPTION .....	42
ENABLE BLOCKING .....	41
MPAA RATING .....	42
NEW PIN CODE .....	45
TV RATING .....	41
Unlocking programs temporarily .....	43
VCR connection .....	9
VIDEO LABEL .....	50
VIDEO LOCK .....	45

### W

Warranty .....	67, 68
WOW surround sound feature .....	55

---

## Notes

---

## Notes

## **TOSHIBA AMERICA CONSUMER PRODUCTS, L.L.C.**

HEAD OFFICE: 82 TOTOWA ROAD, WAYNE, NJ 07470, U.S.A.  
NATIONAL SERVICE DIVISION: 1420-B TOSHIBA DRIVE, LEBANON, TN 37087, U.S.A.

## **TOSHIBA OF CANADA LTD.**

HEAD OFFICE: 191 McNABB STREET, MARKHAM, ONTARIO, L3R 8H2, CANADA – TEL: (905) 470-5400

### SERVICE CENTERS:

TORONTO: 191 McNABB STREET, MARKHAM, ONTARIO L3R 8H2, CANADA – TEL: (905) 470-5400  
MONTREAL: 18050 TRANS CANADA, KIRKLAND, QUEBEC, H9J 4A1, CANADA – TEL: (514) 390-7766  
VANCOUVER: 22171 FRASERWOOD WAY, RICHMOND, B.C., V6W 1J5, CANADA – TEL: (604) 303-2500

### MANUFACTURED BY

## **TOSHIBA AMERICA CONSUMER PRODUCTS, L.L.C.**

Manufactured under license from Dolby Laboratories.

Dolby and the double-D symbol are trademarks of Dolby Laboratories.

WOW, SRS, and ● symbol are trademarks of SRS Labs, Inc.

WOW technology is incorporated under license from SRS Labs, Inc.

ColorStream, StableSound, and TheaterWide are registered trademarks of Toshiba America Consumer Products, L.L.C.

CableClear and SurfLock are trademarks of Toshiba America Consumer Products, L.L.C.

The DLP logo and DLP medallion are trademarks of Texas Instruments.

PRINTED IN USA  
(04-10) R1

# **TOSHIBA**

23566348

## Free Manuals Download Website

<http://myh66.com>

<http://usermanuals.us>

<http://www.somanuals.com>

<http://www.4manuals.cc>

<http://www.manual-lib.com>

<http://www.404manual.com>

<http://www.luxmanual.com>

<http://aubethermostatmanual.com>

Golf course search by state

<http://golfingnear.com>

Email search by domain

<http://emailbydomain.com>

Auto manuals search

<http://auto.somanuals.com>

TV manuals search

<http://tv.somanuals.com>