

# TOSHIBA

*OWNER'S MANUAL*

## DATA PROJECTOR

---

### TDP-T90

(XGA)

### TDP-T91

(XGA/ With Document Camera)

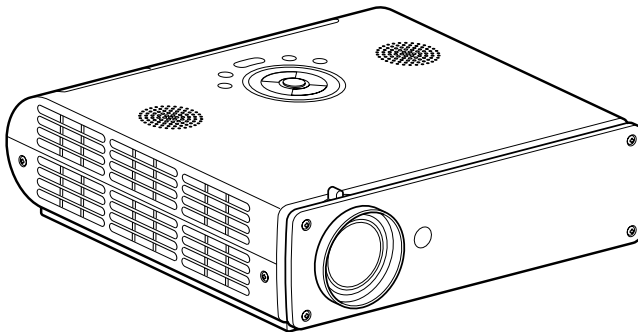

Before Using

Preparations

Operations

Maintenance

Others

# SAFETY PRECAUTIONS



The lightning flash with arrowhead symbol, within an equilateral triangle, is intended to alert the user to the presence of uninsulated "dangerous voltage" within the product's enclosure that may be of sufficient magnitude to constitute a risk of electric shock to persons.



The exclamation point within an equilateral triangle is intended to alert the user to the presence of important operating and maintenance (servicing) instructions in the literature accompanying the appliance.

**WARNING:** TO REDUCE THE RISK OF FIRE OR ELECTRIC SHOCK, DO NOT EXPOSE THIS APPLIANCE TO RAIN OR MOISTURE. DANGEROUS HIGH VOLTAGES ARE PRESENT INSIDE THE ENCLOSURE. DO NOT OPEN THE CABINET. REFER SERVICING TO QUALIFIED PERSONNEL ONLY.

**WARNING:** Handling the cord on this product or cords associated with accessories sold with this product, will expose you to lead, a chemical known to the State of California to cause birth defects or other reproductive harm. **Wash hands after handling.**

**WARNING:** This [product] contains mercury. Disposal of mercury may be regulated due to environmental considerations. For disposal or recycling information, please contact your local authorities or the Electronic Industries Alliance: [www.eiae.org](http://www.eiae.org).

**MODEL NAME: TDP-T90** **USA only**

TRADE NAME: DATA PROJECTOR      MODEL NAME: TDP-T90  
**FC** Tested To Comply  
With FCC Standards  
FOR HOME OR OFFICE USE

**FCC NOTICE:** This device complies with part 15 of the FCC Rules. Operation is subject to the following two conditions:

(1) This device may not cause harmful interference, and (2) this device must accept any interference received, including interference that may cause undesired operation.

This equipment has been tested and found to comply with the limits for a Class B digital device, pursuant to part 15 of the FCC Rules. These limits are designed to provide reasonable protection against harmful interference in a residential installation. This equipment generates, uses and can radiate radio frequency energy and, if not installed and used in accordance with the instructions, may cause harmful interference to radio communications.

However, there is no guarantee that interference will not occur in a particular installation. If this equipment does cause harmful interference to radio or television reception, which can be determined by turning the equipment off and on, the user is encouraged to try to correct the interference by one or more of the following measures:

- Reorient or relocate the receiving antenna.
- Increase the separation between the equipment and receiver.
- Connect the equipment into an outlet on a circuit different from that to which the receiver is connected.
- Consult the dealer or an experienced radio/TV technician for help.

RESPONSIBLE PARTY: TOSHIBA AMERICA INFORMATION SYSTEMS, INC.  
9740 Irvine Blvd., Irvine, CA 92618-1697 U.S.A  
Phone: (949) 583-3000

**WARNING:** Changes or modifications made to this equipment, not expressly approved by Toshiba, or parties authorized by Toshiba, could void the user's authority to operate the equipment.  
**USA only**

**Notice:** This Class B digital apparatus complies with Canadian ICES-003. Cet appareil numérique de la classe B est conforme à la norme NMB-003 du Canada.  
**CANADA only**

**MODEL NAME: TDP-T91**

FCC Radio Frequency Interference Statement

**Note:** This equipment has been tested and found to comply with the limits for a Class B digital device, pursuant to part 15 of the FCC Rules. These limits are designed to provide reasonable protection against harmful interference when the equipment is operated in a commercial environment. This equipment generates, uses, and can radiates radio frequency energy and, if not installed and used in accordance with the instruction manual, may cause harmful interference to radio communications. Operation of this equipment in a residential area is likely to cause harmful interference in which case the user will be required to correct the interference at his own expense.  
**USA only**

**WARNING:** Changes or modifications made to this equipment, not expressly approved by Toshiba, or parties authorized by Toshiba, could void the user's authority to operate the equipment.  
**USA only**

**Notice:** This Class A digital apparatus complies with Canadian ICES-003. Cet appareil numérique de la classe A est conforme à la norme NMB-003 du Canada.  
**CANADA only**

**WARNING:** This is a Class A product. In a domestic environment this product may cause radio interference in which case the user may be required to take adequate measures.

# IMPORTANT SAFETY INSTRUCTIONS

**CAUTION: PLEASE READ AND OBSERVE ALL WARNINGS AND INSTRUCTIONS GIVEN IN THIS OWNER'S MANUAL AND THOSE MARKED ON THE UNIT. RETAIN THIS BOOKLET FOR FUTURE REFERENCE.**

This set has been designed and manufactured to assure personal safety. Improper use can result in electric shock or fire hazard. The safeguards incorporated in this unit will protect you if you observe the following procedures for installation, use and servicing. This unit is fully transistorized and does not contain any parts that can be repaired by the user.

**DO NOT REMOVE THE CABINET COVER, OR YOU MAY BE EXPOSED TO DANGEROUS VOLTAGE. REFER SERVICING TO QUALIFIED SERVICE PERSONNEL ONLY.**

## 1. Read Owner's Manual

After unpacking this product, read the owner's manual carefully, and follow all the operating and other instructions.

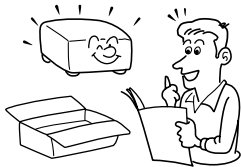

## 2. Power Sources

This product should be operated only from the type of power source indicated on the marking label. If you are not sure of the type of power supply to your home, consult your product dealer or local power company. For products intended to operate from battery power, or other sources, refer to the operating instructions.



## 3. Source of Light

Do not look into the lens while the lamp is on. The strong light from the lamp may cause damage to your eyes or sight.



## 4. Ventilation

Openings in the cabinet are provided for ventilation and to ensure reliable operation of the product and to protect it from overheating, and these openings must not be blocked or covered. The openings should never be blocked by placing the product on a bed, sofa, rug or other similar surface. This product should not be placed in a built-in installation such as a bookcase or rack unless proper ventilation is provided or the manufacturer's instructions have been adhered to.



## 5. Heat

The product should be situated away from heat sources such as radiators, heat registers, stoves, or other products (including amplifiers) that produce heat.

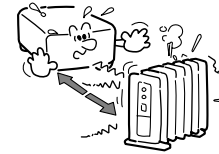

## 6. Water and Moisture

Do not use this product near water. - for example, near a bath tub, wash bowl, kitchen sink, or laundry tub; in a wet basement; or near a swimming pool and the like.

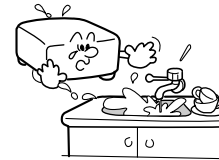

## 7. Cleaning

Unplug this product from the wall outlet before cleaning. Do not use liquid cleaners or aerosol cleaners. Use a soft cloth for cleaning.

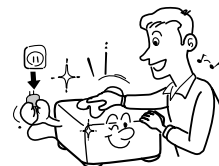

## 8. Power-Cord Protection

Power-supply cords should be routed so that they are not likely to be walked on or pinched by items placed upon or against them, paying particular attention to cords at plugs, convenience receptacles, and the point where they exit from the product.



## 9. Overloading

Do not overload wall outlets; extension cords, or integral convenience receptacles as this can result in a risk of fire or electric shock.

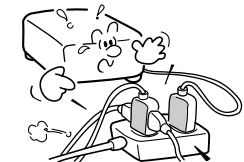

## IMPORTANT SAFETY INSTRUCTIONS (Continued)

### 10. Lightning storms

For added protection for this product during storm, or when it is left unattended and unused for long periods of time, unplug it from the wall outlet. This will prevent damage to the product due to lightning and power-line surges. However, while it is thundering or lightning, do not touch the apparatus and any connected cable and/or equipment. This will prevent you from receiving the electric shock by an electric surge.

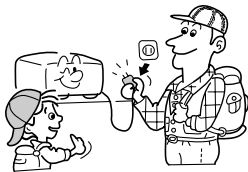

### 11. Object and Liquid Entry

Never push objects of any kind into this product through openings as they may touch dangerous voltage points or short-out parts that could result in a fire or electric shock. Never spill liquid of any kind on the product.



### 12. Do not place the product vertically

Do not use the product in the upright position to project the pictures at the ceiling, or any other vertical positions. It may fall down and dangerous.

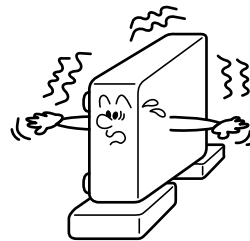

### 13. Stack Inhibited

Do not stack other equipment on this product or do not place this product on the other equipment. Top and bottom plates of this product develops heat and may give some undesirable damage to other unit.

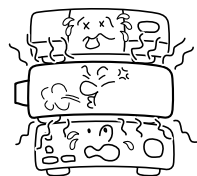

### 14. Attachments

Do not use attachments not recommended by the product manufacturer as they may cause hazards.

### 15. Accessories

Do not place this product on an unstable cart, stand, tripod, bracket, or table. The product may fall, causing serious injury to a child or adult, and serious damage to the product. A product and cart combination should be moved with care. Quick stops, excessive force, and uneven surfaces may cause the product and cart combination to overturn.



### 16. Damage Requiring Service

Unplug this product from the wall outlet and refer servicing to qualified service personnel under the following conditions:

- When the power-supply cord or plug is damaged.
- If liquid has been spilled, or objects have fallen into the product.
- If the product has been exposed to rain or water.
- If the product does not operate normally by following the operating instructions. Adjust only those controls that are covered by the operating instructions as an improper adjustment of other controls may result in damage and will often require extensive work by a qualified technician to restore the product to its normal operation.

- If the product has been dropped or damaged in any way.
- When the product exhibits a distinct change in performance - this indicates a need for service.

### 17. If glass components, including lens and lamp, should break, contact your dealer for repair service.

This product incorporates glass components, including a lens and a lamp. If such parts should break, please handle with care to avoid injury and contact your dealer for repair service. The broken pieces of glass may cause to injury. In the unlikely event of the lamp rupturing, thoroughly clean the area around the projector and discard any edible items placed in that area.

### 18. Servicing

Do not attempt to service this product yourself as opening or removing covers may expose you to dangerous voltage or other hazards. Refer all servicing to qualified service personnel.



## IMPORTANT SAFETY INSTRUCTIONS (Continued)

### 19. Replacement Parts

When replacement parts are required, be sure the service technician has used replacement parts specified by the manufacturer or have the same characteristics as the original part. Unauthorized substitutions may result in fire, electric shock, or other hazards. (Replacement of the lamp only should be made by users.)

### 20. Safety Check

Upon completion of any service or repairs to this product, ask the service technician to perform safety checks to determine that the product is in proper operating condition.

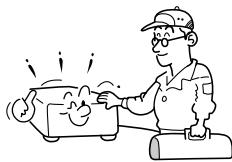

### 21. Do not leave thermal-paper documents or easily deformed items on top of the unit or near the air exhaust for long periods of time.

The heat from the unit could erase the information on the thermal paper, or cause deformation or warping.

### 22. Do not get your hands between the camera arm and the main unit when setting the camera arm back in its original position. (Models equipped with document camera)

To avoid injury, be careful not to get your hands caught when setting the camera arm back in its original position. Families with children should be particularly careful.

### 23. Do not carry by the camera arm. (Models equipped with document camera)

Do not carry the projector by the camera arm. Doing so can result in damage or injury.

### 24. Do not move the projector while the arm is still erect. (Models equipped with document camera)

Always store the arm back in position when moving the projector. Otherwise injury or damage may result.

### 25. Do not use the product in a closed installation state.

Do not place the product in a box or in any other closed installation state. Otherwise it may overheat. This could result in a risk of fire.

## POWER SUPPLY CORD SELECTION

If your line voltage is 220 to 240V, use one of the following types of cable.

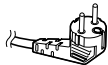
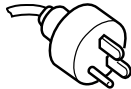
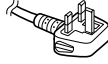
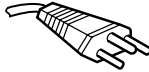
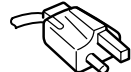
Plug configuration	Plug type	Line voltage	Plug configuration	Plug type	Line voltage
	EURO	220 – 240V		Australian 240V 10A	200 – 240V
	UK	220 – 240V		Switzerland 240V 6A	200 – 240V
				North American 240V 15A	200 – 240V

Use a 5A fuse which is approved by ASTA or BSI to BSI362. Always replace the fuse cover after changing the fuse.

## IMPORTANT PRECAUTIONS

### Save Original Packing Materials

The original shipping carton and packing materials will come in handy if you ever have to ship your projector. For maximum protection, repack the set as it was originally packed at the factory.

### Moisture Condensation

Never operate this unit immediately after moving it from a cold location to a warm location. When the unit is exposed to such a change in temperature, moisture may condense on the crucial internal parts. To prevent the unit from possible damage, do not use the unit for at least 2 hours when there is an extreme or sudden change in temperature.

### Place and Manner of Installation

- Do not place in hot locations, such as near heating equipment. Doing so could cause malfunction, and shorten the life of the projector.
- Avoid locations with oil or cigarette smoke. Doing so will dirty the optical parts, shortening their lives, and darkening the screen.
- Do not use the product vertically in any upright position or slantwise in an angle of 20 degrees or more.
- Using this instrument near a TV or radio may cause interference to the images or audio sound. If this happens, move it away from the TV or radio.
- Moving the projector from a low-temperature room to a high-temperature room may cause condensation on the lens or internal parts in the instrument. If you continue to use it in that situation, the malfunction may result. Ensure to wait until the condensation naturally disappears.
- In a high altitude location where air is thin, cooling efficiency is reduced so use it with the ambient temperature being lowered.

## IMPORTANT PRECAUTIONS (Continued)

### Avoid Volatile Liquid

Do not use volatile liquids, such as an insect spray, near the unit. Do not leave rubber or plastic products touching the unit for a long time. They will leave marks on the finish. If cleaning with a chemically saturated cloth, be sure to follow the product's precautions.

In the spaces provided below, record the Model and Serial No. located at the bottom of your projector.

Model No. \_\_\_\_\_ Serial No. \_\_\_\_\_

Retain this information for future reference.

## EXEMPTION CLAUSES

- Toshiba Corporation bears no responsibility in the case of damages arising from natural disaster such as earthquakes, lightning, etc., fire not liable to Toshiba Corporation, operation, theft or mischief by third parties, other accidents, or use under abnormal conditions including erroneous or improper operation and other problems.
- Toshiba Corporation bears no responsibility for incidental damages (lost profit, work interruption, corruption or loss of the memory contents, etc.) arising from the use of or the inability to use this unit.
- Toshiba Corporation accepts no liability whatsoever for any damages arising from not having followed the descriptions in this Instruction Manual.
- Toshiba Corporation accepts no liability whatsoever for any damages arising from malfunctions arising from combination with equipment or software that is not related to Toshiba Corporation.

## OTHER CAUTIONS AND INFORMATIONS

### Copyrights

Showing or transmitting commercial imaging software or broadcast or cable-broad casting programs with the purpose of other than the personal and private viewing, including modifying images using the freeze or resize functions, or displaying with the varying aspect ratio of the images, could violate the direct or indirect copyrights of the imaging software or broadcast program, etc., if done without first consulting with the copyright holder. For this reason, please take appropriate measures before performing one of the actions listed above, including obtaining a license from the copyright holder.

### Disposal

This product contains substances which are harmful to humans and the environment.

- Solder used in the internal parts contains the lead.
- The lamp contains inorganic mercury.

Please dispose of this product or used lamps in accordance with local regulations.

### Trademarks

- VGA, SVGA, XGA, SXGA, UXGA are trademarks or registered trademarks of International Business Machines Corporation.
- Digital Light Processing, Digital Micromirror Device and DMD are trademarks of Texas Instruments.
- Macintosh is a registered trademark of Apple Computer, Inc.
- Windows is a registered trademark of Microsoft Corporation in the U.S. and other countries.
- Adobe is a registered trademark and Acrobat Reader is a trademark of Adobe Systems Incorporated.

### Notational Conventions Used in This Manual

- References to pages with related information are annotated as follows. For example, if making a reference to page 36: [p.36](#)
- The illustrations in this document are for reference purposes only and may not reflect your package exactly.

## REMOTE CONTROL BATTERIES

- Be sure to use AA size batteries.
- Do not reverse the polarity when inserting the battery.
- Do not recharge, heat, disassemble, short-circuit, or burn the battery.
- Do not use the battery beyond the expiration date indicated on the battery or leave a dead battery in the remote control.
- Do not mix batteries of different types, such as alkaline and manganese. Do not mix new and used batteries.

Using the batteries improperly may cause them to explode or leak and lead to burn or injury. If battery-leaking fluid contacts skin, wash the fluid off immediately with clean water and consult a doctor. If the fluid is spilt on an instrument, avoid contact and wipe it off using tissue paper. (Dispose of the used tissue paper as flammable garbage after moistening with water.)

# CONTENTS

## Before Using

SAFETY PRECAUTIONS .....	2
IMPORTANT SAFETY INSTRUCTIONS .....	4
POWER SUPPLY CORD SELECTION .....	9
IMPORTANT PRECAUTIONS .....	9
EXEMPTION CLAUSES .....	10
OTHER CAUTIONS AND INFORMATIONS .....	11
REMOTE CONTROL BATTERIES .....	11
CONTENTS .....	12

## Preparations

Checking the package contents .....	14
Names of each part on the main unit .....	15
Names of each part on the control panel and remote control .....	16
Parts on the rear panel .....	17
Names of each part on the document camera (TDP-T91) .....	18
Preparing and using the remote control .....	19
Placement .....	20
Connection .....	21

## Operations

Turning the power on and off .....	22
Basic operations .....	24
Using handy features .....	26
Using auto setting .....	26
Cutting off the picture and sound temporarily (Mute) .....	28
Freezing the image (Freeze) .....	28
Using the menus .....	29
How to use the menus .....	29
The image adjustment menu .....	30
The display setting menu .....	31
The default setting menu .....	32
Displaying Information (Status display) .....	33
Using the document camera .....	34
How to use the document camera .....	34
Image projection with the document camera .....	36
Locking the white balance .....	37

## Maintenance

About lamp .....	38
Lamp replacement .....	38
Lens and main unit cleaning .....	40

## Others

Trouble indications .....	41
Before calling service personnel .....	42
Specifications .....	44
List of general specifications .....	44
Document camera specifications (TDP-T91) .....	44
List of supported signals (RGB signals) .....	45
List of supported signals (Y/Pb/Pr signals) .....	46
List of supported signals (Video, S-Video signals) .....	46
Pin assignment of COMPUTER-1/2 & MONITOR terminals .....	46
CONTROL terminal .....	47
Separately sold product .....	47

## Checking the package contents

Please make sure that the following items are included in the box, along with the main unit. If any item is missing, please contact the store immediately where you purchased the product.

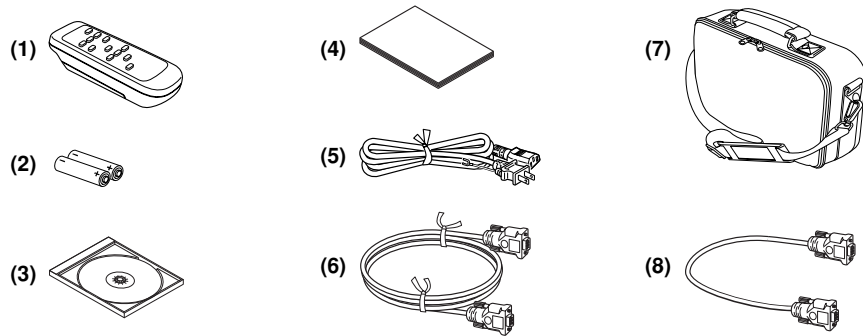

- (1) Remote control
- (2) R6 (SIZE AA) batteries for remote control (2)
- (3) CD-ROM
- (4) Owner's Manual
- (5) Power cord (See note)
- (6) RGB cable (3m)
- (7) Carrying bag
- (8) RGB cable (25cm)\*

\*: Supplied with TDP-T91

### Note

The shape and number of supplied power cords vary depending on the product destination.

### ◆The Supplied CD-ROM

The supplied CD-ROM contains an owner's manual, including information not available for the printed Owner's manual (Getting started) and Acrobat® Reader™ to view the manual.

#### ■ Installing Acrobat® Reader™

Windows®: Run the CD-ROM, select the **Reader/English** folder, and run **ar500enu.exe**. Follow the on-screen instructions.

Macintosh: Run the CD-ROM, select the **Reader/English** folder, and run **Reader Installer**. Follow the on-screen instructions to install the software.

#### ■ Viewing the manual

Run the CD-ROM and double-click on **Start.pdf**. Acrobat® Reader™ launches, and the menu screen of the Owner's manual appears. Click on your language. The Owner's Manual cover and list of bookmarks appear. Click on a bookmark title to view that section of the manual. Click on [p. 16](#) to view a reference page with related information. See the Help menu for more information about Acrobat® Reader™.

## Names of each part on the main unit

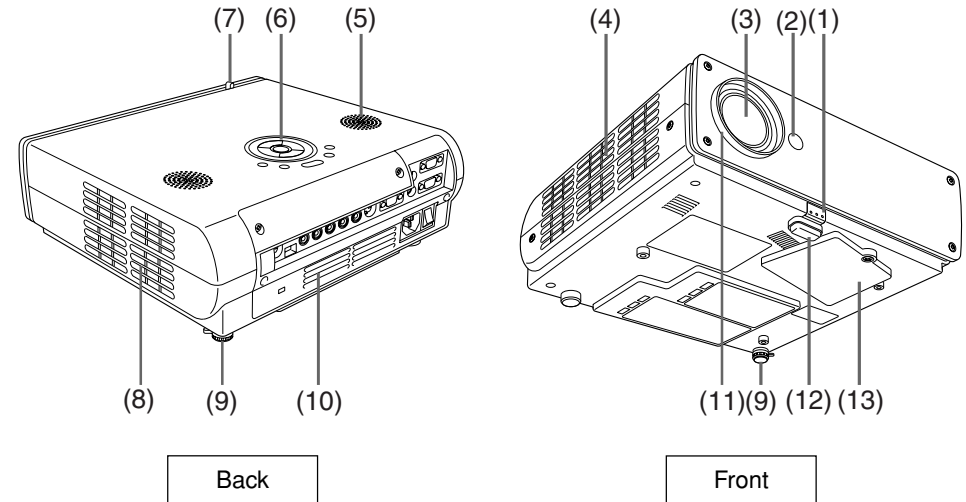

Name	Function
(1) Foot adjuster release button	: Press to stow the foot adjuster. <a href="#">p.25</a>
(2) Infrared remote sensor	: Senses commands from the remote control. <a href="#">p.19</a>
(3) Lens	: Projects expanded image.
(4) Air intake	: Draws in air from outside the projector.
(5) Speaker	: Outputs audio sound.
(6) Control panel	: Operates the projector. <a href="#">p.16</a>
(7) Zooming lever	: Adjusts screen size. <a href="#">p.25</a>
(8) Air exhaust	: Expels air that has grown hot inside the projector.
(9) Tilt adjuster	: Adjusts the projector's horizontal tilt. <a href="#">p.25</a>
(10) Rear panel	: Connects external devices. <a href="#">p.17</a>
(11) Focusing lever	: Adjusts screen focus. <a href="#">p.25</a>
(12) Foot adjuster	: Adjusts the vertical projection angle. <a href="#">p.25</a>
(13) Lamp cover	: Remove to replace lamp. <a href="#">p.39</a>



## Names of each part on the control panel and remote control

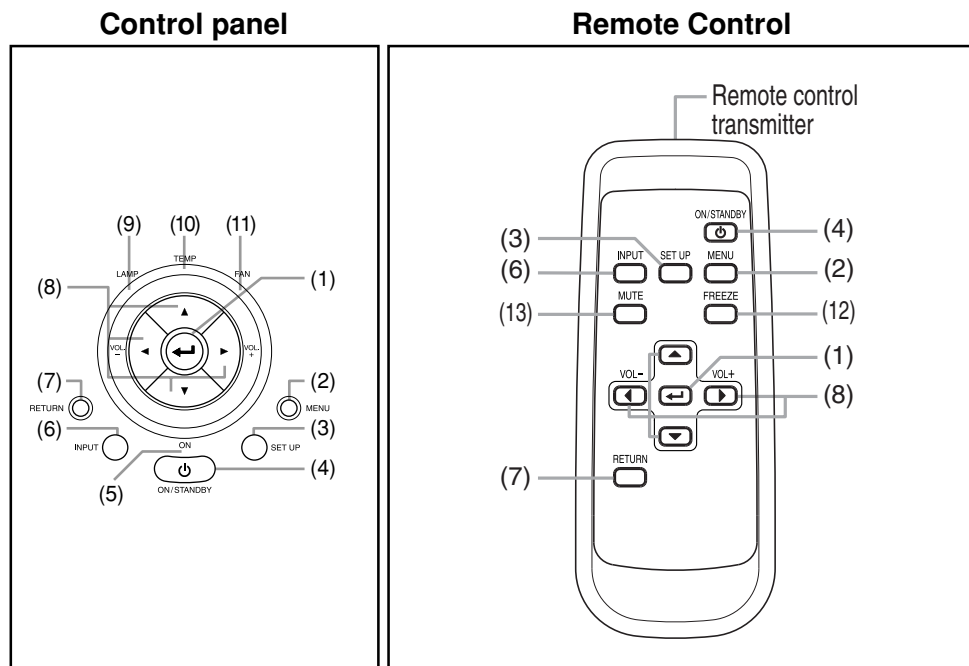

Name	Main Function
(1) ENTER button	: Accepts the selected mode.
(2) MENU button	: Displays menus. <a href="#">p.29</a>
(3) SET UP button	: Sets up image and mode. <a href="#">p.26</a>
(4) ON/STANDBY button	: Turns the power on/off (standby). <a href="#">p.22</a>
(5) ON indicator	: Displays whether power is on or off. <a href="#">p.22</a>
(6) INPUT button	: Selects input. <a href="#">p.24</a>
(7) RETURN button	: Goes back one screen.
(8) Selection button	: Menu selections and adjustments, etc. <a href="#">p.30</a>
(9) LAMP indicator	: Displays lamp mode. <a href="#">p.23</a>
(10) TEMP indicator	: Lights when internal temperature too high. <a href="#">p.41</a>
(11) FAN indicator	: Displays cooling fan mode. <a href="#">p.41</a>
(12) FREEZE button	: Pauses image. <a href="#">p.28</a>
(13) MUTE button	: Cuts off the picture and sound temporarily. <a href="#">p.28</a>

### Note

- For the remainder of this manual, buttons are referred to as follows:  
Selection buttons ⇒ ; ENTER button ⇒

## Parts on the rear panel

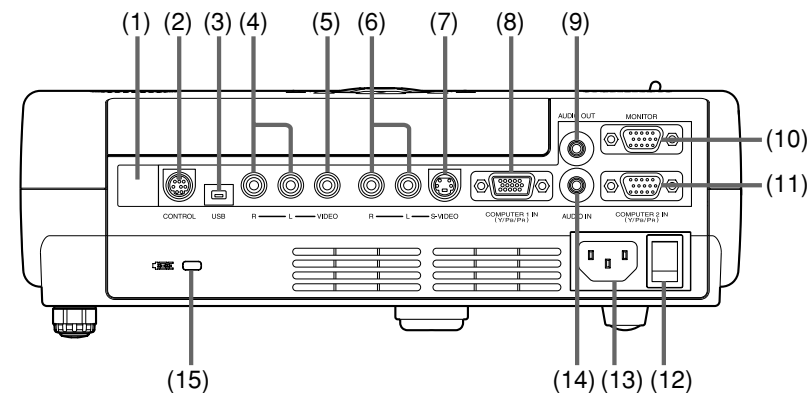

Name	Main Function
(1) Infrared remote sensor	: Senses commands from the remote control. <a href="#">p.19</a>
(2) CONTROL terminal	: When operating the projector via a computer, connect this to the controlling computer's RS-232C port. <a href="#">p.47</a>
(3) USB terminal	: Terminal for service purpose. Do not make any connection.
(4) AUDIO (L/R) terminal	: Input audio signals from video equipment.
(5) VIDEO terminal	: Input video signals from video equipment.
(6) AUDIO (L/R) terminal	: Input audio signals from video equipment.
(7) S-VIDEO terminal	: Input S video signals from video equipment.
(8) COMPUTER 1 terminal	: Input RGB signal from a computer or other source, or a component video signal (Y/Pb/Pr) from video equipment.
(9) AUDIO OUT terminal	: Outputs audio signals.
(10) MONITOR terminal	: Connect to a computer display, etc.
(11) COMPUTER 2 terminal	: Input RGB signal from a computer or other source, or a component video signal (Y/Pb/Pr) from video equipment. For TDP-T91, use exclusively for document camera connection.
(12) Main power switch	: AC power line ON (standby)/OFF.
(13) AC IN socket	: Connect the supplied power cord here.
(14) AUDIO IN terminal	: Input audio signals from a computer or video equipment with a component video signal output terminal.
(15) Antitheft lock hole	: Attach a safety cable or any other antitheft device.

### Note

- Although this owner's manual abbreviates component video signals as Y/Pb/Pr, the product also supports signals from video equipment marked "Y/Cb/Cr."

## Names of each part on the document camera (TDP-T91)

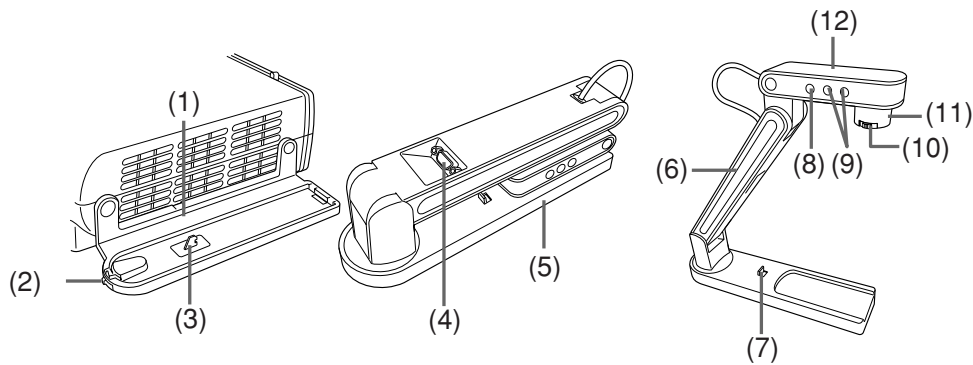

Name	Function
(1) Tray	: The document camera is mounted.
(2) Lock switch	: Used when the document camera is attached/detached to/from the tray.
(3) Lock lever	: Locks the document camera onto the tray.
(4) Camera output terminal (CAMERA OUT)	: Used connect the supplied document camera cable to the COMPUTER IN (camera) terminal of the projector.
(5) Tip resistant bar	: Pulled out when a camera is used separated from the projector.
(6) Camera arm	: Adjusts the shooting angle. <a href="#">p.36</a>
(7) Lock lever	: Used when the document camera is detached from the tray.
(8) CAMERA button	: Toggles between the camera input and previous input. <a href="#">p.36</a>
(9) CAMERA GAIN buttons	: Adjusts the camera gain. <a href="#">p.36</a>
(10) Focusing lever	: Adjusts the focus.
(11) Camera lens	: Shooting lens for the document camera.
(12) Camera head	: Document camera.

## Preparing and using the remote control

### ■ Loading dry-cell batteries into the remote control

- 1 Remove the battery cover.

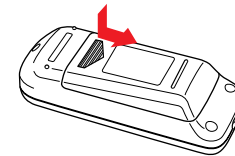

- 2 Insert the dry-cell batteries.

Be sure to align the plus and minus ends of the batteries properly.

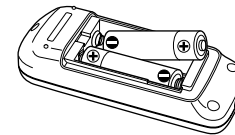

Two batteries (R6, SIZE AA) are used.

- 3 Replace the battery cover.

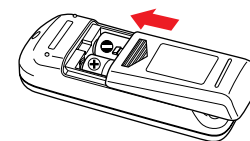

### ■ Operating the remote control

Point the remote control toward the projector's infrared remote sensor, and press a button on the remote control.

- Operating the projector from the front

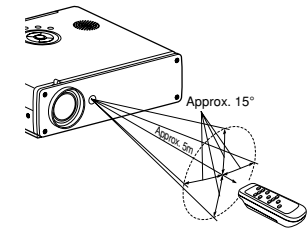

- Operating the projector from the rear

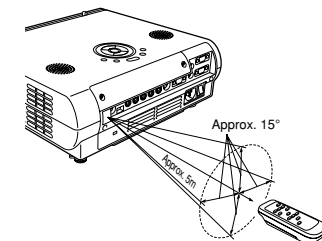

### ■ Dry-cell batteries

- Before using the batteries, be sure to observe the Safety Precautions described in previous pages.
- Remove batteries from remote control when not using for extended periods.
- If the remote control stops working, or if its range decreases, replace all the batteries with new ones.

### ■ The remote control

- The remote control may fail to operate if the infrared remote sensor is exposed to bright sunlight or fluorescent lighting.
- Do not drop or bang.
- Do not leave in hot or humid locations.
- Do not get wet or place on top of wet objects.
- Do not take apart.
- In rare cases, ambient conditions could impede the operation of the remote control. If this happens, point the remote control at the main unit again, and repeat the operation.

# Placement

## Placement Styles

As shown in the figures below, this device can be placed in 4 different styles. The factory setting is "floor-mounted front projection." Set the **Projection mode** in the **default setting menu** [p.32](#), in accordance with your needs.

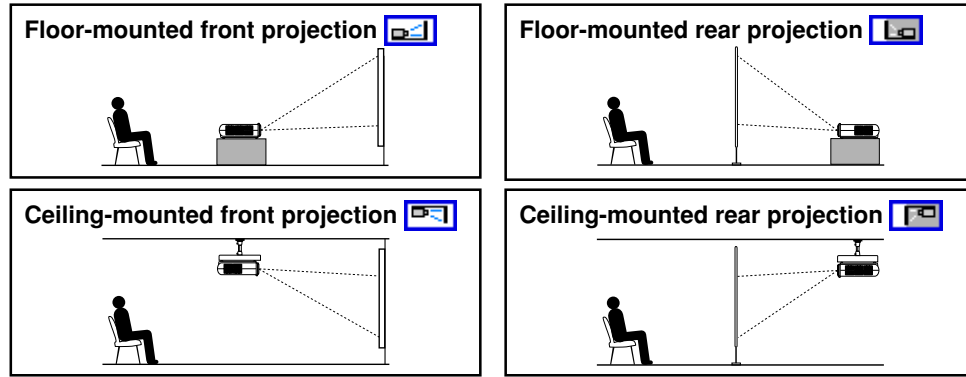

**WARNING**

- Always obey the instructions listed in IMPORTANT SAFETY INSTRUCTIONS when placing the unit. Attempting to clean/replace the lamp at a high site by yourself may cause you to drop down, thus resulting in injury.
- If you wish to mount the projector on the ceiling, be sure to ask your dealer to do so. Mounting the projector on a ceiling requires special ceiling brackets (sold separately) and specialized knowledge. Improper mounting could cause the projector to fall, resulting in an accident.
- If the projector is ceiling-mounted, install the breaker for turning off the power in case of anomaly. Let everyone involved with the use of the projector know that fact.

## Projection Distance and Size

Use the figures, tables, and formulas below to determine the projection size and projection distance. (Projection sizes are approximate values for full-size picture with no keystone adjustment.)

Screen **As seen from above**

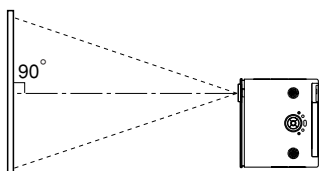

**As seen from the side**

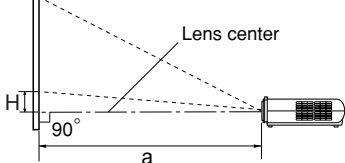

**a** is the distance (m) between the lens and the screen, and corresponds to a range of 1.20 m to 10.00 m. **H** is the height from the image bottom to the center of the lens.

$$a \text{ (min length)} = \text{projection size (inches)} \times 4.064$$

$$a \text{ (max length)} = \text{projection size (inches)} \times 4.878$$

projection size (inches)	projection distance a (m)		height (H) (cm)
	min length (zooming max)	max length (zooming min)	
24.6	—	1.20	5.6
40	1.62	1.95	9.1
60	2.44	2.93	13.8
80	3.25	3.90	18.3
100	4.00	4.88	22.9
150	6.10	7.30	34.3
200	8.10	9.76	45.7
246	10.00	—	56.2

# Connection

## Before connection

- Read the owner's manual of the device you are connecting to the projector.
- Some types of computer cannot be used or connected to this projector. Check for an RGB output terminal, supported signal [p.45](#), etc.
- Turn off the power of both devices before connecting.
- The figure below is a sample connection. This does not mean that all of these devices can or must be connected simultaneously. (Dotted lines mean items can be exchanged.)

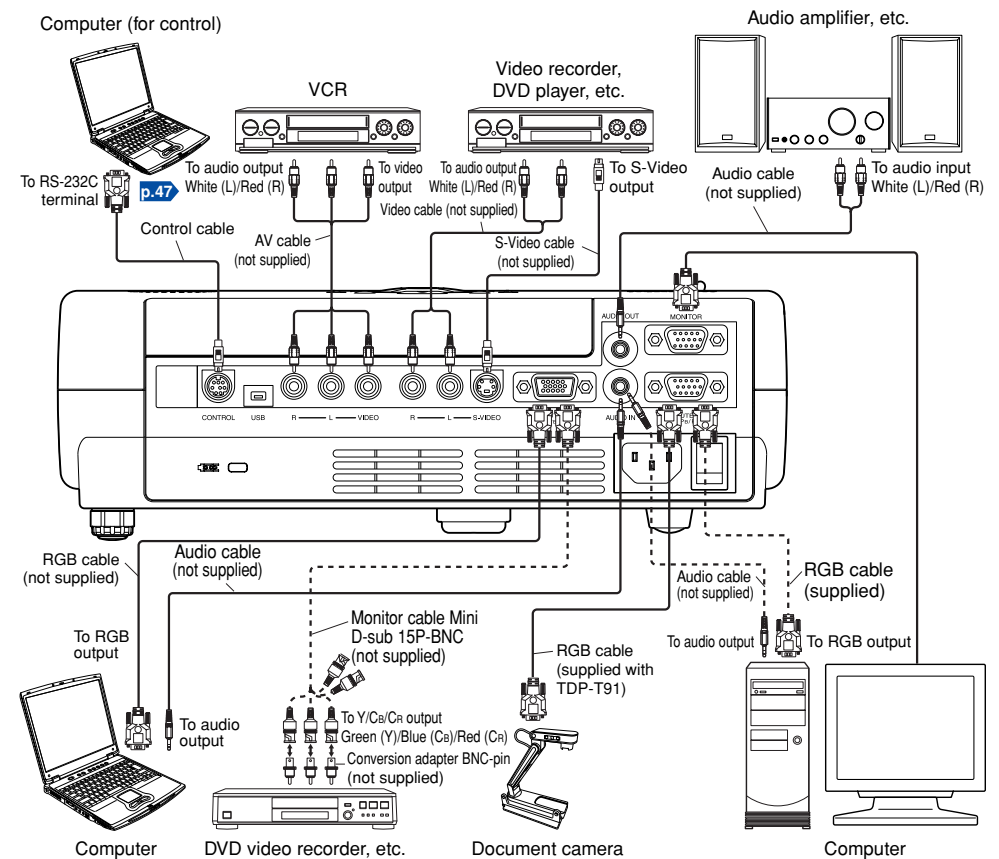

## Notes

- COMPUTER terminals 1 and 2 function identically.
- For TDP-T91, the document camera should be connected to COMPUTER terminal 2.
- The AUDIO IN terminal doubles for devices connected to COMPUTER terminals 1 and 2.

# Turning the power on and off

## ■ Connecting the power cord

**1** Insert the power cord connector into the AC IN socket of the projector.

**2** Insert the power cord plug into a wall or other power outlet.

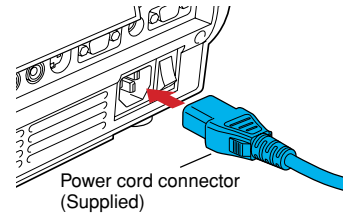

## ■ Removing the lens cover

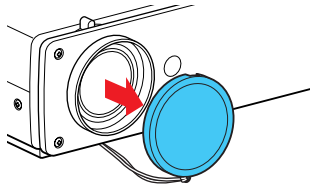

Be sure to remove the lens cover when the power is turned on. If it is left on, it could become deformed due to heat.

## ■ Turning the power on

**1** Turn on the main power switch

The ON indicator will change to orange, indicating standby mode.

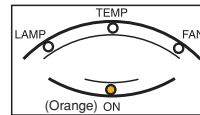
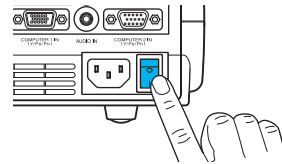

**2** Press the ON/STANDBY button.

The power turns on, and the following 3 green indicators light: ON, LAMP, and FAN. After a moment, the start-up screen appears.

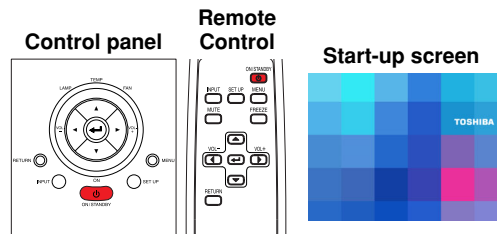

## ⚠ CAUTION

- Do not look into the lens while the lamp is on. The strong light from the lamp may cause damage to your eyes or sight.
- Do not block the air intake or exhaust. Doing so could cause a fire due to internal overheating.
- Do not place your hands, face, or other objects near the air exhaust. Doing so could cause burns, deform/break the object.

## ■ Notes

- The start-up screen will disappear after a moment. You can dismiss the start-up screen before this by performing any operation. You can also configure the start-up screen not to appear via the **Display setting menu** [p.31](#).
- The first time you use the projector after purchase, after the start-up screen disappears, the Language menu is displayed [p.24](#).

## ■ Turning the power off

**1** Press the ON/STANDBY button.

A message appears on the screen, confirming that you wish to shut off the power. This message will disappear after a moment. (This operation is no longer valid after the message disappears.)

**2** Press the ON/STANDBY button again.

The screen turns off, but the internal cooling fan continues to operate for a short while. Then, the projector goes into standby mode.

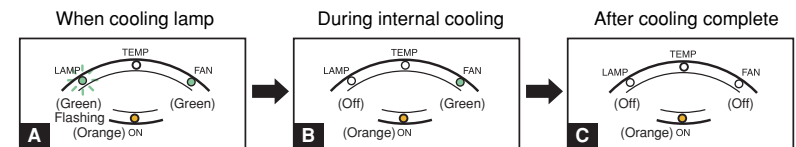

**A** During cooling, the LAMP indicator flashes. In this state, the power cannot be turned back on.

**B** After the LAMP indicator goes off, the cooling fan continues to operate for a short while, in order to expel excess internal heat. If you are in a hurry, there is no problem with unplugging the power cord or turning off the main power switch in this state.

**C** In standby mode

## ■ Note

- The projector consumes about 12W of power in standby. We recommend that you unplug the power cord or turn off the main power switch if you will not be using the projector for an extended period.

## ■ PRECAUTION

- If the power cord is unplugged before cooling is complete, give the lamp time (about 5 minutes) to cool before plugging it back in. If the lamp overheats, it may fail to light, and its lifetime will be shortened.

# Basic operations

## 1 Turn on the power.

Turn on the power by following the instructions in “Turning the power on” [p.22](#).

## 2 Select the language and the lamp power (When using the first time).

When the projector is used for the first time after purchase, menu for language and lamp power selection and configuration is displayed in English. (If the screen is out of focus, adjust it according to the step 6.)

### 1 Use the ▲ or ▼ button to select the desired language and press the ⏻ button.

Message for setup confirmation is displayed in a selected language.

Then, the menu for lamp power selection and configuration is displayed. It is automatically set as Standard. To change the setting, follow the step 2.

### 2 Using the ▲ or ▼ button, select Low, Standard or High for the lamp power (menu item) and press the ⏻ button.

The lamp power, if selected, will be toggled without pressing the ⏻ button. The display automatically disappears in a few seconds.

English	.....	English
Français	.....	French
Deutsch	.....	German
Italiano	.....	Italian
Español	.....	Spanish
Português	.....	Portuguese
Russian	.....	Russian
Swedish	.....	Swedish
Türkçe	.....	Turkish
日本語	.....	Japanese
中文(简体字)	.....	Chinese (simplified)
中文(繁體字)	.....	Chinese (traditional)
한국어	.....	Korean

### Notes

- When the projector is turned on the next time, the Language and Lamp power menus do not appear upon startup. However, if “Reset all” is executed from the **Default setting** menu [p.32](#), the Language and Lamp power menus will be displayed the next time when the power is turned on.
- The language can also be set via the Display setting menu [p.31](#) and Lamp power via the Default setting menu [p.32](#).
- This owner’s manual assumes that English has been selected.

## 3 Activate the connected device.

Turn on and start the connected device such as a computer.

## 4 Press the INPUT button.

An image of the connected equipment is projected.

Each time you press the INPUT button, it switches to the input of the connected equipment.

### Notes

- When [Auto input search] is set to [On] in the **default setting menu** [p.32](#), the image of the equipment which is connected and turned on is projected.
- Moving pictures generated with the DVD software for computers may appear unnatural if it is projected with this projector, but it is not a malfunction.

## 5 Projector placement angle adjustments

The placement angle and the height of the projected image can be adjusted by the foot adjuster.

### 1 Lift up the front of the projector to the desired angle, then press the foot adjuster release button.

The foot adjuster extends. Release the button to lock the position.

### 2 Turn the foot adjuster to fine-tune the angle.

### 3 To adjust the horizontal angle, use the tilt adjuster.

To stow the foot adjuster, hold up the projector while pressing the foot adjuster release button, then slowly lower the projector.

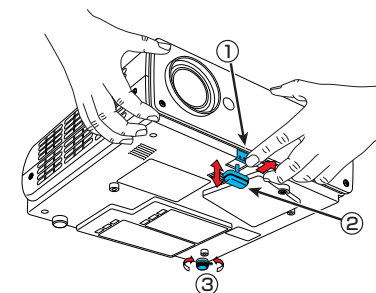

## 6 Adjusting the screen size and focus

### 1 Use the zooming lever to adjust the screen size.

### 2 Use the focusing lever to adjust the focus.

Readjusting the projection size with the zooming lever after focusing will cause the projected image to be out of focus. In that case, perform focusing again.

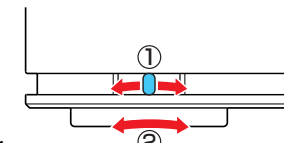

## 7 Adjusting the volume with the ◀ ▶ buttons

The speaker volume can be adjusted when an audio signal is being input.

### Notes

- Note that a lamp characteristics may rarely cause the brightness to fluctuate slightly.
- A lamp is consumable item. If used for extended periods, images will appear dark, and the lamp could burn out. This is characteristic of a lamp, and is not malfunction. (The lifetime of the lamp depends on conditions of use.)
- The DMD™ is made using extremely advanced technology, but there may be black spots (pixels that do not light) or bright spots (pixels that are constantly lit) on the panel. Please note that these are not malfunctions.
- Although this projector supports a wide range of RGB signals [p.45](#), any resolutions not supported by this projector (XGA) will be expanded or shrunk, which will affect image quality slightly. To view high-quality images, it is recommended that the computer’s external output should be set to XGA resolution.
- With some models of computer having LCD displays or the like, displaying images simultaneously on the projector and the monitor’s display may prevent the images from displaying properly. If this happens, turn off the computer’s LCD display. For information on how to turn off the LCD display, see the owner’s manual of your computer.
- If a signal not supported by the projector is input, the “Unsupported signal” will appear.
- If no signal is being input from the connected device, the “No signal” will appear.
- If an unavailable operation button is pressed, the ❌ icon will appear.

# Using handy features

## ■ Using auto setting

This function sets up the projector to the optimum state for each type of the input signal by using simple operations.

### 1 Press the SET UP button.

The Set up menu appears.

### 2 Press the SET UP button again.

The displayed menu item is automatically adjusted/set. For computer input, the  icon will appear during processing.

For manual adjustment and setting, see the following table [p.27](#).

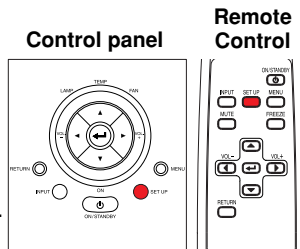

### ■ Note

- The image may not be projected or auto adjustment/setting may not be performed correctly for input signals other than those supported by the projector [p.45](#), [p.46](#).

## ● Correcting the keystone distortion

When the foot adjuster [p.25](#) is used to change the projector placement angle while projecting the image, the picture will undergo keystone (trapezoidal) distortion. This projector is capable of correcting this keystone distortion.

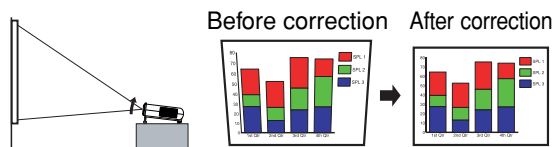



### 1 Press the SET UP button.

### 2 Press the button.

The keystone distortion is automatically corrected. The  icon appears during this correction.

### ● Manual adjustment





Press the SET UP button to display the Set up menu and select [Keystone]. Use the   buttons for keystone adjustment. When the adjustment is finished, press the RETURN button. The menu disappears.



























### ■ Notes

- Depending on the amount of keystone adjustment and the content of images, some information may be lost, or the picture quality may suffer.
- Keystone adjustment is available for the keystone distortion in a slant angle of  $\pm 15$  degrees.
- Keystone adjustment will not change the shape of the menus, the start-up screen, and the background (with no signal input).

## ● Manual adjustments and settings

The menu items of the Set up menu vary depending on the input type, as shown in the table below.

Use the      buttons to adjust the items in the table below, then press the RETURN button when you are finished.

Select Item  	Description	Computer	Y/Pb/Pr	Video S-video	Camera
 <b>Auto. Keystone</b>	Automatically corrects the keystone distortion. Press  .	Yes	Yes	Yes	Yes
 <b>Keystone</b>	Correct the keystone (trapezoid) distortion of the screen. Screen shrinking   Screen shrinking downward upward	Yes	Yes	Yes	Yes
 <b>Auto setting</b>	Automatically adjusts items such as the sampling phase depending on the type of input signal. Press the SET UP button.	Yes	No	No	No
 <b>Phase</b>	Adjust with   to eliminate flicker.	Yes	No	No	No
 <b>Frequency</b>	Adjust with   to eliminate periodic patterns and flickering when many vertical lines appear on the screen.	Yes	No	No	No
 <b>H-position</b>	Adjust the horizontal position of the image. Move left   Move right	Yes	No	No	No
 <b>V-position</b>	Adjust the vertical position of the image. Move down   Move up	Yes	No	No	No
 <b>Clamp 1</b>	Adjusts the clamp pulse position. Lower   Higher	Yes	No	No	No
 <b>Clamp 2</b>	Adjusts the clamp pulse width. Narrower   Wider	Yes	No	No	No

## Using handy features (Continued)

### ■ Cutting off the picture and sound temporarily (Mute)

When you want to project the images of another projector, overhead projector, etc. temporarily, this projector's images and sound can be turned off.

#### ● Press the remote control's MUTE button.

The picture and sound are cut off. (The Mute function is released when pressing the MUTE button again.)

#### ■ Notes

- The  icon will appear while mute is in effect.
- Operating any other functions will also cancel the muting.

#### Remote Control

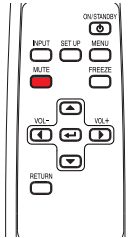

### ■ Freezing the image (Freeze)

The image being projected can be made to be frozen. This function is to be used to pause a video during a presentation, etc.

#### ● Press the remote control's FREEZE button.

The picture pauses. (The Freeze function is released when pressing the FREEZE button again.)

#### ■ Notes

- The  icon will appear while freeze is in effect.
- Other operation will also release the freeze.
- Even if an image is frozen on the projector, the pictures are running on the video or other equipment.
- If you use this function on video software sold on the market, broadcast or broadcast on cable except for the purpose of your private viewing and listening, it may infringe the copyright protected by the copyright laws.

#### Remote Control

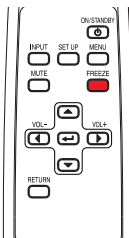

## Using the menus

You can call up on-screen menus, and conduct a number of adjustments and settings using the operation buttons [p.16](#) on the control panel (main unit side) and remote control.

### ■ How to use the menus





The menu shown below is for operation instructions purposes and might differ from the actual display.

1. Press the MENU button Display the Setting display menu

#### 2. Select a Category

Select a category by using  .

There are following four categories:

-  Image adjustment menu [p.30](#)
-  Display setting menu [p.31](#)
-  Default setting menu [p.32](#)
-  Status display menu [p.33](#)





Displays the current adjustments and settings of selected category. Item shown with gray cannot be adjusted with the current input source.



#### 3. Adjustments & Settings

Press  to open the menu.

Item Adjustment/Setting Value

These marks signify the items can be adjusted/set by using  .

These marks signify that there are options. Press  to display a list of options.

These marks signify the items can be selected from the list by using  . After an item is selected, apply it by pressing .

The figure shows displays given for operation instructions purposes. As the display may differ depending on the item, use the following pages as a reference.

#### 4. Back

5. End Press the MENU button  
The menu disappears.

#### ■ Note

- Menu adjustments and settings are saved when the power is turned off via the ON/STANDBY button. If the power cable is disconnected before this, or the power goes out, then the data will not be saved.

## Using the menu (Continued)

### ■ The image adjustment menu

Use this menu to adjust image-related items.

Items that can be adjusted are marked with “Yes”, and those that cannot are marked with “No”.

Item	Description	Computer	Y/Pb/Pr	Video S-video	Camera
<b>Contrast</b>	Adjust the image contrast. Lower   Higher	Yes	Yes	Yes	Yes
<b>Brightness</b>	Adjust the brightness of the image. Darker   Brighter	Yes	Yes	Yes	Yes
<b>Color</b>	Adjust the color of the image. Lighter   Deeper	No	Yes	Yes	No
<b>Tint</b> *1	Adjust the tint of the image color. Reddish   Greenish	No	No	Yes	No
<b>Sharpness</b>	Adjust the sharpness of the image. Softer   Sharper	No	Yes	Yes	Yes
<b>Noise reduction</b>	Set the function to reduce screen noise. On (Enable)   Off (Disable)	No	Yes	Yes	No
<b>Picture mode</b>	Press . Toggle the picture mode with . Bright/Standard/True color	Yes	Yes	Yes	No
<b>R-level</b>	Adjust red of the image color. Less red   More red	Yes	Yes	Yes	Yes
<b>G-level</b>	Adjust green of the image color. Less green   More green	Yes	Yes	Yes	Yes
<b>B-level</b>	Adjust blue of the image color. Less blue   More blue	Yes	Yes	Yes	Yes
<b>NTSC mode</b> *1	Set the black level with  /  button. US: NTSC (US) mode Japan: NTSC (JAPAN) mode	No	No	Yes	No
<b>Shutter</b> (TDP-T91)	Set the shutter speed of the camera to the local power frequency. 50 Hz   60 Hz	No	No	No	Yes
<b>White balance</b> *2 (TDP-T91)	Set the white balance of the document camera. Auto   Lock	No	No	No	Yes

\*1: [Tint] and [NTSC mode] can be displayed and adjusted only when the video signal is set to [NTSC] and [NTSC4.43]. (NTSC mode is set to JAPAN when the language is set to Japanese. It is set to US for other languages.)

\*2: Even if the **white balance** is set to [Lock], turning the projector off disables this function and turning it on again the next time resets the menu to [Auto]. (TDP-T91)

### ■ The display setting menu

Use this menu to set screen display-related items.

Item	Description
<b>Screen size</b>	 (Full): Display with 1024 × 768 dot resolution (Thru): Display with sampling resolution (for computer/camera input) (Wide): Wide-screen display (for Video, S-video, and Y/Pb/Pr)
<b>Language</b>	Select one of the languages below to use for displaying the menu and messages [Enter setting mode] → [Selection] → [Apply: Enter] English/Français/Deutsch/Italiano/Español/Português/Russian/Swedish/Türkçe/日本語/中文(简体字)/中文(繁体字)/한국어
<b>Background</b>	Screen to display when there is no input signal  (Logo)  (Blue)  (Black)
<b>Icon</b>	Display icons as function guides <b>On</b> <b>Off</b>
<b>Start-up screen</b>	Display start-up screen when power is turned on <b>On</b> <b>Off</b>

#### ■ Note

- If “Thru” is selected for **screen size**, portions exceeding the native resolution (1024 × 768 pixels) will not appear on the screen. Note that for RGB signals with clock frequency 140MHz or lower, all input pixel signals are sampled. However, if the clock speed is higher than this, the RGB pixel signal is thinned before sampling.



## Using the menu (Continued)

### ■ The default setting menu

This menu shows placement status and other settings.

Item ▲▼	Description
<b>Projection mode</b>	Sets projection mode in accordance with Placement Style. <a href="#">p.20</a> (Standard)  (Rear)  (Mounted from ceiling)  (Rear mounted from ceiling)
<b>No signal power off</b>	Set the timer to wait for the power to be turned off after signal input stops. Press . Switch with ▲ and ▼. <b>Off</b> (not turned off)/ <b>1 min./5 min./10 min./30 min./60 min.</b>
<b>Auto input search</b>	Set whether the input with signals is only selected or not. <b>On</b> <b>Off</b>
<b>Power on</b>	Sets whether to turn on the power when the <b>ON/STANDBY</b> button is pressed (Manual), or when the power cord is plugged in (Auto). <b>Manual</b> <b>Auto</b>
<b>Lamp power</b> <sup>[Note 1]</sup>	Sets the lamp power. <b>Low</b> <b>Standard</b> <b>High</b>
<b>Fan mode</b> <sup>[Note 2]</sup>	Sets the cooling fan speed. <b>Standard</b> <b>High</b>
<b>Reset all</b>	Press . Resets all adjustments and settings to their factory settings. <b>Yes</b> <b>No</b>

#### Notes

- 1: When **Lamp power** is set to **Low**, the screen becomes a little darker, but the cooling fan noise gets quieter. This setting will be cleared when you turn the power off.
- 2: Setting **[Fan mode]** to **[High]** increases the cooling fan speed. Set this option to use the projector, for example, at high altitude (over 1,500 meters above sea level).

#### ■ Notes

- Note that in the event of a power outage but the power is restored afterwards, the projector power will come on if **Power on** is set to **Auto**, and the power cord is plugged in.
- When you turn off the projector even if **Power on** is set to **Auto**, you must press the **ON/STANDBY** button to turn the power off.

### ■ Displaying Information (Status display)

This displays information about the input signal, lamp use time, etc.

“Yes”: displayed, “No”: not displayed

Item	Description	Computer	Y/Pb/Pr	Video S-video	Camera
Input	Input source name	Yes	Yes	Yes	Yes
Mode name	RGB input mode <sup>[Note 1]</sup>	Yes	No	No	No
H-resolution	Horizontal resolution (in dots)	Yes	No	No	No
V-resolution	Vertical resolution (in dots)	Yes	No	No	No
H-frequency	Horizontal sync frequency	Yes	No	No	No
V-frequency	Vertical sync frequency <sup>[Note 2]</sup>	Yes	No	No	No
Sync	Sync signal polarity <sup>[Note 3]</sup>	Yes	No	No	No
Signal format	Y/Pb/Pr signal format	No	Yes	No	No
Video mode	Color method of video signal	No	No	Yes	No
Lamp time	Time of lamp use <sup>[Note 4]</sup>	Yes	Yes	Yes	Yes
Lamp reset count	The count for lamp replacement	Yes	Yes	Yes	Yes
Total time	The total time that this projector is used	Yes	Yes	Yes	Yes
Version	Firmware version <sup>[Note 5]</sup>	Yes	Yes	Yes	Yes

#### Notes

- 1: The mode of supported RGB signals [p.45](#) is shown.
- 2: Same as the refresh rate of the computer signal.
- 3: Sync signal polarity shown as P (positive) or N (negative) for [H/V].
- 4: Displays **[Lamp time]** as a measure of when the lamp should be replaced. (Cannot be used as a counter of guaranteed lamp time.) When the displayed time approaches 2,000 hours, consult with a store about getting a TLPLW3 replacement lamp (sold separately) prepared.
- 5: **[Version]** shows the version of the projector's internal control program. This version is referred to for customer service, etc.

#### ■ Note

- The displayed information will not be refreshed if the status changes. To refresh the information, dismiss the display, then display it again.

# Using the document camera

Please read this chapter if the model you purchased is TDP-T91 which includes a document camera.

## ■ How to use the document camera

### ● Using the camera attached on the projector

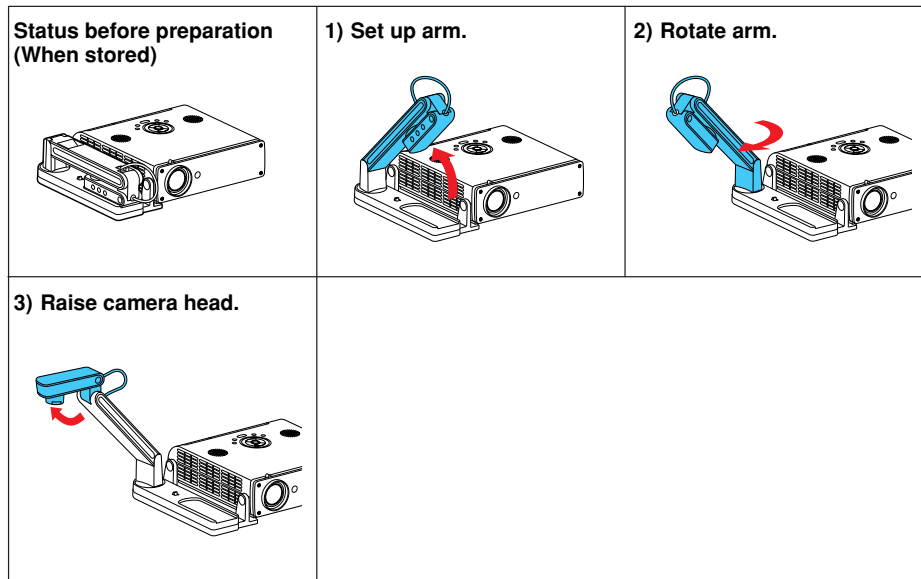

### ■ PRECAUTIONS

- For camera interconnection, be sure to use the supplied RGB cable (25 cm or 3 m). If you use the other cables, the normal operation may not be achieved and even the malfunction may result.
- When moving the projector with the camera attached, do not grab the camera arm and/or the camera head.
- When moving the projector with the camera attached, first ensure that the camera is securely locked in position on the tray.
- Insert the RGB cable straight and securely until it is fixed in place.
- Do not jolt or force the camera head or camera arm. Doing so could cause malfunction.
- Note that when extending or rotating the camera arm, the arm moves in an arc. Take care not to bump yourself or others with it.
- When placing the projector in the carrying bag, remove the connection cables. Otherwise, damage to the connectors and cables may result.

### ● Using the camera removed from the projector

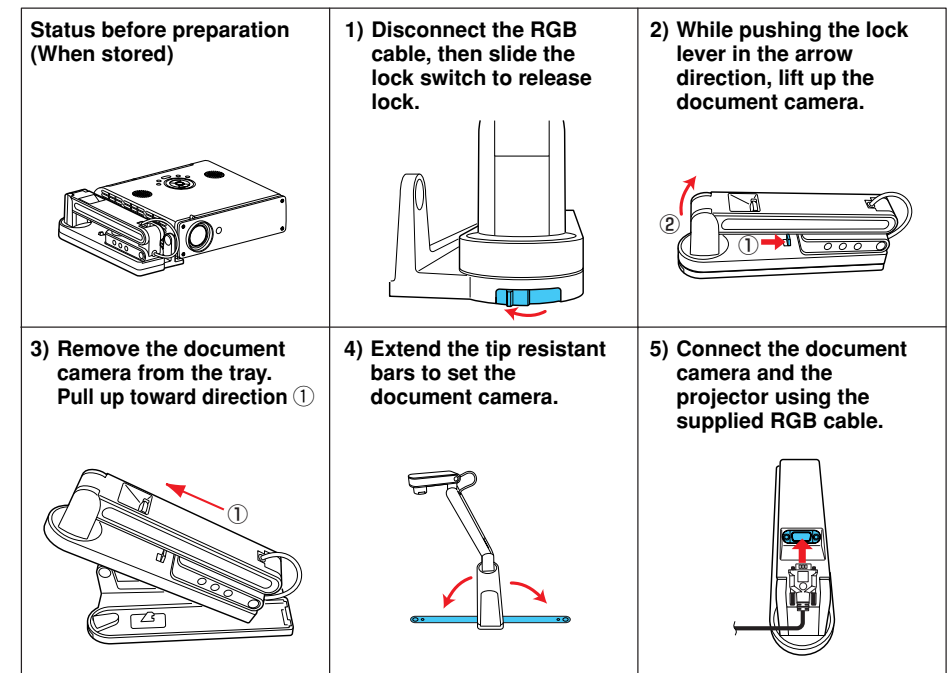

### ■ PRECAUTIONS

- Installation of the document camera onto the tray should be performed in the reverse order shown above.
- When replacing the document camera on the tray, ensure that the lock lever is securely locked in position.
- When using the tip resistant bars, pull them fully until each forms the angle of 90 degree. If you don't use the bars, the camera may topple over.

## Using the document camera (Continued)

### ■ Image projection with the document camera

#### ① Place the document.

Set the document at the side of the projector.

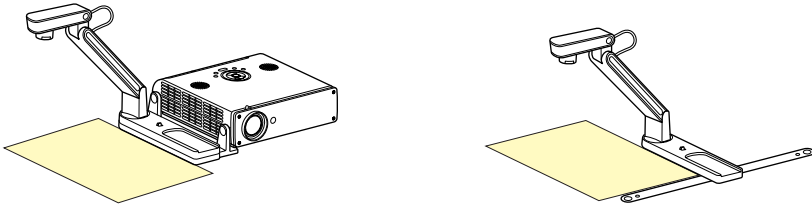

#### ② Press the CAMERA button, and select camera input.

- The input returns to the previous input when the CAMERA button is pressed again.
- Camera input can also be selected by pressing either the remote control or projector's INPUT button.



#### ③ Rotate the camera head to align the orientation of the document for shooting by checking the screen.

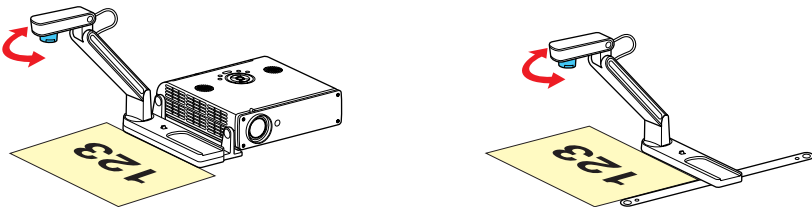

#### ④ Move the camera arm up and down to adjust the image size.

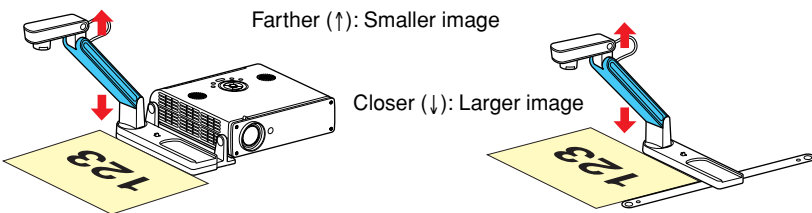

- Closeup shot with the distance shorter than 100 mm cannot be performed.

#### ⑤ Adjust the focus using the focusing lever on the camera head

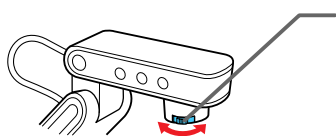

Focusing lever  
Rotate the focusing lever to either **NEAR** or **FAR**, whichever is better in focusing.

- **Near** : 100 mm to 300 mm
- **Far** : 300 mm to 5 m

#### ⑥ If the screen is too dark or too bright, use the CAMERA GAIN (+/-) buttons to make it easier to see.

The Sharpness of the camera image can also be adjusted using the **Image adjustment menu** [p.30](#).



#### ⑦ After use, fold up the document camera.

Fold up the camera using the reverse order from unfolding the document camera [p.34](#).

### ■ Notes

- There is no audio output when camera input is selected.
- If the room's fluorescent lighting causes the image to flicker, either turn off the fluorescent light, or set the **Shutter** from the **Image adjustment menu** [p.30](#). Note that changing the **Shutter** setting may not eliminate the flicker, depending on the lighting, state of the document, or image adjustment.

### ■ Locking the white balance

Although the projector's camera is constantly adjusting the color balance of the images it photographs, the color balance may be disrupted, depending on the color layout of the document. If this happens, the white balance can be locked using the procedures below.

#### ① Lay down a piece of white paper, and adjust so it fills the screen.

Adjust the camera head and arm so that the white paper fills the screen completely.

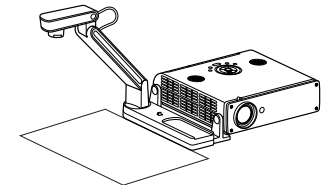

#### ② Set the White balance to Lock in the Image adjustment menu. [p.30](#)

The white balance is locked. If you want to return to the auto adjustment, set the **White balance** to **Auto** in the **Image adjustment menu**.

### ■ Notes

- If the white balance is set to **Lock**, once power is turned off, the setting goes back to **Auto**.
- The color of the room lighting may prevent the white balance from being adjusted to the optimum level. In this situation, or if you want to use a certain tinting, adjust the **R-level**, **G-level** and **B-level** on the **Image adjustment menu** [p.30](#).

# About lamp

The product's light source is a mercury lamp that lights at increased internal pressure. Be sure to fully understand the following characteristics of the lamp and handle it with extreme care.

- The lamp may explode with a loud noise due to impact or deterioration, or fail to light at the expiration of its life.
- How long it takes before the lamp explodes or the life expires may vary greatly by lamp. Some may explode shortly after first use. (Free replacement is available if the lamp explodes within the warranty period. Contact the dealer from whom you purchased the product in such a case.)
- Explosion is likely to happen if the lamp is used after the replacement period has elapsed.
- When the lamp explodes, the broken pieces of glass may get inside the product or be released outside from the openings for ventilation.
- When the lamp explodes, a slight amount of mercury gas enclosed in the lamp along with glass dust may be released from the openings for ventilation.

## ■ Immediately replace the lamp when a sign appears on the screen.

- When the replacement time approaches, a message will appear on the screen.
- The risk of explosion will increase if the lamp is continuously used without being replaced.
- Frequently check the used hours and prepare spares when the replacement time approaches. (Refer to "Status display". [p.33](#))

## ■ When the lamp is broken

- If glass components, including a lamp and a lens, should break, handle the broken pieces with care to avoid injury and contact your dealer for repair service.
- In the event of lamp explosion, unplug the product from the wall outlet, leave and completely ventilate the room. Then, thoroughly clean the area around the projector and discard any edible items placed in that area.
- When the lamp explodes, consult a doctor if glass dust or mercury gas gets into your eyes or you breathe it.

# Lamp replacement

A lamp is consumable supplies. If used for extended periods, images will appear dark, and the lamp could burn out. This is characteristic of a lamp, and is not malfunction. (The lifetime of the lamp depends on condition of use.) If this happens, replace it with a new one.

### ⚠ WARNING

- If the projector is mounted on a ceiling, request a lamp replacement from your projector dealership.
- When replacing, always use lamp "TLPLW3" (sold separately).

### ⚠ CAUTION

- If you have been using the projector, the lamp will be very hot, and may cause burn injuries. Wait for the lamp to cool (for longer than 1 hour) before replacing it.
- If the lamp should break, please handle with care to avoid injury due to broken pieces and contact your dealer for repair service.

## 1 Unplug power cord.

## 2 Wait until lamp is sufficiently cooled.

Wait for at least 1 hour.

## 3 Remove the lamp cover.

Loosen the 1 screw, then pull up to the direction of the arrow with your fingers as shown to remove the lamp cover. Use care to avoid any damage to nails and/or tip of your finger(s). If you have any difficulty in removal, you can use a screwdriver or any other smaller tool for your convenience.

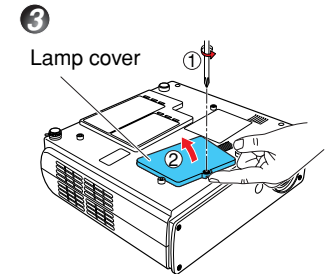

## 4 Pull out the lamp.

Loosen the 2 screws holding the lamp in place, and pull up the handle to remove the lamp.

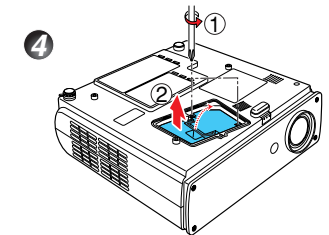

## 5 Mount the new lamp.

Align the orientation, press down until the bottom is reached, and lock in place using the two lamp locking screws.

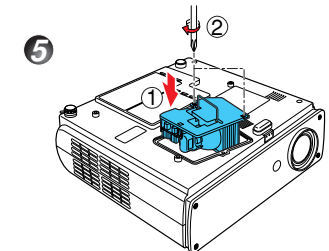

## 6 Replace the lamp cover.

Align the cover, and press it in, then tighten the screws loosened in step 3 until the lamp cover is no longer loose.

## 7 Reset the lamp timer.

See the lamp's manual for instructions on resetting the lamp timer.

## ■ Notes and Precautions

- Press the button twice to display (a rough guide) the time of lamp use, the **Lamp time** item, in the **Status display menu**. [p.33](#)
- It is recommended that the lamp be replaced after 2,000 hours of use. When **Lamp time** reaches 2,000 hours, the icon and a message will appear. This display disappears when you press button.
- Attach the lamp cover correctly so that it is not loose. If it is not attached correctly, the lamp may fail to come on [p.41](#), and the lamp's lifetime may be shortened.
- Always replace the lamp with a new one.
- The lamp is made out of glass. Do not touch the glass surface with your bare hands, bang it, or scratch it. (Dirt, jolts, scratches and the like could break the lamp.)

## Lamp replacement (Continued)

### Used Lamps

This projector's lamps contain trace amounts of environmentally harmful inorganic mercury. Be careful not to break used lamps, and dispose of them in accordance with local regulations.

## Lens and main unit cleaning

### WARNING

- Request cleaning and maintenance of a ceiling-mounted unit from your projector dealership. Attempting to clean/replace the lamp at a high site by yourself may cause you to drop down, thus resulting in injury.

### Lens cleaning

- Clean the lens with a commercially available blower and/or lens cleaner.
- The lens is easily scratched, so do not rub it with hard objects, or strike it.

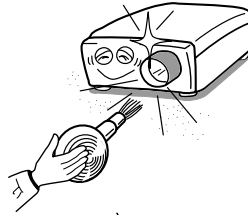

### Main unit cleaning

- Clean the main unit after unplugging the power cord.
- Wipe dirt off the main unit gently with a soft cloth.
- If the soiling is severe, dip the cloth in a neutral detergent diluted in water, wring well, and gently wipe off the dirt, then finish up by wiping with a dry cloth.

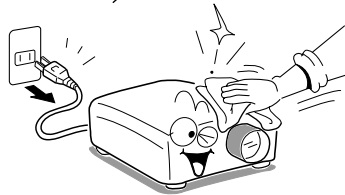

### Replacing cooling fans

To maintain the performance, it is recommended that cooling fans should be replaced about every 2 to 3 years. Consult with your dealer for details.

## Trouble indications

The indicator lights inform you of internal abnormalities.

	<p><b>No power</b></p> <p>⇒ Problem with projector</p> <ul style="list-style-type: none"> <li>Unplug the power cord, and contact your dealer.</li> <li>The lamp cover is not properly attached.</li> <li>Unplug the power cord, and reattach the lamp cover. <a href="#">p.39</a></li> </ul>
	<p><b>Lamp went out during use, or won't come on</b></p> <p>⇒ Lamp temperature is high so that it is difficult to turn on, the lifetime of the lamp has ended or the projector is malfunctioning.</p> <ul style="list-style-type: none"> <li>Unplug the power cord and wait for a short while, then turn the power back on.</li> <li>If a lamp burns out, replace it with a new one.</li> </ul> <p>* After approx. one minute of abnormal display, the projector returns to the standby state waiting for internal cool down.</p>
	<p><b>Power went out during use</b></p> <p>⇒ Internal overheating, or the outside temperature is too high.</p> <ul style="list-style-type: none"> <li>Place the projector so that the air intake and exhaust are not blocked.</li> <li>Unplug the power cord and wait for a short while, then turn the power back on.</li> </ul> <p>* The  icon will appear before the power goes out.</p> <p>* After approx. one minute of abnormal display, the projector returns to the standby state waiting for internal cool down.</p>
	<p><b>Power went out during use</b></p> <p>⇒ Problem with internal cooling fan.</p> <ul style="list-style-type: none"> <li>Unplug the power cord, and contact your dealer.</li> </ul> <p>* The  icon will appear before the power goes out.</p> <p>* After approx. one minute of abnormal display, the projector returns to the standby state waiting for internal cool down.</p>
	<p><b>Power went out during use</b></p> <p>⇒ Problem inside the projector.</p> <ul style="list-style-type: none"> <li>Unplug the power cord and wait for a short while, then turn the power back on.</li> <li>If the above action will not clear the problem, unplug the power cord, and contact your dealer.</li> </ul> <p>* After approx. one minute of abnormal display, the projector returns to the standby state waiting for internal cool down.</p>
<p><b>TDP-T91</b></p>	<p><b>Power went out during use</b></p> <p>⇒ Camera is not correctly connected.</p> <ul style="list-style-type: none"> <li>Disconnect the power plug and check the connection with the camera.</li> </ul> <p>* The  icon will appear before the power goes out.</p> <p>* After approx. one minute of abnormal display, the projector returns to the standby state waiting for internal cool down.</p>

### PRECAUTION

- Make sure to unplug the power cord if something goes wrong.

# Before calling service personnel

If you think something is wrong, check the followings before contacting customer service. Please see "Trouble indications" [p.41](#) as well.

If This Happens	Check
<b>No power</b>	<ul style="list-style-type: none"> <li>Is the power cord plugged in? Is it connected to the projector?</li> <li>Is the lamp cover loose? <a href="#">p.39</a></li> </ul>
<b>Power goes out during use</b>	<ul style="list-style-type: none"> <li>Is the ambient temperature high? <a href="#">p.41</a></li> <li>Is the air intake or air exhaust blocked? <a href="#">p.41</a></li> </ul>
<b>No picture</b>	<ul style="list-style-type: none"> <li>Is the projector turned on? <a href="#">p.24</a></li> <li>Is the mute function on? <a href="#">p.28</a></li> <li>Is the brightness setting minimized? <a href="#">p.30</a></li> <li>Are the connections set up correctly? <a href="#">p.21</a></li> <li>Are all the connected devices functioning properly?</li> </ul>
<b>No audio</b>	<ul style="list-style-type: none"> <li>Is the projector turned on? <a href="#">p.24</a></li> <li>Is the mute function on? <a href="#">p.28</a></li> <li>Is the volume setting minimized? <a href="#">p.25</a></li> <li>Are the connections set up correctly? <a href="#">p.21</a></li> <li>Are all the connected devices functioning properly?</li> </ul>
<b>Picture not displayed correctly</b>	<ul style="list-style-type: none"> <li>Is the input signal supported by the projector? <a href="#">p.45</a>, <a href="#">p.46</a></li> <li>Is there something generating an abnormal video signal, for instance the video tape?</li> </ul>
<b>Picture blurred Part of picture out of focus</b>	<ul style="list-style-type: none"> <li>Is the lens dirty? <a href="#">p.40</a></li> <li>Is the lens focus adjusted optimally? <a href="#">p.25</a></li> <li>Is the projection distance within the projector's supported range? <a href="#">p.20</a></li> <li>Is the projector's screen placement angle tilted too far? <a href="#">p.20</a></li> <li>Are the sharpness or sampling phase adjustments off? <a href="#">p.27</a> <a href="#">p.30</a></li> </ul>
<b>Image is dark</b>	<ul style="list-style-type: none"> <li>Are the brightness or contrast adjustments off? <a href="#">p.30</a></li> <li>Is the lamp nearing the end of its service life? <a href="#">p.33</a></li> </ul>
<b>Colors too light Bad shading</b>	<ul style="list-style-type: none"> <li>Are the color, tint, R-level, G-level, or B-level adjustments off? <a href="#">p.30</a></li> <li>Is the screen dirty?</li> <li>Is the lamp nearing the end of its service life? <a href="#">p.33</a></li> </ul>
<b>Remote control doesn't work</b>	<ul style="list-style-type: none"> <li>Are the remote control's batteries drained?</li> <li>Are the batteries inserted into the remote control correctly? <a href="#">p.19</a></li> <li>Is the remote control being used within the effective range? <a href="#">p.19</a></li> <li>Are there any obstructions between the remote control and projector?</li> <li>Are there any fluorescent or other bright lights shining at the projector's infrared remote sensor?</li> </ul>

If This Happens	Check
<b>TDP-T91 The images from the document camera are blurry</b>	<ul style="list-style-type: none"> <li>Is the document imaging camera's lens dirty?</li> <li>Is the document imaging camera out of focus? <a href="#">p.36</a></li> <li>Is the location of the object being focused too dark?</li> </ul>
<b>TDP-T91 The images from the document camera are flickering</b>	<ul style="list-style-type: none"> <li>Is there impact from the room's fluorescent lighting? Turn off the fluorescent lights, or change the shutter speed settings. <a href="#">p.30</a></li> </ul>

# Specifications

## ■ List of general specifications

Item	Specification	
Consumption Power	300 W	
Weight	TDP-T90: 2.8 kg	
	TDP-T91: 3.7 kg	
External Dimensions (including protruding parts)	TDP-T90: 298 × 101.4 × 275.4 mm (W × H × D)	
	TDP-T91: 283 × 101.4 × 275.4 mm (W × H × D)	
Cabinet material*	PC+ABS resin and ABS resin	
Conditions for usage environment	Temp: 5°C to 35°C; relative humidity: 30% to 70%	
Display pixels	1 chip DMD™	
Picture elements	786,432 pixels (1024H × 768V)	
Lens	Zoom lens F=2.4-2.65 f=28.04-35.59 mm	
Lamp	High-pressure mercury lamp	
Projection screen size	24.6-246 inches	
Projection distance	1.20-10.00m	
Speaker	1 W (Monaural)	
Connection terminal	COMPUTER-1 terminal	Mini D sub 15 pin RGB / Y/P <sub>B</sub> /P <sub>R</sub> (dual use)
	COMPUTER-2 terminal	Mini D sub 15 pin RGB / Y/P <sub>B</sub> /P <sub>R</sub> (dual use) / CAMERA (TDP-T91)
	MONITOR terminal	Mini D sub 15 pin RGB / Y/P <sub>B</sub> /P <sub>R</sub> (dual use)
	S-VIDEO terminal	Mini DIN 4 pin
	AUDIO (L/R) terminal	RCA Pin Jack × 2, 1.5 V (rms), 22 kΩ or more
	VIDEO terminal	RCA Pin Jack, 1 V (p-p), 75 Ω
	AUDIO IN terminal	ø3.5mm dia. stereo mini-jack, 1.5V (rms); 22 kΩ or more
	AUDIO OUT terminal	ø3.5mm dia. stereo mini-jack
CONTROL terminal	Mini DIN 8 pin (RS-232C)	

## ■ Document camera specifications (TDP-T91)

Item	Specification
Lens	F=2.8, f=2.8mm
Focusing	Switching in two steps
Zooming	None (adjusted through distance from subject)
Image element	1/4.2 inches honeycomb CCD
Effective pixels for pickup section	629,856 pixels (648H × 486V × 2)

\* Each plastic part displays the materials it is made from, in order to facilitate recycling after this product becomes no longer usable.

### ■ Note

- Design, specifications, etc. subject to change without notice for improvements, etc.

## ■ List of supported signals (RGB signals)

This projector supports the following RGB signals. Note, however, that depending on the computer model, the screen may show flicker or streaking. Please adjust the projector if this happens.

(Press the SET UP button, and adjust automatically or manually. [p.26](#), [p.27](#))

Resolution	Mode	Refresh rate (Hz)	H-frequency (kHz)	Clock (MHz)
720 x 400	720x400_85	85.039	37.927	35.500
640 x 480	VGA_60	59.940	31.469	25.175
	VGA_72	72.809	37.861	31.500
	VGA_75	75.000	37.500	31.500
	VGA_85	85.008	43.269	36.000
800 x 600	SVGA_56	56.250	35.156	36.000
	SVGA_60	60.317	37.879	40.000
	SVGA_72	72.188	48.077	50.000
	SVGA_75	75.000	46.875	49.500
	SVGA_85	85.061	53.674	56.250
832 x 624	MAC16"	74.550	49.725	57.283
1024 x 768	XGA_60	60.004	48.363	65.000
	XGA_70	70.069	56.476	75.000
	XGA_75	75.029	60.023	78.750
	XGA_85	84.997	68.667	94.500
	MAC19"	74.700	60.134	79.857
1152 x 864	SXGA1_75	75.000	67.500	108.000
1280 x 960	QuadVGA_60	60.000	60.000	108.000
	QuadVGA_85	85.002	85.938	148.500
1280 x 1024	SXGA3_60	60.020	63.981	108.000
	SXGA3_75	75.025	79.976	135.000
	SXGA3_85	85.024	91.146	157.500
1400 x 1050	SXGA+	60.012	63.973	118.094
1600 x 1200	UXGA_60	60.000	75.000	162.000
	UXGA_65	65.000	81.250	175.500
	UXGA_70	70.000	87.500	189.000
	UXGA_75	75.000	93.750	202.500
	UXGA_85	85.000	106.250	229.500

### ■ Note

- Signals which resolution exceeds the native resolution (1024 × 768 pixels) will be compressed. For this reason, some information may be lost, or image quality may be affected.

## Specifications (Continued)

### ■ List of supported signals (Y/P<sub>B</sub>/P<sub>R</sub> signals)

Signal format	fh(kHz)	fv(Hz)
480i(525i)@60Hz	15.73	59.94
480p(525p)@60Hz	31.47	59.94
576i(625i)@50Hz	15.63	50.00
576p(625p)@50Hz	31.25	50.00
720p(750p)@60Hz	45.00	60.00
720p(750p)@50Hz	37.50	50.00
1080i(1125i)@60Hz	33.75	60.00
1080i(1125i)@50Hz	28.13	50.00
1035i(1125i)@60Hz	33.75	60.00
1152i(1250i)@50Hz	31.25	50.00

### ■ List of supported signals (Video, S-Video signals)

Video mode	fh(kHz)	fv(Hz)	fsc(MHz)
NTSC	15.73	60	3.58
PAL	15.63	50	4.43
SECAM	15.63	50	4.25 or 4.41
PAL-M	15.73	60	3.58
PAL-N	15.63	50	3.58
PAL-60	15.73	60	4.43
NTSC4.43	15.73	60	4.43

### ■ Pin assignment of COMPUTER-1/2 & MONITOR terminals

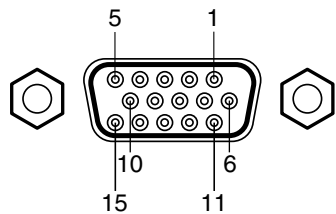

Mini D sub 15 Pin connector

#### Input Signal

- RGB input
  - RGB signals: 0.7V (p-p) 75 Ω
  - Horizontal sync signal: TTL level (Pos/neg polarity)
  - Vertical sync signal: TTL level (Pos/neg polarity)
- Y/P<sub>B</sub>/P<sub>R</sub> input
  - Y signal: 1.0V (p-p) 75 Ω
  - P<sub>B</sub>/P<sub>R</sub> signals: 0.7V (p-p) 75 Ω

Pin No.	Pin description	
	During RGB input	During Y/P <sub>B</sub> /P <sub>R</sub> input
1	Video signal (R)	Color difference signal (P <sub>R</sub> )
2	Video signal (G)	Luminance signal (Y)
3	Video signal (B)	Color difference signal (P <sub>B</sub> )
4	GND	*
5	GND	*
6	GND (R)	GND (P <sub>R</sub> )
7	GND (G)	GND (Y)
8	GND (B)	GND (P <sub>B</sub> )
9	N.C	*
10	GND	*
11	GND	*
12	N.C	*
13	Horizontal sync signal	*
14	Vertical sync signal	*
15	N.C	*

\* Do not connect anything.

### ■ CONTROL terminal

#### ● Pin assignment

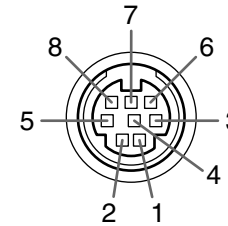

Mini DIN 8 pin connector

Pin No.	Signal Name	Description
1	RXD	Receiving data
2	CTS	Consent to send
3	DSR	Data set ready
4	GND	Signal ground
5	RTS	Request to send
6	N.C	No connection
7	TXD	Sending data
8	GND	Signal ground

#### ● Interface format

- 1 Communication method RS-232C, 9600bps, No Parity, Data Length: 8 bits; Stop Bit Length: 1 bit
- 2 Communication format 

STX (02h)	Command (3Byte)	ETX (03h)
-----------	-----------------	-----------

  
Only 1 command valid per communication.
- 3 Data format For input commands, only ASCII-compliant all-uppercase alphanumeric characters supported.
- 4 Replies
 

Acknowledge	ACK (06h)	CR (0Dh)	Data	... Normally ended
	ACK (06h)	ESC (1Bh)		... Aborted
No acknowledge	NAK (15h)			

If commands are to be sent consecutively, wait for the response from the projector before sending the next command.

#### ● Main Commands

Item	Command
Power on	<b>PON</b>
Power off	<b>POF</b>
Icon display on	<b>MO0</b>
Icon display off	<b>MO1</b>
Auto setting (RGB input)	<b>PAT</b>
Status display on	<b>DON</b>
Status display off	<b>DOF</b>

Item	Command
Computer (1) input select	<b>IN1</b>
Computer (2) input select	<b>IN2</b>
Video input select	<b>IN3</b>
S-video input select	<b>IN4</b>
Camera input select (TDP-T91)	<b>IN5</b>

#### ■ Note

- Contact your dealer for control cable and other commands.

### ■ Separately sold product

Replacement Lamp Model TLPLW3



**TOSHIBA CORPORATION**

## Free Manuals Download Website

<http://myh66.com>

<http://usermanuals.us>

<http://www.somanuals.com>

<http://www.4manuals.cc>

<http://www.manual-lib.com>

<http://www.404manual.com>

<http://www.luxmanual.com>

<http://aubethermostatmanual.com>

Golf course search by state

<http://golfingnear.com>

Email search by domain

<http://emailbydomain.com>

Auto manuals search

<http://auto.somanuals.com>

TV manuals search

<http://tv.somanuals.com>