

# Satellite<sup>®</sup> 1800/1805 Series User's Guide

If you need assistance:



- ❖ VirtualTech<sup>™</sup> e-support tool  
Double-click the desktop icon or visit the Web site:  
<http://virtualtech.answersteam.com>
- ❖ InTouch<sup>sm</sup> Center  
Calling within the United States (800) 457-7777  
Calling from outside the United States (949) 859-4273

For more information, see Chapter 9 on page 197 in this guide.

**TOSHIBA**

C6601-0901M1

## Model: Satellite 1800/1805 Series

### Compact Disk-ReWritable

The computer system you purchased may include a Compact Disk-ReWritable (CD-RW), one of the most advanced storage technologies available. As with any new technology, you must read and follow all set-up and usage instructions in the applicable user guides and/or manuals enclosed. If you fail to do so, this product may not function properly and you may lose data or suffer other damage.

**TOSHIBA AMERICA INFORMATION SYSTEMS (“TOSHIBA”), ITS AFFILIATES AND SUPPLIERS DO NOT WARRANT THAT OPERATION OF THE PRODUCT WILL BE UNINTERRUPTED OR ERROR FREE. YOU AGREE THAT TOSHIBA, ITS AFFILIATES AND SUPPLIERS SHALL HAVE NO RESPONSIBILITY FOR DAMAGE TO OR LOSS OF ANY BUSINESS, PROFITS, PROGRAMS, DATA OR REMOVABLE STORAGE MEDIA ARISING OUT OF OR RESULTING FROM THE USE OF THE PRODUCT, EVEN IF ADVISED OF THE POSSIBILITY THEREOF.**

### Protection of Stored Data

For your important data, please make periodic back-up copies of all the data stored on the hard disk or other storage devices as a precaution against possible failures, alteration, or loss of the data. **IF YOUR DATA IS ALTERED OR LOST DUE TO ANY TROUBLE, FAILURE OR MALFUNCTION OF THE HARD DISK DRIVE OR OTHER STORAGE DEVICES AND THE DATA CANNOT BE RECOVERED, TOSHIBA SHALL NOT BE LIABLE FOR ANY DAMAGE OR LOSS OF DATA, OR ANY OTHER DAMAGE RESULTING THEREFROM. WHEN COPYING OR TRANSFERRING YOUR DATA, PLEASE BE SURE TO CONFIRM WHETHER THE DATA HAS BEEN SUCCESSFULLY COPIED OR TRANSFERRED. TOSHIBA DISCLAIMS ANY LIABILITY FOR THE FAILURE TO COPY OR TRANSFER THE DATA CORRECTLY.**

---

## Critical Applications

The computer you have purchased is not designed for any “critical applications.” “Critical applications” means life support systems, medical applications, connections to implanted medical devices, commercial transportation, nuclear facilities or systems or any other applications where product failure could lead to injury to persons or loss of life or catastrophic property damage.

**ACCORDINGLY, TOSHIBA, ITS AFFILIATES AND SUPPLIERS DISCLAIM ANY AND ALL LIABILITY ARISING OUT OF THE USE OF THE COMPUTER PRODUCTS IN ANY CRITICAL APPLICATIONS. IF YOU USE THE COMPUTER PRODUCTS IN A CRITICAL APPLICATION, YOU, AND NOT TOSHIBA, ASSUME FULL RESPONSIBILITY FOR SUCH USE.**

## FCC Notice

This equipment has been tested and found to comply with the limits for a Class B digital device, pursuant to Part 15 of the FCC rules. These limits are designed to provide reasonable protection against harmful interference in a residential installation.

This equipment generates, uses and can radiate radio frequency energy and, if not installed and used in accordance with the instructions, it may cause harmful interference to radio communications. However, there is no guarantee that interference will not occur in a particular installation. If this equipment does cause harmful interference to radio or television reception, which can be determined by turning the equipment off and on, the user is encouraged to try to correct the interference by one or more of the following measures:

- ❖ Reorient or relocate the receiving antenna.
- ❖ Increase the separation between the equipment and receiver.
- ❖ Connect the equipment to an outlet on a circuit different from that to which the receiver is connected.

- ❖ Consult the dealer or an experienced radio/TV technician for help.



*NOTE: Only peripherals complying with the FCC Class B limits may be attached to this computer. Operation with non-compliant peripherals or peripherals not recommended by Toshiba is likely to result in interference to radio and TV reception. Shielded cables must be used between the external devices and the computer's parallel port, video jack, USB ports, PS/2<sup>®</sup> port and microphone jack. Changes or modifications made to this equipment not expressly approved by Toshiba or parties authorized by Toshiba could void the user's authority to operate the equipment.*

This device complies with Part 15 of the FCC Rules. Operation is subject to the following two conditions:

- ❖ This device may not cause harmful interference.
- ❖ This device must accept any interference received, including interference that may cause undesired operation.

Contact:

Toshiba America Information Systems, Inc.  
9740 Irvine Blvd.  
Irvine, CA 92618-1697  
(949) 583-3000

## Industry Canada Requirement

This Class B digital apparatus complies with Canadian ICES-003.

Cet appareil numérique de la classe B est conforme à la norme NMB-003 du Canada.

## FCC Requirements

The following information is pursuant to FCC CFR 47, Part 68 and refers to internal modems.

---

## Installation

When you are ready to install or use the modem, call your local telephone company and give them the following information:

- ❖ The telephone number of the line to which you will connect the modem.
- ❖ The FCC registration number of the modem.
- ❖ The ringer equivalence number (REN) of the modem, which is 0.6B.

The modem connects to the telephone line by means of a standard jack called the USOC RJ11C.

## Type of Service

Your modem is designed to be used on standard-device telephone lines. Connection to telephone company-provided coin service (central office implemented systems) is prohibited. Connection to party lines service is subject to State tariffs. If you have any questions about your telephone line, such as how many pieces of equipment you can connect to it, the telephone company will provide this information upon request.

## Telephone Company Procedures

The goal of the telephone company is to provide you with the best service it can. In order to do this, it may occasionally be necessary for them to make changes in their equipment, operations or procedures. If these changes might affect your service or the operation of your equipment, the telephone company will give you notice, in writing, to allow you to make any changes necessary to maintain uninterrupted service.

## If Problems Arise

If any of your telephone equipment is not operating properly, you should immediately remove it from your telephone line, as it may cause harm to the telephone network. If the telephone company notes a problem, they may temporarily discontinue service. When practical, they will notify you in advance of this disconnection. If advance notice is not feasible, you will be notified as soon as possible. When you are notified, you will be given the opportunity to correct the problem and informed of your right to file a complaint with the FCC. In the event repairs are ever needed on your modem, they should be performed by Toshiba America Information Systems, Inc. or an authorized representative of Toshiba America Information Systems, Inc.

# 6

---

## Disconnection

If you should ever decide to permanently disconnect your modem from its present line, please call the telephone company and let them know of this change.

## Fax Branding

The Telephone Consumer Protection Act of 1991 makes it unlawful to use a computer or other electronic device to send any message via a telephone fax machine unless such message clearly contains in a margin at the top or bottom of each transmitted page or on the first page of the transmission, the date and time it is sent and an identification of the business, other entity or individual sending the message and the telephone number of the sending machine or such business, other entity or individual.

In order to program this information into your fax modem, you should complete the setup for your fax software before sending a message.

## Instructions for IC CS-03 certified equipment

- 1 **NOTICE:** The Industry Canada label identifies certified equipment. This certification means that the equipment meets certain telecommunications network protective, operational and safety requirements as prescribed in the appropriate Terminal Equipment Technical Requirements document(s). The Department does not guarantee the equipment will operate to the user's satisfaction.

Before installing this equipment, users should ensure that it is permissible to be connected to the facilities of the local telecommunications company. The equipment must also be installed using an acceptable method of connection. The customer should be aware that compliance with the above conditions may not prevent degradation of service in some situations.

Repairs to certified equipment should be coordinated by a representative designated by the supplier. Any repairs or alterations made by the user to this equipment, or equipment malfunctions, may give the telecommunications company cause to request the user to disconnect the equipment.

Users should ensure for their own protection that the electrical ground connections of the power utility, telephone lines and internal metallic water pipe system, if present, are connected together. This precaution may be particularly important in rural areas.

Caution: Users should not attempt to make such connections themselves, but should contact the appropriate electric inspection authority, or electrician, as appropriate.

- 2 The user manual of analog equipment must contain the equipment's Ringer Equivalence Number (REN) and an explanation notice similar to the following:

The Ringer Equivalence Number (REN) of this device is 0.3.

NOTICE: The Ringer Equivalence Number (REN) assigned to each terminal device provides an indication of the maximum number of terminals allowed to be connected to a telephone interface. The termination on an interface may consist of any combination of devices subject only to the requirement that the sum of the Ringer Equivalence Numbers of all the devices does not exceed 5.

- 3 The standard connecting arrangement (telephone jack type) for this equipment is jack type(s): USOC RJ11C.

## Wireless Interoperability

The Toshiba Wireless LAN Mini PCI Card products are designed to be interoperable with any wireless LAN product that is based on Direct Sequence Spread Spectrum (DSSS) radio technology, and is compliant to:

- ❖ The IEEE 802.11 Standard on Wireless LANs (Revision B), as defined and approved by the Institute of Electrical and Electronics Engineers.
- ❖ The Wireless Fidelity (Wi-Fi™) certification as defined by the WECA Wireless Ethernet Compatibility Alliance.

## Wireless LAN and your Health

Wireless LAN products, like other radio devices, emit radio frequency electromagnetic energy. The level of energy emitted by Wireless LAN devices however is far much less than the electromagnetic energy emitted by wireless devices like for example mobile phones. Because Wireless LAN products operate within the guidelines found in radio frequency safety standards and recommendations, Toshiba believes Wireless LAN is safe for use by consumers. These standards and recommendations reflect the consensus of the scientific community and result from deliberations of panels and committees of scientists who continually review and interpret the extensive research literature.

In some situations or environments, the use of Wireless LAN may be restricted by the proprietor of the building or responsible representatives of the organization. These situations may for example include:

- ❖ Using the Wireless LAN equipment on board of airplanes, or
- ❖ In any other environment where the risk of interference to other devices or services is perceived or identified as harmful.

If you are uncertain of the policy that applies on the use of wireless devices in a specific organization or environment (e.g., airports), you are encouraged to ask for authorization to use the Wireless LAN device prior to turning on the equipment.

## Regulatory Information

The Toshiba Wireless LAN Mini PCI Card must be installed and used in strict accordance with the manufacturer's instructions as described in the user documentation that comes with the product. This device complies with the following radio frequency and safety standards.

### Canada – Industry Canada (IC)

This device complies with RSS 210 of Industry Canada.

Operation is subject to the following two conditions: (1) this device may not cause interference, and (2) this device must accept any interference, including interference that may cause undesired operation of this device.

### USA-Federal Communications Commission (FCC)

This device complies with Part 15 of FCC Rules. Operation of the devices in a Wireless LAN System is subject to the following two conditions:

- ❖ This device may not cause harmful interference.
- ❖ This device must accept any interference that may cause undesired operation.

### Caution: Exposure to Radio Frequency Radiation

The radiated output power of the Toshiba Wireless LAN Mini PCI Card is far below the FCC radio frequency exposure limits. Nevertheless, the Toshiba Wireless LAN Mini PCI Card shall be used in such a manner that the potential for human contact during normal operation is minimized. When using this device in combination with Wireless LAN Outdoor Antenna products, a certain



separation distance between antenna and nearby persons has to be kept to ensure RF exposure compliance. The distance between the antennas and the user should not be less than 20 cm.

Refer to the Regulatory Statements as identified in the documentation that comes with those products for additional information.

The Toshiba Wireless LAN Mini PCI Card is far below the FCC radio frequency exposure limits.

Nevertheless, it is advised to use the Toshiba Wireless LAN Mini PCI Card in such a manner that human contact during normal operation is minimized.

## Interference Statement

This equipment has been tested and found to comply with the limits for a Class B digital device, pursuant to Part 15 of the FCC Rules. These limits are designed to provide reasonable protection against harmful interference in a residential installation. This equipment generates, uses, and can radiate radio frequency energy. If not installed and used in accordance with the instructions, it may cause harmful interference to radio communications. However, there is no guarantee that interference will not occur in a particular installation.

If this equipment does cause harmful interference to radio or television reception, which can be determined by turning the equipment off and on, the user is encouraged to try and correct the interference by one or more of the following measures:

- ❖ Reorient or relocate the receiving antenna.
- ❖ Increase the distance between the equipment and the receiver.
- ❖ Connect the equipment to an outlet on a circuit different from that to which the receiver is connected.
- ❖ Consult the dealer or an experienced radio/TV technician for help.

Toshiba is not responsible for any radio or television interference caused by unauthorized modification of the devices included with this Toshiba Wireless LAN Mini PCI Card, or the substitution or attachment of connecting cables and equipment other than specified by Toshiba.

The correction of interference caused by such unauthorized modification, substitution or attachment will be the responsibility of the user.

## Approved Countries for use

This equipment is approved to the radio standard by the countries in Fig.1.

Australia	Austria	Belgium
Canada	Denmark	Finland
Germany	Iceland	Ireland
Japan	Luxembourg	Netherlands
New Zealand	Norway	Sweden
Switzerland	UK	USA
Greece	Italy	France
Poland	Portugal	Spain

**Caution:** Do not use this equipment except in the countries in Fig.1.

## CD-ROM, DVD-ROM, DVD-ROM/CD-RW Safety Instructions

The CD-ROM, DVD-ROM, and DVD-ROM/CD-RW drives employ a laser system. To ensure proper use of this product, please read this instruction manual carefully and retain for future reference. Should the unit ever require maintenance, contact an authorized service location.

Use of controls, adjustments or the performance of procedures other than those specified may result in hazardous radiation exposure.

To prevent direct exposure to the laser beam, do not try to open the enclosure.

## Location of the required label

Sample shown below. (Location of the label and manufacturing information may vary.)

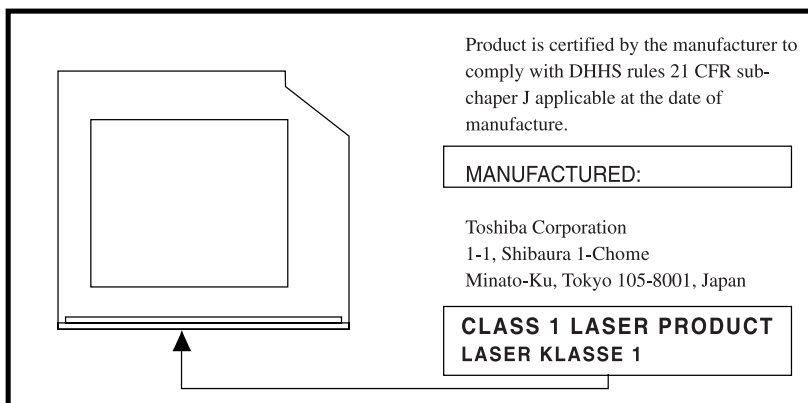

**CAUTION:** *This appliance contains a laser system and is classified as a "CLASS 1 LASER PRODUCT." To use this model properly, read the instruction manual carefully and keep it for your future reference. In case of any trouble with this model, please contact your nearest "AUTHORIZED service station." To prevent direct exposure to the laser beam, do not try to open the enclosure.*

CLASS 1 LASER PRODUCT  
LASER KLASSE 1

*Use of controls or adjustments or performance of procedures other than those specified in the owner's manual may result in hazardous radiation exposure.*

## Copyright

This guide is copyrighted by Toshiba America Information Systems, Inc. with all rights reserved. Under the copyright laws, this guide cannot be reproduced in any form without the prior written permission of Toshiba. No patent liability is assumed, however, with respect to the use of the information contained herein.

©2001 by Toshiba America Information Systems, Inc. All rights reserved.

## Export Administration Regulation

This document contains technical data that may be controlled under the U.S. Export Administration Regulations, and may be subject to the approval of the U.S. Department of Commerce prior to export. Any export, directly or indirectly, in contravention of the U.S. Export Administration Regulations is prohibited.

### Notice

The information contained in this manual, including but not limited to any product specifications, is subject to change without notice.

**TOSHIBA CORPORATION AND TOSHIBA AMERICA INFORMATION SYSTEMS, INC. (TOSHIBA) PROVIDES NO WARRANTY WITH REGARD TO THIS MANUAL OR ANY OTHER INFORMATION CONTAINED HEREIN AND HEREBY EXPRESSLY DISCLAIMS ANY IMPLIED WARRANTIES OF MERCHANTABILITY OR FITNESS FOR ANY PARTICULAR PURPOSE WITH REGARD TO ANY OF THE FOREGOING. TOSHIBA ASSUMES NO LIABILITY FOR ANY DAMAGES INCURRED DIRECTLY OR INDIRECTLY FROM ANY TECHNICAL OR TYPOGRAPHICAL ERRORS OR OMISSIONS CONTAINED HEREIN OR FOR DISCREPANCIES BETWEEN THE PRODUCT AND THE MANUAL. IN NO EVENT SHALL TOSHIBA BE LIABLE FOR ANY INCIDENTAL, CONSEQUENTIAL, SPECIAL, OR EXEMPLARY DAMAGES, WHETHER BASED ON TORT, CONTRACT OR OTHERWISE, ARISING OUT OF OR IN CONNECTION WITH THIS MANUAL OR ANY OTHER INFORMATION CONTAINED HEREIN OR THE USE THEREOF.**

---

## Trademarks

Satellite, Noteworthy, and Fn-Esse are registered trademarks, Ask IRIS Online, SelectServ, VirtualTech, FreedomWare are trademarks, and InTouch is a service mark of Toshiba America Information Systems, Inc. and/or Toshiba Corporation.

Intel and Pentium are registered trademarks of Intel Corporation.

CompuServe is a registered trademark of America Online, Inc.

Ethernet is a registered trademark of Xerox, Inc.

LapLink is a registered trademark of Traveling Software, Inc.

Microsoft, Windows, Windows Millennium Edition, Windows XP, Windows XP Pro, DirectX, Active Desktop, and DirectShow are registered trademarks, and Windows Media is a trademark of Microsoft Corporation.

PS/2 and Wake on LAN are registered trademarks of International Business Machines Corporation.

RingCentral is a registered trademark of Ring Zero Systems, Inc.

Soundblaster Pro is a registered trademark of Creative Labs, Inc.

SPANworks 2000™ is a trademark of SPANworks, U.S.A.

Wi-Fi™ is a trademark of the Wireless Capability Ethernet Alliance.

WinDVD™ is a trademark of InterVideo, Inc.

TouchPad™ is a registered trademark of Synaptics.

All other brand and product names are trademarks or registered trademarks of their respective companies.

## Computer Disposal Information

This product contains mercury. Disposal of this material may be regulated due to environmental considerations. For disposal, reuse or recycling information, please contact your local government or the Electronic Industries Alliance at [www.eiae.org](http://www.eiae.org).



# Contents

---

Introduction .....	23
This guide.....	23
Safety icons.....	24
Other icons used .....	25
Other documentation .....	25
Service options .....	26
Chapter 1: Finding Your Way Around .....	27
Making sure you have everything.....	27
Front with the display closed.....	28
Back.....	29
Right side .....	31
Left side.....	32
Front with the display open .....	34
Status panel.....	35
Shortcut buttons .....	36
System indicator panel.....	36
Front panel controls.....	37
CD/DVD/Media Player power switch .....	38
Underside.....	40

Chapter 2: Getting Started .....	41
Selecting a place to work.....	41
Creating a computer-friendly environment .....	41
Keeping yourself comfortable.....	42
Precautions .....	46
Setting up your computer .....	47
Installing additional memory (optional).....	48
Removing a memory module .....	50
Connecting a mouse .....	52
Connecting a keyboard .....	53
Connecting a printer .....	53
Connecting the AC adapter .....	54
Charging the battery .....	56
Using the computer for the first time.....	57
Opening the display panel.....	57
Turning on the power .....	57
Using the TouchPad .....	59
Setting up your software.....	60
Registering your computer.....	61
Setting up a printer .....	62
Customizing your computer's settings.....	65
Turning off the computer.....	66
Caring for your computer.....	67
Cleaning the computer.....	67
Moving the computer.....	67
Using a computer lock.....	68
Chapter 3: Learning the Basics .....	69
Computing tips.....	69
Using the keyboard.....	70
Character keys .....	71
Ctrl, Fn, and Alt keys.....	71
Function keys.....	71
Windows special keys.....	72
Overlay keys.....	72



---

Starting a program.....	73
Saving your work.....	74
Printing your work.....	75
Using diskettes .....	76
Inserting and removing diskettes.....	76
Caring for diskettes.....	77
Backing up your files.....	77
Copying to a diskette.....	77
Using your CD or DVD drive .....	78
Drive components and control buttons.....	79
Inserting a disc.....	80
Viewing the contents of a CD or DVD.....	83
Playing an audio CD.....	84
Playing a DVD.....	86
Removing a disc .....	86
Caring for CDs and DVDs.....	87
Setting up for communications .....	87
Using the modem .....	88
Using the LAN.....	89
Connecting your computer to a network.....	90
Accessing the Wi-Fi™ Mini PCI Module.....	92
Powering down the computer .....	93
Turn off computer command .....	93
Hibernation command.....	93
Standby command.....	94
Using the Turn Off Computer command.....	95
Using Hibernation .....	96
Using Standby.....	98
<b>Chapter 4: Mobile Computing.....</b>	<b>99</b>
Toshiba's energy-saver design.....	99
Managing power usage.....	99
Running the computer on battery power.....	100
Using additional battery packs.....	100
Battery safety precautions.....	100

---

Maximizing battery life .....	101
Charging batteries.....	101
Charging the main battery .....	102
Charging the RTC battery.....	102
Monitoring battery power.....	103
Determining remaining battery power.....	103
Conserving battery power.....	104
What to do when the battery runs low .....	104
Changing the main battery .....	105
Removing the battery.....	106
Inserting a charged battery.....	107
Disposing of used batteries safely.....	107
Traveling tips.....	108
<b>Chapter 5: Getting to Know Windows XP.....</b>	<b>109</b>
Lesson 1: Exploring the desktop .....	110
Finding your way around the desktop .....	110
Windows <sup>®</sup> XP file system.....	113
Lesson 2: Using the TouchPad pointing device .....	114
Lesson 3: Learning about the Internet.....	116
Lesson 4: Creating a new document.....	117
Lesson 5: Creating a new folder .....	119
Lesson 6: Starting programs.....	120
Lesson 7: Resizing, repositioning, and hiding windows.....	122
Using the taskbar.....	123
Minimizing and maximizing windows .....	123
Resizing and moving windows .....	124
Lesson 8: Closing programs.....	125
Lesson 9: Creating shortcuts.....	126
Creating a shortcut to the Calculator.....	126
Creating a shortcut to the Character Map .....	127
Lesson 10: Changing the screensaver.....	129
Lesson 11: Setting the date and time.....	131
Lesson 12: Removing objects from the desktop.....	132
Lesson 13: Using System Restore.....	134

---

Lesson 14: If I am lost, what do I do? .....	135
Windows XP Help .....	135
Using the online tours and tutorials .....	137
Lesson 15: Turning off your computer.....	139
<b>Chapter 6: Exploring Your Options.....</b>	<b>141</b>
Windows XP special features.....	141
Personalizing your desktop .....	142
Customizing the taskbar.....	142
Personalizing individual windows .....	144
Adding a background to a window .....	144
Customizing window toolbars.....	144
Displaying information about each folder.....	146
Connecting a monitor, keyboard and mouse.....	147
Connecting to a local area network .....	147
Accessing a LAN .....	147
Setting up the connection .....	148
Setting up a wireless connection.....	148
Exchanging data with another computer .....	148
Transferring files using a parallel port connection .....	148
Connecting to the Internet.....	149
Making the physical connection.....	149
Signing up with an Internet Service Provider.....	151
Getting started.....	152
Using the Internet.....	152
The Internet.....	153
The World Wide Web .....	153
Surfing the Internet.....	153
Internet features .....	154
Uploading and downloading files from the Internet ...	154
Toshiba's online resources .....	155
Conducting an electronic meeting .....	155
Exploring video features .....	156
Viewing presentations or DVD movies on a TV .....	156
Exploring audio features.....	158

---

Recording sounds.....	158
Using a microphone.....	158
Adjusting recording quality.....	159
Using external speakers or headphones.....	160
Using PC Cards.....	161
PC Card supporting software.....	162
Inserting PC Cards.....	162
Removing PC Cards.....	164
Hot swapping.....	164
Emulating a full-size keyboard.....	165
<b>Chapter 7: Toshiba Utilities.....</b>	<b>167</b>
Fn-esse.....	167
Starting Fn-esse.....	168
Assigning a key to a program or document.....	169
Viewing existing key assignments.....	171
Changing or removing existing key assignments.....	171
Toshiba Hardware Setup.....	172
Toshiba Power Saver.....	174
<b>Chapter 8: WinDVD 2000.....</b>	<b>175</b>
Playing DVDs.....	175
Using the WinDVD toolbar.....	177
Using the WinDVD status bar.....	178
Using the WinDVD control panel.....	178
Using the control panel playback buttons.....	179
Maximizing the video window.....	181
Using playlists.....	182
Creating playlists.....	182
Loading and playing playlists.....	183
Resuming normal playback after using playlists.....	184
Customizing WinDVD.....	184
Setting general properties.....	185
Setting audio properties.....	186
Setting display properties.....	188

---

Using WinDVD advanced features .....	189
Zooming in .....	193
Zooming out.....	193
Panning.....	193
Adjusting the color balance.....	194
Launching an Internet browser from WinDVD.....	194
Getting help.....	194
Exiting WinDVD.....	195
<b>Chapter 9: If Something Goes Wrong .....</b>	<b>197</b>
Problems that are easy to fix.....	197
Problems when you turn on the computer.....	200
Windows XP problems.....	200
Using startup options to fix problems.....	201
Internet problems.....	202
Windows XP operating system can help you .....	202
Resolving a hardware conflict.....	203
A plan of action.....	204
Resolving hardware conflicts on your own.....	204
Fixing a problem with Device Manager.....	206
Memory card problems .....	207
Power problems .....	208
Keyboard problems .....	209
Display problems.....	210
Disk drive problems.....	212
CD-ROM/DVD-ROM drive problems.....	214
Sound system problems.....	215
PC Card problems.....	215
Printer problems .....	218
Modem problems.....	219
Develop good computing habits.....	220
Using VirtualTech.....	222
If you need further assistance .....	223
Before you call.....	223
Contacting Toshiba .....	224

Other Toshiba Internet Web sites .....	225
Toshiba's worldwide offices .....	225
Appendix A: Hot Keys .....	229
Appendix B: Power Cable Connectors .....	233
Glossary .....	235
Index.....	251

# Introduction

---

Welcome to the world of powerful and portable multimedia computers! With your new Toshiba notebook computer, your access to information can accompany you wherever you go.

Your system comes with either Windows XP Home or Windows XP Pro. This user's guide contains information for both operating systems and how they function with your Toshiba computer. For more specific information on the operating system, see the Microsoft booklet that shipped with your computer.

## This guide

This guide introduces the computer's features. You can:

- ❖ Read the entire guide from beginning to end.
- ❖ Skim through and stop when a topic interests you.
- ❖ Use the table of contents and the index to find specific information.

If you are new to computers, or have not used a notebook computer before, read the first few chapters to familiarize yourself

with the components of the computer and how to turn it on. After that, seek out whatever interests you most.

## Safety icons

This manual contains safety instructions that must be observed in order to avoid potential hazards that could result in personal injuries, damage to your equipment, or loss of data. The safety cautions have been classified according to the seriousness of the risk, and the icons highlight these instructions as follows:



***DANGER:** This icon indicates the existence of a hazard that could result in death or serious bodily injury if the safety instruction is not observed.*

---



***WARNING:** This icon indicates the existence of a hazard that could result in bodily injury if the safety instruction is not observed.*

---



***CAUTION:** This icon indicates the existence of a hazard that could result in damage to equipment or property if the safety instruction is not observed.*

---



***NOTE:** This icon indicates information that relates to the safe operation of the equipment or related items.*

---



## Other icons used

Additional icons highlight other helpful or educational information:



*TECHNICAL NOTE:* This icon highlights technical information about the unit.



*HINT:* This icon denotes helpful hints and tips.



*DEFINITION:* This icon indicates the definition of a term used in the text.

## Other documentation

Your computer comes with the following documentation in addition to this user's guide.

- ❖ An electronic version of the user's guide. Look for the user's guide icon on your desktop or in the DOCS folder on the C: drive.
- ❖ Guides for other programs that may come preinstalled on your computer or that are available for installation on your Recovery and Configuration Builder CD.
- ❖ *Toshiba accessories information*, which lists accessories available from Toshiba and explains how to order them.
- ❖ The Microsoft<sup>®</sup> Windows<sup>®</sup> operating system documentation which explains the features of the operating system.

## Service options

Toshiba offers a full line of service options built around its SelectServ™ warranty programs. For more information, visit Toshiba's Web site at [www.Toshiba.com](http://www.Toshiba.com).

If you have a problem or need to contact Toshiba, see “[If Something Goes Wrong](#)” on page 197.

# Chapter 1

## Finding Your Way Around

---

This chapter presents a “grand tour” of your Satellite computer. It serves as a reference when you need to locate specific parts of the computer.

### **Making sure you have everything**

Before doing anything else, consult the Quick Start card that shipped with your computer to make sure you received everything. If any items are missing or damaged, notify your dealer immediately. For additional help, see [“If you need further assistance” on page 223.](#)

## Front with the display closed

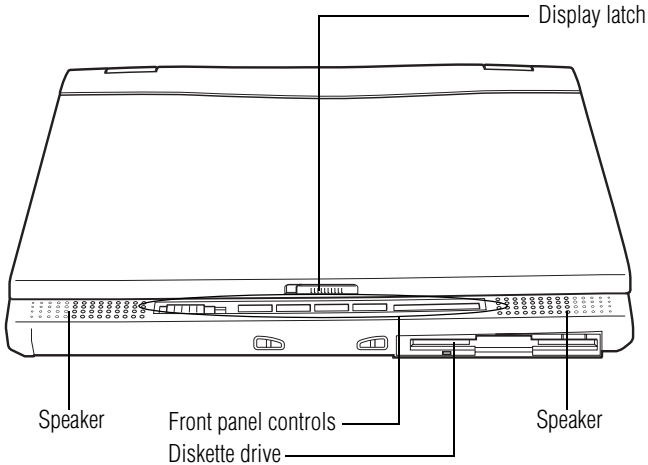

The **display latch** keeps the display panel closed and locked. To open the display panel, slide the latch to the right and raise the panel.

The **speakers** let you hear the computer's audio output—such as system alarms associated with your software and music from audio CDs or DVDs.

The **front panel controls** perform several functions, depending on the position of the CD/DVD/Media Player power switch. For more information, see [“Front panel controls” on page 37](#).

The **diskette drive** allows you to use either high-density or double-density 3.5-inch diskettes.

## Back

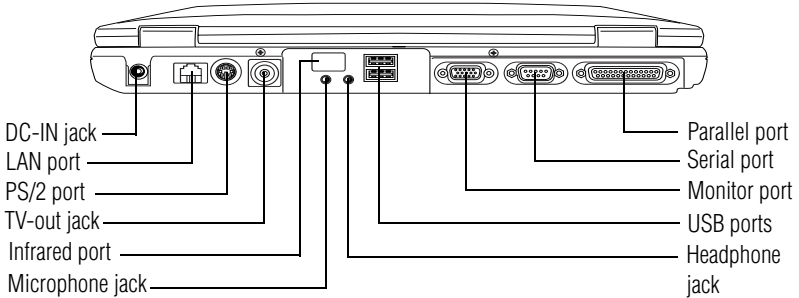

The **DC-IN jack** is where you plug in the AC adapter. For more information, see “[Connecting the AC adapter](#)” on page 54.



The **LAN port** lets you connect the computer to a local area network using a 10/100 Ethernet link via a standard Ethernet® network cable.



The **PS/2® port** allows you to connect an optional PS/2-compatible mouse or external keyboard. An optional “Y” cable enables you to connect both a PS/2 mouse and a PS/2 keyboard to the port.



The **TV-out jack** allows you to connect a television or other video output device.



The **infrared port** allows cable-free communication with another device, such as a computer or printer, that has a compatible infrared port.



*NOTE: It is recommended that you do not use the infrared port at the same time as either playing audio or connecting to the internet via a modem. Audio quality may be reduced and the modem connection may be slower or disrupted.*



The 3.5 mm **microphone jack** lets you connect an external monaural microphone or other audio-input device.



The 3.5 mm **headphone jack** lets you connect stereo headphones or other audio-output devices, such as external speakers. Connecting headphones or other devices to this jack automatically disables the internal speakers.



The **parallel port** lets you connect a parallel printer, or other parallel device, including ECP-compatible devices.

---



*DEFINITION: ECP (Extended Capabilities Port) is a parallel-port standard for PCs that support bi-directional communication between the PC and attached devices (such as a printer).*

---



Use the **serial port** to connect a serial mouse, serial printer, or other serial device.



The **monitor port** allows you to connect an external monitor.



The **USB (Universal Serial Bus) ports** allow you to connect USB peripherals to your computer, such as a keyboard, pointing device, printer, or monitor.

---



*DEFINITION: USB is a peripheral expansion standard that supports a data-transfer rate of up to 12 Mbps. USB peripherals have a single standard for cables and connectors.*

*The USB standard allows you to install and remove USB devices while the computer is on. Switching devices without turning off the computer is called "hot swapping."*

---

## Right side

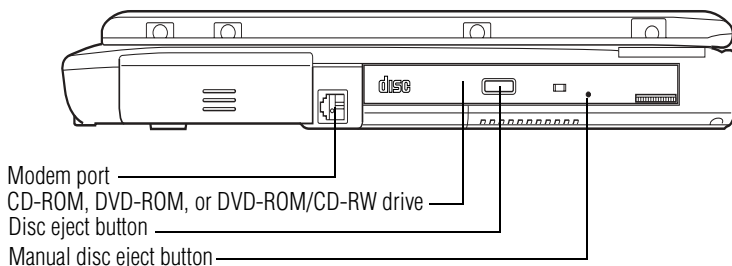

The **modem port** lets you use a modular phone cable to connect the built-in modem directly to a standard telephone line. For more information, see [“Using the modem” on page 88](#).

The **CD-ROM, DVD-ROM, or DVD-ROM/CD-RW drive** allows you to install and run programs from application CD-ROMs. You can also use it to play audio CDs. A DVD-ROM drive also enables you to view DVD video presentations or play DVD movies. With a CD-RW drive, you can also write files (including music) to a CD-Recordable (CD-R) or CD-Rewritable (CD-RW) disc. A DVD-ROM/CD-RW drive can perform all of the above functions.

The **disc eject button** enables you to eject a disc from the CD-ROM, DVD-ROM, or DVD-ROM/CD-RW drive.

The **manual disc eject button** enables you to manually eject a disc from the CD-ROM, DVD-ROM, or DVD-ROM/CD-RW drive when the power is off.

## Left side

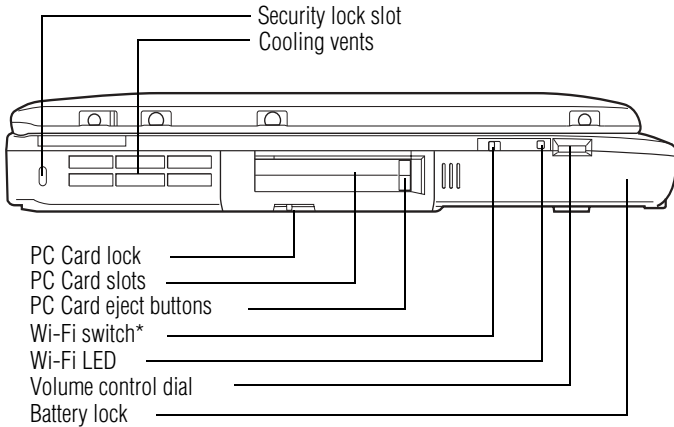

\* for systems with optional Wi-Fi™



The **security lock slot** allows you to attach an optional PORT-Noteworthy® computer lock to secure the computer to a large, heavy object, such as your desk.

The **cooling vents** prevent the computer's central processing unit (CPU) from overheating so that it can continue to perform at its maximum speed.

The **PC Card lock** prohibits accidental ejection of the PC Cards.



The two stacked PCMCIA-compatible **PC Card slots** allow you to install additional devices. Each slot can accommodate a Type I or Type II PC Card. Both slots are required to install a Type III PC Card. For more information, see [“Using PC Cards” on page 161](#).



**CAUTION:** Keep foreign objects out of the PC Card slots. A pin or similar object that accidentally gets into a slot can damage the computer's circuitry.

The **PC Card eject buttons** allow easy removal of PC Cards.



---

The **Wi-Fi™ switch** (available only on Wi-Fi systems) turns the optional 802.11b Wi-Fi wireless communication system on or off.

---



*NOTE: The Wi-Fi™ option must be factory-installed at the time of order. You cannot install it later.*

---

The **Wi-Fi™ LED** (available only on Wi-Fi systems) glows orange when the wireless LAN functions are on.



The volume control dial allows you to adjust the volume of the computer's speakers.



The battery lock releases the battery. For more information, see [“Charging the main battery” on page 102.](#)

## Front with the display open

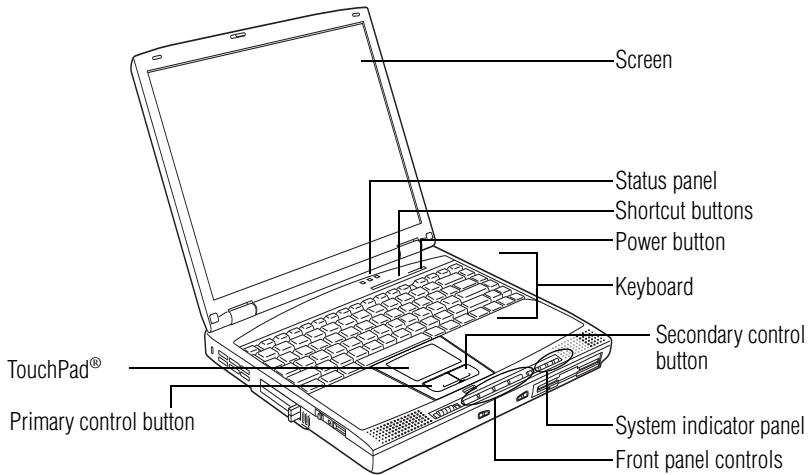

The **screen** is either:

- ❖ A 13.3-inch diagonal, Thin Film Transistor (TFT) color liquid crystal display (LCD), or
- ❖ A 14.1-inch diagonal, Thin Film Transistor (TFT) color liquid crystal display (LCD).
- ❖ A 15.0-inch diagonal, Thin Film Transistor (TFT) color liquid crystal display (LCD).



*DEFINITION: TFT (Thin Film Transistor) is an active-matrix LCD technology that uses one TFT for each cell. Active-matrix displays are viewable from wider angles than most passive-matrix displays.*

The lights on the **status panel** provide information about various keyboard functions.

The **shortcut buttons** allow you direct access to application programs.

The **power button** turns the computer on and off.

The **keyboard** provides all the functionality of a full-size keyboard. For more information, see [“Using the keyboard” on page 70](#).

The lights on the **system indicator panel** provide information about various system functions.

The **front panel controls** allow convenient use of the CD/DVD Media Player. For more information, see [“Front panel controls” on page 37](#).

The computer’s TouchPad® allows you to position the cursor on the screen. The two control buttons work with the TouchPad. The left button acts as the **primary button** on a mouse. The right button acts as the **secondary button** on a mouse.

## Status panel



The **caps lock light** glows when you press the Caps Lock key. When this light is on, pressing a letter key on the keyboard produces an uppercase (capital) letter.



The **cursor control mode light** glows when the cursor control overlay is on. When this light is on, pressing an overlay key moves the cursor in the direction of the white arrow printed on the left top of the key instead of typing the letter printed on the key. For more information, see [“Using the cursor control overlay” on page 73](#).



The **numeric mode light** glows when the numeric overlay is on. When this light is on, pressing an overlay key types the number printed on the right front of the key instead of typing the letter printed on the top of the key. For more information, see [“Using the numeric keypad overlay” on page 72](#).

### Shortcut buttons

Shortcut buttons allow you to automatically launch a chosen application. If your computer is off, you can press the shortcut button to turn on the computer and launch the browser automatically in one step.



The **Internet button** is a shortcut button that launches your Internet Web browser.



The second **shortcut button** is user programmable button available to launch custom applications.



The third **shortcut button** is user programmable button available to launch custom applications.

### System indicator panel

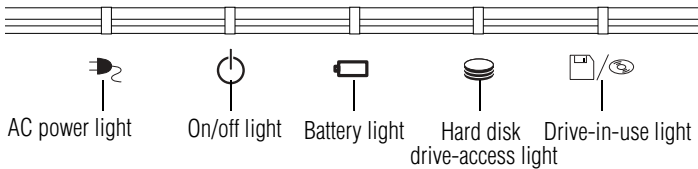

The **AC power light** glows green when the computer is connected to an AC power source.



The **on/off light** glows green when the computer is on, or when the computer is off and the CD/DVD/Media Player power switch is used.



The **battery light** indicates the main battery's current charge. It:

- ❖ Glows green when the battery is fully charged
- ❖ Glows amber while the battery is being charged
- ❖ Flashes amber when the charge reaches the critical battery level, normally 2 percent.
- ❖ Does not glow if the external power source is disconnected or if the battery is completely discharged



The **hard disk drive-access light** flashes green when the hard disk drive is being accessed.



The **drive-in-use light** flashes green when the diskette drive or the CD-ROM, DVD-ROM, or DVD-ROM/CD-RW drive is being accessed.



*CAUTION: Never turn off the computer while any of the drives are in use. Doing so may result in loss of data.*

## Front panel controls

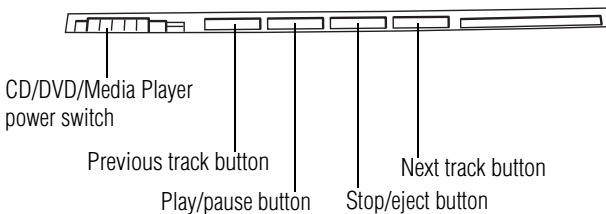

Use the **CD/DVD/Media Player power switch** to play CDs and DVDs.

- ◀◀ The **previous track** button returns to the beginning of the preceding track (for CDs) or chapter (for DVDs) on the disc.
- ▶|| The **play/pause** button starts playing the current track in the CD-ROM, DVD-ROM, or DVD-ROM/CD-RW drive, or pauses a track that is already playing.
  - The **stop/eject** button stops the disc if it is playing, or opens the CD-ROM, DVD-ROM, or DVD-ROM/CD-RW drive tray. You can eject a disc by pressing the stop/eject button twice. Use this method to eject a disc when the computer is turned off and the eject button on the front of the drive is unavailable.
- ▶▶ The **next track** button skips to the beginning of the following track (for CDs) or chapter (for DVDs) on the disc.

## CD/DVD/Media Player power switch

The **CD/DVD/Media Player** power switch allows you to play audio CDs with the computer turned off. This switch has two positions: CD/DVD, which is to the left as you face the computer from the front, and Media Player, which is to the right. What happens when you press this switch depends on what's in the drive.



*NOTE: If you have set a password for logging onto your system, your computer will start up and you will need to log on before being able to play a CD or DVD.*

---

## DVD playback and the power switch

The CD/DVD/Media Player switch sets the computer to turn on the CD/DVD player automatically if there is a disc in the DVD-ROM drive when the computer is turned off, or to power up and launch Windows Media™ Player.

## Audio CD playback and the power switch

If there's an audio CD in the drive, setting the switch to the left leaves the computer's main power off, but turns on the sound system and the disk activity light.

To play the CD, press the Play/Pause button.

To stop the CD, slide the switch to the left and hold it for two seconds.

## What happens when the drive is empty

If there's nothing in the drive, setting the switch to the left turns on the sound system and the disk activity light.

To eject the CD/DVD tray, press either the eject button on the drive or the Stop button twice.

With nothing in the drive, setting the switch to the right turns on both the computer's main power and the power to the sound system. When you open the display, Windows Media™ Player launches, and the sound system plays the default sound (wave file).

For more information about playing CDs, see [“Playing an audio CD”](#) on page 84.

For more information about playing DVDs, see [“Playing a DVD”](#) on page 86.

## Underside

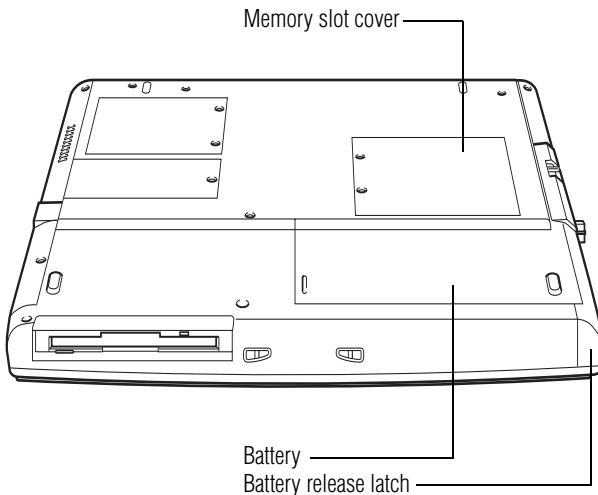

The **memory slot cover** protects the expansion memory module. For more information about expansion memory modules, see [“Installing additional memory \(optional\)”](#) on page 48.

The **battery** provides DC power to the computer. For information about replacing the battery, see [“Changing the main battery”](#) on page 105.



The **battery release latch** and **battery latch lock** secure the battery to the computer and prevent it from falling out.



# Chapter 2

## Getting Started

---

This chapter provides tips for working comfortably, describes how to connect components, and explains what to do the first time you use your notebook computer.

### Selecting a place to work

Your computer is portable and designed to be used in a variety of circumstances and locations.

### Creating a computer-friendly environment

Place the computer on a flat surface which is large enough for the computer and any other items you use, such as a printer. Leave enough space around the computer and other equipment to provide adequate ventilation and prevent overheating.

To keep your computer in prime operating condition, protect your work area from:

- ❖ Dust, moisture, and direct sunlight
  - ❖ Liquids and corrosive chemicals
- 



*CAUTION: If you spill liquid into the computer, turn it off, unplug it from the AC power source, and let it dry out completely before turning it on again.*

*If the computer does not operate correctly after you turn it back on, contact a Toshiba-authorized service provider.*

---

- ❖ Equipment that generates a strong electromagnetic field, such as stereo speakers (other than speakers that are connected to the computer) or speakerphones
- ❖ Rapid changes in temperature or humidity and sources of temperature change such as air conditioner vents or heaters
- ❖ Extreme heat, cold, or humidity. Operate the computer within a temperature range of 41 degrees to 95 degrees Fahrenheit (5 degrees to 35 degrees Celsius) and 20% to 80% non-condensing humidity

## **Keeping yourself comfortable**

Strain and stress injuries are becoming more common as people spend more time using their computers. But, with a little care and proper use of the equipment, you can work comfortably throughout the day.

This section provides hints on avoiding strain and stress injuries. For more information, consult books on ergonomics, repetitive-strain injury, and repetitive-stress syndrome.

## Placement of the computer

Proper placement of the computer and external devices is important to avoid stress-related injuries.

- ❖ Place the computer on a flat surface at a comfortable height and distance. You should be able to type without twisting your torso or neck, and to look at the screen without slouching.
- ❖ If you are using an external monitor, the top of the screen should be no higher than eye level.
- ❖ If you use a paper holder, set it at about the same height and distance as the screen.

## Seating and posture

When using your computer, maintain good posture with your body relaxed and your weight distributed evenly. Proper seating is a primary factor in reducing work strain. Some people find a backless chair more comfortable than a conventional chair.

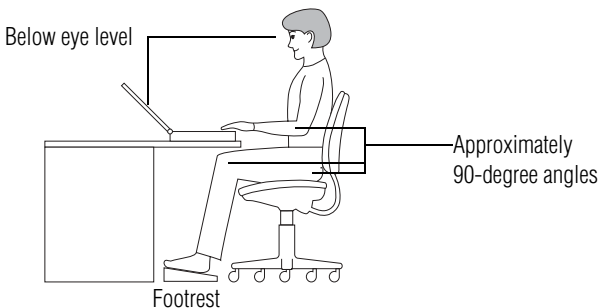

*Correct posture and positioning of the computer*

Whichever type you choose, use the following guidelines to adjust your chair for maximum computing comfort.

- ❖ Position your chair so that the keyboard is at or slightly below the level of your elbow. You should be able to type comfortably with your shoulders relaxed and your forearms parallel to the floor.

If you are using a conventional chair:

- ❖ Your knees should be slightly higher than your hips. If necessary, use a footrest to raise the level of your knees and ease the pressure on the back of your thighs.
- ❖ Adjust the back of your chair so that it supports the lower curve of your spine. If necessary, use a cushion to provide extra back support. Lower-back-support cushions are available at many office supply stores.
- ❖ Sit with your back straight so that your knees, hips, and elbows form approximately 90-degree angles when you work. Do not slump forward or lean back too far.

## Lighting

Proper lighting can improve the visibility of the display and reduce eyestrain.

- ❖ Position the display panel or external monitor so that sunlight or bright indoor lighting does not reflect off the screen. Use tinted windows or shades to reduce glare.
- ❖ Avoid placing your computer in front of a bright light that could shine directly in your eyes.
- ❖ If possible, use soft, indirect lighting in your computer work area.

---

## Arms and wrists

- ❖ Avoid bending, arching, or twisting your wrists. Keep them in a relaxed, neutral position while typing.
- ❖ Exercise your hands, wrists, and arms to improve circulation.



*WARNING: Using the computer keyboard incorrectly may result in discomfort and possible injury. If your hands, wrists, and/or arms bother you while typing, stop using the computer and rest. If the discomfort persists, consult a physician.*

---

## Work habits

The key to avoiding discomfort or injury from strain is to vary your activities. If possible, schedule a variety of tasks into your work day. Finding ways to break up the routine can reduce stress and improve your efficiency.

- ❖ Take frequent breaks to change position, stretch your muscles, and relieve your eyes. A break of two or three minutes every half hour is more effective than a long break after several hours.
- ❖ Avoid performing repetitive activities for long periods. Intersperse such activities with other tasks.
- ❖ Focusing your eyes on your computer screen for long periods can cause eyestrain. Look away from the computer frequently and focus your eyes on a distant object for at least 30 seconds.

## Precautions

Your notebook computer is designed to optimize safety, minimize strain, and withstand the rigors of travel. However, you should observe certain precautions to further reduce the risk of personal injury or damage to the computer.

- ❖ Avoid prolonged physical contact with the underside of the computer.

If the computer is used for long periods, its case can become very warm. While the temperature may not feel too hot to the touch, if you maintain physical contact with the computer for a long time (if you rest the computer on your lap, for example), your skin might suffer low-heat injury.

- ❖ Never apply heavy pressure to the computer or subject it to sharp impacts. Excessive pressure or impact can damage computer components or otherwise cause your computer to malfunction.
- ❖ Some PC Cards can become hot with prolonged use. If two cards are installed, both can become hot even if only one is being used. Overheating of a PC Card can result in errors or instability in its operation.

Be careful when you remove a PC Card that has been used for a long period.

- ❖ Avoid spilling liquids into the computer's keyboard.

If you do spill a liquid that gets into the keyboard, turn off the computer immediately. Leave the computer turned off overnight to let it dry out before you use it again.

- ❖ Never turn off the computer if a drive light indicates a drive is active.

Turning off the computer while it is reading from or writing to a disk may damage the disk, the drive, or both.

- ❖ Keep the computer and disks away from objects that generate strong magnetic fields, such as large stereo speakers.

Information on disks is stored magnetically. Placing a magnet too close to a disk can erase important files.

- ❖ Scan all new files for viruses.

This precaution is especially important for files you receive via diskette, email, or download from the Internet.

Occasionally, even new programs you buy from a supplier may contain a computer virus. You'll need a special program to check for viruses. Ask your dealer to help you.

## Setting up your computer

Your computer comes with a rechargeable battery pack that must be charged before you can use it.

To use external power or to charge the battery, you must attach the AC adapter. See [“Connecting the AC adapter” on page 54](#).

To register your computer online, or to sign up for an Internet account, you must connect the built-in modem to a telephone line. See [“Using the modem” on page 88](#).

Before starting to use your computer, you may also want to:

- ❖ Add more memory (see [“Installing additional memory \(optional\)” on page 48](#))
- ❖ Connect a mouse (see [“Connecting a mouse” on page 52](#))
- ❖ Connect a full-size keyboard (see [“Connecting a monitor, keyboard and mouse” on page 147](#))
- ❖ Connect an external monitor (see [“Connecting a monitor, keyboard and mouse” on page 147](#))

- ❖ Connect a local printer (see “[Connecting a printer](#)” on page 53)
- ❖ Install PC Cards (see “[Using PC Cards](#)” on page 161)

## Installing additional memory (optional)

Your computer comes with enough memory to run most popular applications. However, you may want to increase the computer’s memory if you use complex software or process large amounts of data.

With additional memory, the computer:

- ❖ Can run more programs and open more documents at the same time
- ❖ Will run your Windows<sup>®</sup> operating system and Windows<sup>®</sup> applications faster

## Installing a memory module

If you are adding memory after you have started to use the computer, begin at step 1. If you have not yet used the computer, skip to step 3.

- 1** If the computer is on, click **Start**, then click **Turn Off Computer**.
- 2** In the Turn Off Computer dialog box, select **Turn Off**.  
The computer turns itself off.
- 3** Remove any cables connected to the computer.
- 4** Close the display panel and turn the computer upside down.
- 5** Using a small Standard #1 Phillips screwdriver, remove the screw that secures the memory slot cover, then remove the cover.





*CAUTION: To avoid damaging the computer's screws, use a small Standard #1 Phillips screwdriver that is in good condition.*

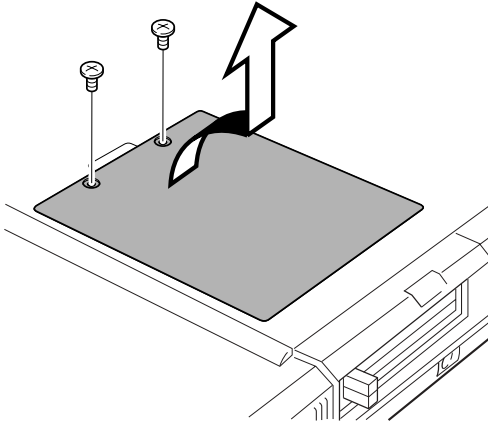

*Removing the memory slot cover*



*CAUTION: Static electricity can damage the memory module. Before you handle the module, touch a grounded metal surface to discharge any static electricity you may have built up.*

*Avoid touching the connectors on the memory module or on the computer. Oil or dust on the connectors can cause memory access problems.*

- 6** Remove the memory module from its antistatic packaging, holding it by its edges.
- 7** Gently slide the module into the socket.

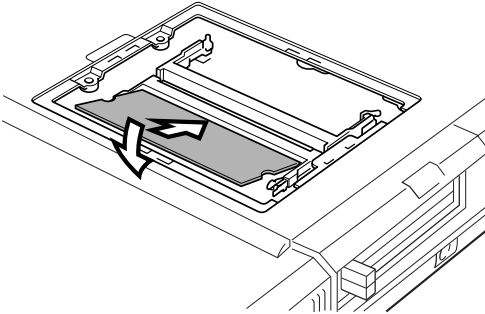

### *Inserting the memory module*

- 8** Push the module down until the latches on either side of the socket engage, securing the module in the socket.
- 9** Position the memory module cover on the computer and secure it with the screw.
- 10** Turn your computer right side up.
- 11** Reconnect any cables you disconnected.
- 12** Turn on the computer.
- 13** Click **Start**, then click **Control Panel** to open the Control Panel.
- 14** Double-click the **System** icon to open the System Properties dialog box.
- 15** Verify that the amount of RAM listed matches the amount of memory currently installed.

## **Removing a memory module**

- 1** Perform steps 1 through 5 in “[Installing a memory module](#)” on page 48, to access the computer’s memory socket.
- 2** Release the memory module by gently pressing outward on the latches on either side of the memory socket.

One edge of the module pops up.

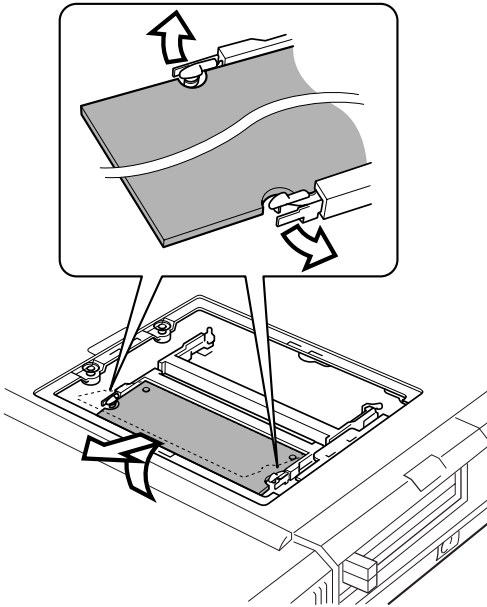

### Removing the memory module

- 3 Remove the memory module from the computer and store it in antistatic packaging.



*CAUTION: Static electricity can damage the memory module. Before you handle the module, touch a grounded metal surface to discharge any static electricity you may have built up.*

*Avoid touching the connectors on the memory module or on the computer. Oil or dust on the connectors can cause memory access problems.*

- 4 Position the memory module cover on the computer and secure it with the screw.
- 5 Turn the computer right side up.
- 6 Reconnect any cables you removed.

## Connecting a mouse

You may want to use a mouse or trackball instead of the computer's built-in TouchPad. Your notebook computer supports USB and PS/2-compatible pointing devices.

The TouchPad® can remain operable, even if you connect a secondary pointing device to the computer. For more information, see [“Toshiba Hardware Setup” on page 172](#).

### Using a USB mouse

- 1 Connect the mouse cable to the USB port.
- 2 Install the vendor supplied software that came with the mouse, if needed.

### Using a PS/2 mouse

The system cannot detect a PS/2 mouse if you connect it after starting the computer.



*NOTE: If you connect a PS/2 mouse to the computer while it is in Standby mode, you will not be able to use the mouse when you turn the computer on.*

---



*CAUTION: When connecting any PS/2 device, turn off your computer to prevent any possible hardware damage.*

---

- 1 Attach the PS/2 mouse cable to the PS/2 port.
- 2 Refer to your mouse documentation for configuration steps.

## Connecting a keyboard

If you prefer to use a full-size keyboard, you can attach one to your computer. The computer's PS/2 port supports any PS/2-compatible keyboard.



*NOTE: If you connect a PS/2 keyboard to the computer while it is in Standby mode, you will not be able to use the keyboard when you turn the computer on.*



*CAUTION: When connecting any PS/2 device, turn off your computer to prevent any possible hardware damage.*

## Connecting a printer



*CAUTION: Connecting the printer cable while the computer is on may damage the printer, the computer, or both.*

Before connecting a printer, you need to know whether it requires a serial or a parallel interface. Check the printer's documentation. If the printer can be switched between serial and parallel mode, choose parallel because it is faster.

You also need a suitable printer cable — which may come with your printer. If not, you can purchase one from a computer or electronics store.



*NOTE: If your printer is ECP- or IEEE-compliant, make sure your printer cable is an IEEE 1284 cable.*

The following instructions assume you have a parallel printer, which is the most common type.

- 1 Connect the printer cable to the printer and to the computer's parallel port.



### *Identifying the ends of a parallel printer cable*

- 2 Plug the printer's power cable into a live AC outlet.

Refer to your printer documentation for additional configuration steps.

## **Connecting the AC adapter**

The AC adapter enables you to power the computer from an AC outlet and to charge the computer's batteries. A status light on the AC adapter glows when the device is in use.

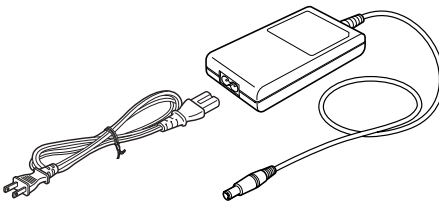

### *AC adapter and power cable*

To connect AC power to the computer:

- 1 Connect the power cable to the AC adapter.
- 2 Plug the AC adapter into the computer's DC-IN jack.

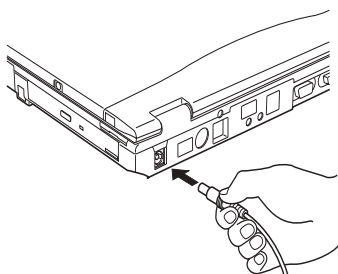

*Connecting the adapter to the computer*

- 3 Connect the power cable to a live AC outlet.



If the battery is being charged, the battery light on the status panel glows amber. Once the battery is fully charged the battery light remains on and glows green.



*DANGER: To avoid electric shock, never modify, forcibly bend, damage, place heavy objects on top of, or apply heat to the power cable. If the power cable becomes damaged or the plug overheats, discontinue use.*

*Never remove the power plug from the outlet with wet hands.*



*CAUTION: Using the wrong AC adapter could damage your computer. Toshiba assumes no liability for any damage in such cases.*

*Never pull directly on the power cable to unplug it. Hold the power plug when removing the cable from the outlet.*

## Charging the battery

Before you can use the battery to power the computer, you must charge it. Connect the computer to a live AC outlet using the AC adapter and power cable. The battery light on the status panel glows amber to show that the battery is charging.

Once the computer is connected to a power outlet, you can charge the battery with the computer turned off or on. It takes several hours to charge the battery with the computer off. It takes much longer to charge the battery while the computer is on. The battery may not charge if several applications are open simultaneously and are using all the computer's resources.

For more information on battery use, see [“Running the computer on battery power”](#) on page 100.



*CAUTION: Once the battery is charged for the first time, avoid leaving the computer plugged in and turned off for more than a few hours at a time. Continuing to charge a fully charged battery can damage the battery.*

---



## Using the computer for the first time

### Opening the display panel

Slide the display latch to the right, then lift the display panel.

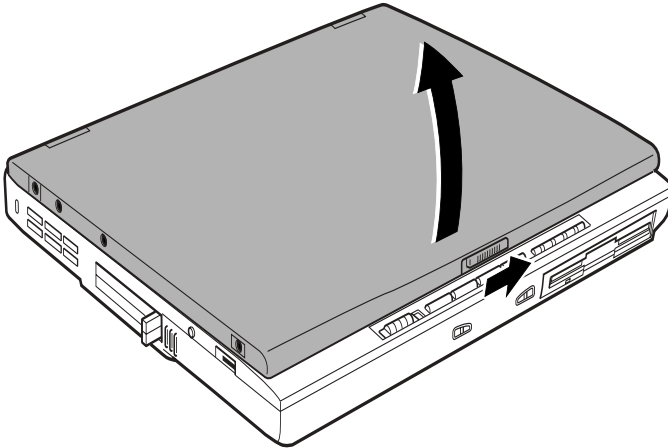

#### *Opening the display panel*



**CAUTION:** Be careful not to force the display panel open beyond the point where it moves easily.

Never lift or move the computer by grasping the display panel.

### Turning on the power

- 1 Make sure the diskette drive is empty.
- 2 If you have a printer connected to your computer, turn the printer on and wait until it indicates that it is ready (on line).
- 3 Press and hold down the power button.

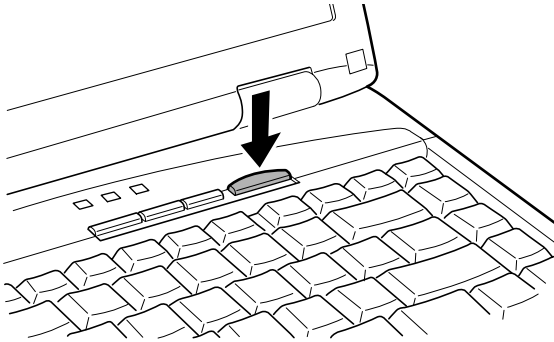

### *Turning on the computer*



The on/off light on the status panel turns on.

- 4 Release the power button.
- 



*NOTE: When turning on the computer for the first time, leave it on until the operating system has loaded completely. Turning off the computer during its initial startup will cause an error the next time you start the computer.*

---



When the computer is connected to an external power source, the battery light glows. If the battery is being charged, the battery light glows amber.



The hard disk drive-access light flashes when the hard disk drive is accessed.

---



*CAUTION: Never turn off the computer while any drives are in use. Doing so may damage the media in use and result in loss of data.*

---

## Using the TouchPad

The TouchPad, the small, smooth square cutout located in front of the keyboard, is sensitive to touch and enables you to move the cursor with the stroke of a finger. Simply move your finger on the TouchPad in the direction you would like to move the cursor.

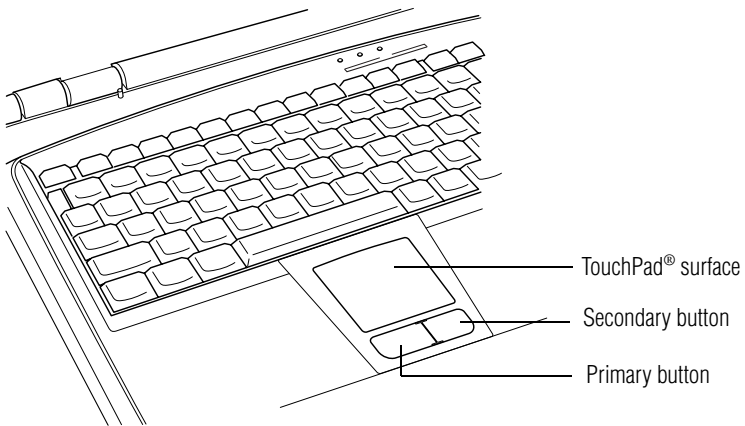

### *TouchPad and control buttons*

- ❖ To move the cursor to the top of the page, push your finger forward on the TouchPad.
- ❖ To move the cursor to the bottom of the page, drag your finger toward yourself.
- ❖ To move the cursor to the right side of the page, slide your finger across the TouchPad from left to right.
- ❖ To move the cursor to the left of the page, slide your finger across the TouchPad from right to left.



*NOTE: Because the TouchPad is much smaller than the display screen, moving your cursor across the screen often means having to move your finger several times across the TouchPad in the desired direction.*

Once you have positioned your cursor, you may either click it in place by double-tapping the TouchPad or clicking the control buttons. For more on the TouchPad and control buttons together, see [“Lesson 2: Using the TouchPad pointing device”](#) on page 114.

## Control buttons

When a step instructs you to click or choose an item, move the cursor to the item, then press and release the primary (left-hand) button. To double-click, press the primary button twice in rapid succession. The primary button usually corresponds to the left mouse button.

The function of the secondary (right-hand) button depends on the program you are using. It usually corresponds to the right mouse button. Check your program’s documentation to find whether it uses the right mouse button.

## Scrolling with the TouchPad®

There are two active regions on the TouchPad which allow you to scroll as you would with any wheel device on a mouse or trackball.

To scroll vertically, run your finger up or down along the right edge of the TouchPad.

To scroll horizontally, run your finger along the bottom edge of the TouchPad.

## Setting up your software

The first time you turn on your computer, the Windows® XP operating system guides you through several essential steps to set up your software. These steps may or may not appear in the following order:

- ❖ Select your time zone.

Select one of the time zones listed by clicking the up and down arrow keys to highlight the appropriate time zone, then click **Next** to change the setting.

- ❖ Confirm acceptance of Microsoft's End User License Agreement and complete information about the operating system.
- ❖ You may be offered the opportunity to register your computer with Toshiba. If not, make sure you register later. For more information, see ["Registering your computer"](#) on page 61.



*NOTE: To register online, your computer's modem must be connected to a voice-grade telephone line, or to a Local Area Network via the LAN port.*

- ❖ Read about Warranty Extensions and Upgrades.  
This step provides important information from Microsoft.
- ❖ Sign up for Internet access.

## Completing installation

Upon completion, you will be prompted to click **Finish** to restart your computer.

## Registering your computer

Registering your computer lets Toshiba keep you up-to-date with information about new products and upgrades, and also extends your Toshiba warranty worldwide at no charge to you.

To register your computer at a later time, select **No, I do not want to register at this time**. A registration icon appears on your desktop as a reminder to register later.



To register your computer, double-click the Registration icon on your desktop and follow the instructions.

Once you have registered your computer, you don't need to register again.

---



*NOTE: If you skip the registration the first time you start your computer, a weekly reminder screen will appear a few times to prompt you to do so.*

---

## Setting up a printer

If you started your computer with a printer connected and turned on, it may have been detected automatically (Plug and Play). If this is not the case, then you must install the printer driver for the model of printer that is connected to your computer. You install the printer driver either by following the instructions indicated in your printer manual, or by using the Windows® XP Add Printer Wizard.

If you plan to set up a printer later, click **Cancel**.

## Using the Add Printer Wizard

To set up a printer with the Add Printer Wizard:

- 1 Click the **Start** button, then click **Control Panel**, and double-click **Printers and Faxes**.

The Printers and Faxes window appears.

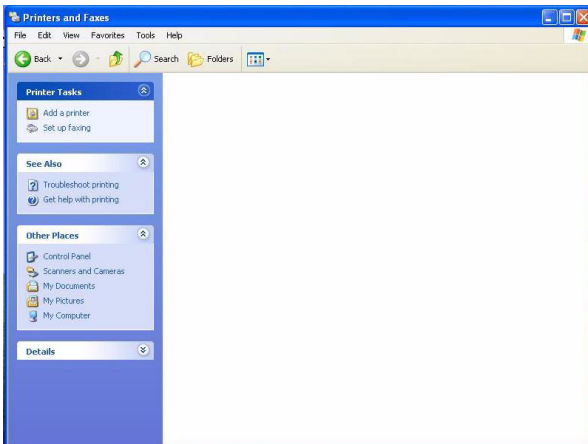

### Sample Printers window

## 2 Click **Add a Printer**.

The Add Printer Wizard starts.



### Add Printer Wizard

**3 Click Next.**

The Add Printer Wizard asks you to select your printer.

---



*TECHNICAL NOTE: If your printer is Plug and Play, Windows® XP recognizes it automatically. You can ignore the remainder of this section. See your printer manual.*

---

**4** If the printer you are setting up:

- ❖ Is not connected to a network, select **Local printer attached to this computer**.
- ❖ Is connected to a network, select **A Network printer, or a printer attached to another computer**.

**5 Click Next.**

The Add Printer Wizard looks for a plug and play printer. If it does not locate one, click **Next** to manually select the printer.

**6** Select the port settings according to the instructions in your printer's documentation and the port to which your printer is connected, then click **Next**.

The Add Printer Wizard prompts you to enter a “friendly” printer name.

**7** From the list of manufacturers and printers, select your printer, then click **Next**.**8** Enter a name for your printer, or accept the default name as it is entered.

*HINT: If you are using more than one printer, make sure the name is descriptive enough to help you tell the difference.*

---

**9 Click Next.**

You are prompted to print a test page.



- 10** If your printer is connected and turned on, click **Yes** to print a test page.

To complete the setup procedure without printing a test page, click **No**, then click **Next**.

- 11** Click **Finish**.

You are now ready to print.

## **Customizing your computer's settings**

There are several ways in which you can customize your computer to suit your particular requirements. Refer to your Windows documentation or online Help for details.

You may also wish to customize your power usage settings. See [“Managing power usage” on page 99](#).

## Turning off the computer

It's a good idea to turn off your computer when you are not using it for a while.

If you are using the computer for the first time, leave the computer plugged into a power source (even though the computer is off) to fully charge the main battery. With the computer off, it may take up to three hours to recharge the main battery.

Guidelines for turning off the computer:

- ❖ If you have work in progress and aren't connected to a network, use the Windows Standby command to save your system settings to memory so that, when you turn on the computer again, you automatically return to where you left off. See [“Standby command” on page 94](#) for more information.



*NOTE: Save your data when you are using Standby mode. If the battery discharges fully, your information will be lost. For more information about Standby mode, see [“Using diskettes” on page 76](#).*

---

- ❖ To leave the computer off for a longer period, use the Windows Turn Off Computer command. Alternatively, use Hibernation to save the system settings to the hard disk. For more information, see [“Powering down the computer” on page 93](#).
- ❖ Never turn off the power while a disk light on the system indicator panel is on. Doing so may damage your hard disk, diskette drive, CD-ROM, DVD-ROM, or DVD-ROM/CD-RW drive.

---

## Caring for your computer

This section gives tips on cleaning and moving your computer. For information about taking care of your computer's battery, see "Running the computer on battery power" on page 100.

### Cleaning the computer

To keep your computer clean, gently wipe the display panel and exterior case with a lightly dampened cloth. Ask your Toshiba dealer for suggestions for appropriate cleaning products.



*CAUTION: Keep liquid, including cleaning fluid, out of the computer's keyboard, speaker grille, and other openings. Never spray cleaner directly onto the computer. Never use harsh or caustic chemical products to clean the computer.*

---

### Moving the computer

Before moving your computer, even across the room, make sure all disk activity has ended and all external peripheral cables are disconnected.



*CAUTION: Never pick up the computer by its display panel or by the back (where the ports are located).*

---

Although your notebook computer is built to withstand reasonable shock and vibration, transport it in a carrying case for long trips. You can purchase a carrying case from your Toshiba dealer or through [toshibaaccessories.com](http://toshibaaccessories.com).

## Using a computer lock

You may want to secure your computer to a heavy object such as your desk. The easiest way to do this is to purchase an optional PORT-Noteworthy® computer lock.



### *PORT-Noteworthy computer lock*

- 1** Loop the cable through or around some part of a heavy object.  
Make sure there is no way for a potential thief to slip the cable off the object.
- 2** Pass the locking end through the loop.
- 3** Insert the cable's locking end into the security lock slot, then rotate the key a quarter turn and remove it.

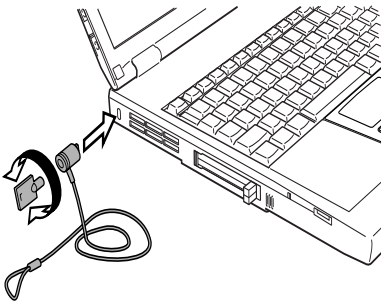

### *Locking the computer*

The computer is now securely locked.

# Chapter 3

## Learning the Basics

---

This chapter lists computing tips that you should follow when using your notebook computer, and provides important information about the computer's basic features.

### Computing tips

- ❖ Save your work frequently.

Your work stays in the computer's temporary memory until you save it to the disk. You will lose all the work done since you last saved, if, for example, a system error occurs and you must restart your computer, or your battery runs out of charge while you are working.



*HINT: Some programs have an automatic save feature which you can turn on. This feature saves your file to the hard disk at preset intervals. See your software documentation for details.*

---

- ❖ Back up your files to diskettes (or other removable media) on a regular basis. Label the backup copies clearly and store them in a safe place.

It is easy to put off backing up because it takes time. However, if your hard disk suddenly fails, you may lose all the data on it unless you have a separate backup copy.

- ❖ Use Error-checking, Disk Defragmenter, and the Maintenance Wizard regularly to conserve disk space and help your computer perform at its optimal level. For more information, see [“Disk drive problems” on page 212](#), or consult your Windows<sup>®</sup> XP operating system documentation for more information on these and other utilities.
- ❖ Take frequent breaks to avoid repetitive-motion injuries and eyestrain.
- ❖ Before turning off the computer, use the Turn Off Computer command from the Start menu.

## Using the keyboard

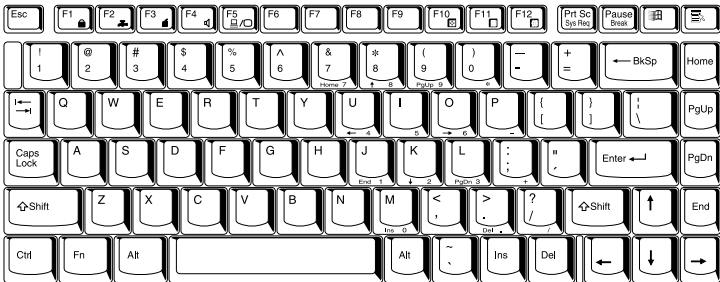

*Keyboard*

## Character keys

Typing with the character keys is very much like typing on a typewriter, except that:

- ❖ The spacebar creates a space character instead of just passing over an area of the page.
  - ❖ The lowercase letter l (el) and the number 1 are not interchangeable.
  - ❖ The uppercase letter O and the number 0 are not interchangeable.
- A** ❖ The Caps Lock key changes only the alphabet keys to upper case — the number and symbol keys are not affected. The caps lock light on the keyboard indicator panel illuminates when you press the Caps Lock key.

## Ctrl, Fn, and Alt keys



### *Ctrl, Fn and Alt keys*

The Ctrl, Fn, and Alt keys do different things depending on the program you are using. For more information, see your program documentation.

## Function keys

The function keys (not to be confused with the Fn key) are the 12 keys at the top of the keyboard.



### *Function keys*

F1 through F12 are called function keys because they perform programmed functions when pressed. Used in combination with the Fn key, function keys marked with icons execute specific functions on the computer. For more information, see “Hot Keys” on page 229.

### Windows® special keys

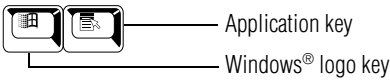

#### *Windows® special keys*

The keyboard provides two keys that have special functions in the Windows® family of operating systems. The Windows® logo key activates the Start menu. The Application key has the same function as the secondary mouse (or TouchPad) button.

### Overlay keys

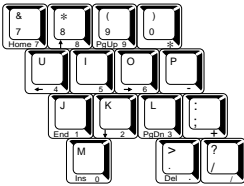

#### *Keyboard overlay keys*

The keys with numbers and symbols on the front of them form the numeric and cursor overlay. This overlay lets you enter numeric data or control the cursor as you would using the ten-key keypad on a desktop computer’s keyboard.

### Using the numeric keypad overlay



To turn the numeric overlay on and off, press Fn and F11 simultaneously. The numeric mode light on the status panel glows when the numeric overlay is on.



You can still use the overlay keys to type alphabetic characters while the numeric overlay is on.

- ❖ For lowercase letters, hold down Fn while you type the letters.
- ❖ For uppercase letters, hold down both Fn and Shift while you type the letters.

To use the cursor control keys when the numeric overlay is on, press and hold down Shift while you use the cursor control keys. To return to the numeric overlay, release Shift.

## Using the cursor control overlay



To turn the cursor control overlay on and off, press Fn and F10 simultaneously. The cursor control mode light on the keyboard indicator panel glows when the cursor control overlay is on.

To type alphabetic characters while the overlay is on:

- ❖ For lowercase letters, hold down Fn while you type the letters.
- ❖ For uppercase letters, hold down both Fn and Shift while you type the letters.

To use the numeric overlay keys when the cursor control overlay is on, hold down Shift while you use the numeric overlay keys. To return to the cursor control overlay, release Shift.

## Starting a program

The easiest way to start a program is to double-click the name of the file that contains the information you want to work on. To find the file, use My Computer or Windows Explorer.

If you prefer to open the program first, you have four options. You can:

- ❖ Double-click the icon for the program on your desktop
- ❖ Use the Start menu

- ❖ Use Windows Explorer or My Computer to locate the program file
- ❖ Use the Run dialog box

The Windows<sup>®</sup> XP tutorial chapter gives step-by-step instructions for starting a program from the Start menu. See “[Lesson 6: Starting programs](#)” on page 120.

## Saving your work

Before you turn off the computer, save your work to the hard disk drive or a diskette. This is one of the most important rules of computing. You can never save your files too often.



*NOTE: Save your data even when you are using Standby mode, in case the battery discharges before you return to work. For more information about Standby and Hibernation, see “[Powering down the computer](#)” on page 93.*

---

Many programs offer a feature that saves documents at regular intervals, such as every 15 minutes. Check your program’s documentation to see whether it has an automatic save feature.

- ❖ To save a file you are updating, open the program’s **File** menu and click **Save**.
- ❖ To save the current file with a new name, choose **Save As** from the File menu, type a name for the file and click **OK**.



*HINT: To make another copy of the file you are currently working with, choose Save As from the File menu and give the new file a different name.*

---

---

## File names

Windows<sup>®</sup> XP supports file names of up to 255 characters. You may use all the letters and numbers on the keyboard plus the following characters: `_`, `^`, `$`, `~`, `!`, `#`, `%`, `&`, `{`, `}`, `(`, `)`, `@`, `[`, `]`, `+`, `-`, `;`, and `'`. The names can include spaces.

## Printing your work

Make sure that the operating system is set up for your printer as described in [“Connecting a printer” on page 53](#).



*TECHNICAL NOTE: You only need to set up the printer the first time you connect it. If you use more than one printer or are changing printers, you will need to set up the Windows<sup>®</sup> XP operating system to run with the additional printer(s).*

---

- 1 If your printer is not on, turn it on now.
- 2 In the File menu of your Windows program, click **Print**.

The program displays a Print dialog box.

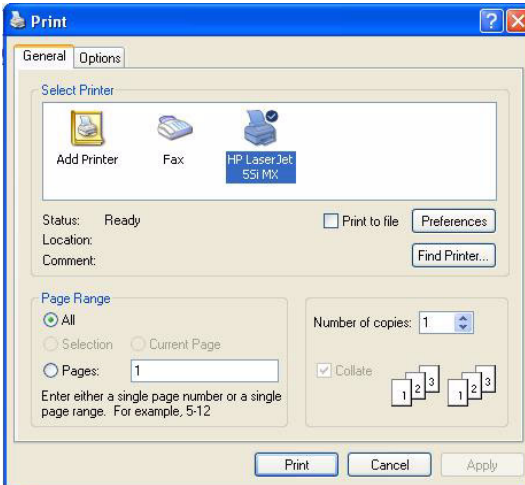

*A sample Print dialog box*

- 3 Click **Print** to print.

## Using diskettes

The 3.5-inch diskette drive lets you use either double-density (720 KB) or high-density (1.44 MB) diskettes for data transfer and storage.

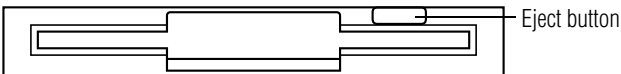

*Diskette drive*

## Inserting and removing diskettes

- 1 Hold the diskette so that the arrow on its upper surface points toward the drive.
- 2 Push the diskette gently into the drive slot. When the diskette is in place, the eject button pops out.

To release a diskette from the drive, push the eject button.

## Caring for diskettes

- ❖ Store your diskettes properly to protect and keep them clean.
- ❖ If a diskette is dirty, clean it with a soft cloth moistened with water. Do *not* use cleaning fluids.
- ❖ Never slide back the protective metal cover.
- ❖ Never touch the magnetic surface of a diskette. Fingerprints can prevent the drive from reading the data stored on a diskette.
- ❖ Never twist or bend a diskette.
- ❖ Keep diskettes at room temperature and avoid exposing them to direct sunlight, otherwise data may be lost.
- ❖ Never place heavy objects on your diskettes.
- ❖ Never eat, smoke, or use erasers near your diskettes. Foreign particles can damage the diskette's surface.
- ❖ Keep your diskettes away from sources of magnetism, such as speakers and radios; these can destroy data.

## Backing up your files

Backing up your files simply means copying individual files to a diskette or copying entire sections of your hard disk to another device, such as a tape drive.

## Copying to a diskette

- 1 Insert a diskette into the diskette drive.
- 2 Double-click the **My Computer** icon on the Windows desktop.
- 3 Double-click the drive that contains the file you want to copy.

- 4 Double-click the folder containing the file, then click the file you want to copy.
- 



*HINT: Use the Ctrl or Shift key to select more than one file.*

---

- 5 Click **File**, then point to **Send To**.
  - 6 Click the icon for the diskette drive (3.5" Floppy A:).
- 



*HINT: You can also back up a file to a diskette by clicking the file (or files) you want to back up with the secondary button, then pointing to Send To and clicking 3.5" Floppy (A:).*

---

## Using your CD or DVD drive

Your computer may have a CD-ROM drive, DVD-ROM drive, or a DVD-ROM/CD-RW multifunction drive. CD-ROM drives can play back prerecorded CDs. DVD-ROM drives can play back both prerecorded CDs and DVDs. With a CD-RW drive you can write files (including music) to a CD-Recordable (CD-R) or CD-Rewritable (CD-RW) disc. A DVD-ROM/CD-RW multifunction drive can do all of these things.

Compact discs (CDs) store up to 600 MB of data or music. You use CD-ROMs to load and run software, and to access reference material such as catalogs, as well as listen to music.

A special feature allows you to play audio CDs even when the computer is turned off.

Digital versatile discs (DVDs) provide a significant increase in data storage and support features that are not available on any other video platform. These features include wide-screen movies, multiple language tracks, digital surround sound, multiple camera

angles, and interactive menus. The computer can play high-resolution video at up to 30 frames per second.



*NOTE: For optimum DVD performance, Toshiba recommends that you play DVDs while running on AC power rather than on battery power.*

## Drive components and control buttons

The CD/DVD control buttons are located on the front of the computer so that you can access them whether the display panel is closed or open. For more information about the front panel controls, see “Front panel controls” on page 37.

### DVD-ROM drive components

If you have a DVD-ROM drive, it may look like this:

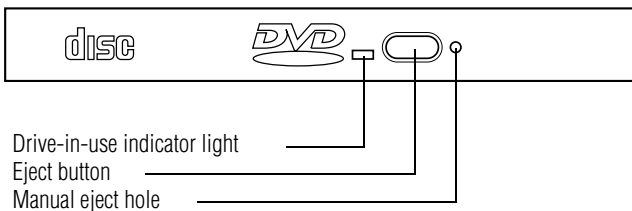

#### *Sample DVD-ROM drive*

Even if your drive looks slightly different, you should be able to identify the drive-in-use light that glows when the system is accessing the CD or DVD, the eject button used to release the disc tray, and a manual eject hole for releasing the disc tray when the computer’s power is turned off.



*CAUTION: Never press the eject button or turn off the computer while any drives are in use. doing so may damage the media in use and result in loss of data.*

The eject button requires power to operate. The manual eject button does not require power.

---



*CAUTION: Never use a pencil to press the DVD-ROM manual eject button. Pencil lead can break off inside the computer and damage it. Instead, use a slim object such as a straightened paper clip.*

---

The vent, located at the lower side of the drive, cools the DVD-ROM drive's internal mechanisms. Do not block this vent.

---



*HINT: When the computer is off and the DVD-ROM drive is on, press the stop/eject control button on the top of the computer to eject a disc.*

---

## Inserting a disc

---



*WARNING: Before playing an audio CD or DVD, turn the volume down. Playing the disc at maximum volume could damage your ears. To turn the volume down, use the Volume Control program (click Start, point to All Programs, Accessories, Entertainment, and click Volume Control) or Volume Control dial.*

---



*CAUTION: When inserting and removing discs, be careful not to touch the lens on the disc tray or the area around it. Doing so could cause the drive to malfunction.*

---

- 1** If the computer is turned on, press the eject button.



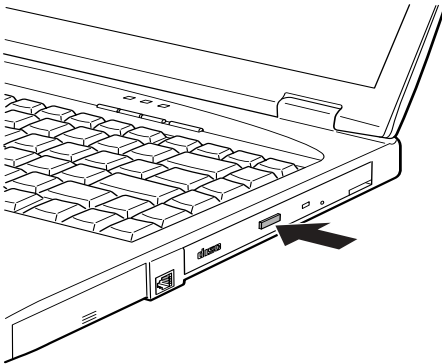

*Pressing the disc eject button*

If the computer is off, either:

- ❖ Slide the CD/DVD/Media Player power switch to the left to turn the drive on, and press the stop/eject button twice to release the disc tray.
- ❖ Press the manual eject button on the drive, accessed through the small hole just to the right of the eject button. For instructions, see [“Removing a disc with the computer off”](#) on page 86.

The disc tray partially opens.

- 2 Pull the disc tray until it is fully open.

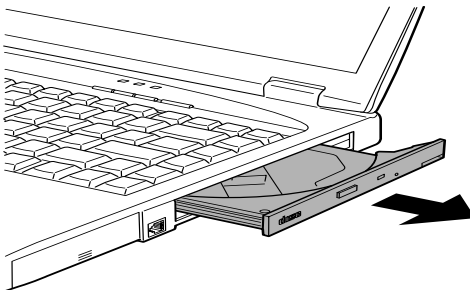

*Opening the disc tray*

- 3 Hold the disc by its edges, ensure it is dust-free, and place it carefully in the disc tray, with the label side up.

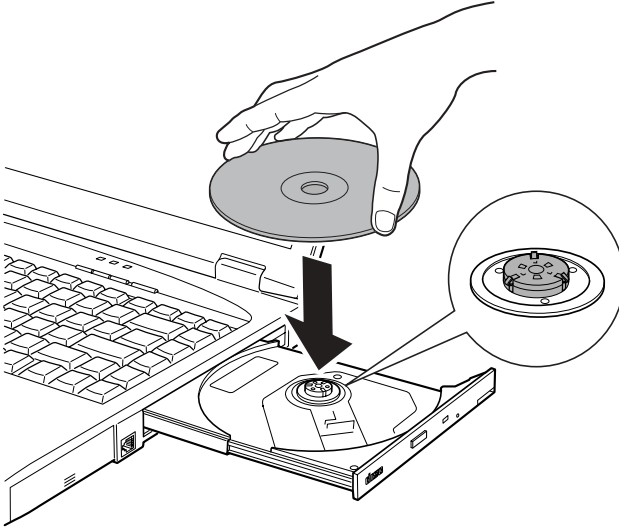

*Inserting a disc into the drive tray*



*CAUTION: Handle discs carefully. Avoid touching the surface of the disc. Grasp it by its center hole and edge. If you handle the disc incorrectly, you could lose data.*

---

- 4 Gently press the center of the disc onto the spindle until it locks into place.



*CAUTION: Make sure the disc is properly positioned on the spindle. If you position the disc incorrectly, it can jam the disc tray.*

---

- 5 Close the disc tray by pressing gently on the center of the tray until it clicks, indicating that it is locked.

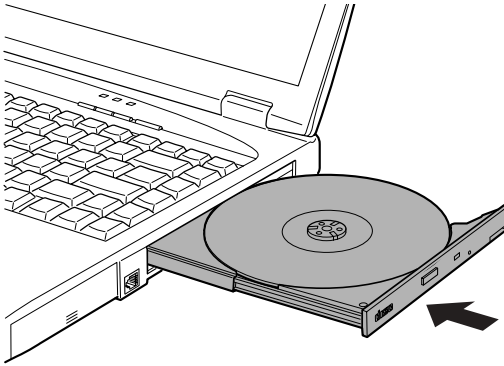

*Closing the disc tray*

## Viewing the contents of a CD or DVD

CDs and DVDs contain files just like diskettes and the hard disk. CD-ROMs are often used to install software or to store files that require lots of space, such as photographs and large presentation files. You can use Explorer or My Computer to view the contents of any CD or DVD. To view the contents of a CD or DVD using My Computer:

- 1 Place the disc in the CD-ROM, DVD-ROM, or DVD-ROM/CD-RW drive.
- 2 Double-click **My Computer** on your desktop to open the My Computer window.
- 3 Locate the folder that contains the CD or DVD icon and title.
- 4 Click the icon.

If you click the icon without having the CD or DVD in the drive, the operating system prompts you to insert the disc.

## Playing an audio CD

---



*WARNING: Before playing an audio CD or DVD, turn the volume down. Playing the disc at maximum volume could damage your ears. To turn the volume down, use the Volume Control program (click Start, point to All Programs, Accessories, Entertainment, and click Volume Control) or Volume Control dial.*

---

To play an audio CD, insert the CD and close the disc tray.

If the computer is off, the drive starts up and begins playing the first audio track.

Slide the CD/DVD/Media Player power switch to the right to enable the front panel control buttons. When playing an audio CD, these buttons have the following functions:



To stop or eject the CD, press the **stop/eject** button.



To play or pause the CD, press the **play/pause** button.



To return to the beginning of the preceding track on the disc, press the **previous track** button.



To go to the beginning of the following track on the disc, press the **next track** button.



The **speaker volume control** adjusts the level of sound from the stereo speakers.

If the computer is on, the Windows Media™ Player window opens, and the CD begins to play. You can use either the front panel control buttons on your computer or the Windows Media™ Player buttons to control the CD.

You can manually open Windows Media™ Player from the Start menu or the taskbar.

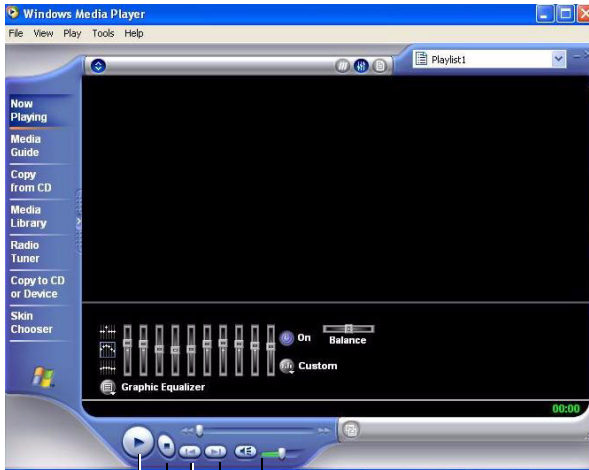

Play/Pause  
Stop  
Previous track  
Next track  
Volume Control

### *Sample Windows Media Player window*

The Windows Media™ Player control panel works much like an ordinary compact disc player:

- ❖ To play the CD or to pause, click the **Play/pause** button on the CD Player control panel.
- ❖ To return to the beginning of the preceding track on the disc, click the **previous track** button.
- ❖ To go to the beginning of the following track on the disc, click the **next track** button.
- ❖ To stop the CD, click the **Stop** button.
- ❖ To adjust the volume, click and drag the volume slider bar until the desired sound level is reached.

## Playing a DVD

This manual has a separate chapter on using the WinDVD™ software application for playing DVDs. For information, see “WinDVD 2000” on page 175.

## Removing a disc

### Removing a disc with the computer on

- 1 Press the eject button.



*CAUTION: Never press the eject button while the computer is accessing the CD-ROM/DVD-ROM drive.*

*If the disc is still spinning when you open the disc tray, wait for it to stop before you remove it.*

---

- 2 Pull the disc tray until it is fully open, remove the disc, and place it in its protective cover.
- 3 Close the disc tray.

### Removing a disc with the computer off

- 1 Insert a slender object, such as a straightened paper clip, into the manual eject button hole.



*CAUTION: Never use a pencil to press the manual eject button. Pencil lead can break off inside the computer and damage it.*

---

- 2 Pull the disc tray until it is fully open, remove the disc, and place it in its protective cover.
- 3 Close the disc tray.

## Caring for CDs and DVDs

- ❖ Store your discs in their original containers to protect them from scratches and keep them clean.
- ❖ Never bend a disc or place heavy objects on top of it.
- ❖ Never apply a label to, or otherwise mar, the surface of a disc.
- ❖ Hold a disc by its outside edge. Fingerprints on the surface of a disc can prevent the CD-ROM drive or DVD-ROM drive from reading the data properly.
- ❖ Avoid exposing discs to direct sunlight or extreme heat or cold.
- ❖ To clean a disc, wipe it with a clean, dry cloth — starting from the center of the disc and wiping toward the outward edge. Avoid wiping using a circular motion. If necessary, moisten the cloth with water or a neutral cleaner (not benzine or rubbing alcohol). Let the disc dry completely before inserting it in the drive.

## Setting up for communications

To connect to the Internet, use an online service, or communicate across the telephone lines with another computer, you need:

- ❖ The computer's modem
- ❖ A telephone line
- ❖ A browser or communications program
- ❖ An Internet Service Provider (ISP) or online service if you plan to use the Internet

## Using the modem

Before you can use the modem, you must connect it to a standard voice-grade telephone line with an RJ11 jack.



*NOTE: It is recommended that you do not use the infrared port at the same time as either playing audio or connecting to the internet via a modem. Audio quality may be reduced and the modem connection may be slower or disrupted.*



*TECHNICAL NOTE: Disable Call Waiting before you connect through the modem. Call Waiting interrupts data transmission.*



- 1 Attach one end of a standard telephone cable to the computer's modem port.

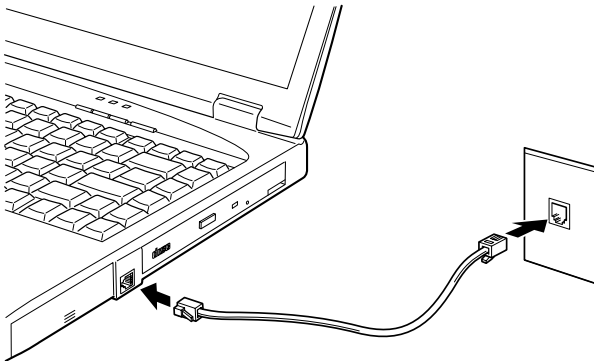

*Connecting the modem*



- 2 Attach the other end of the telephone cable to the modular jack of a standard voice-grade telephone line.



*CAUTION: Never connect the modem to a digital telephone line. A digital line will damage the modem.*

## Using the LAN

If your system has an integrated 10/100 Ethernet LAN port, you can have your network administrator configure your computer for the network and supply you an available network connection point.



- 1 Attach one end of a standard LAN cable to the computer's RJ45 LAN port.

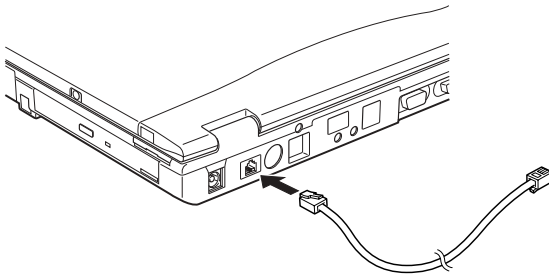

### *Connecting the network port*

- 2 Attach the other end of the LAN cable to your network connection point.

## Using a wireless connection

---



*NOTE: Using this functionality requires an optional Wi-Fi™ module.*

*If you do not have a Wi-Fi™ module installed, you will need to connect using a PC Card device.*

---

For information on how to set up a wireless connection, refer to your wireless networking device documentation or your network administrator.

## Connecting your computer to a network

You can connect your computer to a network locally or remotely.

- ❖ Locally, using the built-in 10/100 Ethernet LAN adapter by connecting it to a standard RJ45 LAN line, or by using the optional Wi-Fi module. For more information about wireless networking, refer to your network administrator.
- ❖ Remotely, using the built-in modem and a dial-up connection. For specific information about connecting to the local area network (LAN) or wide area network (WAN), consult your network administrator.

## Setting up a modem connection

---



*NOTE: It is recommended that you do not use the infrared port at the same time as either playing audio or connecting to the internet via a modem. Audio quality may be reduced and the modem connection may be slower or disrupted.*

---

To use a dial-up connection, have your network administrator configure your computer for the network and supply you with the

telephone number. To set up the network connection, use the Remote Desktop Connection command:

- 1 Click **Start** and point to **All Programs**.
- 2 Point to **Accessories**, then to **Communications**, and click **Remote Desktop Connection**.
- 3 Enter the phone number of your network connection and click **Connect**.

The computer connects with the network.

## Using the Ethernet LAN port

If your computer has an integrated 10/100 Ethernet LAN port, the operating system attempts to contact a Dynamic Host Configuration Protocol (DHCP) server when it starts. If the computer is not connected to a network, it may pause a few minutes as it waits for a reply. To avoid this delay, you can reconfigure Windows to disable the LAN port.

To disable the LAN port:

- 1 Click **Start**, then click **Control Panel**.
- 2 Double-click the **System** icon, click the **Hardware** tab, and then click the **Device Manager** button.
- 3 Select **Intel® Pro/100 VE Network Connection in Network Adapters**.
- 4 Click the **Properties** icon on the toolbar.
- 5 Choose the **Do not use this device (disable)** option from the **Device usage** drop-down.
- 6 Click **OK**.

Your LAN port is now disabled.

To enable the LAN port:

- 1 Click **Start**, and then click **Control Panel**.

- 2 Double-click the System icon, click the **Hardware** tab, and then click the **Device Manager** button.
- 3 Select **Intel® Pro/100 VE Network Connection in Network Adapters**.
- 4 Click the **Properties** icon on the toolbar.
- 5 Choose the **Use this device (enable)** check box.
- 6 Click **OK**.

Your LAN port is now enabled.

## Accessing the Wi-Fi™ Mini PCI Module

Your computer may come with an integrated Wi-Fi™ Mini PCI Module. When using it, your computer may display a PC Card icon in the desktop's system tray to indicate that it is in use. Do not confuse the system tray's icon with other removable PC Card devices you may have installed.

You *can* use the system tray's PC Card icon to turn off your Wi-Fi Mini PCI module. However, you will need to restart your computer to turn it back on.

If your Wi-Fi Mini PCI module is integrated into your computer system, Toshiba recommends that you do not remove the module from your computer. For assistance, contact a Toshiba Wireless Authorized Service Partner.

## Powering down the computer

When you power down the computer, you have three options to choose from: Turn Off Computer, Hibernation and Standby. Each option has its advantages.

### Turn off computer command

The Turn off computer command shuts the computer down completely. When you start up again, the computer runs a self-test and loads the operating system. You must open any programs and files you want to use.

Factors to consider when choosing Turn off computer:

- ❖ No power is used while the computer is shut down. This is the most efficient mode if you will be away from your computer for an extended time.
- ❖ Restarting from Shut down uses the most time and battery power.
- ❖ When starting up again, the system does not automatically open programs and files you were previously using.

### Hibernation command

Hibernation shuts the computer down completely, but it first saves the current state of the computer to the hard disk. Since Hibernation does not require power to maintain the saved information, the system settings are retained indefinitely. Restoring information from the hard drive takes longer than restoring it from memory. When you start up again, the computer runs a self-test, loads the operating system, and then returns to the state in which you left it.

Factors to consider when choosing Hibernation:

- ❖ While in Hibernation, the computer uses no battery power.

- ❖ Because the state of the system is held on the hard disk, no data is lost if the battery discharges.
- ❖ Restarting from Hibernation uses less time and battery power than restarting from Shut down.
- ❖ Restarting from Hibernation uses a little more time and battery power than restarting from Standby because information is being retrieved from the hard disk instead of memory.
- ❖ When starting up again, the computer returns to the state in which you left it and opens the programs and files you were using.

## **Standby command**

The Standby command puts the computer into a power-saving mode. Standby holds the current state of the computer in memory so that, when you restart the computer, you can continue working from where you left off.

Factors to consider when choosing Standby:

- ❖ While in Standby mode, the computer uses some battery power. A fully charged battery will last approximately eight hours in Standby mode.
- ❖ Restarting from Standby mode uses less time and battery power than restarting from Shut down or Hibernation.

- ❖ When starting up again, the computer returns to the state in which you left it and opens the programs and files you were using.



*NOTE: If you power down using the Standby command and the battery discharges fully, your information will be lost. Be sure to save your work first.*



*TECHNICAL NOTE: Before using any of these methods to power down your computer, save your files and make sure the drive-in-use light is off.*

*If you change your mind and decide to continue working after all, wait a few seconds before turning the computer on again.*

## Using the Turn Off Computer command

To power down the computer using the Turn off computer command, click **Start**, **Turn Off Computer**, then click **Turn Off**.



*Sample Shut Down Windows dialog box*

The computer turns itself off.

## Shutting down more quickly

You can also shut down the computer by pressing the power button or closing the display panel.

To use either of these methods, you first need to turn on the feature in the Power Saver utility.



- 1 Open the **Start** menu, then click **Control Panel**.
- 2 In the Control Panel window, double-click the **Toshiba Power Saver** icon.

The Power Saver Properties dialog box appears.

- 3 Click the **Details** button, then the **System Power Mode** tab, and select the options you want from the drop-down lists.
  - ❖ **When I close the lid**  
Set this option to **Power Off** to have the computer shut down when you close the display panel.
  - ❖ **When I press the power button**  
Set this option to **Power Off** to have the computer shut down when you press the power button.
- 4 Click **Apply**.
- 5 Click **OK**, then close the Control Panel.

## Starting again after Shut down

To start the computer up again, press and release the power button. The on/off light changes to green.

## Using Hibernation

If you have enabled Hibernation on the Toshiba Power Saver Properties dialog, you can power down the computer using the Hibernation option as follows:

- 1 Click **Start**, then **Turn Off Computer**.



- 2 Hold down the Shift key and click **Hibernation**.



*Sample Shut Down Windows dialog box*

The computer saves the state of the system, including all open programs and files, to the hard disk, and then turns itself off.

## Going into Hibernation more quickly

You can also put the computer into Hibernation by pressing the power button or closing the display panel.

To use either of these methods, you first need to turn on the feature in the Power Saver utility.



- 1 Open the **Start** menu, then click **Control Panel**.
- 2 In the Control Panel window, double-click the **Toshiba Power Saver** icon.
- 3 Click the **Hibernate** tab, and then click the **Enable hibernate support** checkbox.
- 4 Click **Apply**.
- 5 Click **OK**, then close the Control Panel.

## Starting again from Hibernation

To start the computer from Hibernation, press the power button. The computer returns to the screen you were using.

## Using Standby

To power down the computer using the Standby command, click **Start, Turn Off Computer**, then select **Stand by**.

The computer saves the status of all open programs and files to memory, turns off the display, and goes into a low-power mode. The on/off light blinks amber to indicate the machine is in Standby mode.

### Going into Standby more quickly

You can also put the computer into Standby by either pressing the power button or closing the display panel.

To use either of these methods, you first need to enable the feature in the Power Saver utility.

- 1 Open the **Start** menu, then click **Control Panel**.
- 2 In the Control Panel window, double-click the **Toshiba Power Saver** icon.



The Power Saver Properties dialog box appears.

- 3 Click the **Details** button, then the **System Power Mode** tab, and select the options you want from the drop-down lists.
- 4 Click **Apply**.
- 5 Click **OK**, then close the Control Panel.

### Starting again from Standby

To start the computer from Standby, press the power button. The computer returns to the screen you were using.

If you put the computer in Standby by closing the display panel, you can start it again by opening the display panel.

# Chapter 4

## Mobile Computing

---

This chapter covers all aspects of using your computer while traveling.

### Toshiba's energy-saver design

Your computer enters a low-power mode when it is not being used, thereby conserving energy and saving money in the process. It has a number of other features that enhance its energy efficiency.

Many of these energy-saving features have been set by Toshiba. We recommend you leave these features active, allowing your computer to operate at its maximum energy efficiency, so that you can use it for longer periods while traveling.

### Managing power usage

Your computer's power-saving options greatly increase the length of time you can use the computer before recharging the battery.



To change the Power usage mode, click **Start**, then click **Control Panel**. In the Control Panel, double-click the **Toshiba Power Saver** icon to display the Power Saver Properties window.

Click the **Details** button, then the **Power Save Mode** tab. Select the power scheme with the most appropriate settings for your computer. Keep in mind that changing any settings on the Power Saver Properties window will modify the currently selected scheme. For more information, see [“Toshiba Power Saver” on page 174](#).

## Running the computer on battery power

The computer contains a removable lithium ion (Li-ion) battery pack that provides power when you are away from an AC outlet. You can recharge it many times.

In addition to the removable main battery, the computer has an internal real-time clock (RTC) battery. The RTC battery powers the RTC memory, which stores your system configuration settings and the current time and date for up to a month while the computer is turned off.

## Using additional battery packs

If you spend a lot of time traveling and need to work for many hours without an AC power source, you may want to carry additional charged battery packs with you. You can then replace a discharged battery and continue working.

## Battery safety precautions

- ❖ Never try to disassemble a battery pack.
- ❖ Never overcharge or reverse charge a battery. Overcharging will shorten its life and reverse charging could destroy it, causing the release of toxic fumes.
- ❖ Avoid touching the metal terminals of the battery with another metal object. Short-circuiting the battery will cause it to overheat and may cause permanent damage to the battery or the computer.

- ❖ Never incinerate a spent battery as this will cause it to explode and release toxic materials.
- ❖ If a battery is leaking or damaged, replace it immediately. Use protective gloves when handling a damaged battery.
- ❖ To replace the main battery, use an identical battery that you can purchase through [www.toshibaaccessories.com](http://www.toshibaaccessories.com).

## Maximizing battery life

A main battery can be recharged many times. Gradually over time it will lose its ability to hold a charge. To maximize the life of your main battery:

- ❖ Avoid leaving the computer plugged in and unused for more than a few hours. Overcharging the main battery may shorten its life.
- ❖ If you are not going to use the computer for a long period of time, remove the battery.
- ❖ Alternate between battery packs if you have a spare.
- ❖ Make sure the computer is off when you are replacing the battery.
- ❖ Store spare battery packs in a cool dry place out of direct sunlight.



*TECHNICAL NOTE: Battery life and charge time may vary, depending on applications, power-management settings, and features used.*

## Charging batteries

The main battery needs to be charged before you can use it to power the computer.

## Charging the main battery

To charge the main battery, plug the computer into a live AC outlet.



The **battery light** glows amber while the battery is being charged.

It takes two to three hours to charge the battery with the computer off. It takes much longer to charge the battery while the computer is on.



*TECHNICAL NOTE: The battery does not charge while the computer is consuming full power.*

---

The battery may not start charging immediately if:

- ❖ The battery is extremely hot or cold.

To ensure that the battery charges to its full capacity, wait until it reaches room temperature (50 to 80 degrees Fahrenheit, 10 to 26 degrees Celsius).

- ❖ The battery is almost completely discharged.

Leave the power connected, and the battery should begin charging after a few minutes.



*HINT: Once a battery pack is fully charged, we recommend that you operate your computer on battery power until the battery pack discharges completely. Doing this extends battery life and helps ensure accurate monitoring of battery capacity.*

---

## Charging the RTC battery

During normal use, the main battery keeps the RTC battery adequately charged. Occasionally, the RTC battery may lose its

charge completely, especially if you have had the computer turned off for a long time.

If the RTC battery is low, the real-time clock and calendar may display the incorrect time and date, or stop working.

To recharge the RTC battery, plug in the computer and leave it turned off for at least 24 hours.

## Monitoring battery power

- ☐ The battery light indicates the main battery's current charge. It
  - ❖ Glows green when the battery is fully charged.
  - ❖ Glows amber while the battery is being charged.
  - ❖ Flashes amber when the charge reaches the critical battery level.
  - ❖ Does not glow if the external power source is disconnected or if the battery is completely discharged.

## Determining remaining battery power



*NOTE: Wait at least 16 seconds after turning on the computer before trying to monitor the remaining power. The computer needs this time to check the battery's remaining capacity and perform calculations.*



- 1 Click **Start**, and then click **Control Panel**.
- 2 Double-click the **Toshiba Power Saver** icon.
- 3 The **Power Save Modes** tab shows the current charge state of the battery.



*TECHNICAL NOTE: The computer drains the battery faster at low temperatures. Check your remaining charge frequently if you are working in temperatures below 50 degrees Fahrenheit.*

*The computer calculates the remaining battery charge based on your current rate of power use and other factors such as the age of the battery.*

## Conserving battery power

How long a fully charged battery pack lasts when you are using the computer depends on a number of factors, such as:

- ❖ How the computer is configured
- ❖ How much you use the display panel instead of an external monitor
- ❖ How much you use the hard disk and other drives
- ❖ Whether you use any optional devices to which the battery supplies power, such as a PC Card
- ❖ Where you are working — since operating time decreases at low temperatures

## What to do when the battery runs low

When the battery runs low you have these options:

- ❖ Plug the computer into a live AC outlet and recharge the battery.
- ❖ Replace the battery with a charged spare, if you have one (see [“Changing the main battery” on page 105](#)).
- ❖ Save your work and turn off the computer.

If you don't manage to do any of these things before the battery completely runs out of power, the computer automatically enters



Standby mode and turns itself off. Standby mode keeps track of where you were so, when you turn on the power again, you can continue where you left off. For more information, see [“Standby command” on page 94](#).

## Battery alarms

The computer can be configured to warn you when the battery is running low. You can set each of the following alarms to alert you when a specified percentage of remaining battery power has been reached:

- ❖ Low Battery
- ❖ Critical Battery

You can set how the warning occurs — by sounding an alarm, displaying a message, both, or none. You can also set the computer to enter Standby mode when the alarm goes off.

To set the alarm levels:



- 1 Click **Start**, and then click **Control Panel**.
- 2 Double-click the **Toshiba Power Saver** icon.  
The Power Options Properties dialog box appears.
- 3 Click the **Alarms** tab.
- 4 Set the alarm levels as desired.

For more information on battery alarms, refer to your Windows<sup>®</sup> XP documentation.

## Changing the main battery

When your battery runs out of power, you have two options — connect the AC adapter, or install a fresh battery. For instructions on using the AC adapter, see [“Connecting the AC adapter” on page 54](#).

## Removing the battery

- 1 Save your work.
- 2 Shut down the computer.



*CAUTION: Never remove the battery while the computer is on.*

- 3 Close the display panel, ensuring that it snaps into place.
- 4 Turn the computer upside down with the front of the computer facing you.
- 5 Slide the battery release latch as shown in the illustration.

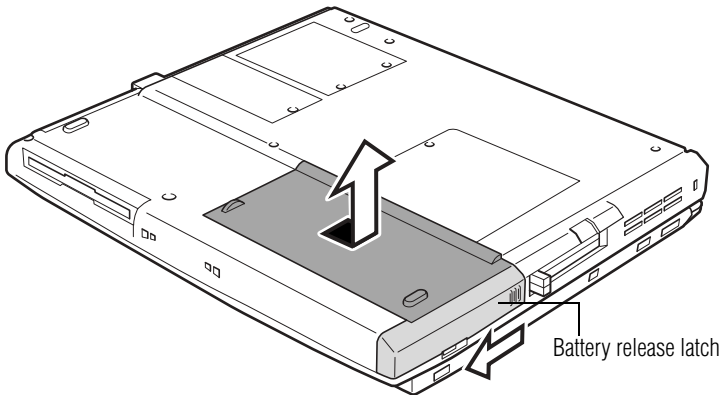

### *Releasing the battery latch*

- 6 Gently pull the battery out of the battery bay.



*WARNING: If the battery is leaking or its case is cracked, put on protective gloves to handle it, and discard it immediately following the advice in "Disposing of used batteries safely" on page 107.*

## Inserting a charged battery

- 1 Wipe the terminals of the charged battery with a clean cloth to ensure a good connection.
- 2 Slide the battery into the battery bay.  
You'll know the battery is properly seated when you hear it click into place.
- 3 Slide the battery release latch as shown in the illustration.

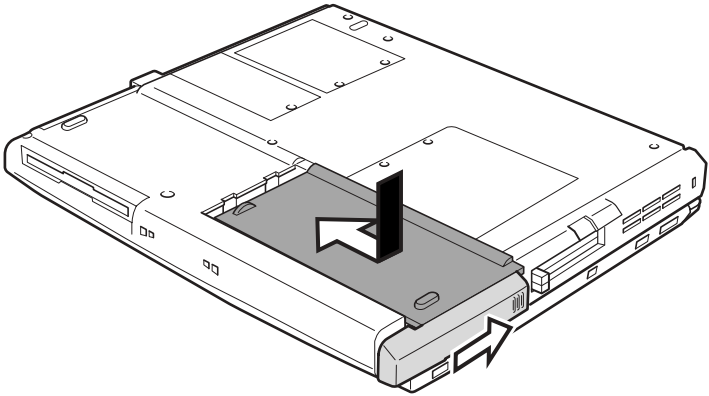

### *Inserting the battery*

- 4 Turn the computer right side up.

## Disposing of used batteries safely

You can recharge a main battery many times, so it should last for years. When the useful life of the battery expires or if the battery becomes damaged, you must discard it responsibly.

The documentation that came with your computer may include an insert regarding the disposal of batteries. If not, check with your local government for information on where to recycle or dispose of old batteries.

Only use replacement batteries recommended by Toshiba.

---



*CAUTION: The computer uses a lithium ion battery, which can explode if not handled or disposed of properly. Putting spent batteries in the trash is not only irresponsible, it may also be illegal. Dispose of the battery as required by local ordinances or regulations.*

---

## Traveling tips

The environmental precautions listed in “[Selecting a place to work](#)” on page 41, also apply while traveling.

- ❖ Never leave your computer on a sunny ledge or in a place where it could get wet or covered in dust.
- ❖ Always travel with the computer in a carrying case. Toshiba offers a choice of carrying cases for the computer. They all provide plenty of extra space for manuals, power cables, compact discs and diskettes. For more information, see the accessories information packaged with your computer, or visit [toshibaaccessories.com](http://toshibaaccessories.com).



*TECHNICAL NOTE: When traveling by air, you may be required to pass your notebook through airport security equipment. The X-ray equipment will not harm your computer.*

---

# Chapter 5

## Getting to Know Windows<sup>®</sup> XP

---

This chapter introduces the Windows<sup>®</sup> XP operating system by guiding you through a few basic tasks.

If you have used the Windows<sup>®</sup> 2000 operating system, you will find that the Windows<sup>®</sup> XP operating system works in similar ways. Whether you have used a Windows<sup>®</sup> operating system or not, the skill and confidence you will gain from this chapter will more than offset the short amount of time spent going through these lessons.

As you explore your computer's operating system further, you will often discover alternative ways of accomplishing a particular task.

For more detailed information on your operating system, refer to the Microsoft Windows<sup>®</sup> XP documentation that came with your computer.

## Lesson 1: Exploring the desktop

The desktop is the launching pad for everything you can do in the Windows<sup>®</sup> XP operating system. You use its features to start programs, find documents, set up system components, and perform most other computing tasks.



*HINT: The illustrated examples in this guide may appear slightly different from the screens displayed on your computer. However, the differences are not significant and do not indicate any change in the functionality of your system.*

### Finding your way around the desktop

Your computer's desktop includes several standard features: icons, Start button, taskbar, system tray, and the desktop background pattern.

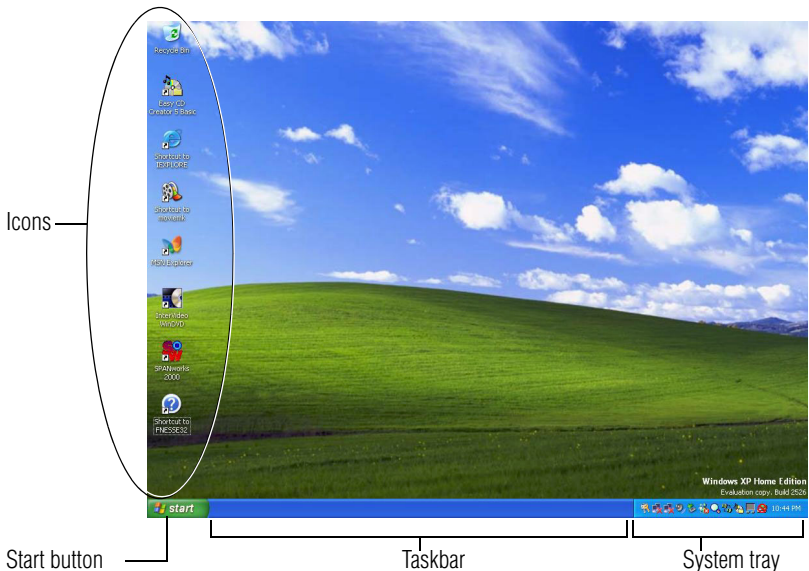

*Sample desktop*

## Icons

An icon represents a folder, file, or program that can be quickly activated by double-clicking the icon.

You can create a new desktop icon for any folder, file, or program by dragging the element's icon from its location in a window to the desktop area.

The icons initially displayed on your Windows® XP desktop include:



**My Documents** — Provides a convenient place to store documents, graphics, or other files you want to access quickly.



**My Computer** — Shows the file system for your computer and the network (if any).



**Recycle Bin** — Holds files you've deleted using the Windows Explorer. You may retrieve these files until you empty the Recycle Bin.



*TECHNICAL NOTE: If you delete a file from a diskette, it does not go into the Recycle Bin. For more information on the Recycle Bin, see Windows Help.*



**Internet Explorer** — The Microsoft browser that provides access to the Internet.



**Toshiba VirtualTech™** — A Toshiba utility to help answer technical questions and troubleshoot system problems. For more information about VirtualTech, see [“Using VirtualTech” on page 222](#).



**Toshiba Great Software Offer** — A service provided by Toshiba that offers additional software to you.



FreedomWare™ — Receive free offers, discounts and productivity solutions.

---



*NOTE: If you place the cursor over an icon, a popup description of the file contents appears.*

---

Your desktop may contain other icons depending on your configuration. See Windows® XP online Help for more specific information on each icon and how to use it.

## Start button

You use the Start button to:

- ❖ Start programs
- ❖ Access Microsoft Windows® XP update information
- ❖ Open recently accessed documents
- ❖ Adjust system settings
- ❖ Search for files
- ❖ Access Windows Help and Support
- ❖ Run programs
- ❖ Suspend system activity and shut down the computer

For more information on starting programs, see [“Lesson 6: Starting programs” on page 120](#).

## Taskbar

Each time you open a program, a button associated with that program appears on the taskbar. With some programs, a button appears on the taskbar for each document or window you open. You can use these buttons to quickly switch between the programs or windows.



To make a program or window active, click the associated button.

## System tray

The system tray displays icons of tasks or programs that run continuously in the background. To learn more about each task, position the cursor over the icon for a few moments and a short description of the task appears.

Typical tasks in the system tray are current time, power usage mode, and speaker volume.

To activate a specific task, double-click the appropriate system tray icon.

## Desktop background

When you first set up your computer, the background image (also called “wallpaper”) on the desktop is the Toshiba background image.

You can change the background of your desktop. To change the background:

- 1 Click **Start**, click **Control Panel**, and then double-click **Display**.
- 2 Select the **Desktop** tab, and choose the background you want to display on the desktop. Then click **OK**.

The new background wallpaper is enabled.

## Windows® XP file system

All files on your computer are organized for accessibility using a hierarchal file system.

Programs, documents, and other data are held in *files*. These files can be grouped together in *folders*, and folders can be grouped inside other folders for convenient organizing. All the files and

folders reside in your computer on a storage *device*, such as a disk drive.

You can think of your computer storage system in terms of office equipment. You have a file cabinet (device), that contains folders, and each folder may contain documents. Your office may have more than one file cabinet, just as your computer may have more than one disk drive.

Computers can be connected together to form a *network*, so that programs, documents and other data can be quickly and easily shared between computers.

You can use the My Computer feature on the desktop to access any file in the Windows file system.

For more information, read the Microsoft documentation that comes with your computer.

## Lesson 2: Using the TouchPad pointing device

“Getting Started” introduced you to the TouchPad, which is your basic tool for moving around the screen and performing computing tasks. This lesson lets you practice using the TouchPad.

- 1 Move the cursor to the **Start** button, then click the primary button to open the Start menu.



*NOTE: In this guide, the term “click” refers to the primary button (the left button). Instructions requiring the secondary button specifically mention that button. For example, “click the secondary button.”*

---

- 2 Click an empty area of the desktop to close the Start menu.
- 3 With the pointer in an empty area of the desktop, click the secondary button (the smaller one) to open the desktop shortcut menu.

As the name implies, shortcut menus provide quick access to many Windows<sup>®</sup> XP features.



*Sample desktop shortcut menu*

- 4 Click an empty area to close the shortcut menu.
- 5 Move the pointer to the **My Computer** icon, then click the primary button twice rapidly. (This process is known as “double-clicking.”)

The My Computer window opens.

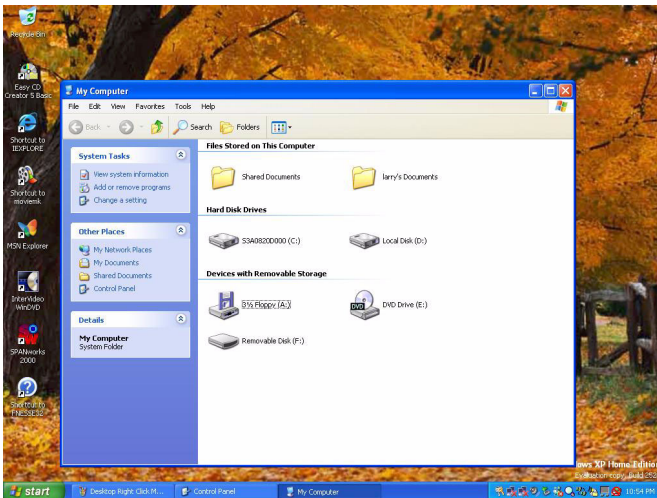

*Sample Desktop with the My Computer window open*



- Now click the Close button in the upper-right corner of this window.

The My Computer window closes.

## Lesson 3: Learning about the Internet

This lesson demonstrates how to access a Web page from a window and from the taskbar. The lesson assumes you have an account with an Internet Service Provider (ISP).

### Opening a Web page from a window

The most common way to open a Web page is by typing a Web address in the address line of the Web browser itself. But you can also type a Web address in the My Computer window.

- On the desktop, double-click **My Computer**.

The My Computer window appears.

- On the **View** menu, point to **Toolbars**, then click **Address Bar**.

The address bar indicates that you are in “My Computer.”

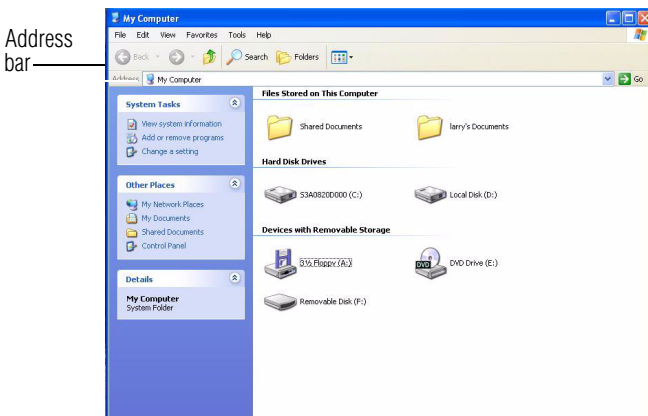

*Sample My Computer window*

- 3 In the address bar, type `http://www.toshiba.com`, and then press Enter.

If you are connected to the Internet, the Toshiba Web site appears.

## Lesson 4: Creating a new document

This lesson teaches you how to create a text file without having to first open a program.

- 1 Move the pointer to an empty area of the desktop, then click the secondary button.

A shortcut menu of commands applicable to the desktop appears.

- 2 Click **New**, then click **Text Document**.

An icon called New Text Document appears on the desktop with the icon name highlighted.

- 3 To give your document a meaningful name, type `New File.txt` and press Enter.

- 4 Double-click the **New File** icon.

The new document opens in Notepad—the text editor built into the Windows® XP operating system.

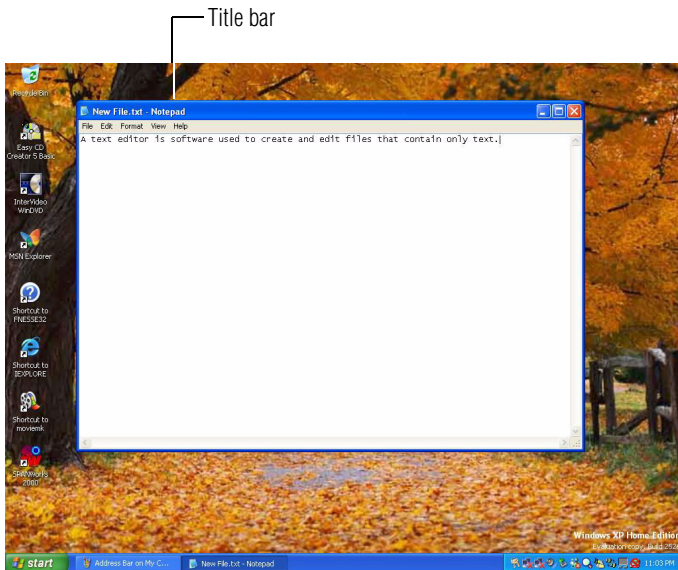

### *Sample Notepad window*

Notice that when the document opens, there is a new button on the taskbar that reads **New File.txt - Notepad** (the name may be too long to fit into the taskbar space but, if you point to the name, you see the complete name). By displaying buttons like this one, the taskbar helps you keep track of the programs and files you currently have open.

To learn more about Notepad, click **Start**, then click **Help and Support** or open the Help menu by pressing F1. For now, leave Notepad open and go on to the next lesson.

## Lesson 5: Creating a new folder



*DEFINITION: A folder is an area where you can store documents and other types of files. It is analogous to a file folder stored in a file cabinet. In this case, a disk drive in the computer is the file cabinet.*

The Windows<sup>®</sup> XP operating system stores documents and programs in folders. It even stores other folders in folders. In this lesson, you will create a folder in which to store your new document.

- 1 Move the pointer to an empty area of the desktop, then click the secondary button.

The desktop shortcut menu appears.

- 2 Click **New**, then click **Folder**.

An icon called New Folder appears on the desktop with the icon name highlighted.

- 3 Type a name for the folder, such as My Folder, then press Enter.



- 4 Close the Notepad document you just created by clicking the Close button on the right side of the Notepad title bar.

The document appears as an icon on the desktop.

- 5 Click the document icon and drag it toward your New Folder icon. Position the document icon over the New Folder icon until it changes color, then release the primary button.

The outline of the document icon moves across the desktop and disappears into the folder.

- 6 To see your document, double-click the folder icon.

A window opens and displays the contents of the folder.



- 7 Close the window by clicking its Close button and continue with the next lesson to learn how to start programs.

## Lesson 6: Starting programs

Usually, you will know which program you want to use for a particular task.

This lesson teaches you how to launch programs from the Start menu, using two of the programs that are built into the Windows<sup>®</sup> XP operating system: Paint and Windows Explorer.

- 1 Click **Start**, then point to **All Programs**.

A list of program folders appears.

- 2 Point to **Accessories**, then click **Paint**.

Paint—a basic drawing program—opens.

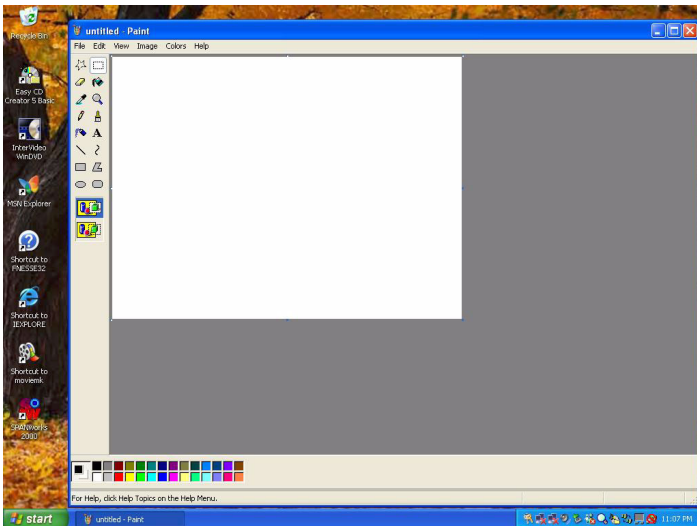

*Sample Paint program open on the desktop*



- 3 To open the second program, click **Start**, then click **All Programs**.
- 4 Point to **Accessories**, then click **Windows Explorer**.

Windows Explorer provides access to all your computer's resources. For example, it lets you see all the files in a particular folder on the computer's hard disk.

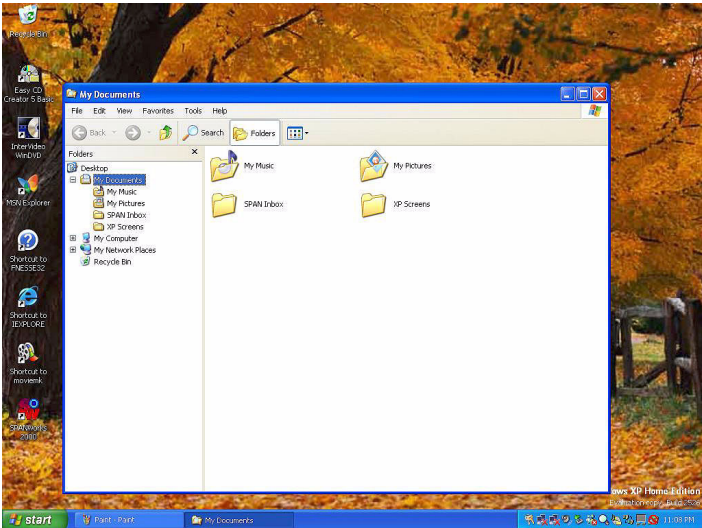

*Sample Windows Explorer open on the desktop*

Notice the taskbar now has two buttons on it—one for Paint and one for Windows Explorer.

- 5 Click the **Paint** button on the taskbar.

The Paint program is displayed on the desktop.

The Windows<sup>®</sup> XP Edition operating system places the active window on top of other windows on the desktop unless you have selected a different display option. You can move back and forth between the two programs by clicking each button alternately.

## Lesson 7: Resizing, repositioning, and hiding windows

If you have followed the lessons in this chapter, you now have a screen cluttered with several program windows. Fortunately, it is easy to create order out of this chaos. You can resize and reposition windows so that you can see more than one of them at a time. You can also hide windows by removing them from the desktop without actually closing your document or program.

This lesson introduces several ways to adjust the size, shape, and position of windows open on the desktop.

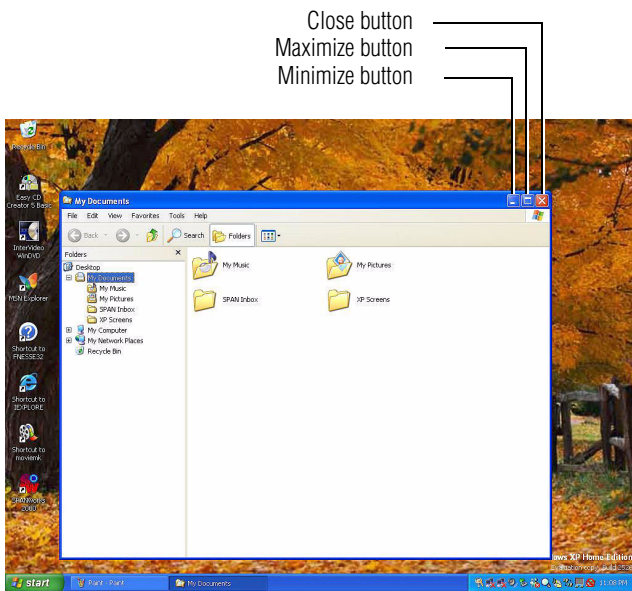

*Sample Windows Explorer open on the desktop*

## Using the taskbar

If you have applications open on the desktop, you can rearrange them by pointing your cursor to the taskbar and clicking the secondary button. You have these options:

- ❖ Move windows
- ❖ Size windows
- ❖ Minimize all windows — display only the taskbar buttons
- ❖ Maximize windows
- ❖ Close windows

Choose your option depending on how you wish to set up your desktop.

## Minimizing and maximizing windows

- 1 To make the Windows Explorer window the active window, click the **My Documents** button on the taskbar.

The Windows Explorer title bar is highlighted to show that Windows Explorer is the active window.



- 2 Click the **Minimize** button at the top-right corner of the Explorer window to hide the window.

Windows Explorer disappears from the desktop. However, it is still open, as you can see from the taskbar.



*HINT: Minimizing program windows is a good way to clean up the desktop without actually closing programs.*

---



- 3 Click the **Maximize** button in the top-right corner of the Paint window.

The Paint window expands to fill the screen, hiding everything except the taskbar. Notice that the Maximize button has changed. It is now called the Restore button.

---



*HINT: Maximizing a program is a good way to work when you are only using that program and do not want any distractions on the screen.*

---

## Resizing and moving windows



- 1 Click the Restore button in the top-right corner of the Paint window.

Paint returns to its previous size and location. Notice that the Restore button has changed back into the Maximize button.

For the next few steps assume that you want to be able to see both Paint and Windows Explorer at the same time.

- 2 Move the pointer to the right-hand edge of the Paint window.  
The pointer changes to a two-headed arrow.
- 3 Click and drag the edge of the window until it takes up just less than half the width of the desktop.
- 4 Click the title bar of the Paint window and drag it to the left side of the desktop.  
You can move any window by clicking its title bar and dragging it.
- 5 Click the **My Documents** button on the taskbar.
- 6 Repeat steps 3 and 4 to change the size and position of Windows Explorer, placing it on the right side of the desktop.

Now that the windows are side by side, you can see how you could refer to one window while working in the other.

Resizing and moving windows allows you to rearrange the desktop to suit your needs. Experiment with different sizes and placements of windows to find the best arrangement for your work.

At this point you have two programs open on the desktop. The next lesson shows you how to close them.

## Lesson 8: Closing programs

Once you are finished working with a document or program, it is a good idea to close it. While you can run several programs at the same time, having a large number of programs and documents open simultaneously can slow down your computer.

This lesson teaches you how to close the programs you opened earlier in this tutorial.



- 1 Click the Close button at the top-right of the Explorer window.

That is all there is to it. Windows Explorer closes, removing the Explorer button from the taskbar as well.

- 2 Close Paint and the My Computer window (assuming it is still open) by clicking the Close buttons for each program.



*HINT: Always save your work before you close a program.*

## Lesson 9: Creating shortcuts

By adding shortcuts to your desktop, you can open programs or files with the click of a button. You will probably want to create shortcuts for the programs you use most frequently. This lesson explains how to create shortcuts using two Windows<sup>®</sup> XP accessories, Calculator and Character Map, as examples.

### Creating a shortcut to the Calculator

Use this method when you know the name and location of the program file to which you would like to create a shortcut.

- 1 Move the pointer to an empty area of the desktop, then click the secondary button.

The desktop shortcut menu appears.

- 2 Click **New**, then click **Shortcut**.

The Create Shortcut dialog box appears.



*Sample Create Shortcut dialog box*

- 3 In the **Command line** box, type `c:\windows\calc.exe` and click **Next**.
- 4 A dialog box prompts you to select a name for the shortcut.
- 5 Type Calculator and click **Finish**.

The Windows<sup>®</sup> XP operating system displays the new shortcut on your desktop.

## Creating a shortcut to the Character Map

Use this method when you don't know the name and location of the program file.

- 1 Click **Start**, then point to **Search**.

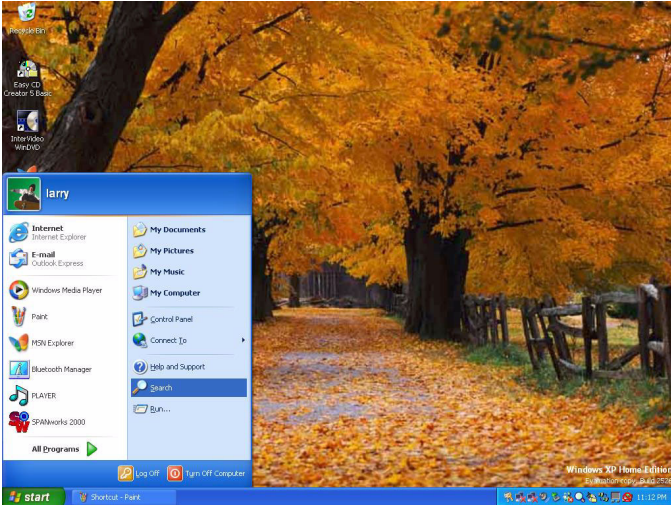

*Sample Search options on the Start menu*

- 2 Click **All Files or Folders**.

The Search Results dialog box appears.

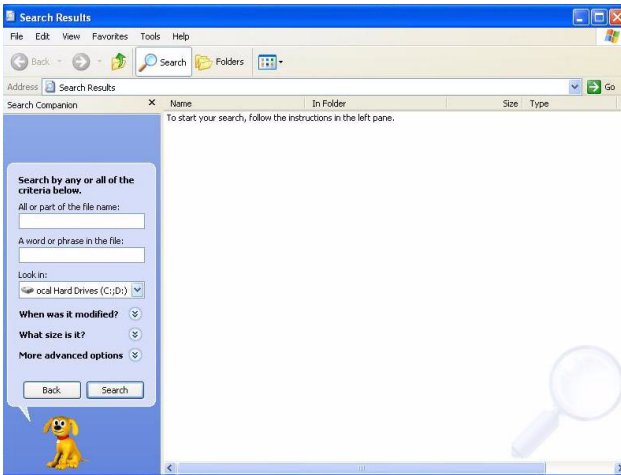

*Sample Search Results dialog box*



*HINT: Search also allows you to perform searches on the Internet.*

- 3 Type char in the **All or part of the file name:** text box, and then click **Search**.

The Search function displays a list of all the files with “char” in their names.

- 4 Click the **Character Map** file with the secondary button and drag it to the desktop.

A shortcut menu appears.

- 5 Click **Create Shortcut**.

A shortcut to the Character Map appears on your desktop.



Clicking a shortcut icon opens the program or folder immediately. You can place as many shortcuts on your desktop as you find useful.



*HINT: The Character Map is a useful tool when you want to add a special character to a document.*

## Lesson 10: Changing the screensaver

You can personalize the background area of your desktop with pictures, patterns, or colors. The background is considered a “property” of your desktop. This lesson will not only teach you how to personalize the background, but will also introduce you to properties.

The Windows<sup>®</sup> XP operating system treats all windows, icons, programs, drives, etc. as self-contained objects, each with its own set of properties (such as size, position on-screen, and color). Many of these properties can be customized to meet your particular needs and tastes.



*DEFINITION: An object is an independent block of data, text, or graphics that was created by an individual application.*

This lesson introduces object properties by showing you how to change one of the properties of the desktop—the screen saver. This is a continuously changing pattern that appears on the screen during pauses in your work.

- 1 Move the pointer to an empty area of the desktop, then click the secondary button.

The desktop shortcut menu appears.

**2** Click **Properties**.

The Display Properties dialog box opens.

*Sample Display Properties dialog box***3** Click the **Screen Saver** tab.**4** Click the arrow beside the current option—probably “(None)” —to open the screen saver list box.**5** Scroll through the screen saver options by clicking the scroll arrows in the list box.**6** Try a screen saver pattern by clicking a name in the list box.

Your selection appears in the monitor above the list box. Try several patterns.

**7** To apply a pattern to your desktop, click **Apply**.**8** After you have chosen a screen saver pattern and applied it to your desktop, click **OK**.

You return to the desktop.

You can view any object’s properties by clicking the object with the secondary button, then choosing **Properties** from the shortcut menu that appears.

The next lesson explains how to set two other properties—the date and time.

## Lesson 11: Setting the date and time

You initially set the computer's date and time properties when you turned the computer on for the first time.

To change the date and time settings:

- 1 Click **Start**, then click **Control Panel**.

The Control Panel appears.

- 2 Double-click the **Date/Time** icon.

The Date/Time Properties dialog box appears.

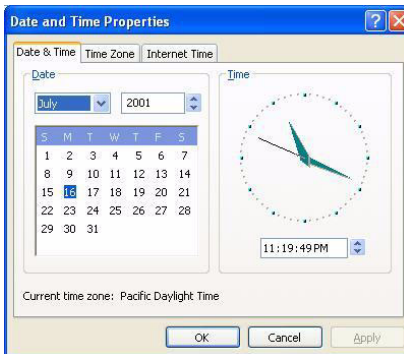

*Sample Date/Time Properties dialog box*



*HINT: To open the Date/Time Properties dialog box more quickly, either click the time display on the taskbar with the secondary button, then click Adjust Date/Time, or double-click the time display.*

- 3 Set the correct month, year, day, and time.

- 4 Click the **Time Zone** tab and set your time zone.
- 5 Click **OK**.

Continue with the next lesson to finish cleaning up the desktop.

## Lesson 12: Removing objects from the desktop

Earlier in this tutorial, you created a new icon on the desktop. Since everything you have done to this point has been just practice, you may want to return the desktop back to its original uncluttered state. This lesson explains how to remove objects from the desktop and introduces the Recycle Bin.

- 1 Click the **New Folder** icon you created, drag it until it is over the Recycle Bin icon and it changes color, then release the primary button.

The icon disappears. But, with the Windows<sup>®</sup> XP operating system, it is not really gone. It is merely set aside in the Recycle Bin so that you can restore or delete it later.

- 2 Repeat step 1 for any other icons you created during this tutorial.

Each icon disappears as you drop it on the Recycle Bin.

- 3 Double-click the **Recycle Bin** icon.

The Recycle Bin window opens. Notice that all the icons you dropped on the Recycle Bin are listed.

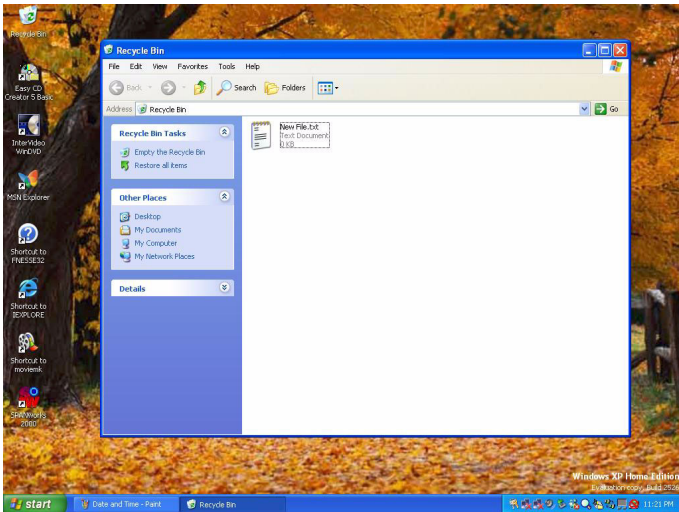

*Sample Recycle Bin open on the desktop*

- 4 To completely remove an object, select it, and then click **File, Delete**.

The object is permanently deleted from the Recycle Bin.

Later on—in your real work, not in this tutorial—you will use the Recycle Bin to delete other objects such as folders, documents, and sometimes even programs. Still, the process is the same. Just drag an object's icon to the Recycle Bin.

If you change your mind and want to restore an object you sent to the Recycle Bin, select the object with the secondary button and click **Restore**. The Windows<sup>®</sup> XP operating system restores the object to the place from which it was deleted.

But when you are absolutely certain that you never want to see it again, delete it from the Recycle Bin.

To delete everything from the Recycle Bin at once, choose **Empty the Recycle Bin** from the File menu.



*HINT: Empty the Recycle Bin periodically. Even though an item is moved to the Recycle Bin, it still uses valuable space on the hard disk drive until it is deleted from the Recycle Bin.*

## Lesson 13: Using System Restore

The System Restore feature allows you to return your computer to the way it was configured on a specific date or time, a “restore point.” This is useful if you are reconfiguring your computer for new hardware or software. In the event that your hardware or software causes your computer to malfunction, you can remove the offending item(s) and restore the system to the state it was in at the preset time.

To open System Restore, click **Start**, point to **All Programs**, **Accessories**, **System Tools** and **System Restore**.

The System Restore Welcome screen appears.

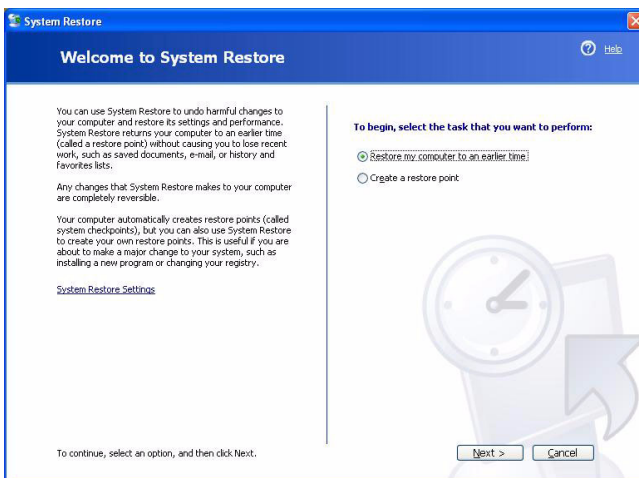

*Sample System Restore welcome screen*

The Windows<sup>®</sup> XP operating system guides you through the process of storing your system settings for future use. It also guides you through restoring your system to the selected date or time.

## Lesson 14: If I am lost, what do I do?

This lesson teaches you how to use some of the Help features in the Windows<sup>®</sup> XP operating system.

### Windows<sup>®</sup> XP Help

The Windows<sup>®</sup> XP operating system has an excellent Help facility. If you cannot figure out how to do something, the answer is probably only a few clicks away.

Assume that you want to draw a picture but don't know how.

- 1 If you have an application open, press F1, otherwise click **Start**, then click **Help and Support**.

The Help and Support window appears.

- 2 If you do not see the Index, click the **Index** icon on the toolbar.

Help and Support displays the Index.

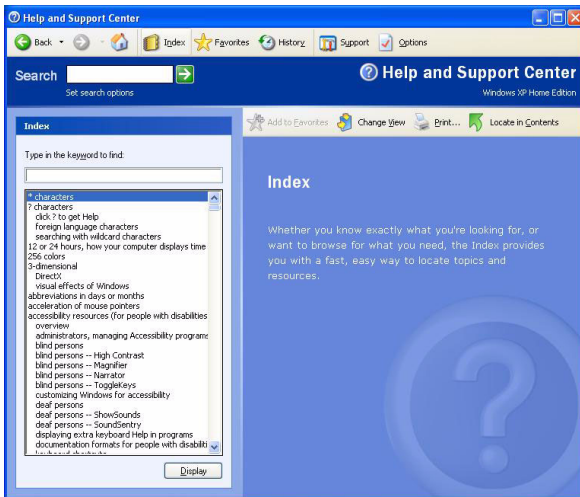

### *Sample Help and Support Index*

The left side of the screen contains the index. The text box above the index, where the cursor is flashing, lets you type in a topic you want to find in the index.

#### **3** Type pictures in the text box.

Notice as you type that the corresponding location in the index appears. When you type the letter p, the topic list moves to the first entry that begins with P, and so on.

There are a number of topics listed under Picture. One of them, “creating, editing with Paint,” looks promising.

#### **4** Double-click **creating pictures using Paint**.

Help opens a topic screen that gives a brief description of how to draw pictures, including an icon to start the Paint program.



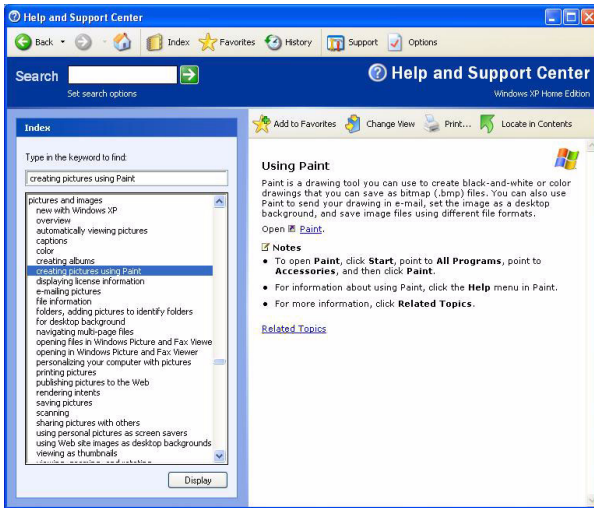

*Sample drawing Help window*

**5** Click the **Open Paint** link.

The Paint program opens.

Not every Help topic contains a hot link to start the program it is talking about. However, when you do encounter one, it provides a convenient way to start the program to look at it while you read about the program in the Help topic.

## Using the online tours and tutorials

Whether you are new to computers or you have some experience, the Windows<sup>®</sup> XP Tours and Tutorials collection is a good place to start.

If you are not familiar with either the Windows<sup>®</sup> 2000 or Windows<sup>®</sup> XP operating system, start with “Windows Basics.”

If you have used the Windows<sup>®</sup> 2000 operating system, “What’s New in Windows” is a helpful introduction to the new features in the Windows<sup>®</sup> XP operating system.



*Sample Windows<sup>®</sup> XP Tours and Tutorials window*

## Lesson 15: Turning off your computer

It is very important that you let the Windows® XP operating system shut down your computer. As it shuts down, the operating system performs a number of tasks ensuring that everything is in place the next time you turn on the computer. This lesson teaches you how to shut down the Windows® XP operating system and turn off your computer.

- 1 Click **Start**, then click **Turn Off Computer**.

The Turn Off Computer dialog box appears.

- 2 Select **Turn Off**, then click **OK**.

A shutting down message appears and the computer is turned off.

There are other ways to shut down your computer. For more information, see [“Powering down the computer”](#) on page 93.

**- Blank Page -**

# Chapter 6

## Exploring Your Options

---

In this chapter, you will explore other features of your notebook computer.

### Windows<sup>®</sup> XP special features

The Windows<sup>®</sup> XP operating system offers you several new features and enhancements, including:

- ❖ New system file protection
- ❖ A system restore function, allowing you to roll back the system to its previous state
- ❖ An improved help center, support automation, and automatic Windows<sup>®</sup> update
- ❖ Wizards to simplify setting up your home network
- ❖ Ability to share one Internet connection among multiple PCs
- ❖ An automatic discovery feature that allows your computer to detect new and intelligent devices

## Personalizing your desktop

Your desktop is your virtual workspace. This section explains how to customize its features for the way you like to work. You can customize the following aspects of the desktop:

- ❖ Taskbar—which resources to display for quick access
- ❖ Folders style —how windows are displayed and how to browse folders and files
- ❖ Toolbars—what information appears at the top of each window

### Customizing the taskbar

As you work, the taskbar changes to reflect what you are doing. Its icons provide shortcuts to programs, documents, files, folders, system features, and components. Open applications also have Forward and Backward buttons to allow navigation through folders, documents, and Web sites.

For example, you can personalize the taskbar to include not only Quick Launch icons, but also your favorite URL addresses or local folders and programs.



*DEFINITION: URL stands for Uniform Resource Locator, which is the address that defines the route to a file on the Web or any other Internet facility. Generically, it is known as the World Wide Web site address.*

Having a list of favorite URLs handy saves time. Using it bypasses the need for you to launch your browser first.

To access all taskbar options, point to an empty space in the taskbar and click the secondary button to customize your setting.

## Choosing folder options

To select a desktop style and browsing option:

- 1 On the desktop, double-click **My Computer**.  
The My Computer window appears.
- 2 On the **Tools** menu, click **Folder Options**.  
The Folder Options dialog box appears.

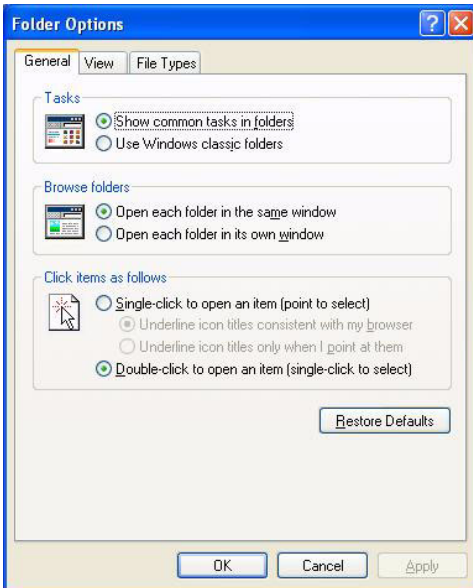

### *Sample Folder options*

- 3 Click the style you want to use, then click **OK**.

## Personalizing individual windows

Just as you can display a Web page on your desktop, you can also display a Web page in an individual window. If you subscribe to the Web page, it can be automatically updated on a regular basis. For example, using this Web integration feature you can monitor weather, game scores, stock prices, or headlines—all in the window of your choice.

## Adding a background to a window

If you select art or a Web page as a window background, set your desktop style to Web style—or select the **As Web Page** option from the View menu.

To add a background to a window:



- 1 Double-click **My Computer**.

The My Computer window opens.

- 2 Open the folder you want to customize.
- 3 On the **View** menu, select **Customize this folder**, and follow the prompts.

## Customizing window toolbars

You can display one or more customizable toolbars at the top of a window. As you browse, the Windows<sup>®</sup> XP operating system detects the kind of information presented in the window and automatically displays the appropriate toolbar buttons and menus.



You can also add these toolbars to the taskbar.

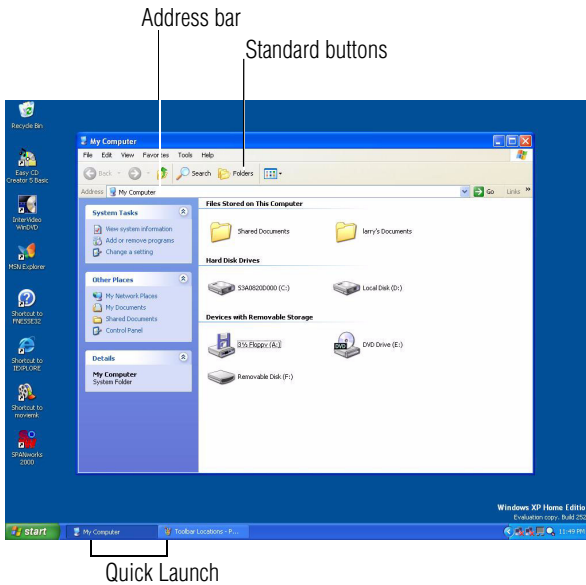

### *Sample toolbar locations*

The elements you can add to the top of the window are:

<i>Toolbar element</i>	<i>Description</i>
------------------------	--------------------

Address Bar

Opens Web pages, programs, folders, or documents. By default, the address bar shows your current location, and whether it is a folder or a Web page. You can browse to another location by typing an address—a URL, a path, or even a program name.

If you start typing a previously typed address, the AutoComplete feature finishes the address for you.

<i>Toolbar element</i>	<i>Description</i>
Standard buttons	Displays buttons for commonly used commands, such as copying, pasting, deleting items, changing views, and browsing backward and forward.
Quick Launch	Opens your browser or email program or allows you to view channels or instantly bring your desktop to the front. To add a new toolbar button, drag the program icon to the Quick Launch tray.

## Displaying a toolbar in a window



- 1 On the desktop, double-click **My Computer**.

The My Computer window appears.

- 2 On the **View** menu, point to **Toolbars**, then click the name of the toolbar you want to display.

The toolbar appears below the menu bar of the current window.

## Displaying information about each folder

In addition to displaying the contents of each window, you might find it helpful to have the operating system display the name of the folder and brief information about how to use the folder.

- 1 Double-click **My Computer**.

The My Computer window opens.

- 2 Open the folder you want to view as a Web page.

- 3 On the **Tools** menu, select **Folder Options**.

- 4 Make the selections on the **View** tab, then click **OK**.

## Connecting a monitor, keyboard and mouse

By connecting an external monitor, external full-size keyboard and a mouse, you can work with your notebook as if it were a standard office computer.

To connect a television to your computer, you must first purchase a video cable.



You can connect an external monitor to the monitor port. For more information, see [“Back” on page 29](#).



You can connect an external USB-compatible keyboard and a USB-compatible mouse to one of the USB ports. For more information about connecting a mouse, see [“Connecting a mouse” on page 52](#).

## Connecting to a local area network

You can connect your computer to a Local Area Network (LAN) at work or from a remote location.

### Accessing a LAN

To access a LAN:

- ❖ **At the office**  
If your computer has an integrated 10/100 Ethernet port, you can connect the network Ethernet cable to the LAN (RJ45) port on your computer. Your computer may also be equipped for wireless communications. For specific information, consult your network administrator.
- ❖ **From home or while on the road**  
You'll need a dial-up connection. Ask your network administrator for the telephone number of the network.

## Setting up the connection

To set up an office connection, consult your network administrator for network settings and additional considerations.

To set up a dial-up connection, use the New Connection Wizard:

- 1 Click **Start** and point to **All Programs**.
- 2 Point to **Accessories**, then to **Communications**, and click **New Connection Wizard**.
- 3 Click **Next** and follow the on-screen prompts.

## Setting up a wireless connection

If your computer is equipped with the Wi-Fi wireless communication module, refer to your wireless networking device documentation or your network administrator for information on setting up a wireless connection.

## Exchanging data with another computer

To transfer a large amount of information between computers, you need a wireless or physical connection and a synchronization program.

You can use the Windows<sup>®</sup> XP Briefcase or a specialized synchronization program that transfer's data using a cable connected to the computers' parallel ports.

## Transferring files using a parallel port connection

To transfer files using the computers' parallel ports, you need a LapLink<sup>®</sup> - compatible parallel cable.

## Getting started

- 1 Connect the cable.
- 2 Load the transfer program on both computers.
- 3 Set any specific options.
- 4 Start the transfer.
- 5 When you have finished transferring files, close the programs on both computers.

## Getting help

- 1 Click **Start**, then **Help and Support**.
- 2 Click the **Index** icon on the toolbar.
- 3 In the dialog box, type direct cable connection.
- 4 Follow the online guide instructions.

## Connecting to the Internet

To connect to the Internet you need:

- ❖ A modem (one comes with your Satellite computer)
- ❖ A telephone line, DSL or cable connection
- ❖ A browser or communications program
- ❖ An Internet Service Provider (ISP) or online service

## Making the physical connection

You can connect to the Internet by using a telephone and modem or through other higher-speed communication methods, such as Digital Subscriber Lines (DSL), cable, and satellite link.

## Using a modem

If you're using a modem, you connect the modem to one of the computer's COM (communications) ports. The default setting for the modem is COM3.

If you are having trouble connecting through the modem, you may need to determine the current COM port name and possibly change it.

## Determining the COM Port

To find out which port your modem is connected to:

- 1 Click **Start**, and then click **Control Panel**.
- 2 Double-click **Phone and Modem Options**.

The Phone and Modem Options dialog box appears.

- 3 Click the **Modems** tab.

Your modem should be listed next to one of the computer's COM ports.

- 4 Make a note of the COM port number.
- 5 Click **OK** to close the dialog box.
- 6 Close the Control Panel.

## Testing the modem



*NOTE: It is recommended that you do not use the infrared port at the same time as either playing audio or connecting to the internet via a modem. Audio quality may be reduced and the modem connection may be slower or disrupted.*

---

To test to see if your modem is functioning properly:

- 1 Click **Start**, and then click **Control Panel**.

**2** Double-click **Phone and Modem Options**.

The Phone and Modem Options dialog box appears.

**3** Click the **Modems** tab.

Your modem should be listed next to one of the computer's COM ports.

**4** If there is more than one modem listed, select the one you wish to test, and click **Properties**.

**5** Click the **Diagnostics** tab.

**6** Click on **Query Modem**.

A pop up window will inform you that the modem query may take a few moments before displaying the result of the test.

## Signing up with an Internet Service Provider

An Internet Service Provider (ISP) is a company that has the equipment and the telecommunication lines necessary to maintain an Internet connection.

Microsoft's Web browser, Internet Explorer, which is preinstalled on your system, is automatically configured so that when you first start it, it guides you through signing up for a new ISP account, or assists you in setting up your computer to work with your existing ISP.

Once you have established an ISP account, you can access the Internet.

## Getting started

- 1 Connect your computer's modem to a telephone line.



*TECHNICAL NOTE: If you are using the telephone line at home, disable Call Waiting before you connect through the modem. Call Waiting interrupts data transmission.*



- 2 Start your Web browser. Have your modem dial the ISP's telephone number, and establish a connection with the ISP's computer.

If you are using your computer at the office, then you probably connect to the Internet through your company's local area network. For more information, see [“Connecting to a local area network”](#) on page 147.

## Using the Internet

The following sections give a quick introduction to the Internet and some of its exciting features, under these headings:

- ❖ The Internet
- ❖ The World Wide Web
- ❖ Surfing the Internet
- ❖ Internet features
- ❖ Uploading and downloading files from the Internet

For more information about the Internet, see [“Lesson 3: Learning about the Internet”](#) on page 116.



## The Internet

The Internet is an association of thousands of networks and millions of computers around the world connected by communications lines. They all work together to share information.

## The World Wide Web

The World Wide Web (or 'Web') is a subset of the Internet—a collection of interlinked documents (located on computers connected to the Internet) that work together using a specific Internet protocol called Hypertext Transfer Protocol (HTTP).

The World Wide Web offers information as text, images, audio, or video to be referenced from anywhere in the world. Special programs called Web browsers are specifically designed to work with HTTP. They make it easier to connect to a particular network address and send and receive information.

## Surfing the Internet

Once connected to the Internet, the Web browser displays a home page, for example, your ISP's home page on the Internet or your company's Web site home page.

To visit a desired Web site, type in the Web address. The Web address, or Uniform Resource Locator (URL), is a unique identifier for that computer system linked to the Internet. Web addresses can also appear within a Web page's text, and are known as links. Clicking a link automatically transfers your Web browser to that site.

You can also use a Search Engine, a Web site specifically designed to help you look for information.

## Internet features

The Internet offers many types of communication tools to help you perform many tasks.

❖ **Internet email**

To send and receive email of your own, you need a mailbox on the Web, or an email address.

If you have an account with an ISP, you can probably set up an email address at the same time as you sign up for the service.

❖ **Internet chat rooms**

A chat room is a Web site that offers a place where people with similar interests and ideas can communicate in real-time, one-on-one or in groups, by typing messages which are instantly viewed by others on their computer screens.

❖ **Internet news groups**

A news group is similar to a chat room, but instead of using a dedicated site to converse about a specialized subject with others in real-time, it uses a Web site as a clearinghouse where all the messages are placed, like a gigantic bulletin board.

❖ **Online shopping**

Many Web sites offer products and services for sale.

## Uploading and downloading files from the Internet

Transferring files from one computer to another is termed uploading (transferring data from your computer to a site on the Web), or downloading (transferring data from a site on the Web to your computer).

There are several ways to upload or download data. It can be as simple as attaching a file or document to an email, or you can use the File Transfer Protocol (FTP) features of your Web browser to transfer large amounts of data.

## Toshiba's online resources

Toshiba maintains a number of online sites to which you can connect. These sites provide information about Toshiba products, give help with technical questions, and keep you up to date with future upgrades. For more information, see ["Contacting Toshiba"](#) on page 224.

## Conducting an electronic meeting

With the SPANworks™ 2000 application, you can use your notebook computer to hold an electronic meeting with other computers on the network. You can do such things as transfer files between two computers, broadcast a slide presentation simultaneously to several machines, set up electronic business cards, and send text messages to a few people or to everyone in your proximity.



*NOTE: Before using SPANworks, you must establish a network link between the computers.*

To access SPANworks 2000:



- 1 Double-click the **SPANworks** icon on the desktop.
- 2 Follow the instructions on your screen to set up a connection to the network.

## SPANworks 2000 file utilities

The central application of SPANworks 2000 is designed to enable data transfers among a group of computers without using wired connections. You can transfer files, browse authorized locations on other computers, or synchronize data with other computers. A record of each transaction is maintained in a list or archive so you know exactly what you sent to others, or received from them.



*TECHNICAL NOTE: Toshiba recommends that you start the SPANworks 2000 application after closing all other applications. This will ensure system resources are available since in the presentation function, SPANworks 2000 may stop opening a presentation if the amount of remaining system resources is less than required.*

---

## Exploring video features

Your computer's video features include viewing Windows presentations or DVD movies either on the computer screen (display panel or external monitor) or on a television set.

### Viewing presentations or DVD movies on your television

To view a DVD movie or Windows presentation in full-screen mode on your TV:

- 1 Connect a video cable to the TV out port on your computer.
- 2 Change the display properties setting to 640 x 480:
  - ❖ Right click anywhere on your desktop and select **Properties**.

The Display Properties dialog box appears.

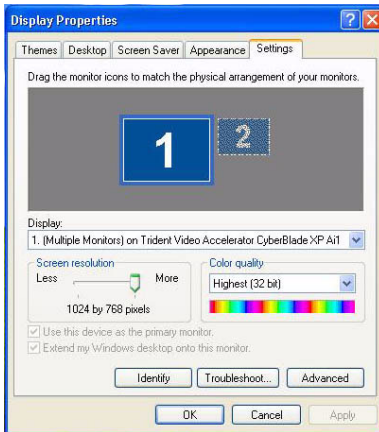

*Sample Display Properties dialog box*

- ❖ Click the **Settings** tab.
  - ❖ Slide the Screen area slider bar toward **Less** until the setting reads **640 x 480**.
  - ❖ Click **Apply**, then **OK**.
- 3** Connect the other end of the video cable to your television.
  - 4** Press Fn and F5 three times consecutively. The picture will automatically display on the TV screen.
- If a movie is already playing, turn it off and repeat step 3.



*TECHNICAL NOTE: If you are using WinDVD, Fn and F5 will not turn the display off and on.*

## Exploring audio features

You can use your computer to record sounds using an external microphone. You can play .wav sound files or audio CDs using the built-in speakers, headphones or external speakers.



*NOTE: It is recommended that you do not use the infrared port at the same time as either playing audio or connecting to the internet via a modem. Audio quality may be reduced and the modem connection may be slower or disrupted.*

## Recording sounds

You can make audio recordings and save them as .wav files by connecting an external microphone or other sound source to the microphone jack and using Windows' Sound Recorder.



*DEFINITION: A .wav (pronounced "wave") file is the format for storing sound in files in Windows.*



## Using a microphone

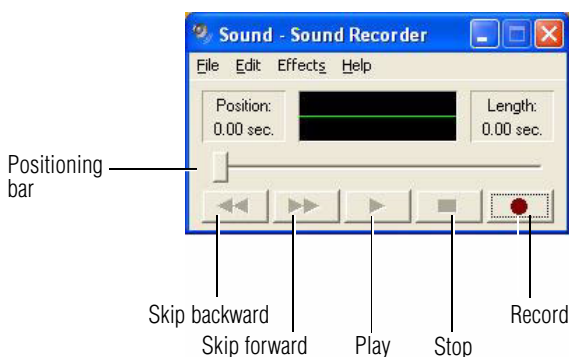

- 1 Connect an external microphone to the computer.
- 2 Click **Start**, point to **All Programs**, **Accessories**, **Entertainment**, then click **Sound Recorder**.



### Sound Recorder window

-  **3** Click the **Record** button and speak normally into the microphone.  
The maximum recording time is 60 seconds.
-  **4** When you have finished recording, click the **Stop** button.
-  **5** To hear what you just recorded, click the **Play** button.
- 6** To save the file, select **Save** from the **File** menu.

## Adjusting recording quality

The better the quality of the recording, the more disk space the sound file requires. Experiment to find a balance that fits your needs.

- 1** Open Sound Recorder, if necessary (click **Start**, point to **All Programs, Accessories, Entertainment**, then click **Sound Recorder**).
- 2** In the Sound Recorder window, click **Edit**, then click **Audio Properties**.
- 3** In the Audio Properties dialog box, adjust the Recording Volume, Preferred device, and Preferred quality.
- 4** Click **OK**.

Your new settings take effect the next time you record.

## Using external speakers or headphones

Your computer is equipped with a full stereo sound system with internal speakers. Instead of using the internal speakers, you can connect headphones or a pair of external stereo speakers.



*TECHNICAL NOTE: Use amplified speakers that require an external power source. Other types of speakers will be inadequate to produce sound from the computer.*

---





To play back sound files through external speakers or headphones:

- 1 Locate the headphone jack on the computer.

To locate the headphone jack, see “[Left side](#)” on page 32.

- 2 Using any necessary adapters, plug the cable from the headphones or external speakers into the headphone jack.

The headphone jack requires a 16-ohm stereo mini-jack.



- 3 Adjust the volume.

## Using PC Cards

PC Cards expand your computer’s capabilities and usefulness. You can purchase additional PC Cards from your dealer. Most PC Cards conform to the PCMCIA (Personal Computer Memory Card International Association) standard.

Your computer has two stacked PC Card slots and supports three types of PC Cards:

- ❖ Type I cards and Type II cards are typically used for memory storage, network cards, etc. You can install up to two of these cards, one in each slot.
- ❖ Type III cards are used for removable hard disks and other functions that require a larger card. You can install just one of these cards.

Check the documentation that came with the PC Card to see if it conforms to the PCMCIA 2.1 standard, or later. Other cards may work with your computer, but are likely to be much more difficult to set up and use.

## PC Card supporting software

PC Cards require Card and Socket Services software — a set of programs that acts as a translator between the PC Card and the computer, and that makes hot swapping (switching cards while the computer is on) possible.

The Windows<sup>®</sup> XP operating system provides the Card and Socket Services for your PC Card. Even if your PC Card comes with its own version of Card and Socket Services, you should use the files included in the Windows<sup>®</sup> XP operating system.

## Inserting PC Cards

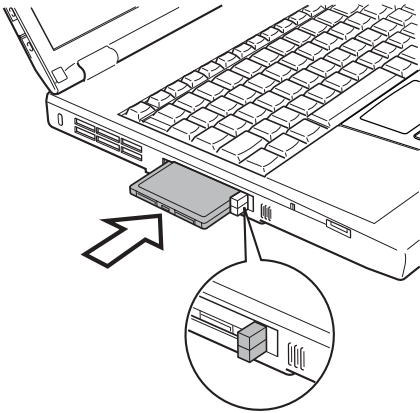

### *Inserting a PC Card*

- 1** If your PC Card does not support hot swapping, save your data and turn off the computer before inserting the PC Card. For more information, see [“Hot swapping” on page 164](#).
- 2** Hold the PC Card with the arrow side up and the connector side toward the slot.

- 3 Align the card connectors with an available PC Card slot and carefully slide the card into the slot until it locks into place.



*NOTE: If you have a Type III card, insert the connector into the lower slot. If you have a Type I or Type II card, you can insert it into either the upper or the lower slot.*

There are two eject buttons, one per slot. When the PC Card is seated, the eject button for that slot pops out.

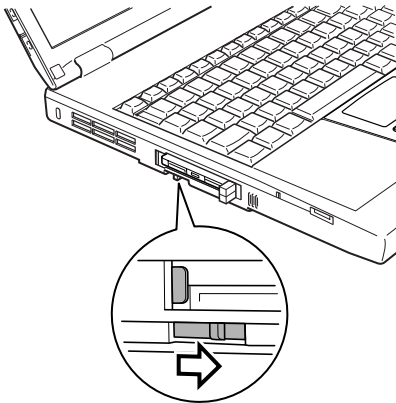

*Locking the PC Card in place*



*CAUTION: To avoid damaging the PC Card or the computer, do not force the card into the PC Card slot.*

- 4 Slide the PC Card lock to the right.

## Removing PC Cards

- 1 Click the **PC Card** button on the taskbar.
- 2 Click **Stop xxxx** where xxxx is the identifier for your PC Card. A message advises you that you may safely remove the card.
- 3 To remove the PC Card, press the slot's eject button once.

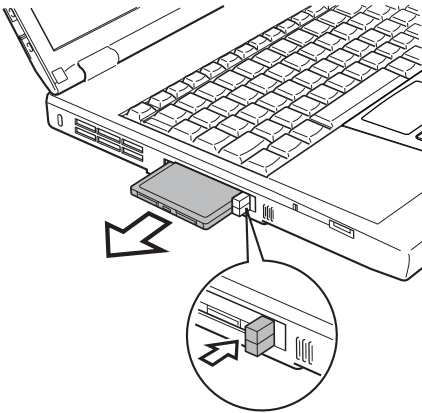

### *Ejecting a PC Card*

- 4 Remove the PC Card and store it properly.

## Hot swapping

One of the great things about PC Cards is that you can replace one PC Card with another while the computer is on. This is called “hot swapping.”

### Hot swapping precautions

Although you can insert a PC Card at any time, to avoid data loss never remove a card while it is in use. For example:

- ❖ Never remove a hard disk card while the system is accessing it.

- ❖ Never remove a network card while you are connected to a network.
- ❖ Never remove a SCSI card while any of the SCSI devices connected to it are operating.



*DEFINITION: SCSI is an acronym for Small Computer Systems Interface. A single SCSI PC Card enables you to connect several SCSI devices, such as a scanner or digital camera to your computer.*

Before removing a PC Card, shut it down by clicking the PC Card (PCMCIA) icon on the taskbar. Once the PC Card has stopped, you can safely remove it.

## Emulating a full-size keyboard

Although the computer's keyboard layout is compatible with a standard full-size keyboard, it has fewer keys.

Pressing the Fn key simultaneously in combination with one of the specially marked keys allows you to emulate a full-size keyboard. For further information and instructions, see [“Using the keyboard” on page 70](#) for more information.

**- Blank Page -**

# Chapter 7

## Toshiba Utilities

---

Your computer includes several utilities designed to help you to reconfigure your system to best meet your individual needs. Together, these allow you to ascertain certain system details, set additional options, or change default options. These utilities are described in this chapter:

- ❖ Fn-esse®
- ❖ Hardware Setup
- ❖ Power Saver

### Fn-esse

Desktop shortcuts and Toshiba's Fn-esse program provide quick ways to open programs, documents, and folders from within any Windows program without using the Start menu.

This section describes how to use the Fn-esse program to quickly access your programs and files. For information on creating desktop shortcuts, see [“Lesson 9: Creating shortcuts” on page 126](#).

With Fn-esse, you can assign an Fn key combination to:

- ❖ Open a Windows program
- ❖ Open a file in its associated Windows program
- ❖ Display a customized folder of Windows programs and/or files from which to choose

Fn-esse also has several keys, known as hot keys, that perform preassigned operations. For more information, see [“Hot Keys” on page 229](#).

You can assign any key that is not associated with a hot key or a keyboard overlay.

## Starting Fn-esse

To start Fn-esse, click **Start**, point to **All Programs**, **Toshiba Utilities**, then click **Fn-esse**.

The Fn-esse keyboard appears.



### *Fn-esse window*

The keys are color-coded as follows:

- ❖ Available keys are black.
- ❖ Assigned keys and keys associated with a popup list are shown on the Fn-esse keyboard in the selected color.
- ❖ Unavailable keys are dark gray.



## Assigning a key to a program or document

There are two ways to assign a key to open a program or document:

- ❖ Drag-and-drop
- ❖ Use the keyboard or pointing device

The method most often used is drag-and-drop.

### Using drag-and-drop

To assign a key to a program or document:

- 1 Start both Fn-esse and Windows Explorer (or the program supporting drag-and-drop).
- 2 Resize the Explorer window so that you can see both the Fn-esse keyboard and Explorer at the same time.
- 3 In the Explorer window, highlight the program or document file you wish to assign to a key.
- 4 Click and hold the primary button as you drag the highlighted item from Explorer to the key on the Fn-esse keyboard you wish assigned.
- 5 Release the primary button.

Fn-esse displays the Add/Edit Command dialog box with the Description, Command Line, and Working Directory fields automatically completed.

- 6 Click **OK** to close the Add/Edit Command dialog box with your key assignment in place.

The program or document is now associated with the key you just selected. To open the program or document, press Fn plus the appropriate key from within any Windows program.

## Using the keyboard or pointing device

To assign a key to open a program or document:

- 1 Start Fn-esse.
- 2 Perform one of the following:
  - ❖ Using the keyboard, press and hold the Fn key, then press the desired assignment key.
  - ❖ Using the pointing device, move the cursor over the desired key and press the secondary button.

The Assignment Type dialog box appears.



*HINT: If you are making a direct key assignment, complete step 3. If you are making a popup assignment, complete step 4.*

- 3 To make a direct key assignment, select **Direct** to display the Add/Edit Command dialog box, then complete these steps:
  - ❖ Enter the Description, Command Line, and Working Directory for the new Fn-esse key assignment, or click the **Browse** button to specify this information.
  - ❖ Click **OK**.
- 4 To make a popup assignment, select **Popup** to display the Application Explorer dialog box, then complete these steps:
  - ❖ Select the desired folder. The left side of the Application Explorer window displays the folders in the Programs menu. The right side lists the programs and documents in the folder. These are the items that appear in the popup list.
  - ❖ To create a popup list with items from various folders, or to pick only a few items from a folder, create a new folder containing only the desired programs and documents.

If you are unsure how to do this, refer to your Windows® XP operating system documentation.

- ❖ Click **OK** to associate the folder with the key you just selected.
- ❖ To open a popup list showing the items in that folder, press Fn plus the appropriate key from within any Windows program.

## Viewing existing key assignments

To view the existing key assignments, choose **Assignments** from the Fn-esse keyboard. Fn-esse displays the Function Key Assignments dialog box. This box lists all the key assignments and the program or document to which each key is assigned.

To view items in a popup list, click the **Expand popup lists** check box.

## Changing or removing existing key assignments

- 1 In the Fn-esse keyboard, click the key you wish to change with the secondary button.  
Fn-esse displays the Assignment Type dialog box.
- 2 To change the key assignment, click **Direct** or **Popup** and continue as if you were creating a new assignment.
- 3 To remove the key assignment, click **Clear**.

## Toshiba Hardware Setup

Toshiba Hardware Setup is the Toshiba configuration management tool available through Windows. To access it, open the **Start** menu, click **Control Panel**, then double-click **Toshiba HW Setup**.



*Sample Toshiba HWSetup window*

The tabs represent various dialog boxes. They are:

- ❖ **General**—Allows you to view current BIOS, hard disk drive and memory settings
- ❖ **Password** — Allows you to set the user password and an owner string
- ❖ **Device Config** — Shows the Device configuration options
- ❖ **Parallel/Printer** — Allows you to configure the parallel port default settings
- ❖ **Pointing Devices** — Allows you to use both the TouchPad and external pointing devices together or to have the system auto-select one

- ❖ Display — Allows you to change various default settings for the built-in LCD display
- ❖ CPU — Allows you to enable or disable accessing the processor's serial number
- ❖ Boot Priority—Allows you to change the sequence in which your computer searches the drives for the operating system.
- ❖ Keyboard — Allows you to configure an external keyboard to emulate the Fn function key
- ❖ USB — Allows you to enable or disable USB Legacy Emulation
- ❖ LAN—Allows you to set networking functions
- ❖ Hardware Alarm—Allows you to select notification settings for low battery and panel close, and to adjust the alarm volume.

By changing any of the options that appear in the dialog boxes and clicking **Apply**, you can reconfigure that function. Any options that you change will become default settings when you restart your system.

## Toshiba Power Saver

Toshiba Power Saver enhances your computer's power management capabilities. The Power Save Modes tab contains a series of settings for power management. You can change which mode your computer uses, change settings for each mode, or create your own mode.

To access Power Saver Properties:

- 1 Open the **Start** menu, then click **Control Panel**.
- 2 Double-click the **Toshiba Power Saver** icon.

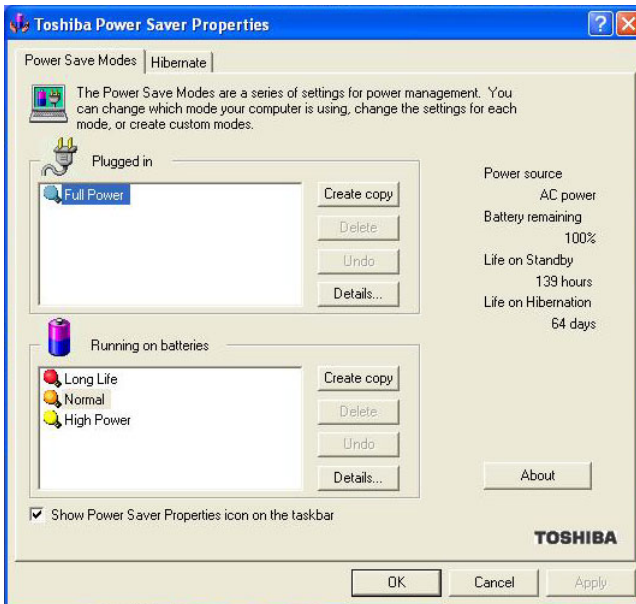

### *Sample Toshiba Power Saver Properties dialog box*

By changing the options that appear in the Toshiba Power Saver Properties dialog box and clicking **OK**, you can reconfigure that function. Any options that you change become effective when you click either **OK** or **Apply**.

# Chapter 8

## WinDVD™ 2000

---

WinDVD™ is a full-featured multimedia control center that helps you get the most out of the exciting world of DVD technology. You use it to play CDs and DVDs.

### Playing DVDs



*TECHNICAL NOTE: For optimum DVD performance, always play DVDs while your computer is connected to AC power.*

---

If your computer has a DVD-ROM, or DVD-ROM/CD-RW drive, you can use InterVideo WinDVD to play DVDs. Your computer comes with WinDVD pre installed.



*WARNING: Before playing a DVD, turn the volume down. Playing the disc at maximum volume could damage your ears. To turn the volume down, use the Volume Control program (click Start, point to All Programs, Accessories, Entertainment, and click Volume Control) or Volume Control dial.*

---



*TECHNICAL NOTE: You cannot play DVD movies on a TV and on the LCD/CRT at the same time.*

Insert a DVD into the drive, following the instructions in “[Inserting a disc](#)” on [page 80](#). The computer automatically detects the disc in the drive and opens WinDVD. If the autoplay feature is enabled, the DVD automatically begins to play (see “[Setting general properties](#)” on [page 185](#) for information on enabling autoplay).

To open WinDVD manually:

- 1** Click **Start**, and point to **All Programs**.
- 2** Point to **InterVideo WinDVD**, then click **InterVideo WinDVD**.





Time slider  
Playback speed slider  
Current chapter indicator  
Current time slot indicator

*Sample WinDVD video window with the control panel*

## Using the WinDVD toolbar

The WinDVD window contains a toolbar at the top and a status bar at the bottom. If the toolbar or status bar does not appear, you can display them by following the instructions in [“Setting general properties”](#) on page 185.

The toolbar contains basic DVD playback controls. Pause the pointer over a button to display its definition. The toolbar also contains an adjustment button (see [“Adjusting the color balance”](#) on page 194 for more information).

## Using the WinDVD status bar

The time slider enables you to rapidly move forward or backward in the DVD content. Move the time slider to the left to move backward or move it to the right to move forward. The current time slot is indicated on the right side of the status bar.

The playback speed slider enables you to control the speed at which the DVD plays. Move the slider to the left to slow the playback speed or move it to the right to play the DVD faster. Placing the slider in the center plays the DVD at normal speed, and enables the audio. The audio is automatically muted at any other playback speed.

The current chapter indicator displays the DVD chapter that is currently playing.

## Using the WinDVD control panel

The WinDVD control panel resembles the control panel of a standard home DVD player.

---



*TECHNICAL NOTE: The DVD author determines which features the DVD supports. Depending on the DVD format and the computer's hardware configuration, some of the control panel features may be unavailable when playing a DVD. Unsupported features appear gray, and you cannot select them.*

---



### *Sample WinDVD control panel*







You can open a shortcut menu by positioning the cursor anywhere in the WinDVD window, other than over the control panel, then clicking the secondary button. The shortcut menu contains the same features as the control panel, plus the enable caption feature, which displays captions for the hearing impaired.





You can also create a playlist, to customize the order in which the DVD content plays (see [“Using playlists” on page 182](#)). Once a DVD is playing, the counter displays the current chapter and elapsed time, in *hours:minutes:seconds* format.

From the WinDVD control panel, you can open an expanded control panel by clicking the expanded controls button. The expanded control panel contains several advanced features. See [“Using WinDVD advanced features” on page 189](#) for an explanation of these features.

## **Using the control panel playback buttons**

Once you have inserted a DVD and started WinDVD, you are ready to play the disc. Using the control panel, you can play a DVD from the beginning, or move to a desired location, then begin playing.

<i>Click this</i>	<i>To do this</i>	<i>Or use keyboard shortcut</i>
	Repeat — repeat the current chapter, if the DVD contains chapters. Otherwise this button repeats the DVD from the beginning. When the repeat button is activated, the repeat symbol appears to the left of the chapter number on the control panel counter. The DVD continues to repeat until you click the repeat button again, and the repeat symbol no longer displays on the control panel.	None
	<b>Eject</b> — open the DVD-ROM drive disc tray.	E
	<b>Pause</b> — temporarily stop playing a DVD.	Spacebar
	<b>Play</b> — start playing a DVD.	Spacebar
	<b>Step</b> — move forward through the DVD one frame at a time. Each time you click this button the DVD moves forward one frame.	None
	<b>Stop</b> — cease playing a DVD. After stopping the DVD, click the play button to resume playing the DVD.	End

<i>Click this</i>	<i>To do this</i>	<i>Or use keyboard shortcut</i>
	<b>Fast reverse</b> — move quickly backward through the DVD content. When you reach the desired location, click the play button to resume playing the DVD.	R
	<b>Previous</b> — move to the beginning of the previous chapter and resume playing the DVD.	PgUp
	<b>Next</b> — move to the next chapter and resume playing the DVD.	PgDn
	<b>Fast forward</b> — move quickly forward through the DVD content. When you reach the desired location, click the play button to resume playing the DVD.	F
	<b>Time</b> — move to a specific time slot, then click the play button to play the DVD from the selected location.	None

## Maximizing the video window



To close the WinDVD control panel and expand the video window to fill the screen, click the Maximize button.

To display the control panel again, double-click anywhere in the video window.

## Using playlists



*TECHNICAL NOTE: The DVD author determines which features the DVD supports. Depending on the DVD format and the computer's hardware configuration, some of the control panel features may be unavailable when playing a DVD. Unsupported features appear gray, and you cannot select them.*

A playlist is a customized list of DVD files in the order in which you want to view them. For example, you may want to create a playlist for DVDs that contain music files, so you can play the music selections you want in the order you want to hear them. You can only save one playlist at a time.

## Creating playlists



- 1 On the WinDVD control panel, click the playlist button.

The Playlist window appears.

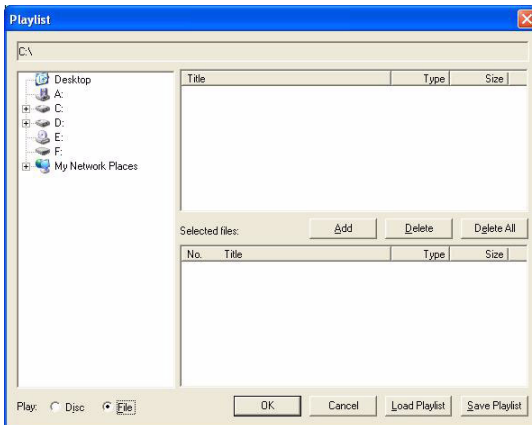

*Sample Playlist window*

- 2 Click the **File** button in the lower-right corner of the window, to indicate that you are creating a playlist of individual files.
- 3 In the **Directory** list, select the file you want to play first, and click **Add** to put it at the top of the playlist.

DVD files have an .mpg, .vob or .ac3 file name extension. After selecting a file, the file name appears in the **Selected files** list. You can also double-click a file name to add it to the playlist.

- 4 Add as many files as you wish to the playlist. You must add the files in the order in which you want to play them.

To delete a file from the playlist, select the file in the **Selected files** list, then click **Delete**. To delete the entire list and start over, click **Delete All**.

- 5 When you have finished creating your playlist, click **Save Playlist** to save it.

You do not assign a name to the saved playlist, as you can only save one playlist at a time. After saving the playlist, a confirmation dialog box appears.

- 6 Click **OK** to close the confirmation dialog box, then click **OK** to close the **Playlist** window.

## Loading and playing playlists

- 1 In the **Playlist** window, click **File** to display the saved playlist of files.

- 2 Click **Load Playlist** to load the saved playlist.

After loading the playlist, a confirmation dialog box appears.

- 3 Click **OK** to close the confirmation dialog box, then click **OK** to close the **Playlist** window.

The DVD begins to play the loaded playlist.

## Resuming normal playback after using playlists

To resume playing the DVD files in order after using a playlist, click the eject button to open the disc tray, then close it again. The DVD resumes normal playback.

## Customizing WinDVD

You can control several general WinDVD characteristics, such as whether the toolbar and status bar are visible, as well as numerous audio and display features.

You control these general, audio and display features from the Properties dialog box.

- 1 Launch WinDVD, if it is not already running.
- 2 On the WinDVD control panel, click the **Properties** button.



WinDVD displays the **Properties** dialog box, with the **General** tab on top.

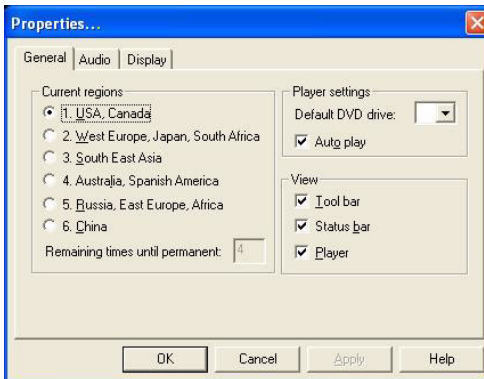

*Properties dialog box with the General tab on top*



## Setting general properties

You use the **General** tab to select the region code, the drive letter assigned to the DVD-ROM drive, the autoplay default option, and which WinDVD toolbars are displayed by default.

Region coding is part of the protection system for DVD content. It divides the world into six regions. The intent is to enable specific content to be viewed in a specific region. The current region code of the WinDVD player installed in your computer is Region 1, comprising the United States and Canada.



*NOTE: Most DVD-ROM drives let you change the region code, usually between one and five times. Once a drive has reached the limit, the region code cannot be changed again. Pay careful attention to the **Remaining times until permanent** box on the General properties tab.*

- 1 To change the region code, select the desired option in the **Current regions** list.

The **Remaining times until permanent** box displays the remaining number of times you can change the current region before the setting becomes permanent.

- 2 In the **Player settings Default DVD drive** box, select your DVD-ROM drive letter.
- 3 Select the **Player settings Auto play** check box to enable the auto play feature. Clear the check box to disable this feature.

When enabled, the auto play feature automatically launches a DVD-ROM when it is inserted in the DVD-ROM drive.

- 4 In the **View** box, select the items you want displayed when WinDVD launches.

**Tool bar** is the bar containing basic player functions that is displayed at the top of the WinDVD video window.

**Status bar** is the bar that is displayed at the bottom of the WinDVD video window.

**Player** is the WinDVD control panel.

- 5 Click **OK** to save your settings.

## Setting audio properties

---



*TECHNICAL NOTE: The DVD author determines which features the DVD supports. Depending on the DVD format and the computer's hardware configuration, some of the control panel features may be unavailable when playing a DVD. Unsupported features appear gray, and you cannot select them.*

---

- 1 Launch WinDVD, if it is not already running.
- 2 On the WinDVD control panel, click the **Properties** button.



WinDVD displays the **Properties** dialog box, with the **General** tab on top.

- 3 In the Properties dialog box, click the **Audio** tab.

The Audio tab moves to the front. The **Current audio track** box displays the format and attributes for the current audio track.

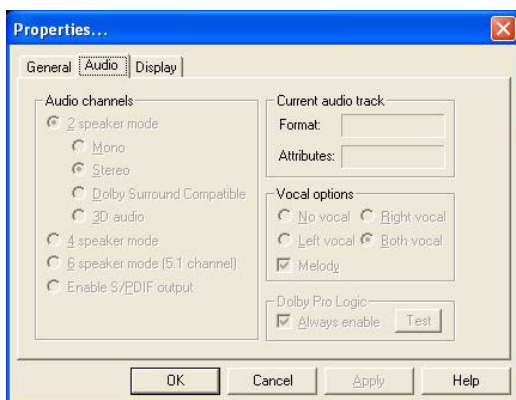

*Properties dialog box with Audio tab on top*

- 4 In the **Audio channels** box, select the appropriate speaker mode to match your setup as follows:
  - ❖ If you have two speakers, select one of the **2 speaker modes**. **Mono** mixes the audio channels into one channel. **Stereo** mixes the audio channels into two channels. **Dolby Surround Compatible** mixes the audio channels into two channels plus Dolby Pro Logic Surround sound. **3D audio** provides standard 3D audio sound.
  - ❖ If you have four speakers, select **4 speaker mode**. WinDVD distributes four unique sound channels to the speakers, providing a true surround sound experience.
  - ❖ If you have six speakers, select **6 speaker mode**. WinDVD automatically distributes 5.1 sound channels to these speakers, for enhanced surround sound.
  - ❖ If you have an S/PDIF compliant sound card, select **Enable S/PDIF output**. This option sends the stereo output through the sound card to an external receiver.
- 5 In the **Vocal options** box, select the desired option for DVDs that support vocal as follows:

- ❖ **No vocal** does not output vocals to any speaker.
  - ❖ **Left vocal** outputs vocals to left speakers only.
  - ❖ **Right vocal** outputs vocals to right speakers only.
  - ❖ **Both** outputs vocals to both left and right speakers.
- 6 In the **Dolby Pro Logic** box, select the **Always enable** check box to enable Dolby Pro Logic. Clear the check box to disable it.
  - 7 To test Dolby Pro Logic, click the **Test** button.

## Setting display properties

- 1 Launch WinDVD, if it is not already running.
- 2 On the WinDVD control panel, click the **Properties** button.



WinDVD displays the **Properties** dialog box, with the **General** tab on top.

- 3 In the Properties dialog box, click the **Display** tab.  
The **Display** tab moves to the front.

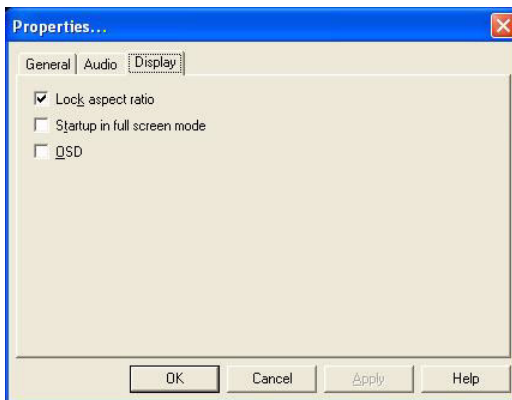

*Properties dialog box with Display tab selected*

- 4 Select the **Lock aspect ratio** check box to maintain the original aspect ratio when the video window is resized. Otherwise clear the check box.
- 5 Select the **Startup in full screen mode** check box to automatically start WinDVD each time with the video window maximized and the control panel hidden. Otherwise, clear the check box.
- 6 Select the **OSD (On Screen Display)** check box to enable OSD. Otherwise, clear the check box.
- 7 Click **OK** to save the settings.

## Customizing the control panel

You can configure the control panel's appearance. Position the pointer over the control panel, then click the secondary button to display a shortcut menu of control panel options. You can select a new control panel background color, or select **WinDVD** to display the control panel in a different format. You can also select **About** to display copyright and version information.

## Using WinDVD advanced features



*TECHNICAL NOTE: The DVD author determines which features the DVD supports. Depending on the DVD format and the computer's hardware configuration, some of the control panel features may be unavailable when playing a DVD. Unsupported features appear gray, and you cannot select them.*

The features described in this section are available on the WinDVD expanded control panel. To open the expanded control panel, click the expanded controls button on the WinDVD main

control panel. See “Using the WinDVD control panel” on page 178 for help locating the expanded controls button.



### WinDVD expanded control panel

Use this



To do this

**Directional buttons** — use to navigate the WinDVD menus, as you would the arrow keys on the keyboard. The center button represents Enter.









**Numeric keypad** — use these buttons to select a chapter by entering the chapter number. After you have entered a chapter number, click the enter button on the lower-right corner of the numeric keypad (↵) to begin playing that chapter. You can clear an entry by clicking the clear (X) button on the lower-left corner of the numeric keypad.

Or use  
keyboard  
shortcut

↑ (Up)  
→ (Right)  
↓ (Down)  
← (Left)  
Enter

0 - 9

<i>Use this</i>	<i>To do this</i>	<i>Or use keyboard shortcut</i>
	<b>Menu button</b> — displays all available menus for the current DVD. Examples of menus are: Root, Audio Language, Subtitles. Use your mouse or the control panel directional buttons to select a menu. Click <b>Resume</b> to resume DVD playback.	None
	<b>Chapter button</b> — displays a list of all the chapters in the current DVD. Select the chapter you want to play, or use the numeric keypad to enter the chapter number.	C
	<b>Title button</b> — displays a list of all the titles on the current DVD. Click the title you want to play.	T
	<b>Audio tracks</b> — displays a list of all the audio track options. This feature is most commonly used with multi-language content to change the spoken/heard language. This button is enabled only when the DVD supports dynamic audio track changes.	A

Use this	To do this	Or use keyboard shortcut
	<p><b>Subtitles</b> — displays a list of all the available language subtitles. This button is enabled only for DVD content that includes subtitles and supports dynamic subtitle information changes. Select the desired language, or select <b>Default</b> to display subtitles in the DVD's default language.</p>	S
	<p><b>Camera angles</b> — displays a list of all the available camera angles. Due to differences in the DVD mastering process, some multi-angle views may not function properly.</p>	G
	<p><b>Bookmark</b> — save an unlimited number of locations on the DVD for quick reference. On the bookmark shortcut menu, click <b>Add</b> to open the Add Bookmark dialog box. Type a bookmark name, then click <b>OK</b>. The bookmark name appears on the bookmark shortcut menu. Click the bookmark name to go to that location on the DVD. Click <b>Delete All</b> to delete all bookmarks.</p>	None



## Zooming in

You can zoom in on an area of the WinDVD video window to get a closer look.



- 1 Click the Zoom button, located in the upper-left corner of the directional button panel.
- 2 Position the cursor over the top-left corner of the area you want to view in close up.
- 3 Hold the primary button and drag the cursor to the bottom-right corner of the area you want to view in close up.

A dotted rectangle appears around the area you wish to view.

- 4 Release the primary button.

WinDVD automatically fills the window with the selected area.

## Zooming out



To return the video to normal size, click the zoom button. The video also returns to normal size when you reach the zoom limit.

## Panning

Once you are zoomed in on an area of the WinDVD video window, you can move the zoom window location using the pan feature.



- 1 With the video window in zoom mode, click the pan button, located in the lower-right corner of the directional button panel.
- 2 With the pointer over the center of the window, drag the zoomed window up, down, left or right.

The close-up view changes to reflect the new zoom window location.

## Adjusting the color balance



You can adjust the DVD color balance. Click the adjustment button on the main DVD video window toolbar to open the Adjustment dialog box.

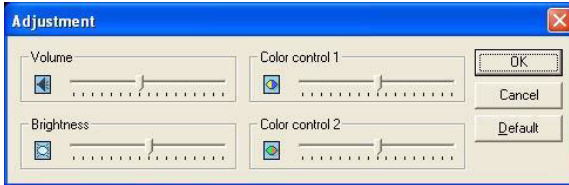

*WinDVD Adjustment dialog box*

The adjustment dialog box provides another set of sliders for adjusting volume and brightness. It also provides two color control sliders.

Move the **Color control 1** slider to the right to increase the blue and decrease the yellow color values. Move the slider to the left to increase the yellow and decrease the blue color values.

Move the **Color control 2** slider to the right to increase the red and decrease the green color values. Move the slider to the left to increase the green and decrease the red color values.

## Launching an Internet browser from WinDVD



Some DVDs contain links to Web sites. To enable these links, click the control panel Web button to launch your Internet browser.

## Getting help



Click the control panel Help button to open the WinDVD Help system.

---

## Exiting WinDVD



Click the control panel Exit button, or click the Close button, to exit WinDVD.

**- Blank Page -**

# Chapter 9

## If Something Goes Wrong

---

Some problems you may encounter when using your notebook computer are relatively easy to identify and solve. Others may require help from your dealer or the manufacturer of a software program.

This chapter aims to help you solve many problems yourself without needing additional assistance. It covers the problems you are most likely to encounter.

If all else fails, contact Toshiba. You will find information on Toshiba's support services at the end of this chapter.

### Problems that are easy to fix

#### **Your program stops responding.**

If you are working with a program that suddenly freezes all operations, chances are the program has stopped responding. You can exit the failed program without shutting down the Windows<sup>®</sup> XP operating system or closing other programs.

To close a program that has stopped responding:

- 1 Press Ctrl, Alt, and Del simultaneously (once).

The Close Program dialog box appears. This box lists all the programs and processes currently in operation. If a program has stopped responding, the words “not responding” appear beside its name in the list.

- 2 Select the program you want to close, then click **End Task**.

Closing the failed program should allow you to continue working. If it does not, continue with step 3.

- 3 Close the remaining programs one by one by selecting the program name and clicking **End Task**.
- 



*CAUTION: Pressing Ctrl, Alt, and Del simultaneously twice to restart your computer is not recommended. By closing all open programs before shutting down the operating system you ensure that all data is saved.*

---

### **Your program performs an illegal operation.**

If you receive the message, “Your program has performed an illegal operation,” you should record the details of the message and consult the software manufacturer.

To record the details:

- 1 Click the **Details** button and select the displayed text.

The Details button displays information that the software manufacturer needs to help you solve your problem.

- 2 Press Ctrl and c simultaneously to copy the text to the clipboard.
- 3 Open Notepad (click **Start**, point to **All Programs**, then point to **Accessories** and click **Notepad**).

- 4 Press Ctrl and v simultaneously to paste the details into Notepad.
- 5 Add a paragraph break and type some notes describing what you were doing when you received the message.
- 6 Save the file and refer to it when you contact the software manufacturer.

### **You open a program that immediately stops responding.**

If Standby mode is on (enabled), it may stop a program from responding. Close the program you are trying to open and turn off Standby mode. Then, try to run the program again.

To close the program:

- 1 Press Ctrl, Alt, and Del simultaneously.

The Close Program dialog box displays all the programs and processes currently in operation. If the program has stopped responding, the words “not responding” appear beside it.

- 2 Click **End Task**.
- 3 When the dialog box appears, click **End Task** again.

To turn off Standby mode:

- 1 Open the **Start** menu, then click **Control Panel**.
- 2 In the Control Panel window, double-click the **Toshiba Power Saver** icon.

The Power Saver Properties dialog box appears.

- 3 Click the **System Power Mode** tab.
- 4 In both **System stand by** drop-down lists, select the appropriate option.
- 5 Click **Apply**, then click **OK**.

## Problems when you turn on the computer

These problems may occur when you turn on the power.

### **The computer will not start.**

Make sure you attached the AC adapter and power cable properly or installed a charged battery.

Press and release the power button.

### **The computer is not accessing the hard disk or the diskette drive.**

Your computer normally loads the operating system from the hard disk. If you have a hard disk problem, you will not be able to start the computer. Insert a system diskette into the diskette drive, then press the power button.

### **The computer displays the Non-system disk or disk error message.**

Make sure there is no diskette in the diskette drive. If there is one, remove it and press any key to continue.

If pressing any key does not work, press the Ctrl, Alt, and Del keys to shut down the computer, then try restarting it.

## Windows® XP problems

Once you are familiar with the desktop and used to the way the Windows® XP operating system responds to your work routine, you can easily detect if it is not working correctly. For example:

- ❖ The Windows® XP operating system fails to start after the Starting Windows message appears.
- ❖ The operating system takes a long time to start.
- ❖ The operating system responds differently from its normal routine.
- ❖ The screen does not look right.



Unless a hardware device has failed, problems usually occur when you change the system in some way such as installing a new program or adding a device.

If you experience any of these problems, use the options in the Windows<sup>®</sup> XP Startup menu to fix the problem.

## Using startup options to fix problems

If the Windows<sup>®</sup> XP operating system fails to start properly, you may have to change your computer's configuration or verify the startup procedure to fix the problem. To do this, use the options in the Windows<sup>®</sup> XP Startup menu. This section describes each option and when to use the procedure.

To open the Startup menu:

- 1 Restart your computer.
- 2 Press F8 when your computer starts to display the Windows advanced Options menu.

The Startup menu displays these options:

- ❖ Safe Mode
- ❖ Safe Mode with Networking
- ❖ Safe Mode with Command Prompt
- ❖ Enable Boot Logging
- ❖ enable VGA Mode
- ❖ Last Know Good configuration (your most recent settings that worked)
- ❖ Directory Services Restore Mode (windows domain controllers only)
- ❖ Start Windows Normally
- ❖ Reboot

- ❖ Return to OS choices menu
- 



*TECHNICAL NOTE: If your computer is connected to a network, the Startup menu may display different versions of Safe mode.*

---

For more information, see the documentation that came with your Windows® operating system.

## Internet problems

### **My Internet connection is very slow.**

Many factors contribute to the speed with which you can surf the Internet. They include: modem speed, time of day (when everyone else is surfing, your access can be slow) and popularity of the site. If accessing a particular site is very slow, try again later.

### **My browser can't find the URL address I typed in.**

Make sure you separated the domain names of the address with the forward slash (/). Check the spelling of each name and the syntax of the address carefully. A single incorrect letter, missed period ("dot") or other mistake makes it impossible for your browser to locate the site.

### **My browser can't find a site I bookmarked.**

The World Wide Web is constantly changing. A site you bookmarked yesterday may not be available today or its server may be down for temporary repair. Try again later.

## Windows® XP operating system can help you

If the operating system has started properly, but you still have a problem using your computer, the online Help can assist you in troubleshooting the problem.

To access Windows<sup>®</sup> XP Help:

- 1** Click the **Start** button and click **Help and Support**.
- 2** Click **Fixing a Problem**.
- 3** Click **Troubleshooting Problems**.
- 4** Click the problem you want help with.

## **Troubleshooters**

The Windows<sup>®</sup> XP operating system includes a wide range of helpful troubleshooters that can assist you with many common computer problems. For instance, if you are having difficulty setting up a new printer, the Print troubleshooter can walk you through the setup process step by step. Troubleshooters are available through Windows Help, and they are constantly updated and supplemented on the Microsoft Support Online Web site.

You can connect to Support Online by clicking **Get Support** in Windows Help or by connecting to:

<http://support.microsoft.com>

## **Resolving a hardware conflict**

If you receive an error message telling you there is a device driver conflict or a general hardware problem, try using Windows<sup>®</sup> XP Help to troubleshoot the problem first.

To access Help on hardware conflicts:

- 1** From the Windows **Help** menu, click **Fixing a Problem**.
- 2** Click **Hardware and system device problems** and follow the steps.

If there is still a problem, the Windows<sup>®</sup> XP operating system should display a message that explains what the conflict is. If this happens, you may need to solve the problem on your own.

## A plan of action

The smooth operation of the system depends on the interaction of all devices, programs, and features. If the system or one of its attached devices isn't working, resolving the problem can be time-consuming and frustrating.

The recommended procedure for getting multiple devices to work together is to add and set up one device at a time. After you add each device, test it to make sure it and all previously connected devices work.

The device most recently connected to the system is the one most likely to be causing a hardware conflict.

## Resolving hardware conflicts on your own

Computer components need resources to accomplish a task. A device, such as a CD-ROM drive or a modem, needs a channel to the computer's Central Processing Unit (CPU). It also needs a direct channel to the computer's memory to store information as it works. These channels of communication are commonly referred to as system resources.

### Interrupt Request Channel

The channel to the CPU is called an Interrupt Request (IRQ) because it interrupts what the processor is doing and requests some of the processor's time. If two or more devices use the same IRQ, the processor does not know which device is asking for attention. This causes a hardware conflict.

### Direct Memory Access

Similarly, the data required by the device is stored in a specific place or address in memory called the Direct Memory Access (DMA). The DMA provides a dedicated channel for adapter cards to bypass the microprocessor and access memory directly. If two or more devices use the same DMA, the data required by one

device overwrites the data required by the other, causing a hardware conflict.

## **Plug and Play**

With Plug and Play and the Windows<sup>®</sup> XP operating system, avoiding hardware conflicts is easy. Plug and Play is a computer standard that helps the system BIOS (basic input/output system) and the operating system to automatically assign system resources to Plug and Play-compliant devices. In theory, if every device connected to the computer is Plug and Play-compliant, no two devices will compete for the same system resources. You just plug in the device and turn on your computer. The Windows<sup>®</sup> XP operating system automatically sets up your system to accommodate the new device.

However, if you install an older (legacy) device that the Windows<sup>®</sup> XP operating system cannot recognize, the operating system may have difficulty assigning system resources to it. As a result, a hardware conflict can occur. To see what resources are assigned to the device, see [“Checking device properties” on page 206](#).

## **Resolving conflicts**

There are three things you can do to resolve hardware conflicts.

- ❖ Disable the device.

For an older device, remove it from the computer. For a Plug and Play device, see [“Fixing a problem with Device Manager” on page 206](#).

- ❖ Disable another system component and use its resources for the new device. See [“Fixing a problem with Device Manager” on page 206](#).

- ❖ Reconfigure the device so that its requirements do not conflict. Refer to the device’s documentation for instructions about changing settings on the device.

## Fixing a problem with Device Manager

Device Manager provides a way to check and change the configuration of a device.



*CAUTION: Changing the default settings using Device Manager can cause other conflicts that make one or more devices unusable. Device Manager is a configuration tool for advanced users who understand configuration parameters and the ramifications of changing them.*

### Disabling a device

- 1 Click the **My Computer** icon with the secondary button, then click **Properties**.

The System Properties dialog box appears.

- 2 Click the **Hardware** tab.
- 3 Click the **Device Manager** button.
- 4 Select the device, click the **Action** menu, and choose **Disable**.

A confirmation message displays.

- 5 Click **Yes**.

### Checking device properties

Device Manager provides a way to view the properties of a device. Properties include the name of the manufacturer, the type of device, the drivers installed, and the system resources assigned to the device.

To check a device's properties:

- 1 Click the **My Computer** icon with the secondary button, then click **Properties** to display the System Properties window.
- 2 Click the **Hardware** tab.

- 3 Click the **Device Manager** button.
- 4 To view the device(s) installed, double-click the device type.
- 5 To view the properties, double-click the device.

The Device Properties dialog box appears, providing various tabs from which to choose. Some of the common ones are:

- ❖ The **General** tab, which provides basic information about the device.
- ❖ The **Driver** tab, which displays the drivers being used by the device.

For more information about Device Manager, refer to the Windows<sup>®</sup> XP online help.

## Memory card problems

Incorrectly connected or faulty memory cards may cause errors that seem to be device-related. So it is worthwhile checking for these first:

- 1 Click **Start**, then click **Turn Off Computer**.
- 2 Select **Turn Off**, then click **OK**.

The operating system shuts down and turns off the computer automatically.

- 3 Remove the memory card.
- 4 Reinstall the memory card, following the instructions in “[Installing additional memory \(optional\)](#)” on page 48, and making sure it is seated properly.
- 5 Check for the error again.
- 6 If the error recurs, remove the memory card entirely and check for the error again.

If removing the memory card eliminates the error, the memory card may be faulty. If the error recurs without the

memory card installed, the error is not caused by the memory card.

## Power problems

Your computer receives its power through the AC adapter and power cable or from the system batteries (main battery and real-time clock (RTC) battery). Power problems are interrelated. For example, a faulty AC adapter or power cable will neither power the computer nor recharge the batteries.

Here are some typical problems and how to solve them:

### **The AC power light does not come on when you plug in the AC adapter and power cable.**

Make sure the AC adapter and power cable are firmly plugged into both the wall outlet and the computer.

If the AC power light still does not come on, check that the wall outlet is working properly by plugging in a lamp or other appliance.

### **The AC adapter and power cable work correctly, but the battery will not charge.**

The battery doesn't charge while the computer is consuming full power. Try turning off the computer.

The main battery may not be inserted correctly in the computer. Turn off the computer, remove the battery, clean the contacts with a soft dry cloth (if necessary) and replace the battery.

The battery may be too hot or too cold to charge properly. Its temperature needs to be in the range 50 degrees to 88 degrees Fahrenheit (10 degrees to 30 degrees Celsius). If you think this is the probable cause, let the battery reach room temperature and try again.



If the battery has completely discharged, it will not begin charging immediately. Leave the AC adapter and power cable connected, wait 20 minutes and see whether the battery is charging.

If the battery light is glowing after 20 minutes, let the computer continue charging the battery for at least another 20 minutes before you turn on the computer.

If the battery light does not glow after 20 minutes, the battery may have reached the end of its useful life. Try replacing it.

### **The battery appears not to power the computer for as long as it usually does.**

Check the Power Saver using the Toshiba Power Saver utility. Have you added a device, such as a PC Card or memory module, that takes its power from the battery? Is your software using the hard disk more? Is the display power set to turn off automatically? Was the battery fully charged to begin with? All these conditions affect how long the charge lasts.

For more information on maximizing battery power, see [“Maximizing battery life” on page 101.](#)

## **Keyboard problems**

If, when you type, strange things happen or nothing happens, the problem may be related to the keyboard itself.

### **The keyboard produces unexpected characters.**

A keypad overlay may be on. If the numeric keypad or cursor control light is on, press Fn and F10 simultaneously to turn off the cursor control light or press Fn and F11 simultaneously to turn off the numeric keypad light.

If the problem occurs when both the keypad overlays are off, make sure the software you are using is not remapping the keyboard. Refer to the software’s documentation and check that the program does not assign different meanings to any of the keys.

**You have connected an external keyboard and you get one or more keyboard error messages.**

If you have a second keyboard, try it. If it works, the first keyboard may be defective or incompatible with your computer.

**Nothing happens when you press the keys on the external keyboard.**

You may have plugged the external PS/2 keyboard in while the computer was turned on. Using the TouchPad, click **Start**, then click **Turn Off Computer**. In the Shut down Windows dialog box, select **Restart** and click **OK**. The computer will restart and recognize the device.

**The keyboard locks and the computer will not restart.**

Make sure the power is on and press the Turn Off Computer button. Then press the power button again to turn on the computer.

## Display problems

Here are some typical display problems and their solutions:

**The display is blank.**

Display Auto Off may have gone into effect. Press any key to activate the screen.

You may have activated the instant password feature by pressing Fn and F1 simultaneously. If you have registered a password, press Enter, type your password, then press Enter. If no password is registered, press Enter. The screen reactivates and allows you to continue working.

If you are using the built-in screen, make sure the display priority is not set for an external monitor. To do this, press Fn and F5 simultaneously (once). If this does not correct the problem, press Fn and F5 simultaneously again to return the display priority to its previous setting.

If you are using an external monitor:

- ❖ Check that the monitor is turned on.
- ❖ Check that the monitor's power cable is firmly plugged into a working power outlet.
- ❖ Check that the cable connecting the external monitor to the computer is firmly attached.
- ❖ Try adjusting the contrast and brightness controls on the external monitor.
- ❖ Press Fn and F5 simultaneously to make sure the display priority is not set for the built-in screen.

### **The screen does not look right.**

You can change the display settings by clicking a blank area of the desktop with the secondary button, then clicking Properties. This opens the Display Properties dialog box. The Appearance tab of this dialog box allows you to choose the colors for the screen. The Settings tab allows you to choose the screen resolution.

### **The built-in screen flickers.**

Some flickering is a normal result of the way the screen produces colors. To reduce the amount of flickering, try using fewer colors. To change the number of colors displayed:

- 1** Point at the desktop and click with the secondary button.
- 2** Click **Properties**, and then **Settings**.
- 3** Change the Colors option and click **OK**.

For more information, see the Windows<sup>®</sup> XP Help.

### **A message indicates a problem with your display settings and that the adapter type is incorrect or the current settings do not work with your hardware.**

Reduce the size of the color palette to one that is supported by the computer's internal display. To change the display properties:

- 1 Point at the desktop and click with the secondary button.
- 2 Click **Properties**, and then **Settings**.
- 3 Change a setting and click **OK**.

For more information, see the Windows® XP Help.

### **The display mode is set to Simultaneous and the external display device does not work.**

Make sure the external monitor is capable of displaying at resolutions of 800 x 600 or higher.

## **Disk drive problems**

Problems with the hard disk or with a diskette drive usually show up as an inability to access the disk or as sector errors. Sometimes a disk problem may cause one or more files to appear to have garbage in them. Typical disk problems are:

### **You are having trouble accessing a disk, or one or more files appear to be missing.**

Make sure you are identifying the drive by its correct name (A: or C:).

Run ScanDisk, which analyzes the directories, files and File Allocation Table (FAT) on the disk and repairs any damage it finds:

To run ScanDisk:

- 1 Click **Start**, point to **All Programs, Accessories, System Tools** and click **ScanDisk**.
- 2 Click the drive you want to test.
- 3 Select the type of test you want to use.

A thorough test is more complete but takes much more time than a standard test.

- 4 Click **Start**.

ScanDisk tests the disk.

### **Your hard disk seems very slow.**

If you have been using your computer for some time, your files may have become fragmented. Run Disk Defragmenter. To do this, click **Start**, point to **All Programs, Accessories, System Tools**, and click **Disk Defragmenter**.

### **Your data files are damaged or corrupted.**

Refer to your software documentation for file recovery procedures. Many software packages automatically create backup files.

You may also be able to recover lost data using utility software, which is available from your dealer.

### **Some programs run correctly but others do not.**

This may be a software configuration problem. If a program does not run properly, review the program's hardware configuration requirements. Most software documentation lists the minimum hardware requirements.

### **A diskette will not go into the diskette drive.**

You may already have a diskette in the drive. Make sure the drive is empty.

You may be inserting the diskette incorrectly. Hold the diskette with the hub side facing down, and insert it so that the metal head window cover goes into the drive first.

The metal cover or a loose label may be obstructing the path into the drive. Carefully inspect the diskette. If the metal cover is loose, replace the diskette. If the label is loose, replace the label and try inserting the diskette again.

### **The computer displays the Non-system disk or disk error message.**

If you are starting the computer from the hard disk, make sure there is no diskette in the diskette drive.

If you are starting the computer from a diskette, the diskette in the drive does not have the files necessary to start the computer. Replace it with a bootable diskette.

**The drive can't read a diskette.**

Try another diskette. If you can access the second diskette, the first diskette (not the drive) is probably causing the problem. Run ScanDisk on the faulty diskette (for instructions, see [“Disk drive problems” on page 212](#)).

**CD-ROM/DVD-ROM drive problems****You cannot access a disc in the drive.**

Make sure the drive tray has closed properly. Press gently until it clicks into place.

Open the drive tray and remove the disc. Make sure the drive tray is clean. Any dirt or foreign object can interfere with the laser beam.

Examine the disc to see whether it is dirty. If necessary, wipe it with a clean cloth dipped in water or a neutral cleaner.

Replace the disc in the tray. Make sure it is lying flat, label side uppermost. Press the disc down until it locks on the spindle. Close the drive tray carefully, making sure it has shut completely.

**You press the disc eject button, but the drive tray does not slide out.**

Make sure the computer is connected to a power source and turned on. The CD-ROM/DVD-ROM drive eject mechanism requires power to operate.

To remove a disc without turning on the computer, use a narrow object, such as a straightened paper clip, to press the manual eject button. This button is in the small hole next to the disc eject button on the right side of the computer.

### **Some discs run correctly, but others do not.**

If the problem is with an application CD-ROM, refer to the software's documentation and check that the hardware configuration meets the program's needs.

The color of the materials used to make the disc can affect its reliability. Silver-colored CD-ROMs are the most reliable, followed by gold-colored CD-ROM. Green-colored CD-ROMs are the least reliable.

## **Sound system problems**

### **You do not hear any sound from the computer.**

Adjust the volume control.

If you are using an external headphone or speakers, check that they are securely connected to your computer.

Check to ensure that the sound function is enabled.

## **PC Card problems**

PC Cards (PCMCIA-compatible) include many types of devices, such as a removable hard disk, additional memory, or pager.

Most PC Card problems occur during installation and setup of new cards. If you're having trouble getting one or more of these devices to work together, several sections in this chapter may apply.

Resource conflicts can cause problems when using PC Cards. See ["Resolving a hardware conflict"](#) on page 203.

### **Card Information Structure**

When you insert a PC Card into a slot, the computer attempts to determine the type of card and resources it requires by reading its Card Information Structure (CIS). Sometimes the CIS contains enough information for you to use the card immediately.

Other cards must be set up before you can use them. Use the Windows<sup>®</sup> XP PC Card (PCMCIA) Wizard to set up the card. Refer to your Microsoft documentation for more information, or refer to the documentation that came with the PC Card.

Some card manufacturers use special software called *enablers* to support their cards. Enablers result in nonstandard configurations that can cause problems when installing the PC Card.

If the operating system does not have built-in drivers for your PC Card and the card did not come with a Windows<sup>®</sup> XP driver, it may not work under your operating system. Contact the manufacturer of the PC Card for information about using the card under the Windows<sup>®</sup> XP operating system.

## PC Card checklist

- ❖ Make sure the card is inserted properly into the slot.  
See “Using PC Cards” on page 161 for how to insert PC Cards.
- ❖ Make sure all cables are securely connected.
- ❖ Make sure the computer is loading only one version of Card and Socket Services.
- ❖ Occasionally a defective PC Card slips through quality control. If another PCMCIA-equipped computer is available, try the card in that machine. If the card malfunctions again, it may be defective.

## Resolving PC Card problems

Here are some common problems and their solutions:

### PC Cards that used to work no longer work.

Check the PC Card status:

- 1** Click the **My Computer** icon with the secondary button, then click **Properties**.



The System Properties dialog box appears.

- 2 Click the **Hardware** tab.
- 3 Click the **Device Manager** button.
- 4 Double-click the device listed as your PC Card.

The PC Card's Properties dialog box appears, containing information about your PC Card configuration and status.

### **The computer stops working (hangs) when you insert a PC Card.**

The problem may be caused by an I/O (input/output) conflict between the PCMCIA socket and another device in the system. Use Device Manager to make sure each device has its own I/O base address. See [“Fixing a problem with Device Manager” on page 206](#) for more information.

Since all PC Cards share the same socket, each card is not required to have its own address.

### **Hot swapping (removing one PC Card and inserting another without turning the computer off) fails.**

Follow this procedure before you remove a PC Card:

- 1 Click the **PC Card** icon on the taskbar.
- 2 Click **Stop xxxx**, where xxxx is the identifier for your PC Card.

A message tells you that you may safely remove the card.

- 3 Remove the card from the slot.

**The system does not recognize your PC Card or PCMCIA socket controller.**

This problem may be caused by a low battery. Replace the battery with a fully-charged one or charge the battery fully as follows:

- 1 Make sure the computer is not in Standby mode. For more information, see [“Using Standby” on page 98](#).
- 2 Turn off the computer.
- 3 Connect the AC adapter and power cable.
- 4 Keep the computer plugged in for two to three hours with the power turned off.

If power is not the problem, try removing the card, and reinstalling it using the procedure in [“Using PC Cards” on page 161](#).

The problem may also be caused by a conflict with any additional memory in your system. If you recently installed a memory expansion card, turn off the computer, remove the memory card, turn on the computer and try the PC Card again.

**A PC Card error occurs.**

Reinsert the card to make sure it is properly connected.

If the card is attached to an external device, check that the connection is secure.

Refer to the card’s documentation, which should contain a troubleshooting section.

**Printer problems**

This section lists some of the most common printer problems.

**The printer will not print.**

Check that the printer is connected to a working power outlet, turned on and ready (on line).

Make sure the printer cable is firmly attached to the computer and the printer.

If your printer is ECP- or IEEE 1284-compliant, make sure you have an IEEE 1284 printer cable.

Check that the printer has plenty of paper. Some printers will not start printing when there are just two or three sheets of paper left in the tray.

Run the printer's self-test to check for any problem with the printer itself.

Make sure you installed the proper printer driver, as shown in [“Connecting a printer” on page 53](#).

Try printing another file. For example, you could create and attempt to print a short test file using Notepad. If a Notepad file prints correctly, the problem may be in your original file.

Contact your network administrator if the printer is on your office network.

### **The printer will not print what you see on the screen.**

Many programs display information on the screen differently from the way they print it. See if your program has a print preview mode. This mode lets you see your work exactly as it will print. Contact the software manufacturer for more information.

## **Modem problems**

This section lists common modem problems.

### **The modem will not receive or transmit properly.**

Make sure the RJ11 cable (the one that goes from the modem to the telephone line) is firmly connected to the computer's modem port and the telephone line socket.

Check the port settings to make sure the hardware and software are referring to the same COM port (look in Device Manager under Modems for the built-in modem).

Check the communications parameters (baud rate, parity, data length and stop bits) specified in the communications program. It should be set up to transmit at 300, 1200, 2400, 4800, 9600, 14400, 28800, 33600 bps (bits per second) or higher. Refer to the program's documentation and the modem manual for information on how to change these settings.

### **The modem is on, set up properly and still will not transmit or receive data.**

Make sure the line has a dial tone. Connect a telephone handset to the line to check this.

The other system may be busy or off line. Try making a test transmission to someone else.

## **Develop good computing habits**

Make sure you are prepared.

### **Save your work frequently.**

You can never predict when your computer will lock, forcing you to close a program and lose unsaved changes. Many software programs build in an automatic backup, but you should not rely solely on this feature. Save your work! See [“Computing tips” on page 69](#) for instructions.

---

## **On a regular basis, back up the information stored on your hard disk.**

Here are some ways you can do this:

- ❖ Copy files to diskette, following the steps in “[Saving your work](#)” on page 74.
- ❖ Connect a tape drive to the system and use specialized software to copy everything on the hard disk to a tape.

Some people use a combination of these methods, backing up all files to tape weekly and copying critical files to diskette on a daily basis.

If you have installed your own programs, you should back up these programs as well as your data files. If something goes wrong that requires you to reformat your hard disk and start again, reloading all your programs and data files from a backup source will save time.

## **Read the documentation.**

It's very difficult to provide a fail-safe set of steps you can follow every time you experience a problem with the computer. Your ability to solve problems will improve as you learn about how the computer and its software work together.

Get familiar with all the documentation provided with your computer, as well as the manuals that come with the programs and devices you purchase.

Your local computer store or book store sells a variety of self-help books you can use to supplement the information in the manuals.

## Using VirtualTech

VirtualTech™ is a suite of innovative support resources and tools installed on your computer. VirtualTech will make your computing experience easier and more fulfilling by assisting you when you have questions, run into problems, or need help with your computer or programs.



To access VirtualTech, double-click the VirtualTech icon located on your computer's desktop.

Following is a summary of the kinds of resources and tools VirtualTech has to offer:

- ❖ A library of solutions to common computer problems. These are arranged into easy to navigate topics like software, hardware and the Internet.
- ❖ A set of powerful support tools that can:
  - ❖ Retrieve hardware and software details whenever you need system configuration information.
  - ❖ Check and inform you of any updates whenever you go online. To load an update, click **yes**.
  - ❖ Run a detailed system report that harvests and compiles your system's hardware and software information. This report is also accessible to Toshiba's InTouch Center technicians to reference when you place a call or send a question electronically.
  - ❖ Direct you to Ask IRIS Online™, Toshiba's instant response information service where you can ask questions and receive answers.
  - ❖ Send a message electronically with your questions directly to our InTouch Center. A representative will address your situation and contact you.

## **If you need further assistance**

If you have followed the recommendations in this chapter and are still having problems, you may need additional technical assistance. This section contains the steps to take to ask for help.

### **Before you call**

Since some problems may be related to the operating system or the program you are using, it is important to investigate other sources of assistance first.

Try the following before contacting Toshiba:

- ❖ Review the troubleshooting information in your Windows<sup>®</sup> XP documentation.
- ❖ If the problem occurs while you are running a program, consult the program's documentation for troubleshooting suggestions. Contact the software company's technical support group for their assistance.
- ❖ Consult the dealer from whom you purchased your computer and/or program. Your dealer is your best source for current information.

For the number of a Toshiba dealer near you in the United States, call: (800) 457-7777.

## Contacting Toshiba

If you still need help and suspect that the problem is hardware-related, Toshiba offers a variety of resources to help you.

- 1 Start with accessing Toshiba on the Internet using any Internet browser by typing:  
[www.pcsupport.toshiba.com](http://www.pcsupport.toshiba.com)
- 2 Next, try one of Toshiba's online services. The Toshiba Forum can be accessed through CompuServe® by typing:  
go toshiba

## Toshiba voice contact

Before calling Toshiba, make sure you have:

- ❖ Your computer's serial number.
- ❖ The computer and any optional devices related to the problem.
- ❖ Backup copies of your Windows® operating system and all other preloaded software on diskettes or CD-ROM.
- ❖ Name and version of the program involved in the problem along with its installation diskettes or CD-ROM.
- ❖ Information about what you were doing when the problem occurred.
- ❖ Exact error messages and when they occurred.

For technical support, call the Toshiba InTouch Center:

Within the United States at (800) 457-7777

Outside the United States at (949) 859-4273



## Other Toshiba Internet Web sites

<a href="http://www.toshiba.com">www.toshiba.com</a>	Worldwide Toshiba corporate site
<a href="http://www.computers.toshiba.com">www.computers.toshiba.com</a>	Marketing and product information in the USA
<a href="http://www.toshiba.ca">www.toshiba.ca</a>	Canada
<a href="http://www.toshiba-Europe.com">www.toshiba-Europe.com</a>	Europe
<a href="http://www.toshiba.co.jp/index.htm">www.toshiba.co.jp/index.htm</a>	Japan

## Toshiba's worldwide offices

### **Argentina**

Acron S.A.  
Solís 1525  
(1134) Buenos Aires  
Argentina

### **Austria**

Toshiba Europe GmbH  
Handelskai 388  
1020 Wien

### **Brazil**

Semp Toshiba Informática  
Silveria Rodrigues 52  
05047-000 Sao Paulo  
SP Brazil

### **Australia**

Toshiba (Australia) Pty. Limited  
84-92 Talavera Road  
North Ryde NSW 2113  
Sydney  
Australia

### **Belgium**

Toshiba Information Systems Benelux  
(Belgium) B.V.  
Excelsiorlaan 40  
B-1930 Zaventem  
Belgium

### **Canada**

Toshiba Canada Ltd.  
191 McNabb Street  
Markham, Ontario  
L3R - 8H2  
Canada

**Central America & Caribbean**

TechData Latin America  
8501 NW 17th Street, #101  
Miami, FL 33126  
United States

**Colombia**

CHS Promark Colombia Ltda.  
Carrera 129, Nro. 2957  
Parque Industrial de Occidente  
Bodega 30 - Zona Fontibón  
Santa Fe de Bogotá, Colombia

**Denmark**

Scribona Danmark A/S  
Naverland 27  
DK2600 Glostrup  
Denmark

**France**

Toshiba Systèmes (France) S.A.  
7, Rue Ampère  
92804 Puteaux Cédex  
France

**Greece**

Ideal Electronics S.A.  
109 Syngrou Avenue  
176 71 Kalithea  
Athens  
Greece

**Ireland**

Same as United Kingdom

**Chile**

CHS Promark Chile Ltda.  
J. Joaquin Aguirre Luco 1339  
Huechuraba  
Santiago, Chile

**Czech Republic**

CHG Toshiba, s.r.o.  
Hnevkovskeho 65  
61700 Brno

**Finland**

Scribona TPC OY  
Sinimäentie 14  
P.O. Box 83  
02630 ESPOO  
Finland

**Germany**

Toshiba Europe GmbH  
Leibnizstraße 2  
D-93055 Regensburg  
Germany

**Hungary**

Technotrade Kft.  
Szerencs utca 202  
1147 Budapest  
Hungary

**Italy**

Progetto Elettronica 92 s.r.l.  
Viale Certosa 138,  
20156 Milano  
Italy

**Japan**

Toshiba Corporation, PCO-IO  
1-1, Shibaura 1-Chome  
Minato-Ku, Tokyo, 105-8001  
Japan

**Mexico**

Toshiba de Mexico S.A.  
Sierra Candela No. 111, 6to. Piso  
Col. Lomas de Chapultepec.  
CP 11000, Mexico DF

**The Netherlands**

Toshiba Information Systems  
Benelux B.V.  
Rivium Boulevard 41  
2909 LK, Capelle a/d IJssel  
The Netherlands

**Papua New Guinea**

Fujitsu (PNG) Pty. Ltd.  
P.O. Box 4952 Boroko  
NCD, Papua  
New Guinea

**Portugal**

Quinta Grande Assistência Técnica  
Informática, Lda.  
Av. Moinhos no. 15A  
Ur. Quinta Grande  
2720 Alfragide  
Portugal

**Slovakia**

HTC a.s.  
Dobrovicova 8  
81109 Bratislava  
Slovakia

**Luxembourg**

Same as Netherlans

**Morocco**

C.B.I.  
22 Rue de Béthune  
Casablanca  
Morocco

**Norway**

Scribona Norge A/S  
Toshiba PC Service  
Stalfjaera 20  
P.O. Box 51  
Kalbakken  
0901 OSLO 9  
Norway

**Poland**

TECHMEX S.A.  
ul. Partyzantów 71,  
43-316 Bielsko-Biala  
01-059 Warszawa  
Poland

**Singapore**

Toshiba Singapore Pte. Ltd.  
438B Alexandra Rd. # 06-01  
Alexandra Technopark  
Singapore, 119968

**Slovenia**

Inea d.o.o.  
Ljubljanska 80  
61230 Domzale  
Slovenia

**Spain**

Toshiba Information Systems  
(España) S.A.  
Parque Empresarial San Fernando  
Edificio Europa, 1a Planta  
Escalera A  
28831 (Madrid) San Fernando de  
Henares  
Spain

**Switzerland**

Ozalid AG  
Herostrasse 7  
8048 Zürich  
Switzerland

**United States**

Toshiba America Information  
Systems, Inc.  
9740 Irvine Boulevard  
Irvine, California 92618  
United States

**The Rest of Europe**

Toshiba Europe (I.E.) GmbH  
Hammfelddamm 8  
D-4-1460 Neuss  
Germany

**Sweden**

Scribona PC AB  
Sundbybergsvägen 1  
Box 1374  
171 27 Solna  
Sweden

**United Kingdom**

Toshiba Information Systems  
(U.K.) Ltd.  
Toshiba Court  
Weybridge Business Park  
Addlestone Road  
Weybridge KT15 2UL  
United Kingdom

**Venezuela**

InterPC de Venezuela  
Esquina Calle 4 y Calle 8  
Edificio Tepal - Piso 3  
La Urbina  
Caracas 1073 - Venezuela

# Appendix A

## Hot Keys

---

Hot keys are keys that, when pressed in combination with the Fn key, turn system functions on and off. Hot keys have a legend on or above the key indicating the option or feature the key controls.

### Instant password security

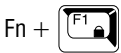

This hot key locks the keyboard and turns off the display.

To resume working, if you have registered a user password, press Enter, type your password and press Enter. If you haven't registered a password, press Enter.

Do not confuse the instant password security feature with:

- ❖ The Windows® XP operating system screen saver feature that merely blanks the display after a specified amount of time (and needs no password to resume operation),  
or

- ❖ The Toshiba Power Saver feature that turns off the display to conserve power (and needs no password to resume operation), or
- ❖ The use of an invalid Display mode hot key (Fn + F5) setting.

## Power usage mode

Fn + 

This hot key displays the power usage pop-up window and cycles through the power usage modes.

The power usage modes under battery power are: Long Life, Normal, and High Power.

The power usage modes under AC power is Full Power only.

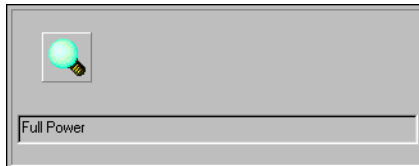

### *Sample Power usage modes*

For more information, see [“Toshiba Power Saver”](#) on page 174.

---

## Speaker sound level

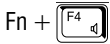

This hot key controls the system speaker sound level.

## Power-on display

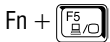

This hot key cycles through the display options.

The display options are: Built-in Display Only, Simultaneous Display, and External Monitor Only.



*TECHNICAL NOTE: In order to use simultaneous mode, you must set the resolution of the built-in display panel to match the resolution of the external display device.*

*Simultaneous mode works only with external monitors that support 640 X 480 resolution and higher.*

---

Pressing Fn and F5 three times consecutively sends a signal to the television. To start the movie, press the **Play/pause** button on the front of the computer. For more information about the Play/pause button, see [“Front panel controls” on page 37.](#)

## Keyboard hot keys

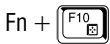

This hot key turns the cursor control overlay on and off.

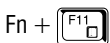

This hot key turns the numeric overlay on and off.

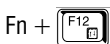

This hot key turns the scroll lock feature on and off.

**- Blank Page -**



# Appendix B

## Power Cable Connectors

The Satellite computer features a universal power supply you can use worldwide. This appendix shows the shapes of the typical AC power cable connectors for various parts of the world.

### USA and Canada



UL approved  
CSA approved

### United Kingdom

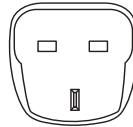

BS approved

### Australia



AS approved

### Europe



VDA approved  
NEMKO approved

**- Blank Page -**

# Glossary

---

---



*TECHNICAL NOTE: Some features defined in this glossary may not be available on your computer.*

---

## Acronyms

The following acronyms may appear in this user's guide.

<b>AC</b>	alternating current
<b>BIOS</b>	basic input/output system
<b>bps</b>	bits per second
<b>CD</b>	compact disc
<b>CD-ROM</b>	compact disc read-only memory
<b>CD-RW</b>	compact disc rewriteable memory
<b>CMOS</b>	complementary metal-oxide semiconductor
<b>COM1</b>	communications port 1 (serial port)
<b>COM2</b>	communications port 2 (serial port)
<b>CPU</b>	central processing unit
<b>DC</b>	direct current

<b>DMA</b>	direct memory access
<b>DIMM</b>	dual inline memory module
<b>DOS</b>	disk operating system
<b>DPI</b>	dots per inch
<b>DSTN</b>	dual supertwist nematic
<b>DVD</b>	digital versatile (or video) disc
<b>DVD-ROM</b>	digital versatile (or video) disc read-only memory
<b>ECP</b>	enhanced capabilities port
<b>EPROM</b>	erasable programmable read-only memory
<b>FAT</b>	file allocation table
<b>FCC</b>	Federal Communications Commission
<b>FIR</b>	fast infrared
<b>GB</b>	gigabyte
<b>HDD</b>	hard disk drive
<b>HTML</b>	Hypertext Markup Language
<b>IEEE</b>	Institute of Electrical and Electronics Engineers
<b>I/O</b>	input/output
<b>IRQ</b>	interrupt request
<b>ISP</b>	Internet service provider
<b>KB</b>	kilobyte
<b>LAN</b>	local area network
<b>LCD</b>	liquid crystal display
<b>LPT1</b>	line printer port 1 (parallel port)
<b>LSI</b>	large-scale integration
<b>MB</b>	megabyte
<b>MIDI</b>	Musical Instrument Digital Interface
<b>PC</b>	personal computer
<b>PCI</b>	Peripheral Component Interconnect
<b>PCMCIA</b>	Personal Computer Memory Card International Association
<b>RAM</b>	random access memory

---

<b>RFI</b>	radio frequency interference
<b>ROM</b>	read-only memory
<b>RTC</b>	real-time clock
<b>SCSI</b>	small computer system interface
<b>SDRAM</b>	synchronous dynamic random access memory
<b>SRAM</b>	static random access memory
<b>SVGA</b>	super video graphics adapter
<b>TFT</b>	thin film transistor
<b>USB</b>	universal serial bus
<b>URL</b>	uniform resource locator
<b>WAN</b>	wide area network
<b>www</b>	World Wide Web

## Terms

The following terms may appear in this user's guide.

### A

**active-matrix display** — A liquid crystal display (LCD) made from an array of liquid crystal cells using active-matrix technology. Also known as a "TFT display," in its simplest form there is one thin film transistor (TFT) for each cell. This type of display works well with notebook computers because of its shallow depth and high-quality color. Active-matrix displays are viewable from wider angles than most passive-matrix displays.

**adapter** — A device that provides a compatible connection between two units. For example, the computer's internal display adapter receives information from the software and translates it into images on the screen. An adapter can take a number of forms, from a microprocessor to a simple connector. An intelligent adapter (one that is capable of doing some processing) may also be called a controller.

**alternating current (AC)** — The type of power usually supplied to residential and commercial wall outlets. AC reverses its direction at regular intervals. Compare *direct current (DC)*.

**application** — A computer program that you use to perform tasks of a specific type. Applications include word processors, spreadsheets, and database management systems. See also *program*.

**B**

**backup** — A copy of a file, usually on a removable disk, kept in case the original file is lost or damaged.

**basic input/output system (BIOS)** — See *BIOS*.

**baud rate** — The speed at which a communication device, such as a printer or modem, transmits information. Baud rate is the number of signal changes per second (not necessarily the same as bits per second). See also *bits per second*.

**BIOS (basic input/output system)** — Basic instructions, stored in read-only memory (ROM), containing the information the computer needs in order to check hardware and load the operating system when you start up the computer.

**bit:** — Short for “binary digit.” A bit is the smallest unit of information used by a computer. A group of eight bits is a byte. See also *byte*.

**bits per second (bps)** — A way of measuring the speed at which information is passed between two devices. The basic measure used in modem communications, bps is similar, but not identical, to the baud rate. See also *baud rate*.

**boot** — To start the computer. The term “boot” originates from bootstrap program (as in “pulling itself up by its bootstraps”), a program that loads and initializes the operating system. See also *reboot*.

**boot disk** — See *system disk*.

**boot priority (startup sequence)** — The order in which the computer accesses its disk drives to locate the startup files. Under the default startup sequence, the computer looks for the startup files in the diskette drive before checking the hard disk.

**bus** — An electrical circuit that connects the central processing unit (CPU) with other parts of the computer, such as the video adapter, disk drives, and ports. It is the pathway through which data flows from one device to another. See also *bus speed*, *frontside bus*.

**bus speed** — The speed at which the central processing unit (CPU) communicates with the other parts of the computer.

**byte** — A sequence of eight bits. A byte is the smallest addressable unit of data. See also *bit, gigabyte, kilobyte, megabyte*.

**C**

**cache** — A section of very fast memory in which frequently used information is duplicated for quick access. Accessing data from cache is faster than accessing it from the computer's main memory. See also *CPU cache, L1 cache, L2 cache*.

**CD** — An individual compact disc. See also *CD-ROM*.

**CD-ROM (compact disc read-only memory)** — A form of high-capacity storage that uses laser optics instead of magnetic means for reading data. See also *CD*. Compare *DVD-ROM*.

**central processing unit (CPU)** — The chip that functions as the “brain” of the computer. It takes information from outside sources, such as memory or keyboard input, processes the information, and sends the results to another device that uses the information.

**character** — Any letter, number, or symbol you can use on the computer. Some characters are non-printing characters, such as a paragraph break in a word-processing program. A character occupies one byte of computer storage.

**chip** — A small piece of silicon containing computer logic and circuits for processing, memory, input/output, and/or control functions. Chips are mounted on printed circuit boards.

**click** — To press and release the TouchPad control button or mouse button without moving the TouchPad or mouse. Refers to the left mouse button or primary TouchPad control button, unless otherwise stated. See also *double-click*.

**color palette** — A set of specified colors that establishes the colors that can be displayed on the screen at a particular time.

**compatibility** — The extent to which computers, programs, or devices can work together harmoniously, using the same commands, formats, or language as another.

**configuration** — (1) The collection of components that make up a single computer system. (2) How parts of the system are set up (that is, configured).

**controller** — A device that controls the transfer of data from a computer to a peripheral device and vice versa. For example, disk drives, monitors, keyboards, and printers all require controllers.

**CPU** — See *central processing unit (CPU)*.

**CPU cache** — A section of very fast memory residing between the CPU and the computer's main memory that temporarily stores data and instructions the CPU will need to execute commands and programs. See also *cache, L1 cache, L2 cache*.

**cursor** — A symbol that indicates the current position on the screen. The shape of the cursor varies, depending on the program you're using and what you're doing.

**D**

**default** — The setting selected by a program when the user does not specify an alternative setting.

**device** — A component attached to the computer. Devices may be external (outside the computer's case) or internal (inside the computer's case). Printers, disk drives, and modems are examples of devices.

**device driver** — A program (called a "driver") that permits a computer to communicate with a device.

**dialog box** — An on-screen window displayed by the operating system or a program giving a direction or requesting input from the user.

**direct current (DC)** — The type of power usually supplied by batteries. DC flows in one direction. Compare *alternating current (AC)*.

**direct memory access (DMA)** — A dedicated channel, bypassing the CPU, that enables direct data transfer between memory and a device.

**directory** — See *folder*.

**disable** — To turn a computer option off. See also *enable*.

**disc** — A round, flat piece of metal, designed to be read from and written to by optical (laser) technology, and used in the production of optical discs, such as CDs and DVDs. Compare *disk*.

**disk** — A round, flat piece of material that can be magnetically influenced to hold information in digital form, and used in the production of magnetic disks, such as diskettes and hard disks. Compare *disc*. See also *diskette, hard disk*.



**disk drive** — The device that reads and writes information and programs on a diskette or hard disk. It rotates the disk at high speed past one or more read/write heads.

**diskette** — A thin, flexible disk in a protective jacket that stores magnetically encoded data. Diskettes can be removed from the computer and come in two sizes: 5.25-inch and 3.5-inch. Your computer uses 3.5-inch diskettes. See also *double-density diskette*, *high-density diskette*.

**document** — Any file created with an application and, if saved to disk, given a name by which it can be retrieved. See also *file*.

**double-click** — To press the TouchPad control button or mouse button rapidly twice without moving the TouchPad or mouse. Refers to the primary TouchPad control button or left mouse button, unless otherwise stated.

**double-density diskette** — A 3.5-inch diskette that can hold up to 720 KB of information (half the capacity of a high-density diskette). See also *diskette*, *high-density diskette*.

**download** — (1) In communications, to receive a file from another computer through a modem or network. (2) To send font data from the computer to a printer. See also *upload*.

**drag** — To hold down the TouchPad control button or mouse button while moving the cursor to drag a selected object. Refers to the primary TouchPad control button or left mouse button, unless otherwise stated.

**driver** — See *device driver*.

**DVD** — An individual digital versatile (or video) disc. See also *DVD-ROM*.

**DVD-ROM (digital versatile [or video] disc read-only memory)** — A very high-capacity storage medium that uses laser optics for reading data. Each DVD-ROM can hold as much data as several CD-ROMs. Compare *CD-ROM*.

**E** **emulation** — A technique in which a device or program imitates another device or program.

**enable** — To turn on a computer option. See also *disable*.

**executable file** — A computer program that is ready to run. Application programs and batch files are examples of executable files. Names of executable files usually end with a .bat or .exe extension.

**expansion device** — A device that connects to a computer to expand its capabilities. Other names for an expansion device are port expander, port replicator, docking station, or network adapter.

**extension** — See *file extension*.

**external device** — See *device*.

## F

**file** — A collection of related information, saved on disk with a unique name. A file may be a program, information used by a program, or a document. See also *document*.

**file allocation table (FAT)** — The section of a disk that keeps track of the location of files stored on the disk.

**file name** — A set of characters that uniquely identifies a file within a particular folder. It consists of two parts: the actual name and the file name extension. See also *file extension*.

**file extension** — The three characters following the period (pronounced “dot”) at the end of a file name. The extension indicates the type of file. Examples are .exe for program files and .hlp for help files. See also *file name*.

**folder** — Also called directory. A container for organizing files saved to a disk. A folder is symbolized on screen by a graphical image (icon) of a file folder. A folder can contain files and other folders.

**format** — (verb) To prepare a blank disk for use with the computer’s operating system. Formatting creates a structure on the disk so the operating system can write information to the disk or read information from it.

**frontside bus** — The primary pathway (bus) between the CPU and the computer’s main memory. Also called “system bus.” See also *bus*.

**function keys** — The keys labeled F1 through F12, typically located on the keyboard. Their function is determined by the operating system and/or individual programs.

## G

**gigabyte (GB)** — A unit of data equal to 1,073,741,824 bytes (1024 x 1024 x 1024 bytes). See also *byte*.

**ground** — A conductor to which all components of an electric circuit are connected. It has a potential of zero (0) volts, is connected to the earth, and is the point of reference for voltages in the circuit.

**H**

**hard disk** — A storage device composed of a rigid platter or platters that can be magnetically coded with data. Hard disks hold much more information than diskettes and are used for long-term storage of programs and data. The primary (or only) hard disk in a computer is usually fixed, but some computers have secondary hard disks that are removable. By default, the primary hard disk is referred to as drive C.

**hardware** — The physical components of a computer system. Compare *software*.

**Hibernation** — A feature of many Toshiba notebook computers that saves to the hard disk the current state of your work, including all open files and programs, when you turn the computer off. When you turn on the computer again, your work is returned to the same state it was when the computer was turned off. See also *Standby*, *Suspend*.

**high-density diskette** — A 3.5-inch diskette that holds 1.44 MB of data. See also *diskette*.

**hot key** — (1) A feature in which certain keys in combination with the Fn key can set system options or control system parameters, such as the battery save mode. (2) A key or combination of keys that activates a memory resident program.

**hot swapping** — The ability to add or remove devices from a computer while the computer is running and have the operating system automatically recognize the change.

**icon** — A small image displayed on the screen that represents a function, file, or program.

**interlaced** — A method of refreshing a computer screen, in which only every other line of pixels is refreshed. Interlaced monitors take two passes to create a complete screen image. Compare *non-interlaced*.

**internal device** — See *device*.

**Internet** — The decentralized, world-wide network of computers that provides electronic mail, the World Wide Web, and other services. See also *World Wide Web*.

**K**

**keyboard shortcut** — A key or combination of keys that you use to perform a task instead of using a pointing device such as the TouchPad.

**kilobyte (KB)** — A unit of data equal to 1024 bytes. See also *byte*.

**L**

**L1 (level one) cache** — Memory cache built into the processor to help improve processing speed. See also *cache*, *CPU cache*, *L2 cache*.

**L2 (level two) cache** — Memory cache installed on the motherboard to help improve processing speed. It is slower than L1 cache and faster than main memory. See also *cache*, *CPU cache*, *L1 cache*.

**LAN (local area network)** — A group of computers or other devices dispersed over a relatively limited area and connected by a communications link that enables any device to interact with any other on the network.

**liquid crystal display (LCD)** — A type of display that uses a liquid substance between two transparent electrode panels. When an electric current passes through the electrodes, the molecules in the liquid form a crystalline pattern that polarizes the light passing through it. A filter over the electrodes permits only non-polarized light to pass to the surface of the display, creating light and dark pixels.

**load** — To move information from a storage device (such as a hard disk) into memory for processing.

**local area network** — See *LAN*.

**logical drive** — A section of a disk that is recognized by the operating system as a separate disk drive. A system's logical drives may differ from its physical drives. For example, a single hard disk drive may be partitioned into two or more logical drives.

**M**

**megabyte (MB)** — A unit of data equal to 1,048,576 bytes (1024 x 1024 bytes). See also *bytes*.

**memory** — Typically refers to the computer's main memory, where programs are run and data is temporarily stored and processed. Memory can be volatile and hold data temporarily, such as RAM, or it can be nonvolatile and hold data permanently, such as ROM. A computer's main memory is RAM. See *RAM*, *ROM*.

**microprocessor** — See *central processing unit (CPU)*.

**MIDI (Musical Instrument Digital Interface)** — A standard for connecting musical instruments, synthesizers, and computers. The MIDI standard provides a way of translating music into a form computers can use, and vice versa.

**modem** — Short for “modulator/demodulator.” A device that converts information from digital to analog and back to digital, enabling information to pass back and forth between digital computers and analog telephone lines.

**motherboard** — The main circuit board in the computer. It contains the processor, memory, and other primary components.

**MS-DOS prompt** — See *system prompt*.

**multimedia** — A combination of two or more media, such as sound, animation, and video in a computer program or presentation.

**Musical Instrument Digital Interface** — See MIDI.

## N

**network** — A collection of computers and associated devices that are connected by communications facilities. A network allows you to share data and peripheral devices, such as printers, with other users and to exchange electronic mail.

**non-interlaced** — A method of refreshing a computer screen, in which each pixel of every line is refreshed as the electron beam scans across and down the screen. Compare *interlaced*.

**non-system disk** — A disk for storing programs and data that cannot be used to start the computer. Compare *system disk*.

## O

**online** — Available through the computer. Online may refer to information being read from your own computer’s hard disk, such as online documentation or online help, or to information coming from another company on a company network or the Internet.

**operating system** — A set of programs that controls how the computer works.

## P

**palette** — See *color palette*.

**parallel** — Processes that occur simultaneously. In communications, it means the transmission of more than one bit of information at a time. On your computer, the parallel port provides a parallel communications interface between the computer and an appropriate device. Most modern printers are parallel. Compare *serial*.

**password** — A unique string of characters entered by a user to verify his or her identity to the computer or the network.

**PC Card** — A credit-card-sized expansion card designed to increase the capabilities of notebook computers. PC Cards provide functions such as modem, fax/modem, hard disk drive, network adapter, sound card, or SCSI adapter.

**peripheral** — Any device, such as a printer or joystick, that is attached to the computer and controlled by the computer's CPU.

**pixel** — Short for "picture element." The smallest dot that can be produced on a screen or printer.

**Plug and Play** — Generally, refers to the computer's ability to automatically configure itself to work with peripheral devices. When capitalized, refers to a standard that, when followed by a device manufacturer, allows a PC to configure itself automatically to work with the device.

**pointing device** — Any device, such as the TouchPad or a mouse, that enables you to move the cursor on the screen.

**port** — A socket on the computer where you plug in a cable for connection to a network or a peripheral device.

**processor** — See *central processing unit (CPU)*.

**program** — A set of instructions that can be executed by a computer. The general classes of programs (also called software) are operating system, application, and utility. See also *operating system*, *application*, *utility*.

**properties** — The attributes of an object or device. For example, the properties of a file include the file's type, size, and creation date.

**R**

**RAM (random access memory)** — Volatile memory that can be written to as well as read. By volatile, we mean that information in RAM is lost when you turn off your computer. This type of memory is used for your computer's main memory. See also *memory*. Compare *ROM*.

**random access memory** — See *RAM*.

**read-only memory** — See *ROM*.

**reboot** — See *boot, restart*.

**removable disk** — A disk that can be removed from a disk drive. A diskette is one example of a removable disk.

**resolution** — A measure of the sharpness of the images that can be produced by a printer or displayed on a screen. For a printer, resolution is expressed in dots per inch (dpi). For a screen, it is expressed as the number of pixels available horizontally and vertically.

**restart** — Synonymous with reboot. To reset the computer by reloading the operating system without turning the computer off. See also *boot*.

**RJ11** — A modular connector used on most U.S. telephone systems and direct-connect modems. The RJ11 connector is a 6-wire connector.

**ROM (read-only memory)** — Non-volatile memory that can be read but not written to. By non-volatile, we mean that information in ROM remains whether or not the computer is receiving power. This type of memory is used to store your computer's BIOS, which is essential instructions the computer reads when you start it up. See also *BIOS, memory*. Compare *RAM*.

**S**

**select** — To highlight or otherwise specify text, data, or graphics with the intent to perform some operation on it.

**serial** — Processes that occur one at a time. In communications, it means the transmission of one bit at a time sequentially over a single channel. On your computer, the serial port provides a serial interface between the computer and an appropriate device. Compare *parallel*.

**shortcut** — See *keyboard shortcut*.

**software** — See *program*. Compare *hardware*.

**Standby** — A feature of some Windows® operating systems that allows you to turn off the computer without exiting your open applications and to continue from where you left off when you turn the computer on again.

**Suspend** — A feature of some Windows® operating systems that allows you to turn off the computer without exiting your open applications and to continue from where you left off when you turn the computer on again.

**system disk** — A diskette that contains the operating system files needed to start the computer. Any diskette can be formatted as a system disk. A system disk is also called a “bootable disk” or a “startup disk.” Compare *non-system disk*.

**system prompt** — The symbol (in MS-DOS, generally a drive letter followed by a “greater than” sign) indicating where users are to enter commands.

**TFT display** — See *active-matrix display*.

**universal serial bus (USB)** — A serial bus that supports a data transfer rate of up to 12 Mbps (12 million bits per second). USB can connect up to 127 peripheral devices through a single all-purpose USB port. USB allows hot swapping of peripherals. See also *bus*, *hot swapping*, *serial*.

**upload** — To send a file to another computer through a modem or network. See also *download*.

**USB** — See *universal serial bus (USB)*.

**utility** — A computer program designed to perform a narrowly focused operation or solve a specific problem. Utilities are often related to computer system management.

**Web** — See *World Wide Web*.

**Wi-Fi** — A trademarked term by the Wireless Capability Ethernet Alliance which stands for Wireless Fidelity. Wi-Fi is another term for the IEEE 802.11b communication protocol to permit an Ethernet connection using wireless communication components.



**World Wide Web (www)** — The worldwide network of Web sites linked together over the Internet. A user of the Web can jump from site to site regardless of the location of the computer hosting the site. See also *Internet*.

**- Blank Page -**

# Index

---

## A

- AC adapter 54
  - connecting the power cable 55
- AC power
  - cable connectors 233
  - light 36
  - problem solving 208, 209
- adding
  - background to a window 144
- additional memory 48
  - installing 48
- alarm
  - setting levels 105
  - types 105
- Alt key 71
- Application key 72
- As Web Page option 144
- Ask IRIS Online 222
- audio CDs
  - playing 38, 78
- audio features 158
- avoiding strain and injury 42, 43, 45

## B

- battery 55, 103
  - additional packs 100
  - alarm 105
  - charging 54, 56, 66, 101
  - charging before use 47
  - conserving power 104
  - cover 40
  - determining remaining power 37, 103
  - inserting into computer 107
  - light 37, 58, 103
  - Li-Ion (lithium ion) 100
  - low charge 104
  - main 100
  - maximizing life 101
  - problem solving 208, 209
  - release latch 40
  - removing 106
  - RTC (real-time clock) 100
  - safe disposal 107
  - safety precautions 100
- buttons

- CD Player 37, 84, 85
- CD/DVD controls 79
- DVD-ROM drive eject 80
- Restore 124
- speaker volume control 85

## C

- caps lock light 35
- Card and Socket Services 162
- care and handling
  - compact discs 87
  - diskettes 77
  - your computer 67
- CD Player
  - next track button 38, 84, 85
  - play/pause button 37, 84
  - previous track button 37, 84, 85
  - stop/eject button 37, 84
- CD Player control panel 85
- CD/DVD control buttons 79
  - stop/eject 81
- CD-ROM drive 31, 78
  - manual eject button 81
  - problem solving 214
- CD-ROMs
  - using 78
- CDs
  - care and handling 87
  - problem solving 215
- charging 56
  - main battery 102
  - RTC 103
- checking device properties 206
- CIS (Card Information Structure) 215
- closing programs 125
- COM port 150
  - modem connection 150
- comfort
  - arms and wrists 45
  - lighting 44
  - seating and posture 43
  - work habits 45
- commands
  - Hibernation 93
  - Shut down 93
  - Standby 94
- communications
  - cable-free 29
  - network connection 147
  - ports 150
  - setting up 87
- compact discs
  - care and handling 87
- computer 69
  - cleaning 67
  - customizing settings 65
  - moving 67
  - placement 41, 43
  - powering on 57
  - setting up 60
  - transferring information 148
  - turning off 93, 95, 96, 98
  - using at the office 147
- computing tips 220
- connecting
  - external monitor 147
  - external speakers 161
  - headphones 161
  - microphone 158
  - mouse 52
  - to a network 90
- conserving battery power 104
- contacting Toshiba 224
- cooling vents
  - CPU 32
- copying files to a diskette 77
- CPU 204
- creating
  - new documents 117
  - new folders 119

- shortcuts
  - Calculator 126
  - Character Map 127
- critical battery alarm 105
- Ctrl key 71
- Current time 113
- cursor control
  - mode light 35
  - overlay 73
    - hot key 231
- customizing
  - computer settings 65
  - taskbar 142
  - window toolbars 144

**D**

- date and time 131
- DC-IN jack 29
- desktop 110
  - background 110
  - choosing style and browsing
    - options 143
  - removing objects 132
  - Web style 144
  - windows 122, 123, 124
- determining remaining battery power 103
- Device Manager
  - check/change device properties 206
  - configuration tool 206
  - disabling a device 206
- device properties 206
- dial-up connection 91
- Dial-Up Networking Wizard 91
- Digital Subscriber Lines (DSL) 149
- Digital Versatile Discs 79
- Direct Memory Access 205
- disabling a device 206
- disk activity light 37
- disk error 213

- diskette drive 76
  - problem solving 214
- diskettes 76
  - care and handling 77
  - inserting and removing 76
- display panel
  - latch 28, 57
- display screen
  - hot keys 231
  - options 231
  - problem solving 210
  - resolution 34
- displaying folder information 146
- DMA (Direct Memory Access) 205
- documents
  - creating new 117
- drive-access light 37
- DVD-ROM drive
  - eject button 80
  - inserting a disc 80
  - playing
    - CDs and DVDs 78
- DVD-ROM/CD-RW drive 78
- DVDs 79

**E**

- ECP (Extended Capabilities Port) 30
- email 154
- emulating a full-size keyboard 165
- ergonomics 42, 43, 44, 45
- error messages 213
  - device driver conflict 203
  - disk error 200
  - general hardware problem 203
  - Non-system disk 200, 213
- Ethernet 10/100 Ethernet LAN adapter 90
- expansion memory modules
  - cover 40
- Extended Capabilities Port 30

external monitor

connecting 147

external speakers 161

eyestrain

avoiding/reducing 44, 45

## F

FAT (File Allocation Table) 212

files

backing up 77

copying to diskette 77

hierarchal file system 113

naming 75

printing 75

saving 74

transferring 148

Fn key 71, 165

assigning functions 169

Fn-esse 167

assigning keys 169

change/remove key assignments  
171

drag-and-drop 169

keyboard 168

starting 168

using keyboard or pointing device  
170

viewing key assignments 171

folder

creating new 119

folders

displaying information 146

front panel controls 35

function keys 71

## G

guidelines

posture 44

proper lighting 44

seating 44

## H

hard disk drive

backing up 221

light 58

problem solving 213

hardware conflicts

DMA assignments 205

IRQ (Interrupt Request) channel  
204

older (legacy) device 205

Plug and Play 205

resolving 205

headphone jack 161

headphones

connecting 161

jack 30

Help facility 135

Hibernation 93, 96

factors to consider 93

quick 97

restarting 94, 97

hot keys

display options 231

keyboard controls 231

password security 229

hot swapping 162

precautions 164

Hypertext Transfer Protocol (HTTP)

153

## I

icons 111

definitions 24, 25

safety 24

infrared port 29

inserting

charged battery 107

diskettes 76

PC Cards 162

Internet 87, 153

- chat rooms 154
- connecting to 149
- downloading files 154
- news groups 154
- overview 152
- problem solving 202
- uploading files 154

Internet Explorer 111

Interrupt Request channel 204

InTouch Center 222

IRQ (Interrupt Request)  
channel 204

ISP (Internet Service Provider) 116

## J

jacks

- external speakers 30
- headphone 30
- microphone 29

## K

keyboard 35, 71

- 85-key 35
- caps lock key 71
- caps lock light 35
- character keys 71
- Ctrl, Fn, and Alt keys 71
- cursor control overlay 35, 73
  - hot key 231
- emulating full-size 165
- Fn-esse 168
- function keys 71
- numeric overlay 35, 72
  - hot key 231
- overlay keys 72
- problem solving 209
- scroll lock
  - hot key 231
- Windows special keys 72

## L

LAN (Local Area Network)

- adapter 90
- port 29

lighting 44

lights

- battery 58, 103
  - current charge 37, 103
- caps lock 35
- cursor control mode 35, 73
- disk activity 37
- drive-access 37
- hard disk drive 58
- main battery 37, 103
- numeric mode 35, 72
- power on/off 36
- system indicator 35

Li-Ion (Lithium Ion) 100

locking cable 32

low battery alarm 105

## M

main battery 100, 102

- charging before use 101
- maximizing battery life 101

memory

- installing additional 48
- problem solving 207
- removing module 50

memory slot cover 40

microphone

- connecting external 158
- jack 29
- recording sounds 158

modem

- connecting to a phone line 88
- determining the COM port 150
- port 31

modes

- Power usage 99

- Safe 201
- Standby 105
- monitor
  - connecting 147
  - connecting an external 30
  - port 30
- monitoring battery power 103
- mouse 52
  - connecting 52
  - PS/2 52
  - USB 52
- My Computer 73, 111
- My Documents 111
- N**
- naming files 75
- network
  - accessing 147
  - connecting to 90
  - dial-up connection 91
  - Dial-Up Networking Wizard 147
- Notepad 117
- numeric mode light 35
- numeric overlay 35, 72
  - hot key 231
- O**
- on/off light 36
- opening a Web page 116
- operating system 109
- optional devices
  - battery pack 100
- overlay keys 72
  - cursor control 73
  - numeric 72
- P**
- Paint program 121
- parallel port 30
- parallel printer 30
- password security
  - hot key 229
- PC Card
  - Card and Socket Services 162
  - eject buttons 32
  - enablers 216
  - inserting 162
  - problem solving 215, 216, 217
  - removing 164
  - replacing 164
  - slots 32
  - Type I, Type II, or Type III 32
  - using 161
- PCMCIA 32
- PCMCIA (Personal Computer Memory Card International Association) 161
- playing
  - CDs and DVDs 81
- Plug and Play 205
- pointing device
  - TouchPad II 35
- PORT-Noteworthy Computer Lock 32
- ports
  - communication 150
  - external monitor 30
  - infrared 29
  - LAN 29
  - modem 31
  - parallel 30
  - S-video out 29
  - USB 30
- power
  - alarm 105
  - button 35
  - cable connectors 233
  - DC-IN jack 29
  - on/off 35, 57
  - problem solving 208
  - usage mode 99
- power down options



- Hibernation 93, 96
- Shut down 93, 95
- Standby 93, 98
- power off
  - guidelines 66
- Power Options utility 96, 199
- Power usage mode 99, 113
- power-on display
  - hot key 231
- precautions 46
- presentations
  - viewing on television set 156
- printer
  - Add Printer Wizard 62
  - connecting 53
  - problem solving 218, 219
  - selecting mode 53
- printing your work 75
- problem
  - prevention 220
  - solving 197, 209, 215
- program
  - starting 73
- programs
  - Web browsers 153
- PS/2
  - external keyboard 29
  - mouse 29, 52
  - port 29

**Q**

- Quick Start card 27

**R**

- real-time clock battery 100, 103
- recording
  - adjusting quality 159
  - sounds 158
- Recycle Bin 111, 132
- region code 185

- removing
  - diskettes 76
  - objects from the desktop 132
  - PC Cards 164
  - the battery 106
- resolving hardware conflicts 203, 204, 205
- restarting the computer
  - from Hibernation 97
  - from Shut down 96
  - from Standby 98
- Restore button 124
- RTC (real-time clock) battery 100
- RTC battery 103
  - recharging 103

**S**

- Safe mode 201
- safety precautions 46
  - battery 100
    - disposal 107
- saving your work 74
- ScanDisk 212
- screen
  - problem solving 210
  - resolution 34
- scroll lock
  - hot key 231
- SCSI (Small Computer Systems Interface) 165
- Search Engine 153
- security
  - instant password hot key 229
  - lock slot 32
  - locking cable 68
  - PORT-Noteworthy Computer Cable Lock 68
  - PORT-Noteworthy Computer Lock 32
- SelectServ 26

setting the date and time 131

setting up

    computer 60, 61

    printer 62

    software 60

    work environment 42

setting up your computer 47

settings

    customizing the computer 65

shortcut tray 110

shortcuts

    creating 126

Shut down 93, 95

    quick 96

    restarting 93, 96

software

    setting up 60

sound

    .wav files 158

    problem solving 215

SPANworks 155

speakers

    external 161

    jack 30

    volume control 85

Standby 93, 94, 98

    mode 105

    restarting from 94, 98

Start button 110, 112

starting a program 73, 120

Startup menu 201

stop/eject button 81

Support Online 203

system indicator panel

    lights 35

System Restore

    using 134

system tray 110

    tasks 113

## T

taskbar 110, 112

    customizing 142

    using 123

technical support

    Toshiba InTouch Center 224

tips on computing 69

toolbars

    customizing 144

    displaying in a window 146

Toshiba Accessories

    information 25

    Web site 67

Toshiba Forum 224

Toshiba FreedomWare 112

Toshiba Hardware Setup 172

Toshiba Internet Web sites 225

Toshiba InTouch Center 224

Toshiba online

    services 224

Toshiba Power Saver 174

    Hibernation 97

    Shut down 96

    Standby 98

Toshiba Software Offer 111

Toshiba VirtualTech 111

Toshiba voice contact 224

Toshiba worldwide offices 225

TouchPad 52

    control buttons 35

    pointing device 35

    using 114

trackball 52

transferring files 148

transferring information between

    computers 148

troubleshooters

    Windows 203

troubleshooting 197

    AC/power

- battery will not charge 208
  - faulty adapter or cable 208
  - light does not come on 208
  - partially charged battery 209
  - batteries 208
  - CD-ROM drive 214, 215
  - data files 213
  - device properties 206
  - disabling a device 206
  - disk drive
    - files missing 212
    - Non-system disk or disk error 200, 213
    - slow 213
  - diskette drive
    - can't insert diskette 213
    - can't read diskette 214
  - display 210
  - external monitor 211
  - faulty AC adapter 208
  - faulty power cable 208
  - further assistance 223
  - hardware conflict 203, 204, 205
  - hot swapping 217
  - Internet 202
  - keyboard
    - locks and computer won't restart 210
    - unexpected characters 209
  - memory cards 207
  - modem 219
  - PC Card 215, 216, 217, 218
    - checklist 216
    - error 218
  - power problems 208
  - printer 218
    - will not print 219
  - program doesn't run 213
  - program performed illegal operation 198
  - program stops responding 197, 199
  - screen display
    - blank 210
    - doesn't look right 211
    - external device does not work 212
    - problem with display settings 211
    - screen flickers 211
  - sound 215
  - sound system 215
  - Windows Millennium Edition 200, 201
  - turning computer on/off 57, 93, 95, 96, 98, 125
  - turning off the computer 66
- U**
- Uniform Resource Locator (URL) 142, 153
  - universal power supply 233
  - Universal Serial Bus
    - mouse 52
    - port 30
    - ports 30
  - URL (Uniform Resource Locator) 142, 153
  - USB
    - port 30
  - USB (Universal Serial Bus)
    - mouse 52
    - port 30
  - using
    - PC Cards 161
  - utilities
    - Toshiba Power Saver 96, 97, 98
- V**
- video features
    - exploring 156
  - VirtualTech 222
  - volume, adjusting 161

## W

World Wide Web 153

warranty

    SelectServ 26

wav files

    recording 158

Web address 153

Web browsers 153

Web sites 203, 224

    opening a page 116

Web style 144

Wi-Fi

    wireless networking 147

windows

    adding a background 144

    minimizing and maximizing 123

    resizing and moving 122, 124

Windows Explorer 73

Windows Help

    Support Online 203

    troubleshooters 203

Windows logo key 72

Windows XP

    Briefcase 148

    fails to start 200

    Help 135, 203

    Preview 137

    special features 141

    Startup menu 201

    Shut Down 139

    Tours and Tutorials 137

WinDVD

    customizing 184

    optional settings 182

    region code 185

    starting 176

wireless networking 147

Wizards

    Add Printer 62

    Dial-Up Networking Wizard 147

work environment considerations 41



## Free Manuals Download Website

<http://myh66.com>

<http://usermanuals.us>

<http://www.somanuals.com>

<http://www.4manuals.cc>

<http://www.manual-lib.com>

<http://www.404manual.com>

<http://www.luxmanual.com>

<http://aubethermostatmanual.com>

Golf course search by state

<http://golfingnear.com>

Email search by domain

<http://emailbydomain.com>

Auto manuals search

<http://auto.somanuals.com>

TV manuals search

<http://tv.somanuals.com>