

# Owners Manual

TEC LOAD CELL SCALE  
**MODEL SL39N SERIES**  
(US. Version)

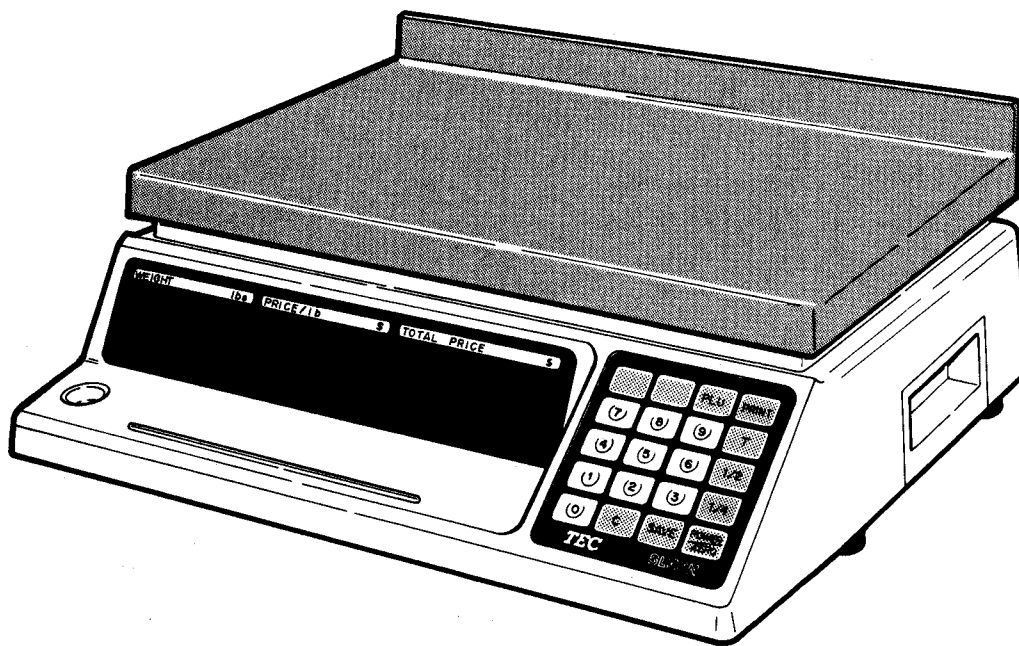

**TEC** TOKYO ELECTRIC CO., LTD.

**WARNING**

This equipment generates, uses, and can radiate radio frequency energy and if not installed and used in accordance with the instructions manual, may cause interference to radio communications. It has been tested and found to comply with the limits for a Class A computing device pursuant to Subpart J of Part 15 of FCC Rules, which are designed to provide reasonable protection against such interference when operated in a commercial environment. Operation of this equipment in a residential areas likely to cause interference in which case the user at his own expense will required to take whatever measures may be required to correct the interference.

## 9. BEFORE YOU CALL FOR SERVICE

It is our primary concern to give you full satisfaction and better service. If, however, any problem arises in connection with the operation of this scale, please check the following points once more before calling for service:

- A) Is the power plug fully inserted into AC outlet ?
- B) Is the power switch turned ON ?
- C) Is AC power being properly supplied to outlet ? (Check it using other electric appliance.)
- D) Check circuit breaker.
- E) Has there been a power failure of any sort ?
- F) Has the operation been carried out in the correct order ?

This scale has been manufactured under strict quality control. If you have trouble, however, DO NOT TRY TO FIX IT BY YOURSELF. Pull the power plug out of the AC outlet, and contact your TEC representative.

### CAUTION:

The specifications given in this manual may be modified by TEC, if necessary.

1. Do not subject the weighing platter to sudden shocks.
2. Do not pour water directly on scale.



3. Clean the cover and weighing platter by wiping with a dry and soft cloth.
4. Do not use thinner or other volatile solvent for cleaning.

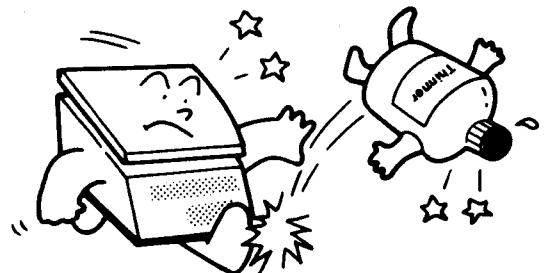
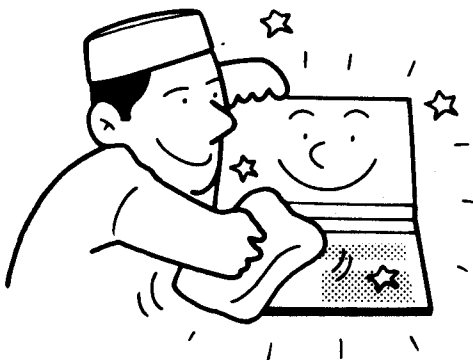

**WARNING**

This equipment generates, uses, and can radiate radio frequency energy and if not installed and used in accordance with the instructions manual, may cause interference to radio communications. It has been tested and found to comply with the limits for a Class A computing device pursuant to Subpart J of Part 15 of FCC Rules, which are designed to provide reasonable protection against such interference when operated in a commercial environment. Operation of this equipment in a residential areas likely to cause interference in which case the user at his own expense will required to take whatever measures may be required to correct the interference.

## 2. OVERVIEW

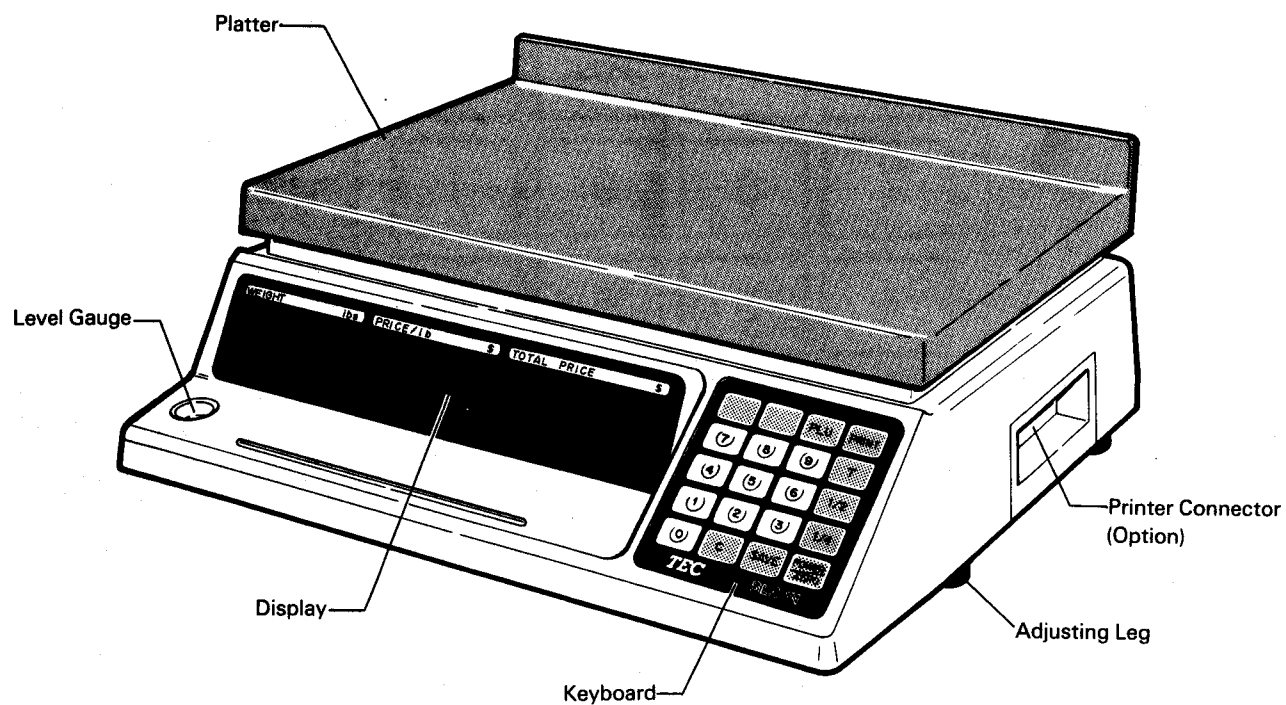

## 3. DISPLAY

### Operator's View

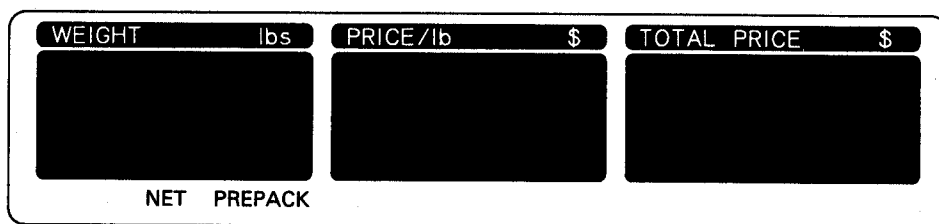

### Customer's View



## INTRODUCTION

We thank you very much for purchasing our TEC Electronic SL39N Series Scale. This series has been designed with TEC reliability and in consideration of future upgradability.

This model uses a new method which allows weighing without any movement of the platter, thus providing far greater accuracy. This method also allows you, the user, to change the unit price while the commodity is on the platter simply by depressing the numeric keys; and to subtract tare weight by a single depression of the T key.

Other functions are available on this unit, such as Tare Presetting. With the added feature of a micro-computer in the electronic calculation circuit, we believe that your needs will now be fully satisfied, and you will have total reliability in price calculation.





This manual will help to acquaint you with the proper operation and care of the SL39N series scale. Please keep it handy for future reference.

## PRECAUTIONS

1. DO NOT SUBJECT the weighing platter to SUDDEN SHOCKS.
2. DO NOT DEPRESS THE KEYS TOO HARD. Keys will operate correctly if they are merely touched lightly.
3. Clean the cover and weighing platter by wiping with a dry cloth or a cloth soaked with detergent and wring out thoroughly. NEVER USE THINNER OR OTHER VOLATILE SOLVENT FOR CLEANING.
4. This machine has been made drip-proof, but DO NOT POUR WATER directly on it.
5. To insure scale is operating correctly, place a known weight on platter and check for correct computing. This should be done every morning before starting normal operations.
6. When in use, avoid locations subject to vibration and direct sunlight.

## 1. SPECIFICATIONS

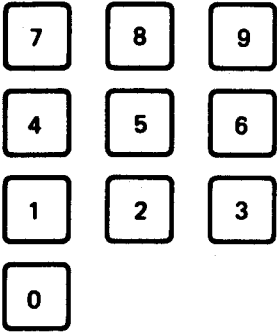
Items	SL39-30L-N-US
Maximum Capacity	30 lbs
Minimum Scale Division	0.01 lbs
Using Weight Range	0.01 ~ 30 lbs
Display Range	0.01 ~ 30.05 lbs
Tare	Up to 30 lbs
Unit Price Presetable	\$0.01 ~ 99.99
Minimum Price Display	\$0.01
Display:	
Weight	5 digits (including negative sign)
Unit Price	4 digits
Total Price	5 digits
Display Designations	NET, PREPACK
Display Mode	Both sides
Power Requirement	AC 120V $\pm$ 10%, 60 Hz
Current Consumption	120V · 0.2A, 60Hz
Operating Environment:	
Temperature	32° ~ 104°F
Relative Humidity	35% ~ 85% RH (No condensation)
Dimensions (approx.)	13.8" (W) x 13.3" (D) x 6.3" (H)
Weight	17.1 lbs
Printer Interface (Option)	TEC Scale Printer H-7, H-18

Name of Key & Lamp	Function
TARE Key 	1) Used to subtract tare weight. 2) Used to preset tare weight beforehand through the numeric keys. 3) Used to clear the tare weight.
PRINT Key 	When the SL39N is connected to the H-18 scale printer, this key activates the print mechanism and a label is issued. This function can only take place when the control switch on the H-18 is set in the "MANUAL" or "BY COUNT" position.
PLU Key 	Used to recall and display the PLU data which is stored in the H-18 scale printer.
Numeric Keys 	1) In standalone mode, these keys are used to enter unit price and tare weight. 2) When the SL39N is connected to the H-18, these keys are used to enter PLU number, unit price, and tare weight.
NET Lamp 	Lights when tare is subtracted.
PREPACK Lamp 	Lights when <b>SAVE</b> key is pressed.



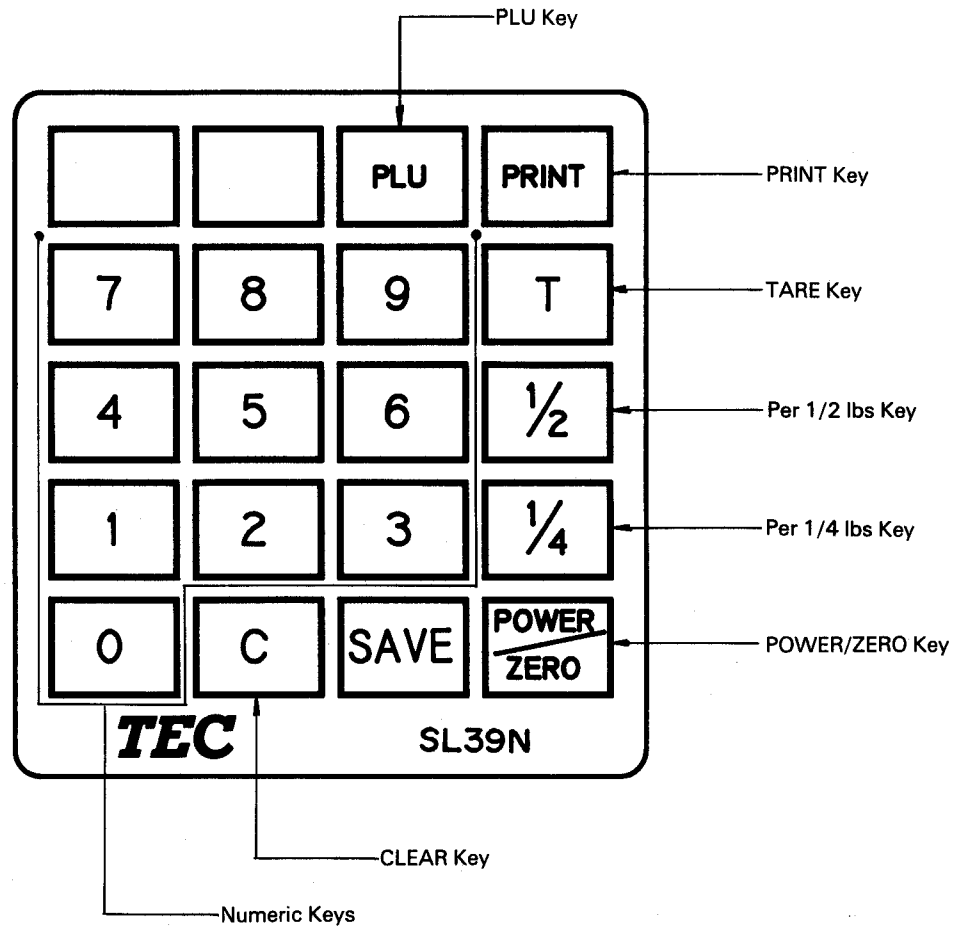

**NOTES:**

- (1) The Load Cell in the unit is turned ON when the power plug is connected to the AC outlet. The power of the load cell cannot be turned OFF by the **POWER/ZERO** key.
- (2) When the **POWER/ZERO** key is turned on within about 16 seconds after the power plug is connected to the AC outlet, the test scanning sequence is made, ZEROs are displayed and the scale is ready for use.
- (3) When the **POWER/ZERO** key is turned on over about 16 seconds after the power plug is connected to the AC outlet, all "8"s appear on all displays for a moment, then ZEROs are displayed and the scale is ready for use.

## 4. KEY ARRANGEMENT



## 5. KEY AND LAMP FUNCTIONS

Name of Key & Lamp	Function
POWER/ZERO Key 	Used to supply power to the main circuit and to adjust "ZERO" point.
SAVE Key 	Used to save tare and unit price.
CLEAR Key 	1) Used to clear the unit price. 2) Used to release the scale from save or error mode. 3) Used to clear the price when scale printer is connected. 4) Used to clear the PLU number when scale printer H-18 is connected.
Per 1/2, 1/4 Keys  	Used to calculate the unit price by 1/2 lbs or 1/4 lbs. <b>NOTE:</b> When the 1/2 (1/4) key is depressed, the unit price is multiplied by 2 (4).



## 6. LEVEL ADJUSTMENT



Correct



Incorrect

Set the scale on a stable and level surface. Level the scale by turning the adjusting legs so that the air bubble comes to the center circle. For example, in the case of the condition shown in the left figure, turn the Adjusting Legs (1) and (2) in the direction shown so that the bubble comes to the center of the circle.

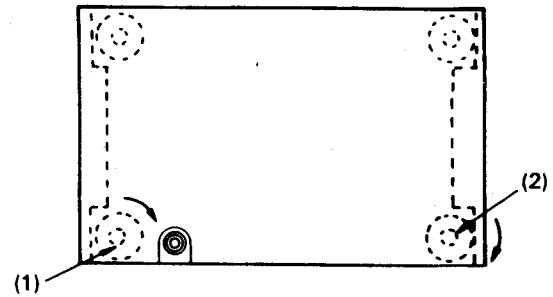
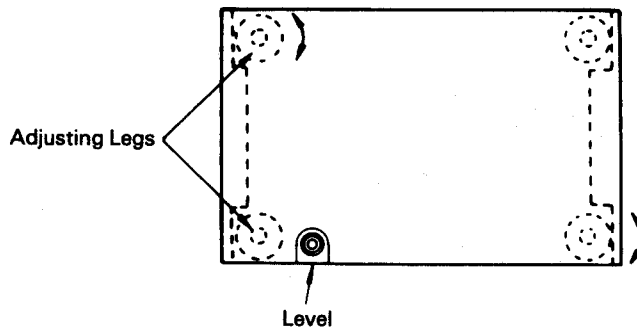

## 7. NOTES BEFORE STARTING OPERATION

- A. Be sure to insert power plug into AC outlet.
- B. When turning **POWER/ZERO** key on within about 16 seconds after inserting the power plug into AC outlet, the scale enters the test scanning sequence, such as 00000, 0000, 00000, then 11111, 1111, 11111 ... until ZEROs are shown on all displays.
- C. While scale is in the test sequence, do not put anything on the platter.
- D. Do not move the unit while it is in operation. Should it become necessary to move it at any time, turn the power switch off and be sure to readjust the level after relocating the scale.
- E. Should a power failure occur during operation, turn the power OFF and remove the commodity from the platter, and turn the power on again when power is restored.
- F. If scale is used with an unrated power source, inaccurate scaling or other errors may occur.
- G. If Zero Point has shifted during scaling, and no tare is displayed, adjust Zero Point by depressing **POWER/ZERO** key.

# 8. OPERATIONAL PROCEDURE

## 8-1. Regular Operation (SL39-30L-N)

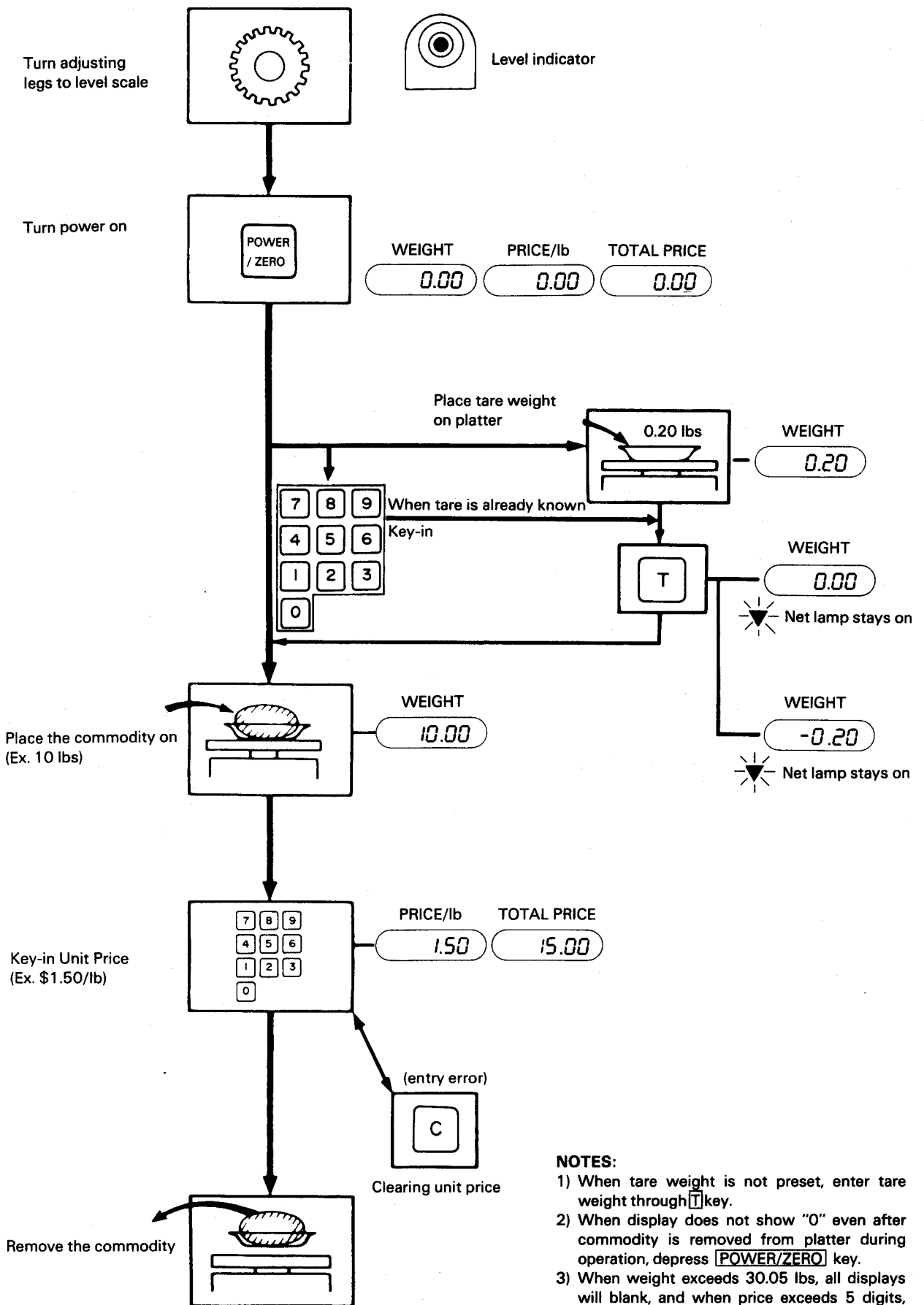

### NOTES:

- 1) When tare weight is not preset, enter tare weight through **T** key.
- 2) When display does not show "0" even after commodity is removed from platter during operation, depress **POWER/ZERO** key.
- 3) When weight exceeds 30.05 lbs, all displays will blank, and when price exceeds 5 digits, only price display will blank.
- 4) **[1/2]** or **[1/4]** key should be depressed after

## 8-2. Tare Function Procedures

There are two kinds of tare subtraction procedures, one is "Direct tare", another is "Preset tare".

### 1) Direct tare subtraction

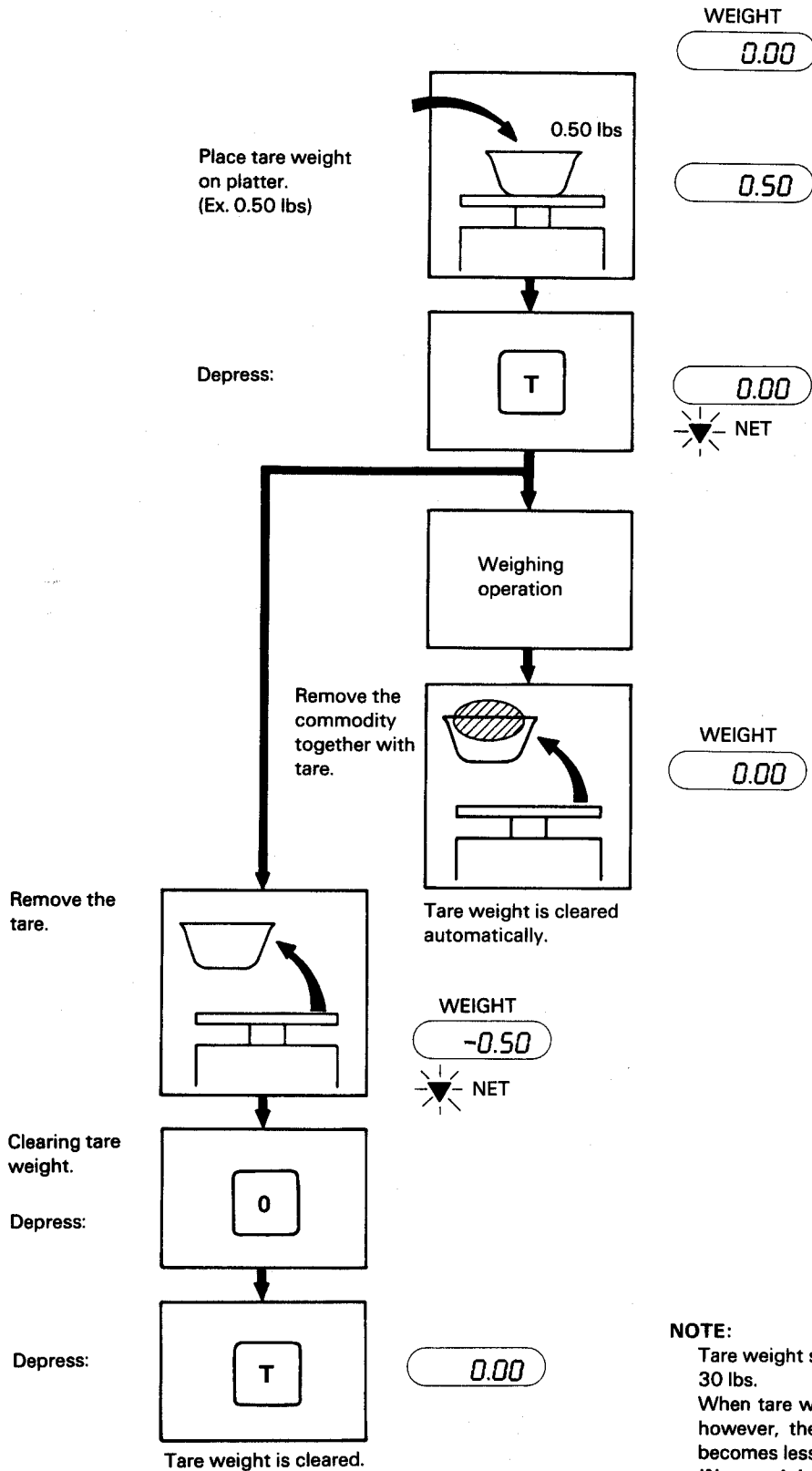

#### NOTE:

Tare weight subtraction is available with up to 30 lbs.

When tare weight subtraction is in operation, however, the scalable range for net weight becomes less by the amount of the tare.

**(Net weight = Weighing amount - Tare weight)**

## 2) Preset tare subtraction

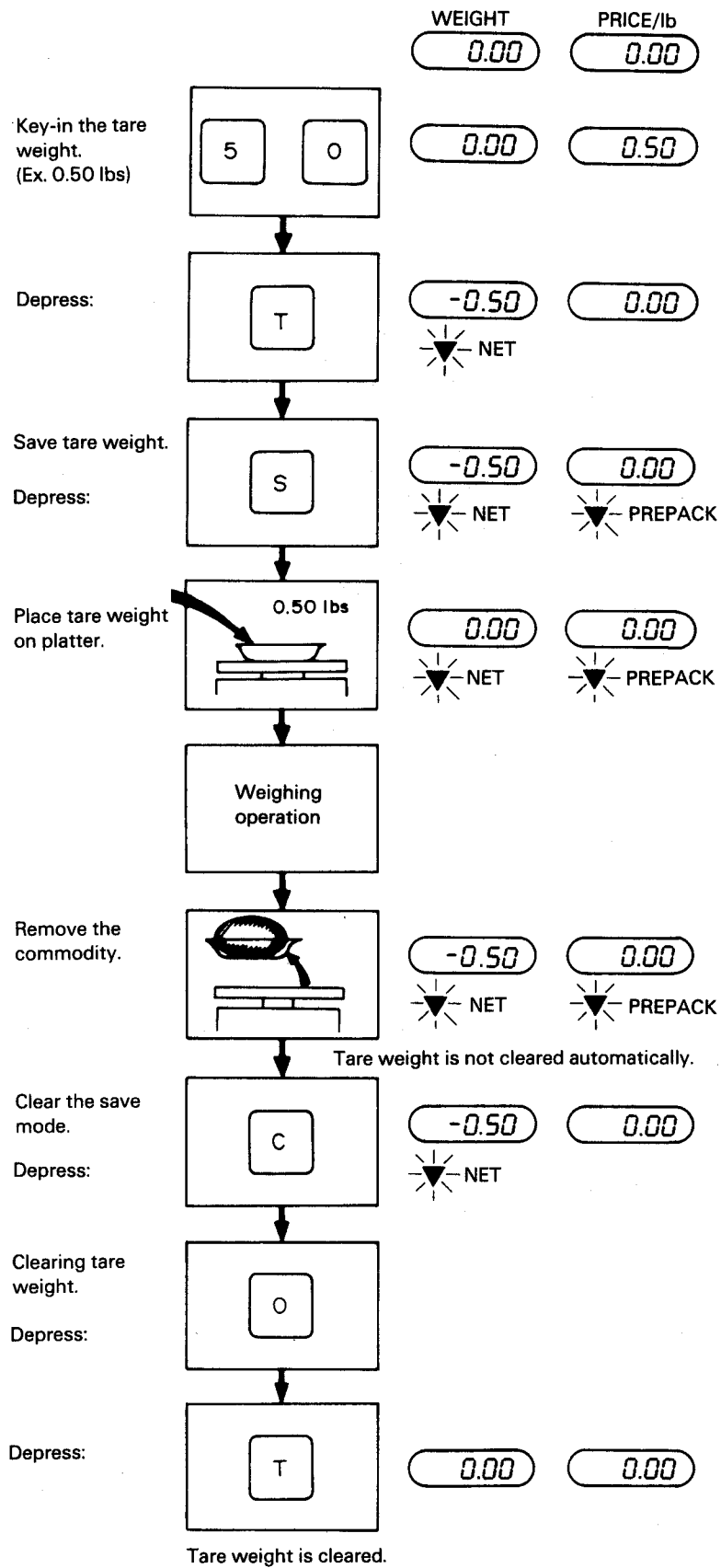

### 8-3. Unit Price per 1/2, 1/4 lbs

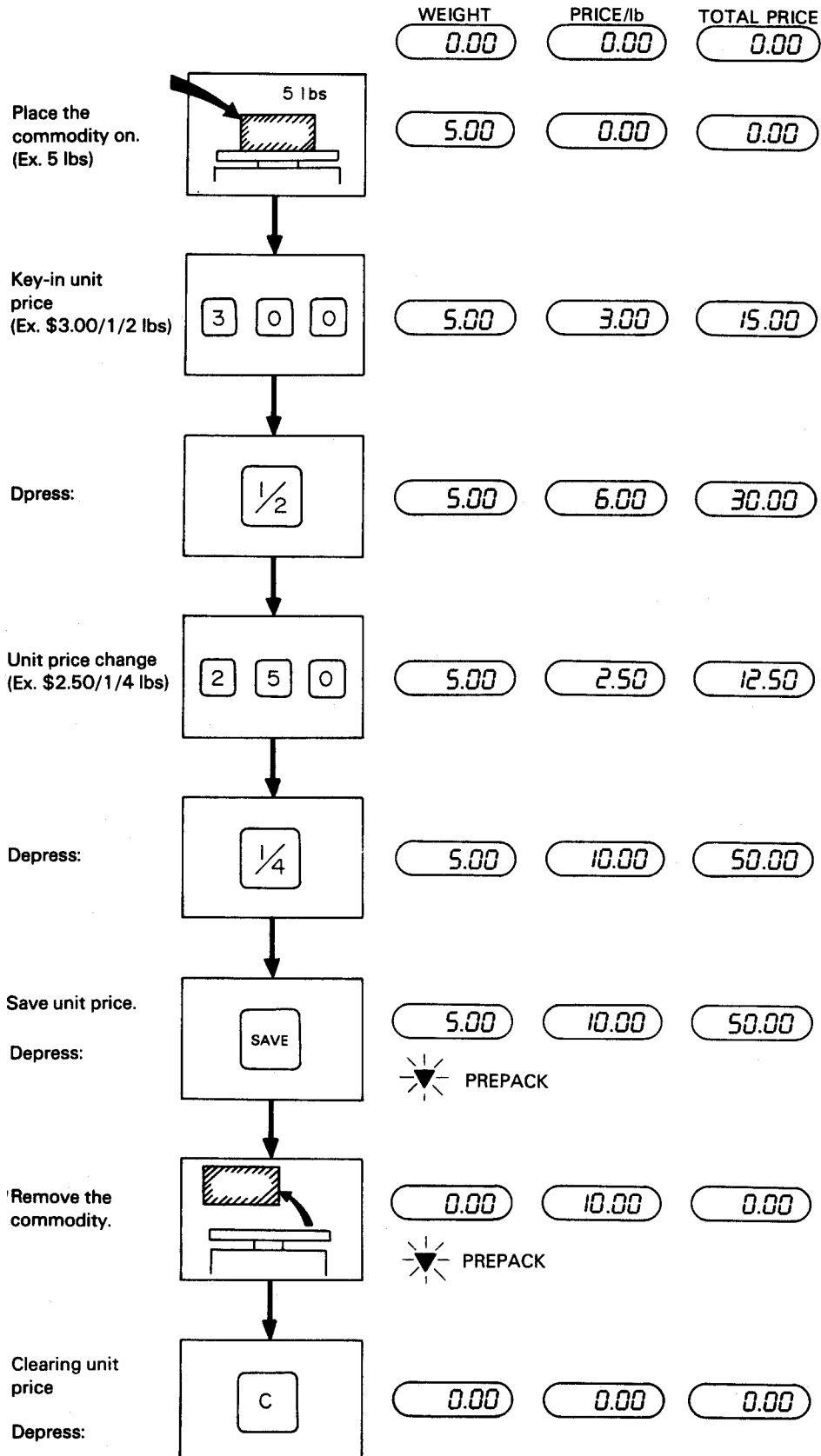

**NOTES:** 1) The SL39N will check details of unit price, if unit price after calculation (1/2 lbs: 2 times, 1/4 lbs: 4 times) is exceeded 4 digits then unit price will be cleared.

2) 1/2 or 1/4 key should be depressed after key-in unit price.

**8-4. When the H-7 SCALE PRINTER is Connected (Printer interface is optional)**

**1) Example of operation with the H-7 set to AUTO or MANUAL mode**

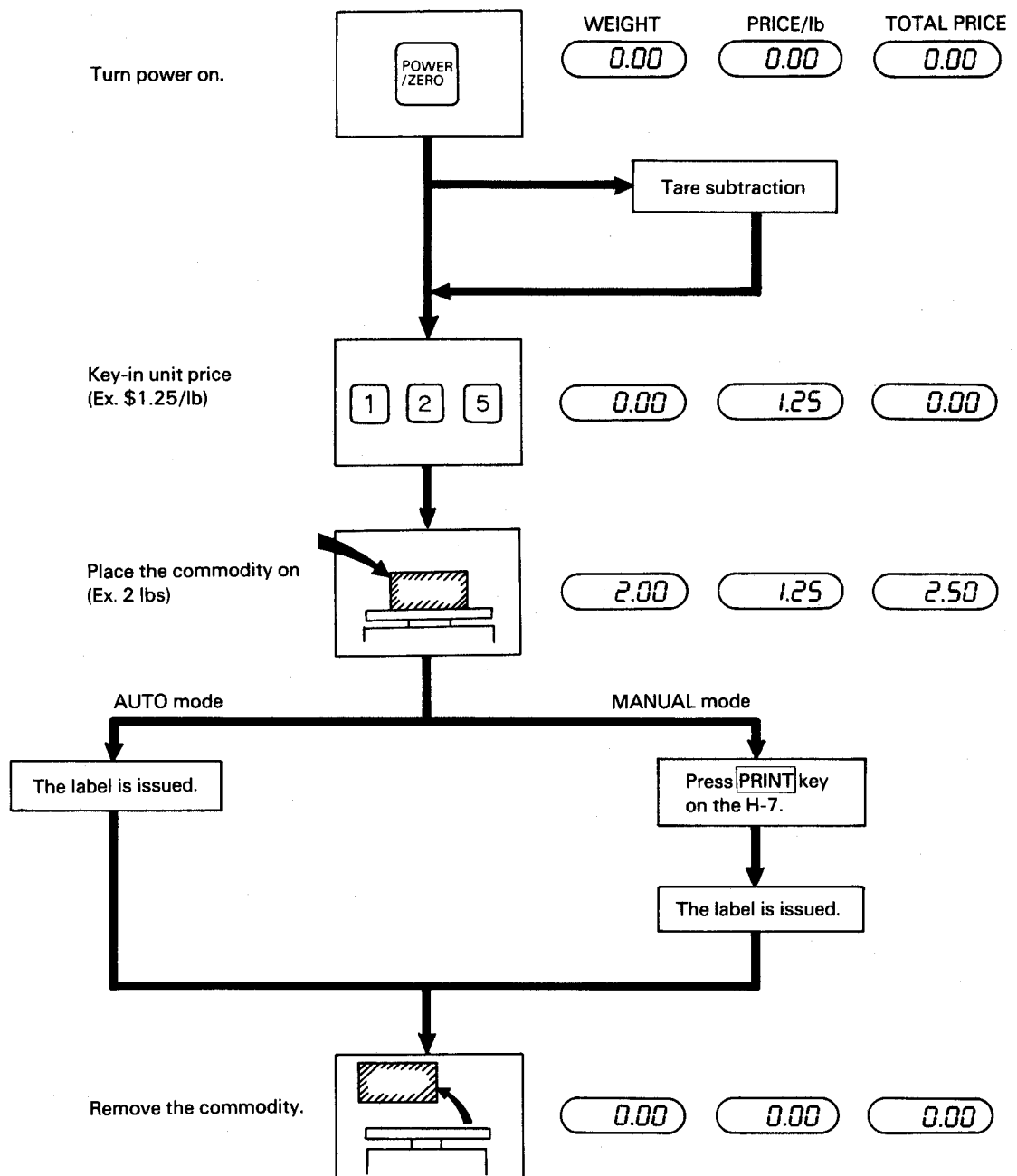

**NOTE:** When the tare weight exceeds 0.20 lbs with the H-7 Label Issue Mode switch set to AUTO position, one tare label sheet will be issued automatically.

To prevent this, set the H-7 Label Issue Mode switch to MANUAL position.

When the H-18 Scale Printer is connected, this same phenomenon will occur.

**8-5. When the H-18 SCALE PRINTER is Connected (Printer interface is optional)**  
**Example of general operation**

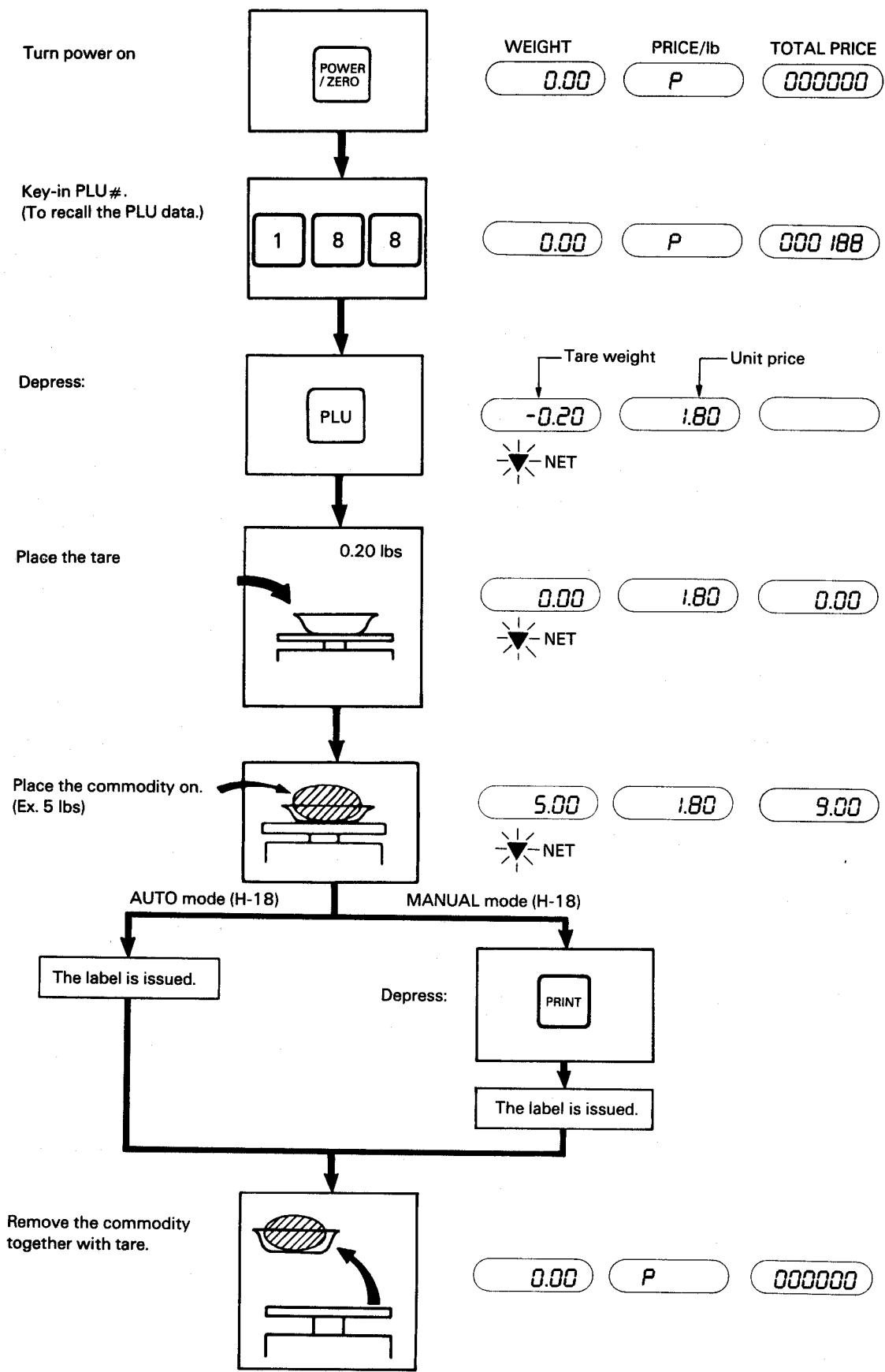

**NOTE:** If an error tone is heard from SL39N, you have indexed a invalid PLU #.

## 2) Example of operation with the H-7 set to BY COUNT mode.

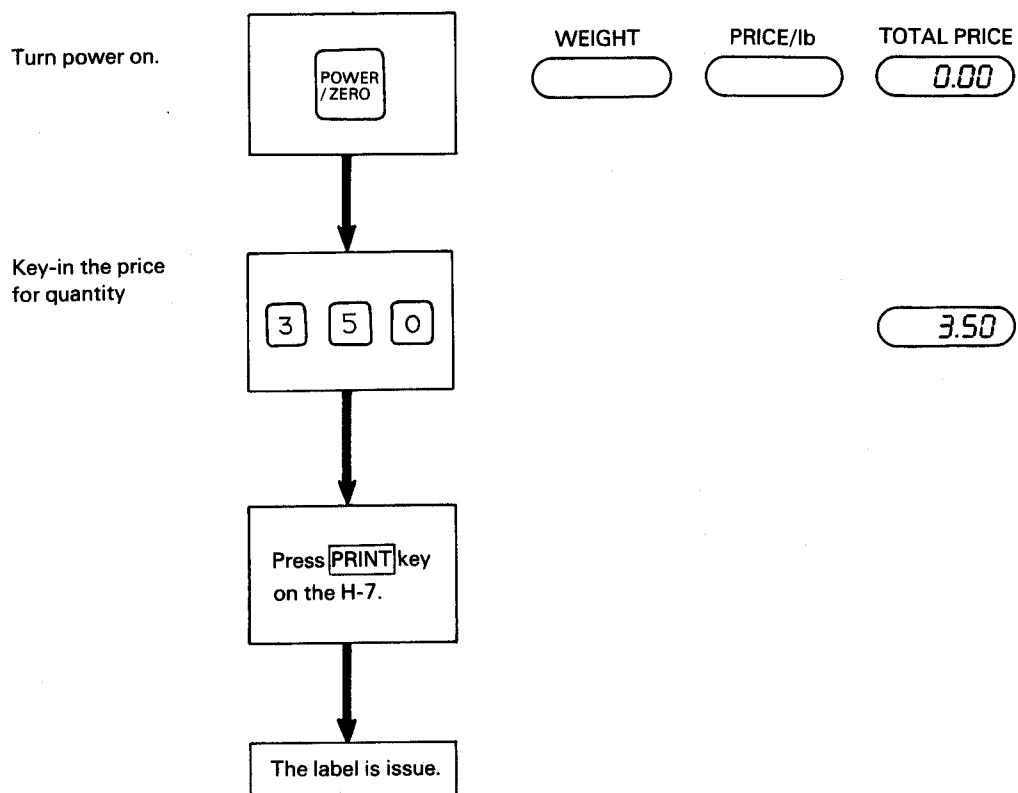

**NOTE:** The number of articles should be set with the H-7.  
For details, refer to the H-7 Owners Manual.







## Free Manuals Download Website

<http://myh66.com>

<http://usermanuals.us>

<http://www.somanuals.com>

<http://www.4manuals.cc>

<http://www.manual-lib.com>

<http://www.404manual.com>

<http://www.luxmanual.com>

<http://aubethermostatmanual.com>

Golf course search by state

<http://golfingnear.com>

Email search by domain

<http://emailbydomain.com>

Auto manuals search

<http://auto.somanuals.com>

TV manuals search

<http://tv.somanuals.com>