

TEC

TEC Laser Scanner

LS-780 SERIES

Owner's Manual

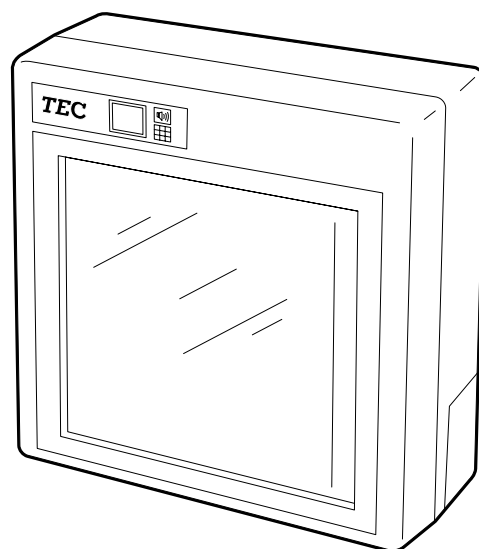

TOSHIBA TEC CORPORATION

CE Compliance (for EU only)

This product complies with the requirements of EMC and Low Voltage Directives including their amendments.

Caution:

For U.S and Canada, use a UL Listed or Recognized, ITE or Class 2 power supply unit having a L-shaped output connector.

For Europe, use a CE marked ITE or Class 2 power supply unit having a L-shaped output connector.

Rated output of the power supply unit shall be 12 Vdc -10% 800 mA or more.

FCC Notice (for USA only)

This equipment has been tested and found to comply with the limits for a Class A digital device, pursuant to Part 15 of the FCC Rules. These limits are designed to provide reasonable protection against harmful interference when the equipment is operated in a commercial environment. This equipment generates, uses, and can radiate radio frequency energy and, if not installed and used in accordance with the instruction manual, may cause harmful interference to radio communications.

Operation of this equipment in a residential area is likely to cause harmful interference in which case the user will be required to correct the interference at his own expense.

Changes or modifications not expressly approved by manufacturer for compliance could void the user's authority to operate the equipment.

WARNING

This is a Class A product. In a domestic environment this product may cause radio interference in which case the user may be required to take adequate measures.

ATTENTION

Ce produit est de classe A. Dans un environnement domestique, il peut causer des interférences radio. Auquel cas, l'utilisateur sera amené à prendre les mesures adéquates.

Warnung

Dies ist ein Klasse A Produkt. In einer örtlichen Umgebung kann dieses Gerät Funkstörungen verursachen.

Atención

Este es un producto de la clase A. En ambientes domésticos éste producto puede causar radio interferencias en cuyo caso el usuario deberá tomar las medidas oportunas.

VERWITTINGING

Dit is een klasse A produkt. Het gebruik hiervan kan radio interferenties veroorzaken die de gebruiker ertoe kunnen dwingen sommige maatregelen te moeten treffen.

Safety Summary

Personal safety in handling or maintaining the equipment is extremely important. Warnings and Cautions necessary for safe handling are included in this manual. All warnings and cautions contained in this manual should be read and understood before handling or maintaining the equipment.

Do not attempt to effect repairs or modifications to this equipment. If a fault occurs that cannot be rectified using the procedures described in this manual, turn off the power, unplug the machine, then contact your authorized TOSHIBA TEC representative for assistance.

Meanings of Each Symbol



This symbol indicates warning items (including cautions). Specific warning contents are drawn inside the Δ symbol. (The symbol on the left indicates a general caution.)



This symbol indicates prohibited actions (prohibited items). Specific prohibited contents are drawn inside or near the $\text{\textcircled{X}}$ symbol. (The symbol on the left indicates "no disassembling".)











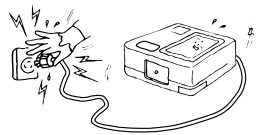



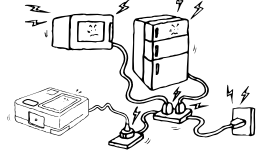









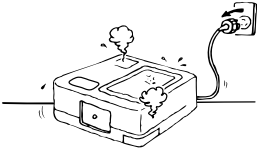

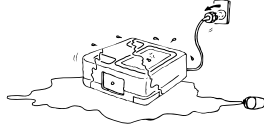

This symbol indicates actions which must be performed. Specific instructions are drawn inside or near the \bullet symbol. (The symbol on the left indicates "disconnect the power cord plug from the outlet".)

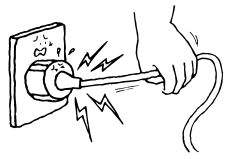

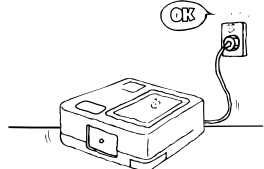
WARNING

This indicates that there is the risk of **death** or **serious injury** if the machines are improperly handled contrary to this indication.

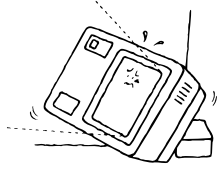
 <p>Prohibited</p>  <p>■ Do not plug in or unplug the power cord plug with wet hands as this may cause electric shock.</p>	 <p>Any other than the specified AC voltage is prohibited.</p>  <p>■ Do not use voltages other than the voltage (AC) specified on the rating plate, as this may cause fire or electric shock.</p>
 <p>Prohibited</p>  <p>■ If the machines share the same outlet with any other electrical appliances which consume large amounts of power, the voltage will fluctuate widely each time these appliances operate. Be sure to provide an exclusive outlet for the machine as this may cause fire or electric shock.</p>	 <p>Prohibited</p>  <p>■ Do not place metal objects or water-filled containers such as flower vases, flower pots or mugs, etc. on top of the machines. If metal objects or spilled liquid enter the machines, this may cause fire or electric shock.</p>
 <p>Prohibited</p>  <p>■ Do not insert or drop metal, flammable or other foreign objects into the machines through the ventilation slits, as this may cause fire or electric shock.</p>	 <p>Prohibited</p>  <p>■ Do not scratch, damage or modify the power cords. Also, do not place heavy objects on, pull on, or excessively bend the cords, as this may cause fire or electric shock.</p>
 <p>Disconnect the plug.</p>  <p>■ If the machines are dropped or their cabinets damaged, first turn off the power switches and disconnect the power cord plugs from the outlet, and then contact your authorized TOSHIBA TEC representative for assistance. Continued use of the machine in that condition may cause fire or electric shock.</p>	 <p>Disconnect the plug.</p>  <p>■ Continued use of the machines in an abnormal condition such as when the machines are producing smoke or strange smells may cause fire or electric shock. In these cases, immediately turn off the power switches and disconnect the power cord plugs from the outlet. Then, contact your authorized TOSHIBA TEC representative for assistance.</p>

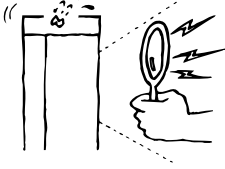
 <p>Disconnect the plug.</p>  <p>■ If foreign objects (metal fragments, water, liquids) enter the machines, first turn off the power switches and disconnect the power cord plugs from the outlet, and then contact your authorized TOSHIABA TEC representative for assistance. Continued use of the machine in that condition may cause fire or electric shock.</p>	 <p>Disconnect the plug.</p>  <p>■ When unplugging the power cords, be sure to hold and pull on the plug portion. Pulling on the cord portion may cut or expose the internal wires and cause fire or electric shock.</p>
 <p>Connect a grounding wire.</p>  <p>■ Ensure that the equipment is properly grounded. Extension cables should also be grounded. Fire or electric shock can occur on improperly grounded equipment.</p>	 <p>No disassembling.</p>  <p>■ Do not remove covers, repair or modify the machine by yourself. It may result in hazardous radiation exposure. Unauthorized modification is prohibited.</p>
 <p>Prohibited</p>  <p>■ Do not remove the glass surface (top window) except for cleaning, as using the machine in this condition may adversely affect people's eyes.</p>	 <p>Prohibited</p>  <p>■ Using the laser beam with large mirrors or optical equipment will result in increased risk to people's eyes and avoid viewing direct laser beam for a long time.</p>

 **CAUTION** This indicates that there is the risk of personal **Injury** or **damage** to objects if the machines are improperly handled contrary to this indication.

Precaution

The following precautions will help to ensure that this machine will continue to function correctly.

- Try to avoid locations that have the following adverse conditions:
 - * Temperatures below 0 C and above 40 C
 - * Shared power socket
- Do not subject the machine to sudden shocks.
- Clean the cover and Top Window, etc. by wiping with a dry cloth or a cloth soaked with detergent and wrung out thoroughly. Never use thinner or other volatile solvent for cleaning.
- At the end of the day, turn the power OFF, then clean and inspect the exterior of the machine.
- Try to avoid using this equipment on the same power supply as high voltage equipment or equipment likely to cause mains interference.
- Do not place heavy objects on top of the machines, as these items may become unbalanced and fall causing **injury**.
- Do not lean against the machine. It may fall on you and could cause **injury**.
- Direct sunlight
- Excessive vibration

Request Regarding Maintenance

- Utilize our maintenance services.

After purchasing the machines, contact your authorized TOSHIBA TEC representative for assistance once per year.

- Our maintenance service performs the periodic checks and other work required to maintain the quality and performance of the machines, preventing accidents beforehand.

For details, please consult your authorized TOSHIBA TEC representative for assistance.

- Using insecticides and other chemicals

Do not expose the machines to insecticides or other volatile solvents, as this will deteriorate the cabinet or other parts or cause the paint to peel.

TABLE OF CONTENTS

	Page
1. INTRODUCTION	1
2. LASER SAFETY	1
3. APPEARANCE AND NOMENCLATURE	2
4. OPERATING PROCEDURE	4
5. BARCODE READING	4
6. MAINTENANCE	6
7. TROUBLESHOOTING	7
8. SPECIFICATIONS	8

1. INTRODUCTION

Thank you for purchasing the TEC LS-780 Series Laser Scanner.

This manual describes the functions and handling of this Scanner and should be read carefully to help gain maximum performance and life from your Scanner. For most queries please refer to this manual and keep it safe for future reference.

2. LASER SAFETY

■ Maintenance and Safety

1. Caution—use of controls or adjustments or performance of procedures other than those specified herein may result in hazardous radiation exposure.
2. The use of optical instruments including a magnifying glass with this product will increase eye hazard.
3. Avoid viewing direct laser beam for a long time.

■ Radiant Energy

This scanner is an IEC Class 1 and CDRH Class IIa laser product. The system uses an embedded Class IIIb VLD (Visible Laser Diode) operating at 650 nm, in an optomechanical scanner, resulting in less than 4.7 microwatts radiated power observed through 100 seconds. Maximum peak output power is 840 microwatts.

■ Label

- The following labels are placed on the back side and inside of the scanner.
<US Type>

(Back side)

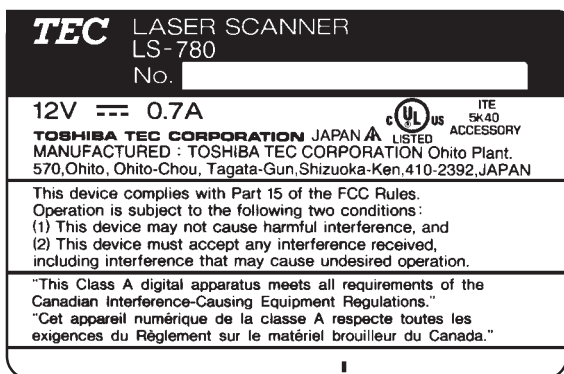

(Inside)

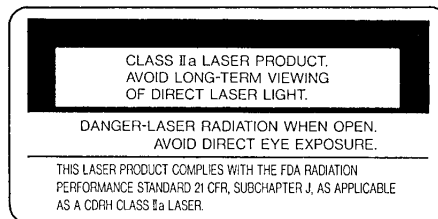

<QM Type>

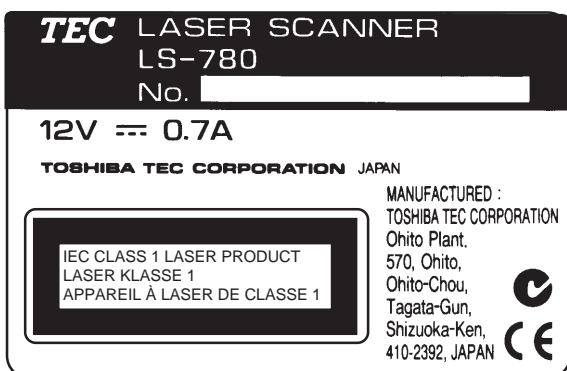

3. APPEARANCE AND NOMENCLATURE

3.1 Appearance

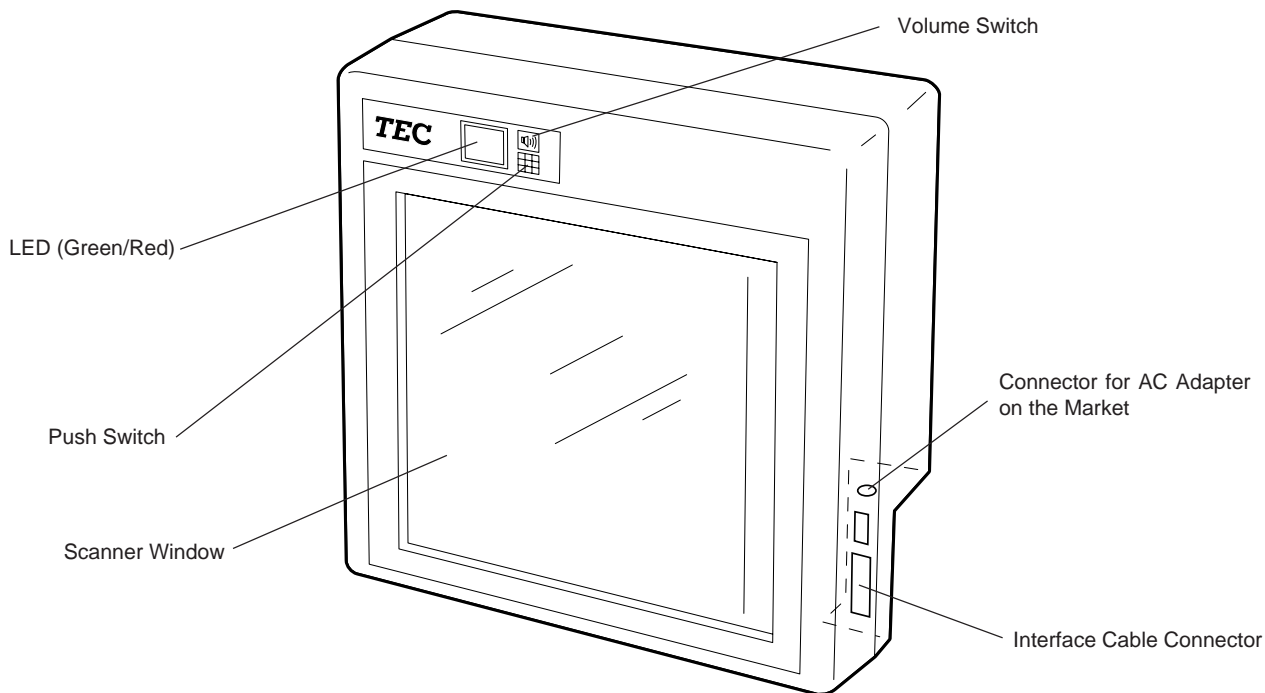

Scanner Window:

Read a barcode of an item.
(For barcode readable range, refer to 5. BARCODE READING.)

Connector for AC Adapter
on the market:

Connects the AC Adapter on the market.
(Complying with EIAJ RC6705.)

Interface Cable Connector:

Connects the Interface Connector Cable (26-pin). OCIA type,
RS-232C type or USB type can be selected according to the host
(ECR/POS) specification.

3.2 Switch Panel

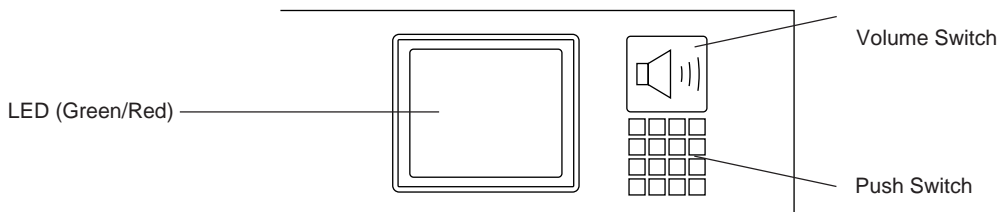

LED(Green/Red): Indicates scanner status using two-color LED (green and red).
(The red LED lights when the scanner is ready to read a barcode and the green LED lights when a barcode is read normally.)

Push Switch: Pressed to return the scanner to reading standby state in auto-power off mode.)

Volume Switch: Adjusts the buzzer volume of the scanner. Each time the volume switch is pressed, the buzzer volume changes as follows:

fi Max. Volume fi Loud Volume fi Medium Volume fi Min. Volume

Default: Loud Volume

Each time the volume switch is pressed while pressing the push switch, the buzzer tone changes as follows:

fi Low Tone fi Medium Low tone fi Medium Tone fi Medium High Tone fi High Tone fi Highest Tone

Default: Low Tone

3.3 Accessory

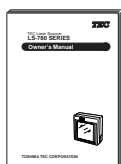

Owner's Manual (1 pc.)

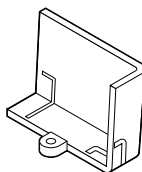

Connector Cover (1 pc.)



Double Sems Screw (1 pc.)

3.4 Optional Parts

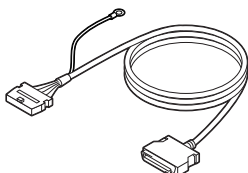

Interface Cable (OCIA)
Model Name: IFC-750-OC

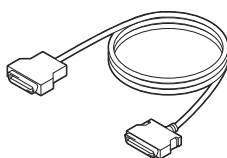

Interface Cable (RS-232C)
Model Name:
IFC-750-RS-09F (26P-9P <Female>)
IFC-750-RS-25F (26P-25P <Female>)
IFC-750-RS-25M (26P-25P <Male>)

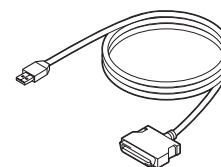

Interface Cable (USB)
Model Name: IFC-780-USB

4. OPERATING PROCEDURE

Power Supply

(1) When the AC Adapter on the market is used:

When the AC adapter is equipped with the power switch, the scanner is turned on and off by turning on and off the power switch. When the AC Adapter is not equipped with the power switch, the power is supplied by plugging in the power cord (no RPC function can be used).

(2) When the power is supplied from the host (ECR/POS):

The power can be supplied via the interface cable. If the host can control power supply to the scanner, the host turns the scanner on and off.

Auto-Power Off Function

To save electricity, this scanner has a function that laser and the motor are automatically turned off when the scanner does not read barcodes for a prescribed time. At auto-power off time, the scanner enters reading standby state by pressing the Push Switch. Since the laser and motor are turned on when the merchandise detect sensor detects something, the scanner also enters reading standby state when anything like a hand is put above the Scanner Window.

5. BARCODE READING

This scanner reads barcode in the following range.

5.1 Scanning Direction

There are two types of the scanner depends on setting position. They are the vertical type and the horizontal type. Each type can read barcodes in the following range.

The scanning pattern generated by an optical head unit is designed to achieve the best reading performance when an article is scanned as illustrated below.

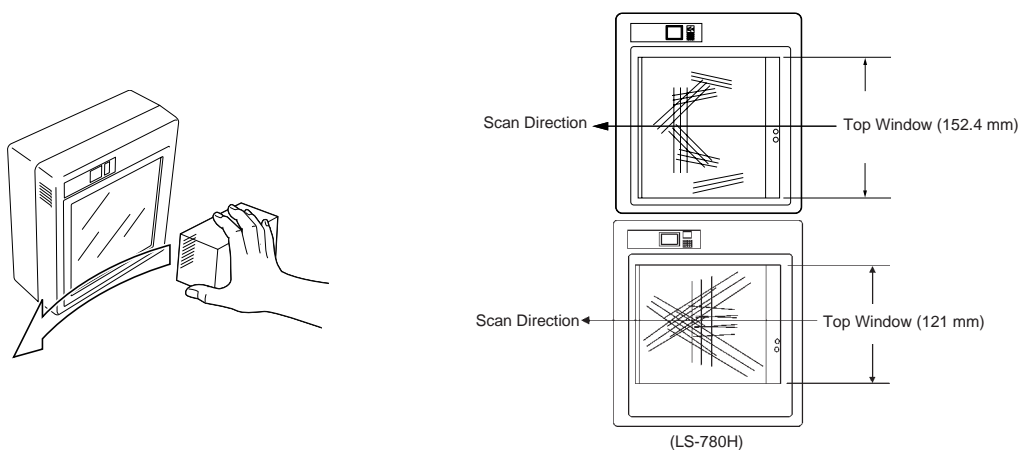

<Seen from the above>

5.2 Effective Scanning Zone

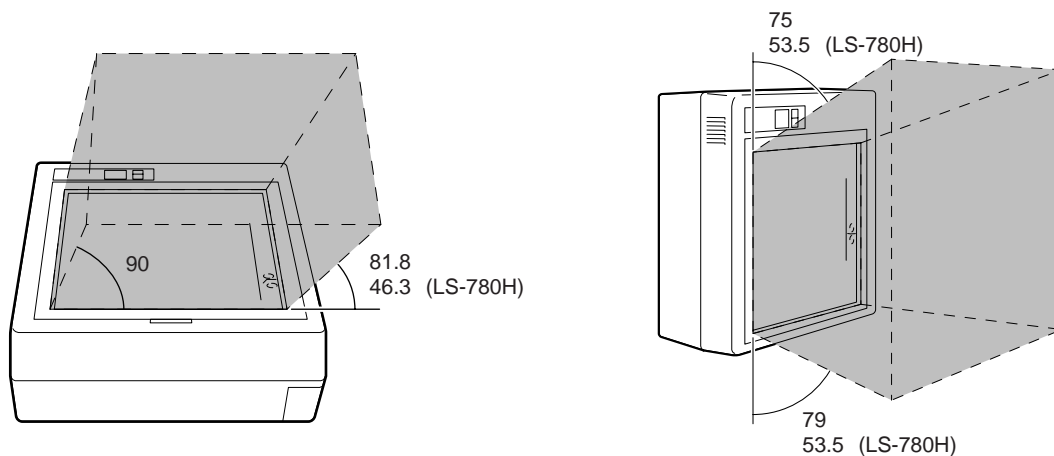

5.3 How to Read

Target the center of the Scanner Window so that the scanner can read a barcode of an item in the range at 50 mm to 200 mm above from the Scanner Window surface.

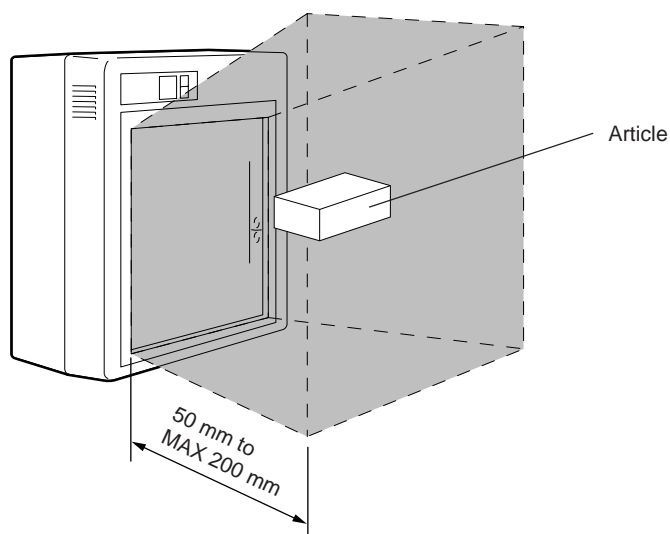

<Seen from the front>

CAUTION

1. Do not contact the item and the Scanner Window.
2. Moving the item perpendicularly to the Scanner Window makes it difficult to read the barcode.

Readable Barcode: EAN/JAN-13, EAN/JAN-8, UPC-A and UPC-E, EAN128, EAN-13/8 and UPC-A/E with Supplemental 2 or 5 digits, ITF (Interleaved 2 of 5), NW7 (CODABAR), CODE39, CODE93, CODE128

6. MAINTENANCE

To maintain reading precision above the prescribed level, keep the Scanner Window clean. To clean the Top Window, use a soft cloth. Remove the Top Window as shown in the figure below, and wipe the Top Window softly using a dry soft cloth. When the Top Window is badly soiled, use a cloth after moistening it with water and wringing water from it. Then wipe the Top Window again using a dry cloth. Clean the Under Window in the same manner. Be careful not to damage the Under Window, since it is made of acrylic and easily damaged.

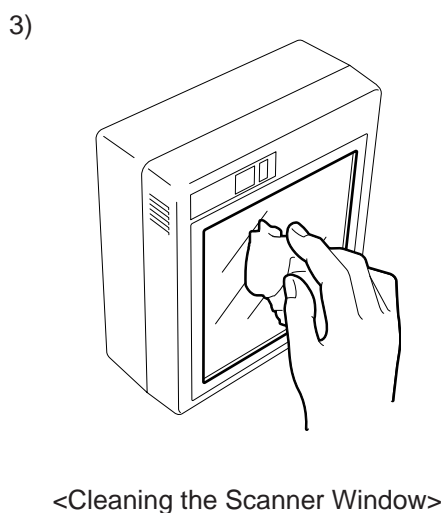
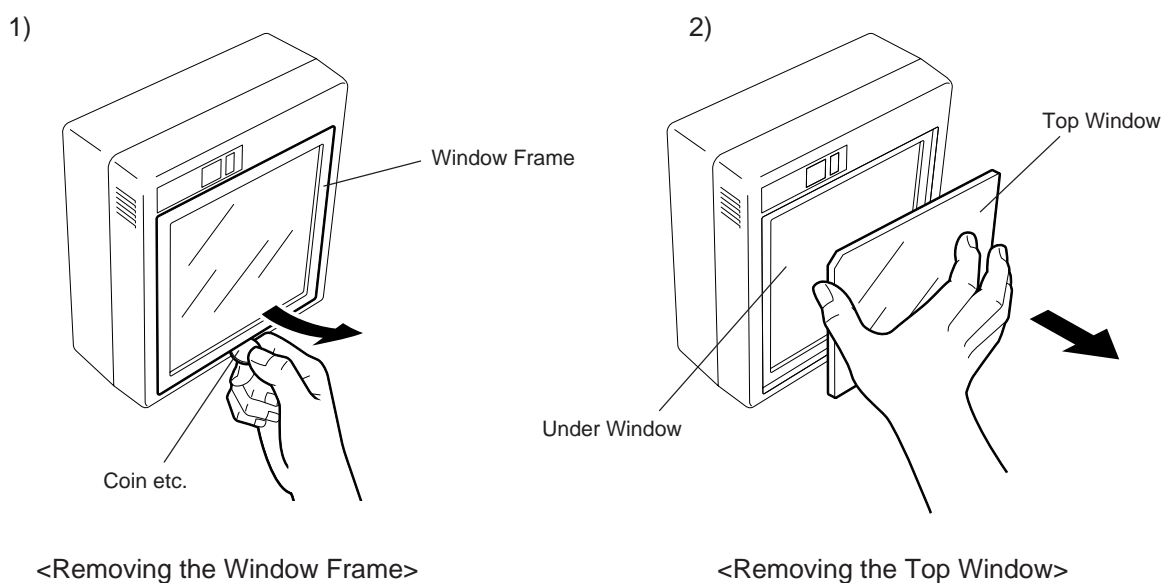

- Reassemble the Top Window so that the window cut part will be placed on the convex part of the Top Window Holder.

7. TROUBLESHOOTING

- When an error is detected at the power ON...

This scanner has the self-diagnosis function to detect an internal error when the power is turned ON. If an error is found at this time, the scanner informs you of error occurrence by the LED and the buzzer. Number of the LED flickering and the buzzer beep is predetermined according to the error contents as shown below. The error indication is repeated at the one second interval until the power of the scanner is turned OFF. In case of the error occurrence, inform your TOSHIBA TEC representative of the error status.

Error Indication		Error Contents
Red LED	Buzzer	
Flickers once.	Single Tone once	ROM Error
Flickers twice.	Single Tone twice	RAM Error
Flickers three times.	Single Tone three times	EEPROM Error
Flickers four times.	Single Tone four times	Decoder IC Error
Flickers five times.	Single Tone five times	Motor Error
Flickers six times.	Single Tone six times	Laser Error

- When an error is detected during the normal operation...

This scanner also detects an internal error during the normal operation. If an error is found during the normal operation, the scanner informs you of error occurrence by the LED and the buzzer. Number of the LED flickering and the buzzer beep is predetermined according to the error contents as shown below. The error indication is repeated at the one second interval until the power of the scanner is turned OFF. In case of the error occurrence, inform your TOSHIBA TEC representative of the error status.

Error Indication		Error Contents
Red LED	Buzzer	
Flickers three times.	Single Tone three times	EEPROM Error
Flickers five times.	Single Tone five times	Motor Error
Flickers six times.	Single Tone six times	Laser Error

- When the power of the scanner is not turned ON...

Cause	Action
<ul style="list-style-type: none"> The power plug of the AC adapter is not inserted, or is not securely inserted. 	<ul style="list-style-type: none"> Insert the power plug into the power outlet securely.
<ul style="list-style-type: none"> The power is not supplied to the power outlet. 	<ul style="list-style-type: none"> Check the power supply using another electrical appliance.
<ul style="list-style-type: none"> The connector of the interface cable has been de-detached in case of the scanner of which power is controlled from the host terminal. 	<ul style="list-style-type: none"> Attach the connector securely.
<ul style="list-style-type: none"> The power of the host terminal is OFF in case of the scanner of which power is controlled from the host terminal. 	<ul style="list-style-type: none"> Turn the power of the host terminal ON.

When a trouble still exists after taking the actions described above, ask your TOSHIBA TEC representative.

- When the scanner cannot read a barcode...

Cause	Action
<ul style="list-style-type: none"> • The top window of the scanner is dirty or dewed. 	<ul style="list-style-type: none"> • Clean the top window.
<ul style="list-style-type: none"> • Barcode system does not correspond to scanner specification. 	<ul style="list-style-type: none"> • Reading a barcode is unavailable. Use the barcode system corresponding to the scanner specification.
<ul style="list-style-type: none"> • Barcode has a defect. (Print of a barcode is too light, dirty, blurred, or defaced.) 	<ul style="list-style-type: none"> • Reading a barcode is unavailable. Read a perfect barcode attached to the same article. Enter the barcode of the article manually by the keyboard. (However, depending on the function of the host terminal.)
<ul style="list-style-type: none"> • Angle to read a barcode is not appropriate. 	<ul style="list-style-type: none"> • Read the barcode at the appropriate angle. (Refer to page 5 in details.)
<ul style="list-style-type: none"> • Barcode to be read is too near to the top window or too far from the top window. 	<ul style="list-style-type: none"> • Read the barcode in the effective scanning zone. (Refer to pages 4 and 5.)

When a trouble still exists after taking the actions described above, ask your TOSHIBA TEC representative.

- When the scanned data is not transferred to the host terminal...

Cause	Action
<ul style="list-style-type: none"> • The connector of the interface cable has been detached. 	<ul style="list-style-type: none"> • Attach the connector securely.

When a trouble still exists after taking the action described above, ask your TOSHIBA TEC representative.

8. SPECIFICATIONS

8.1 Scanner Main Body

Dimensions:	200 (W) x 90 (D) x 220 (H) mm (Vertical standing dimensions)
Weight:	1.5 kg
Readable code:	EAN/JAN-13, EAN/JAN-8, UPC-A, UPC-E, EAN128, EAN-13/8 and UPC-A/E with Supplemental 2 or 5 digits, ITF (Interleaved 2 of 5), NW7 (CODABAR), CODE39, CODE93, CODE128
Interface:	OCIA RS-232C USB
Reading Height:	Up to 200 mm above from the Scanner Window surface
Input Power:	12 VDC – 10%

8.2 Interface Cable (Option)

Cable Length:	5.0 m
---------------	-------



TEC
TOSHIBA TEC CORPORATION

M PRINTED IN JAPAN
EO1-19036

Free Manuals Download Website

<http://myh66.com>

<http://usermanuals.us>

<http://www.somanuals.com>

<http://www.4manuals.cc>

<http://www.manual-lib.com>

<http://www.404manual.com>

<http://www.luxmanual.com>

<http://aubethermostatmanual.com>

Golf course search by state

<http://golfingnear.com>

Email search by domain

<http://emailbydomain.com>

Auto manuals search

<http://auto.somanuals.com>

TV manuals search

<http://tv.somanuals.com>