



CCD B/W CAMERA CS4000B/BC SERIES Specifications

CONTENTS

	Page
1. FEATURES	1
2. PRECAUTION	1
3. CAMERA HEAD&CAMARA CABLE	2
4. CONSTITUTION	3
5. SPECIFICATION	3
6. EXTERNAL VIEW	9
•CAMERA CONTROL UNIT	
•CAMERA HEAD	
•CAMERA CABLE	
•CAMERA MOUNTING KIT(OPTION)	

TOSHIBA TELI CORPORATION



This user's manual is manufactured from recycled paper.

Important Safety Precautions

The main unit and the user's manual of the product provide information on important contents that will help prevent injury to those using the product and others, prevent property damage, and ensure safe use of the product. Please make yourself familiar with this information before using your CCD camera.

Make sure you understand the meaning of the indications and graphic symbols shown below before reading this manual. Be sure to observe the precautions indicated.





● Description of indications

Indication	Meaning of indication
 DANGER	Incorrect use or disregarding precautions may result in death or serious injury
 WARNING	Incorrect use or disregarding precautions may result in death or serious injury
 CAUTION	Incorrect use or disregarding precautions may result in personal injury (*1) or damage to property (*2).







*1: Personal injury refers to injuries, burns, or electric shock that does not require hospitalization or repeated hospital is its.

*2: Property damage refers to damage to assets or materials.

● Description of graphic symbols







Graphic symbol	Meaning of graphic symbol
	Prohibited – actions to be avoided at all times. The prohibited actions are indicated within or near the graphic symbol with illustrations or text.
	Required – actions or that must be taken. The required actions are indicated within or near a graphic symbol with illustrations or text.
	Hazardous. The nature of the hazard is indicated within or near the graphic symbol with illustrations or text.
	Caution. The reason for the precaution indicated within or near the graphic symbol with illustrations or text.

● Handling Precautions (Camera Control Unit)









 <h1 style="margin: 0;">DANGER</h1>	
 Unplug	<p><u>If any overheating sign is observed, discontinue the use immediately.</u></p> <p>In the event that smoke, smell, or any other overheating sign is observed, turn its power switch OFF immediately, and remove your plug from outlet. Do NOT try to continue to use this device. To do so in spite of clear signs of malfunction invites a fire, an electric shock hazard, or a serious damage. In such case, contact us or our dealer /distributor from which you purchased this device for repair service.</p>
 Unplug	<p><u>If any malfunctioning sign is observed, discontinue the use immediately.</u></p> <p>Do NOT try to use this device when it is obviously malfunctioning. (Example: No images on the monitor) In the event of malfunction, turn its power switch OFF immediately, and remove the plug from the outlet. In such case, contact us or our dealer/ distributor from which you purchased this device for repair service.</p>
 Unplug	<p><u>If any liquid gets into the device, discontinue the use immediately.</u></p> <p>In the event that water, or any other type of liquid gets into the body, do NOT try to continue to use the device. To do so invites a fire or an electric shock hazard. In that case, turn its power switch OFF immediately, and then remove the plug from the outlet. After that, contact us or our dealer/ distributor from which you purchased this device for repair service/technical advice.</p>
 Unplug	<p><u>If any foreign object gets into the body, discontinue the use immediately.</u></p> <p>In the event that grits, small particles, or any other foreign objects get inside, do NOT try to continue to use the device. To do so invites a fire or an electric shock hazard. In that case, turn its power switch OFF immediately, and then remove the plug from the outlet. After that, contacts or our dealer/ distributor from which you purchased this device for repair service/technical advice.</p>
 Unplug	<p><u>If any outer strong impact is given to this device, discontinue the use immediately.</u></p> <p>In the event that this device is dropped onto the ground, or its cabinet is damaged, turn its power switch OFF immediately, and remove the plug from the outlet. Do NOT try to continue to use the device. To do so invites a fire or an electric shock hazard.</p> <p>In such case, contact us or our dealer/distributor from which you purchased this device for repair service.</p>
 NEVER pull apart	<p><u>Do NOT disassemble this device.</u></p> <p>Do NOT attempt to pull apart, repair, or modify the device on your own. To do so might lead to a fire or an electric shock accident.</p> <p>Contact us or the dealer/distributor from which you purchased the device for repair/modification.</p>

 Avoid	<p><u>Do NOT supply any power other than specified.</u></p> <p>This device is designed to work only under specified voltage. Do NOT attempt to supply the device with power other than specified. Supplying the device with unspecified power invites a fire or an electric shock hazard.</p>
--	---



● Handling Precautions



 DANGER	
 Avoid	<p><u>Do NOT place the device unstably.</u></p> <p>Do NOT place the device on an unstable table, sloped ground, etc.. Make sure that the device do not fall nor roll over to prevent an accident.</p>
 Avoid	<p><u>Do NOT place any potentially-hazardous things on this device.</u></p> <p>Do NOT place any things on the device which may, if it gets into the inside of the body, damage the inner parts of the device (such as a flower pot, glass, cosmetics, a container filled with liquids or chemicals, as well as small metal parts, etc.). If tumbled, the liquids inside the bottle, etc. may get into the chassis, causing a fire or an electric shock accident.</p>
 Avoid	<p><u>Do NOT insert any foreign object through air-vent</u></p> <p>Avoid inserting any foreign object, especially metal part, combustible, through ventilation slits. To do so may cause a fire or an electric shock accident.</p>
 Avoid	<p><u>Do NOT damage the power cord.</u></p> <p>Do NOT damage, break, re-process, nor bend forcefully the power cord. Pulling forcefully/Twisting/Placing a heavy object on/Applying heat on the cord should also be avoided. Otherwise, the cord may be damaged, causing a fire or an electric shock accident. If the cord is damaged, contact us or our dealer/distributor from which you purchased this device for repair service.</p>
 Avoid	<p><u>Do NOT remove the protective cover</u></p> <p>Avoid removing its protective cover. If you touch the inner high-voltage part, you might get an electric shock. For inner part/circuit checkup, maintenance, or repair, contact us or the dealer/distributor from which you purchased this device.</p>

● Handling Precautions



 CAUTION	
 Unplug	<p><u>Unplug the power-plug when the your device is not in use.</u></p> <p>For safety, make sure to unplug the power-plug before you give your device a cleanup, or when it is not used. Keeping the power-cord connected might invite a fire or an electric shock hazard.</p>
 Avoid	<p><u>Do NOT expose your device to direct sunlight, nor intensive heat.</u></p> <p>Do NOT place this device where it is exposed to direct sunlight, or in a high temperature condition. To do so may cause the inner temperature of the device to go up, resulting in burning-down of inner parts, circuits or a fire accident.</p>
 Avoid	<p><u>Do NOT attempt to make connection before turning power off</u></p> <p>Make sure to check the CCU power is OFF before connection. Otherwise, you might get an electric shock.</p>
 Avoid	<p><u>Do NOT pull the cord itself</u></p> <p>When disconnecting the power-plug out of the outlet, make sure to hold the plug, and then pull it out. Do NEVER try to pull the cord itself. Otherwise, the cord may be damaged or broken, leading to a fire or an electric shock accident.</p>
 Avoid	<p><u>Do NOT handle the power cord with your hand in an wet condition.</u></p> <p>Do NOT plug in/out the power cord with an wet hand. Otherwise, it may cause an electric shock accident.</p>
 Avoid	<p><u>Do NOT block ventilating slits.</u></p> <p>You should avoid;</p> <ul style="list-style-type: none"> ■ Placing your device upside down, or with wrong side up. ■ Installing your device in a poor natural draft condition, recessed area. ■ Placing your device on carpet, cushion. ■ Putting a tablecloth, curtain on your device. <p>Blocking the ventilation slits prevents inner heat from escaping, which might lead to a fire accident.</p>
 Avoid	<p><u>Do NOT place your device too close to a heater.</u></p> <p>Do NOT place your device or its power cord too close to any heating appliance. Otherwise, the coating of its switch and/or power-cord may melt, leading to a fire or an electric shock accident.</p>
 Avoid	<p><u>Do NOT use chemical solvent for cleanup.</u></p> <p>When giving your camera a cleanup, avoid using a benzene, alcohol, and thinner. These chemicals might cause its coating or markings to come off or become degraded.</p>



● Handling Precautions (Camera-head)

 <h2 style="margin: 0;">DANGER</h2>	
 NEVER pull apart	<p><u>Do NOT disassemble this device.</u></p> <p>Do NOT attempt to pull apart, repair, or modify the device on your own. To do so might lead to a fire or an electric shock accident. Contact us or the dealer/distributor from which you purchased the device for repair/modification.</p>

 <h2 style="margin: 0;">CAUTION</h2>	
 Avoid	<p><u>Do NOT connect/disconnect connectors before turning power off.</u></p> <p>Make sure to check the CCU power is OFF before connecting/disconnecting connectors. Otherwise, you might get an electric shock, or your camera might break down.</p>
 Avoid	<p><u>Do NOT expose your device to direct sunlight, nor intensive heat.</u></p> <p>Do NOT place this device where it is exposed to direct sunlight, or in a high temperature condition. To do so may cause the inner temperature of the device to go up, resulting in burning-down of inner parts, circuits or a fire accident.</p>

● Handling Precautions (Camera Cable)

 <h2 style="margin: 0;">DANGER</h2>	
 NEVER pull apart	<p><u>Do NOT disassemble this device.</u></p> <p>Do NOT attempt to pull apart, repair, or modify the device on your own. To do so might lead to a fire or an electric shock accident. Contact us or the dealer/distributor from which you purchased the device for repair/modification.</p>

 <h2 style="margin: 0;">CAUTION</h2>	
 Avoid	<p><u>Do NOT connect/disconnect connectors before turning power off.</u></p> <p>Make sure to check the CCU power is OFF before connecting/disconnecting connectors. Otherwise, you might get an electric shock, or your camera might break down.</p>

RESTRICTION FOR USE

1. Avoid irregular signal interface.

Do not attempt irregular signal interface other than specified. Under signal interface other than recommended/specified in this instruction manual, the device might fail to exert the maximum performance. In much worse case, if you continue to use your device under incorrect signal interface, part(s) of inner circuits might burn down.

DISCLAIMER (LIMITED WARRANTY)

We disclaim any responsibility and shall be held harmless for damages or losses incurred by user(s) in either of the following cases.

1. In case damages or losses are caused by fire, earthquake, or other acts of Gods, the act by third party, misuse by the user deliberately or erroneously, use under extreme operating conditions.
2. In case any indirect, additional, consequential damages (loss of expected interest, suspension of business activities) are incurred as results of malfunction or non-function of this device, we shall be exempted from assuming responsibility for such damages.
3. In case damages or losses are caused by incorrect use which is not in line with the instructions given in this instruction manual.
4. In case damages or losses are caused by malfunction resulting from bad connection with other equipment.
5. In case damages or losses are caused by repair or modification done by the user.

OTHER INSTRUCTIONS

Do NOT use power other than specified

Be sure to use DC12V power supply. The camera is designed to work only under the specified voltage. Do NOT attempt to drive the camera with the power other than DC12V. Operating the camera under power other than DC12V invites a fire or an electric shock hazard.

Avoid intensive light

Do NOT expose the camera's image-pickup-plane to sunlight or other intense light directly. If the part of CCD is exposed to spot-intensive light, you might get a picture problem like blooming and/or smear. You might observe vertical stripes on your monitor if your camera is exposed to sunlight (or any other intensive light), however, this is not a malfunction. Redirect your CH (camera-head) to different directions in such case.

Use under right operation condition

This equipment is designed and guaranteed to work under the temperature range of 0 to 40 degrees C and 30 through 90% humidity range. Avoid using the equipment beyond that limits.

Handle with care

Take care not to drop the equipment, nor give strong impact, as this may cause breakdown.

Do NOT tamper with switches

Read this operation guide thoroughly before you touch switches and adjusters on the rear panel. Do NEVER attempt to disassemble the camera and/or tamper with any inner switches, potentiometers, etc.

Avoid liquid

Avoid placing the camera where it is likely to be splashed with water or any other fluids. Operating the camera with its inner parts/circuits in a wet condition might cause a damage or an electric shock accident.

About camera cable

The connector of the camera cable is in “screw-coupling” lock structure. Improper cramping might cause image noise. Be sure to give it a good cramping to avoid noise.

Camera cable connection/disconnection

Before connecting/disconnecting connectors, make sure to turn camera power OFF. Otherwise, your camera might break down.

Avoid placing near TV/radio

This camera might cause interference (e.g. noise) if used around radio / TV set. In such a case, change the location of your camera (or radio / TV).

Abnormal operation

In the event that any abnormal condition is observed, turn the power switch OFF immediately. Do NOT try to continue to use the camera. To do so reckless of visible signs of malfunction invites a fire, an electric shock hazard, or any other serious damage to the camera. In such case, contact us or our dealer/distributor from which you purchased the camera for repair service.

Thank you for purchasing CS4000B series television camera featuring compact and light weight. To take best advantage and gain the most service from your camera, read this operation manual carefully and thoroughly.

WARNING:

TO PREVENT FIRE OR SHOCK HAZARD, DO NOT EXPOSE THIS APPLIANCE TO RAIN OR MOISTURE.

This equipment should be used with DC12V. Do not use any other power source.

INFORMATION

This equipment generates and uses radio frequency energy and if not installed and used properly, that is, in strict accordance with the manufacturer’s instructions, may cause interference to radio and television reception. If does so, which can be determined by turning the equipment off and on, the user is encouraged to try to correct the interference by one or more of the following measures:

Reorient the receiving antenna;

Relocate this equipment with respect to the receiver;

Move this equipment away from the receiver;

If necessary, the user should consult the dealer or an experienced radio/television technician for additional suggestions.

1. FEATURES

- (1) Compact and light weight camera head.
- (2) Equipped with AGC (Automatic Gain Control) which allows wide dynamic range from bright to dark subjects.
- (3) Equipped with RTS (Random Trigger Shutter) which allows free timing capture with stable SYNC.
- (4) Available external SYNC (HD/VD, VS, SYNC) operation.

2. PRECAUTION

- (1) This equipment should be used with DC12V only.
To prevent electric shocks and fire hazards, do not use any other power source.
- (2) The CS4000 series are designed to be used with EIA B/W television signals.
It cannot be used for playback with a television of a different standard
- (3) Please handle the equipment carefully.
- (4) Do not point your camera lens directly into sunlight or strong artificial light.
This might cause irreparable damage to the image sensor.
Also, be sure to use the lens cap when the camera is not in use.
- (5) Do not expose the camera unit to high temperatures. For example, do not place it near a stove for long periods, or in direct sunshine or in a car in hot weather. Heat may cause some malfunction.
- (6) Keep the camera clean. Dust can damage the camera and cause trouble in moving parts.
Take particular care to avoid the entry of sand or grit when changing the camera lens.
- (7) Avoid jolting the equipment or exposing it to vibration.
- (8) Never attempt to dismantle the equipment.
- (9) Avoid folding or stretching the camera cable or other connection cable between equipment.
- (10) When the cabinet is dusty, clean by gently wiping with a soft cloth. And avoid the use of strong cleaning agents such as benzene or alcohol as they may damage the cabinet.

3. CAMERA HEAD & CAMERA CABLE

The constitution (the combinations of the camera head and the camera cable) is as following.

Camera cable							Camera cable
Type name	TV system	CCD Size	Appearance	Lens mount	Appearance of the camera head	Accessories	
CSH4200B CSH4200BC	EIA CCIR	Type 1/2	φ 17mm	M15.5 P0.5 (male screw)	Round type		3m(CPRC4000B-03) 5m(CPRC4000B-05) Extension7m (CPC4000B-07J)
CSH4300B CSH4300BC	EIA CCIR	Type 1/3	φ 12mm	M10.5 P0.5 (male screw)	Round type		3m(CPRC4000B-03) 5m(CPRC4000B-05) Extension7m (CPC4000B-07J)
CSH4301B CSH4301BC	EIA CCIR	Type 1/3	φ 12mm	M10.5 P0.5 (male screw)	Round type		Cable length 3m (Direct wiring) Extension7m (CPC4000B-07J)
CSH4310BV-□□ CSH4310BCV-□□	EIA CCIR	Type 1/3	20×20mm	M10.5 P0.5 (female screw)	Square type	Slotted set screw	Cable : Direct wiring Type name: (view from rear) (1)V : rear (2)W : left (3)X : under (4)Y : right (5)Z : upper □□ : Cable length (1) 03 : 3m (2) 05 : 5m Extension7m : (CPC4000B-07J)
CSH4310BW-□□ CSH4310BCW-□□	EIA CCIR	Type 1/3	20×20mm	M10.5 P0.5 (female screw)	Square type	Slotted set screw	
CSH4310BX-□□ CSH4310BCX-□□	EIA CCIR	Type 1/3	20×20mm	M10.5 P0.5 (female screw)	Square type	Slotted set screw	
CSH4310BY-□□ CSH4310BCY-□□	EIA CCIR	Type 1/3	20×20mm	M10.5 P0.5 (female screw)	Square type	Slotted set screw	
CSH4310BZ-□□ CSH4310BCZ-□□	EIA CCIR	Type 1/3	20×20mm	M10.5 P0.5 (female screw)	Square type	Slotted set screw	
CSH4410BW-□□	EIA	Type 1/4	20×20mm	M10.5 P0.5 (female screw)	Square type	Slotted set screw	
CSH4410BX-□□	EIA	Type 1/4	20×20mm	M10.5 P0.5 (female screw)	Square type	Slotted set screw	
CSH4410BY-□□	EIA	Type 1/4	20×20mm	M10.5 P0.5 (female screw)	Square type	Slotted set screw	
CSH4410BZ-□□	EIA	Type 1/4	20×20mm	M10.5 P0.5 (female screw)	Square type	Slotted set screw	

Camera control unit	
Type name	TV system
CSU4000B	EIA
CSU4000BC	CCIR

4. CONSTITUTION

- | | | |
|------------------------|---|---|
| (1)Camera control unit | | 1 |
| (2)Accessories | Operation manual | 1 |
| (3)Option | | |
| ① | Each camera head | |
| ② | Camera cable : CPRC4000B-03(3m),-05(5m) | |
| ③ | Extension camera cable : CPC4000B-07J(7m) | |
| ④ | Power adapter | |
| ⑤ | Power cable (Both ends 12P connector) : 3m, 5m, 10m | |
| ⑥ | Cable for power supply (VIDEO,HD,VD, SYNC, WENOUT, TRIGINPUT) | |
| ⑦ | Lens | |
| ⑧ | For DC INPUT CONNECTOR | |
| ⑨ | C mount Adapter | |

About the option part and EMC

This camera guarantee combination with option part .

EMC is not guarantee incase with use non-designate option part.

5. SPECIFICATIONS

(The FACTOR is combination CSH4200B with 3m camera cable when no display head type.)

(1) TV system	
B type	EIA
BC type	CCIR
(2) Image sensor	Interline
CCD (CSH4200B)	ICX418ALB
(CSH4200BC)	ICX419ALB
(CSH4301B)	ICX408ALB
(CSH4301BC)	ICX409ALB
(CSH4310B□-□□)	ICX408AL
(CSH4310BC□-□□)	ICX409AL
(CSH4410B□-□□)	ICX228AL
• Total Active pixel	
(EIA) / (CCIR)	811(H)×508(V) / 795(H)×596(V)
• Active pixel	
(EIA) / (CCIR)	768(H)×494(V) / 752(H)×582(V)
• Video out Active pixel	
(EIA) / (CCIR)	756(H)×485(V) / 742(H)×575(V)
• Pixel Size	
(CSH4200B)	8.4×9.8 μm
(CSH4200BC)	8.6×8.3 μm
(CSH4301B、CSH4310B□-□□)	6.35×7.4 μm
(CSH4301BC、CSH4310BC□-□□)	6.5×6.25 μm
(CSH4401B□-□□)	4.75×5.55 μm

• Active image area	
(CSH4200B, CSH4200BC)	6.5 × 4.85mm(1/2Type)
(CSH4301B, CSH4310B□-□□)	4.8 × 3.6mm(1/3Type)
(CSH4301BC, CSH4310BC□-□□)	
(CSH4401B□-□□)	3.65 × 2.74mm(1/4Type)
(3) Number of scanning lines	
(EIA) / (CCIR)	525 lines / 625 lines
(4) Scanning system	2 : 1 interlace
(5) Synchro system	Internal/External automatic switch-over
(6) Aspect ratio	4 : 3
(7) Illumination	
• Standard	
(CSH4200B, CSH4200BC)	100lx F5.6
(CSH4301B, CSH4310B□-□□	150lx F5.6
CSH4301BC, CSH4310BC□-□□)	
(CSH4401B□-□□)	250lx F5.6 GAIN:STD $\gamma = 1.0$
• Minimum	
(CSH4200B, CSH4200BC)	0.5lx F5.6
(CSH4301B, CSH4310B□-□□	0.7lx F5.6
CSH4301BC, CSH4310BC□-□□)	
(CSH4401B□-□□)	1.25lx F5.6 GAIN:MAX, $\gamma = 0.45$
(8) Video output	VS=1.0 V(p-p)/75 Ω , 1line DC/AC coupling (inner SW setting)
(9) Resolution	
(EIA)	H:570TVlines , V:485TVlines
(CCIR)	H:560TVlines , V:575TVlines
(10) GAIN control	AUTO/STD/MANU (Front panel SW setting) Video level can be adjustable by「GAIN」 Potentiometer when MANU.
(11) Gamma	ON(0.45)/OFF(1.0)Selectable by rear DIPSW setting Initial factory setting: OFF(1.0)
(12) White clip-level	857 ± 40mV(p-p):SYNC non-include
(13) S/N	50dB(p-p)/rms(standard) (GAIN=STD, $\gamma = 1.0$)
(14) CCD integration mode	Field/Frame storage (integration) by rear DIPSW setting Initial factory setting: Field storage integration
(15) Power source	DC12V ± 10%(Ripple level: Less than10mV(p-p)
(16) Power consumption	400mA(DC12V)
(17) Scanning frequencies(Internal synchronization mode)	
• Horizontal drive(H)	
(EIA) / (CCIR)	14.31818MHz ± 100ppm/ 14.18750MHz ± 100ppm
• Vertical drive(V)	
(EIA) / (CCIR)	59.94Hz ± 100ppm/ 50.0Hz ± 100ppm

(18) External sync input

- Input level
HD·VD,SYNC
VS
- Input impedance
- Scanning system
- Polarity
- Frequency
(EIA)
(CCIR)
- Scanning lines
(EIA)/(CCIR)
- Phase different

HD·VD/SYNC/ VS

2~6V(p-p)/10kΩ、2~4V(p-p)/75Ω

1.0V(p-p) (Sync:0.3V(p-p))

High/75Ω、Selectable by rear SW setting

2:1 interlace

Negative

fH=15.734kHz±1%, fV=2fH/525

fH=15.625kHz±1%, fV=2fH/625

525lines/ 625lines

The difference in phase between the falling edge of VD and that of HD is shown in the figure below.

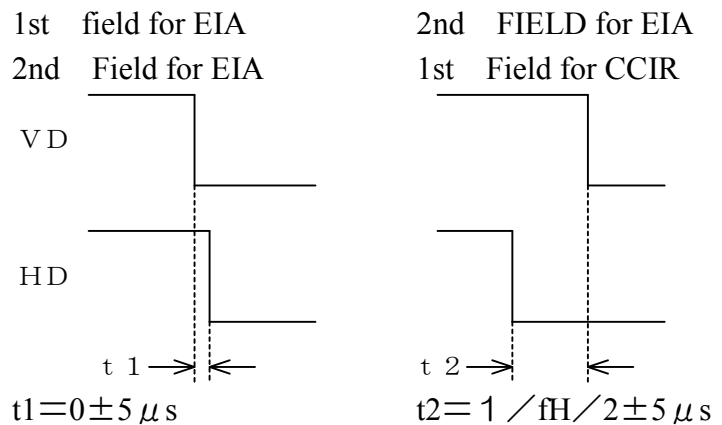

(19) Trigger input

- Input level
- Input impedance
- Polarity
- Pulse with

VL=0~0.5V、VH=4~5V

High impedance

Negative/Positive

2μs~1/4s

(20) Output signal

① HD·VD

- Output level

HD:4.5V±0.5V(p-p)(on no-load condition)

VD:4.5V±0.5V(p-p)(on no-load condition)

- Scanning system

2:1 interlace

- Polarity

Negative

- Pulse width

(EIA)

HD:6.36±1μs, VD:572±10μs

(CCIR)

HD:6.41±1μs, VD:480±10μs

- Frequency

(EIA)

fH:15.334kHz±100ppm, fV:2fH/525

(CCIR)

fH:15.625kHz±100ppm, fV:2fH/625

- Scanning line

(EIA)/(CCIR)

525line/ 625line

② CLOCK

- Output level
- Frequency
- (EIA)
- (CCIR)

2.0 ± 0.3V(p-p)(on no-load condition)
 14.31818MHz ± 100ppm(on no-load condition)
 14.18750MHz ± 100ppm(on no-load condition)

③ WEN

- Polarity
- Diagram

On operate random shutter mode, WEN put out from the fall time of VD to the fall time of VD under put out video signal..
 Positive
 The circuit is shown in the figure below

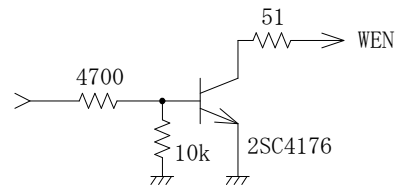

(21) Electronic shutter

Shutter speed can set by front panel switch As follow:
 OFF, 1/125, 1/250, 1/500, 1/1000, 1/2000,
 1/4000, 1/10000, F.L
 1FLD, 2FLD, 4FLD, 6FLD, 8FLD, 10FLD
 (slow speed shutter mode)

(22) Random shutter

RTS mode selection available

Mode1	Shutter-speed switch setting	Internal sync	SYNC non-reset
Mode2	Shutter-speed switch setting	Internal sync	SYNC non-reset
Mode3	Shutter-speed switch setting	Internal sync	SYNC Reset
Mode4	Shutter-speed switch setting	Internal sync	SYNC Reset
Mode5	Shutter-speed switch setting	SeriesHD, SeriesVDinput	SYNC non-reset
Mode6	Shutter-speed switch setting	SeriesHD, SeriesVDinput	SYNC non-reset
Mode7	Shutter-speed switch setting	SeriesHD, One-pulseVDinput	SYNC non-reset
Mode8	Shutter-speed switch setting	SeriesHD, One-pulseVDinput	SYNC non-reset

(23) Special shutter

User-defined shutter-speed cued and timed by shutter trigger and restart / reset pulse input ON /OFF selectable via rear panel DIP SW.
 (Initial factory setting :OFF)

(24) Restart Reset

Restart Reset function available via rear DIP SW selection.

(25) Lens Mount

Special Mount, by each head specification.

(26) Mass

Camera control unit: about 350g

(27) GND

Circuit GND---Chassis: Electrically continuous

(28) EMI

Conforms to EN50081-2

(29) Connector Pin Assignment

• Power/Video connector ···· Compatible plug :HR10A-10P-12S(Manufactured HIROSE ELEC)

Pin No.	External sync			Internal sync
	HD · VD	VS/SYNC	Restart Reset	
1	GND	GND	GND	GND
2	+12V	+12V	+12V	+12V
3	GND	GND	GND	GND
4	Video OUT	Video OUT	Video OUT	Video OUT
5	GND	GND	GND	GND
6	HD INPUT	—————	HD INPUT	HD OUT (*1)
7	VD INPUT	VS/SYNC INPUT	R.R INPUT	VD OUT (*1)
8	GND	GND	GND	GND
9	CLOCK OUT	CLOCK OUT	CLOCK OUT	CLOCK OUT
10	WEN OUT	WEN OUT	—————	WEN OUT
11	TRIG INPUT	TRIG INPUT	TRIG INPUT	TRIG INPUT
12	GND	GND	GND	GND

*1 HD·VD OUT is available via inner SW selection under internal sync operation.

(30) Typical spectral response

(The lens characteristics and light source characteristics Is not reflected in table.)

CSH430□B, CSH4310B□-□□

CSH430□BC, CSH4310BC□-□□

CSH4200B, CSH4200BC

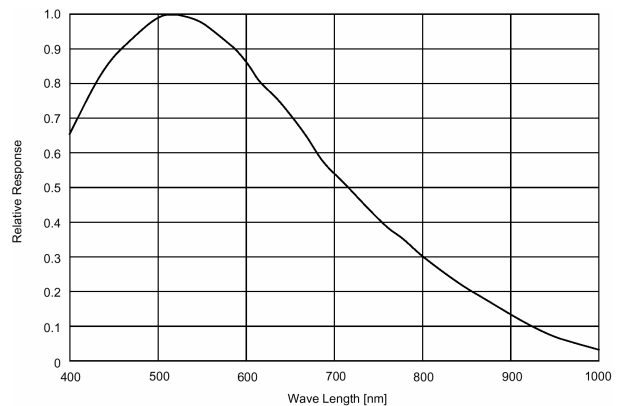
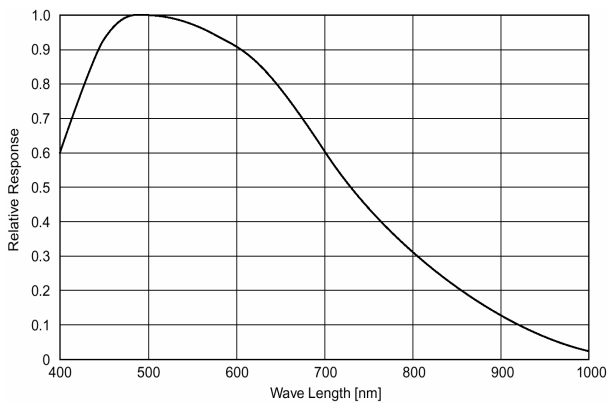

CSH4410B□-□□

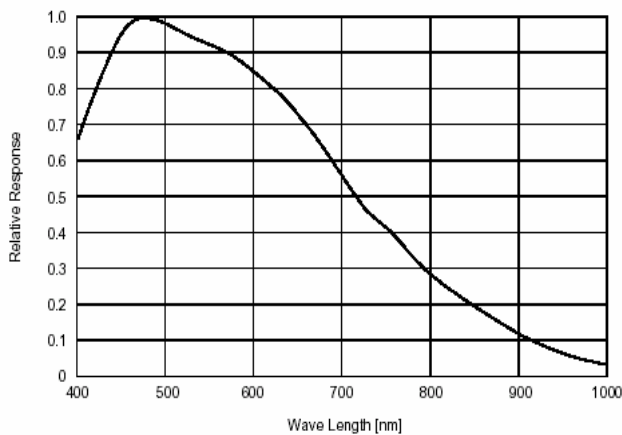

(30) Ambient condition

• Performance assurance

Temperature

0°C ~ 40°C

Humidity

20 ~ 80% (No condensing)

• Operation assurance

Temperature

-10°C ~ 50°C

Humidity

20 ~ 80% (No condensing)

• Storage

Temperature

-20°C ~ 60°C

Humidity

20 ~ 95% (No condensing)

6.EXTERNAL-VIEW DRAWINGS

(1)CAMERA CONTROL UNIT DRAWING

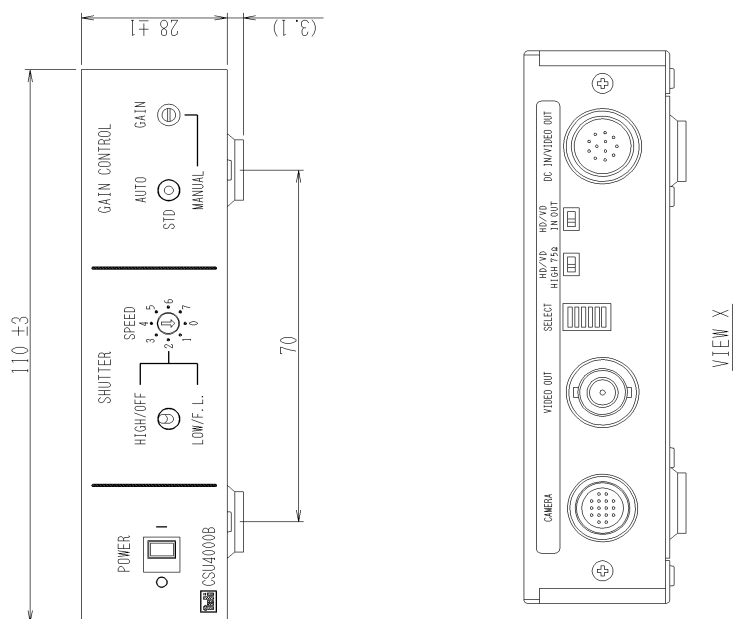
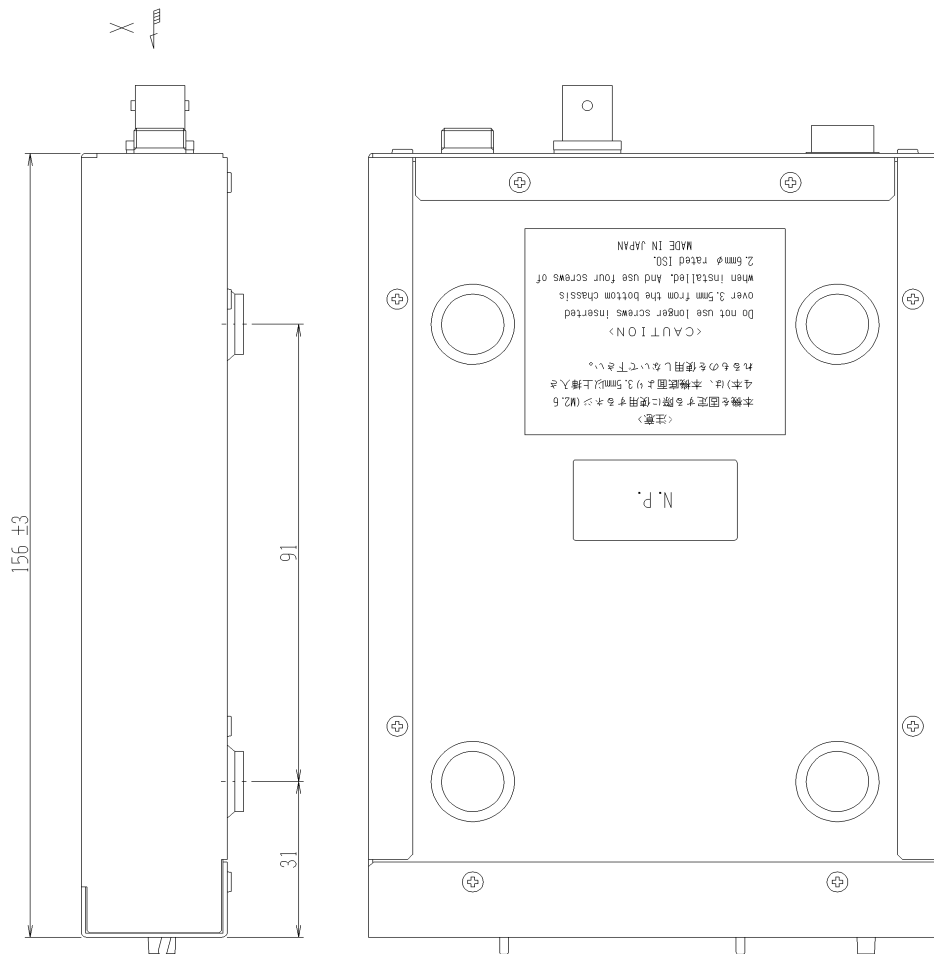

(2)CAMERA HEAD DRAWING
CSH4200B, CSH4200BC

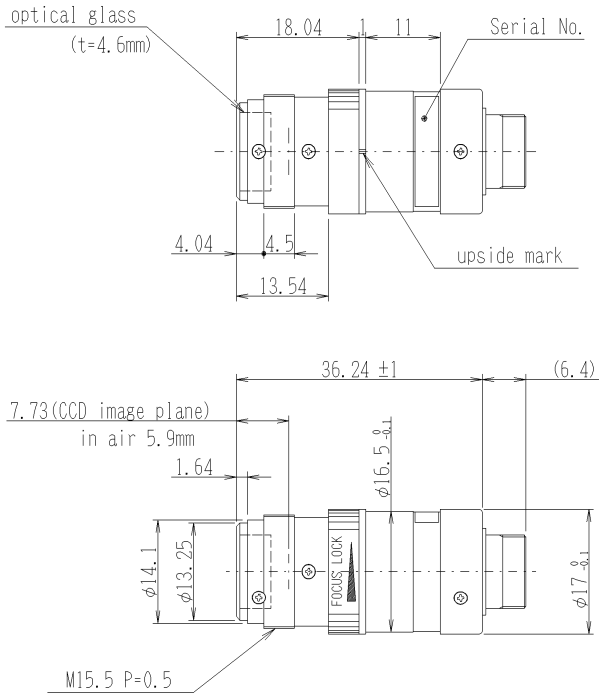

CSH4300B, CSH4300BC

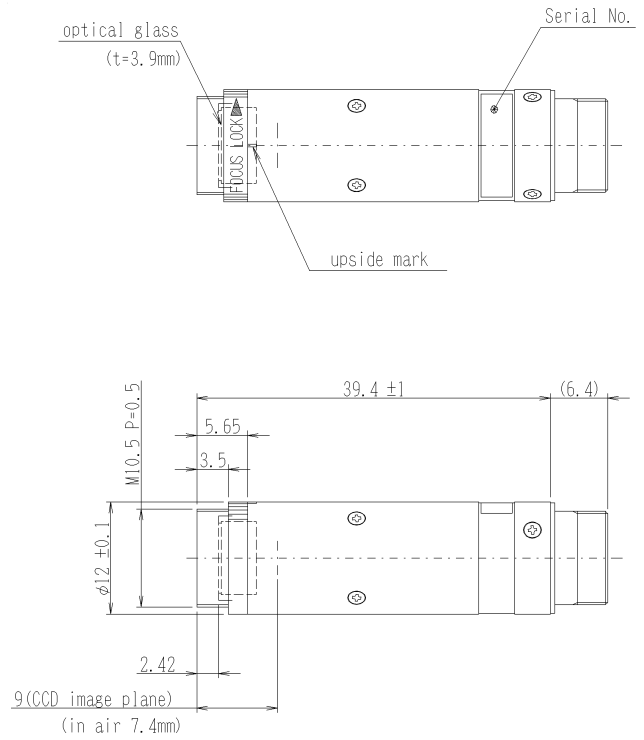

CSH4310BW/X/Y/Z-□□
CSH4310CW/X/Y/Z-□□

CSH4310BV-□□
CSH4310BCV-□□

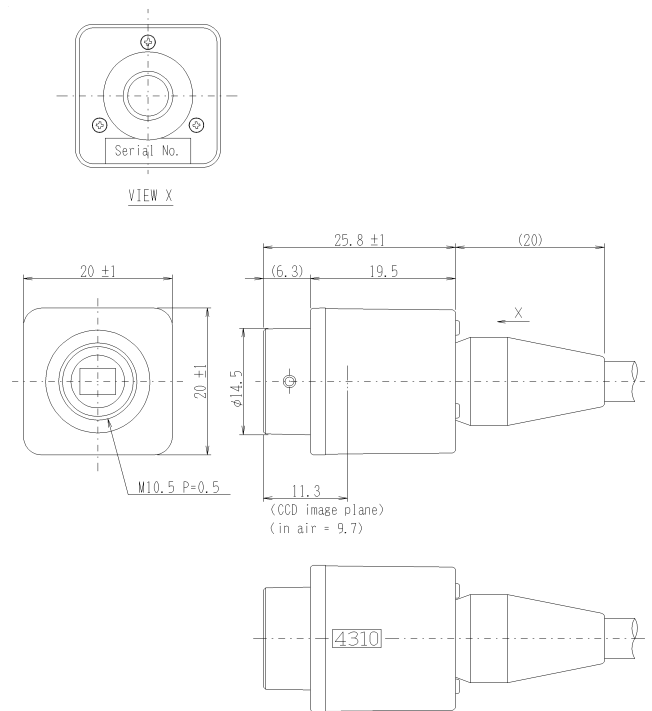
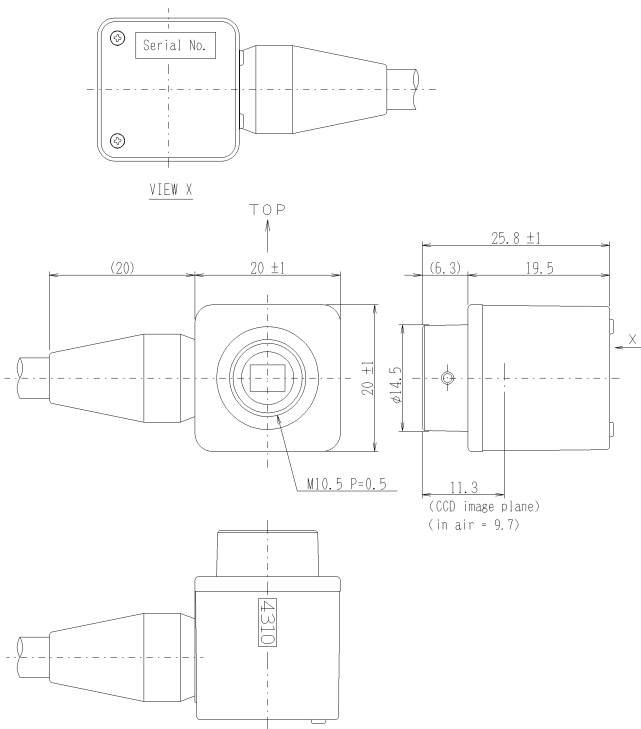

CSH4301B, CSH4301BC

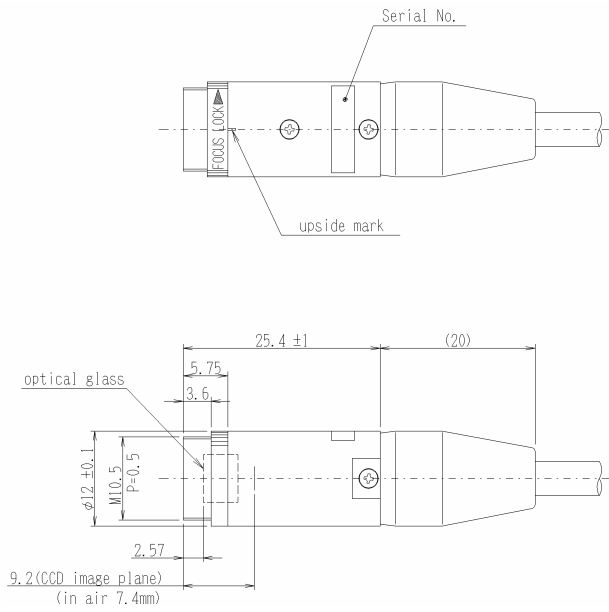

CSH4410BW/X/Y/Z-□□

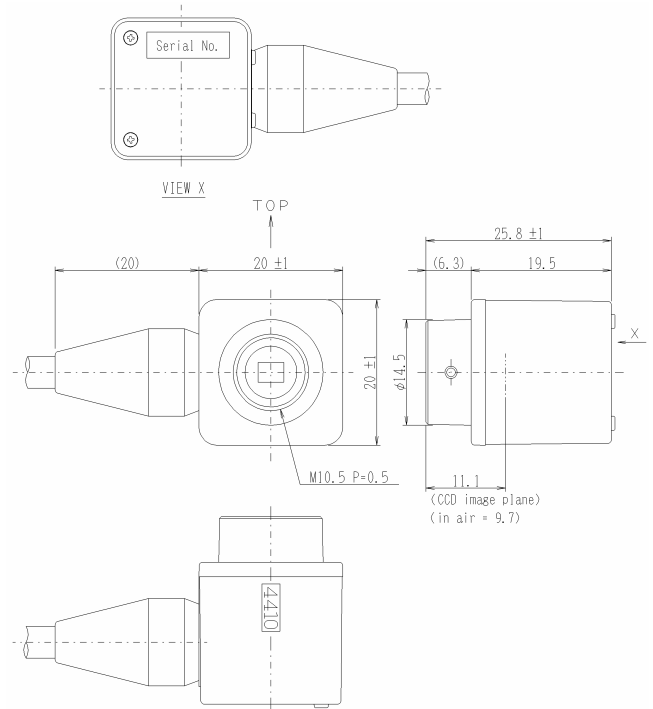

(3)CAMERA CABLE

CPRC4000B-03/05

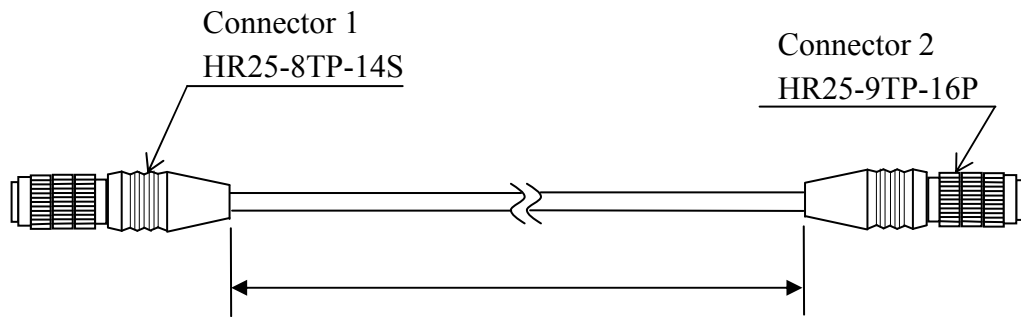

Cable length 3/5 m

CPC4000B-07J

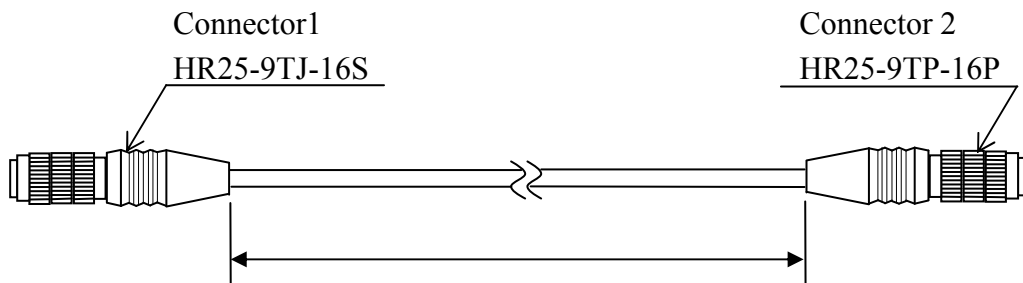

Cable length 7m

(4)CAMERA MOUNTING KIT(OPTION)

Mount kit:CSH4200B/BC

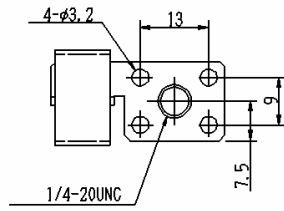

Mount kit: CSH4300B/BC

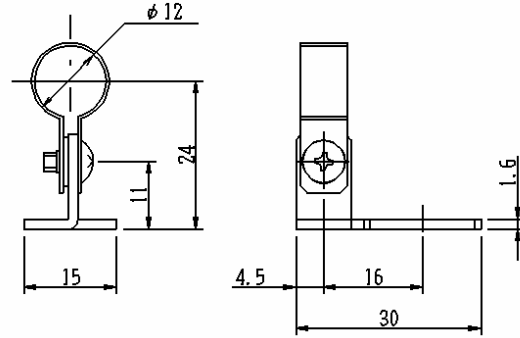
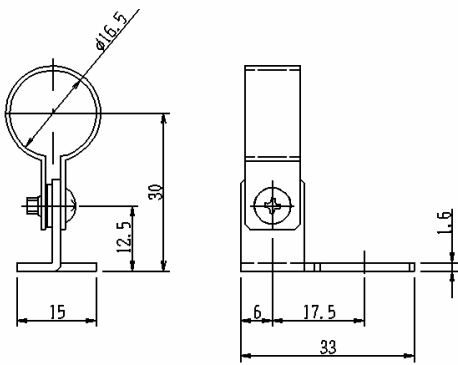
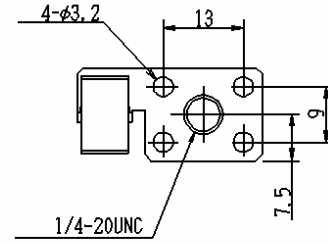

Free Manuals Download Website

<http://myh66.com>

<http://usermanuals.us>

<http://www.somanuals.com>

<http://www.4manuals.cc>

<http://www.manual-lib.com>

<http://www.404manual.com>

<http://www.luxmanual.com>

<http://aubethermostatmanual.com>

Golf course search by state

<http://golfingnear.com>

Email search by domain

<http://emailbydomain.com>

Auto manuals search

<http://auto.somanuals.com>

TV manuals search

<http://tv.somanuals.com>