

CAMERA CONTROL UNIT

IK-TU51CU

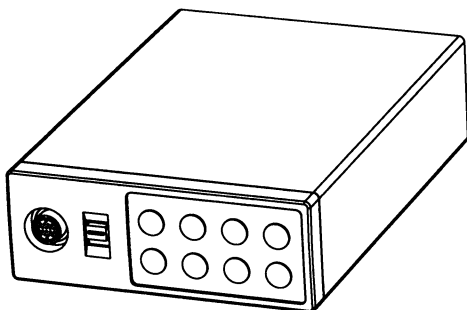

For Customer Use

Enter below the Serial No. which is located on the bottom of the cabinet. Retain this information for future reference.

Model No.: IK-TU51CU

Serial No.: _____

WARNING

This is a Class A of EN55022 product. In a domestic environment this product may cause radio interference in which case the user may be required to take adequate measures.

INFORMATION

This equipment has been tested and found to comply with the limits for a Class A digital device, pursuant to Part 15 of the FCC Rules. These limits are designed to provide reasonable protection against harmful interference when the equipment is operated in a commercial environment. This equipment generates, uses, and can radiate radio frequency energy and, if not installed and used in accordance with the instruction manual, may cause harmful interference to radio communications. Operation of this equipment in a residential area is likely to cause harmful interference in which case the user will be required to correct the interference at his own expense.

USER-INSTALLER CAUTION: Your authority to operate this FCC verified equipment could be voided if you make changes or modifications not expressly approved by the party responsible for compliance to Part 15 of the FCC Rules.



This Class A digital apparatus complies with Canadian ICES-003.

Cet appareil numérique de la classe A est conforme à la norme NMB-003 du Canada.



SAFETY PRECAUTIONS

Read the following safety precautions carefully before using the product. These instructions contain valuable information on safe and proper use that will prevent harm and damage to the operator and other persons. Make sure that you fully understand the following details (indications, graphic symbols) before proceeding to the main descriptions in this manual.

Indication definitions

Indication	Meaning
 Warning	This indicates that ignoring this label and/or misoperation of the product may cause serious personal injury or even death.
 Caution	This indicates that ignoring this label and/or misoperation of the product may cause personal injury ^{*1} and/or material damage ^{*2} .

Graphic symbol definitions

Symbol	Meaning
	Indicates a prohibited action that must not be carried out. The actual prohibited action is indicated in the symbol or nearby graphically or described in text.
	Indicates a mandatory action that must be carried out surely. The actual mandatory action is indicated in the symbol or nearby graphically or described in text.

*1: Bodily injury means injuries, burns and electric shock which does not require hospitalization or prolonged treatment.

*2: Physical damage means extended harm to home, household effects.

Warning

- 

Do not use the product when abnormality occurs.
The use in the abnormality status such as emitting smoke from the product, smelling burning, being damaged by drop, invasion of foreign objects inside the product, etc. , may cause fire and/or electric shock. Be always sure to disconnect the power plug from the electrical outlet (socket) at once and contact your dealer.

- 

Do not install the product where splashing of water may occur, such as outdoor, a bathroom, etc.
This may cause fire and/or electric shock.

- 

Do not repair, disassemble and/or modify by yourself.
This may cause fire and/or electric shock. Be always sure to contact your dealer for internal repair, check and cleaning of the product.

- 

Keep the rated voltage for the product.
The use of power supply voltage except for its rated voltage may cause fire and/or electrical shock. Please refer to "5.CONNECTIONS".

- 

Do not put a vessel(s) filled with a liquid (flower vase, etc.).
If a liquid enters the product, a fire and/or electric shock may occur.

- 

Do not put the product in an unstable, slanting and/or vibrated place.
Drop and/or fail of the product may cause injury.

- 

Do not touch power or TV antenna cords during a thunderstorm.
This might cause electric shock.



Caution

- **Keep the followings when installing.**

- Do not put the product on a flammable material such as carpet or blanket.
- Do not put the product in a narrow space, since the heat generated from the product may be difficult to emanate.
- Do not put a flammable material on the product.
If you do not keep above, the heat generated by the product may cause fire.



- **Do not put the product in direct sunshine and/or high temperature.**
The temperature rise inside the product may cause fire.



- **Do not put the product in a moist or dusty place such as a bathroom, a place close to a humidifier, etc.**
This may cause fire and/or electric shock.



- **Do not put the product in a moist, soot and/or dusty place such as a kitchen, etc.**
Do not put the product where a soot and steam may occur, such as a kitchen, etc. , or in a dusty place. This may cause fire and/or electric shock.



- **Do not shoot the sun with the lens and do not put the lens in the place exposed to an intensive light, such as the sunshine, etc.**
Focusing of the light may cause injury of eye and/or fire.



- **Do not put the product in your mouse and do not swallow it.**
This may cause suffocation and/or injury.



- **Ask your dealer to perform a periodical check and internal cleaning.**
Dust inside the product may cause fire and/or trouble. For check and cleaning cost, please consult your dealer.

1. CAUTIONS ON USE AND INSTALLATION	6
2. COMPONENTS.....	6
3. ITEMS CONTROLLED BY USING ON SCREEN DISPLAY	7
4. NAMES AND FUNCTIONS	8
5. CONNECTION	10
5.1 Standard Connection.....	10
5.2 Cautions on Connection	10
5.3 Connection on Back Panel.....	10
5.3A Connector Pin Assignments.....	11
6. OPERATION	12
6.1 Automatic Black Balance	12
6.2 White Balance	13
6.3 Scene File	15
6.4 Gain.....	15
6.5 Shading Correction	16
6.6 Freeze Operation.....	17
7. MODE SETTING BY ON SCREEN DISPLAY	17
7.1 Using the Menus.....	17
7.2 Menus	19
(1) SHUTTER (Electronic shutter)	19
(1.1) Changing each setting in AUTO mode	20
(1.2) Changing each setting in MANUAL mode	22
(1.3) Changing each setting in SS(synchro. scan) mode	23
(1.4) Changing each setting in EXT TRIG mode.....	24
(1.4.1) Changing each setting in 1 PULSE SNR mode.....	24
(1.4.2) Changing each setting in 1 PULSE SR mode	25
(1.4.3) Changing each setting in 2 PULSE mode.....	26
(1.4.4) Changing each setting in RS232C mode.....	27
(2) GAIN (Video gain).....	27
(2.1) Changing the maximum gain in AUTO (Automatic gain control) mode.....	28
(2.2) Changing gain in MANUAL mode.	28
(3) WHT BAL (White balance)	29
(3.1) Changing the AWB (Automatic White Balance)mode setting.....	29
(3.2) Changing the ATW (Automatic Trace White Balance)mode setting.....	30
(3.3) Changing the MANUAL mode setting	31
(4) PROCESS (Process).....	32
(4.1) Changing the gamma correction ON/OFF	32
(4.2) Changing gamma correction level	32
(4.3) Changing black gamma correction level.....	33
(4.4) Changing two-dimension low pass filter.....	33
(4.5) Changing detail (outline) gain	33
(4.6) Changing detail boost frequency	33
(4.7) Changing master pedestal	34
(4.8) Changing chroma gain	34
(4.9) Changing DNR(Digital Noise Reduction).....	34
(5) MATRIX(Matrix color correction)	35
(5.1) Changing MATRIX color correction ON/OFF.....	35
(5.2) Changing each of MATRIX setting.....	35
(6) SYNC.....	36
(6.1) INT screen.....	36
(6.2) Changing EXT setting	36

(7) OPTION	37
(7.1) Chaging OUTPUT1 output	37
(7.2) Chaging OUTPUT2 output	37
(7.3) Chaging shading correction mode	37
(7.4) Chaging manual shading correction setting	37
(7.5) Chaging RGB SYNC	37
(7.6) Chaging FREEZE DISP setting	38
(7.7) Chaging Negative/Positive inversion switch	38
(7.8) Chaging detail signal output	38
(7.9) Chaging RS232C communication baud rate setting	38
(8) Setting USER area	38
(9) Setting to factory setting status	40
7.3 External Sync	40
(1) External sync signal input conditions	40
(2) External sync frequency range	41
(3) Using the unit with external sync signal	41
(3.1) H (horizontal) phase adjustment	41
(3.2) SC (Sub carrier) phase adjustment	41
7.4 Synchro. Scan Operation	42
(1) Setting by 1H	42
(2) Setting by the frame	42
7.5 EXT TRIG(External trigger)	43
(1) 1 PULSE SNR (1 PULSE Sync Non Reset)	43
(2) 1 PULSE SR (1 PULSE Sync Reset)	44
(3) 2 PULSE	45
(4) RS232C	47
7.6 Freeze Operation by Trigger Input	48
7.7 Digital output	49
(1) Sync pulse timing	49
8. BEFORE MAKING A SERVICE CALL	50
9. SPECIFICATIONS	51
10. EXTERNAL APPEARANCE DIAGRAM	52

1. CAUTIONS ON USE AND INSTALLATION

●Carefully handle the units.

Do not drop, or give a strong shock or vibration to the camera. This may cause problems. Treat the camera cables carefully to prevent cable problems, such as cable breakdown and loosened connections.

●Do not shoot intense light.

If there is an intense light at a location on the screen such as a spot light, a blooming and smearing may occur.

When intense light enters, vertical stripes may appear on the screen. This is not a malfunction. Ghosts may occur when there is an intense light near the object. In this case, change the shooting angle.

●Install the camera in a location free from noise.

If the camera or the cables are located near power utility lines or a TV, etc. undesirable noise may appear on the screen. In such a case, try to change the location of the camera or the cable wiring.

●Moire

When thin stripe patterns are shooted, stripe patterns that are not actually there (moire) may appears as interference stripes. This is not a malfunction.

●Operating ambient temperature and humidity.

Do not use the camera in places where temperature and humidity exceed the specifications. Picture quality will lower and internal parts may be damaged.

Be particularly careful when using in places exposed to direct sunlight. When shooting in hot places, depending on the conditions of the object and the camera (for example when the gain is increased), noise in the form of vertical strips or white dots may occur. This is not a malfunction.

●Handling of the camera head and protection cap.

Keep the camera head and the protection cap away from children. Children may put them into mouth or swallow them accidentally. The protection cap protects the image sensing plane when the lens is removed from the camera head, do not throw away.

●When not using the camera for a longtime.

Turn off the camera power switch and stop supplying power.









●When cleaning the camera

Always turn off the power and make a cleaning with a piece of dry cloth. If necessary, gently wipe with a cloth dampened with thinned detergent. Do not use benzine, alcohol, thinner, etc. If used, coating and printed letters may be discolored. When cleaning the lens, use a lens cleaning paper, etc.

2. COMPONENTS

(1) Camera Control Unit	1
(2) Accessories	
(a) Instruction manual	1

3. ITEMS CONTROLLED BY USING ON SCREEN DISPLAY

Item		Available selections	Preset value (Factory setting)		
Electronic shutter	MODE	AUTO, MANUAL, SS, EXT TRIG	MANUAL		
	EXT TRIG	1PULSE SNR, 1PULSE SR, 2PULSE, RS232C	1PULSE SNR		
	AUTO level	-100 — 0 — 100	0		
	AUTO peak/average	00 : 10 — 05 : 05 — 10 : 00	05 : 05		
	AUTO response speed	1 — 5 — 10	5		
	AUTO area	PRESET A, PRESET B, PRESET C, PRESET D, PRESET E, USER (USER area is possible to set in 64 zones)	PRESET A		
	MANUAL speed	OFF, 1/100s, 1/250s, 1/500s, 1/1000s, 1/2000s, 1/4000s, 1/10000s	OFF		
	Syncro. scan	FLD	1/525H to 260/525H, OFF, 1FRM to 255FRM	OFF	
		FRM	1/525H to 260/525H, OFF, 2FRM to 256FRM		
	Storage mode	FLD, FRM	FLD		
	Freeze operation	FRONT, TRIG  , TRIG 	FRONT		
	Trigger (1PULSE SNR/SR)	 , 			
	Trigger(2PULSE)	 , 			
1PULSE exposure time	0.06ms to 16ms	16ms			
AUTO maximum gain	0dB to 20dB	10dB			
MANUAL gain	0dB to 20dB	0dB			
Write balance	Color temperature	3200K, 5600K	3200K		
	AWB R PAINT	-10 — 0 — 10	0		
	AWB B PAINT	-10 — 0 — 10	0		
	AWB area	PRESET A, PRESET B, PRESET C, PRESET D, PRESET E, USER (USER area is possible to set in 64 zones)	PRESET A		
	ATW R PAINT	-10 — 0 — 10	0		
	ATW B PAINT	-10 — 0 — 10	0		
	MANUAL R GAIN	-100 — 0 — 100	0		
	MANUAL B GAIN	-100 — 0 — 100	0		
Gamma correction switching	ON, OFF	ON			
Gamma correction level	-10 — 0 — 10	0			
Black gamma	LOW, NORMAL, HIGH	NORMAL			
Two-dimension low pass Filter (2D LPF)	ON, OFF	OFF			
Detail gain	-7(OFF) — 0 — 7	0			
Detail boost frequency	LOW, NORMAL, HIGH	NORMAL			
Master pedestal	-50 — 0 — 50	0			
Chroma gain	-128 — 0 — 127	0			
Digital noise reduction(DNR)	ON, OFF	OFF			
Matrix color correction	Correction ON/OFF	ON, OFF	ON		
			JK-TU52H use	JK-TU53H use	
	R hue	-15 — 0 — 15	0	0	
	R gain	-15 — 0 — 15	0	0	
	G hue	-15 — 0 — 15	3	0	
	G gain	-15 — 0 — 15	3	0	
	B hue	-15 — 0 — 15	0	0	
	B gain	-15 — 0 — 15	2	-1	
	Ye hue	-15 — 0 — 15	0	0	
	Ye gain	-15 — 0 — 15	2	-1	
	Cy hue	-15 — 0 — 15	0	0	
	Cy gain	-15 — 0 — 15	0	0	
	Mg hue	-15 — 0 — 15	0	0	
Mg gain	-15 — 0 — 15	0	0		

Item		Available selections	Preset value (Factory setting)
Ext. Sync.	H phase adjustment	-100 — 0 — 100	0
	SC 0/180	0, 180	0
	SC phase adjustment	-128 — 0 — 127	0
OUTPUT	1	RGB, Y/P _r /P _b	RGB
	2	VBS, Y/C	VBS
Shading correction mode		SET, MANUAL, OFF	OFF
Manual shading correction		-128 — 0 — 127	0
RGB SYNC		G, ALL ON, ALL OFF	G
FREEZE DISP		ON, OFF	ON
Negative/Positive inversion		NEGA, POSI	POSI
Detail signal output		ON, OFF	OFF
RS232C baud rate		9600bps, 19200bps	9600bps

4. NAMES AND FUNCTIONS

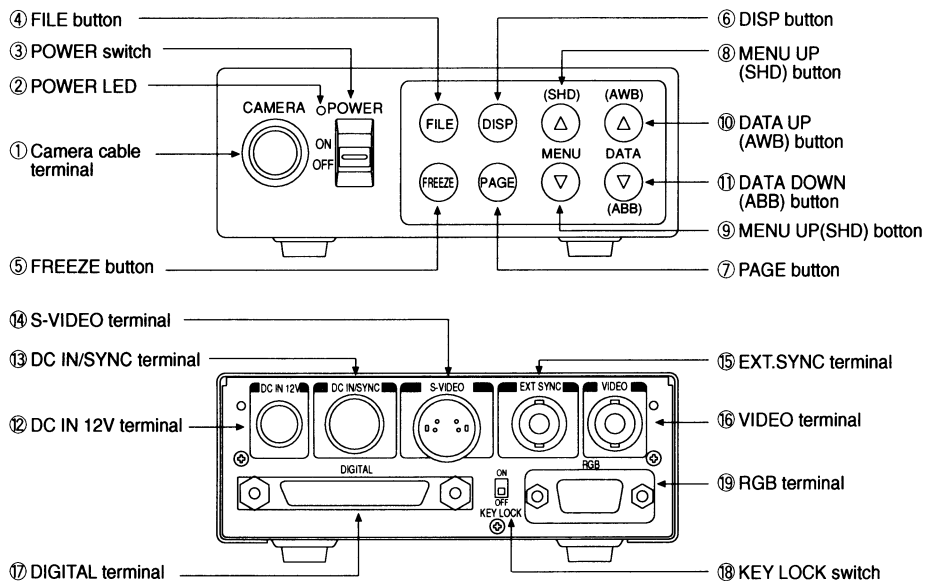

① Camera cable terminal	The camera cable is connected.
② POWER LED	Lights when the power is turned on.
③ POWER switch	Turns on or off the power supply.
④ FILE button	Used when switching the scene files.
⑤ FREEZE button	Used when switching to the freeze menu and when returning from the freeze menu to the camera menu.
⑥ DISP button	Used when switching the display.
⑦ PAGE button	Used when switching to the menu and when selecting the menus.
⑧ MENU UP (SHD) button	Select the function to be confirmed or changed on the menu. (Also used when performing the auto shading correction.)
⑨ MENU DOWN button	Select to confirm the function or to change the menu.
⑩ DATA UP (AWB) button	Changes the value of the function selected by the MENU (UP/DOWN) button. (Also used when using AWB.)
⑪ DATA DOWN (ABB) button	Changes the value of the function selected by the MENU (UP/DOWN) button. (Also used when using ABB.)
⑫ DC IN 12V terminal	Accept a DC power input (12V).
⑬ DC IN / SYNC terminal	HD and VD signals are input/output. When the random trigger operation is used, the trigger signal is input and the index signal is output.
⑭ S—VIDEO terminal	Outputs Y (luminance) and C (color) signals.
⑮ EXT. SYNC terminal	Used when the camera output signal is synchronized by the external signal. (BNC connector)
⑯ VIDEO terminal	Outputs VBS output. Connected to a monitor, VTR, etc. (BNC connector)
⑰ DIGITAL terminal	LVDS format digital video signal output and control signal input/output terminal. This terminal also includes an RS232C format external control pin.
⑱ KEY LOCK switch	Enables/disables buttons ④ to ⑪.
⑲ RGB terminal	Used as the connector terminal for Y/C or VBS output, RGB or Y/P _r /P _b output, and SYNC output.

5. CONNECTION

5. 1 Standard Connection

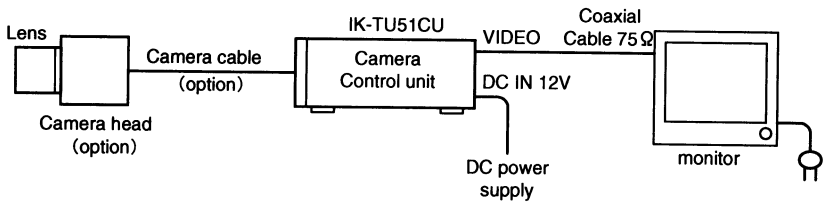

5. 2 Caution on Connection

- Please use only optional camera heads model # JK-TU52H or JK-TU53H with this camera controller. Use of another head may cause damage.
- When connecting the camera cables, be sure to turn off the camera control unit and the other equipment connected.
- For DC power supply connecting to DC IN 12V terminal, use UL listed and/or CSA approved ungrounding type AC adaptor with the specifications described below.

Power supply voltage : DC12V±10%

Current rating : More than 830mA, Less than 2.5A

Ripple voltage : Less than 50mV(p-p)

Connector : HR10A-7P-4S by HIROSE electronics Co. Ltd

Pins 1, 2 : 12V

Pins 3, 4 : GND

- If the screw on the camera connector portion of the camera cable loosens, noise may appear on the screen. So be sure to tighten the connector fully.
- Please use optional camera head JK-TU52H or JK-TU53H exclusively. Using other camera head may cause trouble.

5. 3 Connection on Back Panel

Back panel view

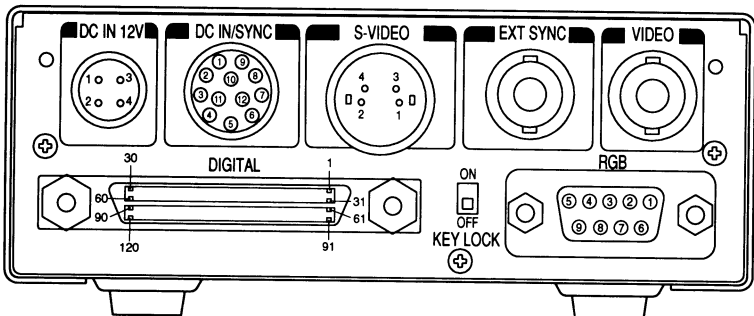

5. 3A Connector Pin Assignments

DC IN 12V

1	+12V
2	+12V
3	GND
4	GND

DC IN/SYNC

1	GND
2	+12V
3	GND(for INDEX)
4	INDEX
5	GND(for HD)
6	HD OUT
7	VD OUT
8	GND(for TRIGGER)
9	TRIGGER
10	VD IN
11	HD IN
12	GND(for VD)

S-VIDEO

1	GND
2	GND
3	Y
4	C

RGB

1	GND(for VBS,Y/C)
2	GND(for R/G/B,Y/Ps/Ps)
3	R/P _r OUT
4	G/Y OUT
5	B/P _b OUT
6	VBS/Y OUT
7	SYNC OUT
8	GND(for SYNC)
9	-/C OUT

DIGITAL

1	R0 (+)	31	R0 (-)	61	GND	91	GND
2	R1 (+)	32	R1 (-)	62	PIXEL CLK (+)	92	PIXEL CLK (-)
3	R2 (+)	33	R2 (-)	63	FRAME EN (+)	93	FRAME EN (-)
4	R3 (+)	34	R3 (-)	64	FIELD ID (+)	94	FIELD ID (-)
5	R4 (+)	35	R4 (-)	65	LINE EN (+)	95	LINE EN (-)
6	R5 (+)	36	R5 (-)	66	TRIGGER D (+)	96	TRIGGER D (-)
7	R6 (+)	37	R6 (-)	67	RESERVE(OUT +)	97	RESERVE(OUT -)
8	R7 (+)	38	R7 (-)	68	GND	98	GND
9	R8 (+)	39	R8 (-)	69	GND	99	GND
10	R9 (+)	40	R9 (-)	70	GND	100	GND
11	G0 (+)	41	G0 (-)	71	GND	101	GND
12	G1 (+)	42	G1 (-)	72	GND	102	GND
13	G2 (+)	43	G2 (-)	73	GND	103	GND
14	G3 (+)	44	G3 (-)	74	GND	104	GND
15	G4 (+)	45	G4 (-)	75	GND	105	GND
16	G5 (+)	46	G5 (-)	76	GND	106	GND
17	G6 (+)	47	G6 (-)	77	GND	107	GND
18	G7 (+)	48	G7 (-)	78	GND	108	GND
19	G8 (+)	49	G8 (-)	79	GND	109	GND
20	G9 (+)	50	G9 (-)	80	GND	110	GND
21	B0 (+)	51	B0 (-)	81	GND	111	GND
22	B1 (+)	52	B1 (-)	82	GND	112	GND
23	B2 (+)	53	B2 (-)	83	GND	113	GND
24	B3 (+)	54	B3 (-)	84	GND	114	GND
25	B4 (+)	55	B4 (-)	85	GND	115	GND
26	B5 (+)	56	B5 (-)	86	GND	116	GND
27	B6 (+)	57	B6 (-)	87	TXD	117	NC
28	B7 (+)	58	B7 (-)	88	FXD	118	NC
29	B8 (+)	59	B8 (-)	89	GND	119	NC
30	B9 (+)	60	B9 (-)	90	GND	120	GND

* When using pins to remote(pins 87 to 89), please consult with your dealer.

Precautions on DIGITAL terminal :

- Interference occurring inside the cable may accidentally activate the Trigger if the TRIGGER D inputs (pins 66 and 96) are open.
If the TRIGGER D input is not used, the TRIGGER D input pin should be either not connected or connected to RESERVE output pin (pins 67 and 97) ie: (connect pin 66 to pin 67 and pin 96 to 97).
- The RESERVE pins (pins 67 and 97) are provided for an additional output. If unused they should be OPEN or connected to Trigger D.
- NC pins (pins 117 to 119) should be left OPEN.

6. OPERATION

- ① Referring to the item " 5. CONNECTION", connect each equipment correctly.
- ② Turn on the connected equipment and the camera.
- ③ When using the camera for the first time and when replacing the camera cable and the camera head, be sure to operate the ABB adjustment in advance, referring to the item "6.1 Automatic Black Balance".
- ④ Facing the lens to the object, operate the lens iris adjustment, focus adjustment, etc.
- ⑤ Referring to the item "6.2 White Balance", operate the adjustment.
- ⑥ Referring to the items "6.3 Scene File, 6.4 Gain, 7. MODE SETTING BY ON SCREEN DISPLAY", select the necessary items.

6. 1 Automatic Black Balance

Black balance adjustment is necessary to get the correct black picture level.

- Close the lens iris.
- If the color bar pattern is displayed on the screen or if the index menu/menu is displayed, press the [DISP] button to disable the color bar pattern or the character display. If the camera is in Freeze Mode, perform the cancellation procedure (refer to the item "6.6 Freeze Operation") to return the camera to Live Image Mode.
- Hold the [DATA DOWN] button for approx. 1 second.
- When the black balance adjustment operation starts, the character ABB blinks on the screen.
- When the black balance adjustment operation finishes, the character ABB ends blinking and the result appears for approx. 1 second.

Display	Meaning
ABB OK	Automatic black balance adjustment finished correctly.
ABB NG CLOSE LENS	Automatic black balance adjustment cannot be performed because the lens iris is open. Close the lens iris.
ABB NG	Automatic black balance adjustment cannot be performed. Operate the automatic black balance again.

6. 2 White Balance

For the white balance adjustment for this unit, ATW (Automatic Trace White balance), AWB (Automatic White Balance) and MANUAL (Manual white balance) adjustments are provided. Referring to the items "7.2 (3) WHT BAL (White balance), 7. MODE SETTING BY ON SCREEN DISPLAY", select the desired mode.

	ATW (Automatic Trace White Balance)	AWB (Automatic White Balance)	MANUAL (Manual White Balance)
Outline	Camera measures the object color temperature and adjust the white balance automatically.	Adjust white balance by displaying the white object inside the area set by AWB menu and pressing the [DATA UP] button.	Adjust the white balance manually using the WHT BAL menu while shooting the white object.
Features	Traces variations of color temperature and adjusts the white balance automatically.	Measurement accuracy is higher than ATW. This mode is effective when shooting under less variations of color temperature.	Artificial white balance setting can be set. The manual adjustment is most effective under shooting condition with no color temperature variation.
Notes	If an illumination is low, white balance may not be corrected. When the shutter mode is EXT TRIG or long the long period exposure mode, ATW is not available.	When the shutter mode is EXT TRIG, AWB is not available.	Adjustment is performed by confirming with a vector scope.

① AWB(Automatic white balance)

- Set the MODE to AWB on the WHT BAL menu.

Perform the C.TEMP (color temperature conversion) setting, if necessary.

(Refer to the item "7.2 (3) WHT BAL (White balance)".)

3200K: Appropriate for indoor shooting.

5600K: Appropriate for outdoor shooting.

- If the color bar pattern is displayed on the screen or if the index menu/menu is displayed, press the [DISP] button to disable the color bar pattern or the character display on the menu. If the camera is in Freeze Mode, perform the cancellation procedure (refer to the item "6.6 Freeze Operation") to return the camera to Live Image Mode.
- Shoot a known white object entirely in the area set by the AWB menu (refer to the item "7.2 (3) (3.1) (d) Changing AWB zone area") and push [DATA UP] button for approx. 1 second.
- The character AWB blinks on the screen when the AWB starts.
- The character AWB ends blinking when the AWB finishes, and the result is displayed for approx. 1 second.

Display	Meaning
AWB OK	Automatic white balance adjustment finished correctly.
AWB NG LEVEL LOW	Automatic white balance adjustment cannot be performed because the video level is too low. Set the video level properly.
AWB NG LEVEL HIGH	Automatic white balance adjustment cannot be performed because the video level is too high. Set the video level properly.
AWB NG C. TEMP LOW	Automatic white balance adjustment cannot be performed because the color temperature is too low. If the C.TEMP is set to 5600K, set to 3200K. If the message appears with the C.TEMP set to 3200K, change the illumination or use a color temperature conversion filter.
AWB NG C. TEMP HIGH	Automatic white balance adjustment cannot be performed because the color temperature is too high. If the C.TEMP is set to 3200K, set to 5600K. If the message appears with the C.TEMP set to 5600K, change the illumination or use the color temperature conversion filter.
AWB NG NOT AVAILABLE	Automatic white balance adjustment cannot be performed because the shutter speed mode is EXT TRIG mode.
AWB NG	Automatic white balance adjustment cannot be performed for other reasons. Such as no white area is included in an object, etc.

② MANUAL(Manual white balance)

- Set the MODE to MANUAL on the WHT BAL menu.
(Refer to the item "7.2 (3) WHT BAL (white balance)".)
- Shoot a known white object, adjust the white balance adjusting the levels of R GAIN and B GAIN on the menu, confirming with a monitor or a vector scope.
(Refer to the item "7.2 (3) (3.3) Changing each setting in MANUAL mode".)

6. 3 Scene File

Three scene files (A, B, C) are available as user memories for this unit. These are selectable depending on shooting conditions. By using the [FILE] button, the camera operation is changed immediately from the currently selected Scene File to the next. (Refer to the item "7. MODE SETTING BY ON SCREEN DISPLAY".)

- While any menu is displayed, pressing the [FILE] button will display the menu settings for the next Scene File:



- When the [FILE] button is pressed while the camera is in live image mode, the current scene file selection at that time is displayed for approx. 3 seconds in the upper right corner of the screen. If the [FILE] button is pressed again while the position is displayed, the scene file cycles as described above.

6. 4 Gain

When the image is dark even if the lens iris is open, change the gain (video gain) to get the proper video level.

For the gain adjustment of the unit, AUTO (Automatic gain control), MANUAL (Manual), OFF (0 dB) modes are provided. Select the mode on the GAIN menu. (Refer to the item "7.2 (2) GAIN (Video gain)".)

① AUTO(Automatic gain control)

When the output is low, the gain is automatically adjusted to a suitable video level.

The maximum value of the gain is 20dB, and can be set from 0 to 20dB in 1dB steps. (Refer to the item "7.2 (2) (2.1) Changing the maximum gain in AUTO (Automatic gain control) mode".)

Video level (LEVEL), peak average value ratio (PEAK/AVE), and measurement light area (AREA) is same as the setting on the automatic shutter. (Refer to the item "7.2 (1) (1.1) Changing each setting in AUTO mode".)

② MANUAL(Manual gain)

Gain adjustment is performed on the GAIN menu. The adjustment range is from 0 to 20dB in 1dB steps.

(Refer to the item "7.2 (2) (2.2) Changing the gain in MANUAL mode".)

③ OFF

Gain is fixed at 0 dB.

6. 5 Shading Correction

Due to the lens used or the environmental condition, color shading may occur at the upper and lower side of the screen. In this case, the shading correction can decrease the color shading. For the shading correction of the unit, SET (Automatic shading correction), MANUAL (Manual shading correction), and OFF (no shading correction) modes are provided. Select the mode on the OPTION menu. (Refer to the item "7.2 (7) (7.3) Changing shading correction mode".)

① SET(Auto shading)

- When the shutter speed mode is set to EXT TRIG or the SS long period exposure mode, the automatic shading correction cannot be performed.
- If the color bar pattern is displayed on the screen or if the index menu/menu is displayed, press the [DISP] button to remove them from the screen. If the camera is in Freeze Mode, perform the cancellation procedure (refer to the item "6.6 Freeze Operation") to return the camera to Live Image Mode.
- Push the [MENU UP] button for approx. 1 second.
- When the automatic shading correction operation starts, the character SHD blinks on the screen.
- When the automatic shading correction operation terminates, the character SHD ends blinking and the result is displayed for approx. 1 second.

Display	Meaning
SHD OK	Automatic shading correction operation terminated correctly.
SHD OK LIMIT	Automatic shading correction operation terminated, however, the correction necessary exceeds the camera's range so the maximum possible value is applied.
SHD NG LEVEL LOW	Automatic shading correction cannot be performed because the video level is too low. Set the video level properly.
SHD NG LEVEL HIGH	Automatic shading correction cannot be performed because the video level is too high. Set the video level properly.
SHD NG NOT AVAILABLE	Automatic shading correction operation cannot be performed because the shutter speed mode is the EXT TRIG mode or the SS long period exposure mode.

② MANUAL(Manual Shading)

Perform the correction amount setting on the OPTION menu, confirming with a monitor or a vector scope. (Refer to the "7.2 (7) (7.4) Changing the manual shading correction setting".)

③ OFF

The status is no shading correction.

* **The shading correction is effective when the lens iris or zoom ratio is fixed. Use the unit with SHADING OFF for variable lens conditions.**

6. 6 Freeze Operation

- Freeze Mode Operation is only possible when no menu character display or color bar is on the screen.
- Freeze Mode Operation is not possible when the shutter mode is set to EXT TRIG.
- The method of toggling between Live Image Mode and Freeze Mode differs according to the shutter menu's FREEZE INPUT setting.
 - When set to FRONT : The mode is toggled using the FREEZE button on the front panel.
 - When set to TRIG \uparrow : The mode is toggled at the rising edge of the trigger terminal input.
 - When set to TRIG \downarrow : The mode is toggled at the falling edge of the trigger terminal input.
- When the OPTION menu's FREEZE DISP setting is set to ON, "FREEZE" is indicated at the upper right corner of the screen.
- During Freeze Mode Operation, the [DISP], [PAGE], [MENU UP], [MENU DOWN], [DATA UP], [DATA DOWN] and [FILE] buttons are disabled.

7. MODE SETTING BY ON SCREEN DISPLAY

Various settings can be controlled on the unit by using the on screen menu displayed on the monitor. The contents once set are memorized in the scene files (A, B, C) selected, so if the power turns off, it is unnecessary to set again when using the unit next time. When the setting is performed, select the menu of the item to be set.

7. 1 Using the Menus

When the power turns on, the normal screen showing only the video signal appears. Change the output to each screen (video signal output, color bar screen, Index menu, menus, and area menu) by using the [DISP], [PAGE], [MENU UP], and [MENU DOWN] buttons.

* A menu is selected when pushing the [PAGE] button after moving the "—" on the screen by the [MENU UP], [MENU DOWN] button while the Index menu is displayed.

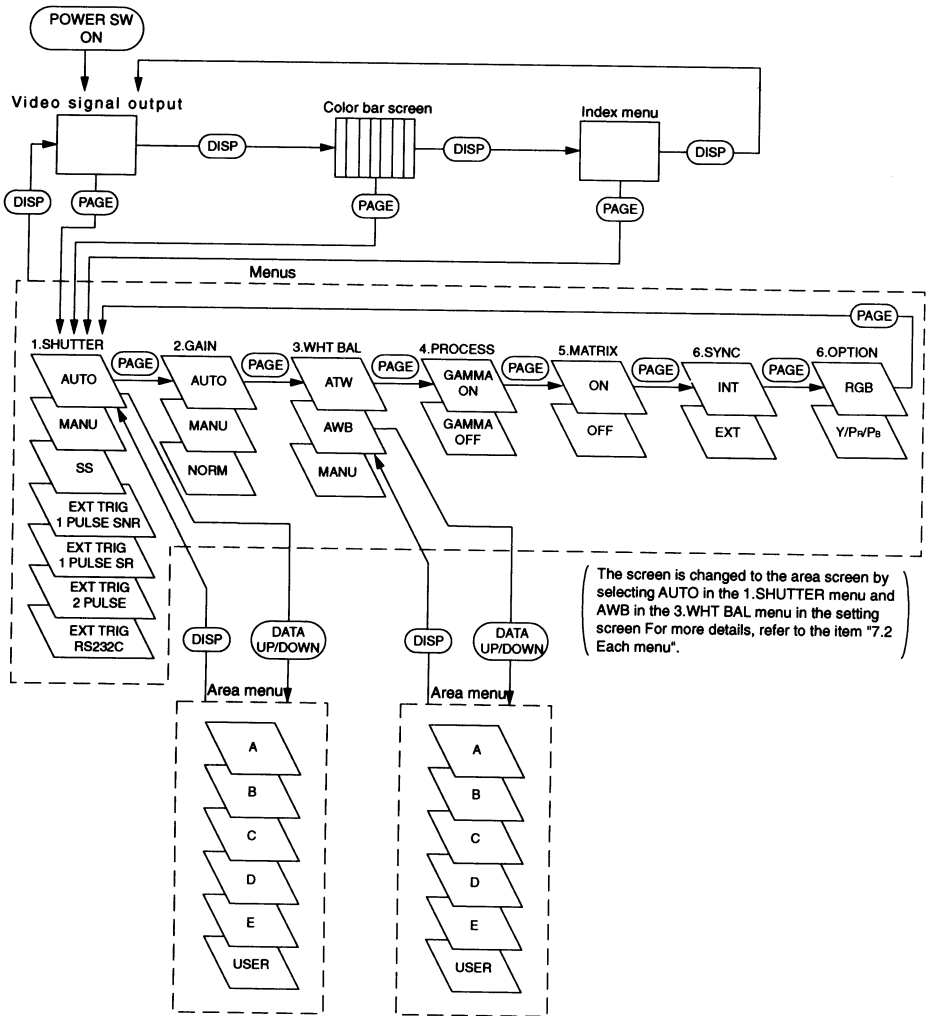

7. 2 Menus

- Select the menu to change the setting by referring the item "7.1 Using the Menu".)
- When the [MENU UP], [MENU DOWN] buttons are pushed, the "→" on the screen moves up and down. Move the "→" to the item to change.

(1) SHUTTER (Electronic shutter)

The electronic shutter has four modes; AUTO, MANUAL, SS(Synchro. Scan), EXT TRIG(External trigger). Press the "Page" button to enter the Shutter Page. Use the "Data Up/Down" buttons to select the Shutter Mode.

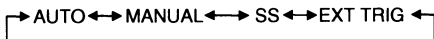

AUTO : The exposure time is controlled automatically to obtain the video level set.

MANUAL : It is possible to select the exposure time from eight speed settings; OFF (1/60s), 1/100s, 1/250s, 1/500s, 1/1000s, 1/2000s, 1/4000s, 1/10000s.

Note:

When setting a rapid shutter speed, sensitivity degrades according to the speed. When a discharging light such as fluorescent lamp, etc. is used for the illumination, the flicker may be large.

SS : Shutter speed can be set by the horizontal scanning time (1H) unit or by the frame unit.

EXT TRIG : Exposure is performed and images are output by external trigger. EXT TRIG includes the four modes described below. (For details of specifications, refer to the item "7.5 EXT TRIG (External trigger)".)

●1 PULSE SNR (1 Pulse Sync Non Reset)

The charge begins to accumulate after the trigger pulse is received, and 1 field images are output according to the internal vertical sync signal timing. The exposure/accumulation time can be set from 0.06 to 16 ms. The trigger signal timing can be set to either the rising or falling edge.

●1 PULSE SR (1 Pulse Sync Reset)

The charge begins to accumulate after the trigger pulse is received. Upon completion of accumulation the vertical sync signal is reset and 1 field images are output. The exposure/accumulation time can be set from 0.06 to 16 ms. The trigger signal timing can be set to either the rising or falling edge.

●2 PULSE

The charge begins to accumulate after the trigger pulse is received. Upon completion of accumulation the vertical sync signal is reset and 1 field images are output. The exposure/accumulation time is the time from when the first trigger signal is taken in until the next trigger signal is taken in. The trigger signal intake timing can be set to one of three settings: rising edge, falling edge or pulse width (front and back edges of pulse).

●RS232C

Accumulation of charges is started and ended by RS232C external control command input, and 1 field images are output without changing the vertical sync signal timing.

(1. 1) Changing each setting in AUTO mode

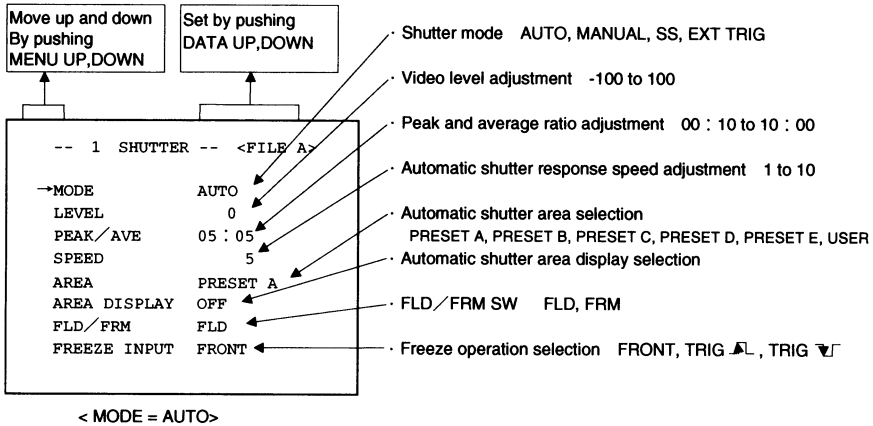

(a) Changing the video level in the automatic shutter mode

- ① Set the "→" to LEVEL by pushing [MENU UP], [MENU DOWN] buttons.
- ② Set the video level by pushing [DATA UP], [DATA DOWN] buttons.

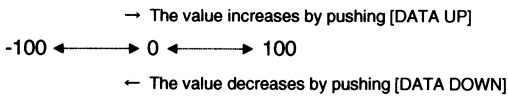

(b) Changing the automatic shutter detection (ratio between peak and average value)

- ① Set the "→" to PEAK/AVE by pushing [MENU UP], [MENU DOWN] buttons.
- ② Set the ratio between peak and average value by pushing [DATA UP], [DATA DOWN] buttons.

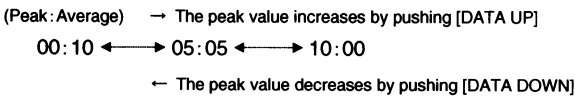

(c) Changing the automatic shutter response speed

- ① Set the "→" to SPEED by pushing [MENU UP], [MENU DOWN] buttons.
- ② Set the response speed by pushing [DATA UP], [DATA DOWN] buttons.

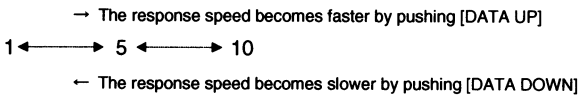

(d) Changing the automatic shutter zone area

- ① Set the "→" to AREA by pushing [MENU UP], [MENU DOWN] buttons.
- ② Set the measurement light area by pushing [DATA UP], [DATA DOWN] buttons.

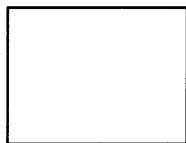
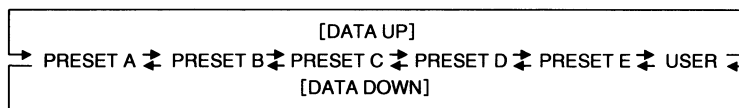

PRESET A

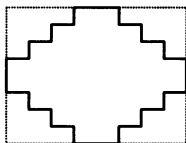

PRESET B

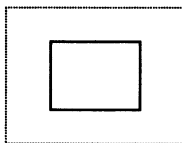

PRESET C

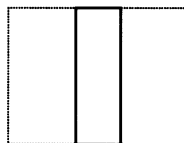

PRESET D

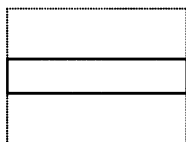

PRESET E

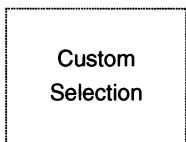

USER

(e) Confirming the contents of the measurement light area selected by the automatic shutter

- ① Set the "→" to AREA DISP by pushing [MENU UP], [MENU DOWN] buttons.
- ② Area screen appears by pushing [DATA UP], [DATA DOWN] buttons.

When AREA is set to USER, the setting can be changed on the area menu. When changing the area, refer to the item "7.2 (8) Setting USER area".

- ③ Push the [DISP] button to return to the menu.

(f) Changing the CCD storage mode

- ① Set the "→" to FLD/FRM by pushing [MENU UP], [MENU DOWN] buttons.
- ② Select either FLD (field) or FRM (frame) by pushing [DATA UP], [DATA DOWN] buttons.

(g) Changing the freeze operation setting

- ① Set the "→" to FREEZE INPUT by pushing [MENU UP], [MENU DOWN] buttons.
- ② Set the freeze operation by pushing [DATA UP], [DATA DOWN] buttons.

When set to FRONT : The Freeze Operation is performed by using the FREEZE button on the front panel.

When set to TRIG  : The Freeze Operation is performed at the rising edge of the rear TRIG input.

When set to TRIG  : The Freeze Operation is performed at the falling edge of the rear TRIG input.

(1. 2) Changing each setting in MANU mode

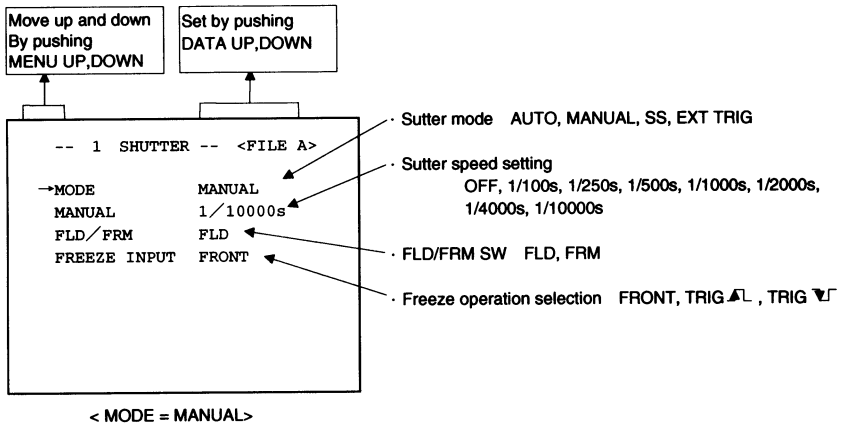

(a) Changing the shutter speed

- ① Set the "→" to MANU by pushing [MENU UP], [MENU DOWN] buttons.
- ② Set the shutter speed by pushing [DATA UP], [DATA DOWN] buttons.

[DATA UP] →

OFF ↔ 1/100s ↔ 1/250s ↔ 1/500s ↔ 1/1000s ↔ 1/2000s ↔ 1/4000s ↔ 1/10000s

← [DATA DOWN]

(b) Changing the CCD storage mode

- ① Set the "→" to FLD/FRM by pushing [MENU UP], [MENU DOWN] buttons.
- ② Select either FLD (field) or FRM (frame) by pushing [DATA UP], [DATA DOWN] buttons.

(c) Changing the freeze operation setting

- ① Set the "→" to FREEZE INPUT by pushing [MENU UP], [MENU DOWN] buttons.
- ② Set the freeze operation by pushing [DATA UP], [DATA DOWN] buttons.

When set to FRONT : The Freeze Operation is performed by using the FREEZE button on the front panel.

When set to TRIG \uparrow : The Freeze Operation is performed at the rising edge of the rear TRIG input.

When set to TRIG \downarrow : The Freeze Operation is performed at the falling edge of the rear TRIG input.

(1. 3) Changing each setting in SS(synchro. scan) mode

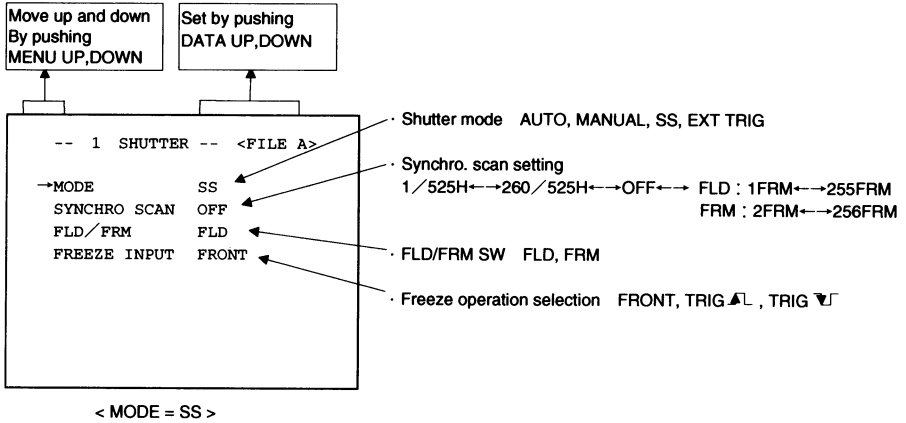

(a) Changing the shutter speed setting

- ① Set the "→" to SYNCHRO SCAN by pushing [MENU UP], [MENU DOWN] buttons.
- ② Select the shutter speed by pushing [DATA UP], [DATA DOWN] buttons.

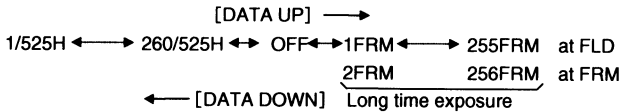

(b) Changing the CCD storage mode

- ① Set the "→" to FLD/FRM by pushing [MENU UP], [MENU DOWN] buttons.
- ② Select either FLD (field) or FRM (frame) by pushing [DATA UP], [DATA DOWN] buttons.

(c) Changing the freeze operation setting

- ① Set the "→" to FREEZE INPUT by pushing [MENU UP], [MENU DOWN] buttons.
- ② Set the freeze operation by pushing [DATA UP], [DATA DOWN] buttons.

When set to FRONT : The Freeze Operation is performed by using the FREEZE button on the front panel.

When set to TRIG \uparrow : The Freeze Operation is performed at the rising edge of the rear TRIG input.

When set to TRIG \downarrow : The Freeze Operation is performed at the falling edge of the rear TRIG input.

Note:

The longer the storage time with extended exposures, the more visible certain characteristics of CCD cameras become: fixed pattern noise, white pixels, etc.

(1. 4) Changing each setting in EXT TRIG mode

The EXT TRIG has four modes; 1PULSE SNR, 1PULSE SR, 2PULSE, RS232C.

First set the "→" to MODE and select EXT TRIG, then set the "→" to EXT TRIG and select the desired EXT TRIG mode.

(1. 4. 1) Changing each setting in 1PULSE SNR mode

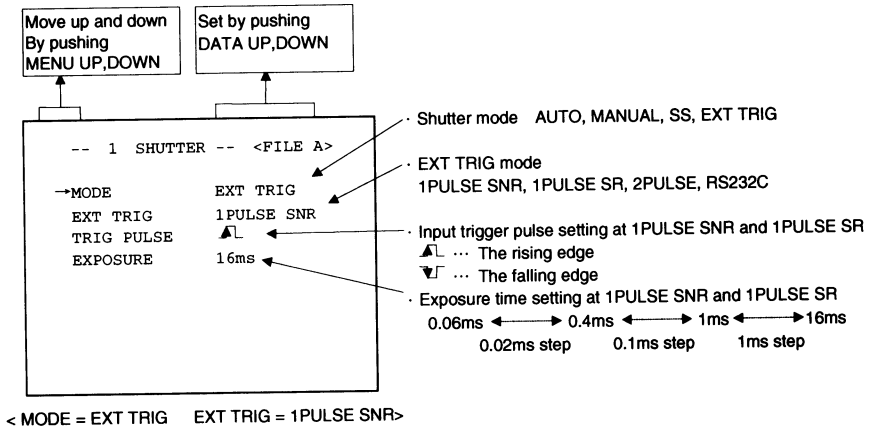

(a) Changing inputting trigger pulse setting

- ① Set the "→" to TRIG PULSE by pushing [MENU UP], [MENU DOWN] buttons.
- ② Select either ▲L or ▼L by pushing [DATA UP], [DATA DOWN] buttons.

* This setting is only valid in the 1PULSE mode (1PULSE SNR and 1PULSE SR). To make the trigger pulse setting when using the 2PULSE mode, first set the EXT TRIG mode to 2PULSE, then make the settings with the TRIG PULSE items.

(b) Changing 1PULSE exposure time setting

- ① Set the "→" to EXPOSURE by pushing [MENU UP], [MENU DOWN] buttons.
- ② Set the exposure time by pushing [DATA UP], [DATA DOWN] buttons.

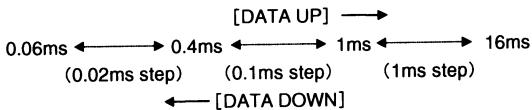

(1. 4. 2) Changing each setting in 1PULSE SR mode

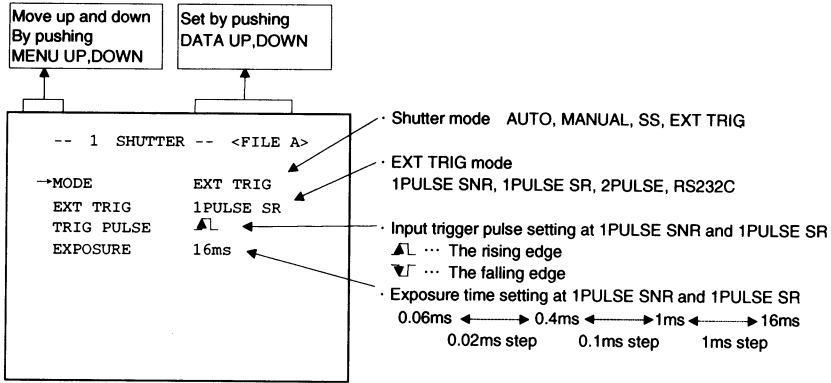

< MODE = EXT TRIG EXT TRIG = 1PULSE SR>

(a) Changing inputting trigger pulse setting

- ① Set the "→" to TRIG PULSE by pushing [MENU UP], [MENU DOWN] buttons.
- ② Select either ▲L or ▼L by pushing [DATA UP], [DATA DOWN] buttons.

* This setting is only valid in the 1PULSE mode (1PULSE SNR and 1PULSE SR). To make the trigger pulse setting when using the 2PULSE mode, first set the EXT TRIG mode to 2PULSE, then make the settings with the TRIG PULSE items.

(b) Changing 1PULSE exposure time setting

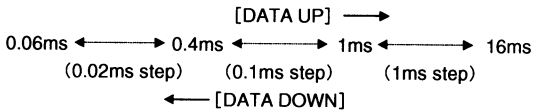

- ① Set the "→" to EXPOSURE by pushing [MENU UP], [MENU DOWN] buttons.
- ② Set the exposure time by pushing [DATA UP], [DATA DOWN] buttons.

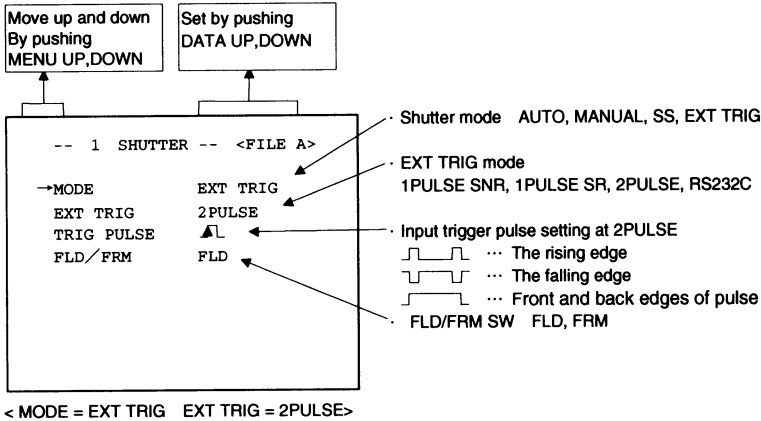

(1. 4. 3) Changing each setting in 2PULSE mode



(a) Changing inputting trigger pulse setting

- ① Set the "→" to TRIG PULSE by pushing [MENU UP], [MENU DOWN] buttons.
- ② Select either ,  or  by pushing [DATA UP], [DATA DOWN] buttons.

* This setting is only valid in the 2PULSE mode. To make the trigger pulse setting when using the 1PULSE mode, first set the EXT TRIG mode to 1PULSE SNR or 1PULSE SR, then make the settings with the TRIG PULSE items.

(b) Changing the CCD storage mode

- ① Set the "→" to FLD/FRM by pushing [MENU UP], [MENU DOWN] buttons.
- ② Select either FLD (field) or FRM (frame) by pushing [DATA UP], [DATA DOWN] buttons.

Note:

The longer the storage time with extended exposures, the more visible certain characteristics of CCD cameras become: fixed pattern noise, white pixels, etc.

(1. 4. 4) Changing each setting in RS232C mode

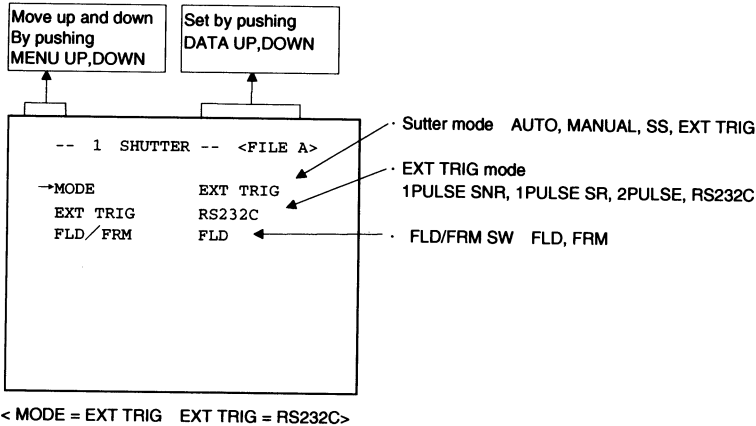

(b) Changing the CCD storage mode

- ① Set the "→" to FLD/FRM by pushing [MENU UP], [MENU DOWN] buttons.
- ② Select either FLD (field) or FRM (frame) by pushing [DATA UP], [DATA DOWN] buttons.

Note:

The longer the storage time with extended exposures, the more visible certain characteristics of CCD cameras become: fixed pattern noise, white pixels, etc.

(2) GAIN (Video gain)

The GAIN has three modes; AUTO, MANUAL, OFF.

Set the "→" to MODE, push the [DATA UP], [DATA DOWN], and select mode among AUTO, MANUAL, OFF.

In the OFF mode, gain is fixed to 0dB.

(2. 1) Changing the maximum gain in AUTO (Automatic gain control) mode

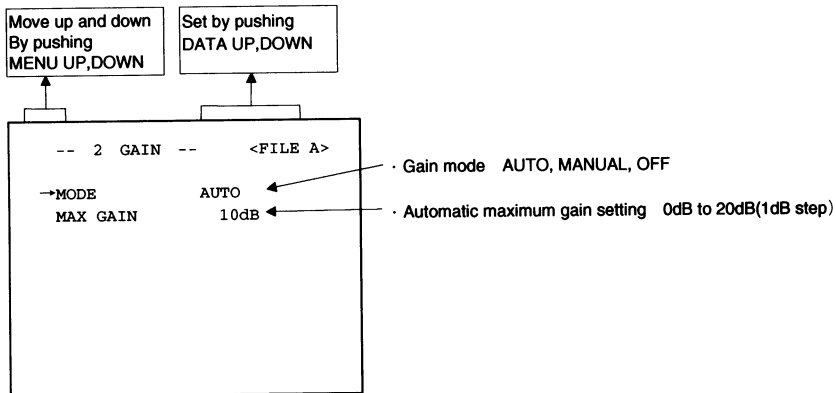

- ① Set the "→" to MAX GAIN by pushing [MENU UP], [MENU DOWN] buttons.
- ② Set the automatic maximum gain by pushing [DATA UP], [DATA DOWN] buttons.

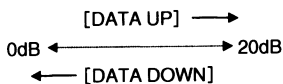

(2. 2) Changing the gain in MANUAL mode

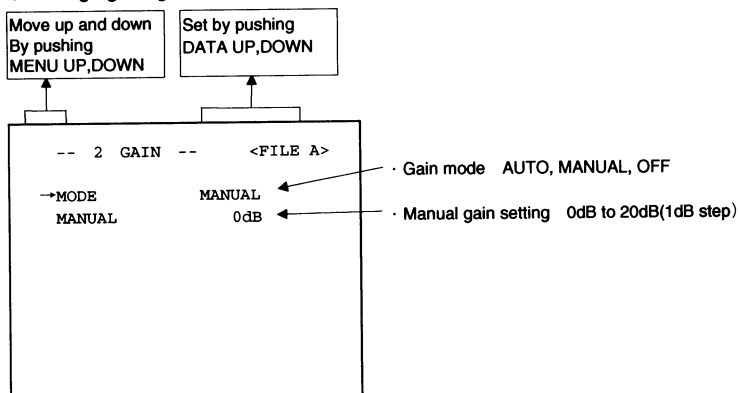

- ① Set the "→" to MANUAL by pushing [MENU UP], [MENU DOWN] buttons.
- ② Set the manual gain by pushing [DATA UP], [DATA DOWN] buttons.

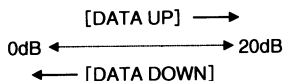

(3) WHT BAL(White balance)

The WHT BAL has three modes; AWB, ATW, MANUAL.

Set the "→" to MODE, push the [DATA UP], [DATA DOWN], and select mode among AWB, ATW, MANUAL.

(3. 1) Changing each setting in AWB(Automatic White Balance) mode

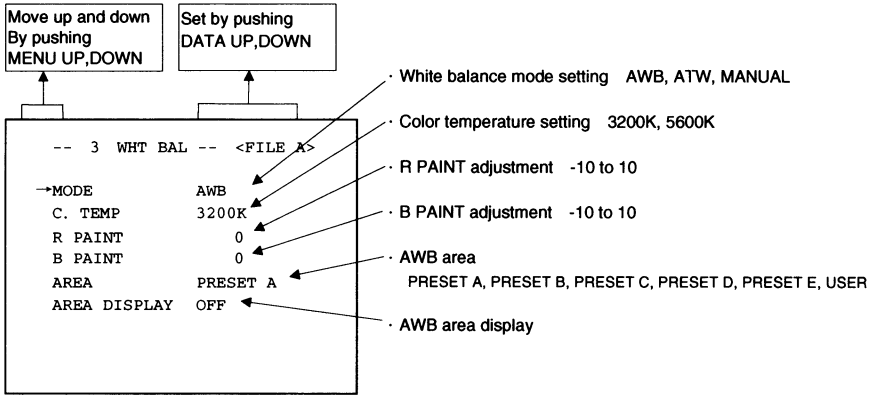

(a) Changing color temperature setting

- ① Set the "→" to C.TEMP by pushing [MENU UP], [MENU DOWN] buttons.
- ② Select either 3200K or 5600K by pushing [DATA UP], [DATA DOWN] buttons.

(b) Changing R PAINT

- ① Set the "→" to R PAINT by pushing [MENU UP], [MENU DOWN] buttons.
- ② Set the red paint by pushing [DATA UP], [DATA DOWN] buttons.

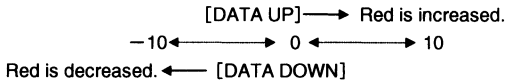

(c) Changing B PAINT

- ① Set the "→" to B PAINT by pushing [MENU UP], [MENU DOWN] buttons.
- ② Set the blue paint by pushing [DATA UP], [DATA DOWN] buttons.

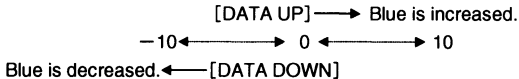

(d) Confirming the contents of the zone area selected by AWB

- ① Set the "→" to AREA DISP by pushing [MENU UP], [MENU DOWN] buttons.
- ② Select the area by pushing [DATA UP], [DATA DOWN] buttons.



PRESET A

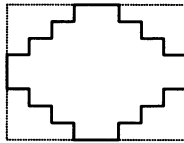

PRESET B

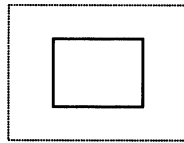

PRESET C

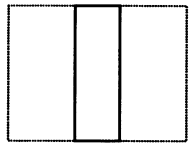

PRESET D

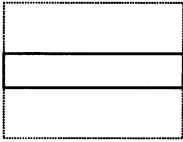

PRESET E



USER

(e) Confirming the contents of the zone area

- ① Set the "→" to AREA DISP by pushing [MENU UP], [MENU DOWN] buttons.
- ② Area screen appears by pushing [DATA UP], [DATA DOWN] buttons.

When AREA is set to USER, the setting can be changed on the area menu. When changing the area, refer to the item "7.2 (8) Setting USER area".

- ③ Push the [DISP] button to return to the menu.

(3. 2) Changing each setting in ATW(Automatic Trace White Balance) mode

Move up and down
By pushing
MENU UP,DOWN

Set by pushing
DATA UP,DOWN

White balance mode AWB, ATW, MANUAL

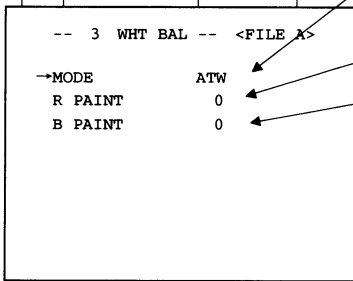

- R PAINT adjustment -10 to 10
- B PAINT adjustment -10 to 10

(a) Changing R PAINT

- ① Set the "→" to R PAINT by pushing [MENU UP], [MENU DOWN] buttons.
- ② Set the red paint by pushing [DATA UP], [DATA DOWN] buttons.

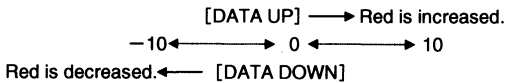

(b) Changing B PAINT

- ① Set the "→" to B PAINT by pushing [MENU UP], [MENU DOWN] buttons.
- ② Set the blue paint by pushing [DATA UP], [DATA DOWN] buttons.

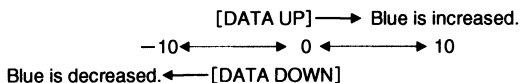

(3. 3) Changing the gain in MANUAL mode

Move up and down
By pushing
MENU UP,DOWN

Set by pushing
DATA UP,DOWN

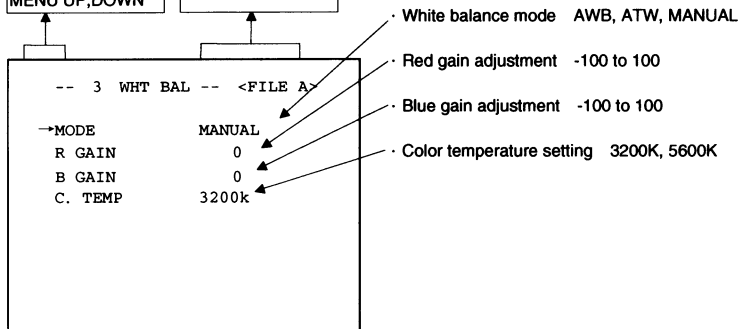

(1) Changing the red gain

- ① Set the "→" to R GAIN by pushing [MENU UP], [MENU DOWN] buttons.
- ② Set the red gain by pushing [DATA UP], [DATA DOWN] buttons.

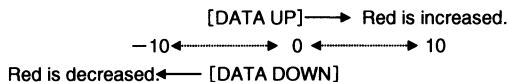

(2) Changing the blue gain

- ① Set the "→" to B GAIN by pushing [MENU UP], [MENU DOWN] buttons.
- ② Set the blue gain by pushing [DATA UP], [DATA DOWN] buttons.

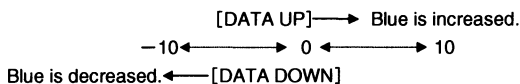

(4) PROCESS

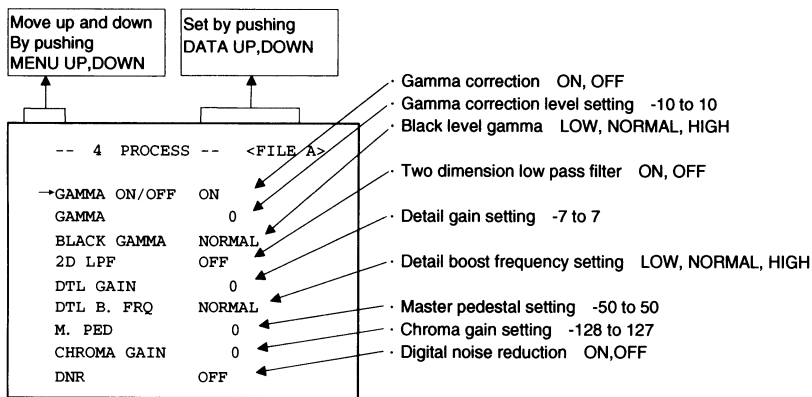

(4. 1) Changing the gamma correction ON/OFF

- ① Set the "→" to GAMMA ON/OFF by pushing [MENU UP], [MENU DOWN] buttons.
- ② Select either ON or OFF by pushing [DATA UP], [DATA DOWN] buttons.

When ON is selected, menu will show the GAMMA and BLACK GAMMA selections. When OFF is selected, GAMMA, BLACK GAMMA, and 2D LPF disappear. So the setting for GAMMA, BLACK GAMMA, and 2D LPF cannot be made. (2D LPF setting turns OFF.)

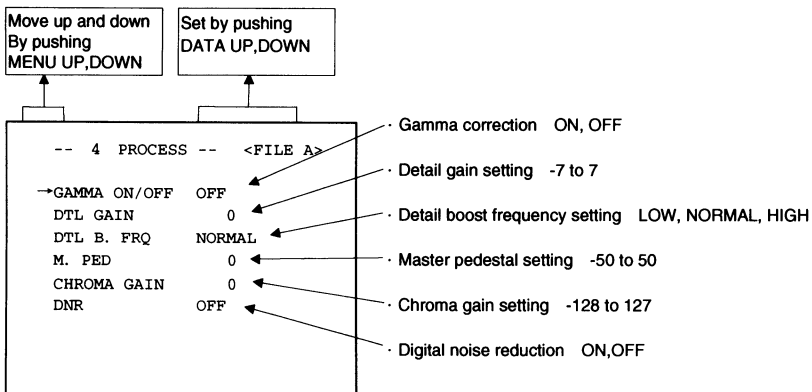

Menu when GAMMA OFF is selected.

(4. 2) Changing gamma correction level

- ① Set the "→" to GAMMA by pushing [MENU UP], [MENU DOWN] buttons.
- ② Set the gamma correction level by pushing [DATA UP], [DATA DOWN] buttons.

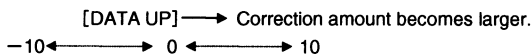

Correction amount becomes smaller. ← [DATA DOWN]

* When OFF is selected in GAMMA ON/OFF selection line, the display GAMMA turns off automatically. So the gamma correction level change cannot be changed.

(4. 3) Changing black gamma correction level

- ① Set the "→" to BLACK GAMMA by pushing [MENU UP], [MENU DOWN] buttons.
- ② Select black gamma correction by pushing [DATA UP], [DATA DOWN] buttons.

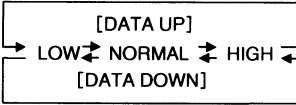

* When OFF is selected in GAMMA ON/OFF selection line, the display BLACK GAMMA turns off automatically. So the black gamma correction level change cannot be changed.

(4. 4) Changing two-dimension low pass filter

- ① Set the "→" to 2D LPF by pushing [MENU UP], [MENU DOWN] buttons.
 - ② Select either ON or OFF by pushing [DATA UP], [DATA DOWN] buttons.
- * When ON is selected, the cross color noise in VBS output is reduced.

Note:

Select OFF in step 2 described above when using signals other than the VBS output.

When OFF is selected in the GAMMA ON/OFF line or when DTL OUT ON is selected in the OPTION menu, the display 2D LPF turns off automatically. So 2D LPF change cannot be performed. (2D LPF is set to OFF.)

(4. 5) Changing detail (outline) gain

- ① Set the "→" to DTL GAIN by pushing [MENU UP], [MENU DOWN] buttons.
- ② Set the detail gain by pushing [DATA UP], [DATA DOWN] buttons.

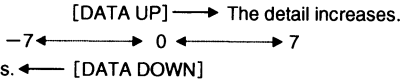

* When DTL OUT ON is selected in OPTION menu, the display DTL GAIN turns off automatically. So DTL GAIN change cannot be performed.

(4. 6) Changing detail boost frequency

- ① Set the "→" to DTL B.FREQ by pushing [MENU UP], [MENU DOWN] buttons.
- ② Set the detail boost frequency by pushing [DATA UP], [DATA DOWN] buttons.

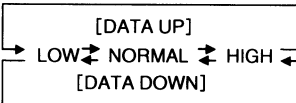

(4. 7) Changing master pedestal

- ① Set the "→" to M. PED by pushing [MENU UP], [MENU DOWN] buttons.
- ② Set the master pedestal by pushing [DATA UP], [DATA DOWN] buttons.

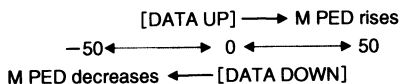

- * When DTL OUT ON is selected in OPTION menu, the display M. PED turns off automatically.
So the M. PED change cannot be performed.

-- 4 PROCESS -- <FILE A>	
→ GAMMA ON/OFF	ON
GAMMA	0
BLACK GAMMA	NORMAL
DTL B. FRQ	NORMAL
CHROMA GAIN	0
DNR	OFF

-- 4 PROCESS -- <FILE A>	
→ GAMMA ON/OFF	OFF
DTL B. FRQ	NORMAL
CHROMA GAIN	0
DNR	OFF

Menu when DTL OUT ON is selected in OPTION menu.

(4. 8) Changing CHROMA GAIN

- ① Set the "→" to CHROMA GAIN by pushing [MENU UP], [MENU DOWN] buttons.
- ② Set the chroma gain by pushing [DATA UP], [DATA DOWN] buttons.

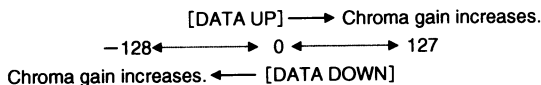

Note:

The chroma gain setting is only valid for VBS output signals and Y/C output signals. It is not valid for the RGB output in the RGB terminal, the Y/P_R/P_B outputs or the DIGITAL terminal's digital output signals.

(4. 9) Changing DNR (Digital Noise Reduction)

- ① Set the "→" to DNR by pushing [MENU UP], [MENU DOWN] buttons.
- ② Select either ON or OFF by pushing [DATA UP], [DATA DOWN] buttons.

Note:

When DNR is set to ON, noise is reduced, but the resolution decreases slightly.

(5) MATRIX(Matrix color correction)

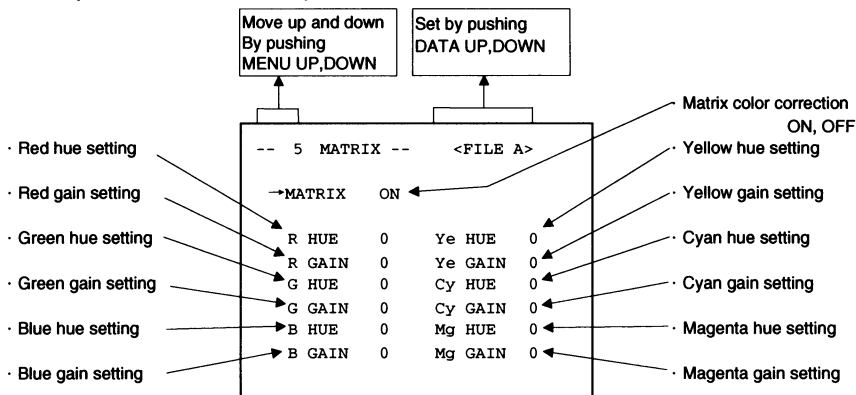

(5. 1) Changing Matrix color correction ON/OFF

- ① Set the "→" to MATRIX by pushing [MENU UP], [MENU DOWN] buttons.
- ② Select either ON or OFF by pushing [DATA UP], [DATA DOWN] buttons.

(5. 2) Changing each color of MATRIX setting

- ① Set the "→" to the desired item by pushing [MENU UP], [MENU DOWN] buttons.
- ② Set the color by pushing [DATA UP], [DATA DOWN] buttons.

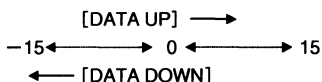

* When matrix color correction is set to OFF, the setting indications turn off, so the color cannot be set.

(6) SYNC

When an external sync signal is input, the display changes from INT (internal sync) to EXT (external sync) automatically.

INT ↔ EXT

(6. 1) INT screen

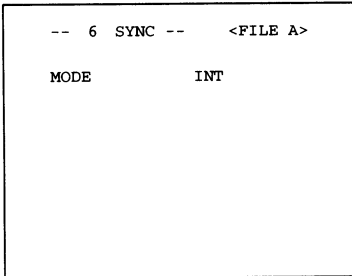

(6. 2) Changing EXT setting

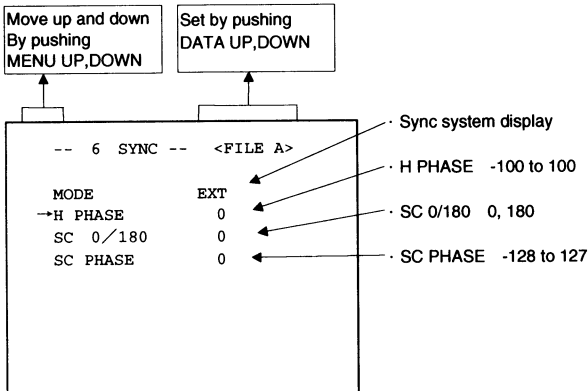

(a) Adjusting horizontal phase

- ① Set the "→" to H PHASE by pushing [MENU UP], [MENU DOWN] buttons.
- ② Adjust the horizontal phase by pushing [DATA UP], [DATA DOWN] buttons.

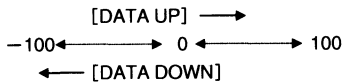

(b) Performing coarse adjustment of sub carrier phase

- ① Set the "→" to SC 0/180 by pushing [MENU UP], [MENU DOWN] buttons.
- ② Select either 0 or 180 by pushing [DATA UP], [DATA DOWN] buttons.

(c) Adjusting sub carrier phase

- ① Set the "→" to SC PHASE by pushing [MENU UP], [MENU DOWN] buttons.
- ② Adjust the sub carrier phase by pushing [DATA UP], [DATA DOWN] buttons.

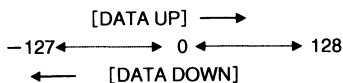

(7) OPTION

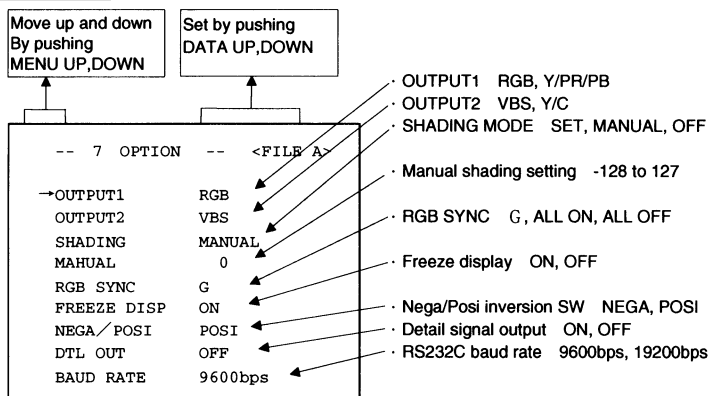

(7. 1) Changing OUTPUT1 output

- ① Set the "→" to OUTPUT1 by pushing [MENU UP], [MENU DOWN] buttons.
- ② Select either RGB or Y/PR/PB by pushing [DATA UP], [DATA DOWN] buttons.

(7. 2) Changing OUTPUT2 output

- ① Set the "→" to OUTPUT2 by pushing [MENU UP], [MENU DOWN] buttons.
- ② Select either VBS or Y/C by pushing [DATA UP], [DATA DOWN] buttons.

(7. 3) Changing shading correction mode

- ① Set the "→" to SHADING by pushing [MENU UP], [MENU DOWN] buttons.
- ② Select SET, MANUAL or OFF by pushing [DATA UP], [DATA DOWN] buttons.

(7. 4) Changing manual shading correction mode

- ① Set the "→" to MANUAL by pushing [MENU UP], [MENU DOWN] buttons.
- ② Set manual shading correction by pushing [DATA UP], [DATA DOWN] buttons.

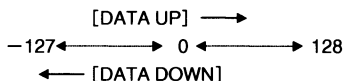

* When the shading correction mode is set to anything other than **MANUAL**, the display turns off, so the setting cannot be made.

(7. 5) Changing RGB SYNC

- ① Set the "→" to RGB SYNC by pushing [MENU UP], [MENU DOWN] buttons.
- ② Select G, ALL ON or ALL OFF by pushing [DATA UP], [DATA DOWN] buttons.

* When Y/PR/PB is selected at OUTPUT1, the display RGB SYNC turns off automatically. So RGB SYNC change cannot be performed.

(7. 6) Changing FREEZE DISP setting

- ① Set the "→" to FREEZE DISP by pushing [MENU UP], [MENU DOWN] buttons.
- ② Select either ON or OFF by pushing [DATA UP], [DATA DOWN] buttons. When ON is selected, the word "FREEZE" appears on the frozen image.

(7. 7) Changing Negative/Positive inversion switch

- ① Set the "→" to NEGA/POSI by pushing [MENU UP], [MENU DOWN] buttons.
- ② Select either NEGA (negative) or POSI (positive) by pushing [DATA UP], [DATA DOWN] buttons.

(7. 8) Changing detail signal output

- ① Set the "→" to DTL OUT by pushing [MENU UP], [MENU DOWN] buttons.
- ② Select either ON (detail signal only is output) or OFF (video signal) by pushing [DATA UP], [DATA DOWN] buttons.

(7. 9) Changing RS232C communication baud rate

- ① Set the "→" to BAUD RATE by pushing [MENU UP], [MENU DOWN] buttons.
- ② Select either 9600bps or 19200bps by pushing [DATA UP], [DATA DOWN] buttons.

(8) Setting USER area

- When USER is selected for the AREA of the automatic shutter or for AWB, the light measurement zones can be changed.
- The USER area is composed of 64 zones with 8 (vertical) x 8 (horizontal) areas, and each area can be set to ON/OFF.

- ① Set the output to area menu.

Set the output to the area menu by referring to the item "7.2 (1.1) (e) Confirming the contents of the measurement light area selected by automatic shutter" and "7.2 (3.1) (e) Confirming the contents of the measurement light area selected by AWB".

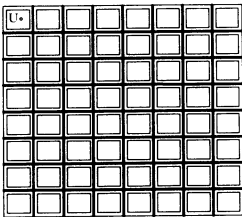

- ② Move the "o" to the zone to be appeared.

The display "o" moves up, down, left and right by pushing [MENU UP], [MENU DOWN], [DATA UP], [DATA DOWN] buttons.

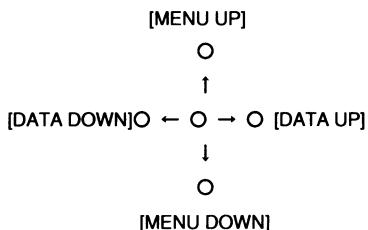

- ③ Select ON/OFF for the zone.

Select ON (effective) or OFF (ineffective) by pushing [PAGE] button.

When ON is selected, the display "□" appears on the screen and when OFF is selected, "□" turns off.

- ④ Push [DISP] button to return to the menu.

Note:

When OFF is selected for all 64 zones, the automatic shutter function and AWB function are not performed correctly. So do not select OFF for all.

(9) Setting to factory setting status

The contents set of each scene file can be returned to the factory default status (preset status).

(1) Select a file to set to the factory default status by [FILE] button.

(2) If the color bar pattern or characters are displayed on the screen, press the [DISP] button to disable the color bar pattern and character display. If the camera is in Freeze Mode, perform the cancellation procedure (refer to the item "6.6 Freeze Operation") to return the camera to Live Image Mode.

(3) Push [MENU DOWN] and [DATA DOWN] buttons simultaneously for approx. 1 second.

(4) The preset operation starts. When the preset operation finishes, the character PRESET OK is displayed for approx. 1 second.

7. 3 External Sync

When using the unit with an external sync signal, input VBS (composite video signal) or BS to EXT. SYNC terminal on the rear panel, or input HD and VD to DC IN/SYNC terminal. When the external sync signal is input, the camera automatically switches its sync from the internal sync to the external sync.

The operation is as shown below, depending on the unit's status and how external sync signals are input.

Unit's status	HD input	VD input	EXT. SYNC input	Operation
Shutter mode: EXT TRIG EXT TRIG: 1PULSE SR or 2PULSE	On	—	Off	Internal sync
	On	—	Off	External sync with HD (Only for H sync with HD)
	Off	—	VBS	External sync with VBS (H sync with HSYNC and SC sync)
	Off	—	SYNC	H sync with HSYNC
	On	—	VBS or SYNC	Prohibited *1
Others	On	On	Off	External sync with HD, VD (H·V sync with HD, VD)
	Off	Off	VBS	External sync with VBS (H·V sync and SC sync with H SYNC, V SYNC)
	Off	Off	SYNC	External sync with SYNC (H·V sync with H SYNC, V SYNC)
	Off	On	Off	External sync with VD (Only for VD reset)
	On	Off	Off	External sync with HD (Only for H sync with HD)
	Off	On	VBS or SYNC	Prohibited *1
	On	Off	VBS or SYNC	Prohibited *1
	On	On	VBS or SYNC	Prohibited *1

Note: Don't use combination *1.

— : Don't care.

(1) External sync signal input conditions

VBS, BS	: SYNC section	0.286±0.1V
(75Ω unbalanced)	Burst section	0.286±0.1V
HD	: 2 to 5V (p-p)	Negative
VD	: 2 to 5V (p-p)	Negative

(2) External sync frequency range

(External sync with VBS, SYNC)

For NTSC standard frequency : Within ± 50 ppm

(External sync with HD, VD)

For EIA standard frequency : Within $\pm 1\%$ (at horizontal sync frequency)

(3) Using the unit with external sync signal

Adjust H (horizontal) phase and SC (sub carrier) phase if necessary to match the output of multiple cameras.

When adjusting H (horizontal) phase and SC (sub carrier) phase, refer to the item "7.2 (6) SYNC".

(3. 1) H (horizontal) phase adjustment

Observe the external sync signal and the video signal output waveform of the unit with a dual trace oscilloscope, and adjust H phase so that the H phases match.

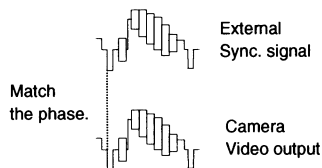

(3. 2) SC (Sub carrier) phase adjustment

When using the unit with external sync, the sub carrier signal phase of the video output signal of the unit can be adjusted. Perform a coarse adjustment for 0, and 180, in SC 0/180 and then perform a fine adjustment in SC PHASE. Using a vector scope for the phase adjustment will provide more accuracy.

7. 4 Synchro. Scan Operation

The shutter speed can be set by the horizontal scanning period (1H) or by the frame. Also, CCD integration mode can be set.

(1) Setting by 1H

260/525H to 1/525H stands for the setting by the 1H and the shutter speed can be set by the 1H (63.56ms).

(2) Setting by the frame

1FRM to 255FRM (at field storage) and 2FRM to 256FRM (at frame storage) stand for the setting (long period exposure) by the frame.

(a) Field storage period

The video signal stored during the frame period set is output as 1 field video image at a frame interval specified. Images stored in the memory are output until the following image output operation is performed.

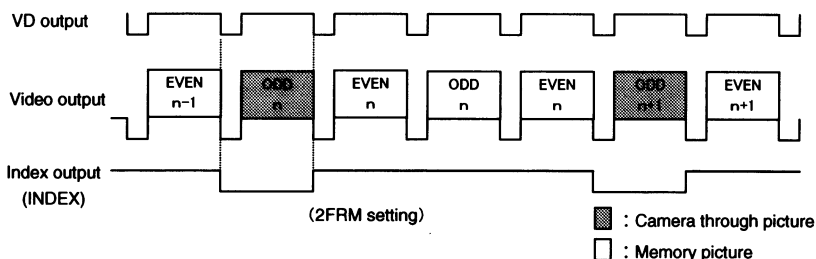

(b) Frame storage period

The video signal stored during the frame period set is output as 1 frame video image in a frame interval. Images stored in the memory are output until the following image output operation is performed.

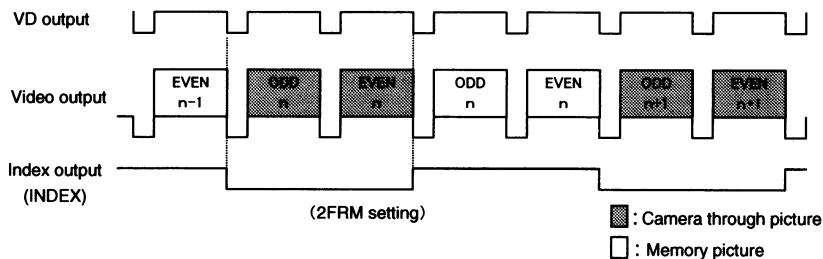

7. 5 EXT TRIG (External trigger)

Charge begins to accumulate after the trigger input operation (in the RS232C mode, by RS232C command input, in other modes, by trigger pulse (TRIGGER) input to the DC IN/SYNC terminal) or trigger signal input to the DIGITAL terminal and 1 field or 1 frame images are output. There are four modes: 1PULSE SNR, 1PULSE SR, 2PULSE and RS232C.

The DC IN/SYNC terminal trigger input and index output interface are as shown below.

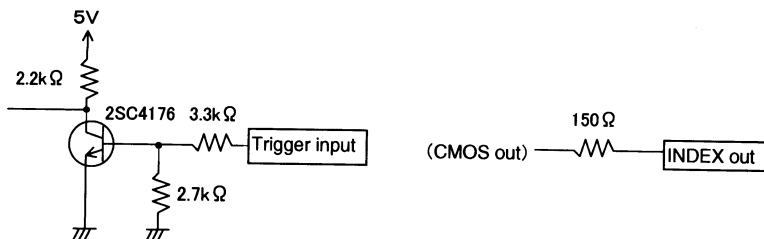

(1) 1 PULSE SNR (1 Pulse Sync Non Reset)

Charge begins to accumulate after the trigger input operation to the DC IN/SYNC terminal or trigger signal input (LVDS) to the DIGITAL terminal and 1 field images are output.

The exposure time is set to 0.06 to 16 ms on the menu.

Trigger pulse level : (Low Level): Less than 0.5V , (High Level): 3.4V to 5V

(DC IN/SYNC terminal)

Trigger pulse fetch timing : Rising edge / Falling edge selectable

Trigger pulse width : More than 2 μ s

Trigger pulse interval : More than 50ms

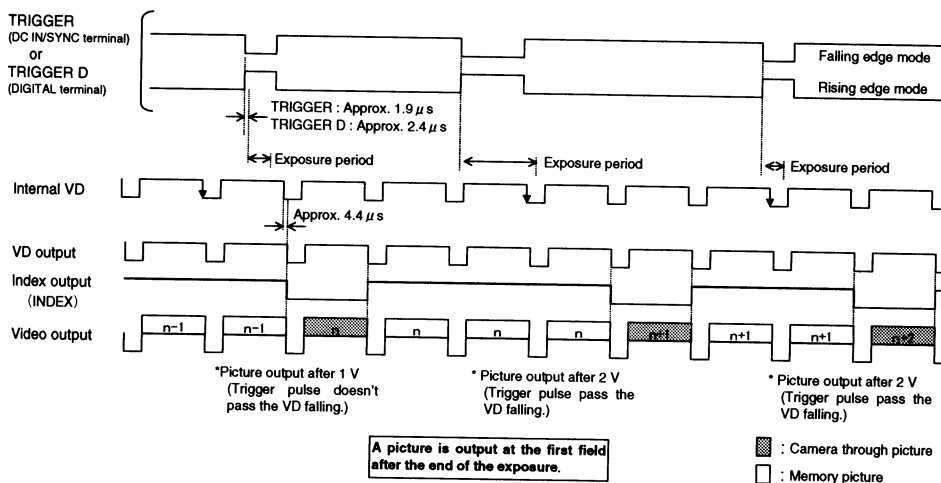

(2) 1 PULSE SR (1 Pulse Sync Reset)

Charge begins to accumulate after the trigger input operation to the DC IN/SYNC terminal or trigger signal input (LVDS) to the DIGITAL terminal, the vertical sync signal is reset and field images are output. The exposure time is set to 0.06 to 16 ms on the menu.

- Trigger pulse level : (Low Level) : Less than 0.5V , (High Level) : 3.4V to 5V
(DC IN/SYNC terminal)
- Trigger pulse fetch timing : Rising edge / Falling edge selectable
- Trigger pulse width : More than 2 μ s
- Trigger pulse interval : More than 33.5 ms

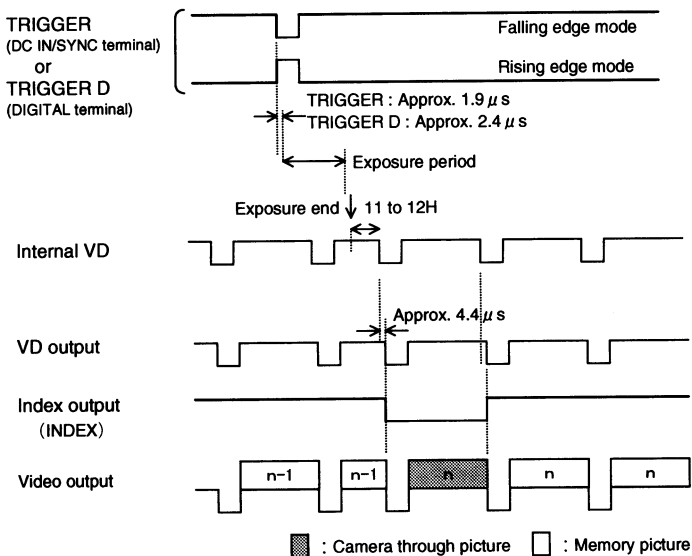

(3) 2PULSE

Accumulation of charges is started and ended through the trigger pulse input to the DC IN/SYNC terminal or trigger signal input (LVDS) to the DIGITAL terminal, the vertical sync signal is reset and field images are output.

Trigger pulse level : (Low Level): Less than 0.5V , (High Level): 3.4V to 5V
(DC IN/SYNC terminal)

Trigger pulse fetch timing : Rising edge / Falling edge / Pulse width selectable

•When the trigger pulse fetch timing is set to pulse width

Trigger pulse width : More than 16.7ms(FLD/FRM setting: FLD)
More than 33.4ms(FLD/FRM setting: FRM)

Trigger pulse interval : More than 16.7ms(FLD/FRM setting: FLD)
More than 33.4ms(FLD/FRM setting: FRM)

•When the trigger pulse fetch timing is set to rising edge or falling edge

Trigger pulse width : More than 2 μ s

Trigger pulse interval : More than 16.7ms(FLD/FRM setting: FLD)
More than 33.4ms(FLD/FRM setting: FRM)

(Frame storage period)

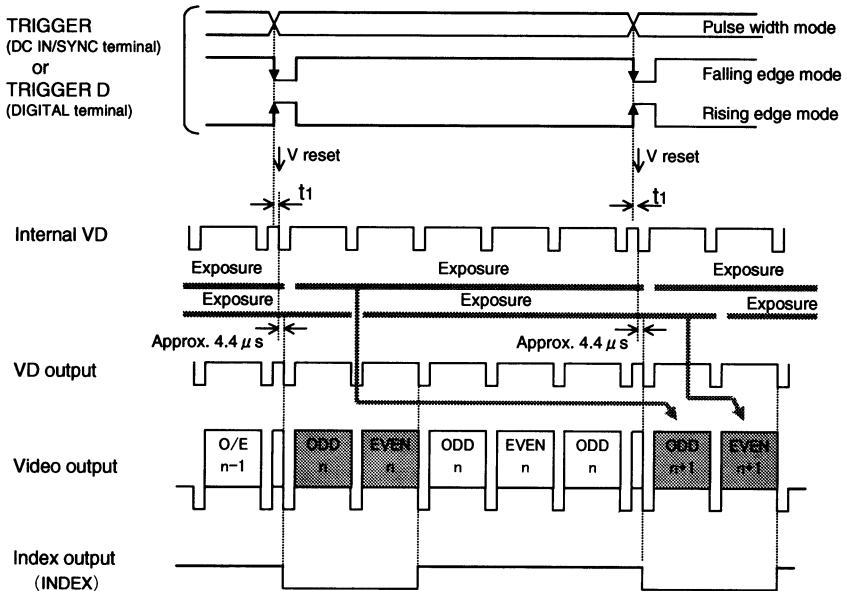

(Field storage period)

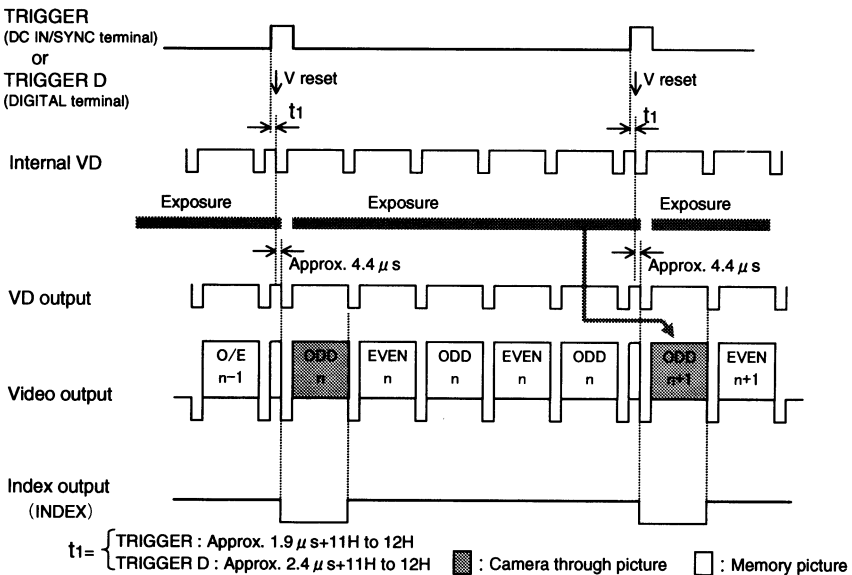

(4) RS232C

Accumulation of charges is started and ended through RS232C commands to the DIGITAL terminal, the vertical sync signal is reset and field images are output.

* RS232C control is required for this mode. To use it, consult with your dealer.

START-STOP command interval : More than 33.4ms

STOP-START command interval : More than 33.4ms

(Frame storage period)

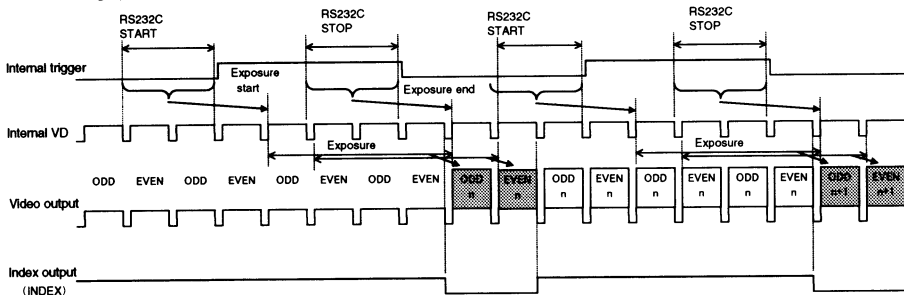

■ : Camera through picture □ : Memory picture

(Field storage period)

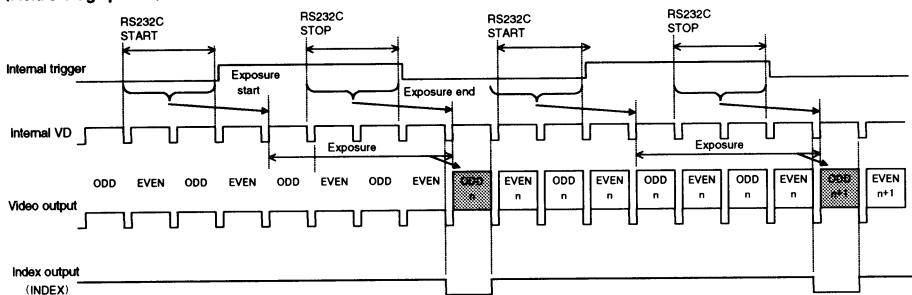

■ : Camera through picture □ : Memory picture

7. 6 Freeze Operation by Trigger Input

When the shutter mode is set to AUTO, MANUAL or SS and the shutter menu's FREEZE INPUT setting is set to TRIG \uparrow or TRIG \downarrow , toggling between the Live and the Frozen Image is performed by the trigger pulse input to the DC IN/SYNC terminal or trigger signal input (LVDS) to the DIGITAL terminal.

Trigger pulse level : (Low Level): Less than 0.5V , (High Level): 3.4V to 5V

(DC IN/SYNC terminal)

Trigger pulse fetch timing : Rising edge / Falling edge selectable

Trigger pulse width : More than $2\mu\text{s}$

Trigger pulse interval : More than 33.4ms

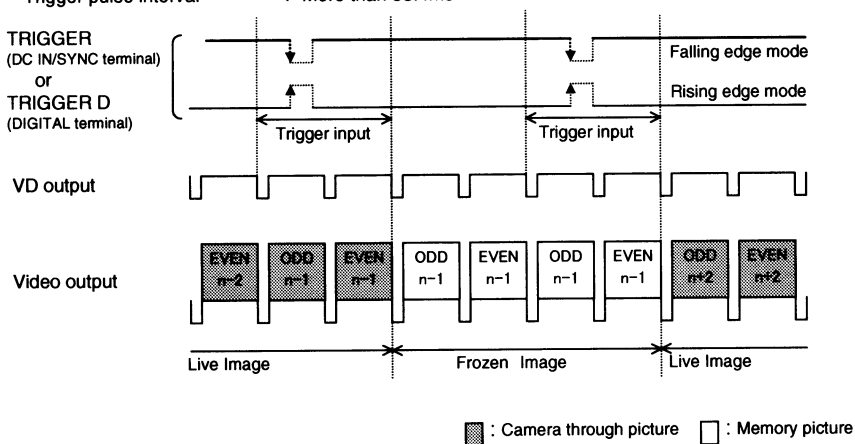

7. 7 Digital output

This unit outputs 10 bit digital video signals each for R, G and B from the DIGITAL terminal using the LVDS (Low Voltage Differential Signaling) method.

(1) Sync pulse timing

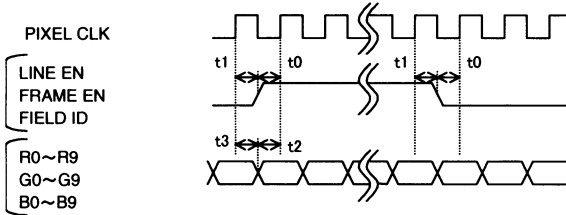
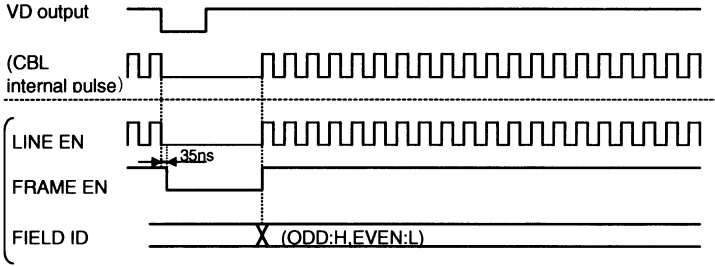

Item	Symbol	Value	unit
clock frequency		28.63636 (typical)	MHz
enable setup time	t_0	10 (minimam)	ns
enable hold time	t_1	5 (minimam)	ns
data setup time	t_2	10 (minimam)	ns
data hold time	t_3	5 (minimam)	ns

The sync pulse is output according to the camera through picture output.

Example : For SS long period exposure, field storage, 2FRM setting

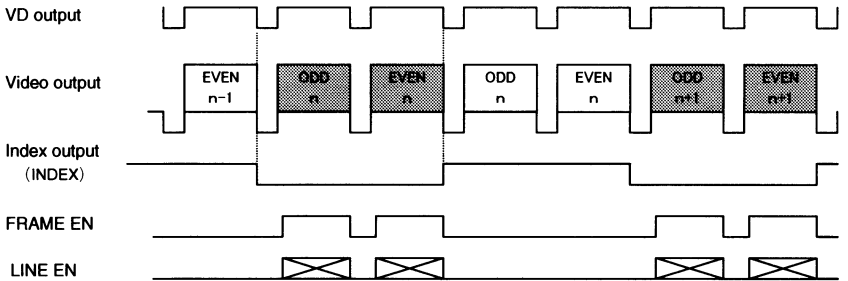

■ : Camera through picture □ : Memory picture

8. BEFORE MAKING SERVICE CALL

Symptom	Items to be checked
No picture	<ul style="list-style-type: none">· Is the power supplied correctly?· Is the lens iris adjusted correctly?· Are the cables connected correctly?· Is the shutter mode set correctly?
Poor color	<ul style="list-style-type: none">· Is the monitor (TV) adjusted correctly?· Is the white balance of the camera adjusted correctly? (in modes other than automatic trace)· Is the matrix color correction set correctly?· Is the illumination dark?· Is the SC phase adjusted correctly? (External sync)
Noise appears	<ul style="list-style-type: none">· Is the camera connector of the camera cable loosened?

9. SPECIFICATIONS

Power supply	DC12V±10%
Power consumption	Approx. 7.8W (including a camera head)
Pick-up system	RGB, 3CCD, Micro prism system
Available image sensor (Effective pixels)	1/2 inch, 1/3inch IT—CCD (Horizontal: 768pixels, Vertical: 494pixels)
Scanning system	2: 1 interlace
Scan frequency	Horizontal: 15.734kHz, Vertical: 59.94Hz
Sync system	Internal/External(Automatic switching)
Horizontal resolution	JK-TU52H connection: 800TV lines JK-TU53H connection: 750TV lines
Sensitivity	F11 standard (2000 lx, 3000K)
Minimum illumination	4 lx (F2.2, Sensitivity+20dB, 3000K)
SN ratio	64dB standard
Lens mount	C mount(flange back: 17.526mm in-air)
Ambient temperature	32 to 104° F (0 to 40°C)
Ambient humidity	Less than 90%
Weight	Approx. 1.57 lbs(710g)
External dimension	4.33"(W) × 1.57"(H) × 6.14(D) (110(W) × 40(H) × 156(D)mm) (except for protruded portion)
Scene file(user memories)	A, B, C
White balance	ATW (Automatic tracing balance), AWB (Automatic white balance), MANUAL (Manual)
Gain	AUTO (Automatic gain control), MANUAL (Manual), OFF (0dB)
Output signal	VBS: 75 Ω unbalanced, BNC connector, NTSC standard Y/C: 75 Ω unbalanced, S terminal RGB or Y/P _r /P _b : 75 Ω unbalanced, D sub 9 pin connector VBS or Y/C: 75 Ω unbalanced, D sub 9 pin connector
External sync input	VBS/BS: 75 Ω unbalanced, Sync negative, BNC connector SYNC 0.286V±0.1V, Burst 0.286V±0.1V HD or VD: 2—5V(p-p) Negative
Sync signal output	SYNC: 2.5V±1V(p-p) 75 Ω unbalanced HD, VD, INDEX: 5V _{1.0} ^{0.5} V(p-p), Negative, Load impedance: More than 10k Ω
External trigger input	TRIGGER: Low level: Less than 0.4V, High level: 3.4—5V 1 Pulse: Positive/Negative selectable 2 Pulse: Positive/Negative/Width selectable
Interface	Serial data interface (RS-232C)
	Digital signal interface (LVDS)
Optional parts	JK-TU52H (1/2 inch 3CCD camera head) JK-TU53H (1/3 inch 3CCD camera head) EXC—T503(Camera cable (3m)), EXC—T506(Camera cable (6.5m)) EXC—T510(Camera cable (10m)), EXC—T530(Camera cable (30m)) EXC—T505RGB(USB cable), JK—KTU5(Camera head tripod base)

●Design and specifications are subject to change without notice.

10. EXTERNAL APPEARANCE DIAGRAM

Unit : mm [inch]

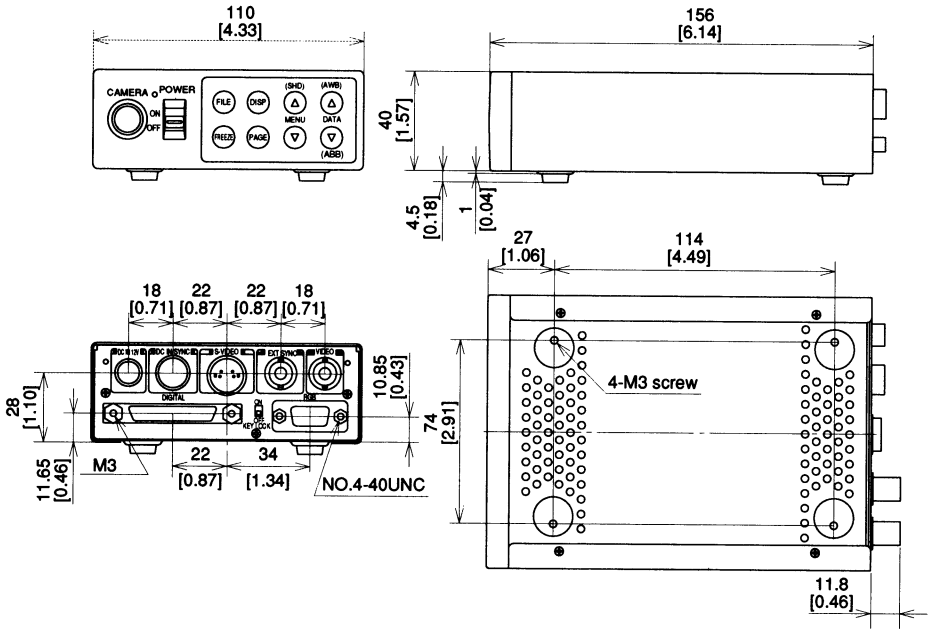

LIMITED WARRANTY CCD CAMERA

The Imaging Systems Division of Toshiba America Information Systems, Inc. ("ISD") makes the following limited warranties with regard to this CCD Camera ("Product"). These limited warranties extend to the Original End-User ("You[r]").

One (1) Year Limited Warranty of Labor and Parts: ISD warrants that this Product will perform in accordance with specifications for a period of one (1) year from the date of purchase by the Original End-User. During this one (1) year period, ISD will repair or replace the Product, if it does not perform as warranted. In order to take advantage of this Limited Warranty, You must: (a) deliver the Product to an ISD Authorized Service Provider ("ASP"); and (b) pay all transportation and insurance charges for shipment of the Product to the ASP. ISD reserves the right to substitute factory refurbished parts in place of those in need of repair.

Instruction Manual (Owner's Manual): You should read the Instruction Manual (Owners Manual) thoroughly before operating this Product. Before seeking warranty service, you should check the troubleshooting guide in the Instruction Manual (Owner's Manual) and follow the instructions to correct the problem.

Your Responsibilities: This Limited Warranty is subject to the following conditions:

1. You must provide the bill of sale or proof of purchase at the time that warranty service is required.
2. You must notify an ASP within thirty (30) days after You discover that the Product does not perform in accordance with specifications during the Limited Warranty period.
3. All warranty servicing of this product must be made by an ISD Authorized Service Provider.
4. You must pack the Product in its original carton using the original packing material, then insert the original carton containing the Product into another carton with additional packing material before shipping the Product to an ASP.

DISCLAIMERS:

ALL OTHER EXPRESS OR IMPLIED WARRANTIES ON THIS PRODUCT, INCLUDING THE IMPLIED WARRANTIES OF MERCHANTABILITY AND FITNESS FOR A PARTICULAR PURPOSE, ARE HEREBY DISCLAIMED. SOME STATES DO NOT ALLOW THE EXCLUSION OF IMPLIED WARRANTIES OR LIMITATIONS ON HOW LONG AN IMPLIED WARRANTY LASTS, SO THE ABOVE LIMITATIONS MAY NOT APPLY TO YOU.

IF THIS PRODUCT IS NOT IN GOOD WORKING ORDER AS WARRANTED ABOVE, YOUR SOLE AND EXCLUSIVE REMEDY SHALL BE THE REPAIR OR REPLACEMENT OF THE PRODUCT. IN NO EVENT WILL ISD OR ITS PARENT COMPANY OR ANY ASP BE LIABLE TO YOU OR ANY THIRD PARTY FOR ANY DAMAGES IN EXCESS OF THE PURCHASE PRICE OF THE PRODUCT. THIS LIMITATION APPLIES TO DAMAGES OF ANY KIND, INCLUDING ANY DIRECT OR INDIRECT DAMAGES, LOST PROFITS, LOST SAVINGS OR OTHER SPECIAL, INCIDENTAL, EXEMPLARY OR CONSEQUENTIAL DAMAGES, WHETHER FOR BREACH OF CONTRACT, TORT OR OTHERWISE, OR WHETHER ARISING OUT OF THE USE OF OR INABILITY TO USE SUCH PRODUCT, EVEN IF TAIS, ITS PARENT COMPANY, OR AN ASP HAS BEEN ADVISED OF THE POSSIBILITY OF SUCH DAMAGES OR OF ANY CLAIM BY ANY OTHER PARTY. SOME STATES DO NOT ALLOW THE EXCLUSION OR LIMITATION OF INCIDENTAL OR CONSEQUENTIAL DAMAGES FOR SOME PRODUCTS, SO THE ABOVE LIMITATIONS OR EXCLUSIONS MAY NOT APPLY TO YOU.

THIS WARRANTY GIVES YOU SPECIFIC LEGAL RIGHTS, AND YOU MAY ALSO HAVE OTHER RIGHTS WHICH MAY VARY FROM STATE TO STATE.

THIS LIMITED WARRANTY SHALL BE VOID IF THE PRODUCT OR PARTS HAVE BEEN SUBJECTED TO MISUSE, ABUSE, ACCIDENT, IMPROPER INSTALLATION, IMPROPER MAINTENANCE, OR USE IN VIOLATION OF ISD'S WRITTEN INSTRUCTIONS, OR WHERE THE PRODUCT HAS BEEN ALTERED OR MODIFIED WITHOUT ISD'S PRIOR AUTHORIZATION, OR UPON THE REMOVAL OR ALTERATION OF ISD'S FACTORY SERIAL NUMBER. LABOR SERVICE CHARGES FOR PRODUCT INSTALLATION, SET UP AND ADJUSTMENT OF CONTROLS ARE NOT COVERED BY THIS LIMITED WARRANTY.

How to Obtain Warranty Service — Step-By-Step Procedures: To obtain warranty service, You should:

1. Contact an ASP for warranty service within thirty (30) days after the Product fails to comply with specifications.
2. Arrange for shipment of the Product to an ASP
3. Securely pack the Product as described above, insure the carton, and include a letter explaining the problem and a copy of the bill of sale or proof of purchase.
4. Prepay all transportation and insurance costs.

Questions? If you have any questions, please check ISD's website or send an e-mail as follows:

Website: <http://www.toshiba.com/taisid/indmed>

E-mail: CCTVtech.support@tais.toshiba.com

No person, agent, distributor, dealer, authorized service provider, or company is authorized to change, modify, or extend the terms of this Limited Warranty in any manner whatsoever. The time within which an action must be commenced to enforce any obligation of ISD arising under this Limited Warranty or under any statute, or law of the United States or any state thereof, is hereby limited to one (1) year from the date You discover or should have discovered the problem. This limitation does not apply to implied warranties arising under state law. Some states do not permit limitation of the time within which You may bring an action beyond the limits provided by state law, so the above provision may not apply to You. This Limited Warranty gives You specific legal rights and You may also have other rights which vary from state to state.

TOSHIBA AMERICA INFORMATION SYSTEMS, INC.
Imaging Systems Division
9740 Irvine Boulevard, Irvine, CA 92618-1697
Service Department: (949) 461-4989 & 4992

Free Manuals Download Website

<http://myh66.com>

<http://usermanuals.us>

<http://www.somanuals.com>

<http://www.4manuals.cc>

<http://www.manual-lib.com>

<http://www.404manual.com>

<http://www.luxmanual.com>

<http://aubethermostatmanual.com>

Golf course search by state

<http://golfingnear.com>

Email search by domain

<http://emailbydomain.com>

Auto manuals search

<http://auto.somanuals.com>

TV manuals search

<http://tv.somanuals.com>