

CCD CAMERA

IK-M41F2/IK-M41R2/ IK-C41F2

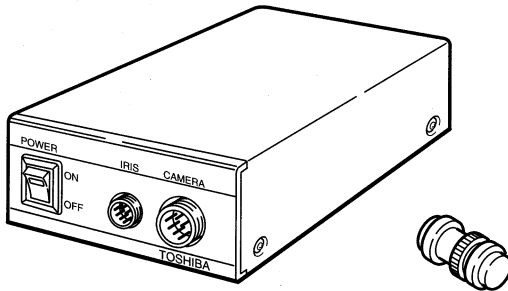

For Customer Use

Enter below the Serial No. which is located on the bottom of the cabinet. Retain this information for future reference.

Model No.: IK-M41F2/

IK-M41R2/

IK-C41F2

Serial No.: _____

WARNING

This is a Class A of EN55022 product. In a domestic environment this product may cause radio interference in which case the user may be required to take adequate measures.

INFORMATION

This equipment has been tested and found to comply with the limits for a Class A digital device, pursuant to Part 15 of the FCC Rules. These limits are designed to provide reasonable protection against harmful interference when the equipment is operated in a commercial environment. This equipment generates, uses, and can radiate radio frequency energy and, if not installed and used in accordance with the instruction manual, may cause harmful interference to radio communications. Operation of this equipment in a residential area is likely to cause harmful interference in which case the user will be required to correct the interference at his own expense.

USER-INSTALLER CAUTION: Your authority to operate this FCC verified equipment could be voided if you make changes or modifications not expressly approved by the party responsible for compliance to Part 15 of the FCC rules.



This Class A digital apparatus complies with Canadian ICES-003.

Cet appareil numérique de la classe A est conforme à la norme NMB-003 du Canada.

Safety precautions

Read the following safety precautions carefully before using the product. These instructions contain valuable information on safe and proper use that will prevent harm and damage to the operator and other persons. Make sure that you fully understand the following details (indications, graphic symbols) before proceeding to the main descriptions in this manual.



Indication definitions

Indication	Meaning
 Warning	This indicates that ignoring this label and/or misoperation of the product may cause serious personal injury or even death.
 Caution	This indicates that ignoring this label and/or misoperation of the product may cause personal injury* ¹ and/or material damage* ² .

*1: Bodily injury means injuries, burns and electric shock which does not require hospitalization or prolonged treatment.

*2: Physical damage means extended harm to home, household effects.

Graphic symbol definitions

Symbol	Meaning
	Indicates a prohibited action that must not be carried out. The actual prohibited action is indicated in the symbol or nearby graphically or described in text.
	Indicates a mandatory action that must be carried out surely. The actual mandatory action is indicated in the symbol or nearby graphically or described in text.
	Indicates an action required caution. The actual action required caution is indicated in the symbol or nearby graphically or described in text.

Warning

- **Do not use the product when abnormality occurs.**

 The use in the abnormality status such as emitting smoke from the product, smelling burning, being damaged by drop, invasion of foreign objects inside the product, etc., may cause fire and/or electric shock. Be always sure to disconnect the power plug from the electrical outlet (socket) at once and contact your dealer.

- **Do not install the product where splashing of water may occur, such as outdoor, a bathroom, etc.**

 This may cause fire and/or electric shock.

- **Do not repair, disassemble and/or modify by yourself.**

 This may cause fire and/or electric shock. Be always sure to contact your dealer for internal repair, check and cleaning of the product.

- **Keep the rated voltage for the product.**

 The use of power supply voltage except for its rated voltage may cause fire and/or electrical shock. Please refer to "2"Connections".

- **Do not put a vessel(s) filled with a liquid (flower vase, etc.).**

 If a liquid enters the product, a fire and/or electric shock may occur.

- **Do not put the product in an unstable, slanting and/or vibrated place.**

 Drop and/or fall of the product may cause injury.

Caution



- **Keep the followings when installing.**
 - Do not put the product on a flammable material such as carpet or blanket.
 - Do not put the product in a narrow space, since the heat generated from the product may be difficult to emanate.
 - Do not put a flammable material on the product.
If you do not keep above, the heat generated by the product may cause fire.



- **Do not put the product in direct sunshine and/or high temperature.**
The temperature rise inside the product may cause fire.



- **Do not put the product in a moist or dusty place such as a bathroom, a place close to a humidifier, etc.**
This may cause fire and/or electric shock.



- **Do not put the product in a moist, soot and/or dusty place such as a kitchen, etc.**
Do not put the product where a soot and steam may occur, such as a kitchen, etc. , or in a dusty place. This may cause fire and/or electric shock.



- **Do not shoot the sun with the lens and do not put the lens in the place exposed to an intensive light, such as the sunshine, etc.**
Focusing of the light may cause injury of eye and/or fire.



- **Do not put the product in your mouse and do not swallow it.**
This may cause suffocation and/or injury.



- **Ask your dealer to perform a periodical check and internal cleaning.**
Dust inside the product may cause fire and/or trouble. For check and cleaning cost, please consult your dealer.



- **Maintenance**
Do not use benzine, alcohol and/or thinner, etc. for cleaning. If you use it, painting or indication on the product may be worn off or deteriorated.

1. Cautions on use

- **Handle the unit carefully.** — Do not drop or give a strong shock or vibration. This may cause trouble. Handling a camera cable roughly may cause the break of cable.
- **Do not shoot intense light.** — If there is an intense light at a location on the screen such as a spot light, blooming and smearing may occur. Do not aim the camera at the sun. If an intense light enters, vertical strips may appear on the screen. However, this is not trouble.
- **Install the camera in a location free from noise.** — If the camera or the cables are located near power utility lines or a TV, undesirable noise may appear on the screen. In such a case, try to change the location of the camera or the cable wiring.
- **Handling of the camera head and protection cap.** — Keep the camera head and the protection cover away from children. Children may put them into mouth or swallow them accidentally. The protection cover protects the image sensing plane when the lens is removed from the camera head, do not throw away.
- **When not using the camera for a long time.** — Stop the power supply for safety.
- **When cleaning the camera** — Be sure to turn off the power and wipe with a dry cloth. If necessary, gently wipe with a cloth impregnated with thinned detergent. Do not use benzine, alcohol, thinner, etc. If used, coating and printed letters may be discolored and deteriorated. When cleaning the lens, use a lens cleaning paper, etc.

TABLE OF CONTENTS

1. CAMERA PARTS AND FUNCTIONS	5
2. CONNECTIONS	8
3. SIGNAL INPUT/OUTPUT	10
4. MODE SETTING AND AUXILIARY FUNCTION	12
5. INTERNAL SYNC	16
6. EXTERNAL SYNC. BY C-SYNC / VS / VBS	16
7. EXTERNAL SYNC. BY HD, VD	17
8. RESET/RESTART MODE	19
9. ONE-PULSE TRIGGER MODE	20
10. SHUTTER SPEED SETTING AT INTERVALS OF 1H	22
11. LIST OF VIDEO OUT MODE SETTING	24
12. DC POWER SUPPLY AND POWER CONNECTION	26
13. TROUBLESHOOTING CHART	27
14. CONFIGURATION	27
15. OPTIONS	28
16. SPECIFICATIONS	29
17. EXTERIOR VIEW	31

1. CAMERA PARTS AND FUNCTIONS

Camera head and camera cable IK-M41F2, IK-M41R2

CAUTION

- Do not use any power supply other than specified.

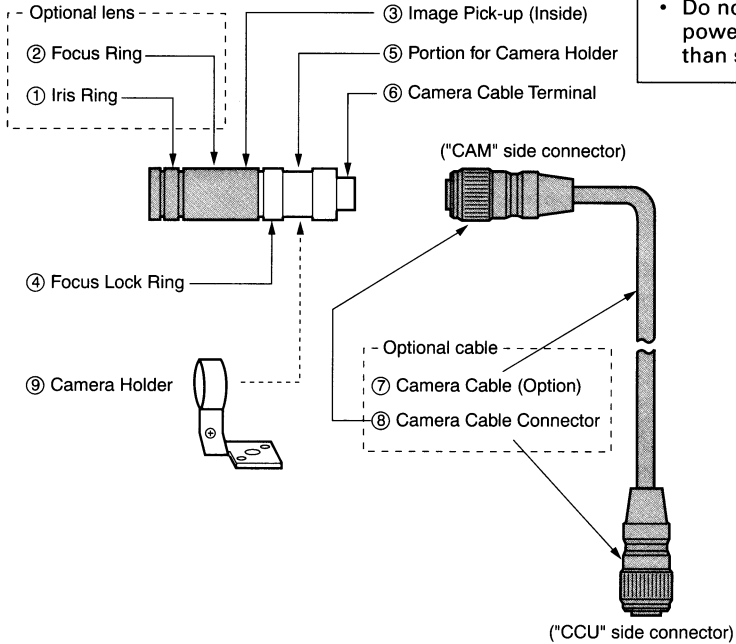

IK-C41F2

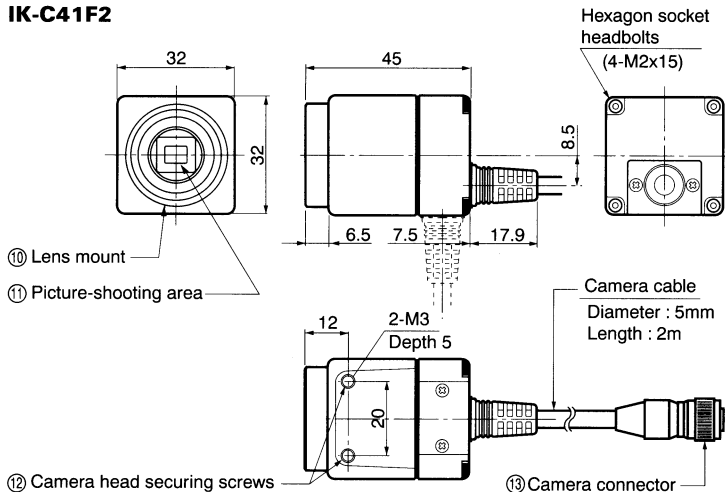

Camera control unit (CCU)

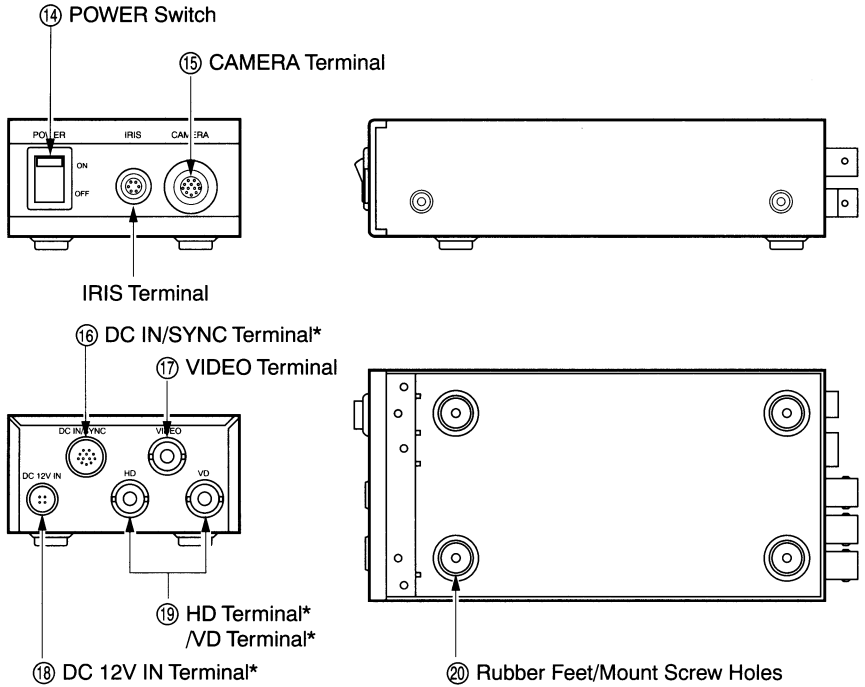

- ① **Iris Ring (The lens is option.)** To get appropriate iris, the aperture size is adjusted by turning this ring.
- ② **Focus Ring** The focus is adjusted by turning this ring.
- ③ **Image Pick-up (CCD)** Should be kept from dirt, dust, finger-print, etc.
- ④ **Focus Lock Ring** When the focus lock ring is set, movement of the focusing ring becomes heavy.
- ⑤ **Portion for Camera Holder** This portion is held by the camera holder.
- ⑥ **Camera Cable Terminal** The 'CAM' side of the camera cable is connected to this terminal.
- ⑦ **Camera Cable (Option)** To connect the camera head and the camera control unit (CCU). Refer to 'OPTIONAL CAMERA CABLES/LENSES'.
- ⑧ **Camera Cable Connector** To be connected to 6 Camera Cable Terminal on the rear of the camera head and to 15 CAMERA Terminal of the CCU. Before connection, confirm the side ('CAM' or 'CCU') of the cable.
- ⑨ **Camera Holder** When installing the camera head to a tripod or the like, use the camera holder.
- ⑩ **Lens Mount** Used to mount the C mount lens.
- ⑪ **Picture shooting area** Be always sure to keep off dust, finger prints, etc.
- ⑫ **Camera Head Securing Screw** Used to mount the camera head
- ⑬ **Camera connector** Connector to CAMERA terminal of camera control unit
- ⑭ **POWER Switch** To turn on/off the power.
- ⑮ **CAMERA Terminal** The 'CCU' side of the camera cable is connected.
- ⑯ **DC IN/SYNC Terminal*** This terminal is to be used for VIDEO output, External Sync. input.
Note: When the signal is input/output through this DC IN/SYNC terminal, 'DC 12V IN'/'HD, VD' terminals (* marked) are not connected.
- ⑰ **VIDEO Terminal** This output terminal is to be connected to Monitor or VCR video-in terminal. (BNC pin)
- ⑱ **DC 12V IN Terminal*** The DC power (12V) is connected to this terminal.
- ⑲ **HD Terminal*/VD Terminal*** These terminals are used for sync. with external control unit.
- ⑳ **Rubber Feet/Mount Screw Holes** Remove four rubber feet, and fix the CCU with screws (M3type). The screw must not protrude more than 5mm beyond the inside surfaces of the CCU.

2. CONNECTIONS

IK-M41F2, IK-M41R2

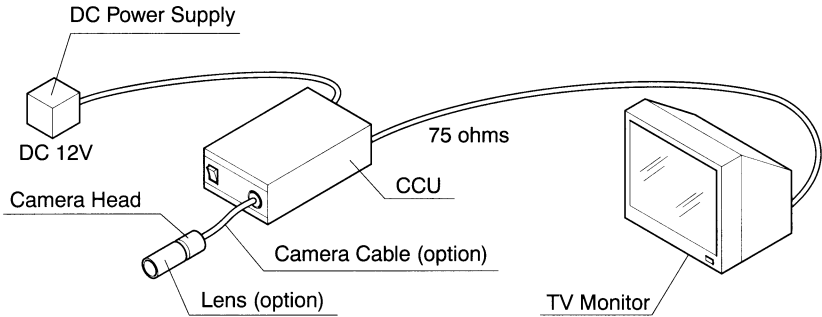

IMPORTANT

Before connecting or disconnecting camera cable, be sure to turn the power OFF. Otherwise, the camera head may be damaged, which will void warranty.

1. Detach the cap from the camera head, and attach an optional lens.
2. Connect the camera cable terminal of the camera head and the CAMERA terminal of the CCU with the camera cable (option). (Refer to NOTE 1.)
3. Connect the VIDEO terminal of the CCU and VIDEO IN terminal of the TV monitor with a video cable. (Refer to NOTE 2.)
4. Connect the cord from the DC power supply to the DC 12V IN terminal of the CCU. (Refer to NOTE 3.)
5. Adjust the Iris/Focus rings of the lens (option) to get appropriate image.

IK-C41F2

1. Mount the lens on the camera and make the wiring between devices.

Available lens

Use a C-mount lens with its protruded dimensions (L) from the mounting surface less than 7.0 mm.

NOTE:

- When the lens quantity exceeds 500g, do not fix the lens by using its camera head securing screw holes but keep the lens on its lens side.
- The camera is not equipped with the back focus adjustment mechanism.

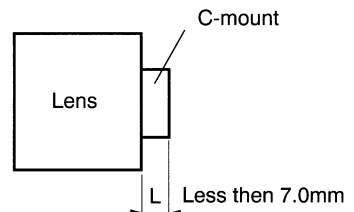

When using an automatic iris lens

When using a EE lens of video feed back type, since the EE video signal develops at the 6P terminal "IRIS" located on the front side of the camera, the signal is sent to the EE lens. When using an iris extension cable (EXC-C2E, etc.), use HR10A-7P-4P (Hirose Electronics Co. Ltd.) for the connector on the lens side.

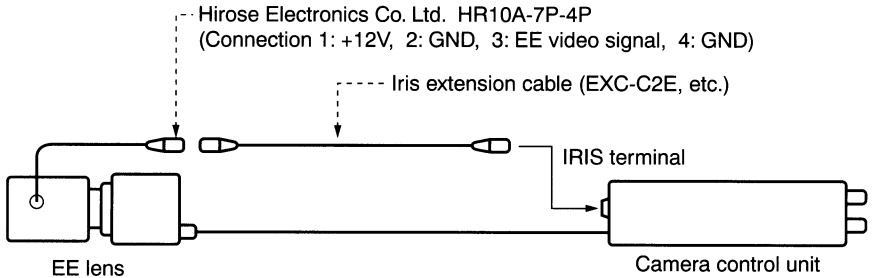
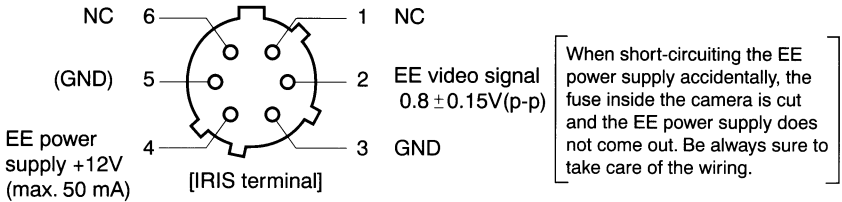

- NOTE:**
1. Make sure power switches of the CCU and TV monitor are at OFF position. Securely tighten the connectors of camera cable.
 2. When using VCR, connect the video cable from the CCU to the VIDEO IN terminal of VCR. Read the operation manual before making connections.
 3. Precautions for connections (HR10A-7P-4S).

Plugging

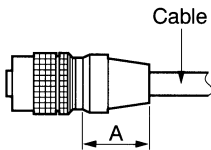

To connect the cable of the DC power supply, hold A position of the plug, and match the plug guide to the receptacle guide so that connection can be done smoothly.

Unplugging

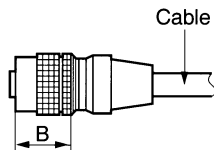

To detach the plug, hold B portion of the plug and pull it straightforward so that the plug can be detached easily.

3. SIGNAL INPUT/OUTPUT

(1) Condition of External Sync. Input

1. HD	3.0±1.5Vp-p • Negative polarity • 75Ω unbalanced 5.0±0.5Vp-p • Negative polarity • TTL level	6.0μs - 10.0μs
2. VD	3.0±1.5Vp-p • Negative polarity • 75Ω unbalanced 5.0±0.5Vp-p • Negative polarity • TTL level	3H to 9H
3. C-SYNC	3.0±1.5Vp-p • Negative polarity • 75Ω unbalanced 5.0±0.5Vp-p • Negative polarity • TTL level	EIA-170A standards
4. VS/VBS	0.3±0.1Vp-p • 75Ω unbalanced	EIA-170A standards
5. RR. VD	3.0±1.5Vp-p • Negative polarity • 75Ω unbalanced 5.0±0.5Vp-p • Negative polarity • TTL level	3H to 9H
6. TRIGGER	3.0±1.5Vp-p • Negative polarity • 75Ω unbalanced 5.0±0.5Vp-p • Negative polarity • TTL level	3H to 9H

NOTE: In case of VD, C-SYNC, VS/VBS and RR. VD, use the connector for DC IN/SYNC terminal or VD terminal and input a signal selected dependent on the mode in use.

External sync, frequency range: Within ±1.0% against NTSC standards

(2) Specifications of External Output Signal

1. VIDEO	1.0Vp-p • 75Ω unbalanced
2. VIDEO INDEX	5.0±0.5Vp-p • Positive polarity • Load impedance more than 10KΩ
3. HD	5.0±0.5Vp-p • Negative polarity • Load impedance more than 10KΩ
4. VD	5.0±0.5Vp-p • Negative polarity • Load impedance more than 10KΩ
5. CLOCK	4.0±1.5Vp-p • 14.31813 MHz • Load impedance more than 1KΩ

When HD and VD, common with HD IN and VD IN, are used for inputting, they cannot be used for outputting. (Input/output can be selected by changing the internal connector. Input: P304, Output: P305) CLOCK can be output by shorting the inner land.

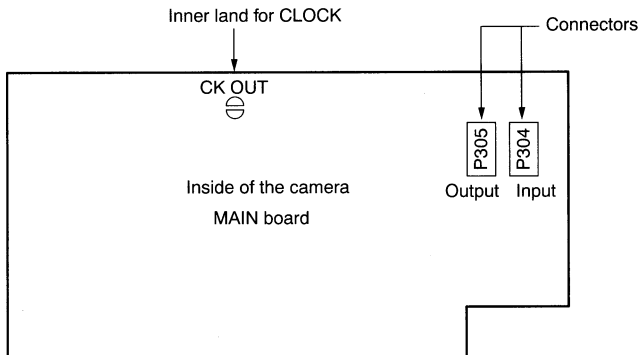

(3) 12 Pin Connector (DC IN/SYNC terminal)

In case the signal is input/output directly from DC IN/SYNC terminal, connect as follows.

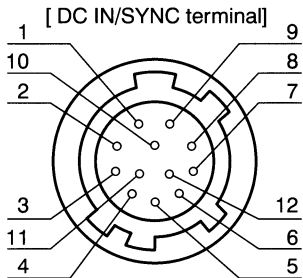

Type of connector to be used with DC IN/SYNC terminal: HIROSE HR10A-10P-12S

Pin No.	External Sync. Mode		
	VS/VBS/C-SYNC	HD, VD	RESET RESTART/ One-pulse Trigger
1	Power GND	Power GND	Power GND
2*	Power +12V	Power +12V	Power +12V
3	VIDEO (GND)	VIDEO (GND)	VIDEO (GND)
4	VIDEO (Signal)	VIDEO (Signal)	VIDEO (Signal)
5	_____	HD input (GND)	HD input (GND)
6*	_____	HD input (Signal)	HD input (Signal)
7*	VS/VBS/C-SYNC input (Signal)	VD input (Signal)	VD input (Signal)
8	CLK output (GND)	CLK output (GND)	CLK output (GND)
9	CLK output (Signal)	CLK output (Signal)	CLK output (Signal)
10	_____	_____	VIDEO INDEX (output)
11	_____	_____	TRIGGER (input)
12	VS/VBS/C-SYNC input (GND)	VD input (GND)	VD input (GND)

CLOCK OUT requires to short the inner land.

IMPORTANT

The one marked with * is parallely connected to HD, VD, and DC 12V IN terminals. Input/output of the signal should be carried out from either one terminal only. (Do not make connection simultaneously.)

4. MODE SETTING AND AUXILIARY FUNCTION

The auxiliary function is set with the built-in switch of the unit. In order to change the setting, remove the cover by detaching 4 screws on the side of the CCU.

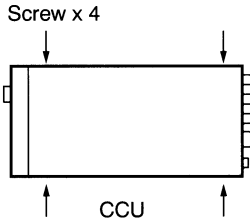

Switch layout (cover removed)

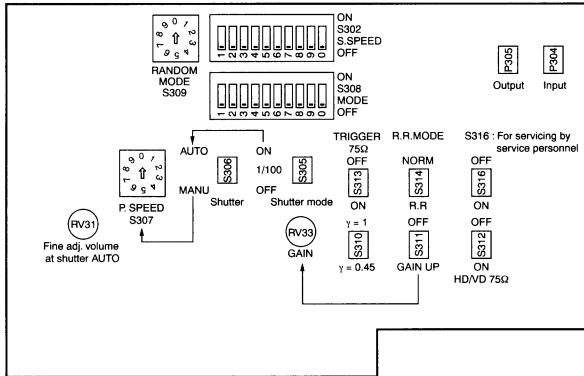

IMPORTANT

When operating the internal switch or using the soldering iron, the built-in circuit of the unit is exposed, which may hazardous condition of breaking static electricity.

In order to prevent the static electricity breaking, make sure to duly observe the following items upon the operation.

- ① Do not touch any parts and boards other than the switch required to be operated.
- ② Do not wear the cloth which is likely to cause static electricity, such as nylon, rubber or the like. Make sure to put on cotton gloves when carrying out the operation.
- ③ Put on the earth band with the arm for earthing. If the earth band is not available, touch GND of BNC connector pin before starting the operation.
- ④ Cover the working table with the conductive sheet for earthing.
- ⑤ Earth GND of the BNC connector pin of the set.

Gamma correction change-over:

Set S311 to select gamma correction amount to 0.45 or 1.

Gain-up mode:

Set S311 at OFF for normal mode (0dB), and ON for gain-up mode. The gain up amount is adjustable maximum to +12dB by setting RV33.

Reset/Restart mode external sync. switch:

In case of RR VD external sync. mode, set S314 at R. RVD. If not, set S314 at NORM.

Input impedance selector switch:

In case the input impedance of external sync. input signal (VS/VBS/C-SYNC/VD, HD/RR.VD) is set to 75Ω, set S312 at ON (75Ω terminated). In case it set to 1KΩ, set S312 at OFF (TTL input).

In case the trigger input impedance is set to 75Ω, set S313 at ON (75Ω terminated).

In case it is set to 1 KΩ, set S313 at OFF (TTL input).

Flickerless:

Setting S305 to 1/100 allows to reduce the occurrence of flickering phenomenon in the region with power frequency of 50Hz (The picture flickers under the illumination produced by electric discharge lamps). Inoperative at One-pulse trigger mode and reset/restart mode.

Automatic Electronic Shutter:

Set S305 at ON, and set S306 at AUTO. RV31 is used for fine tuning of the video level.

The camera is designed to automatically control the exposure time ranging from 1/60 to 1/50000 s. in

order to change in luminous energy of the subject.

Inoperative at One-pulse trigger mode and reset/restart mode.

Electronic shutter:

The shutter speed may be set by using either direct setting with a rotary switch, or binary setting with dip switch. The direct setting with the rotary switch is used for setting at any mode. The binary setting with the dip switch is used for setting the shutter speed at every 1H (1H=63.5μs) at One-pulse trigger mode.

① Direct setting with rotary switch (any mode)

Set S305 at ON, and set S306 at MANU. Set the rotary switch S307 at the position corresponded to the desired shutter speed as shown in the table below.

S307 Position	Shutter speed
0, 8, 9	1/60s
1	1/125s
2	1/250s
3	1/500s
4	1/1000s
5	1/2000s
6	1/4000s
7	1/10000s

② Binary setting with dip switch (One-pulse trigger mode) Refer to 'SHUTTER SPEED SETTING AT INTERVALS OF 1H'.

One-pulse trigger mode setting, Reset/Restart mode setting for trigger input:

The rotary switch S309 is used for the mode setting. Before setting the mode, make sure to turn the power of the camera off.

S309 Position	Mode
0, 1, 2, 3, 8, 9	Normal mode
4	One-pulse trigger, SYNC-RESET
5	Trigger input, RR. SYNC-RESET
6	One-pulse trigger, SYNC-NONRESET
7	Trigger input, RR. SYNC-NONRESET

Set internal sync., external sync. (VS/C-SYNC, HD/VD) and reset/restart (HD, RR.VD input) at NORMAL mode.

Field/Frame accumulation mode:

Set No.1 of S308 to select accumulation/read out mode of CCD output signal.

ON: Frame accumulation

OFF: Field accumulation

Set No.1 of S308 to select field accumulation interlaced mode/frame accumulation interlaced mode at trigger input mode of reset/restart.

ON: Frame accumulation interlaced mode

OFF: Field accumulation interlaced mode

Output field designation:

The video output field can be designated by selecting switches No.2 and No.3 of S308. The setting mode changes depending on the mode.

- Internal sync.

Video output field can be designated. Non-interlaced video image: 1 field (1V)=262H

- Reset/Restart trigger input mode, SYNC-RESET mode

Output the field designated by selecting the switches No.2 and No.3 of S308.

- One-pulse trigger SYNC-RESET mode

Output the field designated by selecting the switches No.2 and No.3 of S308.

- Other mode

Output field cannot be designated. Turn the switches No.2 and No.3 of S308 off.

S308		Video output field
No.2	No.3	
ON	OFF	ODD field
ON	ON	EVEN field
OFF	ON	Designation OFF
OFF	OFF	Designation OFF

CLOCK output:

Shorting the land of MAIN board will allow the clock to be output from 9 pin (signal) and 8 pin (GND) of DCIN/SYNC terminal (12 pin connector) on the rear.

The clock output is 14.31818 MHz \pm 50ppm.

VIDEO OUT C-coupling, DC direct connection output switching

The video out signal develops from both pins 4 (signal), 3 (GND) of the DC IN/SYNC terminal located on the rear side of the camera and the video terminal (BNC connector).

Setting No. 9 and No. 10 of the S308 mode switch can select either the DC direct connection output (the video blanking signal except SYNC is fixed to GND.) or the C-coupling output for the video output signal.

S308		VIDEO output	
No. 9	No. 10	VIDEO (BNC connection)	DC IN/SYNC (pin 12)
OFF	OFF	C-coupling output	C-coupling output
OFF	ON	DC direct connection output	C-coupling output
ON	OFF	C-coupling output	DC direct connection output
ON	ON	DC direct connection output	DC direct connection output

5. INTERNAL SYNC.

At internal sync. mode, the video output field can be designated as well as outputting video signals of NTSC normally interlaced at 262.5H. The video output field can be designated by selecting the switches No.2 and No.3 of S308 as shown in the table below.

Output field	S308	
	No.2	No.3
OFF	OFF	OFF
	OFF	ON
ODD	ON	OFF
EVEN	ON	ON

Upon designating the output field, the video out sends each designated field which is non-interlaced (1 field=262H).

6. EXTERNAL SYNC. BY C-SYNC/VS/VBS

C-SYNC: Composite-SYNC signal

VS: VIDEO/Composite-SYNC signal

VBS: VIDEO/BURST/Composite-SYNC signal

In order to set external sync. mode with the signal selected from C-SYNC, VS and VBS, input to VD IN terminal on the rear (BNC connector) or 7 pin (signal) and 12 pin (GND) of DC IN/SYNC terminal (12 pin connector). No signal is necessary to be input to 5 pin and 6 pin of HD IN terminal (BNC connector) and DC IN/SYNC terminal.

Set S314 to R.R when the external sync. is carried out by using BBS (BLACK/BURST/Composite-SYNC) signal.

Set the S314 (R.R MODE switch) and S312 (HD. VD 75Ω ON/OFF switch) according to the input conditions of C-SYNC, VS and VBS as shown in the table below.

Signal	Input condition	S312 75Ω terminated SW	S314 R.R. mode SW
C-SYNC/VS/VBS	0.3±0.15Vp-p, 75Ω unbalanced	ON	NORM
C-SYNC	3.0±1.5Vp-p, 75Ω unbalanced	ON	NORM
C-SYNC	5.0±0.5Vp-p, TTL	OFF	NORM

External sync. frequency range: Within ±1.0% against NTSC standards.

7. EXTERNAL SYNC. BY HD, VD

(1) Input terminals and switch setting for HD, VD

Input terminals

HD 6 pin (signal) and 5 pin (GND) of HD IN terminal (BNC connector) or DC IN/SYNC terminal (12 pin connector)

VD 7 pin (signal) and 12 pin (GND) of VD IN terminal (BNC connector) or DC IN/SYNC terminal (12 pin connector)

Switch setting

Signal	Input condition	S312 75Ω terminated On/Off SW	S314 R.R. mode SW
HD, VD	3.0±1.5Vp-p, 75Ω unbalanced	ON	NORM
	5.0±0.5Vp-p, TTL level	OFF	NORM

(2) Phase and frequency conditions of HD, VD

Phase condition

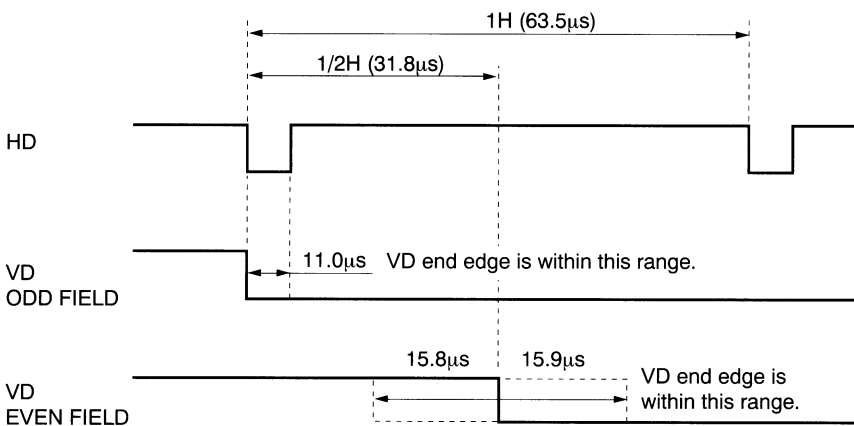

Frequency condition

HD: 15.734kHz ± 1% (63.56µs ± 1%)

VD: More than 244H (1 H=63.56µs: 1 horizontal scanning period) at intervals of 0.5H. Standard VD is 262.5H.

(3) Interlaced/Non-interlaced operation

Interlaced/non-interlaced operation may be carried out by changing the input phase conditions of HD and VD.

Interlaced operation

The input phases of VD and HD may be arranged to be ODD and EVEN alternately at every 1 field so that the video output is interlaced. (Normal HD, VD input)

Non-interlaced operation

The input phases of VD and HD may be arranged to be either ODD or EVEN only for all the fields so that the video output is not interlaced. The 'non-interlaced' operation refers to scan the same scanning line at every field. At non-interlaced operation, vertical resolutions may be decreased as shown in the table below.

Operation mode	Resolution
Frame accumulation interlaced mode	Fine
Field accumulation interlaced mode	Very Good
Frame accumulation non-interlaced mode	Good
Field accumulation non-interlaced mode	Good

8. RESET/RESTART MODE

The camera is designed to reset/restart for retrieving information on a single screen at any desired time. The reset/restart mode has two types, the mode for inputting RR VD and HD, and the mode for inputting trigger.

(1) RR VD, HD input reset/restart mode

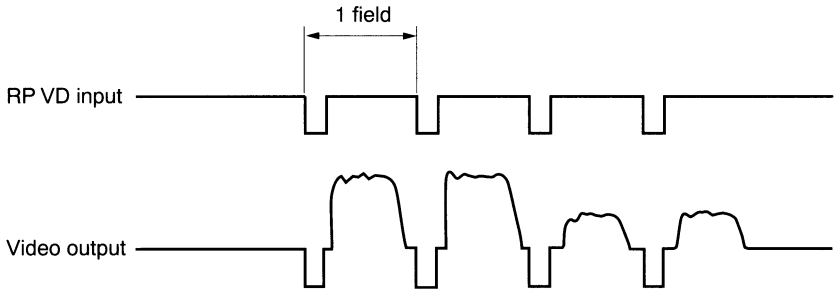

The above figure shows an example of the frame accumulation interlaced mode. The required number of RR VD for video output is to be input.

(2) Trigger input reset/restart mode

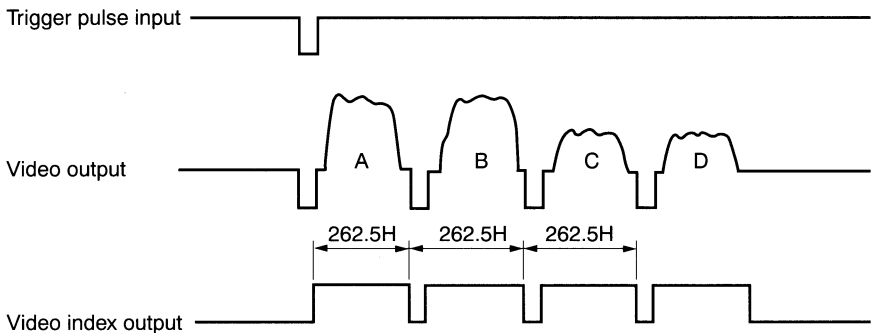

The above figure shows an example of the frame accumulation interlaced mode. Inputting only 1 trigger pulse may provide the identical image to that obtained at the RR VD, input reset/restart mode.

9. ONE-PULSE TRIGGER MODE

The camera is designed to carry out one-pulse trigger for retrieving the information on a signal screen momentarily at the desired time. The one-pulse mode has two types, SYNC reset mode and SYNC non-reset mode. At SYNC reset mode, vertical sync. is carried out by trigger inputting. At SYNC non-reset mode, vertical sync. is not carried out by trigger inputting.

(1) One-pulse trigger SYNC reset mode

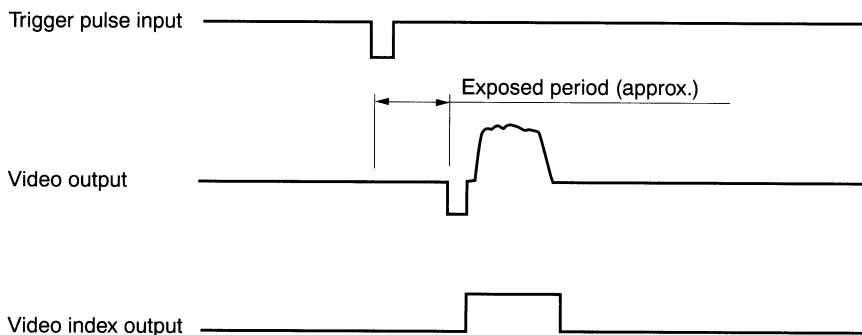

The exposure period starts from the end edge of the trigger pulse and the exposure is conducted for the period at the predetermined shutter speed. When the exposure is finished, video image by 1 field is output.

(2) One-pulse trigger SYNC non-reset mode

The exposure period not overlapped with V-SYNC

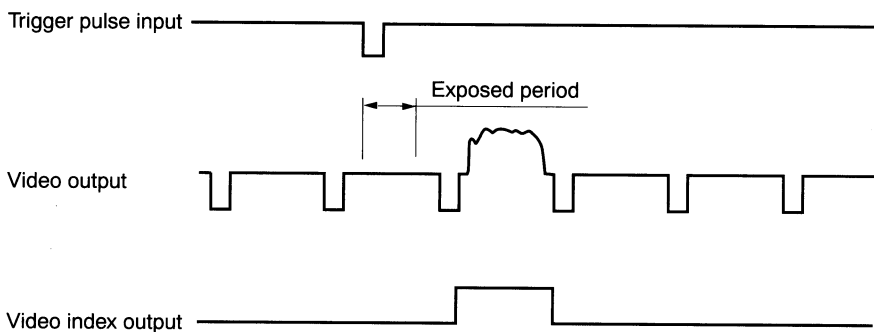

The exposure period not overlapped with V-SYNC

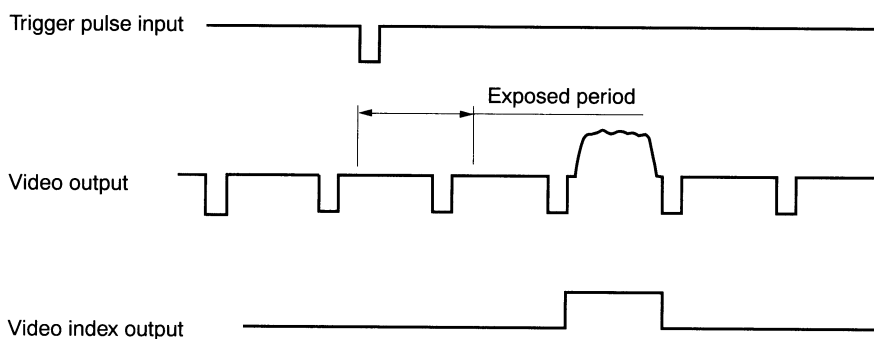

At this mode, the exposure starts after the end edge of the trigger pulse. It is finished when the period at the predetermined shutter speed elapses. The video signal is output upon vertical sync. (V-SYNC) immediately after the end of the exposure. In case the exposure period overlaps with V-SYNC, the video image will be output from the next closest V-SYNC.

10. SHUTTER SPEED SETTING AT INTERVALS OF 1H

The shutter speed can be set at intervals of 1H (1H=63.5 μ s) only at one-pulse trigger SYNC reset/non-reset modes. At these modes, the shutter speed can be set in the range from 262.5H (1/60 s) to 0H (1/30000 s). The shutter speed is set with S302. The mode is set with switches No. 7 and No. 8 of S308. Then S301 is pressed once after confirming the power is turned ON.

S308 (mode setting)

No. 7 setting: In case of 1/60 (262.5H) to 1/984.3 (16H), set at OFF.

In case of 1/1049.9 (15H) to 1/30000, set at ON.

No. 8 set at ON: When setting the shutter speed at intervals of 1H.

(Turned OFF when direct setting by means of S305, S306 and S307.)

S302 (Shutter speed data)

Set the exposure period (H) (shutter speed) as binary data of 9 bit. Set '0' at ON, and '1' at OFF with 'No.1' side of S302 as LSB and 'No.9' side as MSB. For example, in case the exposure period is 8H (shutter speed ranging from $1/63.5 \times 8 \mu$ s to 1/2000 s.), S302 is set as below, since the number '8' is rewritten into '000001000' as binary data of 9 bit.

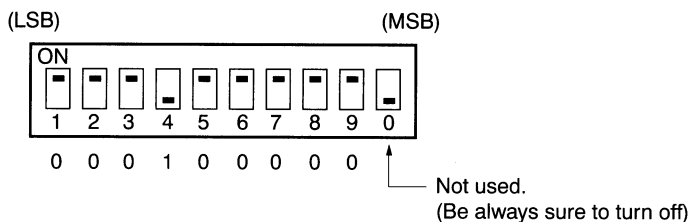

The exposure period A(H) and the shutter speed 1/B (s) can be obtained from the following equations. The obtained exposure period A(H) is rounded to the nearest integral number.

(1) One-pulse trigger SYNC reset mode

The shutter speed is set to be higher than 1/984.3 s (16H):

Exposure period A(H)=14318180/910 x shutter speed 1/B s.

The shutter speed is set at 1/984.3 s (16H) or lower:

Exposure period A(H)=14318180/910 x shutter speed 1/B s - 10

(2) One-pulse trigger SYNC non-reset mode

Exposure period A(H)=14318180/910 x shutter speed 1/B s.

Examples of setting input data of exposure period

Mode	Shutter speed	Input data	S308		MSB			S302					LSB	
			8	7	9	8	7	6	5	4	3	2	1	
One-pulse trigger SYNC-RESET	1/60s	252	ON	OFF	ON	OFF	OFF	OFF	OFF	OFF	OFF	OFF	ON	ON
	1/250s	53	ON	OFF	ON	ON	ON	OFF	OFF	ON	OFF	OFF	ON	OFF
	1/1000s	6	ON	OFF	ON	ON	ON	ON	ON	ON	OFF	OFF	ON	ON
	1/2000s	8	ON	ON	ON	ON	ON	ON	ON	OFF	ON	ON	ON	ON
	1/10000s	1	ON	ON	ON	ON	ON	ON	ON	ON	ON	ON	ON	OFF
One-pulse trigger SYNC-NONRESET	1/30000s	0	ON	ON	ON	ON	ON	ON	ON	ON	ON	ON	ON	ON
	1/60s	262	ON	OFF	OFF	ON	ON	ON	ON	ON	OFF	OFF	OFF	ON
	1/250s	63	ON	OFF	ON	ON	ON	ON	OFF	OFF	OFF	OFF	OFF	OFF
	1/1000s	16	ON	OFF	ON	ON	ON	ON	ON	OFF	ON	ON	ON	ON
	1/2000s	8	ON	ON	ON	ON	ON	ON	ON	ON	OFF	ON	ON	ON
	1/10000s	1	ON	ON	ON	ON	ON	ON	ON	ON	ON	ON	ON	OFF
	1/30000s	0	ON	ON	ON	ON	ON	ON	ON	ON	ON	ON	ON	ON

Mode	External input signal	S309 trigger mode setting	S308								Shutter speed	Remarks	
			Field/Frame Advance	1	2	3	4	5	6	7			8
Reset Start	Trigger input, SYNC non-reset, non-interfaced, HD: External sync.	7	OFF	OFF	OFF	ON	OFF	OFF	OFF	OFF	OFF	Set with rotary switch S307.	Reset/restart by trigger inputting, but SYNC is not reset by trigger inputting.
	Trigger input, SYNC non-reset, non-interfaced, VD: External sync.	7	OFF	OFF	OFF	ON	OFF	OFF	OFF	OFF	OFF	Set with rotary switch S307.	Reset/restart by trigger inputting, but SYNC is not reset by trigger inputting.
	Trigger input, SYNC non-reset, non-interfaced, HD/VD: External sync.	7	OFF	OFF	OFF	OFF	ON	OFF	OFF	OFF	OFF	Set with rotary switch S307.	Reset/restart by trigger inputting, but SYNC is not reset by trigger inputting.
	Trigger input, SYNC non-reset non-interfaced, C-SYNC/VBSYS: External sync.	7	OFF	OFF	OFF	OFF	ON	OFF	OFF	OFF	OFF	Set with rotary switch S307.	Reset/restart by trigger inputting, but SYNC is not reset by trigger inputting.
	SYNC reset	4	OFF	Can be set	OFF	OFF	ON	OFF	ON	Can be set		Set with rotary switch S307	The mode where video is output immediately after trigger inputting.
	SYNC reset, HD input	4	OFF	Can be set	OFF	OFF	OFF	OFF	OFF	Can be set		Set with rotary switch S307	The mode where video is output immediately after trigger inputting.
	SYNC non-reset, HD/VD: Internal sync.	6	OFF	Can be set	OFF	OFF	OFF	OFF	OFF	Can be set		Set at intervals of 1H with S302	The mode where video is output immediately after trigger inputting.
Onpulse trigger	SYNC non-reset, HD: External sync.	6	OFF	OFF	OFF	OFF	OFF	OFF	OFF	OFF	OFF	Set with rotary switch S307	SYNC is not reset by trigger inputting.
	SYNC non-reset, VD: External sync.	6	OFF	OFF	OFF	OFF	OFF	OFF	OFF	OFF	OFF	Set with rotary switch S307	SYNC is not reset by trigger inputting.
	SYNC non-reset, HD/VD: External sync.	6	OFF	OFF	OFF	ON	OFF	OFF	OFF	OFF	OFF	Set with rotary switch S307	SYNC is not reset by trigger inputting.
	SYNC non-reset, C-SYNC/VBSYS: External sync.	6	OFF	OFF	OFF	OFF	OFF	OFF	OFF	OFF	OFF	Set with rotary switch S307	SYNC is not reset by trigger inputting.
	SYNC non-reset, HD/VD: External sync.	6	OFF	OFF	OFF	OFF	OFF	OFF	OFF	OFF	OFF	Set with rotary switch S307	SYNC is not reset by trigger inputting.
	SYNC non-reset, C-SYNC/VBSYS: External sync.	6	OFF	OFF	OFF	OFF	OFF	OFF	OFF	OFF	OFF	Set with rotary switch S307	SYNC is not reset by trigger inputting.

S308		Output field	
No.2	No.3	ODD field	EVEN field
ON	OFF	ON	OFF
OFF	ON	OFF	ON
OFF	OFF	Designation OFF	Designation OFF

S308 No.2, No.3 Output field designation

S308 No.1 Field/Frame accumulation

- ON Frame accumulation
- OFF Field accumulation

12. DC POWER SUPPLY AND POWER CONNECTION

The following specifications are required for DC power supply (DC 12V).

Output voltage: DC12V \pm 10%
Current capacity: More than 600mA
Ripple voltage: Under 50mVp-p

Make sure to supply the camera with power from one terminal either of 'DC 12V IN' or 'DC IN/SYNC'. In case the power is supplied from both terminals simultaneously, the power supply may be damaged.

Terminal	Connector	Connector polarity
DC 12V IN	HIROSE HR10A-7P-4S	Pin 1, 2 : + Pin 3, 4 : -
DC IN/SYNC	HIROSE HR10A-10P-12S	Pin 2 : + Pin 1 : -

Use the supplied connector HR10A-7P-45 (of HIROSE). The connector consists of the following five parts a through e:

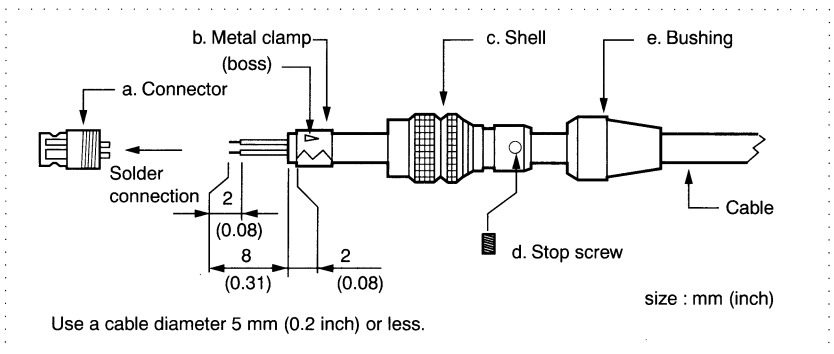

Procedures

1. Insert the cable into the bushing and the shell, as shown. (To avoid losing the stop screw, remove it beforehand.)
2. Solder the cable to the connector. (Check for continuity to avoid short circuit between terminals.)

Pin assignment: Pins 1, 2 + Pins 3, 4 -

3. Secure the metal clamp by clinching. Use the application tool HR10A-TC-02 of HIROSE. (Apply with 5.3 side.)
4. Screw the shell onto the connector until tight. (Make sure not turn the connector and the cable. Otherwise, the cable will be twisted.)
5. Tighten the stop screw so that it fits securely into the boss. Use a 0.05 inch (1.27 mm) hexagon wrench.
6. Slide the bushing up until it fits securely against the shell, covering the connections.

13. TROUBLESHOOTING CHART

Symptoms	Possible causes
No image	<ul style="list-style-type: none"> • Is power properly supplied? • Is the lens iris adjusted properly? • Is the TV monitor adjusted properly? • Is the switch for mode setting set properly? • Is RR VD input at reset/restart mode? • Is trigger input at one-pulse trigger mode?
Dark image	<ul style="list-style-type: none"> • Is shutter speed set properly?
External sync. is not available.	<ul style="list-style-type: none"> • Is the switch for mode setting set properly? • Is external input pulse input at correct phase? • Is external input pulse input within the specified frequency range? • Is 75Ω ON/OFF switch positioned properly? (Is 75Ω terminal is necessary for the signal input from the external unit or TTL level?) • Is external input pulse input from HD/VD terminal, and DC IN/ SYNC terminal simultaneously? (The pulse should be input from one terminal only.)

14. CONFIGURATION

(1) IK-M41F2, IK-M41R2

- (1) Camera head (attached to head cover)
- (2) Camera control unit
- (3) Accessories
 - (a) Camera holder
 - (b) 4-pin connector (HR 10A-7-P-4S)
 - (c) Instruction manual

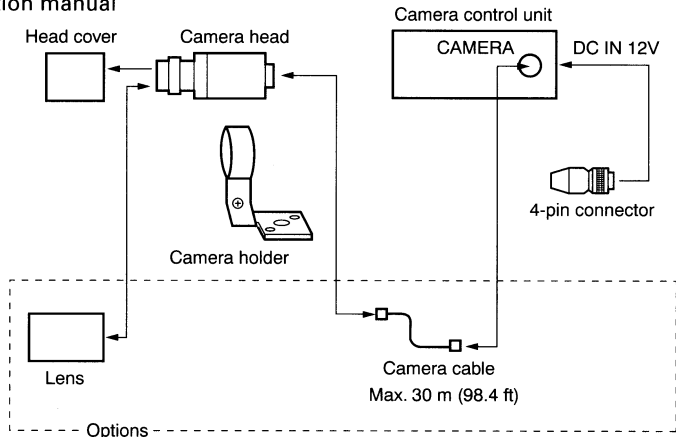

(2) IK-C41F2

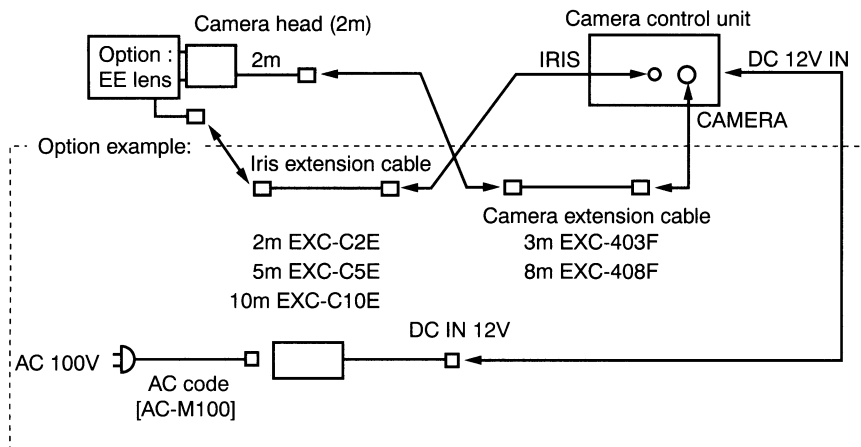

15. OPTIONS

Lens

Model	Focal length mm (inch)
JK-L03M	3 (0.12)
JK-L04M2	4 (0.16)
JK-L75M	7.5 (0.3)
JK-L15M2	15 (0.6)
JK-L24M2	24 (0.94)

Camera Cable

Model	Length m (ft)	Diameter mm (inch)
EXC-401M	1 (3.3)	5.0 (0.2)
EXC-402M	2 (6.5)	5.0 (0.2)
EXC-403M	3 (9.8)	5.0 (0.2)
EXC-405M	5 (16.4)	5.0 (0.2)
EXC-410M	10 (32.8)	7.0 (0.28)
EXC-415M	15 (49.2)	7.0 (0.28)
EXC-420M	20 (65.6)	7.0 (0.28)
EXC-430M	30 (98.4)	7.0 (0.28)

16. SPECIFICATIONS

IK-M41F2, IK-M41R2

Power source	DC12V \pm 10%	
Power current consumption	250mA	
Image element	1/2" interline-transfer CCD (768H x 494V effective picture elements)	
Scan area	6.54 mm x 4.89 mm	
Scanning frequency	15.734 kHz (horizontal), 59.94 Hz (Vertical)	
Sync. system	Internal/External sync. (automatic change-over) <ul style="list-style-type: none"> • C-SYNC/VS mode • HD, VD mode • Reset/Restart mode • One-pulse trigger mode 	
Resolution	570 TV lines (Horizontal) More than 400 TV lines (Vertical) at Frame accumulation mode More than 350 TV lines (Vertical) at Field accumulation mode	
Recommended illumination	36 lx (F1.6 3200K)	
Minimum illumination	1.8 lx (50 IRE F1.6, $\gamma=0.45$, built-in infrared-proof filter)	
S/N ratio	More than 56dB ($\gamma=1$, WEIGHT ON)	
Output signal	VS1.0Vp-p, NTSC compatible	
Output impedance	75 Ω , unbalanced	
Infrared-proof filter	Built-in (IK-M41F2) Dummy Glass (IK-M41R2)	
Ambient temperature	-10°C to +50°C (14F to 122F)	
Ambient humidity	30% to 90%	
Vibration resistance	68.6 m/s ² (10 to 200Hz)	
Shock resistance (camera head)	686 m/s ²	
Weight	Camera	16g (0.56 oz) without lens
	CCU	510g (18 oz)
Dimensions	Refer to 'PROFILE'.	
Auxiliary function	AES	Auto (Automatic electronic shutter)/Manual/Fixed (electronic shutter) (Factory preset at Manual)
	Electronic shutter	1/60, 1/100, 1/125, 1/250, 1/500, 1/1000, 1/2000, 1/4000, 1/10000 sec. (Factory preset at 1/60 sec.) (Every 1H between 1/60 to 1/30000 at one-pulse trigger mode)
	Accumulation	Field/Frame modes (Factory preset at Field)
	γ correction	1/0.45 (Factory preset at 1)
	Sensitivity	Normal to +12dB (Adjustable) (Factory preset at normal)
Others	Video index output, Video out field designation, Video output (DC direct connection, Condenser coupling)	
Options	Refer to 'OPTIONS'.	

* Design and specifications are subject to change without prior notice.

* Dimensions and weight are approximate ones.

NOTE: The camera head and the camera control unit (CCU) are to be used as a set with matching numbers.

Power source	DC12V \pm 10%	
Power current consumption	250mA	
Image element	1/2" interline-transfer CCD (769H x 494V effective picture elements)	
Scan area	6.54 mm x 4.89 mm	
Scanning frequency	15.734 kHz (horizontal), 59.9 Hz (Vertical)	
Sync. system	Internal/External sync. (automatic change-over) <ul style="list-style-type: none"> • C-SYNC/VS mode • HD, VD mode • Reset/Restart mode • One-pulse trigger mode 	
Resolution	570 TV lines (Horizontal) More than 350 TV lines (Vertical) at Field accumulation mode More than 400 TV lines (Vertical) at Frame accumulation mode	
Recommended illumination	20 lx (F1.2 3200K)	
Minimum illumination	1 lx (50 IRE F1.2, $\gamma=0.45$, built-in infrared-proof filter)	
S/N ratio	More than 56 dB ($\gamma=1$, WEIGHT ON)	
Output signal	VS1.0V(p-p), NTSC compatible	
Output impedance	75 Ω , unbalanced	
Infrared-proof filter	Built-in	
Ambient temperature	-10°C to +50°C (14F to 122F)	
Ambient humidity	30% to 90%	
Vibration resistance	68.6 m/s ² (10 to 200Hz)	
Shock resistance	686 m/s ²	
Weight	Camera head	190g (include camera cable 2m) (6.7 oz)
	CCU	510g (18 oz)
Dimensions	Camera head: 32 x 32 x 45 (WXHXD) Camera control unit: 80 x 40.2 x 156.5 (WxHxD)	
Auxiliary function	AES	Auto (Automatic electronic shutter)/Manual/Fixed (electronic shutter) (Factory preset at Manual)
	Electronic shutter	1/60, 1/100, 1/125, 1/250, 1/500, 1/1000, 1/2000, 1/4000, 1/10000 sec. (Factory preset at 1/60 sec.) (Every 1H between 1/60 to 1/30000 at one-pulse trigger mode)
	Accumulation	Field/Frame modes (Factory preset at Field)
	γ correction	1/0.45 (Factory preset at 1)
	Sensitivity	Normal to +12 dB (Adjustable) (Factory preset at normal)
Others	Video index output, Video out field designation, Video output (DC direct connection, Condenser coupling)	
Options	Refer to 'OPTIONS'.	

* Design and specifications are subject to change without prior notice.

* Dimensions and weight are approximate ones.

NOTE: The camera head and the camera control unit (CCU) are to be used as a set with matching numbers.

17. EXTERIOR VIEW

Camera Head IK-M41F2, IK-M41R2

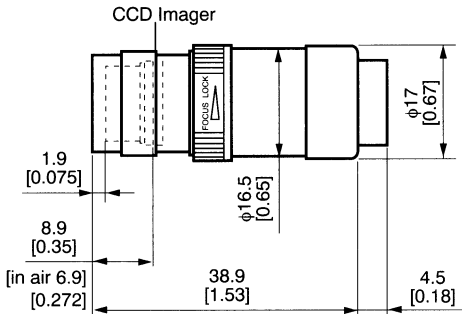

Camera Holder (IK-M41F2, IK-M41R2)

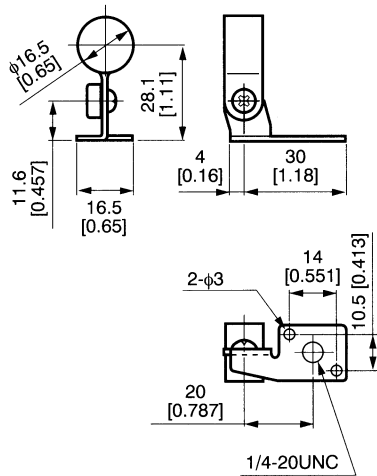

Camera Head IK-C41F2

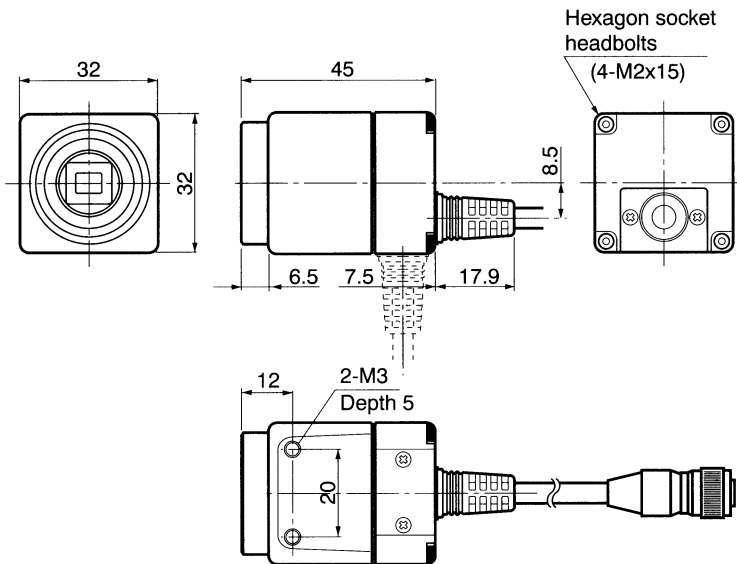

Camera Control Unit

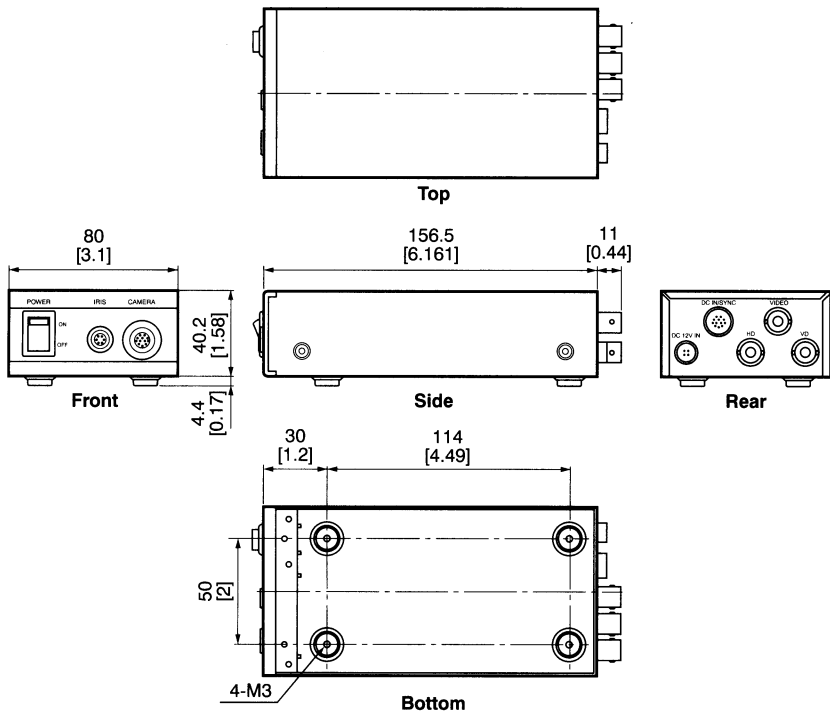

Dimensions. mm [inch]
ø: diameter

Free Manuals Download Website

<http://myh66.com>

<http://usermanuals.us>

<http://www.somanuals.com>

<http://www.4manuals.cc>

<http://www.manual-lib.com>

<http://www.404manual.com>

<http://www.luxmanual.com>

<http://aubethermostatmanual.com>

Golf course search by state

<http://golfingnear.com>

Email search by domain

<http://emailbydomain.com>

Auto manuals search

<http://auto.somanuals.com>

TV manuals search

<http://tv.somanuals.com>