

### CAMERA CONTROL UNIT

# IK-CU43A

**For Customer Use**

Enter below the Serial No. which is located on the bottom of the cabinet. Retain this information for future reference.

Model No.: IK-CU43A \_\_\_\_\_

Serial No.: \_\_\_\_\_

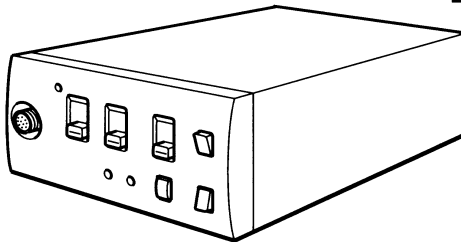
**INFORMATION**

This equipment has been tested and found to comply with the limits for a Class A digital device, pursuant to Part 15 of the FCC Rules. These limits are designed to provide reasonable protection against harmful interference when the equipment is operated in a commercial environment. This equipment generates, uses, and can radiate radio frequency energy and, if not installed and used in accordance with the instruction manual, may cause harmful interference to radio communications. Operation of this equipment in a residential area is likely to cause harmful interference in which case the user will be required to correct the interference at his own expense.

**USER-INSTALLER CAUTION:** Your authority to operate this FCC verified equipment could be voided if you make changes or modifications not expressly approved by the party responsible for compliance to Part 15 of the FCC rules.

This Class A digital apparatus meets all requirements of the Canadian Interference Causing Equipment Regulations.

Cet appareil numérique de la classe A respecte toutes les exigences du Règlement sur le matériel brouilleur du Canada.

# TABLE OF CONTENTS

1. COMPONENTS .....	3
2. SPECIFICATIONS .....	3
3. NAMES AND FUNCTIONS .....	4
4. CONNECTION .....	6
4.1 An Example of Standard Connection .....	6
4.2 Cautions on Connection .....	6
4.3 Connection on Back Panel .....	7
4.4 Connector Pin Assignments .....	7
5. WHEN USING THE CAMERA WITH THE CAMERA UNIT FIXED .....	8
6. OPERATION .....	9
6.1 AGC (Automatic Gain Control) .....	9
6.2 White Balance .....	9
(1) White balance adjustment in modes other than AUTO .....	10
(1.1) White balance adjustment in SET mode .....	10
(1.2) White balance adjustment in MANU mode .....	10
6.3 FUNC LOCK Switch .....	10
7. MODE SETTING BY ON SCREEN DISPLAY .....	11
7.1 FILE (Scene File) .....	12
7.2 SHUTTER (Electronic Shutter, Backlight Correction) .....	12
(1) Detail setting in AUTO mode (auto electronic shutter) .....	13
(2) SS (synchronized scan) .....	13
7.3 Pedestal .....	14
7.4 SYNC (Setting for External Synchronization) .....	14
7.5 AREA (Measurement Area) .....	15
(1) Setting AREA the same for AGC, auto electronic shutter and white balance .....	15
(2) Setting AREA separately for AGC, auto electronic shutter and white balance .....	16
7.6 WB-OFFSET (White Balance Offset) .....	17
7.7 INIT. (Scene File Initialization) .....	18
7.8 END (Ending ON SCREEN DISPLAY) .....	18
8. EXTERNAL SYNC .....	19
9. CAUTIONS ON USE AND INSTALLATION .....	20
10. BEFORE MAKING A SERVICE CALL .....	20
11. OPTIONAL PARTS .....	21
12. EXTERIOR DIMENSIONS .....	22

# 1. COMPONENTS

- (1) Camera control unit ..... 1
- (2) Accessories
  - (a) Instruction manual ..... 1

# 2. SPECIFICATIONS

Specification with camera head (IK-M43H) connected.

Power supply		DC12V $\pm$ 0.5V
Power consumption		310 mA
Image sensor		1/2 inch IT-CCD
Effective pixels		Horizontal: 768 pixels, Vertical: 494 pixels
Effective image area		Horizontal: 6.54 mm, Vertical: 4.89 mm (1/2 inch type)
Scanning system		2:1 interlace
Scan frequency		Horizontal: 15.734 kHz, Vertical: 59.94 Hz
Sync system		Internal/External (automatic switching)
Resolution		Horizontal: More than 470 lines, Vertical: More than 350 lines
Standard intensity of illumination for objects		60 lx (F1.6, 3000K)
Minimum intensity of illumination for objects		5 lx (F1.6, 3000K)
S/N ratio		46 dB or more
Video output		VBS 1.0 V(p-p), (BNC terminal) NTSC system Y/C separation output (S terminal)
Output impedance		75 $\Omega$ unbalanced
External sync	Input	VBS 1.0 V(p-p) (BNC terminal) NTSC 75 $\Omega$ unbalanced
	Adjustment function	Subcarrier phase, H phase
White balance		Automatic/set/manual
Gain switch (AGC)		SENS UP (+6 dB)/ON/OFF
Electronic shutter		Automatic, 1/60s, 1/100s, 1/250s, 1/500s, 1/1000s, 1/2000s, 1/4000s, 1/10000s, synchronized scan
Operating temperature/humidity		14°F to 104°F (-10°C to +40°C)/Less than 90%
Anti-vibration/shock characteristics		70 m/s <sup>2</sup> (10 to 200 Hz)/700 m/s <sup>2</sup>
Weight		Control unit: 0.86 lbs (390g)
Dimensions (Without protrusion)		Control unit: W: 3.35", H: 1.57", D: 6.14" (W: 85 mm, H: 40 mm, D: 156 mm)

Design and specifications are subject to change without notice.

# 3. NAMES AND FUNCTIONS

## Camera Control Unit

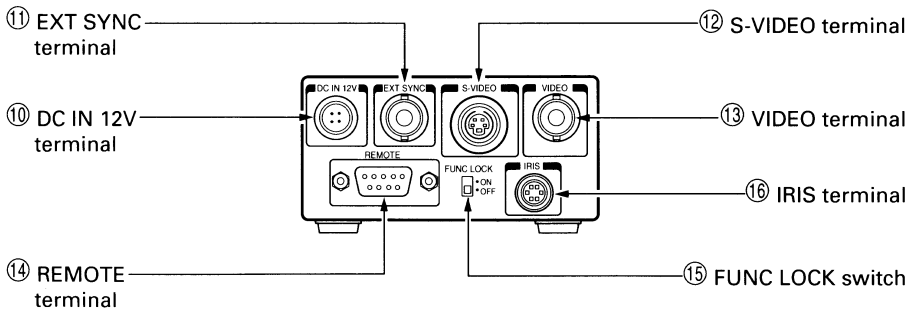
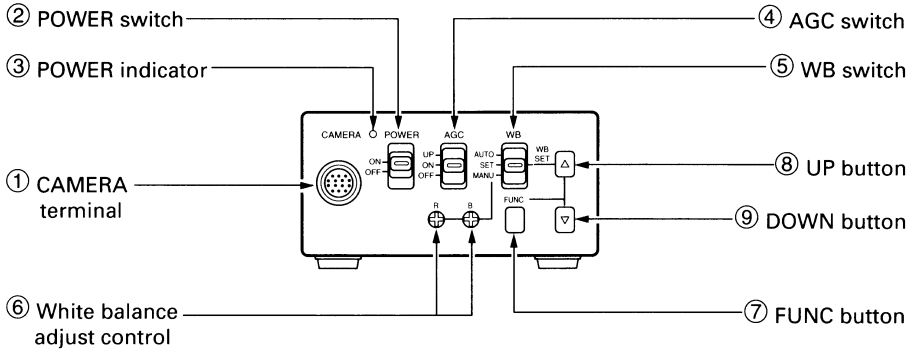

① CAMERA terminal	Connects to the camera head.
② POWER switch	Turns on and off the camera control unit.
③ POWER indicator	Lights up when the power is turned on.
④ AGC switch	Selects the gain mode. (AGC OFF/AGC ON/SENS UP)
⑤ WB switch	Selects the white balance mode. (MANU/SET/AUTO)
⑥ White balance adjust control	Adjusts the R gain and B gain with the white balance mode set to MANU by the WB switch ⑤.
⑦ FUNC button	Determines the setting indication contents when the setting menu is displayed on the screen.
⑧ UP button	Selects the setting item when the setting menu is displayed on the screen. (When the WB switch ⑤ is set to SET, pressing the UP button for more than 2 sec. activates the white balance SET operation.)
⑨ DOWN button	Selects the setting item when the setting menu is displayed on the screen.
⑩ DC IN 12V terminal	Accepts a DC power supply (12V).
⑪ EXT SYNC terminal	Accepts an external sync signal to synchronize the camera output signal with external signal.
⑫ S-VIDEO terminal	Connects terminal to S input terminal of a monitor or a VCR, etc. Can be used at the same time as video terminal.
⑬ VIDEO terminal	Connects terminal to video input terminal of a monitor or a VCR, etc. Can be used at the same time with the S-VIDEO terminal.
⑭ REMOTE terminal	Controls the functions via RS232C.
⑮ FUNC LOCK switch	Locks the switches and control on the front panel. When the FUNC LOCK switch is set to ON, all settings except for the POWER switch ② and the file item of the screen setting menu are locked out.
⑯ IRIS terminal	Connect when using an automatic iris lens.

## 4. CONNECTION

### 4.1 An Example of Standard Connection

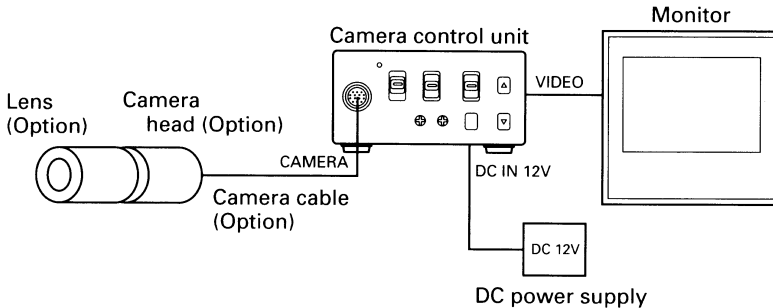

### 4.2 Cautions on Connection

- When connecting or disconnecting the camera cables (for the camera head and camera control unit), always turn off the power switch of the camera control unit first. If not, the camera head may be damaged.
  - When connecting the camera, always turn off the power of the camera control unit and any other equipment connected.
- ① Remove the camera head protection cover and mount a lens (option).
  - ② Connect the camera head and the camera control unit with the camera cable (option).
  - ③ Connect the VIDEO (or S-VIDEO) terminal of the camera control unit to a video input terminal of a monitor, etc.
  - ④ Connect a DC power supply (12V) to the DC IN 12V terminal of the camera control unit.
- For DC power supply connecting to DC IN 12V terminal, use UL listed and/or CSA approved ungrounding type AC adaptor with the specifications described below.

Power supply voltage:	DC12V $\pm$ 0.5V
Current rating:	More than 800 mA
Ripple voltage:	Less than 50 mV(p-p)
Connector:	HR10A-7P-4S (Hirose)
	Pins 1, 2: $\oplus$ , Pins 3, 4: $\ominus$

## 4.3 Connection on Back Panel

The figure below shows the back panel connection terminals of the camera control unit.

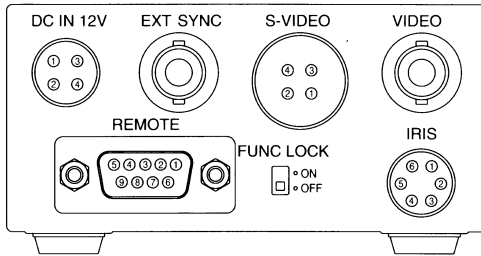

## 4.4 Connector Pin Assignments

### DC IN 12V

1	+12V
2	+12V
3	GND
4	GND

### S-VIDEO

1	GND
2	GND
3	Y
4	C

### REMOTE

1	NC
2	TXD
3	RXD
4	DSR
5	GND
6	DTR
7	CTS
8	RTS
9	NC

### IRIS

1	NC
2	VIDEO
3	GND
4	+12V
5	GND
6	NC

\* When using the REMOTE terminal, please consult with your dealer.

### • Using the auto-iris lens

The following table shows the IRIS terminal when using the auto-iris (EE) lens.

Table 1

IRIS Connector Terminal No.	Signal	Rated
1	—	
2	Video signal	$0.8 \pm 0.1V_{p-p}$
3	GND	
4	Power (DC)	+ 12V (less than 50mA)
5	(GND)	
6	—	

The IRIS connector used for the IRIS terminal: HR10A-7P-6P of HIROSE ELECTRIC CO., LTD.

- EE lens

The IRIS extension cable (optional) is usable for the EE lens. Use the connector HR10A-7P-4P of HIROSE when the IRIS extension cable is selected. For connections, follow the instruction below.

When the IRIS extension cable is used under the right condition, the cable automatically converts to connection for the EE lens in Table 1. See the Chapter OPTIONS for the IRIS extension cable.

**EE lens connector  
HR10A-7P-4P**

1. Power (+)
2. GND
3. Video signal
4. Unconnected or ground

**Notes:**

- **Current consumption must be 50 mA or less.**
- **Avoid an incorrect connection or short-circuit.**

## 5. WHEN USING THE CAMERA WITH THE CAMERA UNIT FIXED

The camera control unit can be directly mounted by using M3 screws if the four rubber feet are removed on bottom of the control unit. When mounting directly as described above, do not use longer screws. If the screws enter by more than 5 mm from the control unit mounting surface, they will cause a short-circuit inside the control unit. For details of screw hole locations, refer to the exterior dimensions of the camera control unit.



## 6. OPERATION

Turn on the POWER switch on the camera control unit and adjust the lens iris and focus while observing a picture on the monitor screen. To obtain the best picture quality, perform various settings.

### 6.1 AGC (Automatic Gain Control)

AGC functions "OFF", "ON" or "UP" can be selected on the screen menu. Generally, the camera is used with the AGC set to OFF, but when increased camera sensitivity is required, it is set to ON. When more sensitivity is required, "UP" is selected. With the AGC ON, the camera sensitivity approximately doubles, and with the UP selected the sensitivity approximately doubles again, but noise will also increase. We recommend you increase intensity of the lighting to obtain good pictures.

The AGC measurement area is the same as that used for "AREA". (Refer to item 7.5)

### 6.2 White Balance

A white balance adjustment is necessary to obtain pictures with correct color tone. This camera allows you to select the white balance adjustment of "AUTO", "SET", and "MANU". With the AUTO mode selected, the camera adjusts the white balance automatically. Most shooting will be made in the AUTO mode. The color temperature applicable to this camera is approximately 2500 to 7000K.

	<b>AUTO</b>	<b>SET</b>	<b>MANU</b>
<b>Outline</b>	Camera automatically measures object color temperature and adjusts the white balance.	Adjust white balance by pressing "UP" button on the camera control unit while shooting a white object.	Adjust R (red) and B (blue) levels on the control unit while shooting a white object.
<b>Features</b>	Automatically traces variations of color temperature and adjusts the white balance.	Measurement accuracy is higher than AUTO mode. This mode is effective when shooting under less variations of color temperature.	Measurement accuracy is higher than SET mode. This mode is effective for users desiring specific color temperature, also effective when shooting under the least variations of color temperature.
<b>Notes</b>	Under poor illumination, white balance may not be correct.		Adjustment will be made by viewing monitor or vector scope.

## **(1) White balance adjustment in modes other than AUTO**

### **(1.1) White balance adjustment in SET mode**

- ① Set the WB switch to "SET" position.
- ② Shoot a white object to fill entire screen and press the UP button (▲) for about 2 sec.
- ③ When the white balance adjustment completes, the letters "WB SET" blinking at the upper right of the screen changes to "WB OK" and then turns off. If the "WB NG" is displayed, it shows the white balance is out of the adjustment range. This is caused by the object not being white enough, or the video level is set too high or too low even if the white object is shot. Shoot the white object or set the video level correctly.

#### **Note:**

- **With the screen menu displayed, the UP button is used for moving the cursor or modifying the data. To activate the SET mode by pressing the UP button, turn off the screen menu.**

### **(1.2) White balance adjustment in MANU mode**

- ① Set the WB switch to "MANU" position.
- ② Shoot the white object and adjust the white balance by adjusting the white balance adjust controls "R" and "B" with the screwdriver while observing the monitor or vector scope.

## **6.3 FUNC LOCK Switch**

The FUNC LOCK switch protects settings even if a switch is accidentally pressed after setting. When the FUNC LOCK switch is ON, only the following functions are available.

POWER switch (ON/OFF)

FILE (A/B) in menu

Settings will not be changed even if the other switches are operated. In the menu screen, all except FILE and END are displayed in black letters (white when the FUNC LOCK switch is OFF) and "FUNCTION LOCK ACTIVE" blinks to indicate that the FUNC LOCK switch is ON.

FILE	A
SHUTTER	AUTO
PEDESTAL	00
SYNC	INT
AREA	LINK:1
WB-OFFSET	00
INIT.	
END	
FUNCTION LOCK ACTIVE	
PUSH <b>FUNC</b> TO SELECT	

## 7. MODE SETTING BY ON SCREEN DISPLAY

Setting while monitoring the menu on the monitor screen is possible. The following seven items can be set.

- ① Scene file
- ② Electronic shutter (AUTO/MANUAL), backlight correction
- ③ Pedestal level
- ④ Phase matching in external synchronization (horizontal/subcarrier synchronization)
- ⑤ White balance, auto electronic shutter, AGC measurement area
- ⑥ White balance offset
- ⑦ Scene file factory setting

Press the FUNC button to display the menu. The menu appears as shown on the right. Current setting is displayed. Move the cursor to a desired item by moving the cursor up or down using the UP and DOWN buttons, and set an item by pressing the FUNC button. To quit the menu, move the cursor to END and press the FUNC button.

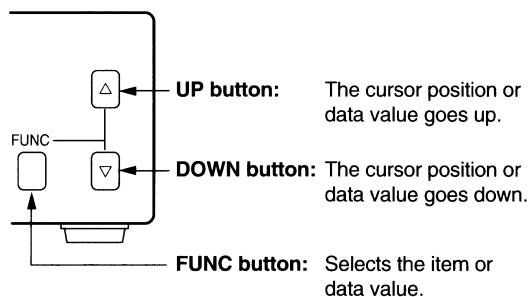

Main Menu

<b>FILE</b>	A
SHUTTER	AUTO
PEDESTAL	00
SYNC	INT
AREA	LINK:1
WB-OFFSET	00
INIT.	
END	
PUSH <b>FUNC</b> TO SELECT	

### Notes:

- **When setting is changed in the menu screen, be sure to move the cursor to "END" and press the FUNC button to turn off the menu. New setting is stored in the camera.**
- **Don't turn off the POWER switch before turning off the menu. New setting is not stored, and old data remains.**

## 7.1 FILE (Scene File)

There are two scene files A and B which can be selected according to the shooting state.

- ① Move the cursor to "FILE" in the main menu using the UP or DOWN button.
- ② Press the FUNC button to display the contents to set FILE, A or B. Move the cursor to A or B using the UP or DOWN button. Press the FUNC button to set the contents.

### Note:

- The scene file is for the menu screen. The AGC switch and the WB switch are only valid in their set positions.
- The new settings are memorized when the POWER is turned off.

```
FILE      A
SHUTTER   AUTO
PEDESTAL  00
SYNC      INT
AREA      LINK:1
WB-OFFSET 00
```

```
INIT.
END
```

PUSH **FUNC** TO SELECT

```
FILE      A
SHUTTER   B
PEDESTAL
SYNC
AREA
WB-OFFSET
```

```
INIT.
END
```

PUSH **FUNC** TO SELECT

## 7.2 SHUTTER (Electronic Shutter, Backlight Correction)

The electronic shutter is available in AUTO (auto electronic shutter), 1/60 ~ 1/10000 and SS (synchronized scan).

**AUTO:** Controls electronic shutter automatically to output the set video level. Can be selected in backlight correction, peak measurement, average measurement and measurement area.

**1/60~1/10000:** Exposure time can be fixed to any one of 1/60, 1/100, 1/250, 1/500, 1/1000, 1/2000, 1/4000 and 1/10000.

**SS:** Sets the electronic shutter in horizontal scanning time intervals of 1H.

- ① Move the cursor to "SHUTTER" in the main menu using the UP or DOWN button.
- ② Press the FUNC button to display AUTO ~ EXIT to set SHUTTER. Move the cursor to a desired item of AUTO ~ SS using the UP or DOWN buttons. Press the FUNC button to frame a desired item in white.
- ③ Move the cursor to "EXIT" using the UP or DOWN button. Press the FUNC button. Return to the main menu.

```
FILE      A
SHUTTER   AUTO
PEDESTAL  00
SYNC      INT
AREA      LINK:1
WB-OFFSET 00
```

```
INIT.
END
```

PUSH **FUNC** TO SELECT

```
FILE      AUTO
SHUTTER   1/60
PEDESTAL  1/250
SYNC      1/500
AREA      1/1000
WB-OFFSET 1/2000
          1/4000
INIT.     1/10000
END       SS 262/525H
          EXIT
PUSH FUNC TO SUB MENU
```

## **(1) Detail setting in AUTO mode (auto electronic shutter)**

When the FUNC button is pressed after AUTO is selected, the submenu for SHUTTER:AUTO appears. Set details in this screen.

**LEVEL:** Adjust the auto electronic shutter video level. Larger values indicates brighter level, and vice versa. Data can be set in a range of -30 to +30.

**BLC:** Correction for backlight. This can be set when the measurement area is set to one of "1/2", "1/8" and "SLIT" for AREA in the main menu. Backlight is corrected at ON, but not at OFF. When the measurement area is "1", BLC is displayed in black letters and setting is impossible.

**PEAK:AVE:** Selects peak or average for measurement of auto electronic shutter video level. The peak to average ratio can be changed in a range of 00:10 to 10:00.

### **Note:**

- **While BLC is ON, PEAK:AVE is displayed in black letters and setting is impossible.**

- ① Move the cursor to a desired item (LEVEL, BLC, PEAK:AVE) using the UP or DOWN button. Press the FUNC button. The cursor moves to the data of the selected item. Set the data by pressing the UP or DOWN button.
- ② After setting the data, press the FUNC button. The cursor moves to the item. To finish setting of submenu, move the cursor to "EXIT" and press the FUNC button to return to "SHUTTER" in the main menu.

	<b>AUTO</b>	
FILE		1/60
<b>SHUTTER</b>		1/100
PEDESTAL		1/250
SYNC		1/500
AREA		1/1000
WB-OFFSET		1/2000
		1/4000
INIT.		1/10000
END		SS 262/525H
		EXIT
PUSH <b>FUNC</b>	TO SUB MENU	

SHUTTER:	<b>AUTO</b>	SUB MENU
<b>LEVEL</b>		00
BLC		OFF
PEAK: AVE		00:10
		EXIT
PUSH <b>FUNC</b>	TO SELECT	

SHUTTER:	<b>AUTO</b>	SUB MENU
<b>LEVEL</b>		<b>00</b>
BLC		
PEAK: AVE		
		EXIT
PUSH <b>FUNC</b>	TO SELECT	

Example of display for LEVEL

## **(2) SS (synchronized scan)**

- ① Move the cursor to "SS" using the UP or DOWN button. Press the FUNC button. (SS is set.)
- ② Press the FUNC button. The cursor moves to the data and blinks. The data varies in 1/525H to 262/525H when the UP or DOWN button is pressed. Set a desired data, and press the FUNC button.
- ③ Return to "SS" of SHUTTER.

		AUTO
FILE		1/60
<b>SHUTTER</b>		1/100
PEDESTAL		1/250
SYNC		1/500
AREA		1/1000
WB-OFFSET		1/2000
		1/4000
INIT.		1/10000
END		<b>SS 262/525H</b>
		EXIT
PUSH <b>FUNC</b>	TO SELECT	

## 7.3 Pedestal

- ① Move the cursor to PEDESTAL using the UP or DOWN button.
- ② Press the FUNC button. The cursor moves to the data. Set the data using the UP or DOWN button. The data can be set in a range of -50 to +50. After setting the data, press the FUNC button to return to the main menu.

```
FILE          A
SHUTTER      AUTO
PEDESTAL     00
SYNC         INT
AREA         LINK:1
WB-OFFSET    00

INIT.
END

PUSH FUNC TO SELECT
```

```
FILE          .
SHUTTER      .
PEDESTAL     00
SYNC         .
AREA         .
WB-OFFSET    .

INIT.
END

PUSH FUNC TO SELECT
```

## 7.4 SYNC (Setting for External Synchronization)

This adjusts horizontal phase and subcarrier phase while externally synchronized. INT is displayed for internal synchronization and changed automatically to EXT when the external synchronizing signal is entered.

- ① Move the cursor to "SYNC" using the UP or DOWN button.
- ② Press the FUNC button to display the available items (H-PHS, SC-PHS, SC-FINE).

H-PHS: H (horizontal) phase matching 0 ~ 99

SC-PHS: SC (subcarrier) rough adjustment 0, 90, 180, 270

SC-FINE: SC (subcarrier) fine adjustment 0 ~ 99

```
FILE          A
SHUTTER      AUTO
PEDESTAL     00
SYNC        INT
AREA         LINK:1
WB-OFFSET    00

INIT.
END

PUSH FUNC TO SELECT
```

```
FILE          A
SHUTTER      AUTO
PEDESTAL     00
SYNC        EXT.VBS
AREA         LINK:1
WB-OFFSET    00

INIT.
END

PUSH FUNC TO SELECT
```

- ③ Move the cursor to a desired item (H-PHS, SC-PHS, SC-FINE) using the UP or DOWN button. Press the FUNC button and the data is displayed. Set the data using the UP or DOWN button and press the FUNC button to select the data. To return to the main menu, move the cursor to EXIT and press the FUNC button.

**Note:**

- **If the internal synchronization is set while the SYNC item (H-PHS, SC-PHS, SC-FINE) is being displayed, the display automatically turns to INT, disabling setting.**

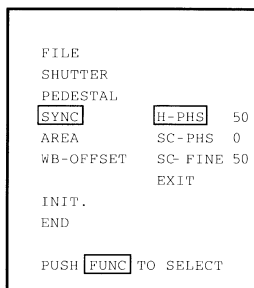

## 7.5 AREA (Measurement Area)

AREA is a measurement AREA item for AGC, auto electronic shutter and white balance. The AREA setting for AGC and auto electronic shutter are the same, so each setting can not be made separately. However, the AREA setting for white balance can be made independently from the AREA setting for AGC and auto electronic shutter.

- ① Move the cursor to AREA using the UP or DOWN button.
- ② Press the FUNC button to display the available items (LINK, SEP).
- ③ Move the cursor to a desired item (LINK, SEP) using the UP or DOWN button.

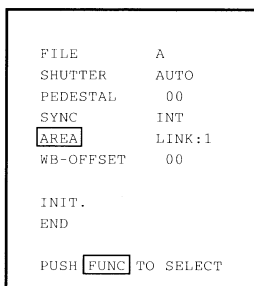

### **(1) Setting AREA the same for AGC, auto electronic shutter and white balance**

- ① Move the cursor to LINK using the UP or DOWN button.

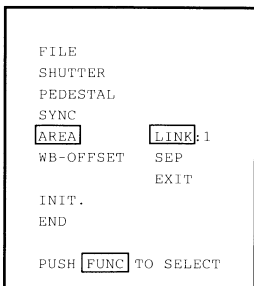

- ② Press the FUNC button to display data 1 ~ SLIT for LINK. Move the cursor to a desired item of AREA data (1, 1/2, 1/8, SLIT) using the UP or DOWN button.
- ③ Press the FUNC button to set the data.

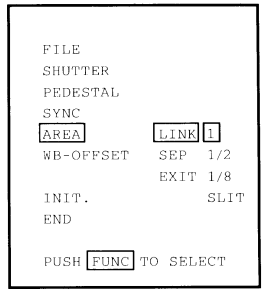

## (2) Setting AREA for white balance separately from the AREA setting for AGC and auto electronic shutter

- ① Move the cursor to SEP using the UP or DOWN button, and press the FUNC button. SEP is selected and framed in white.
- ② Press the FUNC button to display the submenu.
- ③ Move the cursor to a desired item using UP or DOWN button.

WB: Measurement AREA for white balance  
1, 1/2, 1/8, SLIT  
Valid when the WB switch is AUTO and/or SET.

SHUTTER: Measurement AREA for auto electronic shutter and AGC  
1, 1/2, 1/8, SLIT

- ④ Press the FUNC button to select a desired item. The setting data (1, 1/2, 1/8, SLIT) is displayed. Move the cursor to a desired item using UP or DOWN button, then press the FUNC button to select the data.
- ⑤ The submenu for AREA appears. Move the cursor to EXIT, and press the FUNC button to return to the main menu.

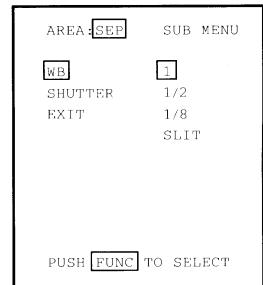
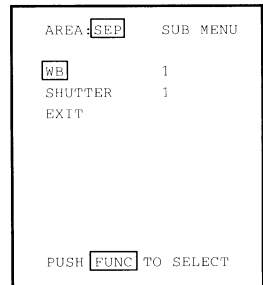
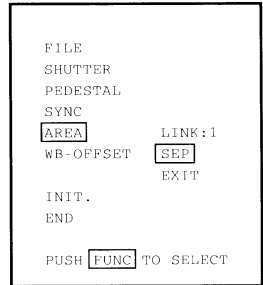

The size of AREA is approximately as shown below.

(1) 1 (Whole monitor screen)

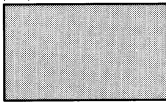

(2) 1/2

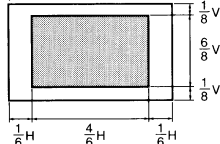

(3) 1/8

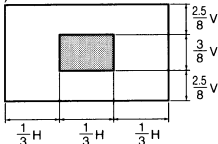

(4) SLIT

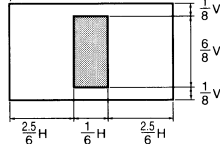



## 7.6 WB-OFFSET (White Balance Offset)

This offsets the white balance in the direction of orange or cyan when the WB switch is set to "SET".

- ① Move the cursor to WB-OFFSET using the UP or DOWN button.
- ② Press the FUNC button. The cursor moves to the data item.
- ③ Change the data using the UP or DOWN button.
  - +20 ~ -20
  - + Orange direction
  - Cyan direction

Press the FUNC button at a desired data value to set the data.

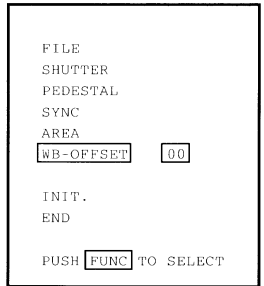
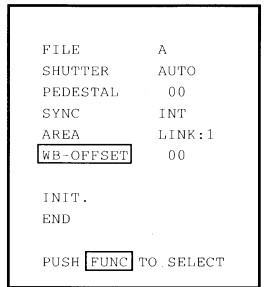

## 7.7 INIT. (Scene File Initialization)

This reset settings of the scene file to the factory setting.

- ① Select a scene file (A or B) to initialize the setting in FILE.
- ② Move the cursor to INIT. using the UP or DOWN button.
- ③ Press the FUNC button. The selected scene file (A or B) is displayed. NO/YES is displayed.
- ④ Select NO when not initializing. Select YES and press the FUNC button when initializing.

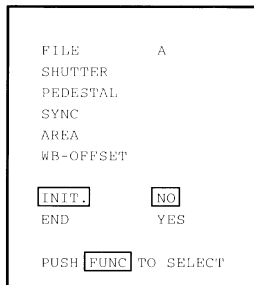
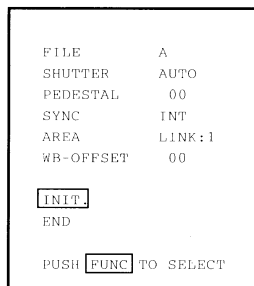

Factory setting (the following setting if INIT. is executed)

The setting is common to scene files A and B.

SHUTTER	AUTO				LEVEL	00
PEDESTAL	00				BLC	OFF
SYNC	EXT.VBS			H-PHS	50	
AREA	LINK:1	(	SEP WB	1	SC-PHS	0
			SHUTTER	1	SC-FINE	50
WB-OFFSET	00					
					PEAK:AVE	00:10

## 7.8 END (Ending ON SCREEN DISPLAY)

To turn off the menu, move the cursor to END using the UP or DOWN button and press the FUNC button. To store the setting in the camera, be sure to turn off the display by pressing END. When the display is turned off, the setting is stored in the camera. If the POWER switch is turned off while the menu is being displayed, the setting is not stored and the old data remains.

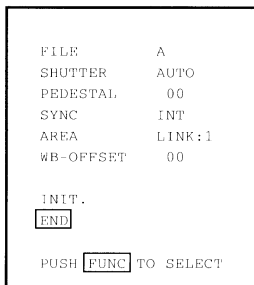

# 8 EXTERNAL SYNC

When using the camera with external sync, connect a composite video signal (C-VIDEO) to the EXT SYNC terminal on back of the camera control unit. When the camera accepts external sync, it is automatically switched from the internal sync to the external sync.

## (1) External sync signal input conditions

C-VIDEO	:	SYNC section	$0.3 \pm 0.1V$
(75Ω unbalanced)		BURST section	$0.3 \pm 0.1V$

## (2) External sync frequency range

Within  $\pm 50$  ppm in reference to NTSC standard frequency  
(H frequency 15733.5 Hz to 15735.0 Hz)

## (3) Using the camera with external sync signal

When using more than two cameras in external synchronization, this adjustment allows matching of color tone between two cameras. Adjust H (horizontal) phase and SC (sub carrier) phase if necessary.

### (3.1) H (horizontal) phase adjustment

Observe the external sync signal and video output signal on the camera with a dual trace oscilloscope, and adjust "H-PHS" of "SYNC" on the screen menu so that the H phase matches.

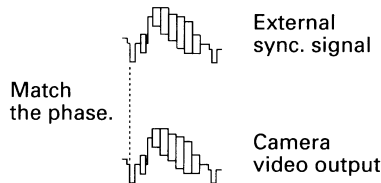

### (3.2) SC (sub carrier) phase adjustment

Perform a coarse adjustment for 0, 90, 180, or 270 degrees in "SC-PHS" on the screen menu and then perform a fine adjustment with "SC-FINE". Using a vector scope for the phase adjustment will provide more accuracy.

## 9. CAUTIONS ON USE AND INSTALLATION

- **Carefully handle the units.**

Do not drop or give a strong shock or vibration to the camera. This may cause problems. Treat the camera cables carefully to prevent cable problems such as cable breakdown and loosened connections.

- **Do not shoot intense light.**

If there is an intense light at a location on the screen such as a spot light, blooming and smearing may occur.

Do not aim the camera at the sun. If an intense light enters, vertical stripes may appear on the screen.

- **Lens treatment.**

Do not look at the sun through the lens.

- **Handling of the camera head and protection cover.**

Keep the camera head and the protection cover away from children. Children may put them into mouth or swallow them accidentally. The protection cover protects the image sensing plane when the lens is removed from the camera head, do not throw away.

- **Do not touch internal parts.**

Tampering with the internal parts may cause operation failure or injury.

- **Operating ambient temperature and humidity.**

Do not use the camera in places where temperature and humidity exceed the specifications. Picture quality will degrade and internal parts may be damaged.

- **Do not splash water.**

Install the camera in a location free from water splash. If splashed, turn off the camera power switch and stop supplying power, then consult with your dealer.

- **Install the camera in a location free from noise.**

If the camera or the cables are located near power utility lines or a TV, etc. undesirable noise may appear on the screen. In such a case, try to change the location of the camera or the cable wiring.

- **When not using the camera for a long-time.**

Turn off the camera power switch and stop supplying power.

- **Should you notice any trouble.**

If an abnormality occurs such as no picture obtained, turn the camera power switch off and stop supplying power, then consult with the dealer. Using the camera without checking the cause of the trouble may lead to further damage or unexpected accident.

- **When cleaning the camera**

Always turn off the power and make a cleaning with a piece of dry cloth. If necessary, gently wipe with a cloth dampened with thinned detergent. Do not use benzine, alcohol, thinner, etc. If used, coating and printed letters may be discolored. When cleaning the lens, use a lens cleaning paper, etc.

## 10. BEFORE MAKING A SERVICE CALL

Symptom	Items to be checked
No picture	<ul style="list-style-type: none"> <li>• Is the power supplied correctly?</li> <li>• Is the lens iris adjusted correctly?</li> <li>• Are the cables connected correctly?</li> </ul>
Poor color	<ul style="list-style-type: none"> <li>• Is the monitor (TV) adjusted correctly?</li> <li>• Is the white balance of the camera adjusted correctly? (in modes other than automatic trace)</li> <li>• Is the illumination dark?</li> <li>• Is the SC phase adjusted correctly? (External sync)</li> </ul>
"HEAD UNCONNECTED" or "CABLE DETECT ERR" is displayed on the screen	<ul style="list-style-type: none"> <li>• Turn the power of the camera off, make proper connection for the camera head, camera cable, and camera control unit, and then turn the power on again. (Improper connection may cause the trouble.)</li> </ul>

# 11. OPTIONAL PARTS

For further details, call the dealers.

## Camera head

Type name	
IK-SM43H	7mm Camera head
IK-C43H	C mount head
IK-M43H	17mm Camera head



## LIMITED WARRANTY

Toshiba America Information Systems, Inc. ("TAIS"), makes the following limited warranties. These limited warranties extend to the original enduser/purchaser.

### Limited One (1) Year Warranty of Labor and Parts

TAIS warrants this product and its parts against defects in materials or workmanship for a period of one year after the date of original retail purchase.

During this period, TAIS will repair a defective product or part, without charge to you. You must deliver the entire product to a TAIS Service Center.

You pay for all transportation and insurance charges for the product to the Service Center.

### Instruction Manual (Owner's Manual)

You should read the instruction manual (owner's manual) thoroughly before operating this product.

### Your Responsibility

The above warranties are subject to the following conditions:

1. You must retain your bill of sale or provide other proof of purchase.
2. You must notify TAIS Service within thirty (30) days after you discover a defective product or part.
3. All warranty servicing of this product must be made by TAIS Service Center.
4. These warranties are effective only if the product is purchased and operated in the U.S.A.
5. Labor service charges for installation and adjustment of customer controls are not covered by this warranty.
6. Warranties extend only to defects in materials or workmanship as limited above and do not extend to any product or parts which have been lost or discarded by you or to damage to products or parts caused by misuse, accident, improper installation, improper maintenance or use in violation of instructions furnished by us; or to units which have been altered or modified without authorization of TAIS or to damage to products or parts thereof which have had the serial number removed, altered, defaced or rendered illegible.

### Step-By-Step Procedures – How to Obtain Warranty Service

To obtain warranty servicing, you should:

1. Contact TAIS Service Center listed below for warranty service within thirty (30) days after you find a defective product or part.
2. Arrange for the delivery of the product to TAIS Service Center. Products shipped to the Service Center must be insured and safely and securely packed, preferably in the original shipping carton, and a letter explaining the defect and also a copy of the bill of sale or other proof of purchase must be enclosed. All transportation and insurance charges must be prepaid by you.
3. If you have any questions about service, please contact the following TAIS Service Center:

9740 Irvine Blvd. Irvine, CA 92713-9724

Phone Number: (714) 583-3000

**ALL WARRANTIES IMPLIED BY STATE LAW, INCLUDING THE IMPLIED WARRANTIES OF MERCHANTABILITY AND FITNESS FOR A PARTICULAR PURPOSE, ARE EXPRESSLY LIMITED TO THE DURATION OF THE LIMITED WARRANTIES SET FORTH ABOVE.** Some states do not allow limitations on how long an implied warranty lasts, so the above limitation may not apply to you. **WITH THE EXCEPTION OF ANY WARRANTIES IMPLIED BY STATE LAW AS HEREBY LIMITED, THE FOREGOING EXPRESS WARRANTY IS EXCLUSIVE AND IN LIEU OF ALL OTHER WARRANTIES, GUARANTEES, AGREEMENTS AND SIMILAR OBLIGATIONS OF MANUFACTURER OR SELLER WITH RESPECT TO THE REPAIR OR REPLACEMENT OF ANY PRODUCT OR PARTS.**

**IN NO EVENT SHALL TAIS BE LIABLE FOR CONSEQUENTIAL OR INCIDENTAL DAMAGES.** Some states do not allow the exclusion or limitation of incidental or consequential damages so the above limitation may not apply to you.

No person, agent, distributor, dealer, service station or company is authorized to change, modify or extend the terms of these warranties in any manner whatsoever. The time within which an action must be commenced to enforce any obligation of TAIS arising under this warranty or under any statute, or law of the United States or any state thereof, is hereby limited to one year from the date you discover or should have discovered, the defect. This limitation does not apply to implied warranties arising under state law. Some states do not permit limitation of the time within which you may bring an action beyond the limits provided by state law so the above provision may not apply to you. This warranty gives you specific legal rights and you may also have other rights which vary from state to state.

**TOSHIBA AMERICA INFORMATION SYSTEMS, INC.**

Printed in Japan 70971703

**TOSHIBA**

## Free Manuals Download Website

<http://myh66.com>

<http://usermanuals.us>

<http://www.somanuals.com>

<http://www.4manuals.cc>

<http://www.manual-lib.com>

<http://www.404manual.com>

<http://www.luxmanual.com>

<http://aubethermostatmanual.com>

Golf course search by state

<http://golfingnear.com>

Email search by domain

<http://emailbydomain.com>

Auto manuals search

<http://auto.somanuals.com>

TV manuals search

<http://tv.somanuals.com>