

TOSHIBA



DVD VIDEO PLAYER & VIDEO CASSETTE RECORDER

SD-V594SC

OWNER'S MANUAL

VHS Hi-Fi SQPB

Introduction 2

Connections 16

Basic setup (VCR) 27

Playback (VCR) 34

Recording (VCR) 39

Other functions (VCR) 44

Basic playback (DVD) 47

Advanced playback (DVD) 50

Function setup (DVD) 63

Others 71



©2006 Toshiba Corporation

This device does not tape-record copy protected DVD Video Discs.

SAFETY PRECAUTIONS

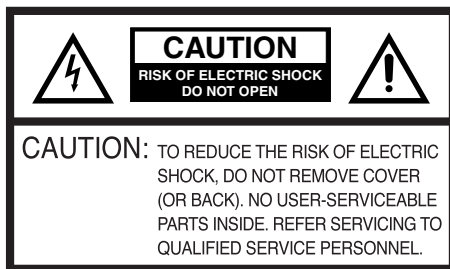

The lightning flash with arrowhead symbol, within an equilateral triangle is intended to alert the user to the presence of uninsulated dangerous voltage within the product's enclosure that may be of sufficient magnitude to constitute a risk of electric shock to persons.



The exclamation point within an equilateral triangle is intended to alert the user to the presence of important operating and maintenance (servicing) instructions in the literature accompanying the appliance.

WARNING: TO REDUCE THE RISK OF FIRE OR ELECTRIC SHOCK, do not expose this appliance to rain or moisture.

CAUTION: TO PREVENT ELECTRIC SHOCK DO NOT USE THIS POLARIZED PLUG WITH AN EXTENSION CORD, RECEPTACLE OR OTHER OUTLET UNLESS THE BLADES CAN BE FULLY INSERTED TO PREVENT BLADE EXPOSURE.

ATTENTION: POUR EVITER LES CHOCS ELECTRIQUES, INTRODUIRE LA LAME LA PLUS LARGE DE LA FICHE DANS LA BORNE CORRESPONDANTE DE LA PRISE ET POUSSER JUSQU'AU FOND.

FCC NOTICE: This equipment has been tested and found to comply with the limits for a Class B digital device, pursuant to Part 15 of the FCC Rules. These limits are designed to provide reasonable protection against harmful interference in a residential installation. This equipment generates, uses and can radiate radio frequency energy and, if not installed and used in accordance with the instructions, may cause harmful interference to radio communications.

However, there is no guarantee that interference will not occur in a particular installation. If this equipment does cause harmful interference to radio or television reception, which can be determined by turning the equipment off and on, the user is encouraged to try to correct the interference by one or more of the following measures:

- Reorient or relocate the receiving antenna.
- Increase the separation between the equipment and receiver.
- Connect the equipment into an outlet on a circuit different from that to which the receiver is connected.
- Consult the dealer or an experienced radio/TV technician for help.

CAUTION: Changes or modifications not expressly approved by the party responsible for compliance with the FCC Rules could void the user's authority to operate this equipment.

CAUTION: THIS DIGITAL VIDEO PLAYER EMPLOYS A LASER SYSTEM.

TO ENSURE PROPER USE OF THIS PRODUCT, PLEASE READ THIS USER'S GUIDE CAREFULLY AND RETAIN FOR FUTURE REFERENCE. SHOULD THE UNIT REQUIRE MAINTENANCE, CONTACT AN AUTHORIZED SERVICE LOCATION.

USE OF CONTROLS, ADJUSTMENTS OR THE PERFORMANCE OF PROCEDURES OTHER THAN THOSE SPECIFIED HEREIN MAY RESULT IN HAZARDOUS RADIATION EXPOSURE.

TO PREVENT DIRECT EXPOSURE TO LASER BEAM, DO NOT TRY TO OPEN THE ENCLOSURE. VISIBLE LASER RADIATION MAY BE PRESENT WHEN THE ENCLOSURE IS OPENED. DO NOT STARE INTO BEAM.

Location of the required Marking

The rating sheet and the safety caution are on the rear of the unit.

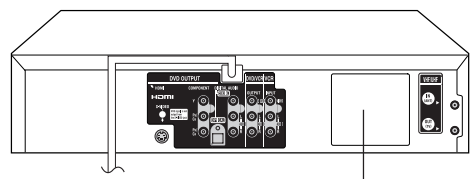

CERTIFICATION: COMPLIES WITH FDA RADIATION PERFORMANCE STANDARDS, 21 CFR SUBCHAPTER J.



IMPORTANT SAFEGUARDS

1. READ INSTRUCTIONS

All the safety and operating instructions should be read before the unit is operated.

2. RETAIN INSTRUCTIONS

The safety and operating instructions should be retained for future reference.

3. HEED WARNINGS

All warnings on the unit and in the operating instructions should be adhered to.

4. FOLLOW INSTRUCTIONS

All operating and use instructions should be followed.

5. CLEANING

Unplug this unit from the wall outlet before cleaning. Do not use liquid cleaners or aerosol cleaners.

Use a soft dry cloth for cleaning the exterior cabinet only.

6. ATTACHMENTS

The manufacturer of this unit does not make any recommendations for attachments, as they may cause hazards.

7. WATER AND MOISTURE

Do not use this unit near water. For example, near a bathtub, washbowl, kitchen sink, laundry tub, in a wet basement, or near a swimming pool.

8. ACCESSORIES

Do not place this unit on an unstable cart, stand, tripod, bracket, or table.

The unit may fall, causing serious injury, and serious damage to the unit.

- 8A. An appliance and cart combination should be moved with care. Quick stops, excessive force, and uneven surfaces may cause the appliance and cart combination to overturn.

9. VENTILATION

Slots and openings in the cabinet back or bottom are provided for ventilation, to ensure reliable operation of the unit, and to protect it from overheating.

These openings must not be blocked or covered. The openings should never be blocked by placing the unit on a bed, sofa, rug, or other similar surface. This unit should never be placed near or over a radiator or heat source. This unit should not be placed in a built-in installation such as a bookcase or rack unless proper ventilation is provided and/or the manufacturer's instructions have been adhered to.

10. POWER SOURCE

This unit should be operated only from the type of power source indicated on the rating plate. If you are not sure of the type of power supply to your home, consult your appliance dealer or local power company.

11. GROUNDING OR POLARIZATION

This unit is equipped with a polarized alternating-current line plug (a plug having one blade wider than the other). This plug will fit into the power outlet only one way. This is a safety feature. If you are unable to insert the plug fully into the outlet, try reversing the plug. If the plug should still fail to fit, contact your electrician to replace your obsolete outlet. Do not defeat the safety purpose of the grounding-type plug.

12. POWER-CORD PROTECTION

Power-supply cords should be routed so that they are not likely to be walked on or pinched by items placed upon or against them, paying particular attention to cords at plugs, convenience receptacles, and the point where they exit from the appliance.

PORTABLE CART WARNING
(symbol provided by RETAC)



S3125A

IMPORTANT SAFEGUARDS

13. LIGHTNING

To protect your unit from a lightning storm, or when it is left unattended and unused for long periods of time, unplug it from the wall outlet and disconnect the antenna or cable system. This will prevent damage to the unit due to lightning and power line surges.

14. POWER LINES

An outside antenna system should not be located in the vicinity of overhead power lines or other electric light or power circuits, or where it can fall onto or against such power lines or circuits. When installing an outside antenna system, extreme care should be taken to keep from touching such power lines or circuits, as contact with them might be fatal.

15. OVERLOADING

Do not overload wall outlets and extension cords, as this can result in a risk of fire or electric shock.

16. OBJECT AND LIQUID ENTRY

Do not push objects through any openings in this unit, as they may touch dangerous voltage points or short out parts that could result in fire or electric shock. Never spill or spray any type of liquid into the unit.

17. OUTDOOR ANTENNA GROUNDING

If an outside antenna or cable system is connected to the unit, be sure the antenna or cable system is grounded to provide some protection against voltage surges and built-up static charges, Section 810 of the National Electrical Code, ANSI/NFPA 70, provides information with respect to proper grounding of the mast and supporting structure, grounding of the lead-in wire to an antenna discharge unit, size of grounding conductors, location of antenna discharge unit, connection to grounding electrodes, and requirements for the grounding electrode.

EXAMPLE OF ANTENNA GROUNDING AS PER THE NATIONAL ELECTRICAL CODE

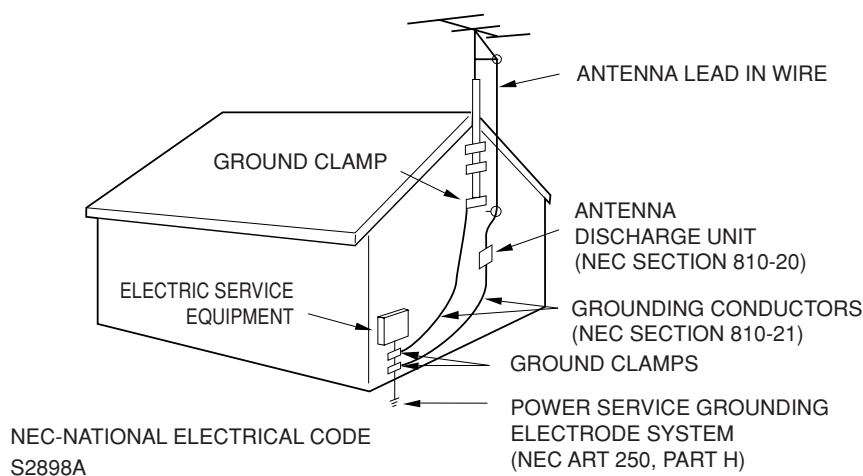

18. SERVICING

Do not attempt to service this unit yourself as opening or removing covers may expose you to dangerous voltage or other hazards. Refer all servicing to qualified service personnel.

For example:

- a. When the power-supply cord or plug is damaged.
- b. If liquid has been spilled, or objects have fallen into the unit.
- c. If the unit has been exposed to rain or water.
- d. If the unit does not operate normally by following the operating instructions. Adjust only those controls that are covered by the operating instructions, as an improper adjustment of other controls may result in damage and will often require extensive work by a qualified technician to restore the unit to its normal operation.
- e. If the unit has been dropped or the cabinet has been damaged.
- f. When the unit exhibits a distinct change in performance, this indicates a need for service.

IMPORTANT SAFEGUARDS / Power source

19. REPLACEMENT PARTS

When replacement parts are required, be sure the service technician uses replacement parts specified by the manufacturer or those that have the same characteristics as the original part.

Unauthorized substitutions may result in fire, electric shock or other hazards.

20. SAFETY CHECK

Upon completion of any service or repairs to this unit, ask the service technician to perform safety checks to determine that the unit is in proper operating condition.

21. HEAT

The product should be situated away from heat sources such as radiators, heat registers, stoves, or other products (including amplifiers) that produce heat.

22. DISC TRAY

Keep your fingers well clear of the disc tray as it is closing. It may cause serious personal injury.

23. CONNECTING

When you connect the product to other equipment, turn off the power and unplug all of the equipment from the wall outlet. Failure to do so may cause a product damage. Read the owner's manual of the other equipment carefully and follow the instructions when making any connections.

24. LASER BEAM

Do not look into the opening of the disc tray or ventilation opening of the product to see the source of the laser beam. It may cause sight damage.

25. DISC

Do not use a cracked, deformed, or repaired disc. These discs are easily broken and may cause serious personal injury and product malfunction.

26. NOTE TO CABLE TV SYSTEM INSTALLER

This reminder is provided to call the Cable TV system installer's attention to Article 820-40 of the NEC that provides guidelines for proper grounding and, in particular, specifies that the cable ground shall be connected to the grounding system of the building, as close to the point of cable entry as practical.

Power source

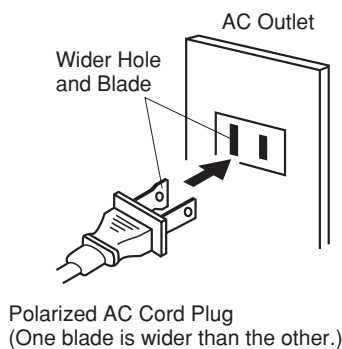

TO USE AC POWER SOURCE

Use the AC polarized line cord provided for operation on AC. Insert the AC cord plug into a standard 120V 60Hz polarized AC outlet.

Notes:

- Never connect the AC line cord plug to other than the specified voltage (120V 60Hz). Use the attached power cord only.
- If the polarized AC cord does not fit into a non-polarized AC outlet, do not attempt to file or cut the blade. It is the user's responsibility to have an electrician replace the obsolete outlet.
- If you cause a static discharge when touching the unit and the unit fails to function, simply unplug the unit from the AC outlet and plug it back in. The unit should return to normal operation.

Precautions

Notes on handling

- When shipping the DVD/VCR, the original shipping carton and packing materials come in handy. For maximum protection, repack the unit as it was originally packed at the factory.
- Do not use volatile liquids, such as insect spray, near the DVD/VCR. Do not leave rubber or plastic products to contact the DVD/VCR for a prolonged period. They will leave marks on the finish.
- The top and rear panels of the DVD/VCR may become warm after a long period of use. This is not a malfunction.
- When the DVD/VCR is not in use, be sure to remove the disc and the video cassette turn off the power.
- If you do not use the DVD/VCR for a long period, the unit may not function properly in the future. Turn on and use the DVD/VCR occasionally.

Notes on locating

- Place the DVD/VCR on a level surface. Do not use it on a shaky or unstable surface such as a wobbling table or inclined stand. The loaded disc or the video tape may become dis-aligned and damage the DVD/VCR.
- When you place this DVD/VCR near a TV, radio, or VCR, the playback picture may become poor and the sound may be distorted. In this case, place the DVD/VCR away from the TV, radio or VCR.

Notes on cleaning

Use a soft, dry cloth for cleaning.

- Use a dry cloth to wipe.
Do not use any type of solvent, such as thinner and benzene, as they may damage the surface of the DVD/VCR.
- If you use a chemical saturated cloth to clean the unit, follow that product's instructions.

Note on moisture condensation

Moisture condensation damages the DVD/VCR. Please read the following carefully.

Moisture condensation occurs, for example, when you pour a cold drink into a glass on a warm day. Drops of water form on the outside of the glass. In the same way, moisture may condense on the head drum or the optical pick-up lens inside this unit, one of the most crucial internal parts of the DVD/VCR.

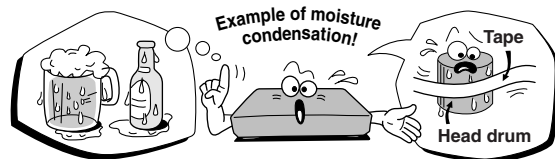

■ **Moisture condensation occurs during the following cases.**

- When you bring the DVD/VCR directly from a cold place to a warm place.
- When you use the DVD/VCR in a room where you just turned on the heater, or a place where the cold wind from the air conditioner directly hits the unit.
- In summer, when you use the DVD/VCR in a hot and humid place just after you move the unit from an air conditioned room.
- When you use the DVD/VCR in a humid place.

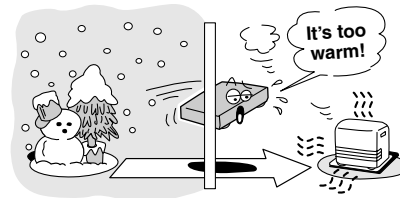

■ **Do not use the DVD/VCR when moisture condensation may occur.**

If you use the DVD/VCR in such a situation, it may damage discs and internal parts. Remove the disc or the video tape, connect the power cord of the DVD/VCR to the wall outlet, turn on the DVD/VCR, and leave it for two or three hours. After two or three hours, the DVD/VCR will have warmed up and evaporated any moisture. Keep the DVD/VCR connected to the wall outlet and moisture condensation will seldom occur.

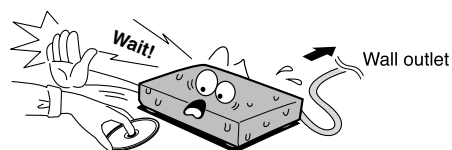



Notes and Informations

On handling discs

- Do not touch the playback side of the disc.



- Do not attach paper or tape to discs.



On cleaning discs

- Fingerprints and dust on the disc cause picture and sound deterioration. Wipe the disc from the center outwards with a soft cloth. Always keep the disc clean.



- Do not use any type of solvent such as thinner, benzene, commercially available cleaners or antistatic spray for vinyl LPs. It may damage the disc.

On storing discs

- Do not store discs in a place subject to direct sunlight or near heat sources.
- Do not store discs in places subject to moisture and dust such as a bathroom or near a humidifier.
- Store discs vertically in a case. Stacking or placing objects on discs outside of their case may cause warping.

Structure of disc contents

Normally, DVD video discs are divided into titles, and the titles are sub-divided into chapters. VIDEO CDs and audio CDs are divided into tracks.

DVD video disc

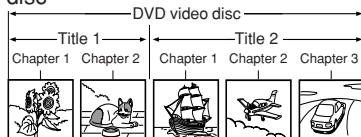

Video CD/Audio CD



Each title, chapter or track is assigned a number, which is called "title number", "chapter number" or "track number" respectively. There may be discs that do not have these numbers.

Playable discs

This DVD/VCR can play the following discs.

	Disc Mark	Contents	Disc Size	Maximum playback time
DVD video discs		Audio + Video (moving pictures)	12 cm	Approx. 4 hours (single sided disc)
				Approx. 8 hours (double sided disc)
			8 cm	Approx. 80 minutes (single sided disc)
				Approx. 160 minutes (double sided disc)
Video CDs		Audio + Video (moving pictures)	12 cm	Approx. 74 minutes (single sided disc)
			8 cm	Approx. 20 minutes (single sided disc)
Audio CDs		Audio	12 cm	Approx. 74 minutes (single sided disc)
			8 cm	Approx. 20 minutes (single sided disc)

The following discs are also available.

- DVD-R/RW discs of DVD video format
 - CD-R/CD-RW discs of CD-DA, Video CD, SVCD, MP3, WMA, JPEG or DivX® format
 - Kodak picture CD, FUJICOLOR CD format
- Some of these discs may be incompatible.

- You cannot play discs other than those listed above.
- You cannot play discs of DVD-RAM, DVD-ROM, Photo CD, etc., or non standardized discs even if they may be labeled as above.
- Some CD-R/RWs cannot be played back depending on the recording conditions.
- This DVD/VCR uses the NTSC color system, and cannot play DVD video discs recorded in any other color system (PAL, SECAM, etc.).



Because of problems and errors that can occur during the creation of DVD and CD Software and/or the manufacture of DVD and CD discs, Toshiba cannot assure that the DVD player will successfully play every disc bearing DVD and CD logos. If you happen to experience any difficulty playing a DVD and/or CD disc on this DVD player, please contact Toshiba Customer Service.

is a trademark of DVD Format/Logo Licensing Corporation.



Notes and Informations (Continued)

Notes on region numbers

The region number of this DVD/VCR is 1. If region numbers, which stand for their playable area, are printed on your DVD video disc and you do not find  or , disc playback will not be allowed by the player. (In this case, the DVD/VCR will display a message on-screen.)

On Video CDs

This DVD/VCR supports Video CDs equipped with the PBC (Version 2.0) function. (PBC is the abbreviation of Playback Control.) You can enjoy two playback variations depending on types of discs.

- **Video CD not equipped with PBC function (Version 1.1)**

Sound and movie can be played on this DVD/VCR in the same way as an audio CD.

- **Video CD equipped with PBC function (Version 2.0)**

In addition to operation of a Video CD not equipped with the PBC function, you can enjoy playback of interactive software with search function by using the menu displayed on the TV screen (Menu Playback). Some of the functions described in this owner's manual may not work with some discs.

Playable USB Mass Storages

This unit is compatible with USB memory devices that accept Mass Storage Class (referred to as USB Mass Storage in this owner's manual). Please note that this does not guarantee that the unit is compatible with any kind of USB Mass Storage.

This unit can be used to read JPEG, WMA, MP3 and DivX® data for the equipment shown in the table below. However, please note that it is not possible to guarantee that all functions are available and some functions may not work properly for some equipment. This unit cannot playback the DivX® VOD content protected by DRM (Digital Rights Management) system on the USB Mass Storage.

This unit is compatible with Nikon COOLPIX P2 and FUJIFILM FinePix A345 digital cameras. However, successful connection depends on the version of the software installed in the camera and the memory capacity and connection status.

This unit cannot be used to read data from equipment not listed below.

Please refer to "Connecting to a USB Mass Storage"  for details of how to connect a USB Mass Storage and the necessary precautions when using the unit.

Equipment	Brand	Models
Memory Card Reader	San Disk	SDDR-89
	ZIO	CM-28100
	GE	HO97949
Digital Camera	Nikon	COOLPIX P2
	FUJIFILM	FinePix A345
USB Memory	Lexar	JDA1GB-275
	San Disk	SDCZ2-512-A10
	PNY	PFD01GU20RF
MP3 Player	SAMSUNG	YP-T7Z
	Sony	NW-E507
	RCA	RD2780

About this owner's manual

This owner's manual explains the basic instructions of this DVD/VCR. Some DVD video discs are produced in a manner that allows specific or limited operation during playback. As such, the DVD/VCR may not respond to all operating commands. This is not a defect in the DVD/VCR. Refer to instruction notes of discs.

The following symbol may appear on the TV screen during operation.

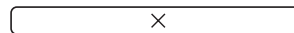

It means that the operation is not permitted by the DVD/VCR or the disc.

For example, sometimes it is unable to stop the playback of copyright message of the disc when the STOP (■) button is pressed. Alternatively, this symbol may also indicate that the feature is not available for the disc.

Notes on copyright

The unauthorized recording, use, distribution, or revision of copyrighted materials including, without limitation, television programs, videotapes, and DVDs is prohibited under the Copyright Laws of the United States and other countries, and may subject you to civil and criminal liability.

This product incorporates copyright protection technology that is protected by U.S. patents and other intellectual property rights. Use of this copyright protection technology must be authorized by Macrovision, and is intended for home and other limited viewing uses only unless otherwise authorized by Macrovision. Reverse engineering or disassembly is prohibited.

Consumers should note that not all high definition television sets are fully compatible with this product and may cause artifacts to be displayed in the picture. In case of 525 progressive scan picture problems, it is recommended that the user switch the connection to the "STANDARD DEFINITION" output. If there are questions regarding our TV set compatibility with this model 525p DVD player, please contact our customer service center.



Contents

Introduction

SAFETY PRECAUTIONS	2
IMPORTANT SAFEGUARDS	3
Power source	5
Precautions	6
Notes and Informations	7
Contents	9
Identification of controls	10
Multi brand remote control	14

Connections

Antenna connections	16
Cable TV connections	18
Connecting to a TV	20
Connecting to an audio equipment	24
Connecting to a USB Mass Storage	26

Basic setup (VCR)

Setting the video channel	27
Setting the language	28
Clock setting	29
Tuner setting	32

Playback (VCR)

Loading and unloading a cassette tape	34
Cassette tape playback	35
Special playback	36
Convenience function	37

Recording (VCR)

Recording a TV program	39
One-touch Timer Recording (OTR)	41
Timer recording	42

Other functions (VCR)

Stereo recording and playback	44
Second Audio Program (SAP)	44
Duplicating a video tape	45
Recording a DVD/CD disc	46

Basic playback (DVD)

Playing a disc	47
----------------------	----

Advanced playback (DVD)

Zooming	50
Locating desired scene	50
Marking desired scenes	51
Repeat playback	52
A-B Repeat playback	52
Program playback	53
Random playback	53
Changing angles	54
Title selection	54
DVD menu	54
Changing soundtrack language	55
Setting surround sound	55
Subtitles	56
To turn off the PBC	56
MP3/WMA/JPEG/DivX® and Audio CD operation	57

Function setup (DVD)

Customizing the function settings	63
Temporary disabling of rating level by DVD disc	70

Others

Language code list	71
Troubleshooting	72
Specifications	73
Canadian warranty information	74

Introduction

Identification of controls

See the page in  for details.

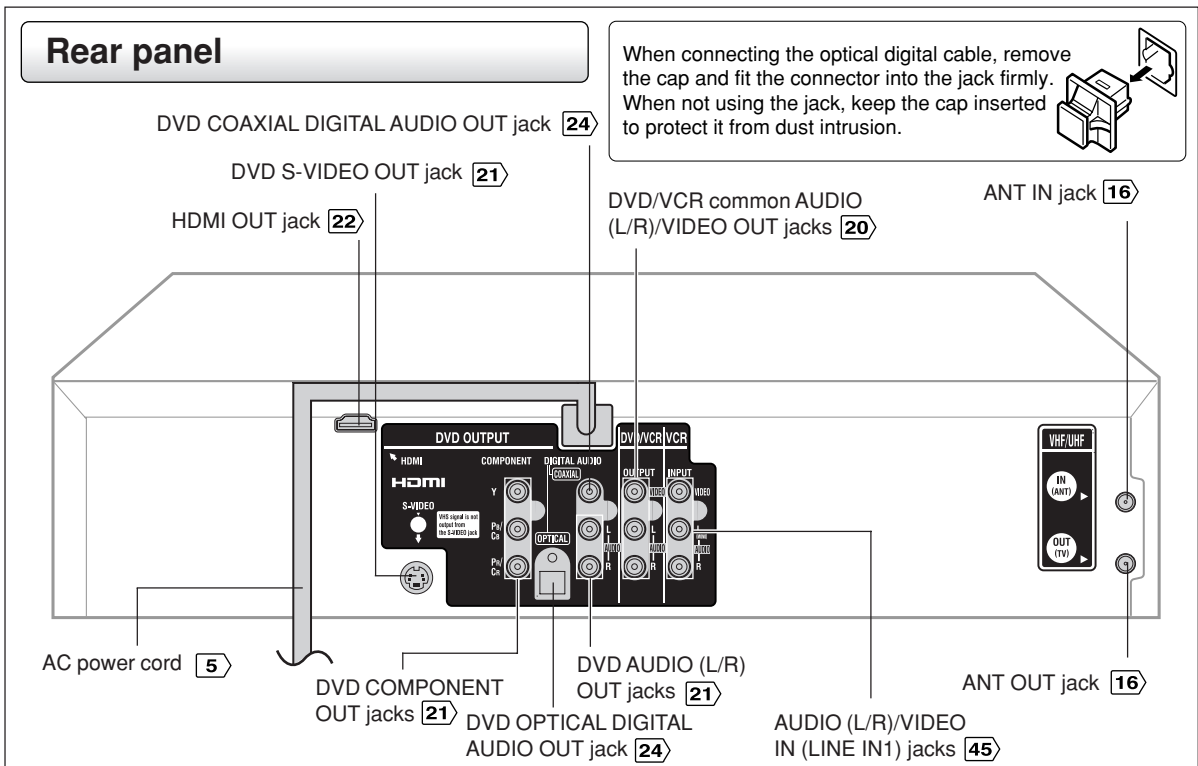
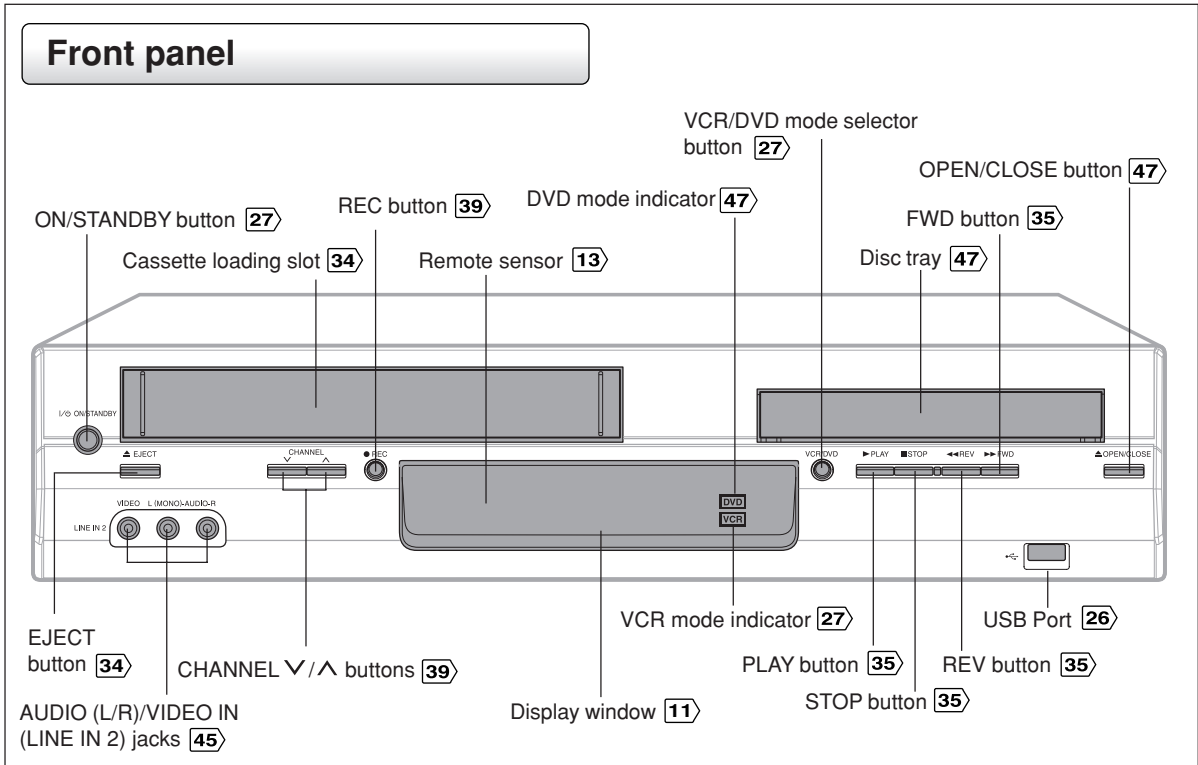



Display window

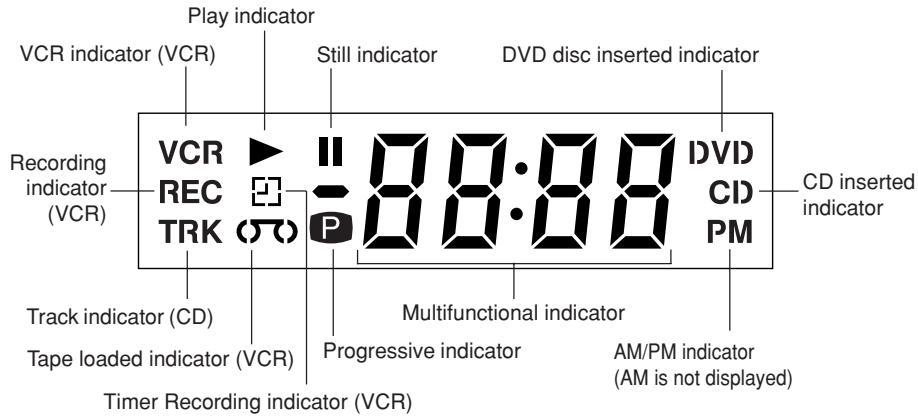

VCR operation status

Press **CALL** to display VCR operation status on the screen.
To cancel the display, press **CALL** again.

While watching TV

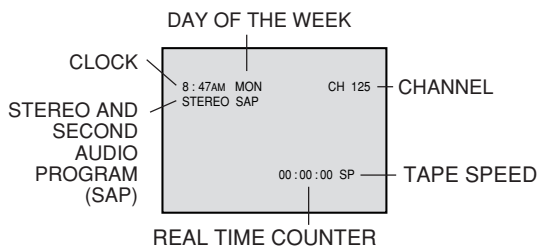

While operating a tape

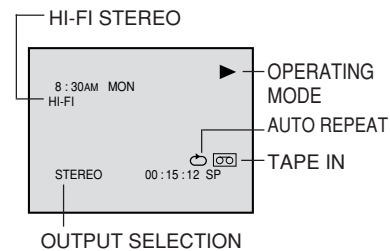

VCR Icons

- Recording : ●
- Rec/Pause : ●||
- Play : ►
- Stop : ■
- Eject : ▲

Disc operation status

Press **DISPLAY**, the status display of the disc will appear on the screen as follows.
To cancel the display, press **DISPLAY** again.

DVD

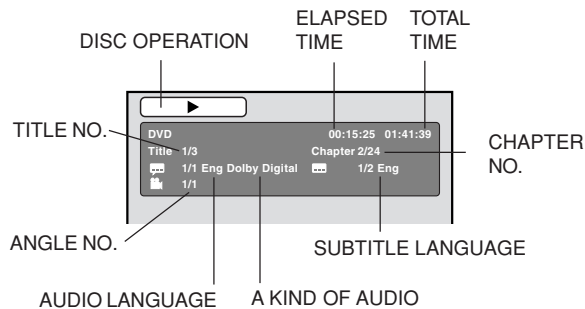

VCD

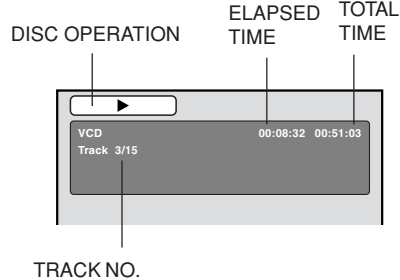

Identification of controls (Continued)

The instructions in this manual describe the functions on the remote control. See the page in for details.

Remote control

DVD/VCR button **13**

* TV button **14**

CALL button **11**

* DISPLAY button **11**

* CH ^/∨ button **14**

ZERO RETURN button **37**

JUMP button **50**

CM SKIP button **36**

ZOOM button **50**

TOP MENU button **54** **59**

Direction buttons (▲/▼/◀/▶) **13**

SET+/- buttons **28**

CH+/- buttons **13**

CANCEL button **31**

CLEAR button **50**

PLAY button **35** **47**

PAUSE/STILL button **36** **48**

REV button **35** **49**

SKIP ◀◀ button **49**

VISS - button **38**

VCR MENU button **28**

SETUP button **63**

MARKER button **51**

COUNTER RESET button **37**

ANGLE button **54** **59**

ATR button **36**

SUBTITLE button **56**

SP/SLP button **39**

PLAYMODE button **52**

DVD/USB button **58**

A-B RPT button **52**

EJECT button (VCR) **34**

OPEN/CLOSE (DVD) **47**

* POWER button **13**

* CABLE BOX button **15**

* Direct channel selection buttons (0-9) **13**

Number buttons (0-9) **14**

* 100 button **14**

* VOL +/- buttons **14**

* INPUT SELECT button **14**

PROGRAM button **14**

DVD MENU button **54** **59**

* ENTER button **28** **63**

RETURN button **63** **70**

STOP button **35** **47**

FWD button **35** **49**

SKIP ▶▶ button **49**

VISS + button **38**

SLOW button **36** **49**

CLOCK/COUNTER button **38**

HDMI button **22**

AUDIO SELECT button **44**

AUDIO button **55**

DVD/VCR SELECT button **27** **47**

TV/VCR button **27**

REC/OTR button **39** **41**

TIMER REC button **42**

DVD MENU button
Use the MENU button to display the menu included on many DVD video discs. To operate a menu, follow the instructions in "DVD Menu." **54**

***TV control buttons**
The various brands of TV listed on page 14 can be operated with this remote control. There may be some TV models that cannot be operated with this remote control. If this is the case, use the original remote control supplied with the TV.

***CABLE BOX control buttons**
The various brands of CABLE BOX listed on page 15 can be operated with this remote control. There may be some CABLE BOX models that cannot be operated with this remote control. If this is the case, use the original remote control supplied with the CABLE BOX.

Inserting batteries

- 1** Open the battery compartment cover in the direction of the arrow.

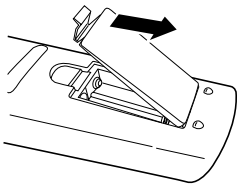

- 2** Install two “AAA” batteries (supplied), paying attention to the polarity diagram in the battery compartment.

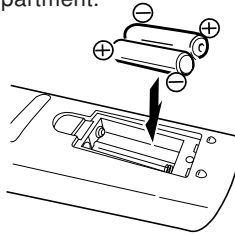

- 3** Replace the compartment cover.

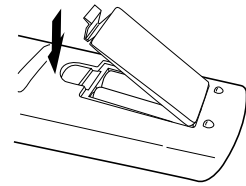

Caution:

Never throw batteries into a fire.

Notes:

- Be sure to use AAA size batteries.
- Dispose of batteries in a designated disposal area.
- Batteries should always be disposed of with the environment in mind. Always dispose of batteries in accordance with applicable laws and regulations.
- If the remote control does not operate correctly, or if the operating range becomes reduced, replace batteries with new ones.
- When necessary to replace batteries in the remote control, always replace both batteries with new ones. Never mix battery types or use new and used batteries in combination.
- Always remove batteries from remote control if they are dead or if the remote control is not to be used for an extended period of time. This will prevent battery acid from leaking into the battery compartment.

Remote control basics

- Press **DVD/VCR** to operate the DVD/VCR.
- Press **POWER** to turn the DVD/VCR on or off.
- Select your desired operating mode (DVD or VCR) using **DVD/VCR SELECT**. (DVD or VCR indicator on the front panel will show you which mode is selected.)
- Press **CH +** or **CH -** to move through the channels one channel at a time.
- The **▲/▼/◀/▶** are also used to navigate on-screen menu system.
- You can directly access specific channels using **Direct channel selection buttons (0-9)**.
- Each press of **DVD/VCR SELECT** on the remote control, switches the screen between the VCR screen (VCR mode) and the DVD screen (DVD mode).

Operation

- Aim the remote control at the remote sensor and press control buttons to operate.
- Operate the remote control within 30° angle on either side of the remote sensor, up to a distance of approx. 7 meters.

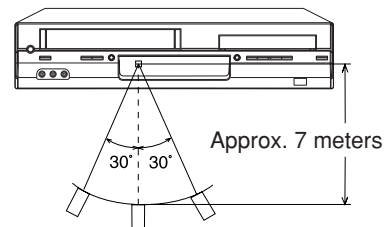

Multi brand remote control

This remote control can be compatible with various brands of TV/ Cable box/DSS® satellite receiver by setting their control codes. The TOSHIBA code has initially been set to control TOSHIBA TVs.

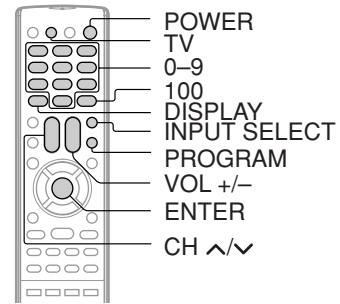

Setting TV control codes

- 1** Press TV to set the remote control operating your TV.



- 2** While holding down PROGRAM, enter the two digits of your TV's brand code (listed on the right) using Number buttons (0-9), then release PROGRAM.

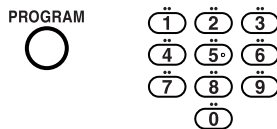

Point the remote control at your TV and use each button listed below to make sure that your TV is operated correctly.

POWER	To turn the TV on or off.
CH ^/v	To select TV channels in the upper or lower direction.
VOL +/-	To adjust the sound level.
INPUT SELECT	To select an external source such as a VCR.
Direct channel selection buttons (0-9)	To select TV channels. When selecting channels 1 to 9, first enter 0 and then desired number.
100	To substitute for 100 channel key.
DISPLAY	To turn TV's screen display on or off.
ENTER	To use for the TV's ENTER key.

Important

Some TV's may not respond to all the operations above, or may not be operated at all with this remote control. In this case, operate your TV with its own remote control.

Notes:

- For some brands, several control codes (brand codes) are allocated. Try each of them until the buttons work on your TV.
- If you replace the remote control's batteries, set the brand code again.

Table of TV brand codes

Brand name of your TV	Brand Code	Brand name of your TV	Brand Code
Toshiba	01	Penney	01, 02, 07, 11, 12
Bell & Howell	09	Philco	10
Carver	10	Philips	10
Celebrity	03	Pioneer	16
Citizen	12	Princeclub	12
Curtis Mathes	09, 12	Prism	07
Dumont	14	Proscan	02
Electro band	03	Proton	11
Emerson	09, 11	Pulser	14
Fisher	09	Quasar	07, 15
GE	02, 07, 11	Radio Shack	13
Gibraltar	14	RCA	02
Goldstar	11	Realistic	09, 11, 13
Hallmark	11	Runco(NEC)	14
Hitachi	06	Samsung	11, 12
Infinity	10	Sanyo	09
JBL	10	Scotch	11
JCB	03	Scott	11
JVC	05	Sears	01, 02, 09, 10, 11
LXI	01, 02, 09, 10, 11	Sharp	08, 13
Magnavox	10	Sony	03
Marantz	10	Soundesign	11
Megatron	06, 11	Supreme	03
Memorex	04, 09, 11	Sylvania	10
MGA	04, 11	Tandy	08
Midland	02, 07, 14	Technics	07, 15
Mitsubishi	04, 11	Techwood	07
Motorola	08	Teknika	04, 10, 12
MTC	12	TMK	11
NAD	01, 11	Victor	05
Nikko	11	Vidikron	10
Optimus	09	Vidtech	11
Optonica	08	Wards	10, 11, 13
Panasonic	07, 10, 15	Zenith	14



Setting Cable box/DSS® satellite receiver control codes

- 1** Press **CABLE BOX** to set the remote control operating your Cable box/DSS® satellite receiver.



- 2** While holding down **PROGRAM**, enter the two digits of your Cable box/DSS® satellite receiver brand code (listed on the right) using Number buttons (0–9), then release **PROGRAM**.

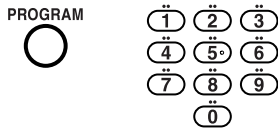

Point the remote control at your Cable box/DSS® satellite receiver and use each button listed below to make sure that your Cable box/DSS® satellite receiver is operated correctly.

POWER	To turn the Cable box/DSS® satellite receiver on or off.
CH \wedge/\vee	To select cable/satellite channels in the upper or lower direction. (Not applicable to some brands of cable box/satellite receiver.)
Number buttons (0–9)	To select desired channels to record.
ENTER	To use for the Cable box's ENTER key.

(Some cable boxes require you to use 100 button as the enter button.)

Important

Some Cable box/DSS® satellite receiver may not respond to all the operations above, or may not be operated at all with this remote control. In this case, operate them with its own remote control.

Notes:

- For some brands, several control codes (brand codes) are allocated. Try each of them until the buttons work on your Cable box/DSS® satellite receiver.
- If you replace the remote control's batteries, set the brand code again.

Table of Cable box brand codes

Brand name of your cable box	Brand Code	Brand name of your cable box	Brand Code
Toshiba	36	Philips	4, 13, 20, 21, 22, 23, 24, 25, 26, 58, 62, 84
Anvision	13, 20, 21, 22, 23, 24, 25, 26, 58, 62, 84	Pioneer	5, 6, 78
Archer	1, 20, 21, 29, 42, 44, 63, 88, 91	Pulsar	30, 42, 44, 52, 63, 88
Cablestar	13, 20, 21, 22, 23, 24, 25, 26, 58, 62, 84	Randtek	13, 20, 21, 22, 23, 24, 25, 26, 58, 62, 84
Cableview	30, 42, 44, 52, 63, 88	RCA	6, 8, 16, 17
Citizen	30, 42, 44, 52, 63, 88	Realistic	44, 88
Curtis	8, 9, 56, 61	Regal	14, 23, 41, 84
Diamond	1, 20, 21, 29, 42, 44, 63, 88, 91	Regency	26, 28
Eagle	13, 20, 21, 22, 23, 24, 25, 26, 58, 62, 84	Rembrandt	29, 32, 38, 39, 42, 44, 88
Eastern	26, 28	Samsung	4, 6, 32, 42, 78
GC Brand	30, 42, 44, 52, 63, 88	Scientific Atlanta	8, 9, 56, 61
Gemini	4, 30, 85	Sheritech	27
General Instrument	1, 2, 3, 4, 31, 34, 55, 83, 85, 91	SL Mark	4, 6, 32, 42, 78
Hamlin	14, 15, 28, 41	Sprucher	6, 8, 16, 17
Hitachi	31, 79, 80	Stargate	4, 6, 30, 32, 42, 44, 52, 63, 78, 88
Jerrold	1, 2, 3, 4, 31, 34, 55, 85, 91	Sylvania	19
Macom	31, 79, 80	Teknika	74
Magnavox	13, 20, 21, 22, 23, 24, 25, 26, 58, 62, 84	Telecaption	77
Movietime	29, 32, 38, 39, 42, 44, 88	Television	4, 6, 32, 42, 78
NSC	29, 32, 38, 39, 42, 44, 88	Texscan	18, 19
OAK	10, 11, 12, 13, 46	Tocom	1, 33, 34, 42, 48, 49, 73, 91
OAK Sigma	10, 11, 12, 13, 46	Unica	1, 20, 21, 29, 42, 44, 63, 88, 91
Panasonic	6, 8, 16, 17	Universal	29, 42, 43, 44, 52, 63, 82, 88
		Videoway	7, 23, 45, 50, 84
		Viewstar	13, 20, 21, 22, 23, 24, 25, 26, 58, 62, 84
		Warner Amex	6
		Zenith	7, 23, 45, 50, 84

Table of DSS® satellite receiver brand codes

Brand name	Brand code	Brand name	Brand code
Toshiba	99	Draker	94
RCA	98	Primestar	93
Sony	97	Hitachi	92, 89
Magnavox	95, 96	Panasonic	90

Antenna connections

If you are using an antenna system, follow these instructions. If you are a Cable TV subscriber, skip ahead to page 18 for the proper connections.

Antenna to DVD/VCR connection

The DVD/VCR must be connected "between" the antenna and the TV. First, disconnect the antenna from the TV and connect it to the DVD/VCR. Then connect the DVD/VCR to the TV. Below are 3 common methods of connecting an antenna system to a DVD/VCR. Find the type of antenna system you are using and follow the connection diagram.

1

Combination VHF/UHF Antenna with 75 ohm Coaxial Cable

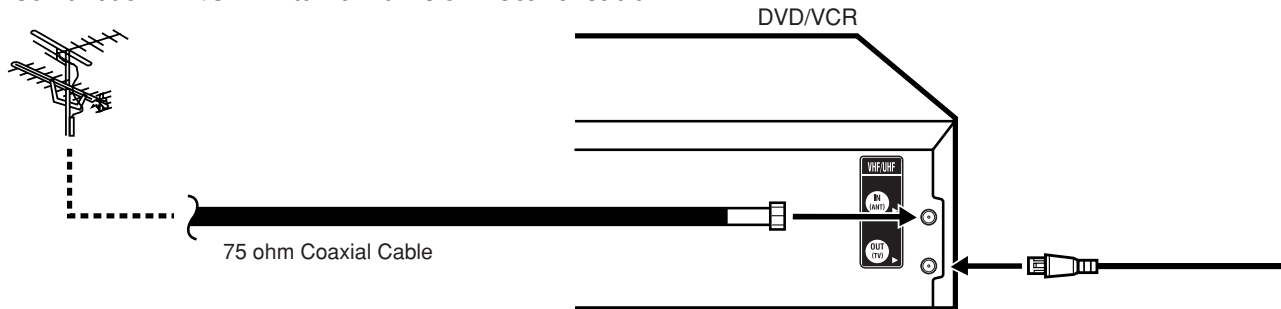

2

Combination VHF/UHF Antenna with 300 ohm Twin Lead (Flat) Wire

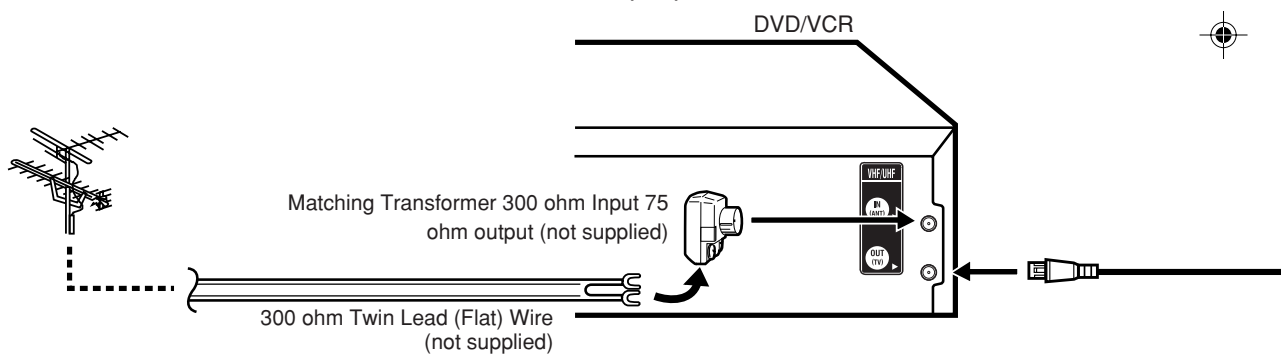

3

Separate VHF and UHF Antennas

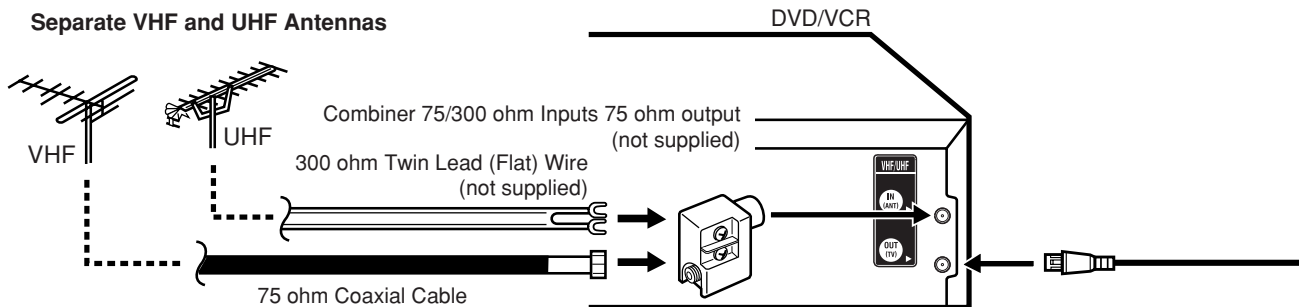

Note: If both VHF and UHF antennas have 300 ohm twin lead (flat) wires, use a combiner having two 300 ohm inputs and one 75 ohm output.

- Notes:**
- A clear picture will not be obtained by the DVD/VCR unless the antenna signal is good. Connect the antenna to the DVD/VCR properly.
 - For better quality recording, an indoor antenna or a telescopic antenna is not recommended. The use of an outdoor type antenna is required.
 - If you are not sure about the connection, please refer to qualified service personnel.



DVD/VCR to TV connection

After you have connected the antenna to the DVD/VCR, you must connect the DVD/VCR to the TV. Below are 3 common methods of connecting your DVD/VCR to a TV. Find the type of TV you are using and follow the connection diagram.

This DVD/VCR has a single 75 ohm output for connection to a TV. If your TV has separate VHF and UHF antenna inputs (numbers 2 and 3 below), use a splitter to connect the DVD/VCR to the TV for VHF and UHF reception.

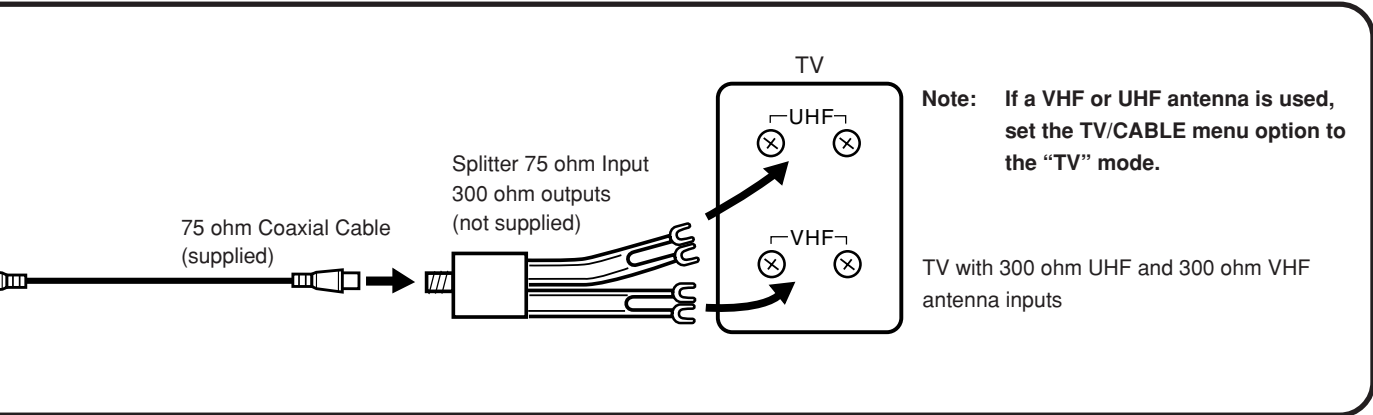
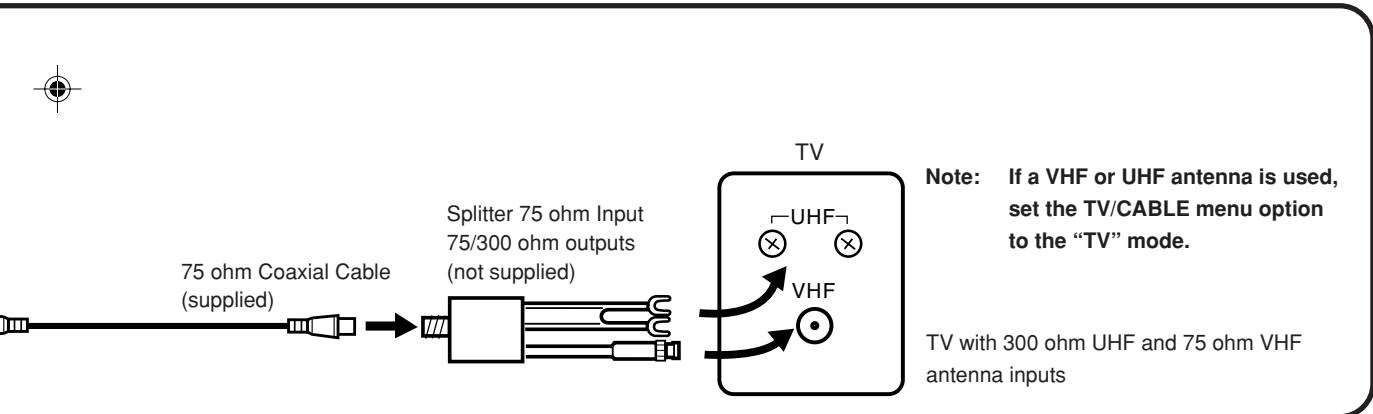
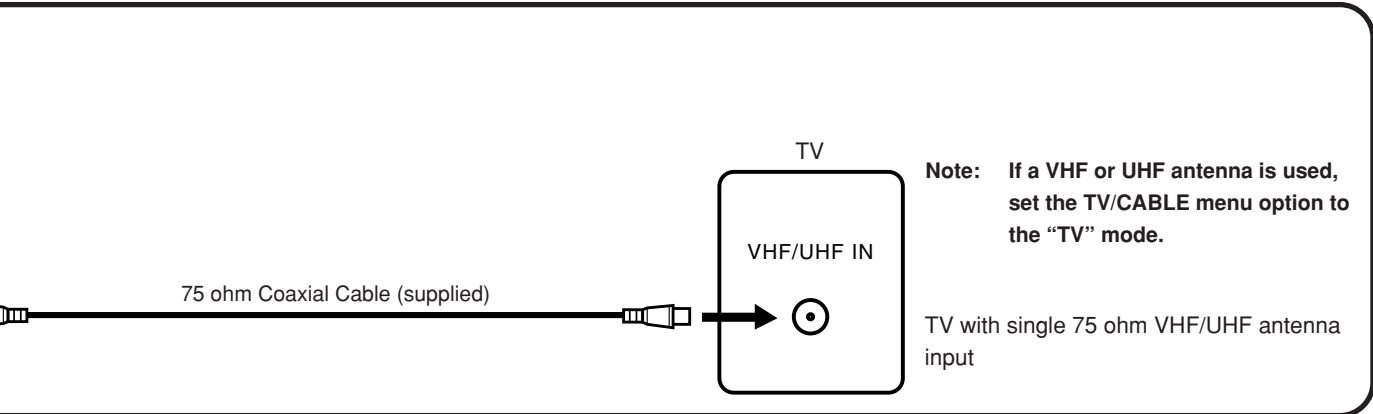

Cable TV connections

Many cable companies offer services permitting reception of extra channels including pay or subscription channels. This DVD/VCR has an extended tuning range and can be tuned to most cable channels without using a cable company supplied converter box, except for those premium channels which are intentionally scrambled. If you subscribe to a premium channel which is scrambled, you must have a descrambler box for proper reception.

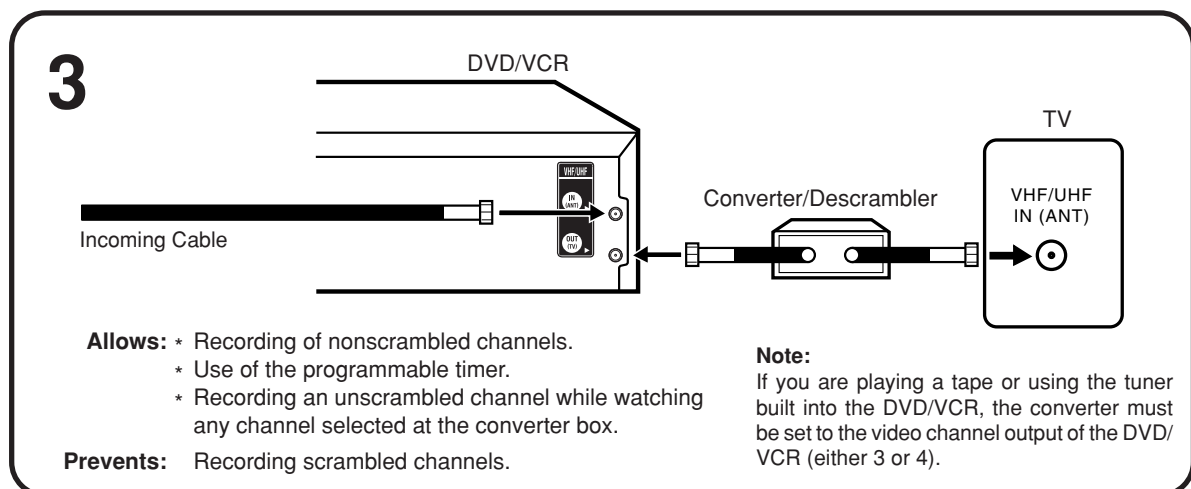
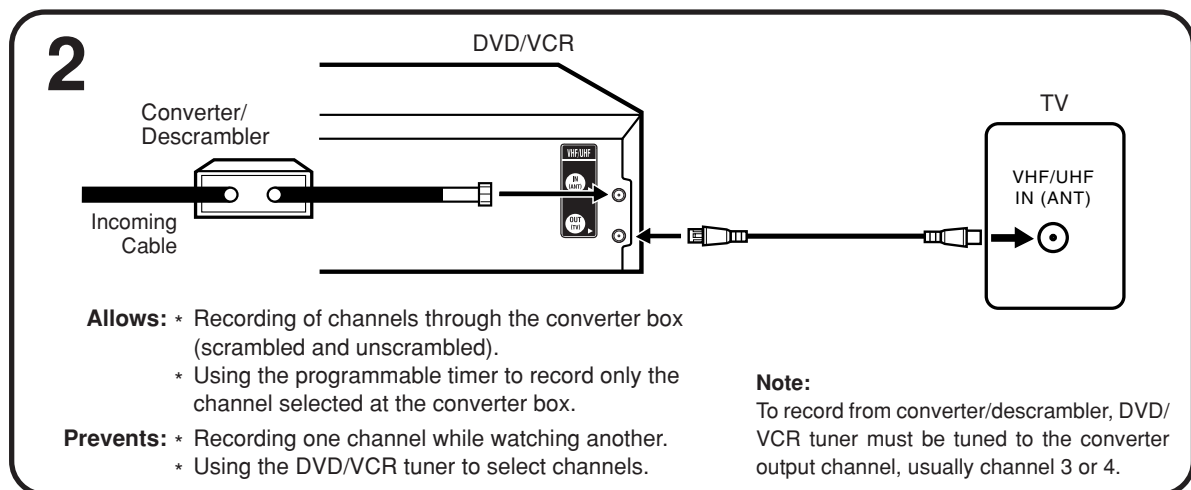
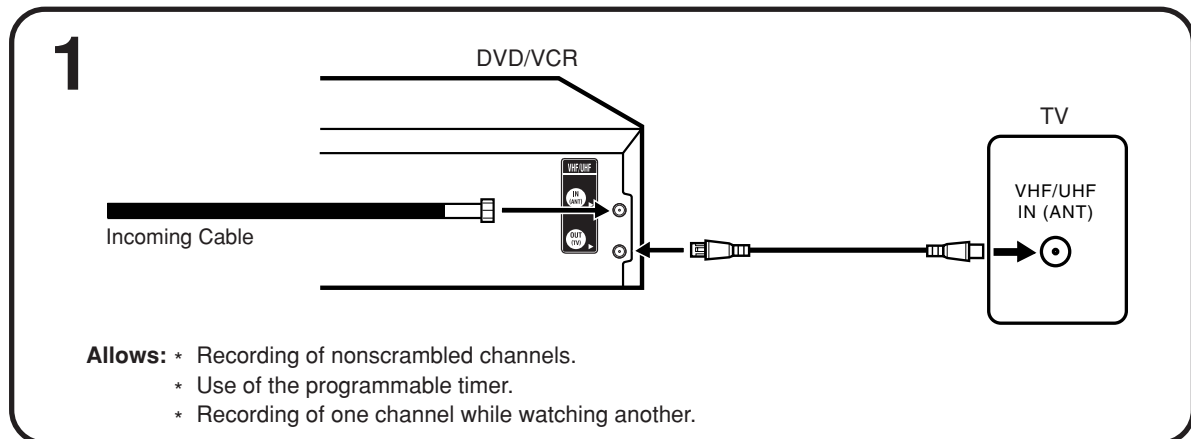

Note: Whenever a Converter/Descrambler box is placed before the DVD/VCR, you must tune the DVD/VCR to the output of the Converter/Descrambler box, usually channel 3 or 4.



IMPORTANT: Make sure the TV/CABLE menu option is set to the "CABLE" mode.

This DVD/VCR cannot receive scrambled programs since it does not contain a descrambler. In order to receive scrambled programs, your existing descrambler must be used. Descrambler boxes are available from cable companies. Consult your local cable company for more information concerning connection to their descrambler equipment. There are many ways to connect your DVD/VCR to a cable system. Below are six common methods of connection.

4

Allows:

- * Recording of one channel while watching another.
- * Using the programmable timer to record only the channel selected at the converter box.
- * Recording of all channels through the converter box.

Prevents:

- * Watching scrambled channels while recording another channel.
- * Using the DVD/VCR tuner to select channels.

5

Allows:

- * Recording of nonscrambled channels.
- * Recording of one channel while watching another.
- * Watching premium channels through the converter while recording nonscrambled channels.
- * Using the programmable timer.

Prevents: Recording scrambled channels.

6

Allows:

- * Recording of all channels through the converter box.
- * Recording a scrambled or unscrambled channel while watching another (scrambled or unscrambled) channel.
- * Using the programmable timer to record only the channel selected at the converter box.

Prevents: Using the DVD/VCR tuner to select channels.

Connecting to a TV

Connect the DVD/VCR to your TV.

Note: This method transports VHS and DVD-video signals. For enhanced DVD-video performance, we recommend you to connect the S-video or ColorStream® component video outputs to your TV/monitor also. [21]

Basic connection

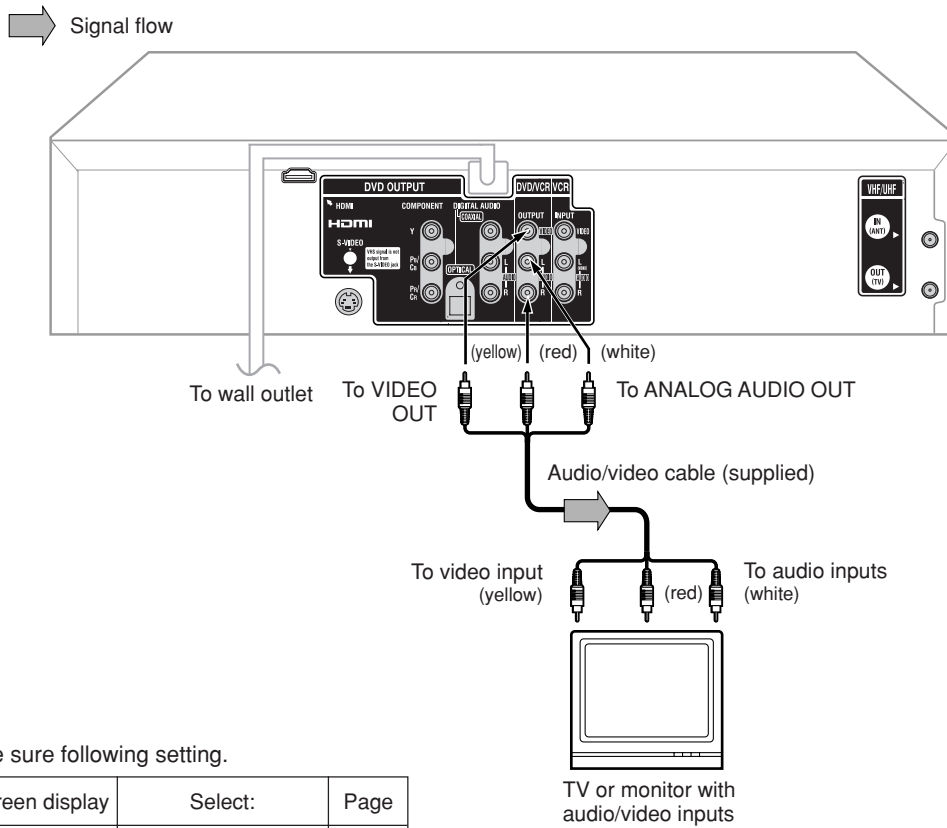

• Make sure following setting.

On-screen display	Select:	Page
"Digital Out"	"PCM" or "Bitstream"	[67]

Notes:

- Refer to the owner's manual of the connected TV as well.
- When you connect the DVD/VCR to your TV, be sure to turn off the power and unplug both units from the wall outlet before making any connections.
- If your television set has one audio input, connect the left and right audio outputs of the DVD/VCR to a Y cable adapter (not supplied) and then connect to your TV.
- Connect the DVD/VCR directly to your TV. If you connect the DVD/VCR to a VCR, TV/VCR combination or video selector, the playback picture may be distorted as DVD video discs are copy protected.
- While HDMI is being output in the DVD mode, it is impossible to output from the Video out jack, S-video out jack or Component video out jacks.



■ S-video output

An S-Video connection is superior to Video (Yellow) output. Use this method for DVD playback when the connected television has S-Video input, and does not have component video inputs.

■ Component video outputs

PROGRESSIVE outputs

Some TVs or monitors are equipped with component video inputs that are capable of reproducing a progressively scanned video signal. Connecting to these inputs allows you to view the highest quality pictures with less flicker.

INTERLACED outputs

Some TVs or monitors are equipped with component video inputs. Connecting to these inputs allows you to enjoy the highest quality DVD picture playback.

Notes:

- To switch the scan mode between the interlace and progressive modes, see page [69](#).
- In some TVs or monitors, the color levels of the playback picture may be reduced slightly or the tint may change. In such a case, adjust the TV or monitor for optimum performance.

Connecting to an audio system and TV equipped with S-video input/component video inputs

The S-video output and component video output transports the DVD-video signal exclusively and will deliver enhanced DVD video picture performance.

Signal flow →

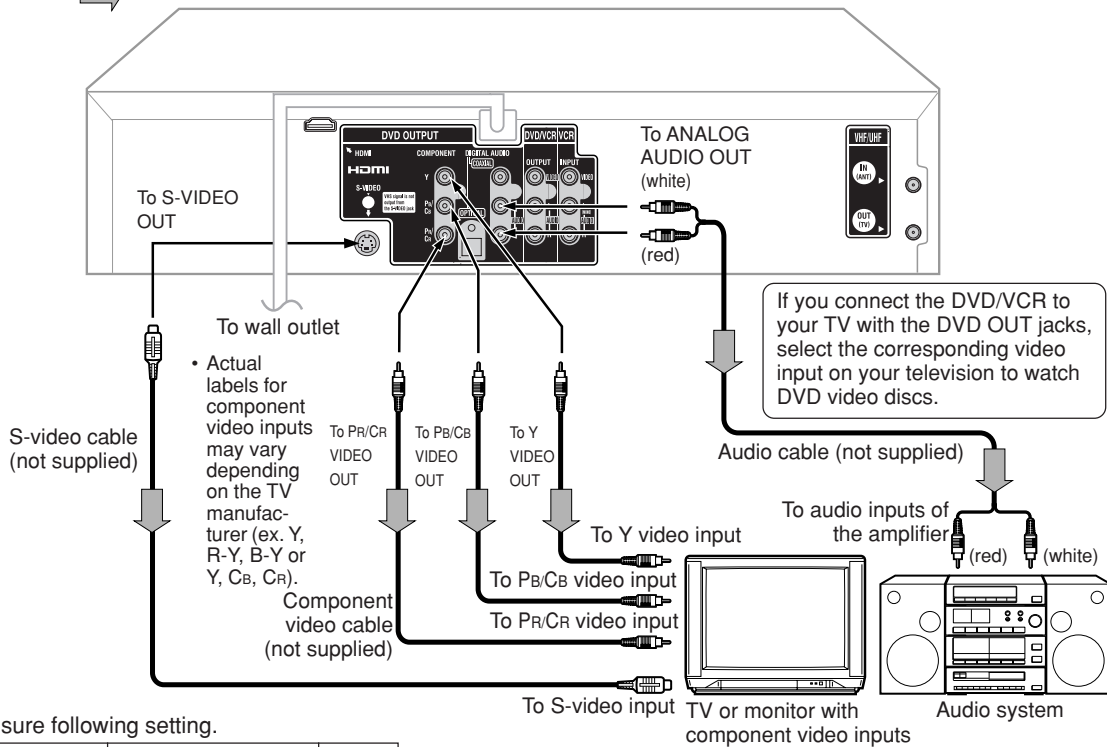

- Make sure following setting.

On-screen display	Select:	Page
"Digital Out"	"PCM" or "Bitstream"	67

Notes:

- Refer to the owner's manual of the connected equipment as well.
- When you connect the DVD/VCR to other equipment, be sure to turn off the power and unplug all of the equipment from the wall outlet before making any connections.
- If you place the DVD/VCR near a tuner or radio, the radio broadcast sound might be distorted. In this case, place the DVD/VCR away from the tuner and radio.
- The output sound of the DVD/VCR has a wide dynamic range. Be sure to adjust the receiver's volume to a moderate listening level. Otherwise, the speakers may be damaged by a sudden high volume sound.
- Turn off the amplifier before you connect or disconnect the DVD/VCR's power cord. If you leave the amplifier power on, the speakers may be damaged.
- While HDMI is being output in the DVD mode, it is impossible to output from the Video out jack, S-video out jack or Component video out jacks.
- **When connecting to a TV using the S-video jack, make sure that the Progressive indicator "P" on the display window is not lit. If it is lit, the S-video outputs do not feed the correct signals and you cannot see any picture. To turn off the Progressive indicator, select Interlaced output [69](#).**

Connecting to a TV (Continued)

About HDMI

HDMI (High Definition Multimedia Interface) supports both video and audio on a single digital connection for use with DVD players, DTV, set-top boxes, and other AV devices. HDMI was developed to provide the technologies of High Bandwidth Digital Content Protection (HDCP) as well as Digital Visual Interface (DVI) in one specification. HDCP is used to protect digital content transmitted and received by DVI-compliant or HDMI-compliant displays.

HDMI has the capability to support standard, enhanced, or high-definition video plus standard to multi-channel surround-sound audio. HDMI features include uncompressed digital video, a bandwidth of up to 2.2 gigabytes per second (with HDTV signals), one connector (instead of several cables and connectors), and communication between the AV source and AV devices such as DTVs.

HDMI, the HDMI logo and High-Definition Multimedia Interface are trademarks or registered trademarks of HDMI licensing LLC.

Connecting to a display (Using the HDMI cable)

➔ Signal flow

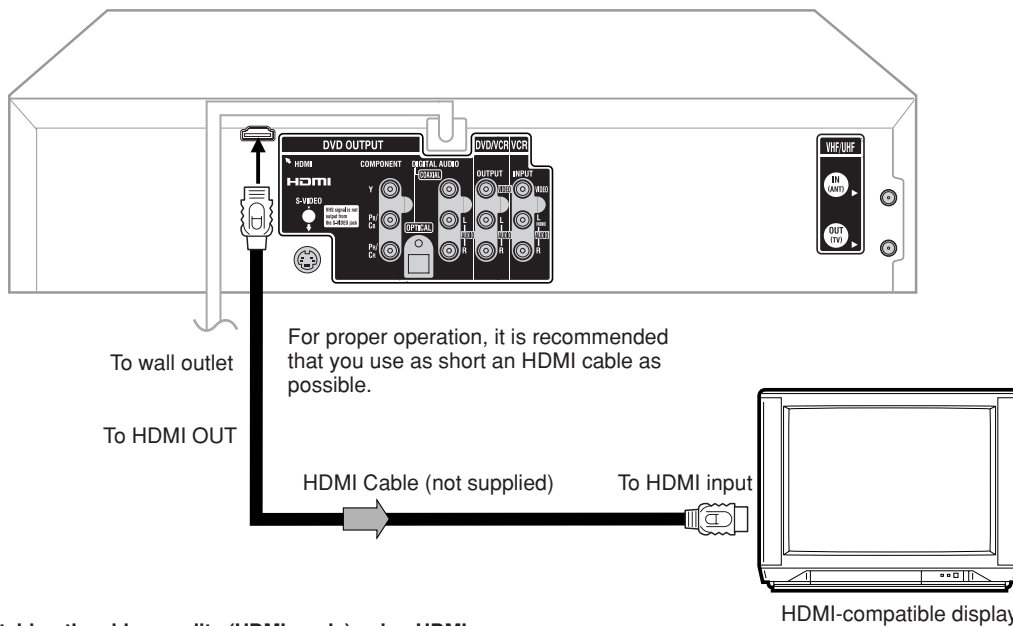

Switching the video quality (HDMI mode) using HDMI button on the remote control

HDMI Press **HDMI** on the remote control to receive a suitable video quality. The video quality is required to match your TV having HDMI feature and suitable quality. Please also check your TV owner's manual. Press **HDMI** to change the video quality as follows:

• Make sure following setting.

On-screen display	Select:	Page
"Digital Out"	"PCM"	67

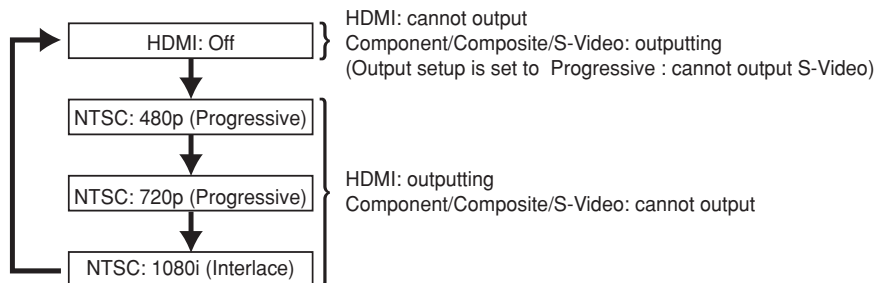

Notes:

It is only possible to switch the HDMI output in the following below cases unless only an Audio/Video Cable/S-video cable/ Component Video Cables is connected.

- * When in DVD Mode (in DISC/USB Mode)
- * When the disc is in Stop or Resume mode
- * When the Setup Menu is not being displayed
- * When the HDMI Cable is connected

The content of the output for each output jack are as shown in the following table and differ depending on User settings/operation.

USER setting/operation			Content of output for each output jack				
Mode VCR/DVD	HDMI Output *1	Output Setting	HDMI	Video	S-Video	Component	RF Modulator
VCR	Off	Interlace	-	VCR	DVD	480i (DVD)	VCR
		Progressive			-	480p (DVD)	
	Interlace	480p	480p (DVD)		-	-	
		720p	720p (DVD)				
		1080i	1080i (DVD)				
	Progressive	480p	480p (DVD)		-	-	
		720p	720p (DVD)				
1080i		1080i (DVD)					
DVD	Off	Interlace	-	DVD	DVD	480i (DVD)	DVD
		Progressive		-	-	480p (DVD)	-
	Interlace	480p	480p (DVD)	-	-	-	
		720p	720p (DVD)				
		1080i	1080i (DVD)				
	Progressive	480p	480p (DVD)	-	-	-	
		720p	720p (DVD)				
1080i		1080i (DVD)					

*1: Settings for HDMI output format are performed using the "HDMI" key on the remote control.

■ **Picture Output**

• **DVD Mode**

The following refers to instructions for Picture Output in DVD Mode.

There is no Analog Output (*2) for HDMI output.

When HDMI output setting is "Off", there is no HDMI output.

*2: Output from Video out jack/S-Video out jack/Component out jacks

• **VCR Mode**

The following refers to instructions for Picture Output in VCR mode.

This set outputs the picture from the Video out jack in VCR mode. However, please see the following instructions for HDMI out jack/S-Video out jack/Component out jacks.

<During HDMI Output>

DVD picture is always output from HDMI out jack during HDMI Output, but it cannot output from S-Video out jack/Component out jacks during HDMI Output.

<When HDMI Output setting is "Off">

When the HDMI output setting is "Off", this set outputs picture signals as follows according to the HDMI Setting in the Setup Menu. When HDMI Output setting is "Off", HDMI output does not function.

When the Output setting is "Interlace": Picture from VCR is output from the Video out jack
Picture from the DVD is output from the S-Video out jack/Component out jacks

When Output setting is "Progressive": Picture from VCR is output from the Video out jack
NO OUTPUT from the S-Video out jack
Picture from the DVD is output from the Component out jacks

Notes:





- When in DVD Mode/outputting HDMI signal, it is impossible to output any video images from either the Video out jack/S-Video out jack/Component out jacks.
If the viewer would like to view videos using the Video out jack/S-Video out jack/Component out jacks, then the HDMI output must set to "Off" by pressing the **HDMI** button on the remote control.
- When the HDMI Cable is connected, if the HDMI is pressed or the VCR Mode is switched to DVD Mode, there is a possibility that the monitor will not show any output images. In this case, turn off the HDMI mode.
Deactivate HDMI output with **HDMI** (For details, please refer to "Switching the video quality (HDMI mode) using HDMI button on the remote control" **22**).
- Refer to the Owner's manual of the connected TV as well.
- When connecting the DVD/VCR to your TV, be sure to turn off the power and unplug both units from the wall outlet before making any connections.
- If you have an HDMI (with HDCP) equipped monitor or display, you can connect it to the DVD/VCR using the HDMI cable.
- The HDMI connector outputs uncompressed digital video as well as almost every kind of digital audio that the DVD/VCR is compatible with, including DVD-Video, Video CD, Audio CD and MP3/WMA/JPEG/DivX® files.
- No sound will be output from the HDMI cable if the "Digital Out" is not set to "PCM" **67**.

Connecting to an audio equipment

You can enjoy high quality dynamic sounds of DVD video discs or audio CDs by connecting the DVD/VCR to optional audio equipment.

For connection to your TV, see "Connecting to a TV" [20](#) [21](#) [22](#).

• This selection uses the following reference mark.

-  : Front speaker
-  : Rear speaker
-  : Sub woofer
-  : Center speaker
-  : Signal flow

Connecting to an amplifier equipped with a Dolby® Digital decoder

Dolby Digital

Dolby Digital is the surround sound technology used in theaters showing the latest movies, and is now available to reproduce this realistic effect in the home. You can enjoy motion picture and live concert DVD video discs encoded via the Dolby Digital recording system with this dynamic realistic sound by connecting the DVD/VCR to a 6 channel amplifier equipped with a Dolby Digital decoder or Dolby Digital processor. If you have a Dolby Pro Logic Surround decoder, you will obtain the full benefit of Pro Logic from the same DVD movies that provide full 5.1-channel Dolby Digital soundtracks, as well as from titles with the Dolby Surround mark.

Manufactured under license from Dolby Laboratories. "Dolby", "Pro Logic" and the double-D symbol are trademarks of Dolby Laboratories.

- Use DVD video discs encoded via the Dolby Digital recording system.
- Make sure following setting.

On-screen display	Select:	Page
"Digital Out"	"PCM" or "Bitstream"	67

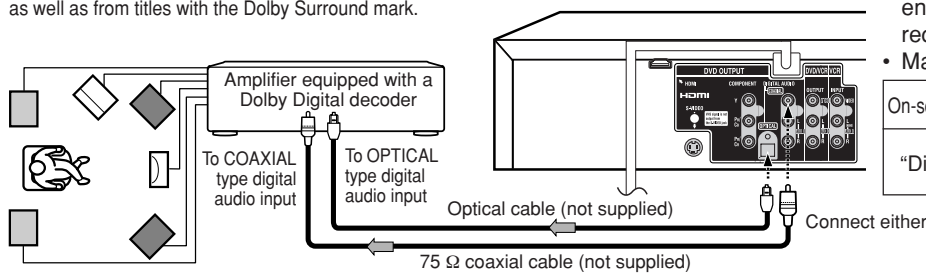

Connecting to an amplifier equipped with Dolby Surround Pro Logic

Dolby Surround Pro Logic

You can enjoy the dynamic realistic sound of Dolby Surround Pro Logic by connecting an amplifier and speaker system (right and left front speakers, a center speaker, and one or two rear speakers).

- With an amplifier equipped with Dolby Digital
Connect the equipment the same way as described in "Connecting to an amplifier equipped with a Dolby Digital decoder." Refer to that amplifier's owner's manual and set the amplifier so that you can enjoy Dolby Surround Pro Logic sound.
- With an amplifier not equipped with Dolby Digital
Connect the equipment as follows.
 - This connection is only suitable for Video CDs and Audio CDs.

• Make sure following setting.

On-screen display	Select:	Page
"Digital Out"	"PCM" or "Bitstream"	67

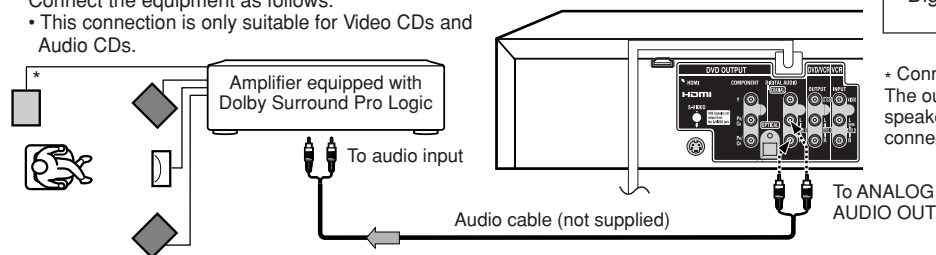

* Connect one or two rear speakers. The output sound from the rear speakers will be monaural even if you connect two rear speakers.

Connecting to an amplifier equipped with a DTS decoder

Digital Theater Systems (DTS)

DTS is a high quality surround technology used in theaters and now available for home use, on DVD video discs or audio CDs.

If you have a DTS decoder or processor, you can obtain the full benefit of 5.1 channel DTS encoded sound tracks on DVD video discs or audio CDs.

"DTS" and "DTS Digital Out" are trademarks of Digital Theater Systems, Inc.

- Use DVD video discs or audio CDs encoded via the DTS recording system.
- Make sure following setting.

On-screen display	Select:	Page
"Digital Out"	"Bitstream"	67

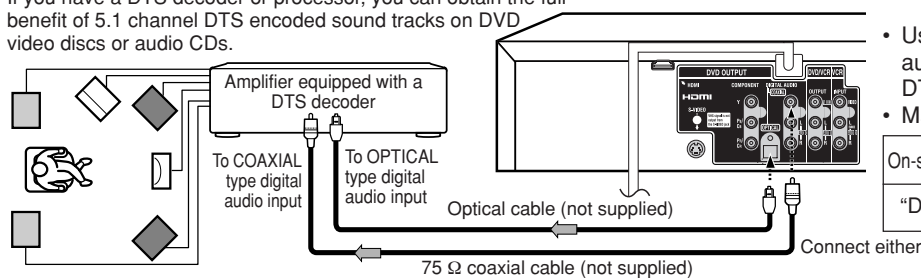

**Warning**

When playing DTS-encoded discs (DVD video discs and audio CDs), excessive noise may be output from the analog stereo jacks. To avoid possible damage to the audio system, you should take proper precautions when the ANALOG AUDIO OUT (L/R) jacks of the DVD/VCR are connected to an amplification system. (Do not leave the ANALOG AUDIO OUT (L/R) wires dangling.) To enjoy DTS Digital Surround™ playback, an external 5.1 channel DTS Digital Surround™ decoder system must be connected to the OPTICAL or COAXIAL DIGITAL AUDIO OUT jack of the DVD/VCR.

Connecting to an amplifier equipped with an MPEG2 audio decoder**MPEG2 sound**

You can enjoy motion picture and live concert DVD video discs encoded via the MPEG2 recording system with dynamic realistic sound by connecting an amplifier equipped with an MPEG2 audio decoder or MPEG2 audio processor.

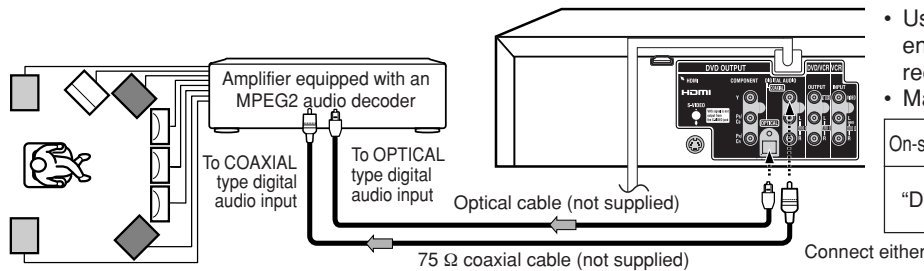

- Use DVD video discs encoded via the MPEG2 recording system.
- Make sure following setting.

On-screen display	Select:	Page
"Digital Out"	"PCM" or "Bitstream"	67

Connecting to an amplifier equipped with a digital audio input**2 channel digital stereo**

You can enjoy the dynamic sound of 2 channel digital stereo by connecting an amplifier equipped with a digital audio input and speaker system (right and left front speakers).

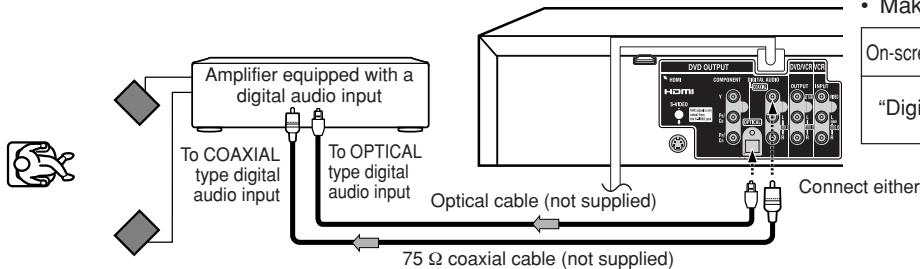

- Make sure following setting.

On-screen display	Select:	Page
"Digital Out"	"PCM" or "Bitstream"	67

Notes:

- DO NOT connect the OPTICAL or COAXIAL DIGITAL AUDIO OUT jack of the DVD/VCR to the AC-3 RF input of a Dolby Digital Receiver. This input on your A/V Receiver is reserved for Laserdisc use only and is incompatible with the OPTICAL or COAXIAL DIGITAL AUDIO OUT jack of the DVD/VCR.
- Connect the OPTICAL DIGITAL AUDIO OUT jack of the DVD/VCR to the "OPTICAL" input of a Receiver or Processor.
- Connect the COAXIAL DIGITAL AUDIO OUT jack of the DVD/VCR to the "COAXIAL" input of a Receiver or Processor.
- Refer to the owner's manual of the connected equipment as well.
- When you connect the DVD/VCR to other equipment, be sure to turn off the power and unplug all of the equipment from the wall outlet before making any connections.
- The output sound of the DVD/VCR has a wide dynamic range. Be sure to adjust the receiver's volume to a moderate listening level. Otherwise, the speakers and your hearing may be damaged by a sudden high volume sound.
- Turn off the amplifier before you connect or disconnect the DVD/VCR's power cord. If you leave the amplifier's power on, the speakers may be damaged.

Connecting to a USB Mass Storage

This unit can be used to read JPEG, WMA, MP3 and DivX® data for any memory card reader/writer or digital camera that accepts USB Mass Storage Class.

For devices that are compatible with the unit's USB port, please refer to page 18.

Connecting to a USB Mass Storage

➔ Signal flow

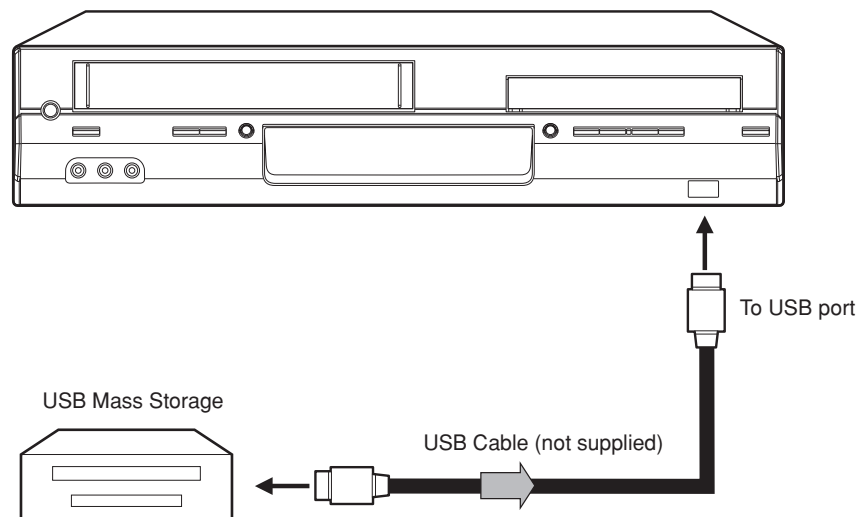

Notes:

In order to avoid damage to the unit, the USB Mass Storage, the Memory Card, etc, the following instructions should be observed.

- Insert the USB cable properly taking care to observe the correct port direction.
- Make sure the unit is off or is set to DISC mode 5B when disconnecting the USB Mass Storage from the unit.
- In order to avoid damage to recorded data, do not plug in or unplug the unit, no matter whether the USB Mass Storage is On or Off, including Resume Stop mode.
- In order to avoid damage to recorded data, do not disconnect the USB Mass Storage from the port, no matter whether the USB Mass Storage is On or Off, including Resume Stop mode.
- Before removing the Memory Card while a Memory Card Reader or Digital Camera is connected to the unit, ensure that the power is off or that the unit is in DISC mode 5B.
- Do not remove the Memory Card from the Memory Card Reader or Digital Camera no matter whether the Memory Card is On or Off, including Resume Stop mode.
- In order to avoid damage to recorded data, do not plug in or unplug the unit, no matter whether the Memory Card is inserted or not inserted into the Memory Card Reader or Digital Camera, including Resume Stop mode.
- In order to understand the correct operation and handling of the USB Mass Storage, read the USB Mass Storage instructions carefully.
- As it cannot be guaranteed that recorded data will not be damaged while using this unit, it is recommended to make back-up data.
- Avoid connecting any other USB connectable device that uses electricity from the USB connector such as a Printer or Keyboard when the USB Mass Storage is connected.
- It is impossible to connect several devices by using a USB HUB.

Setting the video channel

When a TV is connected with the 75 ohm coaxial cable only. To view playback of a recorded tape or DVD disc, or to watch a program selected by the VCR's channel selector, the TV must be set to channel 3 or 4 (video channel).

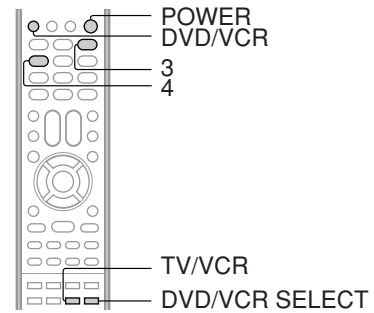

Setting the video channel

1 Press DVD/VCR to operate the DVD/VCR.



2 Press and hold 3 or 4 on the remote for 3 seconds in standby mode.

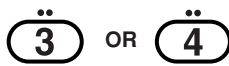

The video channel will start to flash for 3 seconds in the display window.

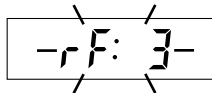

3 Press POWER on the remote control or I/ON/STANDBY on the unit to turn on the DVD/VCR.



4 Press DVD/VCR SELECT to select the VCR mode.



The VCR indicator on the front panel will light.



5 Turn ON the TV and set to CH 3 or 4 to correspond with the channel selected in step 2.

6 Press TV/VCR to select the VCR position.



The VCR indicator will appear in the display window.

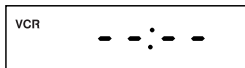

7 Select any channel to receive a TV station in your area. The channel number will appear on the screen for about 4 seconds.

For a push-button TV tuner

If CH 3 or 4 corresponding to the video channel cannot be tuned on your TV, proceed as follows: set the VCR 3/4 channel selector and the TV to CH 3 or 4, playback a prerecorded tape and tune the TV to receive a sharp color picture from the video cassette recorder. Refer to your TV owner's manual for details.

Note:

If the unit does not operate properly, or No key operation (by the unit and/or the remote control): Static electricity, etc., may affect the player's operation. Disconnect the AC power cord once, then connect it again.

Basic setup (VCR)

Setting the language

You can choose from three different languages (English, French and Spanish) for the on-screen display.

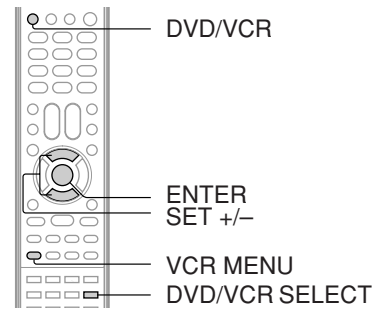

Setting the language

Preparation:

- Turn ON the TV and select to the corresponding video input.
- Press **DVD/VCR** to operate the DVD/VCR.
- Press **DVD/VCR SELECT** to select the VCR mode. (The VCR indicator will light.)

1 Press VCR MENU.



The VCR menu screen will appear. Press **SET +** or **-** to select "SYSTEM SETUP", then press **ENTER**. If you use the unit for the first time, press **VCR MENU**, instead of the "SYSTEM SETUP" menu screen of the main screen in step 2 may appear.

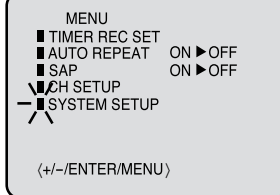
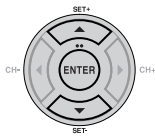

2 Press SET + or - to select "LANGUAGE", then press ENTER.

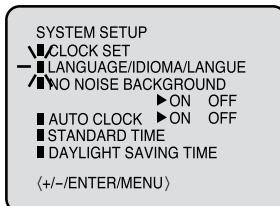
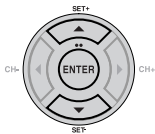

3 Press SET + or - to select the desired language: English (ENGLISH), Spanish (ESPAÑOL) or French (FRANCAIS), then press ENTER.

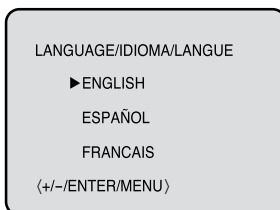
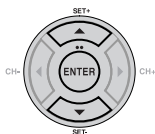

4 Press VCR MENU until the menu screen is cleared.



Notes:

- Both the VCR and the DVD have their own player menus **63**.
- If no buttons are pressed for more than 60 seconds, the VCR MENU screen will return to normal TV-operation automatically.

Clock setting

The AUTO CLOCK function will automatically set the built-in clock (Month, Day, Year and Time) when the DVD/VCR is connected to an Antenna or Cable system and it is turned off. The DVD/VCR searches for a station in your area containing the necessary AUTO CLOCK setting signals. Once received, it will take approximately 4 minutes for the clock to set itself automatically.

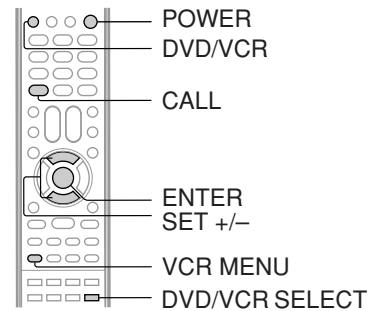

AUTO CLOCK setting

Preparation:

- Turn ON the TV and select the corresponding video input.
- Press **DVD/VCR** to operate the DVD/VCR.
- Press **DVD/VCR SELECT** to select the VCR mode. (The VCR indicator will light.)

1 Connect the Antenna or Cable system.

- If you use a cable box, turn it on.

2 Plug the AC power cord to the AC outlet.

3 Make sure the DVD/VCR is turned off.

- Depending on the reception condition it may take approx. thirty minutes.
- If you press **POWER**, the Auto Clock set is not programmed.

4 Wait at least three minutes and press POWER.



5 Press CALL to check the clock setting on the on screen display.

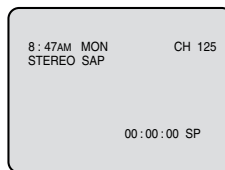

6 If the clock is not set, check the antenna condition. The AUTO CLOCK may not function properly if the reception condition is not good.

AUTO CLOCK adjustment

The auto clock adjustment will be updated at 6:00 AM, 12:00 PM and 6:00 PM everyday when the DVD/VCR turned off.

- If you use a cable box and you want AUTO CLOCK adjustment to be performed, the cable box must be left on.
- The AUTO CLOCK adjustment is not effective when there is a difference of more than 5 minutes exists between the built-in clock time and the actual time.

To set AUTO CLOCK to off

When shipped from factory the AUTO CLOCK is set to "ON". But if you do not want AUTO CLOCK setting:

1 Press VCR MENU.

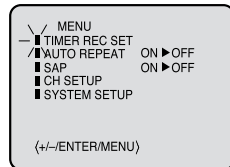

2 Press SET + or - to select "SYSTEM SETUP", then press ENTER.

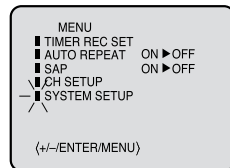
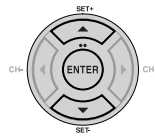

3 Press SET + or - to select "AUTO CLOCK".

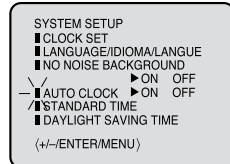
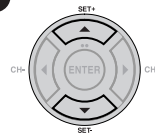

4 Press ENTER to select "OFF".

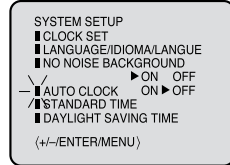
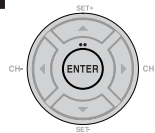

5 Press VCR MENU repeatedly to return to the normal screen.



- When the AUTO CLOCK is set to "OFF", the AUTO CLOCK adjustment does not function. Set the clock manually **[31]**.

Clock setting (Continued)

To set STANDARD TIME

In the rare event that you live within broadcast range of two stations in two different time zones, the DVD/VCR may recognize the wrong station for the AUTO CLOCK setting. To correct the situation:

- 1 Press VCR MENU.**

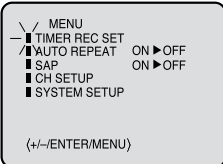
(+/-/ENTER/MENU)
- 2 Press SET + or - to select "SYSTEM SETUP", then press ENTER.**

(+/-/ENTER/MENU)
- 3 Press SET + or - to select "STANDARD TIME", then press ENTER.**

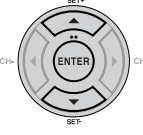
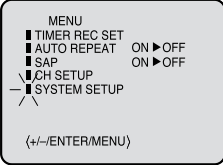

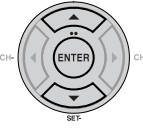
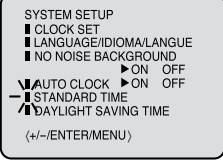

(+/-/ENTER/MENU)
- 4 Press SET + or - to select your time zone, then press ENTER.**

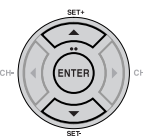

ATLANTIC	: GMT-4hours
EASTERN	: GMT-5hours
CENTRAL	: GMT-6hours
MOUNTAIN	: GMT-7hours
PACIFIC	: GMT-8hours
ALASKA	: GMT-9hours
HAWAII	: GMT-10hours
AUTO	: AUTO SET

(GMT: Greenwich Mean Time)
- 5 Press VCR MENU until the menu screen is cleared.**



- Notes:**
- To be able to select the standard time, the clock must first be set by AUTO CLOCK once.
 - If you live in Newfoundland and the AUTO CLOCK does not function properly, set the AUTO CLOCK menu option to "OFF" and set the clock manually.

To set DAYLIGHT SAVING TIME

You can set the DAYLIGHT SAVING TIME automatically or manually.

- 1 Press VCR MENU.**

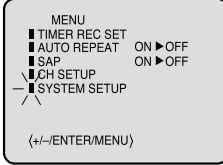
(+/-/ENTER/MENU)
- 2 Press SET + or - to select "DAYLIGHT SAVING TIME", then press ENTER.**



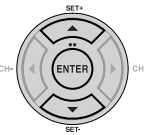
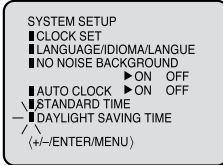

(+/-/ENTER/MENU)
- 3 Press SET + or - to select one of the options, then press ENTER. Press VCR MENU until the MENU screen is cleared.**

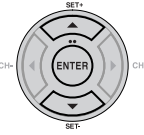
ON:	for manual setting (forward one hour)
OFF:	for manual setting (back one hour)
AUTO:	for automatic setting (read XDS in the signal)

When you want to set the DAYLIGHT SAVING TIME manually, on the first Sunday in April you set to "ON", and on the last Sunday in October you set to "OFF".

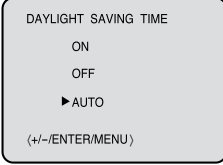

(+/-/ENTER/MENU)

- Notes:**
- When shipped from factory, the DAYLIGHT SAVING TIME is set to "AUTO" position.
 - When the clock is not set, DAYLIGHT SAVING TIME setting is not available.
 - When there is no DAYLIGHT SAVING TIME in your area, always select "OFF" position in step 3.

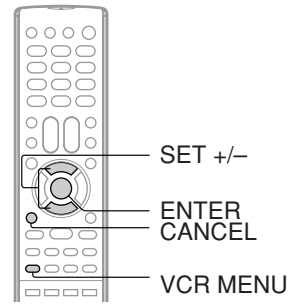

If the AUTO CLOCK process did not set the date and time correctly, you must set them manually for timer recording and DAYLIGHT SAVING TIME.

Manual clock setting

EXAMPLE: Setting the clock to "8:30 AM" October, 28 (SAT), 2006.

1 Press VCR MENU.



2 Press SET + or - to select "SYSTEM SETUP", then press ENTER.

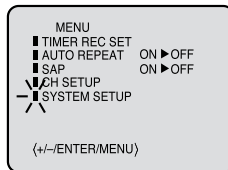
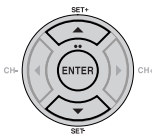

3 Press SET + or - to select "CLOCK SET", then press ENTER.

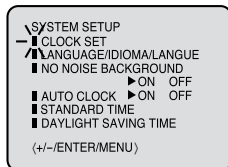
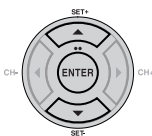

4 Press SET + or - to set the month, then press ENTER.

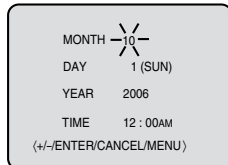
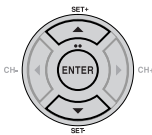

5 Set the day, year and time as in step 4.

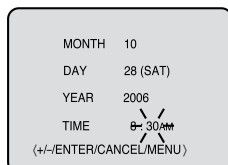

6 After setting the clock, date and time starts functioning automatically.



■ To make corrections any time during the process Press **CANCEL** repeatedly until the item you want to change blinks, then press **SET + or -**.

Note:

After a power failure or disconnection of the power, the timer settings will be lost. In this case, reset the present time.

Basic setup (VCR)

Tuner setting

This DVD/VCR is equipped with a channel memory feature which allows channels to skip up or down to the next channel set into memory, skipping over unwanted channels. Before selecting channels, they must be programmed into the DVD/VCR's memory. In addition to normal VHF and UHF channels, this DVD/VCR can receive up to 113 Cable TV channels. To use this DVD/VCR with an antenna, set the TV/CABLE menu option to the TV mode. When shipped from the factory, this menu option is in the CABLE mode.

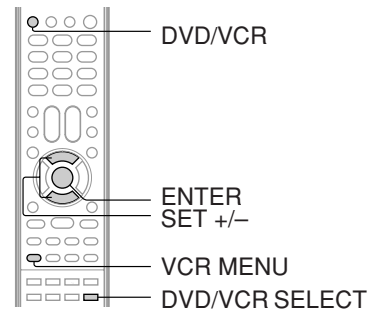

TV/CABLE selection

Preparation:

- Turn ON the TV and select to the corresponding video input.
- Press **DVD/VCR** to operate the DVD/VCR.
- Press **DVD/VCR SELECT** to select the VCR mode. (The VCR indicator will light.)

1 Press **VCR MENU**. Press **SET + or -** to select "CH SETUP", then press **ENTER**.

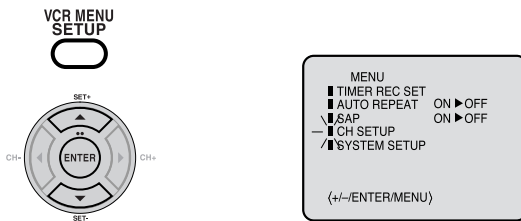

2 Press **SET + or -** to select "TV/CABLE".

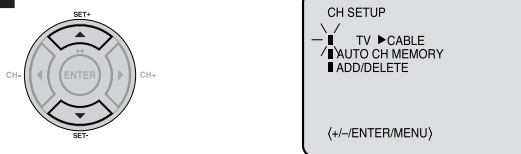

3 Press **ENTER** to select the TV or CABLE mode.

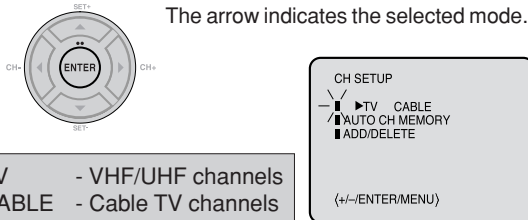

4 Press **VCR MENU** until the menu screen is cleared.



Note:

You can't select "CH SETUP" if you set the channel to "L1" or "L2".

Setting channels automatically

1 Repeat left step 1 and press **SET + or -** to select "AUTO CH MEMORY".

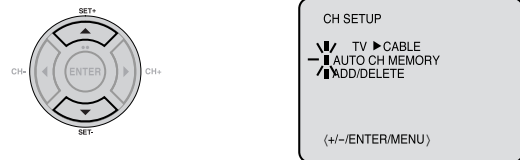

2 Press **ENTER**.

Auto tuning will begin. The channel display will count up and when finished, the screen returns to normal.

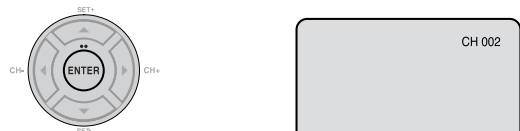

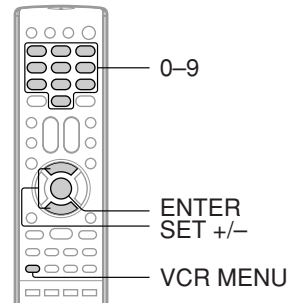

To ADD/DELETE channels

1 Repeat the step 1 on page 32. Then press **SET +** or **-** to select the "ADD/DELETE" and press **ENTER**.

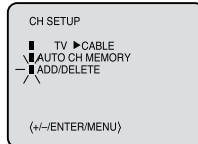
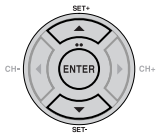

2 To Add or Delete channels

- 1) Press **Direct channel selection buttons (0-9)** or **SET +/-** to select a channel number you want to add or delete.
- 2) **To add channels**
Press **ENTER** until "ADD" appears on the screen.
To delete channels
Press **ENTER** until "DELETE" appears on the screen. The channel number will blink.
- 3) Repeat step 1 and 2 to add or delete other channel.

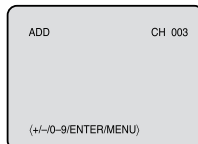
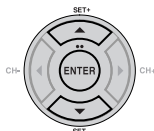
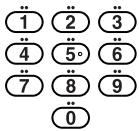

3 Press **VCR MENU** until the menu screen is cleared.



Noise elimination

When you don't want to receive a weak signal broadcast, a Blue back screen can be obtained by selecting the NO NOISE BACKGROUND to "ON". When the unit is shipped from the factory, the NO NOISE BACKGROUND is set to "ON".

1 Repeat the steps 1~2 on page 31) and press **SET +** or **-** to select "NO NOISE BACKGROUND".

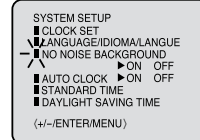
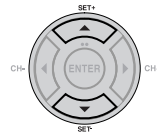

2 Press **ENTER** to select "ON" or "OFF" position.

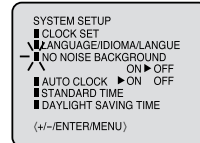
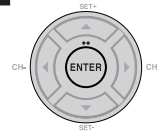

3 Press **VCR MENU** until the menu screen is cleared.



Basic setup (VCR)

Loading and unloading a cassette tape

Use only video cassette tapes marked **VHS**.

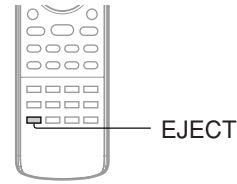

Loading

Push the center of the tape until it is automatically inserted.



Insert the cassette tape with its labeled side facing up and the erase prevention tab positioned at your left. An inverted cassette tape cannot be inserted.

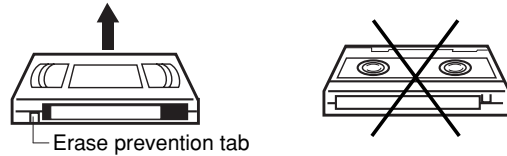

Automatic power ON

When you insert a cassette tape, the DVD/VCR power will turn ON automatically.

Automatic playback

When loading a cassette tape without an erase prevention tab, playback will start automatically.

Unloading

1 Press **EJECT** on the front panel or on the remote.



or

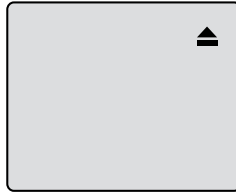

2 Remove the cassette tape.

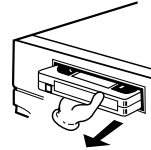

Automatic tape eject

This DVD/VCR will automatically rewind the tape when the tape has ended. Once the tape is rewound to its beginning, the cassette tape will be ejected automatically.

To prevent accidental erasure

To prevent accidental erasure

Remove the erase prevention tab with a screwdriver.

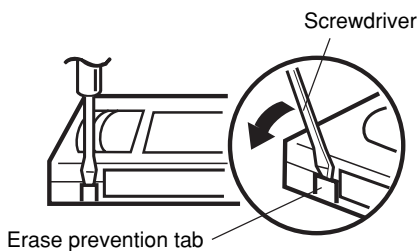

To record again

Cover the hole with a piece of adhesive tape.

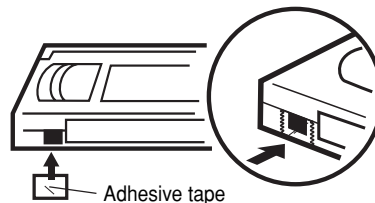

Tape speed and maximum recording time

Tape Speed	Video cassette tape				
	T-160	T-120	T-90	T-60	T-30
SP (Standard Play)	2-2/3 hours	2 hours	1-1/2 hours	1 hour	30 minutes
SLP (Super Long Play)	8 hours	6 hours	4-1/2 hours	3 hours	1-1/2 hours



Cassette tape playback

To play a prerecorded tape.

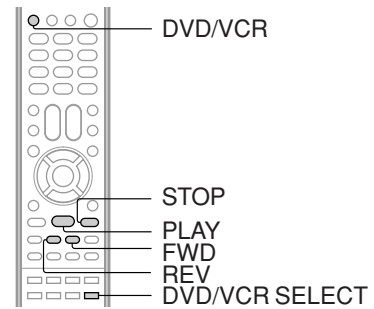

Playback

Preparation:

- Turn ON the TV and select the corresponding video input.
- Press **DVD/VCR** to operate the DVD/VCR.
- Press **DVD/VCR SELECT** to select the VCR mode. (The VCR indicator will light).

1 Load a prerecorded tape

(When loading a cassette tape without the erase prevention tab, playback will start automatically).

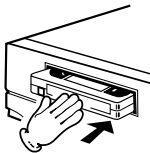

2 To start playback

Press **PLAY**. Playback will start. "▶" will appear on the screen for about 4 seconds.

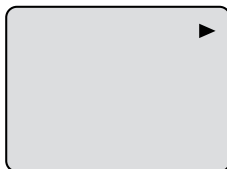

To stop playback

Press **STOP** once. The tape will stop but remain fully loaded and ready to play. "■" will appear on the screen for about 4 seconds.

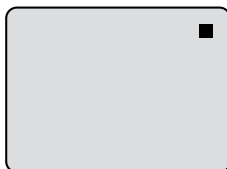

Rewind or forward the tape

Stop the playback or recording via **STOP** on remote control.

To rewind the tape:

Press **REV**.

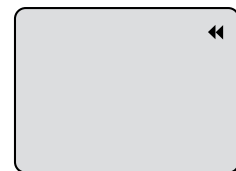

To forward the tape:

Press **FWD**.



To discontinue the tape-winding, press **STOP**. To switch to playback directly (without **STOP**), press **PLAY**.

■ Forward/Reverse picture search mode

When the tape is being wound, you can switch to picture search mode (see page 36). To do this, press **REV** or **FWD** and hold it down. The unit will resume the tape advance or rewinding as soon as the button is released.

Playback (VCR)

Notes:

- This VCR selects the playback tape speed SP, LP or SLP automatically.
- The Cassette tape and DVD disc can be played back simultaneously. If you press **DVD/VCR SELECT**, the tape playback and DVD playback alternate with each other on the screen (via CH3, 4 or video connection).

Special playback

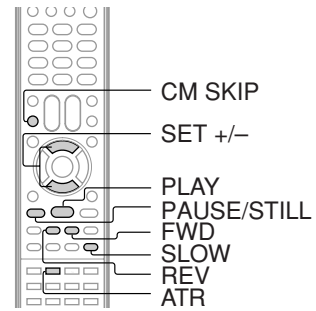

Picture search

Reverse picture search function

Press **REV** once or twice during playback.

Forward picture search function

Press **FWD** once or twice during playback.
To return to playback, press **PLAY**.

SPEED SEARCH TIMES

TAPE SPEED	PICTURE SEARCH SPEED	
	PRESS ONCE	PRESS TWICE
SP (Standard Play)	3 X	5 X
LP (Long Play)	7 X	9 X
SLP (Super Long Play)	9 X	15 X

Still picture

Press **PAUSE/STILL** during playback.

To resume normal playback, press **PLAY** or **PAUSE/STILL**.

Slow motion

During playback press **SLOW**.

To return to playback, press **PLAY**.

■ Slow tracking and vertical lock adjustment

If noise bars appear in the picture during slow motion, press the **SET +/-** to reduce the noise bars.

If the still picture jitters excessively, press **SET +/-** to stabilize the still picture.

Frame by frame picture

Press **PAUSE/STILL** during playback.

Press **SLOW** repeatedly. The picture advances frame by frame.

To return to playback, press **PLAY** or **PAUSE/STILL**.

CM skip

Press **CM SKIP** during playback. The DVD/VCR will search forward through approximately 30 seconds of the tape (e.g. unwanted commercial time) for each press of **CM SKIP** (maximum six presses) and then resume normal playback.

For example : 1 press: 30 seconds of tape
2 press: 60 seconds of tape
3 press: 90 seconds of tape

Adjusting tracking condition

■ Automatic tracking adjustment

Whenever you insert a tape and start playback, the automatic tracking feature continuously analyzes the signal to enable optimum picture quality during playback.

■ Manual tracking adjustment

If automatic tracking cannot eliminate noises well during playback, press **SET +/-** to eliminate the noise. "MANUAL TR." will appear on the screen. Press it once for a fine adjustment, or press and hold for a coarse adjustment.

Press **ATR** to reactivate automatic tracking again. "AUTO TR." will appear on the screen.

AUTO TR.

Notes:

- The audio output is muted during PICTURE SEARCH, STILL, FRAME ADVANCE and SLOW MOTION.
- During picture search mode there will be noise bars. This is not a defect.
- Playback will commence after approx. 5 minutes to protect the video tape against excessive wear during pause mode.

Video head cleaning

■ Video head clogging

The video heads are the means by which the DVD/VCR reads the picture from the tape during playback. In the unlikely event that the heads become dirty enough to be clogged, no picture will be displayed. This can easily be determined if, during playback of a known good tape, there is good sound, but no picture (picture is extremely snowy). If this is the case, the DVD/VCR need to check and clean by the qualified service personnel.



Good Picture



Snowy Picture

Notes:

- DO NOT ATTEMPT TO CLEAN THE VIDEO HEADS OR SERVICE THE UNIT BY REMOVING THE REAR COVER.
- Video heads may eventually wear out and should be replaced when they fail to produce clear pictures.
- To help prevent video head clogging, use only good quality VHS tapes. Discard worn out tapes.

Convenience function

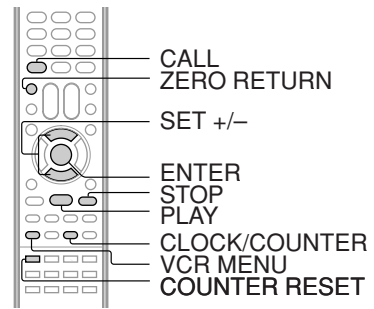

Repeat playback

The entire video tape will play until its end. The tape will automatically rewind to the beginning and the playback will be repeated.

Zero return function

This function rewinds the tape to the "00:00" counter position automatically.

1 Press VCR MENU.
Press **SET + or -** to select "AUTO REPEAT".

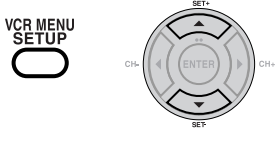

MENU	
TIMER REC SET	ON ▶ OFF
AUTO REPEAT	ON ▶ OFF
SAP	ON ▶ OFF
CH SETUP	
SYSTEM SETUP	

(+/-)ENTER/MENU

2 Press ENTER to select "ON" or "OFF".
If "ON" is selected, the playback will be repeated endlessly.

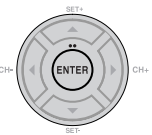

MENU	
TIMER REC SET	ON ▶ OFF
AUTO REPEAT	ON ▶ OFF
SAP	ON ▶ OFF
CH SETUP	
SYSTEM SETUP	

(+/-)ENTER/MENU

3 Press VCR MENU until the menu screen is cleared.
If you press **CALL**, "⏪" will appear on the screen **11**.



4 To commence playback, press PLAY.
The playback will be repeated endlessly.



1 Press CLOCK/COUNTER.
The counter display shows the tape running time during playback or recording.



2 Press COUNTER RESET at the desired tape position.
The counter display will be reset to "00:00" position (e.g. the beginning of recording).



3 Press STOP when playback or recording is completed. Press ZERO RETURN.
The tape will automatically rewind or fast forward to the "00:00" counter position.



Playback (VCR)

To cancel repeat mode:

Follow the above step 1, then press **ENTER** to select "OFF" position. Press **VCR MENU** to return to the TV.

Convenience function (Continued)

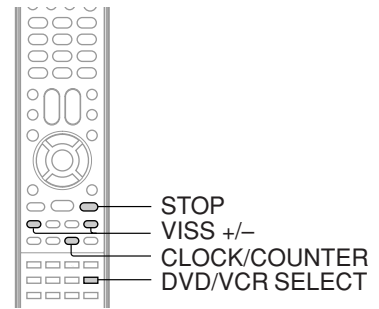

Clock/counter display

Press **CLOCK/COUNTER**. The clock and tape counter alternate with each other in the display window.

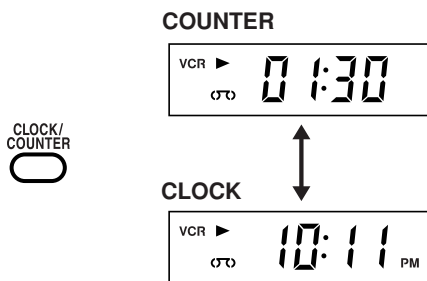

Press **DVD/VCR SELECT**. The DVD mode and the VCR mode alternate with each other in the display.

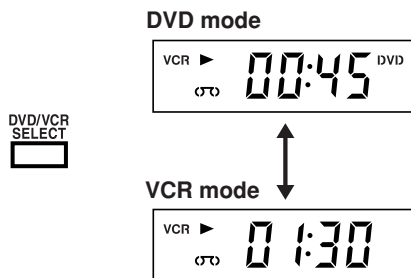

Notes:

- If you rewind the tape beyond "00:00", a minus sign ("-") will be displayed in front of the time.
- When you load a tape, the counter will reset to "00:00".
- The counter does not function on non-recorded (blank) sections of the tape. When you rewind, fast forward or play tapes through blank sections, the counter stops.

Video index search system

This function enables you to locate the beginning of any recording made on the VCR.

Recording an INDEX mark

The Index Search function automatically records an INDEX mark on the tape whenever a recording is initiated.

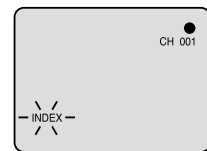

Index search

Press **VISS +** or **-** during stop or play mode.

For Succeeding programs: Press **VISS +**.

For Preceding programs: Press **VISS -**.

(As many as 9 index points can be accessed via this method.)

When the **VISS +** or **-** is pressed, the unit starts searching the selected INDEX NO. and finds the portion. Then playback starts automatically. To stop the Index Search, press **STOP**.



▶▶ or ◀◀ is displayed

INDEX NO. (up to 9)



Notes:

- When you record an INDEX mark at the very beginning of the tape, the mark may not be found.
- During INDEX search, the tape may stop and begin to play at a slightly different location.
- INDEX may not function properly with old or worn out video tapes.
- INDEX marks may not be found if it is extremely close to the point where the search began.
- During recording, if you stop recording temporarily, the INDEX mark is not recorded on the tape.

SQPB (S-VHS Quasi Playback)

You can playback video cassette tapes recorded in the S-VHS system. However, the picture will not have the high resolution of S-VHS system.

Note: You cannot record S-VHS video format with this VCR.

Recording a TV program

Recording and viewing the same TV program.

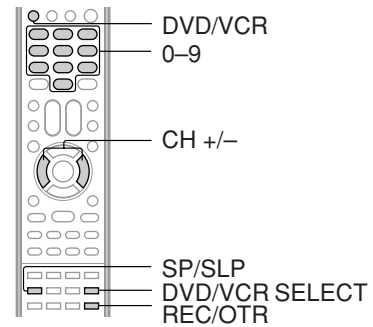

Recording a TV program

Preparation:

- Turn ON the TV and select to the corresponding video input.
- Press **DVD/VCR** to operate the DVD/VCR.
- Press **DVD/VCR SELECT** to select the VCR mode. (The VCR indicator will light.)

1 Load a cassette tape with the erase prevention tab intact.

The DVD/VCR will automatically turn on.

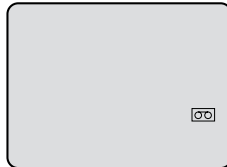
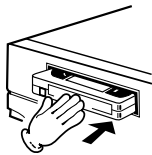

2 Press SP/SLP to select the desired tape speed SP or SLP.

The tape counter and "SP" or "SLP" will appear on the screen for about 4 seconds.

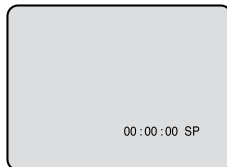

3 Select "TV" or "CABLE" to the appropriate position **32**.

TV - VHF/UHF channels
CABLE - Cable TV channels

4 Press Number buttons or CH +/- to select the channel to be recorded.

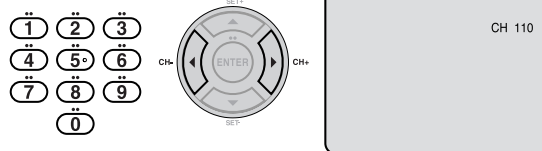

TV mode direct channel selection:

All channels can be instantly selected by using two buttons. (for example, to select channel 2, press "0", then "2". If you press only "2", channel selection will be delayed for two seconds.) For channels 10 and above, press the 2 digits in order.

CABLE mode direct channel selection:

- 1-9 Press **0** twice and then **1-9** as required.
Example: To select "2", Press **002**.
- 10-12 Press **0** first and then the remaining 2 digits in order from left to right.
Example: Press **012** for "12".
- 13-99 Press 2 digits in order.
Example: Press **22** for "22".
- 100-125 Press the 3 digits in order.
Example: Press **110** for "110".

VHF/UHF/CABLE TV CHANNELS

TV	CABLE TV
VHF 2-13	VHF 2-13
UHF 14-69	STD/HRC/IRC 14-36 (A) (W) 37-59 (AA) (WW) 60-85 (AAA) (ZZZ) 86-94 (86) (94) 95-99 (A-5) (A-1) 100-125 (100) (125) 01 (5A)

5 Press REC/OTR.

"●" will appear on the screen for about 4 seconds and "REC" will appear on the display window.

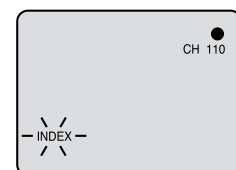



Recording a TV program (Continued)

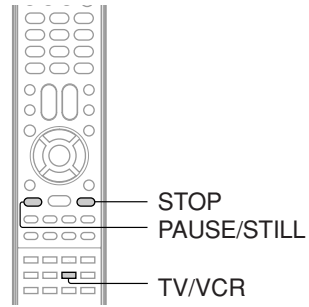

To stop recording

Press **STOP** to stop recording.

"■" will appear on screen for about 4 seconds.

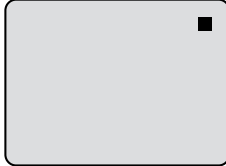

Recording one program while watching another

While the VCR is recording, select your desired channel on the TV.

When a TV is connected with an antenna cable only, press **TV/VCR** to select the TV position.

The "VCR" display will go off and recording will continue. Select the TV channel you want to watch by using the TV channel selector.

Note:

Some Cable TV hookups do not permit viewing one channel while recording another. See pages 18 and 19.

To stop recording temporarily

Press **PAUSE/STILL** to avoid recording unwanted material. Press again to continue the recording.

"●||" will appear on screen for about 4 seconds.



Notes:

- The pause function will be released after 5 minutes to prevent damage to the tape or the VCR. The VCR will change to the STOP mode.
- You can select a recording channel in the recording pause mode.

■ Auto Rewind feature

This VCR will automatically rewind the tape when the tape has ended (except during OTR and timer recording). It will also eject the tape.



One-touch Timer Recording (OTR)

The One-touch Timer Recording feature provides a simple and convenient way to make a timed recording.

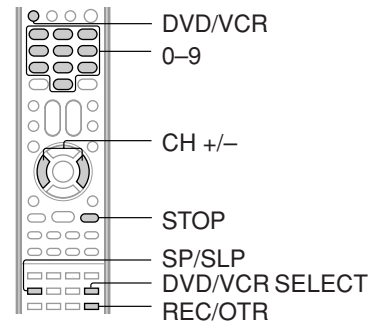

One-touch Timer Recording (OTR)

Preparation:

- Turn ON the TV and select to the corresponding video input.
- Press **DVD/VCR** to operate the DVD/VCR.
- Press **DVD/VCR SELECT** to select the VCR mode. (The VCR indicator will light.)

Example: One-touch Timer Recording for 30 minutes.

1 Load a cassette tape with the erase prevention tab intact.

The VCR will automatically turn on.

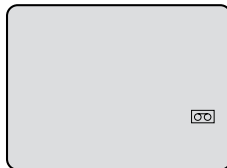
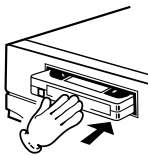

2 Press SP/SLP to select the desired tape speed SP or SLP.

The tape counter and "SP" or "SLP" will appear on the screen for about 4 seconds.

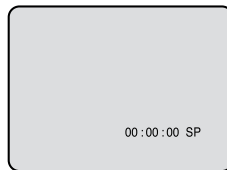

3 Set "TV" or "CABLE" option to the appropriate position 32).

TV - VHF/UHF channels
CABLE- Cable TV channels

4 Press Direct channel selection buttons (0-9) or CH +/- to select the channel to be recorded.

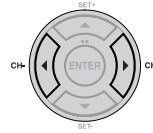
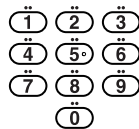

5 Press REC/OTR. Recording begins. Press the button again to stop recording after 30 minutes. Each additional press of REC/OTR will increase recording time as shown in the chart below, up to a maximum of 6 hours.

The OTR and recording time will appear on the screen for about 4 seconds. And, "●" will appear on the display.

Press	Recording time	Press	Recording time
once	NORMAL REC	6 times	3:00
twice	0:30	7 times	4:00
3 times	1:00	8 times	5:00
4 times	1:30	9 times	6:00
5 times	2:00	10 times	NORMAL REC

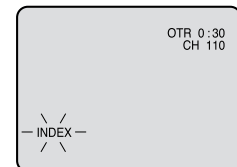

To cancel OTR

Press **STOP** or turn off the power.

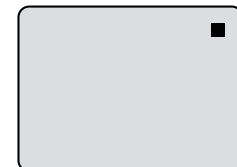

"■" will appear on screen for about 4 seconds.

Note:

If you wish to watch the DVD playback during OTR or standard recording, press **DVD/VCR SELECT** to change to DVD mode and perform the DVD playback 47).

Recording (VCR)

Timer recording

Timer recording can be programmed on-screen with the remote control. The built-in timer allows automatic unattended recording of up to 8 programs within 1 month.

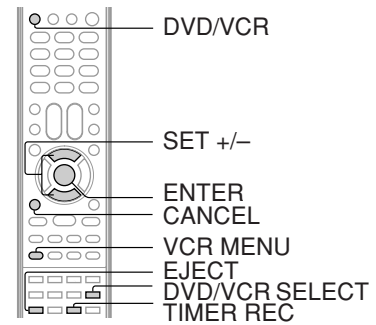

Timer recording

Preparation:

- Press **DVD/VCR** to operate the DVD/VCR.
- Press **DVD/VCR SELECT** to select the VCR mode.
- Load a cassette tape with the erase prevention tab intact.
- Check the time and date are correct [29].

Example: Program a timer recording for the 26th day, channel 125 (Cable TV), 11:00 - 11:30 PM on timer program number 1 (Tape speed: SLP).

1 Press VCR MENU. Select "TIMER REC SET", then press ENTER.

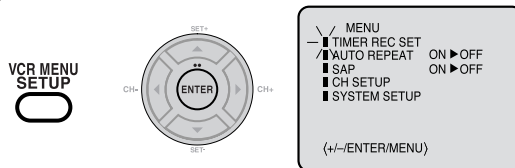

2 Press SET + or - to select one of the program line, then press ENTER.

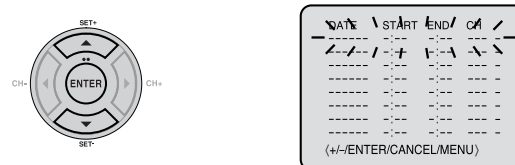

3 Press SET + or - to select the date, then press ENTER.



4 Set the start time, end time, channel and tape speed as in step 3.



Notes:

- Press **CANCEL** to move cursor backward for correction.
- To record from external source set the channel to "L1" or "L2".

5 To enter other programs, repeat steps 2 through 4.



- To return to the normal screen, press **VCR MENU** twice.

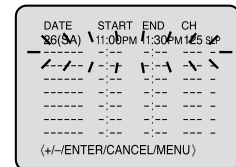

6 Press TIMER REC. The timer symbol ([]) will appear on the display and the VCR standby for recording.



At the same time, VCR mode will change to DVD mode automatically. You can use DVD even if the VCR is in the timer recording mode. If you do not use the DVD, turn the power off.

Notes:

- The timer recording will start at 5 seconds before the preset starting time.
- If the timer symbol ([]) does not appear on the display when **TIMER REC** is pressed, the cassette is not inserted [34].
- If the cassette is ejected when **TIMER REC** is pressed, the erase prevention tab of the cassette may have been removed [34].
- During Timer recording, the power cannot be turned off.

Notes:

- If the timer symbol ([]) blinks when the timer recording ended, the TV program has not been completely recorded because of an insufficient tape length. Press **TIMER REC** to cancel the timer program or press **EJECT** to remove the cassette tape.
- During timer recording standby mode, the VCR mode cannot be operated. To use the VCR, first press **TIMER REC** then press **DVD/VCR SELECT** to change to VCR mode. After VCR mode is selected, press **TIMER REC** again to put the VCR into timer recording standby mode.
- If you press **TIMER REC** during timer recording, the recording operation will be interrupted. If you press **TIMER REC** again within the programmed time, the recording operation will start again.
- After a power failure or disconnection of the power plug, all programmed recording settings and time display will be lost upon resumption of power. In this case, reset the clock [29] and reprogram any timer recording.

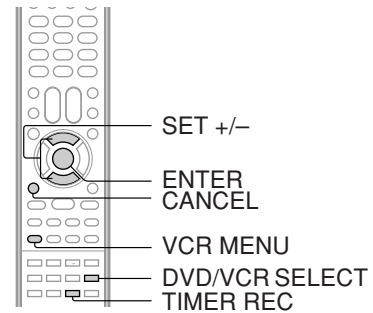

To set daily/weekly timer

Weekly (e.g. WKL-TU: each Tuesday) or daily (e.g. MO-SA: Monday to Saturday) Timer recording

Follow the procedure of timer recording on page 42. At step 3, press **SET +** or **-** repeatedly until the desired setting appears. Then press **ENTER**.

When you press **SET -** repeatedly, the DATE indicator will change as follows, in this case the day is Friday.

The current day (Friday) → SU-SA (Sunday to Saturday)

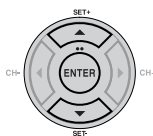
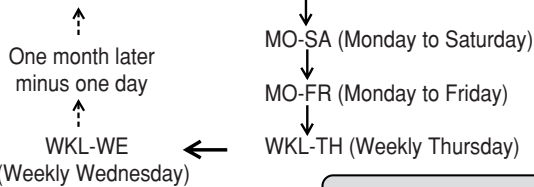

DATE	START	END	CH
WKL-WE	---	---	---
---	---	---	---
---	---	---	---
---	---	---	---
---	---	---	---
---	---	---	---
---	---	---	---
---	---	---	---
---	---	---	---

(+/-)ENTER/CANCEL/MENU

To confirm or cancel a program

1 If the Timer has been activated, press **TIMER REC** to deactivate the Timer.

The timer symbol (⏰) will disappear. Then press **DVD/VCR SELECT** to change to VCR mode.



2 To confirm Timer program:

At step 1 on page 42, select "TIMER REC SET" and press **ENTER**. The timer program list will appear on the screen.

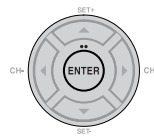

DATE	START	END	CH
26(SA)	11:00PM	11:30PM	125/P
---	---	---	---
---	---	---	---
---	---	---	---
---	---	---	---
---	---	---	---
---	---	---	---
---	---	---	---
---	---	---	---

(+/-)ENTER/CANCEL/MENU

If the programs overlap another

Do not overlap timer programs as portions of the conflicting programs will be lost. The first recording time has priority over the next recording time as shown in the diagram below.

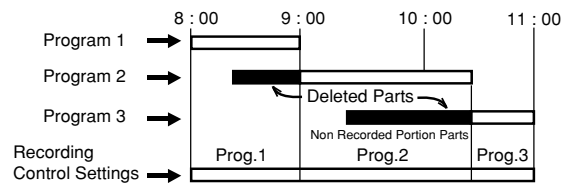

Notes:

- The daily/weekly recording can be made continuously until the recording is canceled or the tape reaches the end.
- During timer recording the automatic rewinding mechanism does not function.

3 To cancel Timer program:

Press **SET +** or **-** to select the unwanted program, then press **CANCEL** to cancel the program.

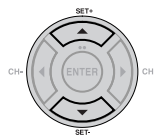

DATE	START	END	CH
---	---	---	---
---	---	---	---
---	---	---	---
---	---	---	---
---	---	---	---
---	---	---	---
---	---	---	---
---	---	---	---
---	---	---	---

(+/-)ENTER/CANCEL/MENU

4 Press **VCR MENU** repeatedly until the menu screen is cleared.



Notes:

- If there are other timer record programs remaining, **TIMER REC** must be pressed to reactivate the timer, otherwise the remaining timer record programs will be ignored.
- You cannot confirm the Timer program during timer recording operation.
- You can correct or cancel a programmed setting in program confirm mode.

Recording (VCR)

Stereo recording and playback/ Second Audio Program (SAP)

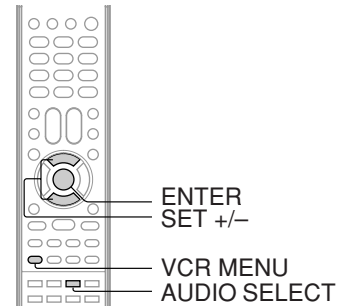

Stereo recording and playback

The VHS Hi-Fi audio system permits high fidelity recording of MTS STEREO TV broadcasts.

When a MTS STEREO broadcast is received, "STEREO" will appear on the screen for about 4 seconds and the program can be viewed or recorded in stereo. The Hi-Fi stereo recording procedure is the same as for normal recordings.

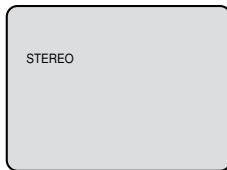

Note:

When using a Cable TV system, stereo TV programs may be transmitted over a mono cable channel. In this case "STEREO" will not appear and the sound will be in mono.



Output selection

When viewing an MTS stereo TV program, or playing a prerecorded VHS Hi-Fi stereo videotape, press **AUDIO SELECT** to select how the audio will be heard through the speakers. Normally set to the Hi-Fi stereo position, this button can be set to the MONO position if the stereo broadcast or videotape audio is of poor quality. The "R" and "L" positions allow the audio from the Right or Left Hi-Fi channel to be heard over both TV speakers. This button has no effect when viewing a MONO videotape or TV program. Each time when you press the button, OUTPUT SELECTION display appears on the screen for several seconds. Refer to the chart below.

OUTPUT SELECTION	SOUND HEARD ON BOTH SPEAKERS
STEREO	STEREO
L ch	LEFT CHANNEL AUDIO
R ch	RIGHT CHANNEL AUDIO
MONO	MONO

Second Audio Program (SAP)

Your DVD/VCR is fitted with a SAP broadcast system which enables you to switch to a second audio program when viewing a selected channel. This function applies only when the program is broadcast in multi-languages through the SAP broadcast system.

1 Press VCR MENU. Then press SET + or - to select "SAP".

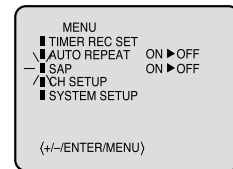
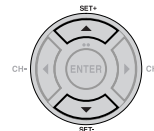

2 Press ENTER to select "ON".

Then press **VCR MENU** until the menu screen is cleared.

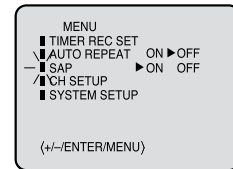
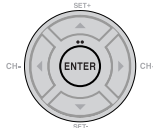

Listening to SAP

When the VCR is turned on or a channel selection is made, make certain the letters "SAP" appears on the screen for about 4 seconds. This means that the "Second Audio Program" broadcasting is available.

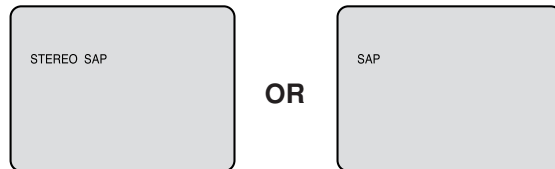

Notes:

- When playing back a tape that is not recorded in Hi-Fi stereo mode, the audio will automatically be monaural.
- When listening to a VHS Hi-Fi video tape or MTS broadcast through the VHF/UHF jack (Audio/Video cable not connected), the sound will be monaural.



Duplicating a video tape

If you connect the DVD/VCR to another VCR or Camcorder, you can duplicate a previously recorded tape. Make all connections before turning on the power.

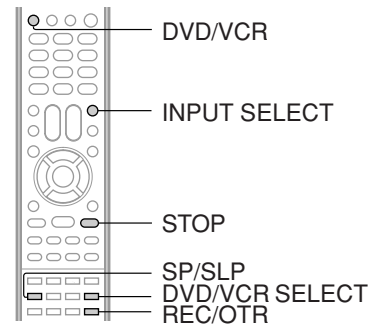

Duplicating a video tape

Preparation:

- Turn ON the TV and select the corresponding video input.
- Press **DVD/VCR** to operate the DVD/VCR.
- Press **DVD/VCR SELECT** to select the VCR mode. (The VCR indicator will light.)
- Load a cassette tape with the erase prevention tab intact.
- Load a previously recorded tape into the playback VCR or Camcorder.

1 Press SP/SLP to select the desired tape speed SP or SLP.



It is recommended to set the tape speed to the SP mode on the recording VCR for best results.

2 Press INPUT SELECT once or twice to select AUDIO/VIDEO input position.

"L1" or "L2" will appear in the display.



L1: on the rear panel
L2: on the front panel

3 Press PLAY on the playback VCR or Camcorder.

4 Press REC/OTR on the recording VCR.

The duplicating process begins.



5 Press STOP when you finish duplicating.



Connection with second VCR

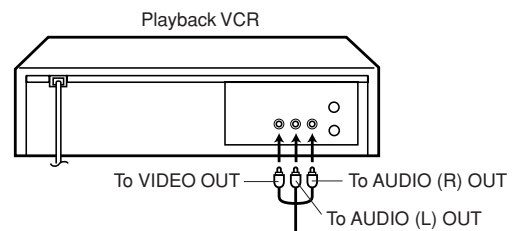

AUDIO/VIDEO cable (supplied)

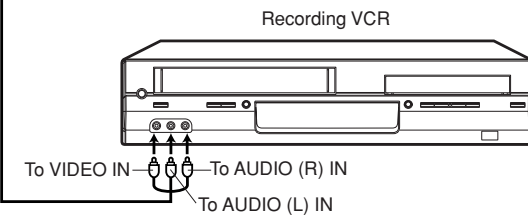

Other functions (VCR)

Connection with Camcorder

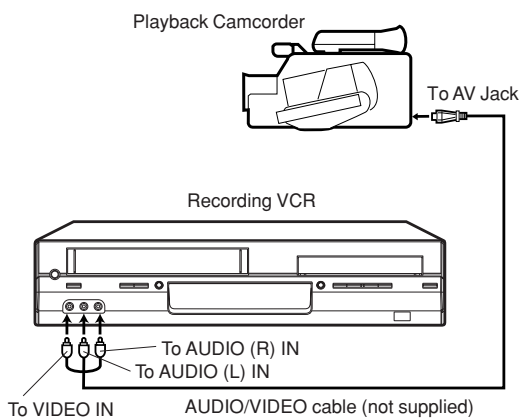

For duplicating a previously recorded tape from a camcorder, follow the camcorder manufacturer's instructions. A typical camcorder dubbing hookup is shown above.

Recording a DVD/CD disc

You can record disc material in DVD, Video CD, Audio CD, etc. onto a Video tape with this DVD/VCR.

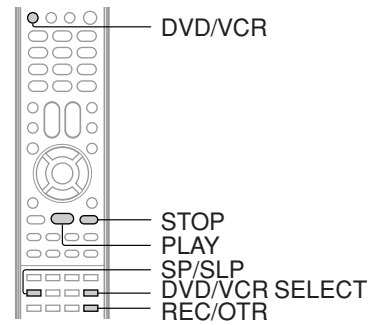

Duplicating a DVD or CD disc

Preparation:

- Turn ON the TV and select the corresponding video input.
- Press **DVD/VCR** to operate the DVD/VCR.
- Press **DVD/VCR SELECT** to select the VCR mode. (The VCR indicator will light.)
- Load a cassette tape with the erase prevention tab intact.
- Load a DVD/CD disc.

1 Press SP/SLP to select the desired tape speed SP or SLP.

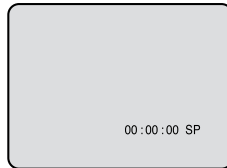

2 Press DVD/VCR SELECT selector to select the DVD mode.

The DVD indicator will light.



3 Press PLAY to start playback.



4 Press REC/OTR to start recording.

The DVD/VCR will change to the VCR mode automatically and the playback picture or sound will be duplicated on the video cassette tape.



5 Press STOP when you finish recording.

If you wish to stop a DVD/CD disc, press **DVD/VCR SELECT** selector to change the DVD mode, then press **STOP**.



Notes:

- You may not be able to record the beginning of the disc. Begin VCR recording once program playback commences on the DVD.
- When the scanning mode is set to the progressive mode, you cannot duplicate a disc material onto a video tape. When **REC/OTR** is pressed, the PROGRESSIVE indicator "P" on the display window will flash.
- When the HDMI mode is ON (480p, 720p, 1080i), you cannot duplicate a disc material onto a video tape.
- You cannot record discs encoded with copy guard function. The following icon and text will show up on the TV screen.



DISC IS COPY PROTECTED

Playing a disc

This section shows you the basics on how to play a disc.

CAUTION

Keep your fingers well clear of the disc tray as it is closing. Neglecting to do so may cause serious personal injury.

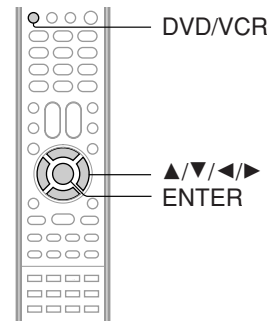
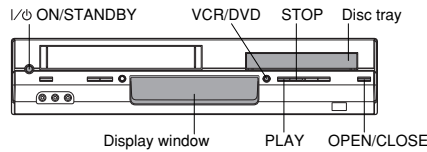

DVD VCR CD Basic playback

Preparations:

- When you want to view a disc, turn on the TV and select the corresponding video input connected to the DVD/VCR. This may include S-video or component video inputs which are exclusive to DVD playback.
- When you want to enjoy the sound of discs from the audio system, turn on the audio system and select the input connected to the DVD/VCR.

1 Press DVD/VCR on the remote control to operate the DVD/VCR.

DVD/VCR



2 Press I/ON/STANDBY.

I/ON/STANDBY



The DVD/VCR turns on.

3 Press VCR/DVD on the unit to select the DVD mode.

VCR/DVD



The DVD indicator will light.

DVD

4 Press OPEN/CLOSE.

The disc tray opens.

OPEN/CLOSE



5 Place the disc on the disc tray.

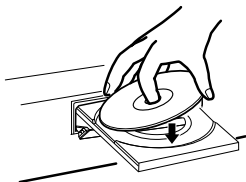

With the playback side down

- There are two different disc sizes. Place the disc in the correct guide on the disc tray. If the disc is out of the guide, it may damage the disc and cause the DVD/VCR to malfunction.
- Do not place a disc which is unplayable in this DVD/VCR.

6 Press OPEN/CLOSE or PLAY on the unit.

OPEN/CLOSE



PLAY



The disc tray closes automatically. On the TV-screen, "▲" changes to "Reading" and then playback commences.

- A menu screen will appear on the TV screen, if the disc has a menu feature.



7 Press ▲/▼ or ◀/▶ to select title.

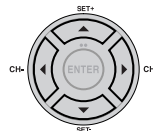

8 Press ENTER.

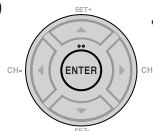

- Title is selected and play commences.

9 Press STOP to end playback.

STOP



- The unit records the stopped point, depending on the disc. "■" appears on the screen. Press **PLAY** to resume playback (from the scene point).
- If you press **STOP** again or unload the disc ("■" appears on the screen.), the unit will clear the stopped point.

■ To start playback in the stop mode

Press **PLAY**.

PLAY



Basic playback (DVD)

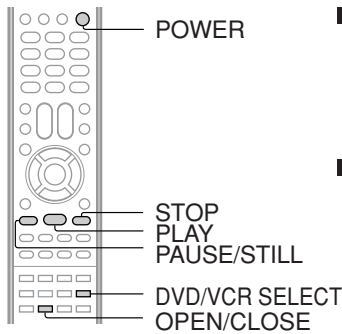

■ To obtain a higher quality picture

Occasionally, some picture noise not usually visible on the TV screen during a normal broadcast may appear while playing a DVD video disc. It is because due to high resolution pictures on these discs which include a lot of information. The amount of noise depends on the disc you use with this unit. You should generally reduce the sharpness adjustment on your TV when viewing DVD video discs.

■ About

The icons on the heading bar show the playable discs for the function described under that heading.

: You can use this function with DVD video discs.

: You can use this function with Video CDs.

: You can use this function with Audio CDs and CD-R/RW CDs.

: You can use this function with USB Mass Storage.

Basic playback

■ To pause playback (still mode)

Press **PAUSE/STILL** during playback.



To resume normal playback, press **PLAY**.

- The sound is muted during still mode.

■ To stop playback

Press **STOP**.



■ To remove the disc

Press **OPEN/CLOSE**.



Remove the disc after the disc tray opens completely.

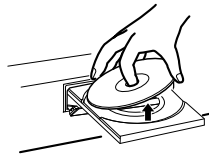

■ Playing a Disc while the VCR section is recording or standing by for timer recording

- 1) Start to record.
Follow steps 1~5 on page [39](#).
 - If the DVD/VCR is standing by for recording, turn on the DVD/VCR.
- 2) Press **DVD/VCR SELECT** selector to select DVD mode.
- 3) Play a disc.
Follow steps 4 ~ 6 on page [47](#).
 - Press **PLAY** if the DVD/VCR does not start to play a disc automatically.
- 4) Stop to play.
Press **STOP** to stop play back a disc.

■ Screen saver function

The screen saver operates when you leave the unit in DVD stop mode for approx. five minutes. The screen will repeatedly get dark gradually and back to normal. Please press any button when you want to return to an usual screen. To turn on or off the screen saver, see page [66](#).

Be sure to press **OPEN/CLOSE** to close the disc tray after you remove the disc.

Notes:

- If a non-compatible disc is loaded, "Incorrect Disc", "Region Code Error" or "Parental Error" will appear on the TV screen according to the type of loaded disc. In this case, check your disc again [7](#) [70](#).
- Some discs may take a minute or so to start playback.
- When you set a single-faced disc label downwards (i.e. the wrong way up) and press **OPEN/CLOSE** or **PLAY** on the unit, "Reading" will appear on the display for a few minutes and then "Incorrect Disc" will continue to be displayed.
- Some discs may not work the resuming facility.
- Resuming cannot function when you play a PBC-featured Video CD while the PBC is on. To turn off the PBC, see page [56](#).
- Some playback operations of DVDs may be intentionally fixed by software producers. Since this unit plays DVDs according to the disc contents the software producers designed, some playback features may not be available. Also refer to the instructions supplied with the DVDs.
- Do not move the unit during playback. Doing so may damage the disc.
- Use the **OPEN/CLOSE** to open and close the disc tray. Do not push the disc tray while it is moving. Doing so may cause the unit to malfunction.
- Do not push up on the disc tray or put any objects other than discs on the disc tray. Doing so may cause the unit to malfunction.
- In many instances, a menu screen will appear after playback of a movie is completed. Prolonged display of an on-screen menu may damage your television set, permanently etching that image onto its screen. To avoid this, be sure to press **POWER** on your remote control once the movie is completed.
- There may be a slight delay between the button is pressed and the function activates.
- The screen saver does not operate when connecting this DVD/VCR to the TV using the HDMI cable.



Playing a disc (Continued)

You can play discs at various speeds.

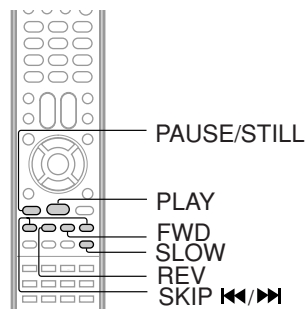

DVD VCD CD Playing in fast reverse or fast forward directions

Press **REV** or **FWD** during playback.

REV **FWD** **REV**: Fast reverse playback
FWD: Fast forward playback

Each time you press **REV** or **FWD**, the playback speed changes.

■ **To resume normal playback**
 Press **PLAY**.



Notes:

- The DVD/VCR mutes sound and subtitles during reverse and forward scan of DVD/VCD video discs. However, this unit plays sound during fast forward or fast reverse play of audio CDs.
- The playback speed may differ depending on the disc.

DVD VCD Playing frame by frame

Press **PAUSE/STILL** during still playback.

PAUSE/STILL Each time you press **PAUSE/STILL**, the picture advances one frame.

■ **To resume normal playback**
 Press **PLAY**.



Note:
 The sound is muted during frame by frame playback.

DVD VCD Playing in slow-motion

Press **SLOW** during playback.

SLOW Each time you press the button, the slow-motion speed changes.

■ **To resume normal playback**
 Press **PLAY**.



Note:
 The sound is muted during slow-motion playback.

DVD VCD CD Locating a chapter or track

Press **SKIP** or repeatedly to display the chapter or track number you want. Playback starts from the selected chapter or track.

<p>SKIP/VISS+ To locate succeeding chapters or tracks.</p> <p></p>	<p>SKIP/VISS- Playback starts from the beginning of the current chapter or track. When you press twice in quick successions, playback starts from the beginning of the preceding chapter or track.</p> <p></p>
--	--

Notes:

- A prohibition symbol "X" may appear at the upper right of the screen. This symbol means either the feature you tried is not available on the disc, or the DVD/VCR cannot access the feature at this time. This does not indicate a problem with the DVD/VCR.
- The unit is capable of holding a still video image or On screen display image on your television screen indefinitely. If you leave the still video image or On screen display image displayed on your TV for an extended period of time, you risk permanent damage to your television screen. Projection televisions are very susceptible.



Zooming/Locating desired scene

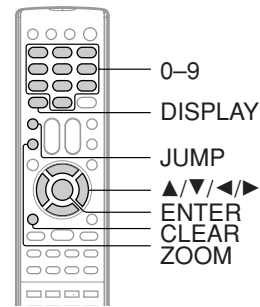

DVD VCD CD Zooming

This unit will allow you to zoom in on the frame image. You can then make selections by switching the position of the frame.

1 Press ZOOM during playback.



The center part of the image will be zoomed in. Each press of **ZOOM** will change the ZOOM Q1 (x 1.3), Q2 (x 1.5) and Q3 (x 2.0).

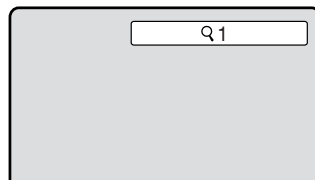

2 Press ▲/▼/◀/▶ to view a different part of the frame.

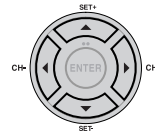

You may move the frame from the center position to UP, DOWN, LEFT or RIGHT direction.

3 In the zoom mode, press ZOOM repeatedly to return to a 1:1 view (Q Off).



Notes:

- You can select the Pause, Slow or Search playback in the zoom mode.
- Some discs may not respond to zoom feature.

DVD VCD CD Locating desired scene

Use the title, chapter and time recorded on the DVD disc to locate the desired point to play back. In the case of VCD/CD discs, time and track are used to locate the desired point to play back. To check the title, chapter and time, press **DISPLAY**.

1 Press JUMP during playback or resume stop mode.

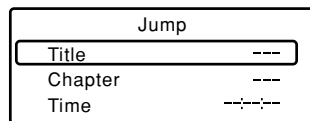

2 Press ▲ or ▼ to select the "Title/Track", "Chapter" or "Time".

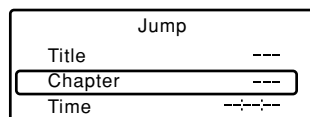
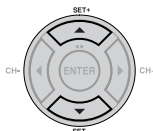

3 Press Number buttons (0-9) to change the number.

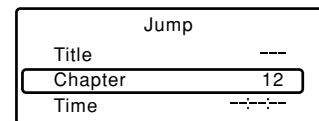
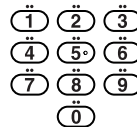

- If you input a wrong number, press **CLEAR**.
- Refer to the package supplied with the disc to check the numbers.

4 Press ENTER. Playback starts.

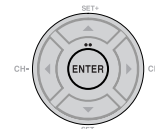

- When you change the title, playback starts from Chapter 1 of the selected title.
- Some discs may not work in the above operation.



Marking desired scenes

The unit stores the points that you want to watch again up to 3 points. You can resume playback from each scene.

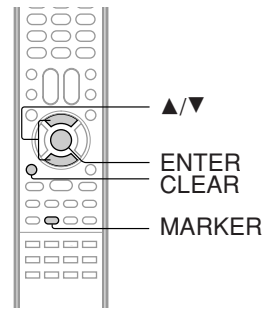

DVD VCD **Marking the scenes**

- 1 Press MARKER during playback.**

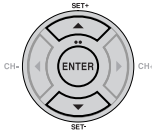
Marker1	-- : -- : --
Marker2	-- : -- : --
Marker3	-- : -- : --
- 2 Select the blank Marker using ▲ or ▼. Then press ENTER at the desired scene.**
 - Repeat this procedure to set the other 2 scenes.

Marker1	00 : 27 : 54
Marker2	-- : -- : --
Marker3	-- : -- : --
- 3 Press MARKER to clear this display.**

DVD VCD **Returning to the scenes**

- 1 Press MARKER during playback or stop mode.**

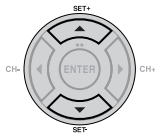
Marker1	00 : 27 : 54
Marker2	01 : 16 : 25
Marker3	02 : 08 : 31
- 2 Press ▲ or ▼ to select the Marker 1-3.**

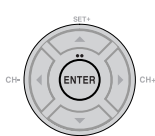
Marker1	00 : 27 : 54
Marker2	01 : 16 : 25
Marker3	02 : 08 : 31
- 3 Press ENTER.**

Playback starts from the marked scene.

■ **To cancel the Marker**
Follow the above steps 1~2, then press **CLEAR**.

Notes:

- Some discs may not work with the marking operation.
- The marking is canceled when you open the disc tray or turn the power off.
- Some subtitles recorded around the marker may fail to appear.
- In case of Video CD with PBC, Marker function is prohibited.

Advanced playback (DVD)

Repeat playback/A-B Repeat playback

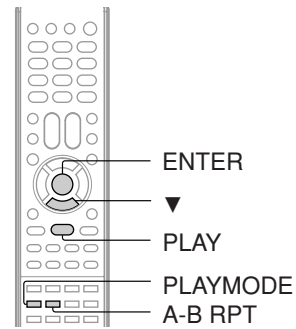

DVD VCD Repeat playback

- 1 Press PLAYMODE during playback or stop mode.**
- 2 [DVD] Press ENTER to select "Chapter" or "Title".**

The unit automatically starts repeat playback after finishing the current title or chapter.

[Video CD]
 Press **▼** to select "Repeat".
 Press **ENTER** to select "Track" or "All".

The unit automatically starts repeat playback after finishing the current track.

 - If you set the repeat mode during stop mode, press **PLAY** to start Repeat playback.

[Audio CD and MP3/WMA CD]
 Please see "Repeat playback (CD/USB)" **[61]**.
- 3 Press PLAYMODE again to clear the screen.**

■ To resume normal playback
 Select Repeat : "Off" in step 2.

- Notes:**
- Some discs may not work with the repeat operation.
 - In case of Video CD with PBC, repeat functions are prohibited during playback.
 - Chapter/Track repeat function is canceled whenever **SKIP** **◀◀** or **▶▶** is pressed.

DVD VCD CD A-B Repeat playback

A-B repeat playback allows you to repeat material between two selected points.

- 1 Press A-B RPT during playback.**

The start point is selected.
- 2 Press A-B RPT again.**

The end point is selected. Playback starts at the point that you selected. Playback stops at the end point, returns to Point A automatically, then starts again.

■ To resume normal playback
 Press **A-B RPT** again.

"Off" appears on the screen.

- Notes:**
- In A-B Repeat mode, subtitles near the A or B locations may not be displayed.
 - You cannot set the A-B Repeat for the scenes that include multiple angles.
 - A-B Repeat playback does not work when Repeat playback is activated.
 - You may not be able to set A-B Repeat, during certain scenes of the DVD.
 - A-B Repeat does not work with an interactive DVD, MP3/WMA/JPEG/DivX® CD.
 - A-B Repeat is prohibited when PBC is on.

Program playback/Random playback

You can arrange the playback order of tracks or files on the disc. And the unit can also select tracks or files at random and playback them. These feature works for Video CD.

For Audio CD and MP3/WMA CD, please see "Random playback (CD/USB)" **[61]** and "Program playback (CD/USB)" **[62]**.

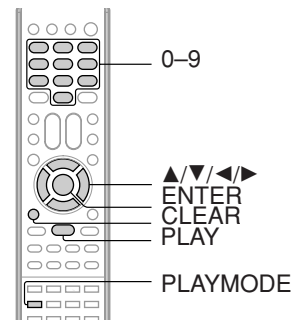

VCD Program playback

1 Press PLAYMODE during stop mode.

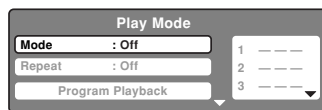

2 Press ▲/▼ to select "Mode", then press ENTER to select "Program".

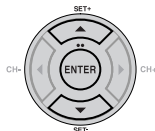

3 Press ◀/▶ to select the right column, then use Number buttons (0-9) to input the track numbers.

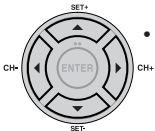

• If you input a wrong number, press **CLEAR**.

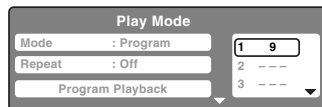
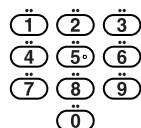

4 Press ◀/▶ to return to the left column, then press ▲/▼ to select the "Program Playback" and press ENTER.

The programs you selected will start to playback in the order.

- To resume normal playback, select Mode "Off" in step 2.

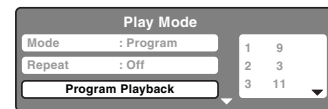
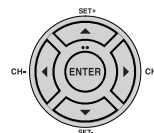

■ To change the program

1. Select Mode to "Program" (as step 2), press ◀/▶/▲/▼ to select the track number you want to change, then press **CLEAR**.
2. Press **Number buttons (0-9)** to overwrite the new track number.

■ To clear the program one by one

Select Mode to "Program", press ◀/▶/▲/▼ to select the track number. Then press **CLEAR**.

■ To clear all the programs

In the left column, press ▲/▼ to select "Clear Program". Then press **ENTER**.

Notes:

- In playing back the Video CD with PBC, you cannot set Program playback.
- The program is canceled when you open the disc tray or turn the power off.

VCD Random playback

1 Press PLAYMODE during playback or stop mode.



2 Press ▲/▼ to select "Mode", then press ENTER to select "Random".

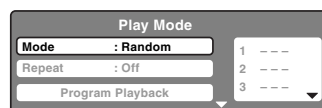
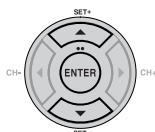

3 Press PLAY.



The Random Playback will start.

- If you set "Random" during playback mode, Random playback will begin after the track that is currently being played has ended.
- To resume normal playback, select Mode "Off" in step 2.

Note:

In playing back the Video CD with PBC, you cannot set Random playback.

Changing angles/Title selection/DVD menu

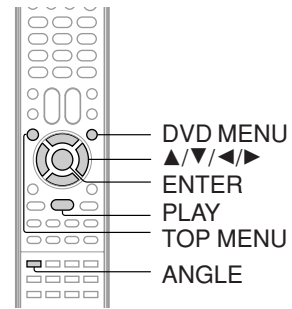

DVD Changing angles

When playing back a disc recorded with multi-angle facility, you can change the angle that you are viewing the scene from.

1 Press ANGLE during playback.

The current angle will appear.

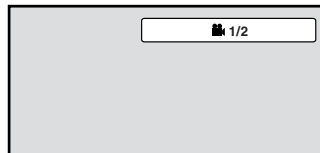

2 Press ANGLE repeatedly until the desired angle is selected.



Note:

Depending on the DVD, you may not be able to change the angles even if multi-angles are recorded on the DVD.

DVD Title selection

Two or more titles are recorded on some discs. If the title menu is recorded on the disc, you can select the desired title.

1 Press TOP MENU during playback.

Title menu appears on the screen.



2 Press ▲/▼/◀/▶ to select the desired title.

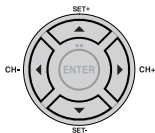

3 Press ENTER or PLAY.

The playback of the selected title will start.

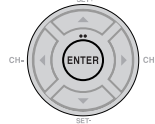

Note:

Depending on the DVD, you may not be able to select the title. Depending on the DVD, a "title menu" may simply be called a "menu" or "title" in the instructions supplied with the disc.

DVD DVD menu

Some DVDs allow you to select the disc contents using the menu.

When you play back these DVDs, you can select the subtitle language and sound-track language, etc. using the menu.

1 Press DVD MENU during playback.

The DVD menu appears on the screen.

- Press **DVD MENU** again to resume playback at the scene when you press **DVD MENU**.



2 Press ▲/▼/◀/▶ to select the desired item.

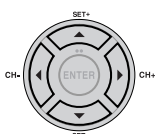

3 Press ENTER.

The menu continues to another screen. Repeat steps 2 and 3 to set the item completely.

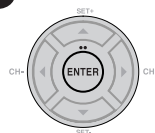

Note:

Depending on the DVD, you may not be able to resume playback from the scene point when you press **DVD MENU**.



Changing soundtrack language/ Setting surround sound

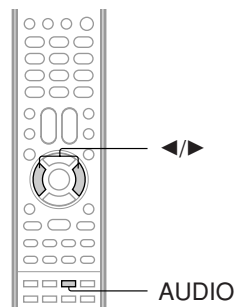

Changing soundtrack language

You can select the language when you play a multilingual disc.

1 Press AUDIO during playback.



The current soundtrack language will appear.

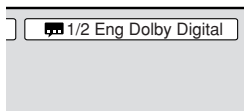

2 Press AUDIO repeatedly until the desired language is selected.

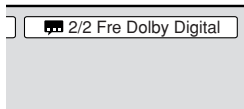

- The on screen display will disappear after a few seconds.

■ In case of Video CD playback

Audio type changes as follows each time you press AUDIO.



Notes:

- If the desired language is not heard after pressing the button several times, the language is not recorded on the disc.
- Changing soundtrack language is canceled when you open the disc tray. The initial default language or available language will be heard if the disc is played back again.

Setting surround sound

This DVD video player equipped with a "QSound". It can produce the effect of being in a cinema or a concert hall.

1 During disc playback press AUDIO.

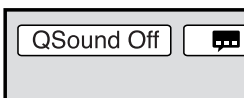

2 Press ◀ or ▶ to select "On".

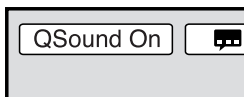
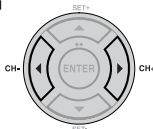

- The on screen display will disappear after a few seconds.

■ To cancel Surround mode:

Follow the left steps 1~2, then press ◀ or ▶ to select the "Off" position.

Notes:

- The QSound setting can also be changed in the function setting [67].
- The "QSound" works only when the DVD disc recorded with Dolby Digital is played back.
- When this function works, the volume might changed.
- When the voice is distorted, turn off QSound.



Manufactured under license from QSound Labs, Inc. U.S. patent Nos. 5,105,462, 5,208,860 and 5,440,638 and various foreign counterpart. Copyright QSound Labs, Inc. 1998-2002. QXpander™ is a trademark of QSound Labs, Inc. All rights reserved.

Advanced playback (DVD)

Subtitles/To turn off the PBC

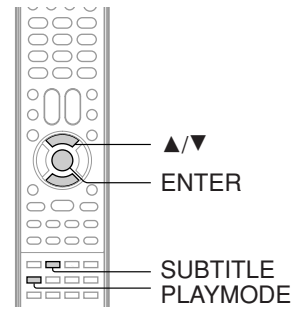

DVD Subtitles

When playing back a disc recorded with subtitles, you can select the subtitle language or turn the subtitle off.

1 Press **SUBTITLE** repeatedly during playback until your desired language appears.

2 To turn off the subtitle, press **SUBTITLE** until "Off" appears.

- The on screen display will disappear after a few seconds.

Notes:

- Depending on the DVD, you may not be able to change subtitles, or to turn subtitles on or off.
- While playing a DVD, the subtitle may change when you open or close the disc tray.
- In some cases, a selected subtitle language may not be changed immediately.

VCD To turn off the PBC (see page 8)

1 Press **PLAYMODE** in the stop mode.

2 Press **▲/▼** to select "Mode", then press **ENTER** repeatedly until "Off" appear.

3 Press **PLAYMODE** again to clear the screen.

■ To turn on the PBC

Follow the above steps 1~2, then press **ENTER** repeatedly until "PBC" appear.



MP3/WMA/JPEG/DivX[®] and Audio CD operation

This player can playback the MP3/WMA/JPEG/DivX[®]-data which has been recorded on CD-R/RW or USB Mass Storage. To produce the MP3/WMA/JPEG/DivX[®]-data, you need a Windows-PC with CD-RW drive or USB memory device and a MP3/WMA/JPEG/DivX[®]-encoding Software (not supplied). The Apple-HFS-System cannot be played.

This player requires discs/recordings to meet certain technical standards in order to achieve optimal playback quality. There are many different types of recordable disc formats (including CD-R containing MP3/WMA files). Not all recordable discs will produce optimal playback quality. The technical criteria set forth in this owner's manual are meant only as a guide. Use of CD-RW for MP3 files is not recommended.

You must obtain any required permission from copyright owners to download or use copyrighted content. Toshiba cannot and does not grant such permission.

MP3/WMA/JPEG/DivX[®] - data information

Limitations on MP3/WMA/JPEG/DivX[®] playback

- MP3/WMA/JPEG/DivX[®] CD/USB Mass Storage are standardized by ISO9660, its file name must include following extensions; ".mp3", ".wma", ".jpg", ".div", ".divx", ".avi".
- MP3/WMA/JPEG/DivX[®] CD/USB Mass Storage must be correspond to the ISO standardized files.
- This unit can read 600 files per disc. If one directory has more than 600 files, it reads up to 600 files, the remaining files will be omitted. (In case of USB Mass Storage, this limitation becomes 2,000 files).
- The unit is able to recognize up to a maximum of 50 directories per disc or USB Mass Storage.
- MP3/WMA/JPEG/DivX[®] CDs/USB Mass Storage cannot be used for the purpose of recording.
- If the CD/USB Mass Storage has both audio tracks and MP3/WMA/JPEG/DivX[®] files, only audio tracks are played.
- It may take more than one minute for this unit to read MP3/WMA/JPEG/DivX[®] files depending on its structure.
- Music recorded by "Joliet Recording Specification" can be played back, the file name is displayed (within 15 letters) on the screen. Long file names will be condensed.
- The music files recorded by "Hierarchical File System" (HFS) cannot be played.

Limitations on display.

- The maximum number for display is 15 letters.
Available characters for display are the following:
capital or small alphabets of A through Z, numbers of 0 through 9, and _ (under score).
- Other characters than those above are replaced in hyphen.

Notes on MP3/WMA/JPEG/DivX[®] files

To playback MP3/WMA/JPEG/DivX[®] CD/USB Mass Storage in the recorded order,

1. Use MP3/WMA/JPEG/DivX[®] software that records data alphabetically or numerically.
2. Insert two or three digit number in the head of file name. (ex. "01" "02" or "001" "002").
3. Refrain from making too many sub-folders.

CAUTION:

- Some MP3/WMA/JPEG/DivX[®] CDs/USB Mass Storage cannot be played back depending on the recording conditions.
- The CD-R/RW or USB Mass Storage that has no music data or non MP3/WMA/JPEG/DivX[®] files cannot be played back.

Standard sampling frequency, and the bit rate:

MP3

MPEG-1 Audio

32kHz, 44.1kHz, 48kHz

32kbps ~ 320kbps (constant bit rate or variable bit rate)

The recommend recording setting for a high-quality sound is 44.1kHz of sampling frequency and 128kbps of constant bit rate.

WMA

WMA version 7 and 8

32kHz/48kbps, 44.1kHz/48kbps~192kbps, 48kHz/128kbps~192kbps

The file recorded by mono, 48kHz, 48 kbps is not available to this unit.

DivX[®] video

DivX[®] version: DivX[®] 3, 4, 5, and 6 (specifically 3.1.1, 4.1.2, 5.0.2, 5.0.5, 5.1.1, 5.2.1, 6.0 at Home Theater profile).

Audio format: MPEG1 Layer2 (MP2), MPEG1 Layer3 (MP3)

Sampling frequencies: 32kHz, 44.1kHz, 48kHz

Bit rate: 32kbps ~ 320kbps

Resolution: Max 720 x 576 (at 25fps), Max 720 x 480 (at 30fps)

Microsoft, Windows Media, and Windows Logo are either registered trademarks or trademarks of Microsoft Corporation in the United States and/or other countries.

DivX, DivX Certified, and associated logos are trade marks of DivX, Inc. and are used under license.

Advanced playback (DVD)

MP3/WMA/JPEG/DivX® and Audio CD operation (Continued)

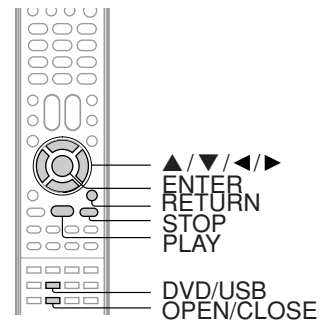

CD/USB Loading media

1 [MP3/WMA/JPEG/DivX® CD, Audio CD]
Place a MP3/WMA/JPEG/DivX® CD or an Audio CD onto the disc tray, then press OPEN/CLOSE.
[USB Mass Storage]
Connect USB Mass Storage to the USB port on the front of the unit (see page 26).



2 Press DVD/USB to display the media selection window. Press ◀ or ▶ to select the DISC mode or the USB mode, then press ENTER.

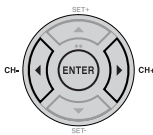

You cannot select the mode if DISC/USB media is not inserted.

3 A file browser screen will be appear on the screen.

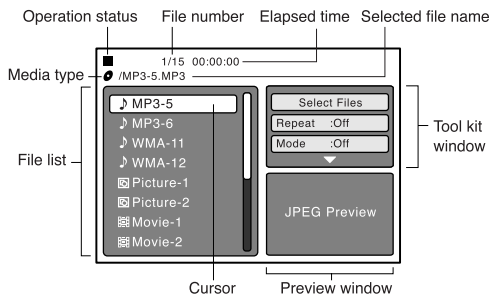

- Media type**
 - : CD-R/RW or Audio CD
 - 🔌 : USB Mass Storage
- File type**
 - 🎵 : Indicates Music file (Audio/MP3/WMA)
 - 🖼️ : Indicates Picture file (JPEG)
 - 🎬 : Indicates Movie file (DivX®/video)

- In case the current directory includes 9 files or more, press ▲ or ▼ to scroll in the file list.
- To see contents in folder, select the folder and then press ENTER. To return to the upstairs directory, select "Go Up ..." then press ENTER.
- In case of a CD/USB Mass Storage containing a mixture of MP3, WMA, JPEG and DivX® files, the files are played back by selecting them from the file browser.

CD/USB MP3/WMA and Audio CD playback

1 In the file browser, press ▲/▼ to select the desired file.

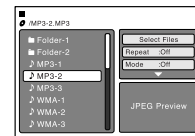
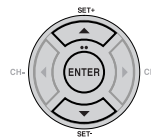

When **PLAY** is pressed after the file browser displayed, playback begins automatically starting from the first file. In this case, if the first file is an MP3/WMA file, only MP3/WMA files are played back in order. If the first file is a JPEG file, the first JPEG file is played back. If the first file is a DivX® file, the first DivX® file is played back. If there is no file at a root directory, playback does not begin automatically.

2 Press ENTER. The selected file starts playing back.

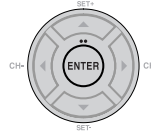

3 Press STOP to end playback.



- The unit records the stopped point. "■" appears on the screen. Press **PLAY** to resume playback (from the scene point).
- If you press **STOP** again or unload the disc, the unit will clear the stopped point.

Notes:

- MP3 or WMA file on the Kodak Picture CD is not recognized on this unit.
- During MP3/WMA/JPEG-Playback, you cannot use Jump and A-B Repeat functions.
- You can use Repeat (Track or All), Random functions and Program playback for MP3/WMA/JPEG/DivX®-Playback [61], [62].
- At USB mode with no disc on the tray, you can move to DISC mode when you press **OPEN/CLOSE** on the remote control.

Select Files

The file type to make it display in the file browser can be chosen.

- Press ◀ or ▶ to highlight "Select Files" at right column in the file browser.
- Press ENTER, then press ▲ or ▼ to select file type from the list (Music, Picture or Movie).
- Press ENTER to add/remove check mark. Checked file type will be displayed in the file browser.
- Press RETURN to save the setting.

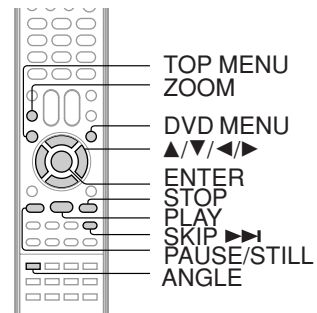

CD/USB JPEG playback

- In the file browser, press ▲/▼ to select the desired JPEG file.**
To display a thumbnail list, press **DVD MENU**. Press ◀/▶ or ▲/▼ to select the desired file. (To return to a file browser, press **TOP MENU**.)

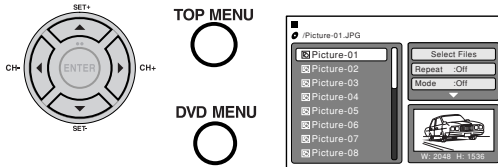

When **PLAY** is pressed after displaying the file browser, playback begins automatically starting from the first file. In this case, if the first file is a JPEG file, the first JPEG file is played back. If the first file is a DivX® file, the first DivX® file is played back. If the first file is an MP3/WMA file, only MP3/WMA files are played back in order. If there is no file at a root directory, playback does not begin automatically.

- Press ENTER. The selected picture appears on the screen.**



Rotating an image

You can rotate an image by 90 degrees by pressing **ANGLE** during playback of the image.

“”, “”, “” or “” appears on the screen.

Zooming an image

Zoom function **also** can be used in viewing JPEG files. Press **ZOOM** (See “Zooming” [50](#)).

- Press STOP to end playback.**
The file browser appears on the screen. If you want to watch the other file, repeat steps 1 ~ 2.



CD/USB Slide show playback

The slide show enables you to view pictures (files) one after another automatically.

Preparation:

Set “JPEG Interval” setting to “5 Seconds”, “10 Seconds” or “15 Seconds” [66](#).

- Select your desired starting file for the slide show in step 1 on the left.**
- Press ENTER or PLAY to start slide show from the selected file.**

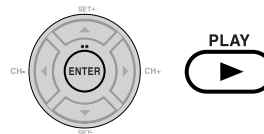

- If you press **PAUSE/STILL** during the slide show, the slide show stops temporary. “” appears briefly on the screen. If the picture appears upside down or sideways, press **ANGLE** repeatedly until it's right side up. Press **PLAY** or **SKIP** again to resume the slide show.
- When the slide show playback finished, the file list appears.
- To stop the slide show, press **STOP**. The file list appears.

Notes:

- If the DVD/VCR is connected to a HDTV using HDMI, you can display the HD resolution JPEG images (720p or 1080i). See “HD Jpeg” on page [68](#).
- During JPEG playback, you cannot use Jump and A-B Repeat functions.

MP3/WMA/JPEG/DivX® and Audio CD operation (Continued)

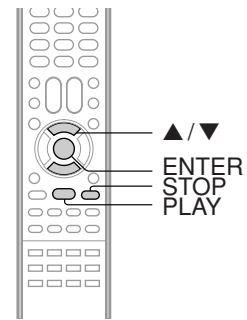

CD USB DivX® playback

1 Press ▲/▼ to select desired DivX® file.

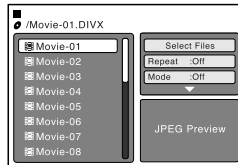
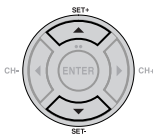

When **PLAY** has been pressed after displaying the file browser, playback begins automatically starting from the first file. In this case, if the first file is a JPEG file, the first JPEG file is played back. If the first file is a DivX® file, the first DivX® file is played back. If the first file is an MP3/WMA file, only MP3/WMA file are played back in order. If there is no file at a root directory, playback does not begin automatically.

2 Press **ENTER** or **PLAY**. The selected DivX® movie will be played back on the screen.

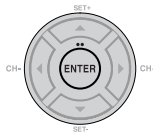

3 Press **STOP** to end playback. The file browser appears on the screen. If you want to watch the other file, repeat steps 1 ~ 2.



CD Playing DivX® VOD content

DivX® VOD content is protected by DRM (Digital Rights Management) system. This restricts playback of content to specific registered devices.

If the incorrect DRM file is loaded, "Authorization Error This player is not authorized to play this video." will appear on the screen.

When you attempt to play DivX® VOD, the number of plays is limited and the right message will appear on the screen. If you wish to play it, select "YES".

View DivX® VOD Rental
This rental has 5 views left.
Do you want to use one
of your 5 views now?

- If the number of plays goes over the limit, then "Rental Expired" will be displayed, in this case the file will not be played.

Notes:

- In order to play DivX® VOD content on this unit, you first need to register the unit with registration code. See page 69.
- This unit cannot playback the DivX® VOD content on the USB Mass Storage.

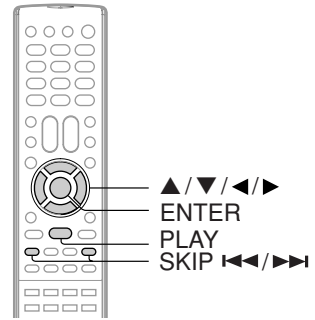

Repeat playback (CD/USB)

1 In the file browser, press ◀/▶ or ▲/▼ to select "Repeat" during stop mode.

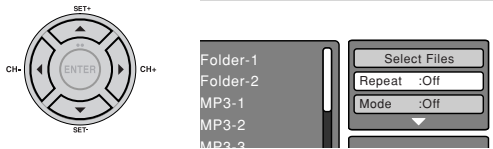

2 Press ENTER to select "Track" or "All".

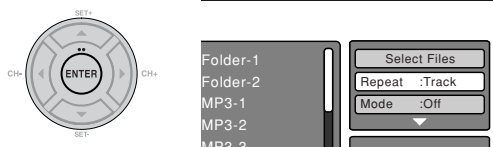

3 Press PLAY.



The unit automatically starts repeat playback after finishing the current track.

■ To resume normal playback

Select Repeat : "Off" in step 2.

Notes:

- The program is canceled when you open the disc tray or turn the power off.
- In case of Audio CD, the function of A-B Repeat can be used. See "A-B Repeat playback" (52).
- Track repeat function is canceled whenever SKIP ◀◀ or ▶▶ is pressed.

Random playback (CD/USB)

1 In the file browser, press ◀/▶ or ▲/▼ to select "Mode" during stop mode.

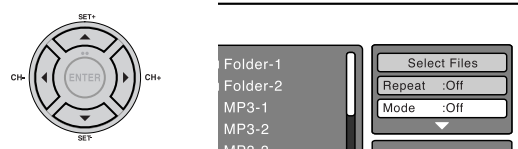

2 Press ENTER to select "Random".



3 Press PLAY.



The Random playback will start.

■ To resume normal playback

Select Mode : "Off" in step 2.

Advanced playback (DVD)

MP3/WMA/JPEG/DivX® and Audio CD operation (Continued)

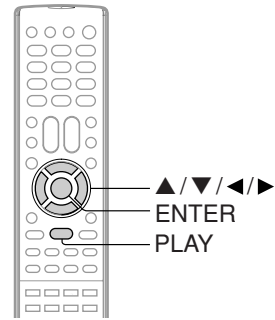

Program playback (CD/USB)

1 In the file browser, press **◀/▶** or **▲/▼** to select “Edit Mode”, then press **ENTER**.

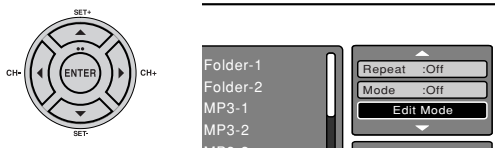

When “Edit Mode” is black color, you can mark the files which you want to add into Program list.

2 Press **◀/▶** or **▲/▼** to select the file you want to add into the program list.

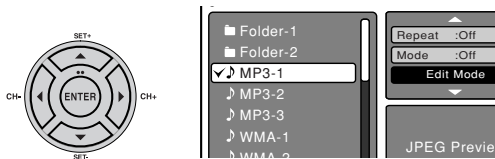

Press **ENTER**. Selected file was marked.
Repeat this procedure to select the other files.

3 Press **◀/▶** or **▲/▼** to select “Add To Program”. Then press **ENTER**. All marked files are added into the program list.



•When you finish storing all the files you want into the Program list, select “Edit Mode” again and press **ENTER** to release edit mode.

4 Press **▲/▼** to select “Program View”, then press **ENTER**. Program View shows only the programmed files that you have added in Step 2.

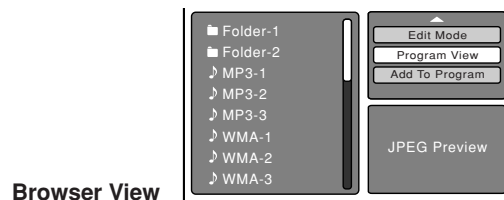

Browser View

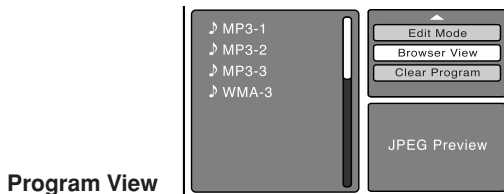

Program View

5 In the Program View, press **PLAY**. The files start to playback in programmed order that were added by you.

To remove file from program list

In the Edit Mode, switch to Program View. Select the files you want to remove, then press **ENTER**. Select “Clear Program” and press **ENTER**. Marked file is removed from program list.

Customizing the function settings

You can change the default settings to customize performance to your preference.

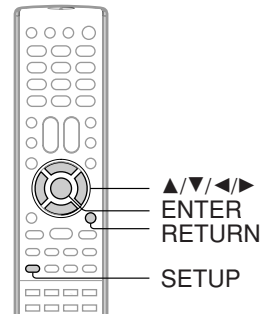

Setting procedure

1 Press **SETUP** during stop mode.



The following on-screen display appears.

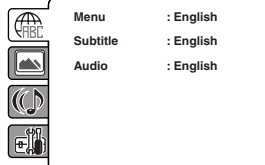

2 Press **▲** or **▼** to select the desired section, then press **◀** or **▶**.

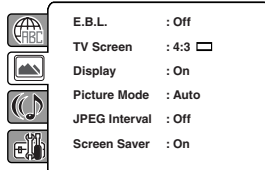
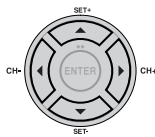

3 First option will be highlighted. Press **▲** or **▼** to select the desired option.

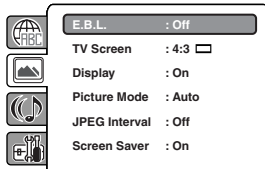
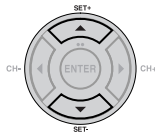

4 Then press **▶** or **ENTER**. The selectable settings will appear.

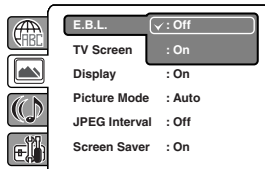
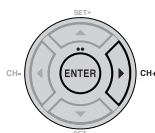

5 Change the selection using **▲** or **▼**, by referring to the corresponding pages **65** ~ **69**. Press **ENTER** to save the setting.

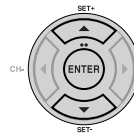



- Repeat steps 3 ~ 5 to change other option.
- To select another section, go back to step 2 by pressing **◀** repeatedly.

6 To clear **SETUP** screen, press **SETUP** or **RETURN**.



Customizing the function settings (Continued)

Setting details

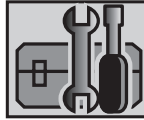
Section	Option	Details	Page
	Menu Subtitle Audio	To select the language of "Menu", "Subtitle" and "Audio" if more than one language are available on the disc.	65
	E.B.L.	To select On or Off for E.B.L. (Enhanced Black Level).	
	TV Screen	To select a picture size according to the aspect ratio of your TV.	66
	Display	To turn on or de-activate the operational status display on the screen.	
	Picture Mode	To select a preferred picture mode from "Video", "Film" or "Auto".	
	JPEG Interval	To select a preferred setting for the slide show playback.	
	Screen Saver	To select On or Off for Screen Saver function.	
	DRC	To select On or Off for DRC (Dynamic Range Control).	67
	QSound	To select On or Off for QSound.	
	Digital Out	To select an output sound format corresponding to your system connection.	
	Parental	To select a preferred parental level for the parental setting.	68
	Password	Input 4-digit password to set the parental level.	
	HD Jpeg	To select On or Off for HD Jpeg mode.	
	Output	To select a preferred video output signal from "Interlace" or "Progressive".	69
	DivX(R) VOD	To display your 8-character registration code.	



	Menu	: English
	Subtitle	: English
	Audio	: English

■ Menu, Subtitle, Audio

You can select the language of “Menu”, “Subtitle” and “Audio” if more than one languages are recorded onto the disc.

English, Francais, Espanol:

The selected language will be heard or seen.

Other:

Other language can be selected (see the “Language code list” [71](#)).

Original: (Audio)

The unit will select the first priority language of each disc.

Off: (Subtitle)

Subtitles do not appear.

Notes:

- If the selected language is not recorded on the disc, the first-priority language is selected.
- If you want to change the OSD language, you can perform it by VCR MENU [28](#).



	E.B.L.	: Off
	TV Screen	: 4:3 <input type="checkbox"/>
	Display	: On
	Picture Mode	: Auto
	JPEG Interval	: Off
	Screen Saver	: On

■ E.B.L.

To select the black level of playback pictures, set your preference and monitor’s ability.

Off: Standard grey scale (7.5 IRE cut off)

On: Enhanced grey scale (0 IRE cut off)

■ TV Screen

You have the following screen sizes to choose from:

4:3 (Letter box):

Select this mode when connecting to a conventional TV. When playing back a wide screen-DVD disc, it displays the wide picture with black bands at the top and bottom of screen.

4:3 (Pan scan):

It displays the wide picture on the whole screen with left and right edges automatically cut off.

16:9 (Wide):

Select this mode when connecting to a wide-screen TV. A wide screen picture is displayed full size.

Note:

If the DVD disc is not formatted in the pan & scan style, it displays 4:3 style.

Function setup (DVD)

Customizing the function settings (Continued)

Setting details

■ Display

On screen display can be switched on or off when you press the buttons.

- Off:** On screen displays do not appear when you press any buttons.
- On:** On screen displays appear when you press the buttons (factory setting).

■ Picture Mode

There are two types of source content in pictures recorded in DVD video discs: film content (pictures recorded from films at 24 frames per second) and video content (video signals recorded at 30 frames per second). Make this selection according to the type of content being viewed.

- Auto:** Select this position normally. The DVD player automatically detects source content, film or video, of playback source, and converts that signal in the progressive output format in an appropriate method.
- Film:** The DVD player converts film content pictures in the progressive output format appropriately. Suitable for playback of film content pictures. The progressive output feature will be most effective under this selection.
- Video:** The DVD player filters video signal, and converts it in the progressive output format appropriately. Suitable for playback of video content pictures.

Note:

Depending on the disc, pictures may be cut off or doubled. In this case, select "Video".

■ JPEG Interval

You can continuously playback all JPEG files automatically. After the selection below, the disc will start playback on which JPEG files have been recorded.

- Off:** Plays back one file at a time.

5 Seconds:
Plays back images in the form of a slide show at 5 second intervals.

10 Seconds:
Plays back images in the form of a slide show at 10 second intervals.

15 Seconds:
Plays back images in the form of a slide show at 15 second intervals.

■ Screen Saver

The screen saver operates when you leave the unit in DVD stop mode for approx. five minutes. The screen will repeatedly get dark gradually and back to normal.

- Off:** Screen Saver function is invalidated.
- On:** Screen Saver function is made effective.



DRC : Off
 QSound : Off
 Digital out : PCM

■ DRC

DRC (Dynamic Range Control) enables you to control the dynamic range so as to achieve a suitable sound for your equipment.

Off:
It plays back at the recording level on the disc.

On:
Loud sound such as explosion or similar is toned down slightly when played back. This makes it suitable for when it is connected to a stereo.

Notes:

- This function works only during playback of Dolby Digital recorded discs.
- The level of Dynamic Range Reduction may differ depending on DVD video disc.

■ QSound

This DVD video player equipped with a "QSound". It can produce the effect of being in a cinema or a concert hall.

Off: The QSound is disengaged.

On: The QSound operates.

Notes:

- The QSound setting can also be changed with **AUDIO** on the remote control (55).
- This function works only when the disc recorded with Dolby Digital is played back.
- When this function works, the volume might changed.
- When the voice is distorted, turn off QSound.

■ Digital Out

Selected the output sound format corresponding to your system connection.

PCM:

Select when connected to a 2 channel digital stereo amplifier.

Bitstream:

Disc audio bitstream data will be output.

Notes:

- When you make a connection to a TV, or Dolby Surround Pro Logic or stereo system via the analog audio jacks, select "PCM" or "Bitstream".
- If apply HDMI connection to TV, make sure to select "PCM", audio signal passing to TV via HDMI cable.

Customizing the function settings (Continued)

Setting details

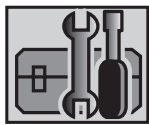

	Parental	: Off
	Password	: Change
	HD Jpeg	: Off
	Output	: Interlace
	DivX(R) VOD	: Display

■ Parental control setting

Some discs are specified not suitable for children. Such discs can be limited not to play back with the unit.

- 1) Press **▲** or **▼** to select "Parental", then press **ENTER**. "Enter Password" screen will appear.
- 2) Press "0000" using **Number buttons (0-9)**. (Please note, this is pre-setting password of this unit). Then press **ENTER**. The parental level list will appear.
 - **Level Off:** The parental control setting does not function.
 - **Level 8:** Virtually all DVD software can be played back.
 - **Level 1:** DVD software for adults cannot be played back.
- 3) Press **▲** or **▼** to select from the level 1 to level 8. The limitation will be more severe as the level number is lower. Then press **ENTER**.
- 4) Press **OPEN/CLOSE** to activate Parental control setting.

Notes:

- Depending on the discs, the unit cannot limit playback.
- Some discs may not be encoded with specific rating level information though its disc jacket says "adult." For those discs, the age restriction will not work.
- The password is required every time when you change the parental level.
- If you input a wrong number, press **CLEAR**.

■ Set the new password

- 1) Press **▲** or **▼** to select "Password", then press **ENTER**. "Enter Current Password" screen will appear.
- 2) Press **Number buttons (0-9)** to input the current password (If the password has not been set yet after you purchase this unit, it is "0000").
- 3) Then press **ENTER**. "Enter New Password" screen will appear. Press **Number buttons (0-9)** to input the new password.
- 4) Press **ENTER**. Now your new password has been set. Be sure to remember this number!

If you forget the password...

- 1) Press **OPEN/CLOSE** to open the disc tray.
- 2) Remove the disc.
- 3) Press **OPEN/CLOSE** again to close the disc tray. "No Disc" appears on the screen.
- 4) While holding **7** down on the remote control and at the same time press **STOP** on the front panel. "Password Clear" appears on the screen. Now the password has been returned to the initial value ("0000").

■ HD Jpeg

This DVD/VCR equipped with a "HD Jpeg". It can display the HD resolution JPEG images when the DVD/VCR is connected to a HDTV using HDMI.

On:

Select when you connect the DVD video player to a HDTV via HDMI OUT jack. JPEG images is displayed in suitable picture quality (480p, 720p or 1080i) **[22]**.

Off:

The picture processing quality is fixed to 480p.

Notes:

- When the DVD/VCR is not connected to a TV using HDMI, you cannot select "On".
- When HD Jpeg is set to "On", zoom function is prohibited and component video outputs disabled when 480p, 720p or 1080i is selected.



■ Output

You can select the video output signal of the DVD video player to the TV from "Interlace" or "Progressive".

Interlace:

Select when connecting to a composite TV or a TV equipped with component video inputs but progressive scan is not compatible.

Progressive:

Select when connecting to a TV equipped with component video inputs and progressive scan compatible.

Warning:

Once "Progressive" is selected when connecting to a TV progressive scan incompatible, no image will be seen on the video display.

In this case, you must reset the unit by pressing **STOP** on the front panel for five seconds. The video output will be restored to "Interlace" setting, and a picture will once again be seen on a conventional analog display.

Notes:

- Some discs may not be played back with the progressive scanning mode correctly because of the disc characteristics or recording condition.
- Once Progressive scan on, S-video output is disabled.

■ DivX® VOD

In order to play DivX® VOD (Video On Demand) content on this unit, you first need to register the unit with your DivX® VOD content provider. You do this by generating a DivX® VOD registration code, which you submit to your provider.

Press **▲** or **▼** to select "DivX(R) VOD". Then press **ENTER**. Your 8-character registration code is displayed. Make a note of the code as you will need it when you register with a DivX® VOD provider. Then press **ENTER** to select Done.

Note:

If each setup (pages 65 ~ 69) has been completed, the unit can always be worked under the same conditions (especially with DVD discs). Each setup will be retained in the memory even if you turn the power off.

Temporary disabling of rating level by DVD disc

Depending on the DVD disc, the disc may try to temporarily cancel the rating level that you have set. It is up to you to decide whether to cancel the rating level or not.

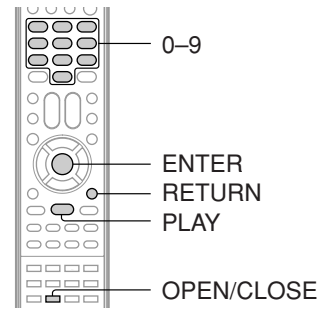

DVD Temporary disabling of rating level by DVD disc

1 Load a DVD disc and press **PLAY** or **OPEN/CLOSE** on the unit **47**.

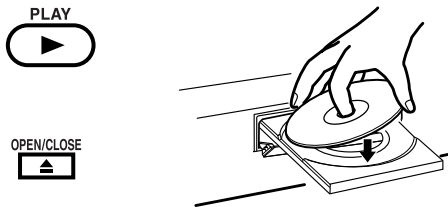

Note:

This temporary cancellation of rating level will be kept until the disc is ejected. When the disc is ejected, the original rating level will be set again automatically.

2 If the DVD disc has been designed to temporarily cancel the Rating level, the screen which follows the "Reading" screen will change, depending on which disc is played. If you select "YES" with the **ENTER** key, password input screen will then appear.

3 Enter the password with Number buttons (0-9). Then press **ENTER**.

To exit from the entry, press **RETURN**.

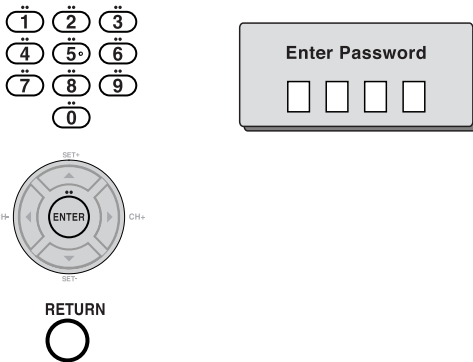

4 Playback will commence if the entered password was correct.

Language code list

Enter the appropriate code number for the initial settings "Menu", "Subtitle" and/or "Audio" **65**.

Language Name Code	Language Name Code	Language Name Code	Language Name Code
Abkhazian 1112	Fiji 1620	Lingala 2224	Singhalese 2919
Afar 1111	Finnish 1619	Lithuanian 2230	Slovak 2921
Afrikaans 1116	French 1628	Macedonian 2321	Slovenian 2922
Albanian 2927	Frisian 1635	Malagasy 2317	Somali 2925
Amharic 1123	Galician 1722	Malay 2329	Spanish 1529
Arabic 1128	Georgian 2111	Malayalam 2322	Sundanese 2931
Armenian 1835	German 1415	Maltese 2330	Swahili 2933
Assamese 1129	Greek 1522	Maori 2319	Swedish 2932
Aymara 1135	Greenlandic 2122	Marathi 2328	Tagalog 3022
Azerbaijani 1136	Guarani 1724	Moldavian 2325	Tajik 3017
Bashkir 1211	Gujarati 1731	Mongolian 2324	Tamil 3011
Basque 1531	Hausa 1811	Nauru 2411	Tatar 3030
Bengali; Bangla 1224	Hebrew 1933	Nepali 2415	Telugu 3015
Bhutani 1436	Hindi 1819	Norwegian 2425	Thai 3018
Bihari 1218	Hungarian 1831	Oriya 2528	Tibetan 1225
Breton 1228	Icelandic 1929	Panjabi 2611	Tigrinya 3019
Bulgarian 1217	Indonesian 1924	Pashto, Pushto 2629	Tonga 3025
Burmese 2335	Interlingua 1911	Persian 1611	Turkish 3028
Byelorussian 1215	Irish 1711	Polish 2622	Turkmen 3021
Cambodian 2123	Italian 1930	Portuguese 2630	Twi 3033
Catalan 1311	Japanese 2011	Quechua 2731	Ukrainian 3121
Chinese 3618	Javanese 2033	Rhaeto-Romance 2823	Urdu 3128
Corsican 1325	Kannada 2124	Romanian 2825	Uzbek 3136
Croatian 1828	Kashmiri 2129	Russian 2831	Vietnamese 3219
Czech 1329	Kazakh 2121	Samoan 2923	Volapük 3225
Danish 1411	Kirghiz 2135	Sanskrit 2911	Welsh 1335
Dutch 2422	Korean 2125	Scots Gaelic 1714	Wolof 3325
English 1524	Kurdish 2131	Serbian 2928	Xhosa 3418
Esperanto 1525	Laothian 2225	Serbo-Croatian 2918	Yiddish 2019
Estonian 1530	Latin 2211	Shona 2924	Yoruba 3525
Faroese 1625	Latvian, Lettish 2232	Sindhi 2914	Zulu 3631

Troubleshooting

Before calling a service technician, please check the following table for a possible cause of the symptoms and some solutions.

Symptoms	Solutions	Page
DVD/VCR		
DVD/VCR does not operate.	<ul style="list-style-type: none"> • Make sure the power cord is plugged in. • Try another AC outlet. • Unplug unit, then plug it back in. • Select the DVD or VCR mode before operating. 	5 – 5 35,47
No picture.	<ul style="list-style-type: none"> • Antenna connection is not correct or antenna cable is disconnected. • The video channel is not in the correct position or the TV is not set to the video channel 3 or 4. • Check the unit is connected correctly. • The video input selector of the TV is not set to VIDEO. Set to VIDEO (or equivalent). • Channel is set to the external mode. • Press HDMI to turn off the HDMI mode. 	16~19 27 16~26 – – 22
No sound.	<ul style="list-style-type: none"> • Check the unit is connected correctly. • Check the input selector of the amplifier is set properly. • The unit is in the Special playback mode. 	16~26 – 36,49
The remote control does not function.	<ul style="list-style-type: none"> • Aim the remote control at the remote sensor. • Operate within Approx. 7 Meters or reduce the light in the room. • Clear the path of the beam. • The batteries are weak. Replace the batteries. • Check the batteries are inserted correctly. 	13
No Cable TV reception.	<ul style="list-style-type: none"> • Check all Cable TV connections. • Station or Cable TV system problems, try another station. 	18,19
VCR		
TV recording does not work.	<ul style="list-style-type: none"> • The erase prevention tab of the video cassette is broken off. • The unit is in the external input mode. 	34,39
Timer recording does not work.	<ul style="list-style-type: none"> • The time is not set correctly. • The recording start/end time is not set correctly. • The TIMER REC has not been pressed (E is not lit). 	29~31 42 42
Noise bars on screen.	<ul style="list-style-type: none"> • Tracking adjustment beyond range of automatic tracking circuit. Try Manual tracking adjustment. • Video heads are dirty. • The tape is worn or damaged. 	36 36 –
DVD		
Display is not shown in your language.	<ul style="list-style-type: none"> • Select proper language in the menu options. 	65
Playback doesn't start.	<ul style="list-style-type: none"> • No disc is inserted. • The disc may be dirty. Clean up the disc. • The unit cannot play DVD-ROMs, etc. 	47 7 7
Stopping playback, slow-motion play, repeat play, or memory play, etc. cannot be performed.	<ul style="list-style-type: none"> • Some discs may not do some of the functions. 	–
No picture, or the screen is blurred or divided into two parts.	<ul style="list-style-type: none"> • The PROGRESSIVE scan is "On" although the unit is connected to a TV via the VIDEO OUT or the S-VIDEO OUT jack. 	69
No 4:3 (16:9) picture.	<ul style="list-style-type: none"> • The setup does not match your TV. 	65
No on-screen display.	<ul style="list-style-type: none"> • Set Display to "On". 	66
No surround sound.	<ul style="list-style-type: none"> • The setup does not match your stereo system. 	67
The unit or remote operation key is not functioning.	<ul style="list-style-type: none"> • Turn off the unit and unplug the AC power cord for several minutes, then replug it. 	–
Playback does not start when the title is selected.	<ul style="list-style-type: none"> • Check the Parental setup. 	68,70
Audio soundtrack and/or subtitle language is not changed when you playback a DVD.	<ul style="list-style-type: none"> • Multilingual language is not recorded on the DVD disc. 	55,56
No subtitle.	<ul style="list-style-type: none"> • Some discs have no subtitles. • Subtitles are cleared. Press SUBTITLE. 	56
Angle cannot be changed.	<ul style="list-style-type: none"> • Multi-angles are not recorded on the DVD disc. 	54
"X" appears on the screen.	<ul style="list-style-type: none"> • The function is prohibited with the unit or the disc. 	49



Specifications

General

Power supply	AC 120 V 60 Hz
Power consumption	Operation: 20 W, Stand by: 2 W
Weight	7.7 lbs (3.5 kg)
Dimensions	Width: 16-15/16 inches (430.6 mm) Height: 3-9/16 inches (89.7 mm) Depth: 9 inches (228.7 mm)
Tuner	181 channel freq. synthesized VHF 2-13 UHF 14-69 Cable TV 113 Channels
Antenna input/output	UHF/VHF In/Out: 75 Ω coaxial
RF channel output	Channel 3 or 4, Switchable
Color system	NTSC
Video head	4 Rotary heads
Audio track	Hi-Fi sound - 2 Tracks / MONO sound - 1 Track
Hi-Fi frequency response	20 Hz to 20 kHz
Hi-Fi dynamic range	More than 90dB
FWD/REV time at 25°C (77°F)	Approx. 1 minute and 48 seconds (with T-120 Cassette Tape)
Applicable disc	DVD (12 cm, 8 cm), CD (12 cm, 8 cm)
Frequency range	DVD: 4 Hz-22 kHz, CD: 4 Hz-20 kHz
S/N ratio	85dB (DVD)
Harmonic distortion	0.06% (DVD)
Wow and flutter	Less than 0.01% Wrms
Operating conditions	Temperature: 5°C-40°C (41°F-104°F), Operating status: Horizontal

Input/Output

DVD/VCR	
Video input	1.0 V (p-p), 75 Ω, negative sync., pin jack x 2
Video output	1.0 V (p-p), 75 Ω, negative sync., pin jack x 1
Audio input	-8 dBm, 50 kΩ, negative sync., pin jack (L/R) x 2
Audio output	-8 dBm, 1 kΩ, negative sync., pin jack (L/R) x 1
DVD	
S-video output	(Y) 1.0 V (p-p), 75 Ω, negative sync., Mini DIN 4-pin x 1 (C) 0.286 V (p-p), 75 Ω
Component video output	(Y) 1.0 V (p-p), 75 Ω, negative sync., pin jack x 1 (P _B)/(P _R) 0.7 V (p-p), 75 Ω, pin jack x 2
Audio output (COAXIAL DIGITAL)	0.5 V (p-p), 75 Ω, pin jack x 1
Audio output (ANALOG)	-12 dBm, 1 kΩ, pin jacks (L/R) x 1

Supplied accessories

Audio/video cable	1
Remote control (SE-R0221)	1
Batteries (R03/AAA)	2
75 Ω coaxial cable	1

- This model complies with the above specifications.
- Designs and specifications are subject to change without notice.
- This model may not be compatible with features and/or specifications that may be added in the future.

Others

- IMPORTANT - CANADIAN WARRANTY INFORMATION GARANTIE CANADIENNE



STANDARD WARRANTY
TYPE OF SET

DVD Player
DVD/VCR Combination
Home Theatre in a Box
DVD Recorder
Portable DVD

GARANTIE NORMALE
TYPE D'APPAREIL

Lecteur DVD
DVD/magnétoscope combo
Cinéma maison dans une boîte
Enregistreur DVD
DVD Portatif

WARRANTY PERIOD

12 MONTHS

DURÉE DE LA GARANTIE:

12 MOIS

CANADIAN WARRANTY

Toshiba of Canada Limited (TCL) makes the following limited warranties to original consumers in Canada. Please retain your "Bill of Sale" as proof of purchase. **To obtain a "Canadian Warranty" please register online at www.toshiba.ca.**

GARANTIE CANADIENNE

1) Toshiba du Canada Limitée (TCL) offre au Canada les garanties limitées suivantes aux consommateurs originiaux. Veuillez conserver votre « facture » comme preuve d'achat. **Pour obtenir une garantie canadienne, veuillez vous inscrire en ligne à www.toshiba.ca**

Canadian Warranty Information

Should service be required on this unit during the one year warranty period, TCL's option will be to repair or exchange the defective unit. It will be necessary to follow this procedure:

Contact: Toshiba of Canada Limited at the Consumer Electronics Group, customer support line.

Phone: 1-800-268-3404

Email: ceg_customer_support@toshiba.ca

All in-warranty repairs must be made by an authorized TCL service centre.

For service exchange TCL will arrange to have the unit picked up by courier and a replacement unit will be returned via same courier. (Note: A major credit card number will be required as a charge of \$25.00 will apply if no fault is found with the unit.) During the first 3 months of ownership, a new unit will be supplied as a replacement. During the remainder of the warranty period a service-renewed unit will be supplied.

The original "Bill of Sale" must be provided as proof of purchase (it will be returned with the replacement unit.)

This 12-month warranty will be strictly adhered to.

Out of warranty units should be repaired by a TCL authorized service centre.

Note: It is the responsibility of the owner to ensure proper packaging. Should damage in shipping occur, due to poor packaging, a charge back for the repair will result.

This warranty applies to the original purchaser only and is not transferable.

This warranty does not apply to sets that have been subjected to misuse, neglect, accident, physical damage or acts of nature.

Sets with the serial number removed, altered, replaced or defaced will not be covered by this warranty.

The warranties from TCL are effective only if the product is purchased in Canada from an authorized TCL dealer and operated in Canada.

Products utilized for rental or commercial purposes are not covered by this warranty.

This warranty is in lieu of all other warranties, guarantees or agreements, whether expressed or implied, and no person, agent distributor, dealer, service centre or company is authorized to change, modify or extend its terms in any manner whatsoever.

Information sur la garantie Canadienne

Si vous avez besoin de service sur cet appareil au cours de l'année de garantie, Toshiba du Canada Limitée aura l'option de réparer ou échanger l'appareil défectueux. Vous devrez suivre la procédure suivante:

Contact: Toshiba du Canada Limitée au Groupe Électronique aux consommateurs, service à la clientèle.

Tél: 1-800-268-3404

Courriel: ceg_customer_support@toshiba.ca

Toutes les réparations au cours de la garantie doivent être faites par un centre de service autorisé Toshiba.

Pour un échange TCL s'assurera qu'un service de courrier ramassera l'unité et qu'un appareil de remplacement soit expédié par le même service de courrier.

(Note: Un numéro de carte de crédit sera requis car une charge de 25.00\$ sera appliquée si toutefois l'appareil n'avait aucun problème de fonctionnement.)

Une nouvelle unité sera fournie comme remplacement durant les premiers 3 mois de propriété. Par contre durant la balance de la garantie une unité remise à neuf sera fournie.

La «facture» originale doit être fournie comme preuve d'achat (elle vous sera retournée avec l'unité de remplacement.)

Cette garantie de 12 mois sera strictement adhéree.

Les unités hors de garantie devraient être réparées par un centre de service autorisé Toshiba.

Note: C'est la responsabilité du propriétaire de s'assurer que l'emballage est adéquat. Vous serez facturé pour toutes réparations causées par des dommages encourus à cause d'un emballage non adéquat.

Cette garantie est octroyée à l'acheteur initial et n'est pas transférable. Cette garantie ne s'applique pas aux appareils qui ont été sujets aux abus, négligences, accidents, dommages physiques ou actes naturels.

Les appareils dont le numéro de série a été enlevé, altéré, remplacé ou barbouillé ne sont pas couverts par cette garantie.

Les garanties de TCL sont valides seulement sur les unités achetées et utilisées au Canada d'un marchand autorisé TCL.

Cette garantie ne couvre pas les produits de location ou à usage commercial. Cette garantie remplace toutes autres garanties ou ententes exprimées ou sous-entendues. Aucune personne, agent, distributeur, concessionnaire ou compagnie n'est autorisé à changer, modifier ou prolonger les termes de cette garantie de quelque façon que ce soit.

Toshiba of Canada Limited 191 McNabb Street Markham, Ontario L3R 8H2



Memo

Dotted lines for writing



Others



TOSHIBA

ColorStream and ColorStream Pro are registered trademarks of Toshiba America Consumer Products, L.L.C.



J2140301A SH 06/03

Printed in Thailand

Free Manuals Download Website

<http://myh66.com>

<http://usermanuals.us>

<http://www.somanuals.com>

<http://www.4manuals.cc>

<http://www.manual-lib.com>

<http://www.404manual.com>

<http://www.luxmanual.com>

<http://aubethermostatmanual.com>

Golf course search by state

<http://golfingnear.com>

Email search by domain

<http://emailbydomain.com>

Auto manuals search

<http://auto.somanuals.com>

TV manuals search

<http://tv.somanuals.com>