

TOSHIBA

COMBINATION 20" FLAT COLOR TELEVISION AND DVD/CD PLAYER COMBINÉ TÉVÉVISEUR COULEUR PLAT DE 20 POUCES ET DVD/CD

Owner's Manual
Manuel d'instructions
MD20FN1C/R

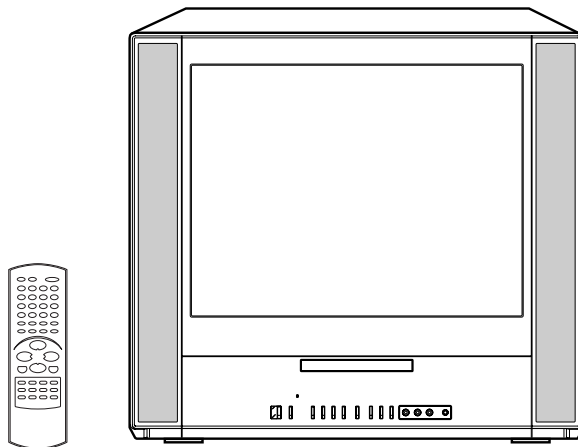

ATTENTION

For your protection in the event of theft or loss of this product, please fill in the information listed below which is for your own personal records.
Pour votre protection en cas de vol ou de perte de l'appareil, veuillez inscrire ci-dessous les renseignements demandés.

Date of Purchase : _____
Date d'achat : _____
Serial No. : _____
Numéro de série : _____
Place of Purchase : _____
Lieu d'achat : _____

TV/CATV MODE SELECTION SELECTION DU MODE TV/CATV

When shipped from the factory, the TV/CATV menu option is set to the "CATV"(Cable Television) mode.

If not using CATV, set this menu option to the "TV" position.

Lors de la fabrication de l'appareil, l'option du menu TV/CATV est réglée au mode "CATV" (câblodistribution).

Si vous n'utilisez pas la câblodistribution, choisissez l'option "TV".

Before operating the unit, please read this manual thoroughly.
Avant de mettre cet appareil en marche, veuillez lire attentivement ce manuel.

	CAUTION RISK OF ELECTRIC SHOCK DO NOT OPEN	
<p>CAUTION: TO REDUCE THE RISK OF ELECTRIC SHOCK, DO NOT REMOVE COVER (OR BACK). NO USER-SERVICEABLE PARTS INSIDE. REFER SERVICING TO QUALIFIED SERVICE PERSONNEL.</p>		



The lightning flash with arrowhead symbol, within an equilateral triangle is intended to alert the user to the presence of uninsulated dangerous voltage within the product's enclosure that may be of sufficient magnitude to constitute a risk of electric shock.



The exclamation point within an equilateral triangle is intended to alert the user to the presence of important operating and maintenance (servicing) instructions in the literature accompanying the appliance.

<p>WARNING: TO PREVENT FIRE OR SHOCK HAZARD, DO NOT EXPOSE THIS APPLIANCE TO RAIN OR MOISTURE.</p> <p>CAUTION: TO PREVENT ELECTRIC SHOCK DO NOT USE THIS POLARIZED PLUG WITH AN EXTENSION CORD, RECEPTACLE OR OTHER OUTLET UNLESS THE BLADES CAN BE FULLY INSERTED TO PREVENT BLADE EXPOSURE.</p>

WARNING: This equipment has been tested and found to comply with the limits for a Class B digital device, pursuant to Part 15 of the FCC Rules. These limits are designed to provide reasonable protection against harmful interference in a residential installation. This equipment generates, uses and can radiate radio frequency energy and, if not installed and used in accordance with the instructions, may cause harmful interference to radio communications. However, there is no guarantee that interference will not occur in a particular installation. If this equipment does cause harmful interference to radio or television reception, which can be determined by turning the equipment off and on, the user is encouraged to try to correct the interference by one or more of the following measures:

- Reorient or relocate the receiving antenna.
- Increase the distance between the equipment and receiver.
- Connect the equipment into an outlet on a circuit different from that to which the receiver is connected.
- Consult the dealer or an experienced radio/TV technician for help.

CAUTION: Changes or modifications not expressly approved by the party responsible for compliance with the FCC (Federal Communications Commission) Rules could void the user's authority to operate this equipment.

COPYRIGHT: It is permissible to record television programs, films, video tapes and other material only in the event that third party copyrights and other rights are not violated.

<p>CAUTION: THIS DIGITAL VIDEO PLAYER EMPLOYS A LASER SYSTEM.</p> <p>TO ENSURE PROPER USE OF THIS PRODUCT, PLEASE READ THIS OWNER'S MANUAL CAREFULLY AND RETAIN FOR FUTURE REFERENCE. SHOULD THE UNIT REQUIRE MAINTENANCE, CONTACT AN AUTHORIZED SERVICE LOCATION-SEE SERVICE PROCEDURE.</p> <p>USE OF CONTROLS, ADJUSTMENTS OR THE PERFORMANCE OF PROCEDURES OTHER THAN THOSE SPECIFIED HEREIN MAY RESULT IN HAZARDOUS RADIATION EXPOSURE.</p> <p>TO PREVENT DIRECT EXPOSURE TO LASER BEAM, DO NOT TRY TO OPEN THE ENCLOSURE. VISIBLE LASER RADIATION MAY BE PRESENT WHEN THE ENCLOSURE IS OPENED. DO NOT STARE INTO BEAM.</p>
--

Location of the required Marking

The rating sheet and the safety caution are on the rear of the unit.

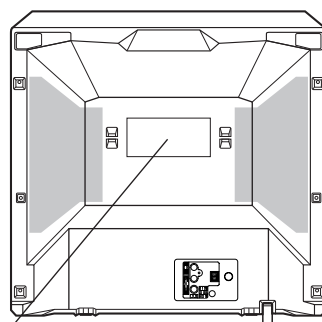

CERTIFICATION: COMPLIES WITH FDA RADIATION PERFORMANCE STANDARDS, 21 CFR SUBCHAPTER J.

IMPORTANT SAFEGUARDS

1. READ INSTRUCTIONS

All the safety and operating instructions should be read before the unit is operated.

2. RETAIN INSTRUCTIONS

The safety and operating instructions should be retained for future reference.

3. HEED WARNINGS

All warnings on the unit and in the operating instructions should be adhered to.

4. FOLLOW INSTRUCTIONS

All operating and use instructions should be followed.

5. CLEANING

Unplug this unit from the wall outlet before cleaning. Do not use liquid cleaners or aerosol cleaners.

Use a damp cloth for cleaning the exterior cabinet only.

6. ATTACHMENTS

The manufacturer of this unit does not make any recommendations for attachments, as they may cause hazards.

7. WATER AND MOISTURE

Do not use this unit near water. For example, near a bathtub, washbowl, kitchen sink, laundry tub, in a wet basement, or near a swimming pool.

8. ACCESSORIES

Do not place this unit on an unstable cart, stand, tripod, bracket, or table.

The unit may fall, causing serious injury, and serious damage to the unit.

- 8A.** An appliance and cart combination should be moved with care. Quick stops, excessive force, and uneven surfaces may cause the appliance and cart combination to overturn.

9. VENTILATION

Slots and openings in the cabinet back or bottom are provided for ventilation, and to ensure reliable operation of the unit, and to protect it from overheating.

These openings must not be blocked or covered. The openings should never be blocked by placing the unit on a bed, sofa, rug, or other similar surface. This unit should never be placed near or over a radiator or heat source. This unit should not be placed in a built-in installation such as a bookcase or rack unless proper ventilation is provided or the manufacturer's instructions have been adhered to.

10. POWER SOURCE

This unit should be operated only from the type of power source indicated on the rating plate. If you are not sure of the type of power supply to your home, consult your appliance dealer or local power company. For units intended to operate from battery power, or other sources, refer to the respective pages on this Owner's Manual for their operating instructions.

11. GROUNDING OR POLARIZATION

This unit is equipped with a polarized alternating-current line plug (a plug having one blade wider than the other). This plug will fit into the power outlet only one way. This is a safety feature. If you are unable to insert the plug fully into the outlet, try reversing the plug. If the plug should still fail to fit, contact your electrician to replace your obsolete outlet. Instead of the polarized alternating-current line plug, your unit may be equipped with a 3-wire grounding-type plug (a plug having a third (grounding) pin). This plug will only fit into a grounding-type power outlet. This too, is a safety feature. If you are unable to insert the plug into the outlet, contact your electrician to replace your obsolete outlet.

Do not defeat the safety purpose of the grounding-type plug.

PORTABLE CART WARNING
(symbol provided by RETAC)



S3126A

12. POWER-CORD PROTECTION

Power-supply cords should be routed so that they are not likely to be walked on or pinched by items placed upon or against them, paying particular attention to cords at plugs, convenience receptacles, and the point where they exit from the appliance.

13. LIGHTNING

To protect your unit from a lightning storm, or when it is left unattended and unused for long periods of time, unplug it from the wall outlet and disconnect the antenna or cable system. This will prevent damage to the unit due to lightning and power line surges.

14. POWER LINES

An outside antenna system should not be located in the vicinity of overhead power lines or other electric light or power circuits, or where it can fall onto or against such power lines or circuits. When installing an outside antenna system, extreme care should be taken to keep from touching such power lines or circuits, as contact with them might be fatal.

15. OVERLOADING

Do not overload wall outlets and extension cords, as this can result in a risk of fire or electric shock.

16. OBJECT AND LIQUID ENTRY

Do not push objects through any openings in this unit, as they may touch dangerous voltage points or short out parts that could result in fire or electric shock. Never spill or spray any type of liquid into the unit.

17. OUTDOOR ANTENNA GROUNDING

If an outside antenna or cable system is connected to the unit, be sure the antenna or cable system is grounded to provide some protection against voltage surges and built-up static charges. Section 810 of the National Electrical Code (NEC), ANSI/NFPA 70, provides information with respect to proper grounding of the mast and supporting structure, grounding of the lead-in wire to an antenna discharge unit, size of grounding conductors, location of antenna discharge unit, connection to grounding electrodes, and requirements for the grounding electrode.

18. SERVICING

Do not attempt to service this unit yourself as opening or removing covers may expose you to dangerous voltage or other hazards. Refer all servicing to qualified service personnel.

For example:

- a. When the power-supply cord or plug is damaged.
- b. If liquid has been spilled, or objects have fallen into the unit.
- c. If the unit has been exposed to rain or water.
- d. If the unit does not operate normally by following the operating instructions. Adjust only those controls that are covered by the operating instructions, as an improper adjustment of other controls may result in damage and will often require extensive work by a qualified technician to restore the unit to its normal operation.
- e. If the unit has been dropped or the cabinet has been damaged.
- f. When the unit exhibits a distinct change in performance, this indicates a need for service.

19. REPLACEMENT PARTS

When replacement parts are required, be sure the service technician uses replacement parts specified by the manufacturer or those that have the same characteristics as the original part.

Unauthorized substitutions may result in fire, electric shock or other hazards.

20. SAFETY CHECK

Upon completion of any service or repairs to this unit, ask the service technician to perform safety checks to determine that the unit is in proper operating condition.

21. HEAT

The product should be situated away from heat sources such as radiators, heat registers, stoves, or other products (including amplifiers) that produce heat.

22. DISC TRAY

Keep your fingers well clear of the disc tray as it is closing. It may cause serious personal injury.

23. CONNECTING

When you connect the product to other equipment, turn off the power and unplug all of the equipment from the wall outlet. Failure to do so may cause an electric shock and serious personal injury. Read the owner's manual of the other equipment carefully and follow the instructions when making any connections.

24. SOUND VOLUME

Reduce the volume to the minimum level before you turn on the product. Otherwise, sudden high volume sound may cause hearing or speaker damage.

25. SOUND DISTORTION

Do not allow the product output distorted sound for a longtime. It may cause speaker overheating and fire.

26. HEADPHONES

When you use the headphones, keep the volume at a moderate level. If you use the headphones continuously with high volume sound, it may cause hearing damage.

27. LASER BEAM

Do not look into the opening of the disc tray or ventilation opening of the product to see the source of the laser beam. It may cause sight damage.

28. DISC

Do not use a cracked, deformed, or repaired disc. These discs are easily broken and may cause serious personal injury and product malfunction.

29. NOTE TO CATV SYSTEM INSTALLER

This reminder is provided to call the CATV system installer's attention to Article 820-40 of the NEC that provides guidelines for proper grounding and, in particular, specifies that the cable ground shall be connected to the grounding system of the building, as close to the point of cable entry as practical.

EXAMPLE OF ANTENNA GROUNDING AS PER THE NATIONAL ELECTRICAL CODE

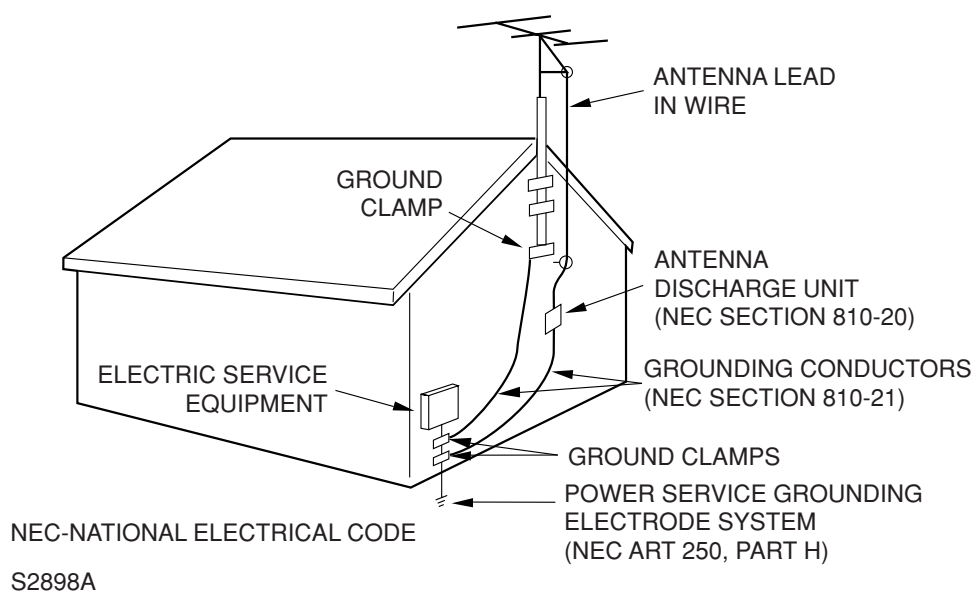

IMPORTANT RECYCLING INFORMATION

This product uses both Cathode Ray Tube (CRT) and other components that contain lead. In your community there might be regulations that require you to dispose these materials properly under environmental considerations. Please contact your local authorities, or the Electronic Industries Alliance (<http://www.eiae.org>) for disposal or recycling information.

Notes on discs

On handling discs

- Do not touch the playback side of the disc.

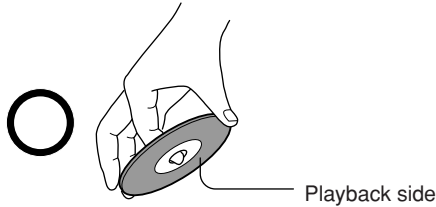

- Do not attach paper or tape to discs.



On cleaning discs

- Fingerprints and dust on the disc cause picture and sound deterioration. Wipe the disc from the center outwards with a soft cloth. Always keep the disc clean.

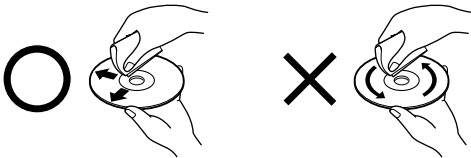

- If you cannot wipe off the dust with a soft cloth, wipe the disc lightly with a slightly moistened soft cloth and finish with a dry cloth.
- Do not use any type of solvent such as thinner, benzene, commercially available cleaners or antistatic spray for vinyl LPs. It may damage the disc.

On storing discs

- Do not store discs in a place subject to direct sunlight or near heat sources.
- Do not store discs in places subject to moisture and dust such as a bathroom or near a humidifier.
- Store discs vertically in a case. Stacking or placing objects on discs outside of their case may cause warping.

Structure of disc contents

Normally, DVD video discs are divided into titles, and the titles are sub-divided into chapters. Video CDs and Audio CDs are divided into tracks.

DVD video disc

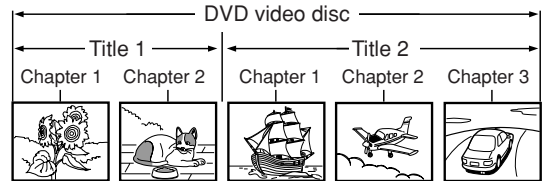

Video CD/Audio CD

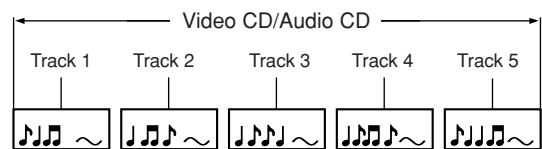

Each title, chapter or track is assigned a number, which is called "title number", "chapter number" or "track number" respectively.

There may be discs that do not have these numbers.

Notes on copyright

It is forbidden by law to copy, broadcast, show, broadcast on cable, play in public, and rent copyrighted material without permission.

This device does not tape-record copy protected DVD Video Discs.

The device is not to be used for copying copyrighted content without the express written permission of the copyright owner.

Obtaining such permission is the sole responsibility of the user.

This product incorporates copyright protection technology that is protected by method claims of certain U.S. patents and other intellectual property rights owned by Macrovision Corporation and other rights owners. Use of this copyright protection technology must be authorized by Macrovision Corporation, and is intended for home and other limited viewing uses only unless otherwise authorized by Macrovision Corporation. Reverse engineering or disassembly is prohibited.

Contents

Before using your unit

IMPORTANT SAFEGUARDS	3
Notes on discs	6
Contents	7
Parts and functions	8
Remote control	9
Power source	10
Antenna connections	11
Cable TV connections	12

TV operation

Setting the language	13
TV operation	14
Closed captions	16
To memorize channels	17
Picture control adjustment	19
Sound control adjustment	20
Stereo and Second Audio Program (SAP)	21

Playback operation

Disc	22
Preparation/Status display of disc/To turn off the PBC	23
Playback procedure	24
Special playback	25

Advanced function

Zooming/Locating desired scene	26
Repeat, Random and Program playback/Repeat A-B	27
Changing soundtrack language/Subtitles	28
Changing angles/Title selection/DVD menu	29

Additional information

Setting language	30
Setting the aspect ratio of TV screen/Setting on screen display	31
Dynamic Range Control	32
Parental control setting	33
To change the parental level	34
Temporary disabling of rating level by DVD disc	35
Connections to other equipments	36
Language code list	38
Reception disturbances	39
Problems and troubleshooting	40
Specifications	42
Warranty	43

Parts and functions

Front

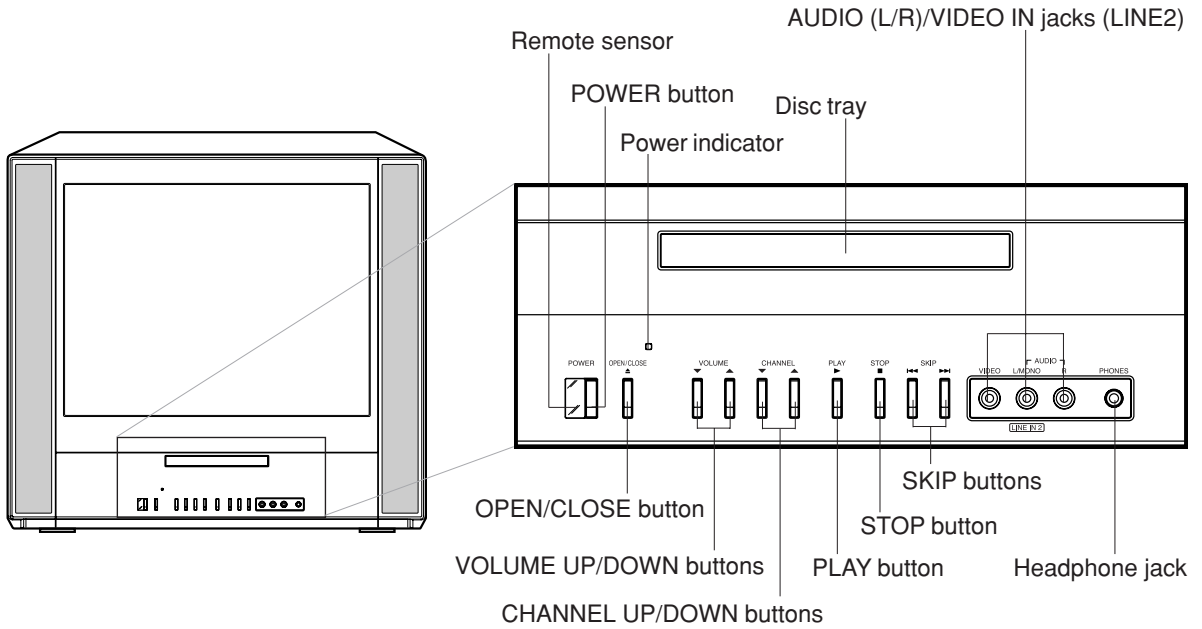

Rear

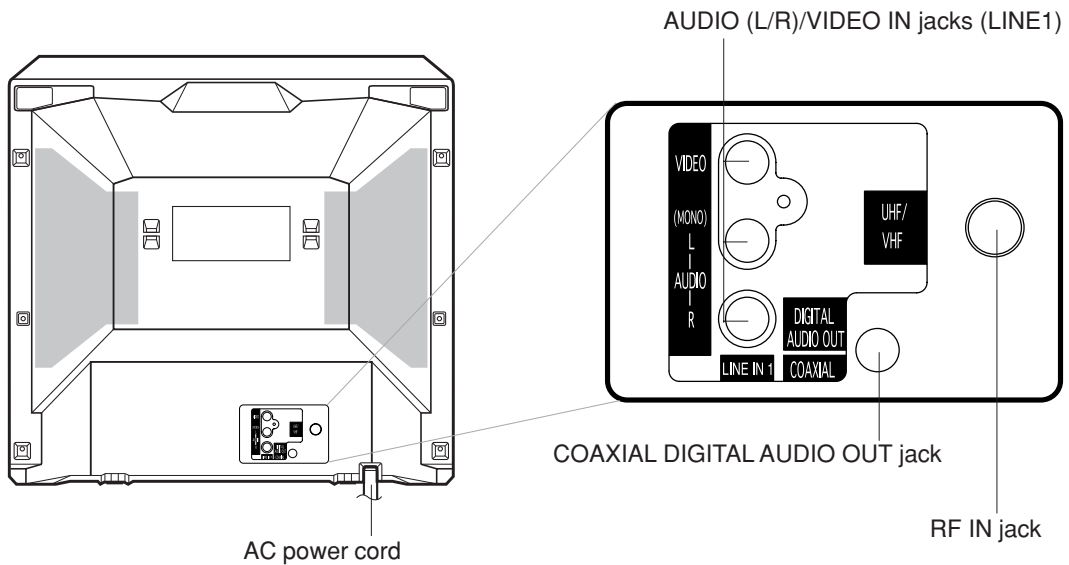

Remote control

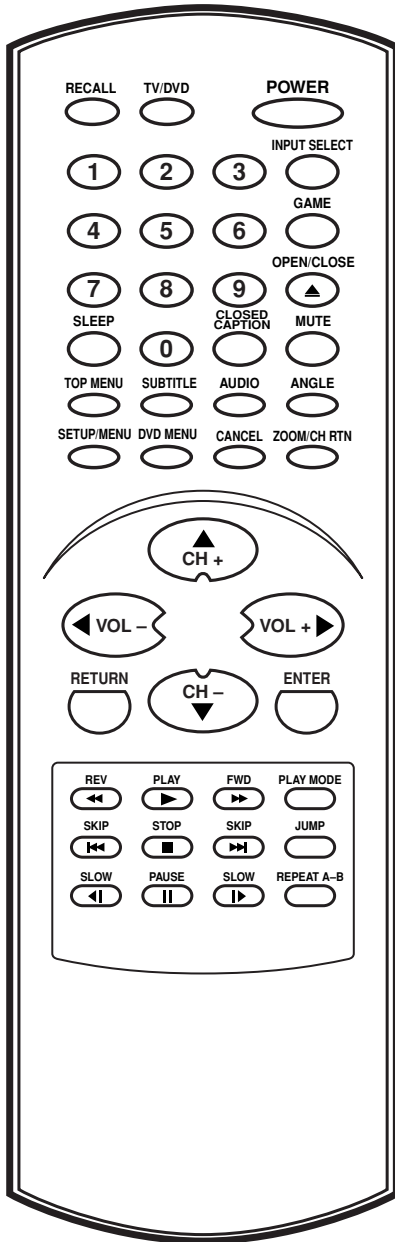

		Page
RECALL	Call TV information Call DVD information	15 23
TV/DVD	Switch between TV/AV and DVD	23
POWER	Power On/Off	13,14,23
0-9	Direct channel selection of TV Input setting Enter a password	14,18 26,27 33~35
INPUT SELECT	Switch between TV/AV	37
GAME	Switch between TV/AV and GAME	37
OPEN/CLOSE	Open or Close the tray	24,35
SLEEP	Sleep timer	15
CLOSED CAPTION	Switch between TV/Caption/Text in Closed Caption mode	16
MUTE	Switch off the sound	15
TOP MENU	Select title	29
SUBTITLE	Set Subtitle	28
AUDIO	Switch the sound of TV Change sound track language	21 28
ANGLE	Change playback angle	29
SETUP/MENU	TV mode - Display menu of TV DVD mode - Call up initial setup mode	13,17~20 30~34
DVD MENU	Display DVD menu	29
CANCEL	Reset information in the menu	19,20,26,33,34
ZOOM/CH RTN	Switch between present/last channel Zoom	15 26
CH +/- ▲▼	Select channel of TV Cursor buttons	15 13,17~20 24,26,29~34
VOL +/- ◀▶	Adjust volume of TV Cursor buttons	14 13,17~20 24,26,29~34
RETURN	Remove DVD set up menu	30~35
ENTER	Enter information in the menu	13,24 26,27,29~35
FWD/REV	Fast Forward/Review playback	25
PLAY	Playback	24,25,27,29,35
PLAY MODE	Select playback mode	27
SKIP	Skip chapter to forward or reverse direction	25
STOP	Stop	24,27
JUMP	Locating desired scene	26
SLOW	Forward/Reverse- slow motion	25
PAUSE	Pause CD sound Still picture of DVD	25
REPEAT A-B	Repeat playback between A and B	27

Remote control/Power source

Inserting Batteries

- 1 Slide the battery compartment cover in the direction of the arrow.

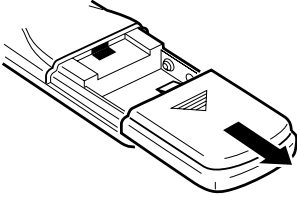

- 2 Install two "AAA" batteries (supplied), paying attention to the polarity diagram in the battery compartment.

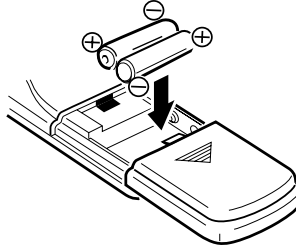

- 3 Replace the compartment cover.

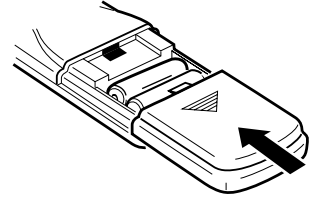

Operation

- Aim the remote control at the remote sensor and press control buttons to operate.
- Operate the remote control within 30° angle on either side of the remote sensor, up to a distance of Approx. 5 meters.

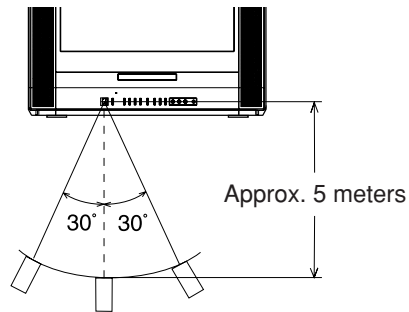

The precautions below should be followed when using batteries in this device:

1. Use only the size and type of batteries specified.
2. Be sure to follow the correct polarity when installing the batteries as indicated in the battery compartment. Reversed batteries may cause damage to the device.
3. Do not mix different types of batteries together (e.g. Alkaline and Carbon-zinc) or old batteries with fresh ones.
4. If the device is not to be used for a long period of time, remove the batteries to prevent damage or injury from possible battery leakage.
5. Do not try to recharge batteries not intended to be recharged; they can overheat and rupture (Follow battery manufacturer's directions).

Power source

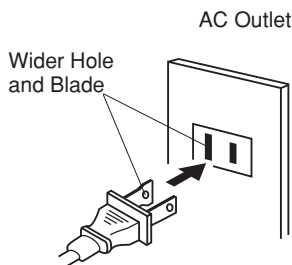

Polarized AC Cord Plug
(One blade is wider than the other.)

TO USE AC POWER SOURCE

Use the AC polarized line cord provided for operation on AC. Insert the AC cord plug into a standard 120V 60Hz polarized AC outlet.

NOTES:

- Never connect the AC line cord plug to other than the specified voltage (120V 60Hz). Use the attached power cord only.
- If the polarized AC cord does not fit into a non-polarized AC outlet, do not attempt to file or cut the blade. It is the user's responsibility to have an electrician replace the obsolete outlet.
- If you cause a static discharge when touching the unit and the unit fails to function, simply unplug the unit from the AC outlet and plug it back in. The unit should return to normal operation.
- If the AC cord plug is plugged in for the first time, wait for about 5 seconds before pressing the POWER button.

Antenna connections

If you are using an indoor or outdoor antenna, follow the instructions below that correspond to your antenna system. If you are using a cable TV service (CATV), see page 12 for Cable TV connections.

Combination VHF/UHF Antenna (Single 75 ohm Cable or 300 ohm Twin-lead Wire)

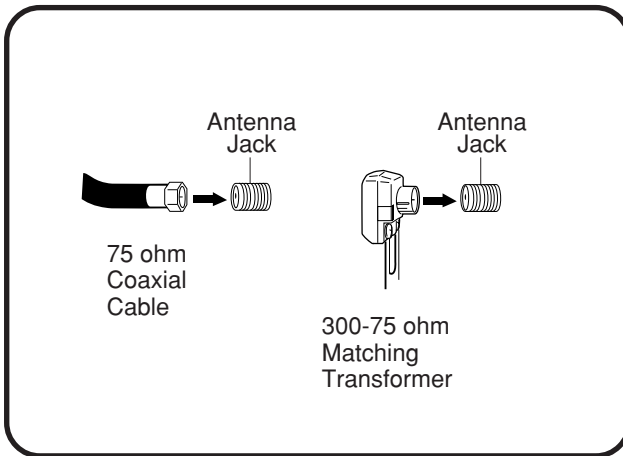

Connect the 75 ohm Cable from the Combination VHF/UHF Antenna to the Antenna Jack.

If your Combination VHF/UHF Antenna has a 300 ohm Twin-lead Wire, the use of the 300-75 ohm Matching Transformer may be necessary.

Combination VHF/UHF Antenna (Separate VHF and UHF 300 ohm Twin-lead Wires)

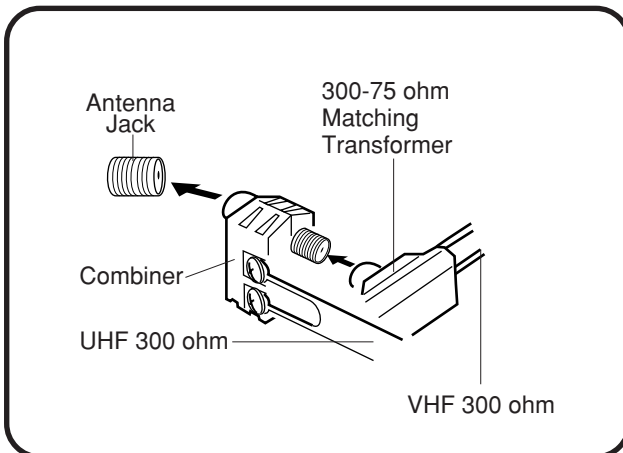

Connect the UHF 300 ohm Twin-lead Wire to the Combiner (not supplied). Connect the VHF 300 ohm Twin-lead Wire to the 300-75 ohm Matching Transformer. Attach the Transformer to the Combiner, then attach the Combiner to the Antenna Jack.

Separate VHF/UHF Antennas (75 ohm VHF Cable and 300 ohm UHF Twin-lead Wires)

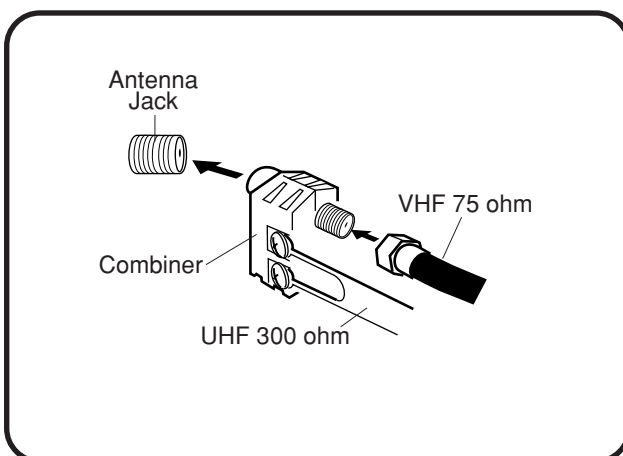

Connect the VHF 75 ohm cable and UHF 300 ohm Twin-lead Wire to the Combiner. Attach the Combiner to the Antenna Jack.

Cable TV connections

This TV/DVD has an extended tuning range and can tune most cable channels without using a Cable TV Converter box. Some cable companies offer “premium pay channels” in which the signal is scrambled. Descrambling these signals for normal viewing requires the use of a descrambler device which is generally provided by the cable company.

FOR SUBSCRIBERS TO BASIC CABLE TV SERVICE

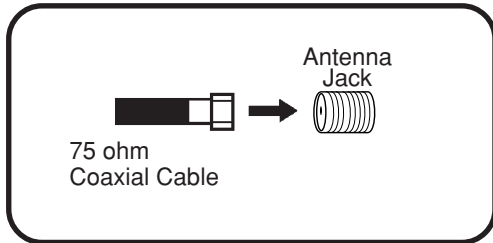

For basic cable service not requiring a Converter/Descrambler box, connect the CATV 75 ohm Coaxial Cable directly to the Antenna Jack on the back of the TV/DVD.

FOR SUBSCRIBERS TO SCRAMBLED CABLE TV SERVICE

If you subscribe to a cable TV service which requires the use of a Converter/Descrambler box, connect the incoming 75 ohm Coaxial Cable to the Converter/Descrambler box. Using another 75 ohm Coaxial Cable, connect the output jack of the Converter/Descrambler box to the Antenna Jack on the TV/DVD. Follow the connections shown below. Tune the TV/DVD to the output channel of the Converter/Descrambler box (usually channel 3 or 4) and use the Converter/Descrambler box to select channels.

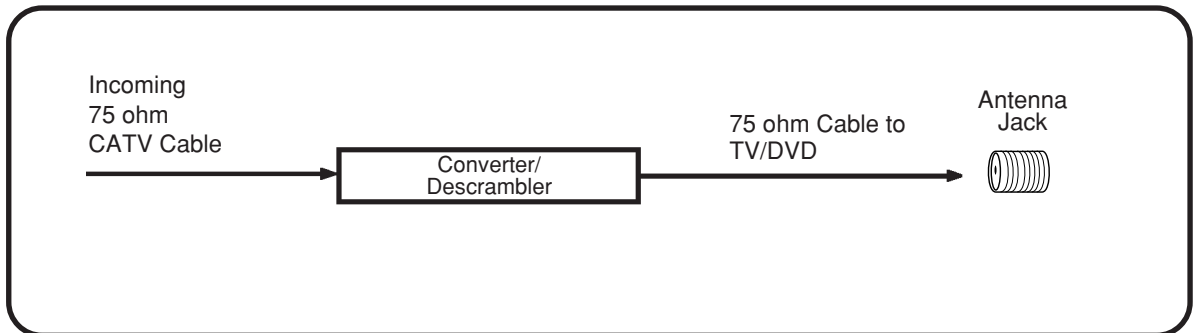

FOR SUBSCRIBERS TO UNSCRAMBLED BASIC CABLE TV SERVICE WITH SCRAMBLED PREMIUM CHANNELS

If you subscribe to a cable TV service in which basic channels are unscrambled and premium channels require the use of a Converter/Descrambler box, you may wish to use a signal Splitter and an A/B Switch box (available from the Cable company or an electronics supply store). Follow the connections shown below. With the switch in the “B” position, you can directly tune any nonscrambled channels on your TV/DVD. With the switch in the “A” position, tune your TV/DVD to the output of the Converter/Descrambler box (usually channel 3 or 4) and use the Converter/Descrambler box to tune scrambled channels.

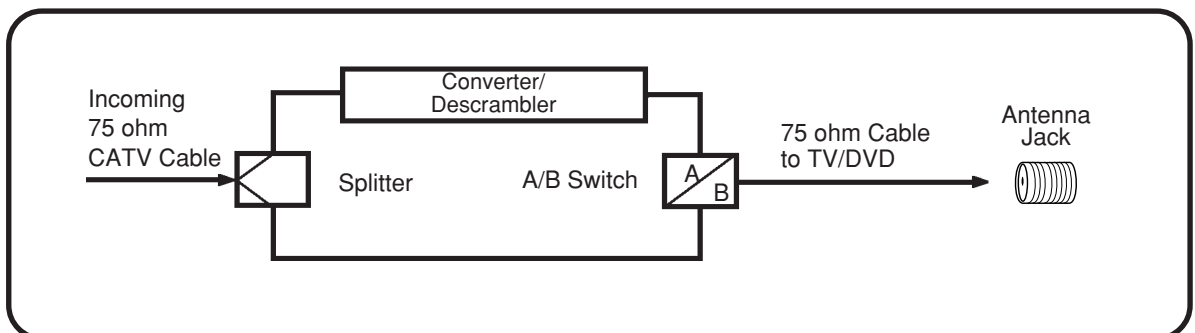

Setting the language

You can choose from three different languages (English, French and Spanish) for the on-screen displays. Adjustment menus and messages will appear in the language of your choice. On-screen language selection (step 5) will automatically appear on the screen when you press the MENU button initially. Select the language you prefer first, then proceed with the other menu options.

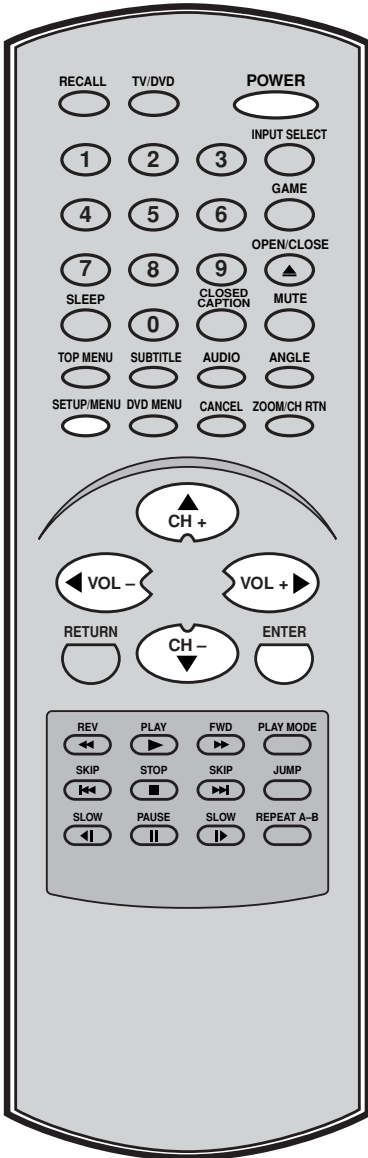

1 To turn on the TV/DVD, press **POWER**. The Power indicator will light.

2 Press **MENU** in the TV mode. The TV menu screen will appear.

3 Press ◀ or ▶ until the **OPTION** menu appears.

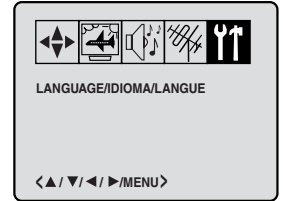

4 Press ▲ or ▼ to select the "LANGUAGE" option, then press ◀ or ▶ button.

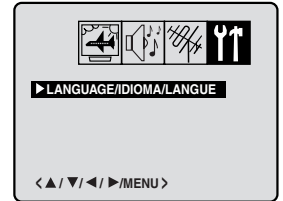

5 Press ▲ or ▼ to select the desired language: English (ENGLISH), Spanish (ESPAÑOL) or French (FRANCAIS), then press **ENTER**.

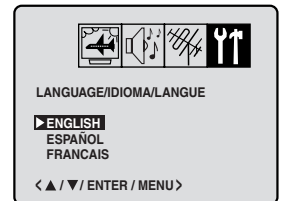

6 Press **MENU** until the MENU screen is cleared.

NOTES:

- If the unit does not operate properly, or No key operation (by the unit and/or the remote control): Static electricity, etc., may affect the player's operation. Disconnect the AC power cord once, then connect it again.
- The TV section has its own menu and also DVD section has its own menu (see page 30).

TV operation

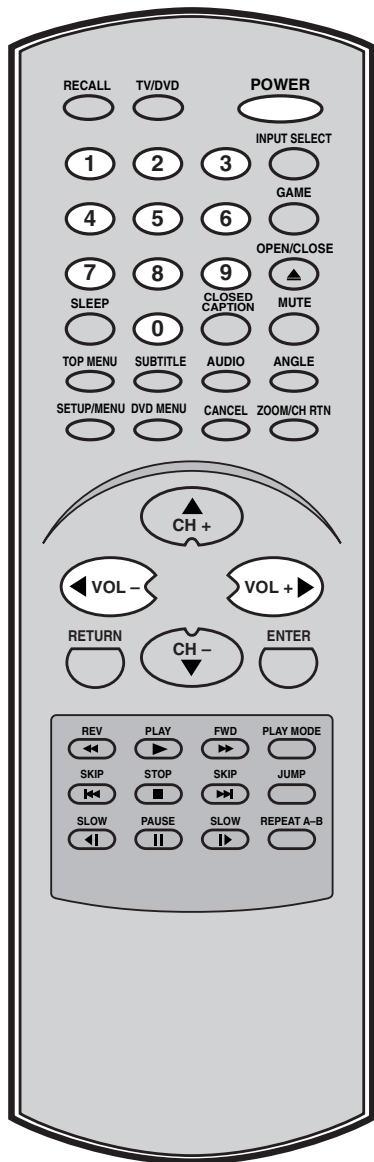

NOTES:

- If a channel with no broadcast is selected, the sound will automatically be muted.
- If a station being viewed stops broadcasting, the TV will automatically shut itself off after 15 minutes.

1 To turn on the TV/DVD, press **POWER**.

2 Adjust the volume level by pressing **VOL +** or **-**. The volume level will be indicated on the screen by green bars. As the volume level increases, so do the number of bars. If the volume decreases, the number of green bars also decreases.

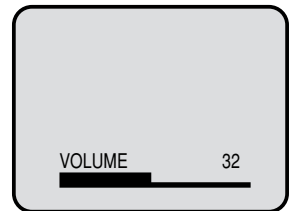

3 Set the TV/CATV menu option to the appropriate position. (See page 17.)

TV - VHF/UHF channels
CATV - CABLE TV channels

4 Press the Direct Channel selection buttons to select the channel.

TV Mode Direct Channel Selection

When the TV/CATV menu option is in the TV position, all channels can be instantly selected by using two buttons. (for example, to select channel 2, press "0", then "2". If you press only "2", channel selection will be delayed for a few seconds.) For channels 10 and above, press the 2 digits in order.

CATV Mode Direct Channel Selection

When the TV/CATV menu option is in the CATV position, channels can be selected as follows:

TO SELECT CATV CHANNELS:

- 1-9: Press "0" twice, then 1-9 as needed. Example, to select channel 2, press "002".
- 10-12: Press "0", then the remaining 2 digits. Example, to select channel 12, press "012".
- 13-99: Press the 2 digits in order. Example, to select channel 36, press "36".
- 100-125: Press the 3 digits in order. Example, to select channel 120, press "120".

NOTE FOR CHANNELS 1-12:

If only 1 or 2 buttons are pressed, the corresponding channel will be selected in 2 seconds.

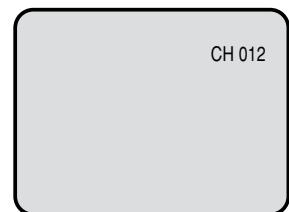

TV	CATV
VHF 2-13	VHF 2-13
UHF 14-69	STD/HRC/IRC 14-36 (A) (W) 37-59 (AA) (WW) 60-85 (AAA) (ZZZ) 86-94 (86) (94) 95-99 (A-5) (A-1) 100-125 (100) (125) 01 (5A)

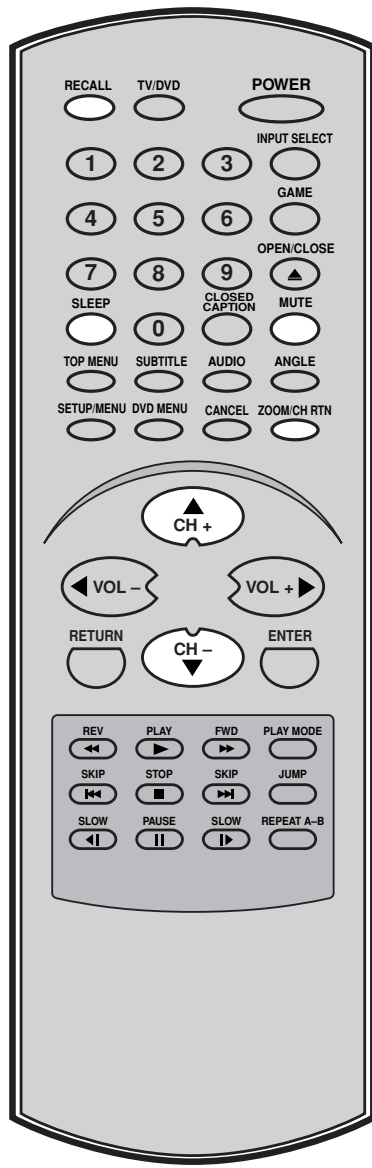

CHANNEL UP/DOWN

Press and release **CH +** or **-**. The channel automatically stops at the next channel set into memory. For proper operation, before selecting channels, they should be set into the memory. See pages 17 and 18 "To memorize channels".

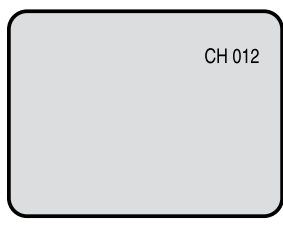

RECALL

Press **RECALL** to display the current informations on the screen. Press **RECALL** again to clear the call display.

- Channel number or VIDEO mode
- Stereo or SAP (second audio program) audio status
- Audio output status

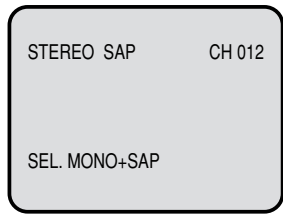

CH RETURN

This button allows you to go back to the last channel selected by pressing **CH RTN**. Press **CH RTN** again to return to the last channel you were watching.

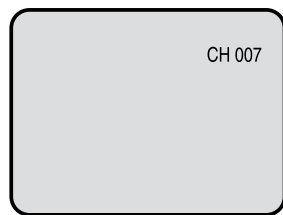

MUTE

Press **MUTE** to switch off the sound. The TV/DVD's sound will be silenced and "MUTE" will briefly appear on the screen. The sound can be switched back on by pressing this button again or one of the VOL + or - buttons.

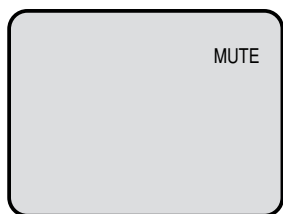

SLEEP

To set the TV/DVD to turn off after a preset amount of time, press **SLEEP** on the remote control. The clock will count down 10 minutes for each press of **SLEEP** (120, 110, ...10, 0). After the sleep time is programmed, the display will appear briefly every ten minutes to remind you that the sleep timer is operating. To confirm the sleep timer setting, press **SLEEP** and the remaining time will be displayed for a few seconds. To cancel the sleep timer, press **SLEEP** repeatedly until the display turns to 0.

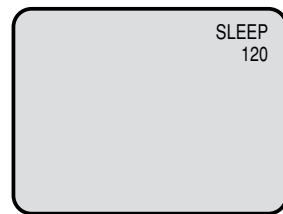

Closed captions

WHAT IS CLOSED CAPTIONING?

This television has the capability to decode and display Closed Captioned television programs. Closed Captioning will display text on the screen for hearing impaired viewers or it will translate and display text in another language.

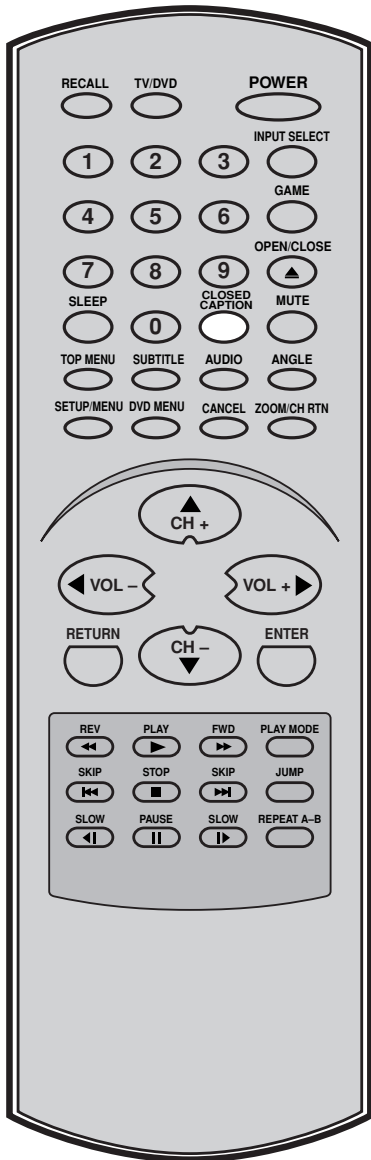

Captions: This Closed Caption Mode will display text on the screen in English or another language (depending on the setting of the Closed Captions CH 1/2).

Generally, Closed Captions in English are transmitted on Captions Channel 1 and Closed Captions in other languages are transmitted on Captions Channel 2.

Text: The Text Closed Caption Mode will usually fill the screen with a programming schedule or other information.

After selecting a Closed Caption Mode, it will stay in effect until it is changed, even if the channel is changed.

If the Captions signal is lost due to a commercial or a break in the signal, the Captions will reappear when the signal is received again. If the channels are changed, the Captions will be delayed approximately 10 seconds. The Captions will appear in places on the screen where they will least interfere with the picture, usually on the bottom of the screen. News programs will usually show three-line Closed Captions which scroll onto the screen.

Most other shows provide two or three lined Captions placed near the character who is speaking so the viewer can follow the dialogue. Words in italics or underlined describe titles, words in foreign languages or words requiring emphasis. Words that are sung usually appear enclosed by musical notes.

For television programs broadcasting with Closed Captions, look in your TV guide for the Closed Captions symbol (CC).

TO VIEW CLOSED CAPTIONS

Press **CLOSED CAPTION** to switch between normal TV and the two closed caption modes (captions and full screen text). Closed captioning will display text on the screen for hearing impaired viewers.

CAPTION CH 1

NOTES:

- When selecting Closed Captions, the captioning will be delayed approximately 10 seconds.
- If no caption signal is received, no captions will appear, but the television will remain in the Caption Mode.
- Misspellings or unusual characters may occasionally appear during Closed Captioning. This is normal with Closed Captioning, especially with live programs. This is because during live programs, captions are also entered live. These transmissions do not allow time for editing.
- When Captions are being displayed, on-screen displays, such as volume and mute may not be seen or may interfere with Closed Captions.
- Some cable systems and copy protection systems may interfere with the Closed Captioned signal.
- If using an indoor antenna or if TV reception is very poor, the Closed Caption Decoder may not appear or may appear with strange characters or misspelled words. In this case, adjust the antenna for better reception or use an outdoor antenna.

To memorize channels

This TV/DVD is equipped with a channel memory feature which allows channels to skip up or down to the next channel set into memory, skipping over unwanted channels. Before selecting channels, they must be programmed into the TV/DVD's memory. In addition to normal VHF and UHF channels, this TV/DVD can receive up to 113 Cable TV channels. To use this TV/DVD with an antenna, set the TV/CATV menu option to the TV mode. When shipped from the factory, this menu option is in the CATV mode.

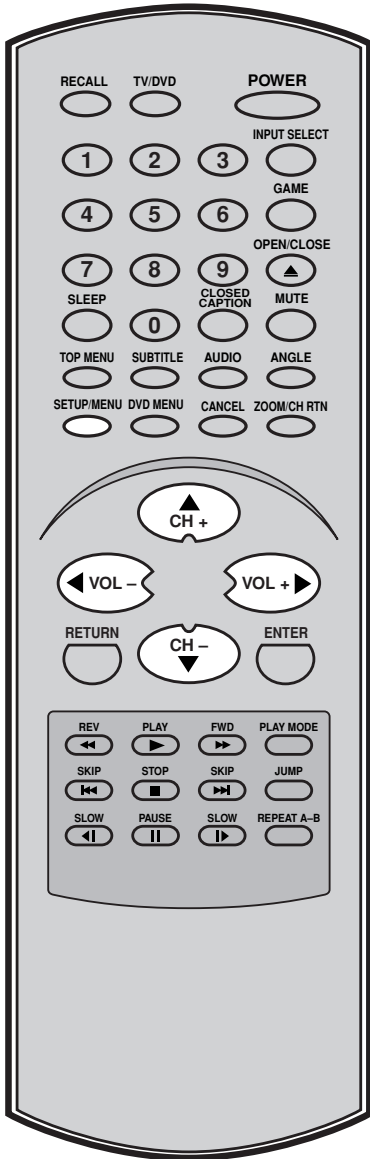

TV/CATV SELECTION

1 Press **MENU** in the TV mode. The TV menu screen will appear.

2 Press ◀ or ▶ until the SETUP menu appears.

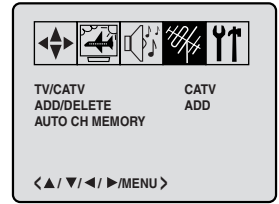

3 Press ▲ or ▼ to select the "TV/CATV".

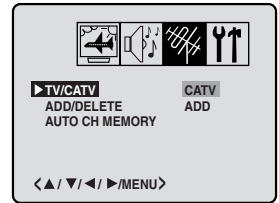

4 Press ◀ or ▶ to select the TV or CATV mode.

TV - VHF/UHF channels
CATV - CABLE TV channels

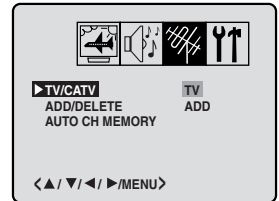

5 Press **MENU** until the MENU screen is cleared.

CATV CHART

The chart below is typical of many cable system channel allocations.

Number on this TV												14	15	16	17	18	19	20	21	22
Corresponding CATV channel												A	B	C	D	E	F	G	H	I
23	24	25	26	27	28	29	30	31	32	33	34	35	36	37	38	39	40			
J	K	L	M	N	O	P	Q	R	S	T	U	V	W	AA	BB	CC	DD			
41	42	43	44	45	46	47	48	49	50	51	52	53	54	55	56	57	58			
EE	FF	GG	HH	II	JJ	KK	LL	MM	NN	OO	PP	QQ	RR	SS	TT	UU	VV			
59	60	61	62	63	64	65	66	67	68	69	70	71	72	73	74	75	76			
WW	AAA	BBB	CCC	DDD	EEE	FFF	GGG	HHH	III	JJJ	KKK	LLL	MMM	NNN	OOO	PPP	QQQ			
77	78	79	80	81	82	83	84	85	86	87	88	89	90	91	92	93	94			
RRR	SSS	TTT	UUU	VVV	WWW	XXX	YYY	ZZZ	86	87	88	89	90	91	92	93	94			
95	96	97	98	99	100	101	102	103	104	105	106	107	108	109	110	111	112			
A-5	A-4	A-3	A-2	A-1	100	101	102	103	104	105	106	107	108	109	110	111	112			
113	114	115	116	117	118	119	120	121	122	123	124	125	01							
113	114	115	116	117	118	119	120	121	122	123	124	125	5A							

To memorize channels

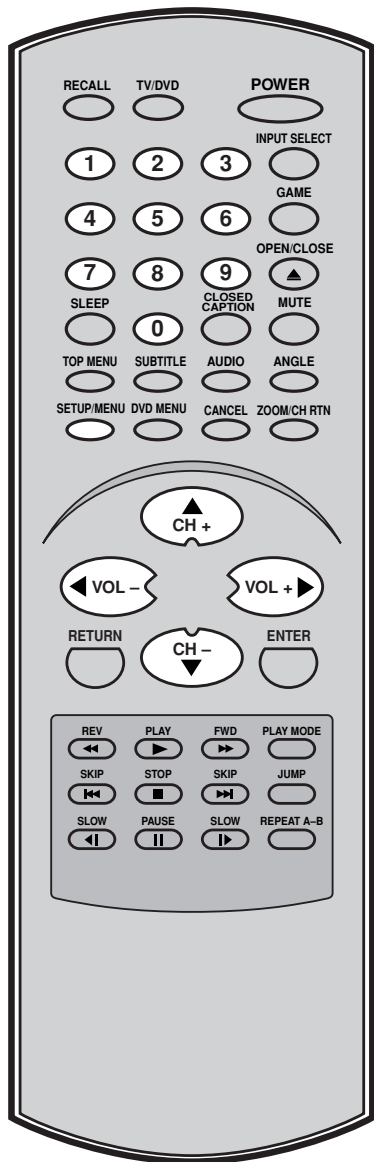

AUTOMATIC MEMORY TUNING

- 1 Press **MENU** in the TV mode. The TV menu screen will appear.
- 2 Press ◀ or ▶ until SETUP menu appears.
- 3 Press ▲ or ▼ to select the "AUTO CH MEMORY", then press ◀ or ▶. The TV will begin memorizing all the channels available in your area.

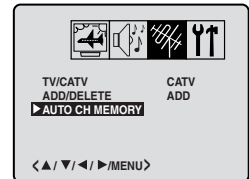
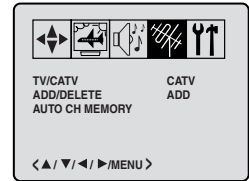

- 4 Press **MENU** until the MENU screen is cleared.

TO ADD/DELETE CHANNELS

- 1 Select the desired channel to be memorized or deleted using **Direct Channel Selection (0-9)**, or **CH +** or **-**.

- 2 Press **MENU**. The TV menu screen will appear.

- 3 Press ◀ or ▶ until SETUP menu appears.

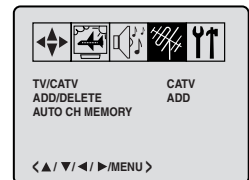

- 4 Press ▲ or ▼ to select the "ADD/DELETE".

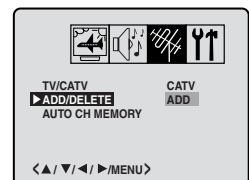

- 5 Press ◀ or ▶ to select "ADD" or "DELETE", whichever function you want to perform.

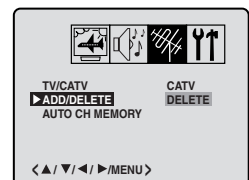

- 6 Press **MENU** until the MENU screen is cleared.

- 7 Repeat steps 1-6 for other channels you want to add or delete.

Picture control adjustment

Picture controls are factory preset but you can adjust them individually as follows:

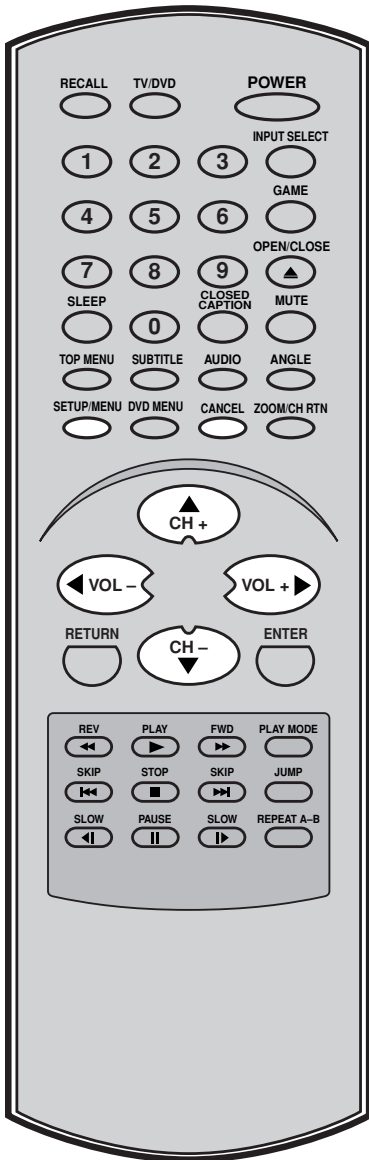

1 Press **MENU** in the TV mode. The TV menu screen will appear.

2 Press ◀ or ▶ until PICTURE menu appears.

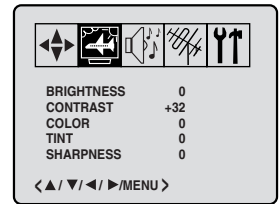

3 Press ▲ or ▼ to select the item you want to adjust.

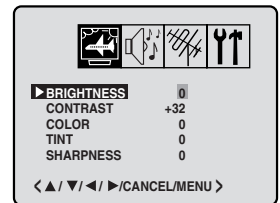

4 Press ◀ or ▶ to adjust the setting.

Selection	◀ Pressing	▶
BRIGHTNESS	darker	lighter
CONTRAST	lower	higher
COLOR	paler	deeper
TINT	reddish	greenish
SHARPNESS	softer	sharper

5 After your desired setting press **MENU** until the MENU screen is cleared.

CANCEL

Pressing **CANCEL** while making picture adjustments will return all adjustments to the factory preset levels.

NOTE:

The CONTRAST default setting is set to maximum at the factory.

Sound control adjustment

Sound controls are factory preset but you can adjust them individually as follows:

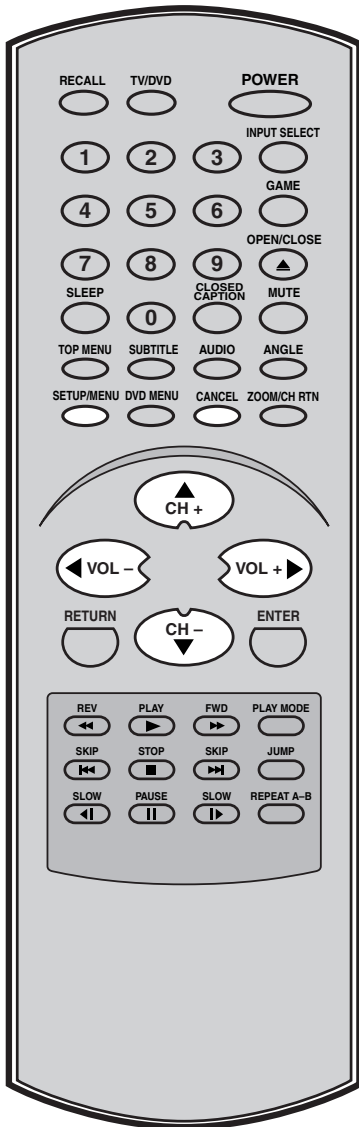

1 Press **MENU** in the TV mode. The TV menu screen will appear.

2 Press ◀ or ▶ until the AUDIO menu appears.

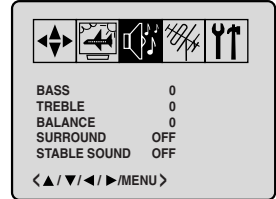

3 Press ▲ or ▼ to select the item you want to adjust.

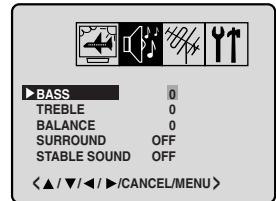

4 Press ◀ or ▶ to adjust the setting.

BASS:

Press ◀ or ▶ to adjust the bass sound.

TREBLE:

Press ◀ or ▶ to adjust the treble sound.

BALANCE:

Press ◀ or ▶ to obtain an equal sound level from both speakers.

SURROUND:

Press ◀ or ▶ to select "ON" or "OFF".

ON: The dynamic presence and sound created offers a thoroughly enjoyable listening experience.

OFF: Normal sound.

STABLE SOUND:

Press ◀ or ▶ to select "ON" or "OFF".

ON: The STABLE SOUND feature limits the highest volume level to prevent extreme changes in volume when the signal source is changed.

OFF: Normal sound.

5 After your desired setting press **MENU** until the MENU screen is cleared.

CANCEL

Pressing **CANCEL** while making sound adjustments will return all adjustments to the factory preset levels.

Stereo and Second Audio Program (SAP)

The TV/DVD is equipped with a feature known as Multi-channel TV Sound or MTS. MTS broadcasts greatly enhance TV viewing by bringing you programs with high fidelity stereo sound. MTS also provides an extra channel called the Second Audio Program or SAP which broadcasters can use to transmit a second language for bilingual transmission or for other purposes.

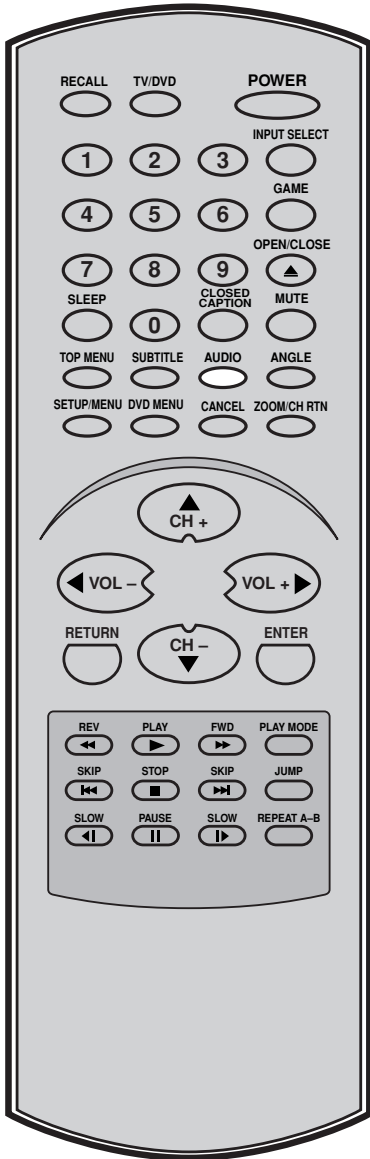

LISTENING TO STEREO SOUND

When the TV is turned on or a channel selection is made, make certain the STEREO appears on the screen. This means that "Stereo" broadcasting is available. You can enjoy stereo sound from the left and right speakers.

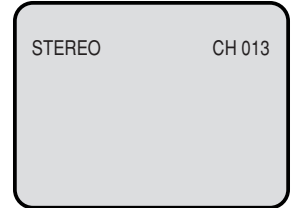

- When "Mono" broadcasting is received, no indication is displayed.
- If the broadcast signal is not strong enough or clear stereo sound is not available, press **AUDIO** to change to mono sound. The noise should be eliminated. Press it again to return to the stereo sound.

LISTENING TO SAP (SECOND AUDIO PROGRAM)

When the TV is turned on or a channel selection is made, make certain the SAP appears on the screen. This means that the "Second Audio Program" broadcasting is available.

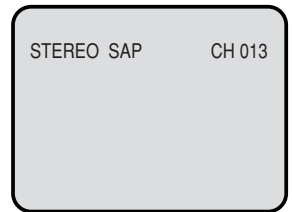

TO SELECT DESIRED SOUND

Press **AUDIO** to select the desired sound.

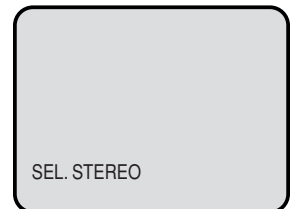

MONO+SAP BROADCASTING

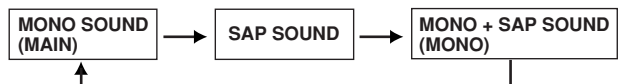

STEREO+SAP BROADCASTING

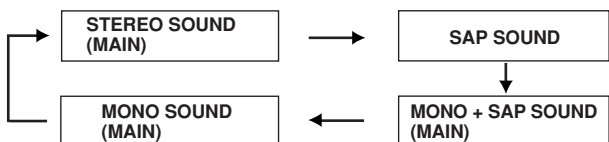



About this owner's manual

This owner's manual explains the basic instructions of this TV/DVD. Some DVD video discs are produced in a manner that allows specific or limited operation during playback. As such, the TV/DVD may not respond to all operating commands. This is not a defect in the TV/DVD. Refer to instruction notes of discs.

"⊙" may appear on the TV screen during operation. A "⊙" means that the operation is not permitted by the TV/DVD or the disc at the moment. For example, it is unable to stop the playback of copyright message of the disc when the STOP(■) button is pressed. Alternatively, the "⊙" may also indicate that the feature is not available for the disc.

Notes on region numbers

The region number of this TV/DVD is 1. If region numbers, which stand for their playable area, are printed on your DVD video disc and you do not find or , disc playback will not be allowed by the player. (In this case, the TV/DVD will display a message on-screen.)

On Video CDs

This TV/DVD supports Video CDs equipped with the PBC (Version 2.0) function. (PBC is the abbreviation of Playback Control.) You can enjoy two playback variations depending on types of discs.

- **Video CD not equipped with PBC function (Version 1.1)**
Sound and movie can be played on this TV/DVD in the same way as an audio CD.
- **Video CD equipped with PBC function (Version 2.0)**
In addition to operation of a Video CD not equipped with the PBC function, you can enjoy playback of interactive software with search function by using the menu displayed on the TV screen (Menu Playback). Some of the functions described in this owner's manual may not work with some discs.

Playable discs

This TV/DVD can play the following discs.

	Disc Mark	Contents	Disc Size	Maximum playback time
DVD video discs		Audio + Video (moving pictures)	12 cm	Approx. 4 hours (single sided disc)
				Approx. 8 hours (double sided disc)
			8 cm	Approx. 80 minutes (single sided disc)
				Approx. 160 minutes (double sided disc)
Video CDs		Audio + Video (moving pictures)	12 cm	Approx. 74 minutes
			8 cm	Approx. 20 minutes
Audio CDs		Audio	12 cm	Approx. 74 minutes
			8 cm (CD single)	Approx. 20 minutes
<p>The following discs are also available.</p> <ul style="list-style-type: none"> ● CD-R ● CD-RW <p>CD-R/RW discs recorded by CD-DA method can be played. Some CD-R/RW discs may be incompatible.</p>				

- You cannot play discs other than those listed above.
- You cannot play discs of DVD-RAM, DVD-RW, etc., or non standardized discs even if they may be labeled as above.
- This TV/DVD uses the NTSC color system, and cannot play DVD video discs recorded in any other color system (PAL, SECAM, etc.).

Preparation/Status display of disc/To turn off the PBC

The following pages describe the setup/operation in DVD mode.

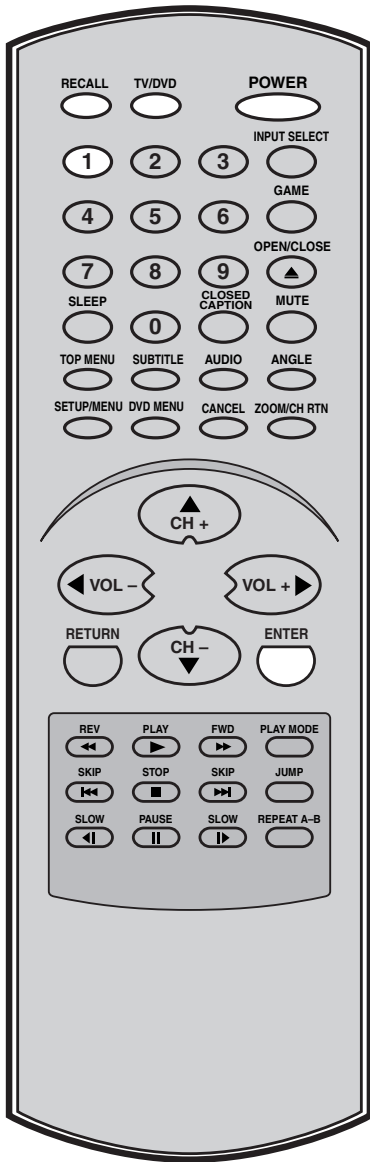

NOTE:
If the unit does not operate properly: Static electricity, etc., may affect the player's operation. Disconnect the AC power cord once, then connect it again.

Preparation

Before DVD/CD operation, please make preparations as follows.

- 1 Insert the AC cord plug into a standard 120V 60Hz polarized AC outlet.
 - If the AC cord plug is plugged in for the first time, wait for about 5 seconds before pressing **POWER**.

NOTE: When connecting to other equipment, unplug the unit from the AC outlet.

- 2 Press **POWER** on the unit or on the remote control to turn on the unit. The **POWER** indicator will light.
 - Every time you press **POWER**, the TV/DVD starts from TV mode.
 - When using an amplifier, switch on the amplifier.

- 3 Press **TV/DVD** to select DVD mode. The DVD startup screen will appear on the screen.

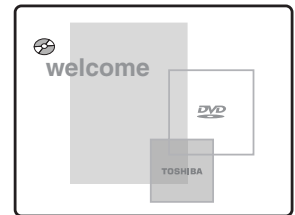

Status display of disc

Press **RECALL**. The status display of the disc will appear on the screen.

DVD

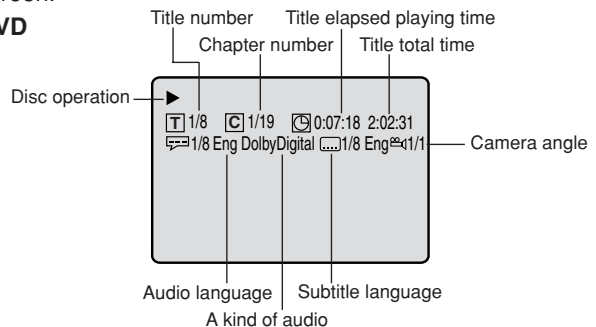

To make status display disappear, press **RECALL** again.

Audio CD/Video CD

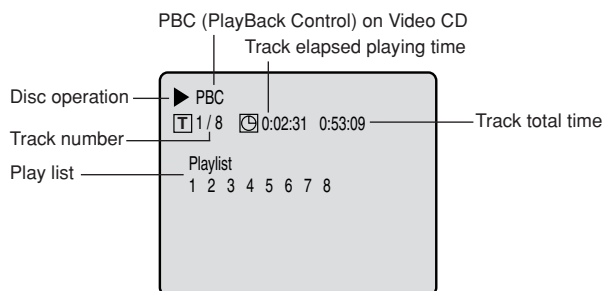

- When you play the CD disc, the status display will appear on the screen and continue displaying.
- When you play the Video CD, Playlist will not appear on the screen.

To turn off the PBC

Press **Number button 1** in the stop mode, then press **ENTER**.

Playback procedure

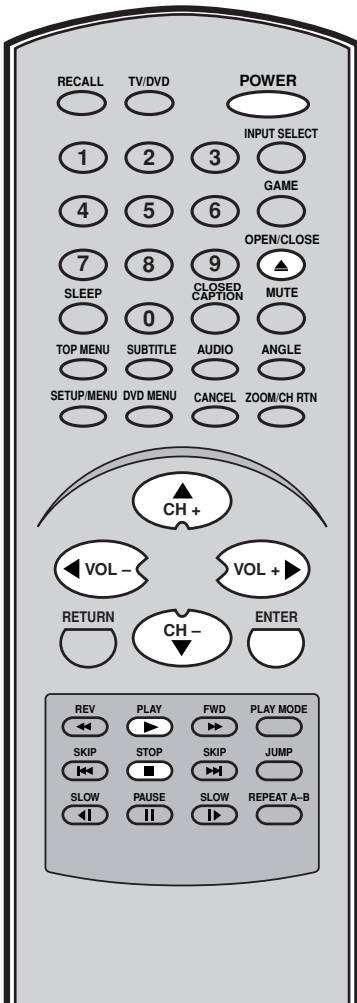

NOTES:

- If a non-compatible disc is loaded, "Incorrect Disc", "Region Code Error" or "Parental Error" will appear on the TV screen according to the type of loaded disc. If these appear, check your disc again (see pages 22 and 33).
- Some discs may take a minute or so to start playback.
- When you set a single-faced disc label downwards (ie. the wrong way up) and press **PLAY** or **OPEN/CLOSE** on the unit, "No Disc" will appear on the display and then "No Disc" or "Incorrect Disc" will be displayed.
- Some discs may not work the resuming facility.
- Some playback operations of DVDs may be intentionally fixed by software producers. Since this unit plays DVDs according to the disc contents the software producers designed, some playback features may not be available. Also refer to the instructions supplied with the DVDs.

- 1 Press **OPEN/CLOSE** on the unit or the remote control.
The disc tray will open.

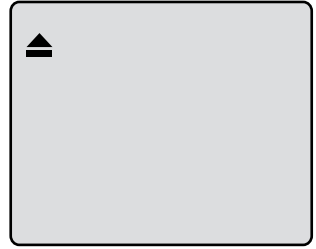

- 2 Place a disc onto the tray. Position it with the printed label side up, align it with the guides, and place it in its proper position.

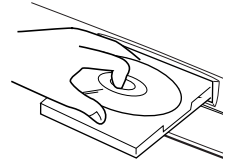

- 3 Press **OPEN/CLOSE** or **PLAY**.
The disc tray closes automatically. On the TV screen, "▲" changes to "Ⓢ" and then playback commences.

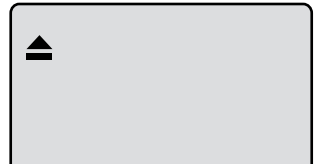

- A menu screen will appear on the TV screen, if the disc has a menu feature.



- 4 Press ▲/▼ or ◀/▶ to make a selection.

- 5 Press **ENTER**.
• Title is selected and play commences.

- 6 Press **STOP** to end playback.
 - The unit memorizes the stopped point, depending on the disc. "■" appears on the screen. Press **PLAY** to resume playback (from the scene point). Resuming cannot function when you play a PBC-featured Video CD while the PBC is on. To turn off the PBC, see page 23.
 - If you press **STOP** again or unload the disc ("■" appears on the screen.), the unit will clear the stopped point.

- 7 To stop the playback, press **STOP**. Then press **OPEN/CLOSE**.
The disc tray opens. Remove the disc and then press **POWER**.
The disc tray closes automatically and unit turns off.

Special playback

Note: There may be a slight delay between when you press the button and the function activating.

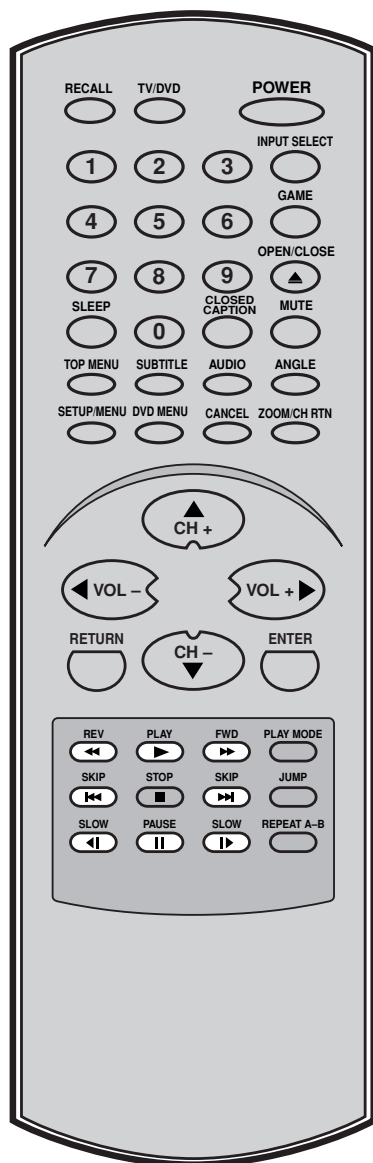

NOTE:

The unit is capable of holding a still video image or On screen display image on your television screen indefinitely. If you leave the still video image or On screen display image displayed on your TV for an extended period of time, you risk permanent damage to your television screen. Projection televisions are very susceptible.

Fast Forward Playback

Press **FWD** during normal playback.

Each press of **FWD** will increase the speed of the search

▶▶ [x 2], ▶▶▶▶ [x 4], ▶▶▶▶▶▶ [x 8], ▶▶▶▶▶▶▶▶ [x 15].

(CD: ▶▶ [x 2], ▶▶▶▶ [x 4], ▶▶▶▶▶▶ [x 8], ▶▶▶▶▶▶▶▶ [x 20])

- To resume normal playback, press **PLAY**.

Review Playback

Press **REV** during normal playback.

Each press of **REV** will increase the speed of the search

◀◀ [x 2], ◀◀◀◀ [x 4], ◀◀◀◀◀◀ [x 8], ◀◀◀◀◀◀◀◀ [x 15].

(CD: ◀◀ [x 2], ◀◀◀◀ [x 4], ◀◀◀◀◀◀ [x 8], ◀◀◀◀◀◀◀◀ [x 20])

- To resume normal playback, press **PLAY**.

Still Playback

Press **PAUSE** during normal playback to pause playback.

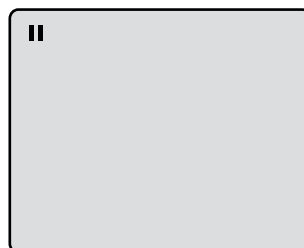

- To resume normal playback, press **PLAY**.

Frame Advance

Press **PAUSE** during still playback.

One frame is advanced each time you press **PAUSE**.

- To resume normal playback, press **PLAY**.

Slow-motion Playback

Press **SLOW** (◀) Reverse or **SLOW** (▶) Forward during normal playback or still playback.

Each press of **SLOW** will change the speed of the slow x1/2, x1/4, x1/6, x1/8.

NOTE: The Video CD can not play Reverse SLOW.

- To resume normal playback, press **PLAY**.
- To resume the still playback, press **PAUSE**.

Locating a chapter or track

Press **SKIP** (▶▶▶) Forward or **SKIP** (◀◀◀) Reverse during playback to locate a chapter or track that you want to watch.

- Press **SKIP** (▶▶▶) briefly to select the next chapter/track.
- Press **SKIP** (◀◀◀) briefly to return to the beginning of the current chapter/track.
- Press **SKIP** (◀◀◀) twice in quick successions to select the previous chapter/track.

Zooming/Locating desired scene

Zooming

This unit will allow you to zoom in on the frame image. You can then make selections by switching the position of the frame.

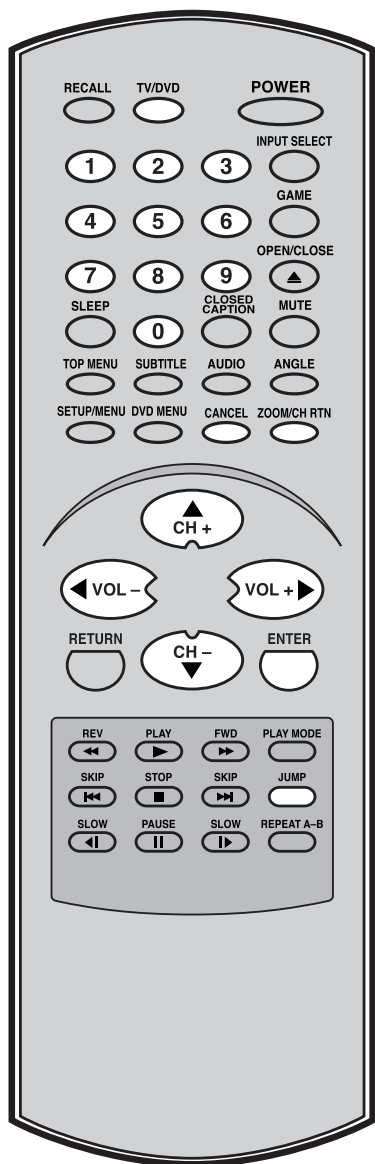

- 1 Press **TV/DVD** to select DVD mode.
Press **ZOOM** during playback.

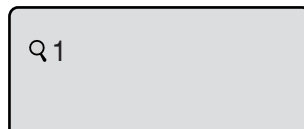

The center part of the image will be zoomed in.
Each press of **ZOOM** will change the ZOOM Q1 (x 2), Q2 (x 3) and Q3 (x 4).

- 2 Press **▲/▼/◀/▶** to view a different part of the frame. You may move the frame from the centre position to UP, DOWN, LEFT or RIGHT direction.
- 3 In the zoom mode press **ZOOM** repeatedly to return to a 1:1 view (Q Off).

Locating desired scene

Use the title, chapter and time recorded on the disc to locate the desired point to play back.

- 1 Press **JUMP** during playback.

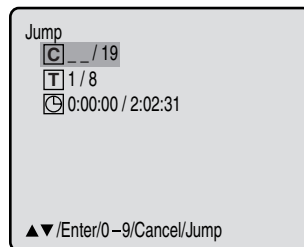

- 2 Press **▲** or **▼** to select the "**C**" (Chapter)", "**T**" (Title/Track)" or "**⌚**" (Time)".
- 3 Press **Number buttons (0-9)** to input the number.
 - If you input a wrong number, press **CANCEL**.
 - Refer to the package supplied with the disc to check the numbers.
- 4 Press **ENTER**.
 - Playback starts.
 - When you change the title, playback starts from Chapter 1 of the selected title.
 - Some discs may not work in the above operation.

NOTES:

- You can select the Pause, Slow or Search playback in the zoom mode.
- Some discs may not respond to zoom feature.

Repeat, Random and Program playback/Repeat A-B

Press **PLAY MODE** during playback or stop mode.
Each time you press **PLAY MODE**, playback mode changes as follows.

DVD

On screen display	Operation
→ Title:	Repeats the current title.
↓ Chapter:	Repeats the current chapter.
↓ Off:	Resumes normal playback.

- During stop mode, **PLAY MODE** key is not effective.

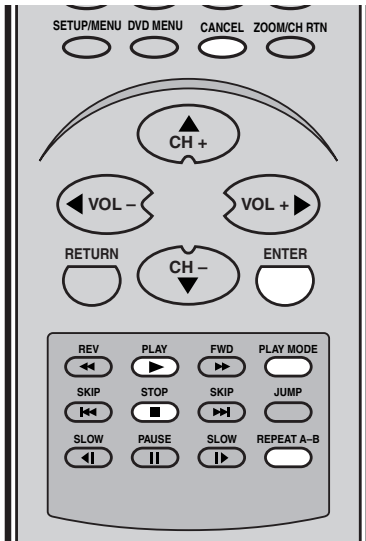

NOTES:

- If you put a wrong number, press **CANCEL**.
- To cancel program play, press **STOP** 3 times.
- To clear the programs on the program menu, press **CANCEL** until all programs will be cleared.
- The program is cancelled when you open the disc tray or turn off the power.

Repeat A-B

Repeat A-B playback allows you to repeat material between two selected points.

- 1 Press **REPEAT A-B** during playback.
The start point is selected.
- 2 Press **REPEAT A-B** again.
The end point is selected. Playback starts at the point that you selected. Playback stops at the end point, returns to Point A automatically, then starts again.
To resume normal playback press **REPEAT A-B** again.
" Off" appears on the screen.

NOTES:

- Some discs may not work with the repeat operation.
- In Repeat A-B mode, subtitles near point A or B may not appear.
- You may not be able to set Repeat A-B, depending on the scenes of the DVD.
- Repeat A-B does not work with interactive DVDs.
- Repeat & Repeat A-B function is prohibited when PBC is on.

Audio CD/Video CD

On screen display	Operation
→ All:	Repeats entire disc.
↓ Track:	Repeats the current track.
↓ Off:	Resumes normal playback
↓ Random Play:	Plays the tracks in random order.
↓ *Program:	Plays the tracks in program order.
↓ (Status display):	Resumes normal playback.

- During stop mode, you cannot select " Track".
- For Audio CD discs, " Off" does not appear.
- Status display is only for Audio CD.
- Random playback and Program playback do not function on the Video CD.

*Program menu

Use **number buttons (0-9)** to enter the track's number you want to program, then press **ENTER**. The track number and total time are displayed. Repeat this step to enter additional tracks. When you have finished entering tracks, press **PLAY** to start Program playback.
A playlist of your programmed tracks is displayed.

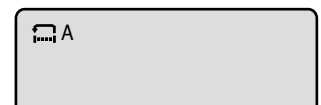
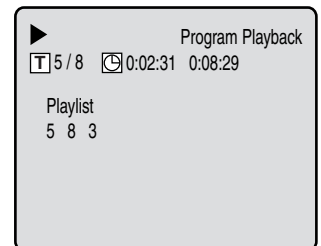
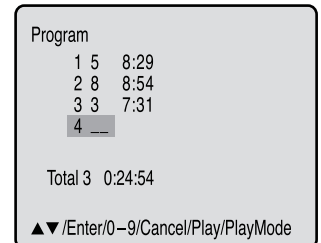

Changing soundtrack language/Subtitles

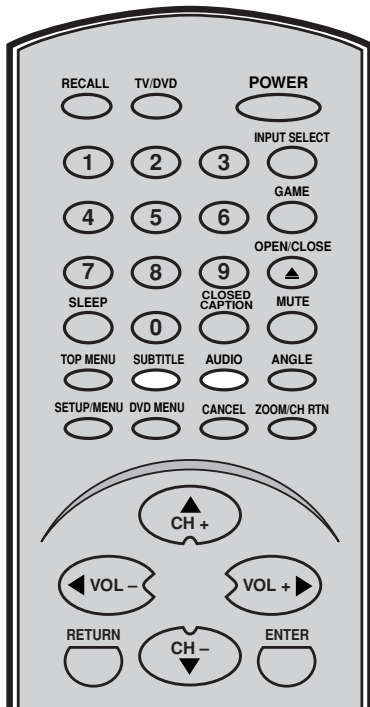

NOTES:

- If the desired language is not heard after pressing the SUBTITLE button several times, the language is not recorded on the disc.
- Changing soundtrack language is cancelled when you open the disc tray. The initial default language or available language will be heard if the disc is played back again.
- Changing subtitle language is cancelled when you open the disc tray.
- Some functions may not work on some DVDs. You may not be able to turn subtitles on or off or change subtitles. While playing the DVD, the subtitle may change when:
 - you open or close the disc tray.
 - you change the title.
- In some cases, the subtitle language is not changed to the selected one immediately.

Changing soundtrack language

You can select the language when you play a multilingual disc.

- 1 Press **AUDIO** during playback.

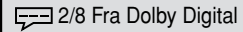

The current soundtrack language will appear.

- 2 Press **AUDIO** repeatedly until the desired language is selected.

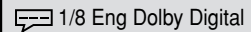

The on-screen display will disappear after a few seconds.

In case of Video CD playback

Audio type changes as follows each time you press **AUDIO**.

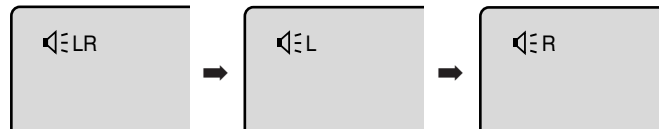

Subtitles

Turning the Subtitles On and Off

When playing back a disc recorded with subtitles, you can turn the subtitles on or off.

Press **SUBTITLE** during playback until "Off" appears.



Changing the subtitle language

You can select the language when playing back a disc recorded with multilingual subtitles.

- 1 Press **SUBTITLE** repeatedly during playback until your desired language appears.

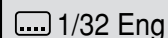

- 2 The on-screen display will disappear after a few seconds.

Changing angles/Title selection/DVD menu

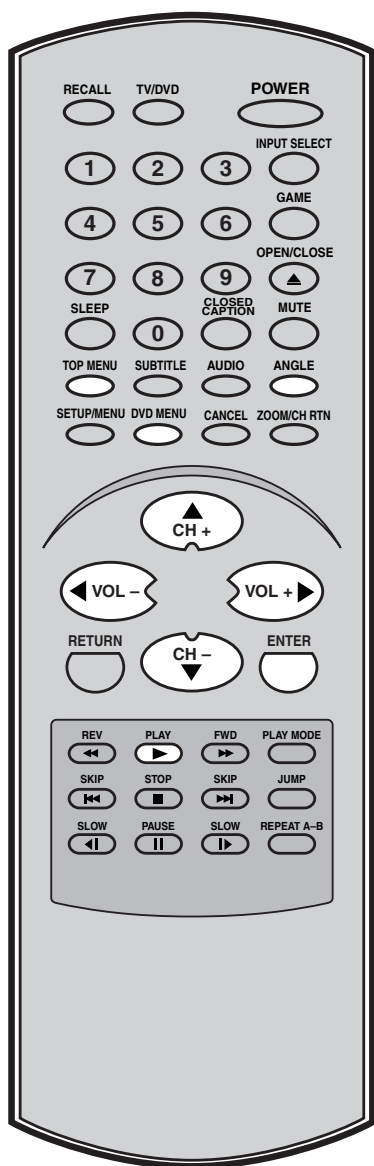

NOTES:

- Depending on the DVD, you may not be able to change the angles even if multi-angles are recorded on the DVD.
- Depending on the DVD, you may not be able to select the title. Depending on the DVD, a "title menu" may simply be called a "menu" or "title" in the instructions supplied with the disc.

Changing angles

When playing back a disc recorded with multi-angle facility, you can change the view angle.

- 1 Press **ANGLE** during playback.

The current angle will appear.

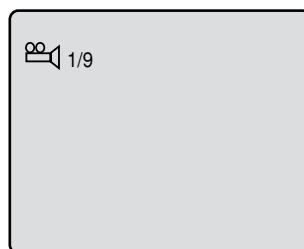

- 2 Press **ANGLE** repeatedly until the desired angle is selected.

Title selection

Two or more titles are recorded on some discs. If the title menu is recorded on the disc, you can select the desired title.

- 1 Press **TOP MENU** during playback.
Title menu appears on the screen.
- 2 Press **▲/▼** or **◀/▶** to select the desired title.
- 3 Press **ENTER** or **PLAY**.
The playback of the selected title will start.

DVD menu

Some DVDs allow you to select the disc contents using the menu.

When you play back these DVDs, you can select the subtitle language and soundtrack language, etc. using the DVD menu.

- 1 Press **DVD MENU** during playback.
The DVD menu appears on the screen.
 - Press **DVD MENU** again to resume playback at the scene when you pressed **DVD MENU**.
- 2 Press **▲/▼** or **◀/▶** to select the desired item.
- 3 Press **ENTER**.
The menu continues to another screen. Repeat steps 2 and 3 to set additional items if any.

Setting language

You can change the default settings to customise performance to your preference.

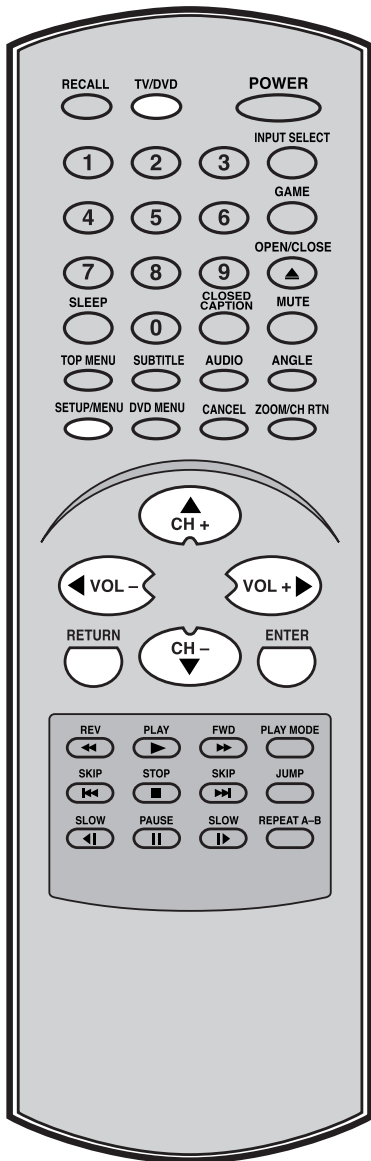

- 1 Press **TV/DVD** to select DVD mode.
Press **SETUP** in the stop mode.
Press **▲** or **▼** to select "Language", then press **▶** or **ENTER**.

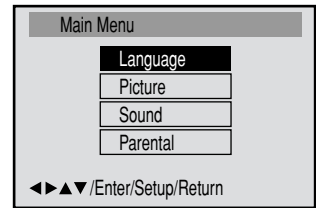

- 2 Press **▲** or **▼** to select "OSD Language", then press **▶** or **ENTER**.

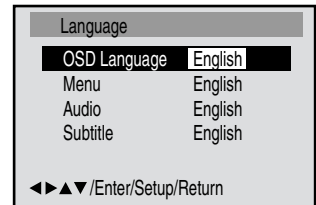

- 3 Press **▲** or **▼** to select desired language (e.g. English), then press **ENTER**.
The menu returns to "Language" menu automatically.

- If you want to return to the previous menu, press **◀** or **RETURN**.

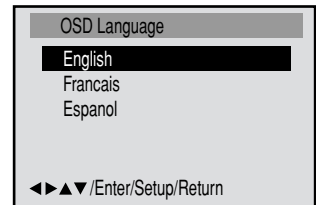

- 4 Repeat steps 2-3 for other "Language" setting.

Other: (Menu/Audio/Subtitle)

If you want to select another language, enter the language code (see the Language code list on page 38).

Off: (subtitle)

Subtitles do not appear.

- 5 Press **SETUP** to remove the Menu screen.

NOTES:

- If the selected soundtrack language is not recorded on the disc, the original language will be heard.
- If the selected subtitle language is not recorded on the disc, the first-priority language is selected.

Setting the aspect ratio of TV screen/Setting on screen display

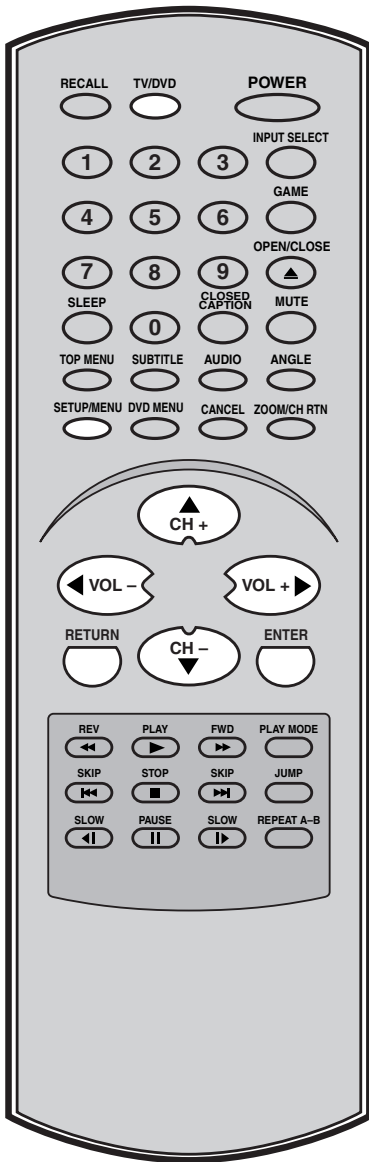

NOTE:
If the DVD disc is not formatted in the pan & scan style, it displays 4:3 style.

Setting the aspect ratio of TV screen

You can select the aspect ratio for your TV.

- 1 Press **TV/DVD** to select DVD mode.
Press **SETUP** in the stop mode or No Disc.
Press **▲** or **▼** to select "Picture", then press **▶** or **ENTER**.

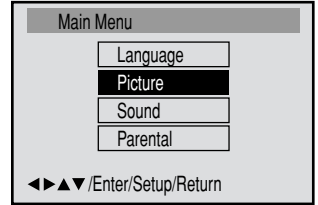

- 2 Press **▲** or **▼** to select "TV Screen", then press **▶** or **ENTER**.

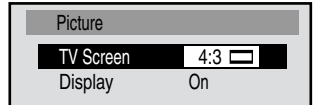

- 3 Press **▲** or **▼** to select your desired screen type, then press **ENTER**.

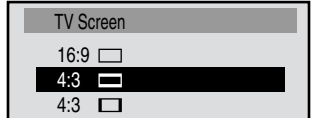

You have the following screen sizes to choose from:

16:9 : (Wide screen)

Select this mode when connecting to a wide-screen TV. A wide screen picture is displayed full size.

4:3 : (Letterbox)

Select this mode when connecting to a conventional TV. When playing back a wide screen-DVD disc, it displays the wide picture with black bands at the top and bottom of screen.

4:3 : (Panscan)

It displays the wide picture on the whole screen with left and right edges automatically cut off.

- If you want to return to the previous menu, press **◀** or **RETURN**.

- 4 Press **SETUP** to remove the Menu screen.

Status on screen display

On screen display can be switched on or off when you press the buttons.

- 1 Press **SETUP** in the stop mode or No Disc.
Press **▲** or **▼** to select "Picture", then press **▶** or **ENTER**.

- 2 Press **▲** or **▼** to select "Display".

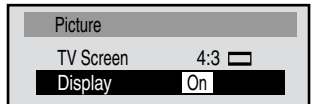

- 3 Press **▶** or **ENTER** to select "On" or "Off".

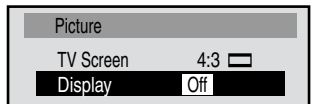

On: On screen displays appear when you press the buttons (factory setting).

Off: On screen displays do not appear when you press any buttons.

- If you want to return to the previous menu, press **◀** or **RETURN**.

- 4 Press **SETUP** to remove the Menu screen.

Dynamic Range Control

DRC (Dynamic Range Control) enables you to control the dynamic range so as to achieve a suitable sound for your equipment.

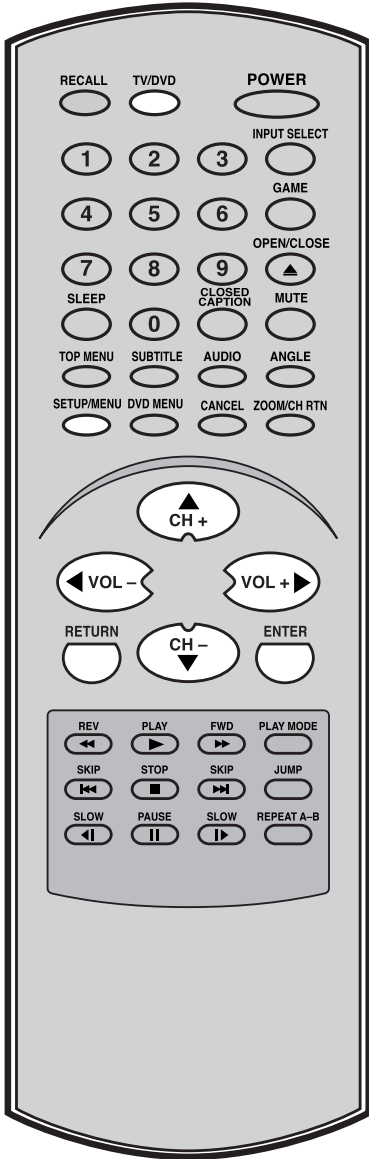

- 1 Press **TV/DVD** to select DVD mode.
Press **SETUP** in the stop mode.
Press **▲** or **▼** to select "Sound".

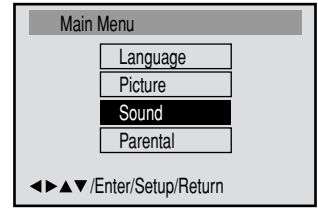

- 2 Press **▶** or **ENTER** to select "DRC".

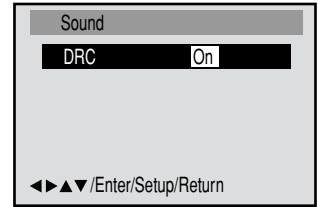

- 3 Press **▶** or **ENTER** to select "On" or "Off".

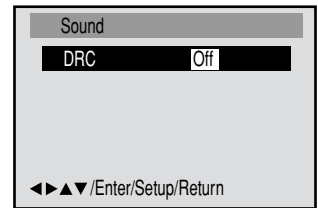

- If you want to return to the previous menu, press **◀** or **RETURN**.

- 4 Press **SETUP** to remove the Menu screen.

NOTES:

- This function works only during playback of Dolby Digital recorded discs.
- The level of Dynamic Range Reduction may differ depending on DVD video disc.

Parental control setting

Some discs are specified not suitable for children. Such discs can be limited not to play back with the unit.

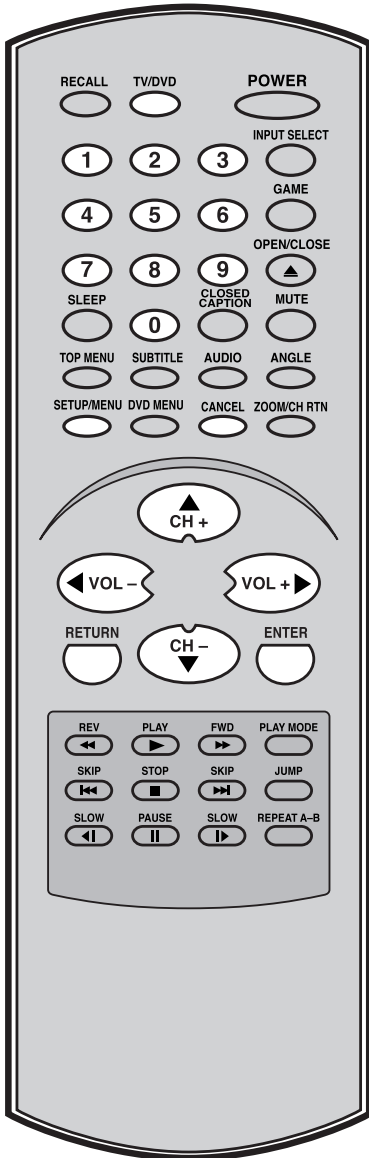

NOTES:

- If each setup (pages 30~34) has been completed, the unit can always be worked under the same conditions (especially with DVD discs). Each setup will be retained in the memory when you turn the power off.
- Depending on the discs, the unit cannot limit playback.
- Some discs may not be encoded with specific rating level information though its disc jacket says "adult." For those discs, the age restriction will not work.

- 1 Press **TV/DVD** to select DVD mode. Press **SETUP** in the stop mode. Press **▲** or **▼** to select "Parental", then press **▶** or **ENTER**.

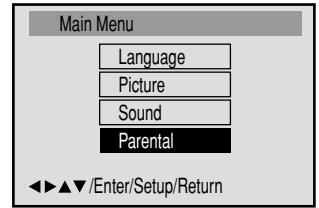

- 2 Press **▲** or **▼** to select "Parental Level", then press **▶** or **ENTER**.

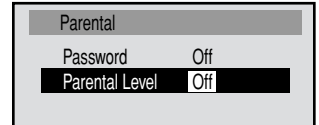

- 3 Press **▲** or **▼** to select a level from Off or 1–8. Press **▶** or **ENTER** to set the selected level.

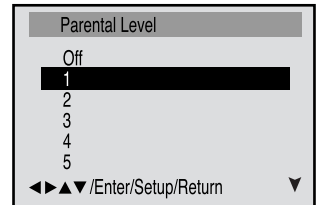

- **Level Off:** The parental control setting does not function.
- **Level 8:** Almost all DVD software can be played back.
- **Level 1:** DVD software for adults cannot be played back.
- Select from the level 1 to level 8. The limitation will be more severe as the level number is lower.

- 4 Press **▲** or **▼** to select "Password", then press **▶** or **ENTER**.

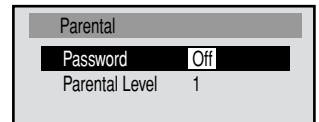

- 5 Press **number buttons (0–9)** for the password. Don't forget the password. If you input a wrong number, press **CANCEL**.

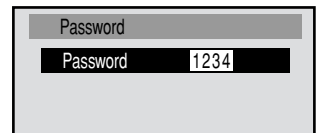

- 6 Press **ENTER** to store the password. **Note:** Now the rating is locked and the setting cannot be changed unless you enter the correct password.

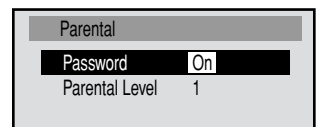

- If you want to return to the previous menu, press **◀** or **RETURN**.

- 7 Press **SETUP** to remove the parental control screen.

To change the parental level

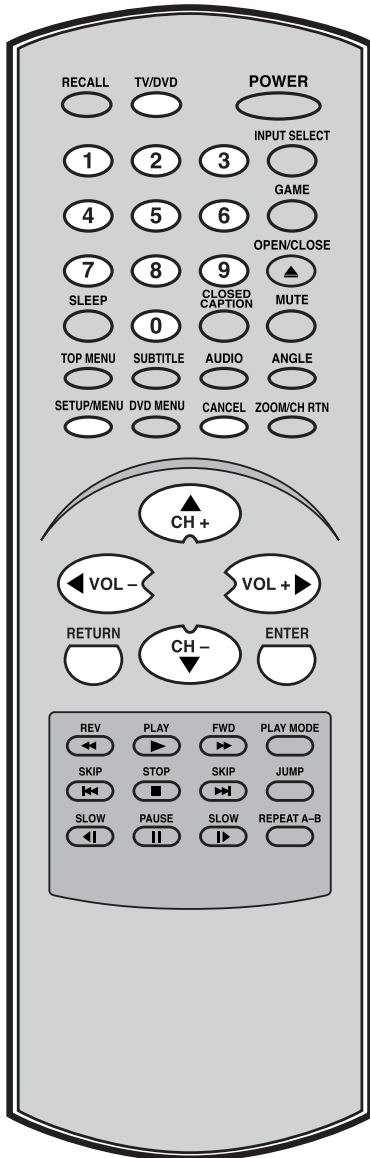

NOTE:

Do not forget the password. If you forget the password, contact the dealer that you purchased the unit from.

1 Press **TV/DVD** to select DVD mode.
Press **SETUP** in the stop mode or No Disc.
Press **▲** or **▼** to select "Parental", then press **▶** or **ENTER**.

2 Press **▲** or **▼** to select "Password", then press **▶** or **ENTER**.

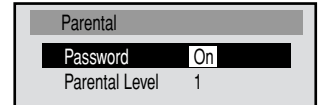

3 Press **number buttons (0–9)** to enter the password you have stored.

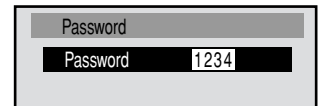

• If you input a wrong number, press **CANCEL**.

4 Press **ENTER**.
The password is now Off.

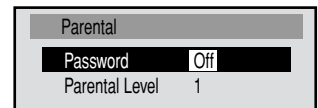

5 Press **▲** or **▼** to select "Parental Level". Then press **▶** or **ENTER**. The Parental Level screen is displayed.

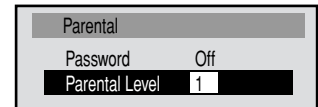

6 Press **▲** or **▼** to select a level from Off or 1–8 and then press **▶** or **ENTER**.

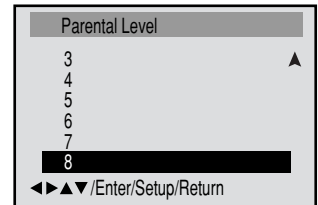

7 Press **▲** or **▼** to select "Password" and then press **▶** or **ENTER**.

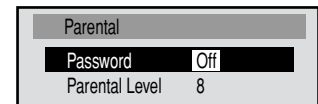

8 Press **number buttons (0–9)** to enter a 4-digit password.

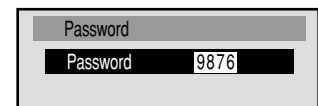

Note: You can enter a new password.

9 Press **ENTER**.
The parental level is now changed and locked.

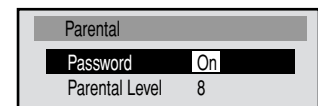

• If you want to return to the previous menu, press **◀** or **RETURN**.

10 Press **SETUP** to remove the parental control screen.

Temporary disabling of rating level by DVD disc

Depending on the DVD disc, the disc may try to temporarily cancel the rating level that you have set. It is up to you to decide whether to cancel the rating level or not.

- 1 Load a DVD disc and press **PLAY** (see page 24).

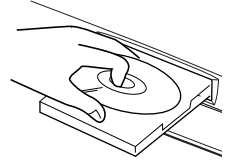

- 2 If the DVD disc has been designed to temporarily cancel the Rating level, the screen which appears after inserting a DVD will change, depending on which disc is played. If you select "YES" with the **ENTER** key, "Your disc exceeds the parental control level." screen will then appear.

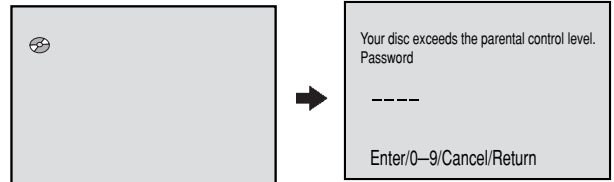

- 3 If you wish to cancel the set rating level temporarily, enter the 4-digit password. Then press **ENTER**. Alternatively, if the password has not been set, playback will commence. If you don't know (or have forgotten) the password, select "STOP". The setting screen will disappear. Press **OPEN/CLOSE** to remove the disc.

To quit entering, press **RETURN**.

- 4 Playback will commence if the entered password was correct.

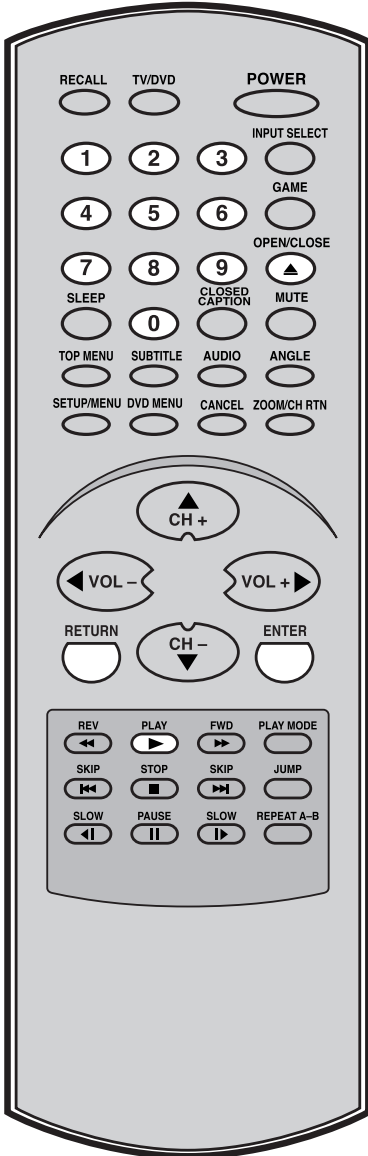

NOTE:

This temporary cancellation of rating level will be kept until the disc is ejected. When the disc is ejected, the original rating level will be set again automatically.

Connections to other equipments

The exact arrangement you use to interconnect various video and audio components to the TV/DVD is dependent on the model and features of each component. Check the Owner's Manual provided with each component for the location of video and audio inputs and outputs.

Using an AV Amplifier with built-in digital surround

If you are using an Amplifier with a built-in digital surround as follows, you can enjoy the various audio systems including Dolby Digital Surround audio that sounds just like the movie.

Connect an AV amplifier with built-in Dolby Digital decoder, DTS decoder, MPEG decoder or etc as shown below.

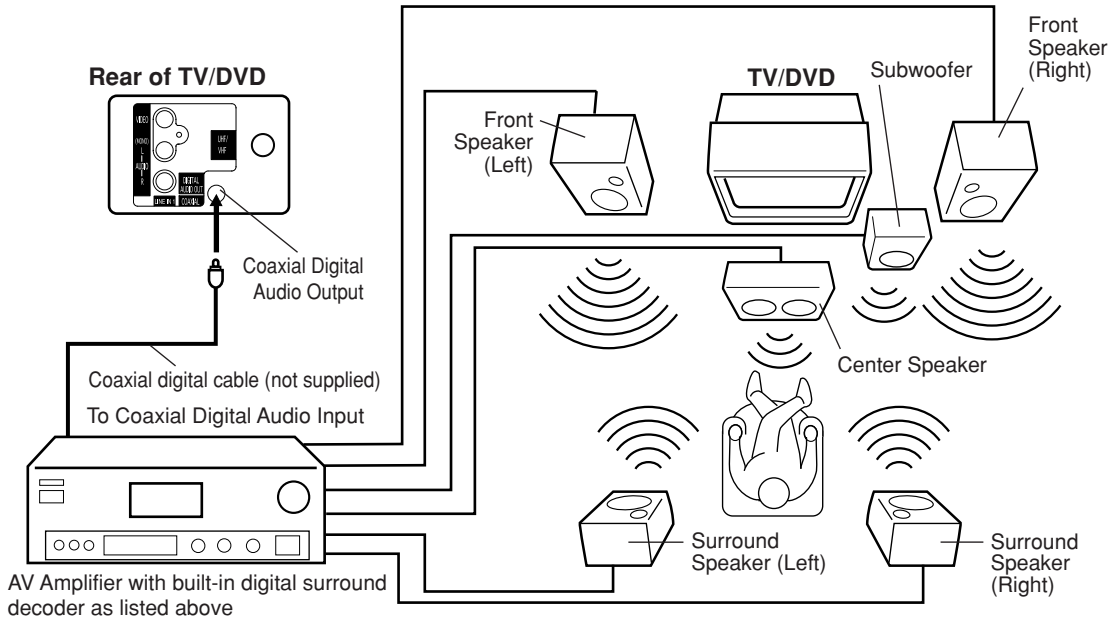

* Manufactured under license from Dolby Laboratories. "Dolby" and the double-D symbol are trademarks of Dolby Laboratories. Confidential unpublished works. © 1992-1997 Dolby Laboratories, Inc. All rights reserved.

* "DTS" and "DTS Digital Out" are trademarks of Digital Theater Systems, Inc.

NOTES:

- When you make the connections above, do not set DOLBY DIGITAL to DOLBY DIGITAL, MPEG to MPEG to ON on the AV Amplifier. If you do, a loud noise will suddenly come out from the speakers, affecting your ears or causing the speakers to be damaged.
- When playing DTS-encoded CDs, only noise will be heard from the speakers or analogue stereo outputs.
- Some DTS decoders which do not support DVD-DTS interface may not work properly with the unit.

Using the audio/video inputs

If you connect the TV/DVD to VCR, camcorder or TV game, you can select by pressing **INPUT SELECT**.

Press **INPUT SELECT** repeatedly to select the desired mode. "LINE1", "LINE2" or TV channel will display on the screen for 4 seconds.

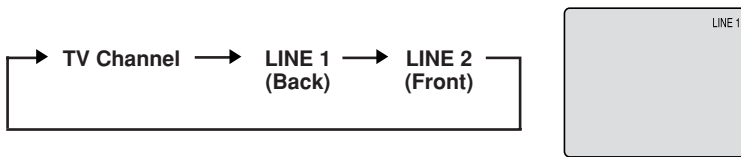

NOTE:

In the DVD mode this key will not operate.

1. To connect the TV/DVD to a VCR

Press the **INPUT SELECT** to select the desired mode to use the TV as a monitor. Operate your VCR as usual.

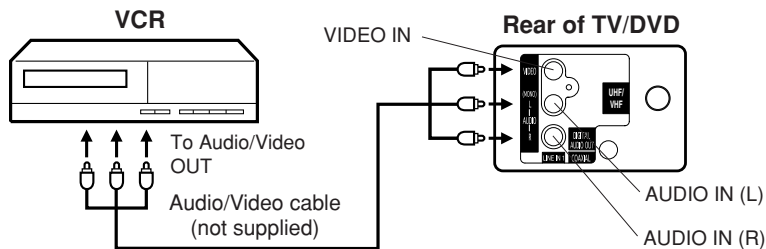

2. To connect the TV/DVD to a camcorder

To playback from the camcorder, connect the camcorder to the TV/DVD as shown.

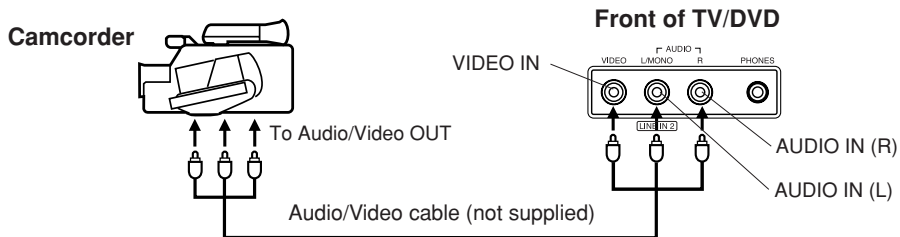

3. To connect the TV/DVD to a TV Game

You can enjoy playing a TV game on the screen by adjusting to suitable brightness for your eyes.

1. Connect a TV Game

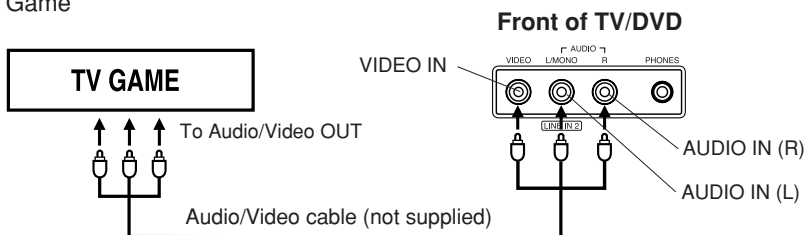

2. Press **GAME** during Power off. The TV/DVD turns on and the GAME screen appears.

Game timer function: After one hour the Game timer display will appear every 30 minutes for about 5 seconds showing how long the time has passed up to 4 hours.

NOTES:

- You can also change the TV screen to LINE2 by pressing **INPUT SELECT**. But this screen is normal.
- The TV/DVD can also be used as a display device for many video games. However, due to the wide variety of different types of signal generated by these devices and subsequent hook-up variations required, they have not all been included in the suggested connection diagrams. You'll need to consult each component's Owner's Manual for additional information.

Language code list

Enter the appropriate code number for the initial settings “Menu”, “Audio” and/or “Subtitle” (see page 30).

Language name	Code	Language name	Code	Language name	Code	Language name	Code
Abkhazian	1112	Fiji	1620	Lingala	2224	Singhalese	2919
Afar	1111	Finnish	1619	Lithuanian	2230	Slovak	2921
Afrikaans	1116	French	1628	Macedonian	2321	Slovenian	2922
Albanian	2927	Frisian	1635	Malagasy	2317	Somali	2925
Amharic	1123	Galician	1722	Malay	2329	Spanish	1529
Arabic	1128	Georgian	2111	Malayalam	2322	Sundanese	2931
Armenian	1835	German	1415	Maltese	2330	Swahili	2933
Assamese	1129	Greek	1522	Maori	2319	Swedish	2932
Aymara	1135	Greenlandic	2122	Marathi	2328	Tagalog	3022
Azerbaijani	1136	Guarani	1724	Moldavian	2325	Tajik	3017
Bashkir	1211	Gujarati	1731	Mongolian	2324	Tamil	3011
Basque	1531	Hausa	1811	Nauru	2411	Tatar	3030
Bengali; Bangla	1224	Hebrew	1933	Nepali	2415	Telugu	3015
Bhutani	1436	Hindi	1819	Norwegian	2425	Thai	3018
Bihari	1218	Hungarian	1831	Oriya	2528	Tibetan	1225
Breton	1228	Icelandic	1929	Panjabi	2611	Tigrinya	3019
Bulgarian	1217	Indonesian	1924	Pashto, Pushto	2629	Tonga	3025
Burmese	2335	Interlingua	1911	Persian	1611	Turkish	3028
Byelorussian	1215	Irish	1711	Polish	2622	Turkmen	3021
Cambodian	2123	Italian	1930	Portuguese	2630	Twi	3033
Catalan	1311	Japanese	2011	Quechua	2731	Ukrainian	3121
Chinese	3618	Javanese	2033	Rhaeto-Romance	2823	Urdu	3128
Corsican	1325	Kannada	2124	Romanian	2825	Uzbek	3136
Croatian	1828	Kashmiri	2129	Russian	2831	Vietnamese	3219
Czech	1329	Kazakh	2121	Samoan	2923	Volapük	3225
Danish	1411	Kirghiz	2135	Sanskrit	2911	Welsh	1335
Dutch	2422	Korean	2125	Scots Gaelic	1714	Wolof	3325
English	1524	Kurdish	2131	Serbian	2928	Xhosa	3418
Esperanto	1525	Laothian	2225	Serbo-Croatian	2918	Yiddish	2019
Estonian	1530	Latin	2211	Shona	2924	Yoruba	3525
Faroese	1625	Latvian, Lettish	2232	Sindhi	2914	Zulu	3631

Reception disturbances

Most types of television interference can be remedied by adjusting the height and position of the VHF/UHF antenna. Outdoor antennas are recommended for best results. The most common types of television interference are shown below. If one of these symptoms appear when the TV/DVD is connected to a Cable TV system, the disturbance may be caused by the local Cable TV company broadcast.

IGNITION

Black spots or horizontal streaks may appear, the picture may flutter or drift. Usually caused by interference from automobile ignition systems, neon lamps or AC powered tools and appliances such as drills or hair dryers.



GHOSTS

Ghosts are caused by the television signal following two paths. One is the direct path and the other is reflected by tall buildings, hills or other large objects. Changing the direction or position of the antenna may improve the reception.



SNOW

If the TV/DVD is located far from the TV station, in a fringe reception area where the signal is weak, small dots may appear in the picture. If the signal is extremely weak, the installation of a larger external antenna may be necessary.



RADIO FREQUENCY INTERFERENCE (RFI)

Caused by two-way radios, this type of interference produces moving ripples or diagonal streaks in the picture. Some cases may cause a loss of contrast in the picture. Changing the direction and position of the antenna or installing an RFI filter may improve the picture.

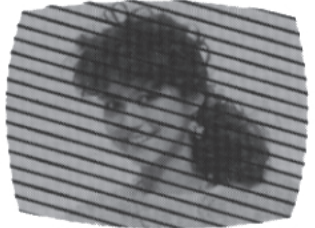

PICTURE SIZE VARIATION

A slight picture size variation is normal when you adjust the CONTRAST or BRIGHTNESS settings.



CARE AND MAINTENANCE

To prevent fire or shock hazard, disconnect the TV/DVD from the power source before cleaning. The finish on the cabinet may be cleaned with mild soap and a soft, damp cloth and cared for as other furniture. Use caution when cleaning or wiping the plastic parts.

Problems and troubleshooting

Use the following check list for troubleshooting when you have problems with your unit. Consult your local dealer or service outlet if problems persist.

Be sure all connections are properly made when using with other units.

SYMPTOMS	POSSIBLE SOLUTIONS	PAGE
POWER		
TV/DVD does not operate.	<ul style="list-style-type: none"> • Make sure the power cord is plugged in. • Try another AC outlet. • Power is off, check fuse or circuit breaker. • Unplug unit, then plug it back in. 	10
TV BROADCAST RECEPTION		
Poor sound or No sound	<ul style="list-style-type: none"> • Station or CATV experiencing problems, tune to another station. • Check Volume adjustments. • Check for sources of possible interference. 	14 14 39
Poor picture or No picture	<ul style="list-style-type: none"> • Station or CATV experiencing problems, tune to another station. • Check antenna or CATV connections, reorient antenna. • Check for sources of possible interference. • Check picture control adjustments. 	14 11,12 39 19
Poor reception on some channels	<ul style="list-style-type: none"> • Station or CATV experiencing problems, tune to another station. • Station signal is weak, reorient antenna to receive weaker station. • Check for sources of possible interference. 	14 11,12 39
Poor color or no color	<ul style="list-style-type: none"> • Station or CATV experiencing problems, tune to another station. • Make sure channels are set into memory. • Check picture control adjustments. • Check antenna or CATV connections, reorient antenna. • Check for sources of possible interference. 	14 18 19 11,12 39
Picture wobbles or drifts	<ul style="list-style-type: none"> • Station or CATV experiencing problems, tune to another station. • Make sure channels are set into memory. • CATV company is scrambling signal. • Check antenna orientation. 	14 18 – 11
No CATV reception	<ul style="list-style-type: none"> • Check all CATV connections. • Set TV/CATV menu option to the CATV mode. • Station or CATV system problems, try another station. 	12 17 14
Horizontal or diagonal bars on screen	<ul style="list-style-type: none"> • Check antenna connections, reorient antenna. • Check for sources of possible interference. 	11,12 39
No reception above channel 13	<ul style="list-style-type: none"> • Make sure TV/CATV menu option is in the appropriate mode. • If using antenna, check UHF antenna connections. 	17 11
TV shuts off	<ul style="list-style-type: none"> • No broadcast on station tuned. • Sleep Timer is set. • Power interrupted. 	18 15 –
Closed - Caption is not activated.	<ul style="list-style-type: none"> • TV station experiencing problems or program tuned is not closed captioned. Try another channel. • Check CATV connection or VHF/UHF antenna, reposition or rotate antenna. • Press CLOSED CAPTION button to turn on the closed caption decoder. 	14 11,12 16
Display is not shown in your language.	<ul style="list-style-type: none"> • Select proper language in the menu options. 	13

SYMPTOMS	POSSIBLE SOLUTIONS	PAGE
DVD		
Playback doesn't start.	<ul style="list-style-type: none"> • No disc is inserted. • The disc may be dirty. Clean up the disc. • The unit cannot play CD-ROMs, etc. 	24 6 –
No picture	<ul style="list-style-type: none"> • TV/DVD selector is not set correctly. 	23
No sound	<ul style="list-style-type: none"> • Check the input selector of the amplifier is set properly. • The unit is in the Special playback mode. • Select the correct Audio Output position on AV amplifier. 	– 25 36
Picture is distorted during CUE or REVIEW.	<ul style="list-style-type: none"> • The picture will be distorted occasionally. 	–
Stopping playback, search, slow-motion play, repeat play, or program play, etc. cannot be performed.	<ul style="list-style-type: none"> • Some discs may not do some of the functions. 	–
No 4:3 (16:9) picture	<ul style="list-style-type: none"> • The setup does not match your TV. 	31
No on-screen display	<ul style="list-style-type: none"> • Select Display On. 	31
No surround sound	<ul style="list-style-type: none"> • The setup does not match your stereo system. 	36
The unit or remote operation key is not functioning.	<ul style="list-style-type: none"> • Turn off the unit and unplug the AC power cord for several minutes, then replug it. 	–
Playback does not start when the title is selected.	<ul style="list-style-type: none"> • Check the RATING LEVEL setup. 	33~35
Audio soundtrack and/or subtitle language is not changed when you play back a DVD.	<ul style="list-style-type: none"> • Multilingual language is not recorded on the DVD disc. 	30
No subtitle	<ul style="list-style-type: none"> • Some discs have no subtitles. • Subtitles are cleared. Press SUBTITLE. 	28
Angle cannot be changed.	<ul style="list-style-type: none"> • Multi-angles are not recorded on the DVD disc. 	29
“⊘” appears on the screen.	<ul style="list-style-type: none"> • The function is prohibited with the unit or the disc. 	–
REMOTE CONTROL		
The remote control does not function.	<ul style="list-style-type: none"> • Aim at the remote control at the remote sensor. • Operate within Approx. 5 Meters or reduce the light in the room. • Clear the path of the beam. • The batteries are weak. Replace the batteries. • Check the batteries are inserted correctly. 	10

Specifications

GENERAL

Power supply:	AC 120 V 60 Hz
Power consumption:	Operation: 115 W Standby: 4 W
Weight:	55.1 lbs (25.0 kg)
Dimensions:	Width: 22-5/8 inches (574 mm) Height: 20-1/4 inches (514.5 mm) Depth: 18-15/16 inches (481.5 mm)
Operating temperature:	5°C - 40°C
Operating humidity:	Less than 80%

TELEVISION

Picture tube:	Type 20 (508 mm diagonal)
Tuner type:	Quartz PLL Frequency Synthesized
Receiving channels:	VHF 2-13 UHF 14-69 CATV 14-36 (A)-(W) 37-59 (AA)-(WW) 60-85 (AAA)-(ZZZ) 86-94 (86)-(94) 95-99 (A-5)-(A-1) 100-125 (100)-(125) 01 (5A)
Antenna input:	VHF/UHF In 75 ohm coaxial
Speaker:	1-13/16 inches x 3-7/8 inches (46 mm x 99 mm), 8 ohm x 2
Audio output power:	5 W + 5 W

DVD/CD player

Signal system:	NTSC
Applicable disc:	1. DVD (12 cm, 8 cm) 2. CD (12 cm, 8 cm)
Frequency response:	DVD: 4 Hz - 22 KHz CD: 4 Hz - 20 KHz
Input:	Video: (RCA) 1 V (p-p)/75 ohm Audio: (RCA) -8 dBm/50K ohm
Digital audio out:	0.5 V (p-p) 75 ohms terminated

ACCESSORIES:

Remote control x 1
Batteries (2 x AAA)
300 - 75 ohm Matching Transformer

LIMITED WARRANTY TOSHIBA COMBINATION TELEVISION AND DVD/CD PLAYER

Toshiba America Consumer Products, Inc. ("TACP") and Toshiba Hawaii Inc. ("THI") make the following limited warranties. These limited warranties extend to the original consumer purchaser or any person receiving this set as a gift from the original consumer purchaser and to no other purchaser or transferee .

Limited Ninety (90) Day Warranty

TACP and THI warrant this product and its parts against defects in materials or workmanship for a period of ninety (90) days after the date of original retail purchase. During this period, TACP and THI will repair a defective product or part, without charge to you. You must deliver the entire set to an Authorized TACP/THI Service Station. You pay for all transportation and insurance charges for the set to and from the Service Station.

Limited One (1) Year Warranty

TACP/THI further warrant the parts in this product against defects in materials or workmanship for a period of one year after the date of original retail purchase. During this period TACP/THI will replace a defective part without charge to you, except that if a defective part is replaced after ninety (90) days from the date of original retail purchase you pay labor charges involved in the replacement. You must also deliver the entire product to a TACP/THI Authorized Service Station. You are responsible for all transportation for the set to and from the Service Station.

Limited Two (2) Year Warranty of Picture Tube

TACP and THI further warrant the picture tube in this product against defects in materials or workmanship for a period of two (2) years after the date of original retail purchase. During this period, TACP/THI will replace a defective picture tube without charge to you except that if a defective picture tube is replaced after ninety (90) days from the date of the original retail purchase, you pay labor charges involved in the replacement. You are responsible for all charges involved in the replacement. you are responsible for all transportation and insurance charges for the set to and from the Service Station.

Rental Units

The warranty for rental units begins with the first rental or thirty (30) days from the date of shipment to the rental firm, whichever comes first.

Commercial Units

Products sold and used for commercial use have a limited ninety (90) day warranty for all parts, labor and picture tube.

Owner's Manual and Demographic Card

You should read this owner's manual thoroughly before operating this product. You should complete and mail the enclosed Demographic card within ten days after you, or the person who has given you this product as a gift, purchased this product. This is one way to enable TACP/THI to provide you with better customer service and improved products. Failure to return the Demographic card will not affect your rights under this warranty.

Your Responsibility

The above warranties are subject to the following conditions:

- (1) You must retain your bill of sale or provide other proof of purchase.
- (2) All warranty servicing of this product must be made by an Authorized TACP/THI Service Station.
- (3) These warranties are effective only if the product is purchased and operated in the U.S.A. or Puerto Rico.
- (4) Labor service charges for set installation, set up, adjustment of customer controls and installation or repair of antenna systems are not covered by this warranty. Reception problems caused by inadequate antenna systems are your responsibility.
- (5) Warranties extend only to defects in materials or workmanship as limited above and do not extend to any product or parts which have been lost or discarded by you or to damage to products or parts caused by misuse, accident, damage caused by Acts of God, such as lightning or fluctuations in electric power, improper installation, improper maintenance or use in violation of instructions furnished by us; or to units which have been altered or modified without authorization of TACP/THI.

LIMITED WARRANTY TOSHIBA COMBINATION TELEVISION AND DVD/CD PLAYER

How to Obtain Warranty Service

If after following all of the operating instructions in this manual and checking the section "Problems and troubleshooting" and you still find that service is needed;

- (1) Call the TACP toll free number 1-800-631-3811 after you find a defective product or part to find the nearest Toshiba Authorized Service Station.
- (2) Please present your bill of sale or other proof to the Authorized Service Station.
"TACP/THI Authorized Service Station personnel will come to your home when warranty service is required. Depending on the type of repair required, the service will either be performed in your home or the set will be taken to the TACP/THI Authorized Service Station for repair and returned to your home at no cost to you".

In the Continental United States contact:



In Hawaii Contact:

Toshiba Hawaii, Inc
327 Kamakee Street,
Honolulu, Hawaii 96814
(808) 591-8377

All warranties implied by state law, including the implied warranties of merchantability and fitness for a particular purpose, are expressly limited to the duration of the limited warranties set forth above. With the exception of any warranties implied by state law as hereby limited, the foregoing warranty is exclusive and in lieu of all other warranties, guarantees, agreements and similar obligations of manufacturer or seller with respect to the repair or replacement of any parts. In no event shall TACP or THI be liable for consequential or incidental damages.

No person, agent, distributor, dealer or company is authorized to change, modify or extend the terms of these warranties in any manner whatsoever. The time within which action must be commenced to enforce any obligation of TACP or THI arising under this warranty or under any statute, or law of the United States or any state thereof, is here by limited to 90 days from the date you discover or should have discovered, the defect. This limitation does not apply to implied warranties arising under state law.

This warranty gives you specific legal rights and you may also have other rights which may vary from state to state. Some states do not allow limitation on how long an implied warranty lasts, when an action may be brought, or the exclusion or limitation of incidental or consequential damages, so the above provisions may not apply to you.



ATTENTION CANADIAN CONSUMERS:

Canadian consumers are requested to complete the special Canadian "Warranty Registration Form" enclosed, and forward this completed form with a copy of bill of sale to TOSHIBA OF CANADA to "Register and Validate" their warranty.

Products purchased in the U.S.A. and used in Canada are not covered by these warranties.
Products purchased in Canada and used in the U.S.A. are not covered by these warranties.
Rev. 09-01-98

TOSHIBA

TOSHIBA AMERICA CONSUMER PRODUCTS, INC.



J5F00301B

03/07 U

Printed in Thailand
Imprimé en Thaïlande

Free Manuals Download Website

<http://myh66.com>

<http://usermanuals.us>

<http://www.somanuals.com>

<http://www.4manuals.cc>

<http://www.manual-lib.com>

<http://www.404manual.com>

<http://www.luxmanual.com>

<http://aubethermostatmanual.com>

Golf course search by state

<http://golfingnear.com>

Email search by domain

<http://emailbydomain.com>

Auto manuals search

<http://auto.somanuals.com>

TV manuals search

<http://tv.somanuals.com>