

# TOSHIBA



## DVD VIDEO RECORDER / VIDEO CASSETTE RECORDER

# D-VR17KB

## OWNER'S MANUAL



**OPERATIONS  
GUIDE**

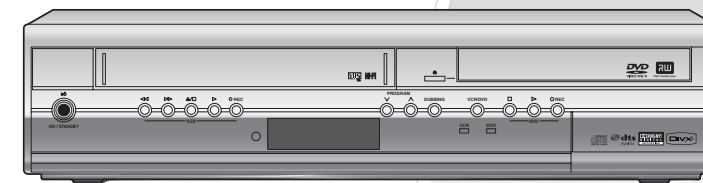

Introduction

Connections

Basic Setup

Recording

Playback

Editing

Function Setup

VCR Functions

Others

# TOSHIBA

Printed in China



1VMN23544 / E9GA0BD ★★★★★

© 2007 Toshiba Corporation



# Introduction

## Precautions

**WARNING:** TO REDUCE THE RISK OF FIRE OR ELECTRIC SHOCK, DO NOT EXPOSE THIS APPLIANCE TO RAIN OR MOISTURE.

	<b>CAUTION</b> <b>RISK OF ELECTRIC SHOCK</b> <b>DO NOT OPEN</b>	
<b>CAUTION:</b> TO REDUCE THE RISK OF ELECTRIC SHOCK, DO NOT REMOVE COVER (OR BACK). NO USER SERVICEABLE PARTS INSIDE. REFER SERVICING TO QUALIFIED SERVICE PERSONNEL.		

The important note is located on the rear of the cabinet.

	The lightning flash with arrowhead symbol, within an equilateral triangle, is intended to alert the user to the presence of uninsulated "dangerous voltage" within the product's enclosure that may be of sufficient magnitude to constitute a risk of electric shock to persons.
	The exclamation point within an equilateral triangle is intended to alert the user to the presence of important operating and maintenance (servicing) instructions in the literature accompanying the appliance.

## Laser Safety

This unit employs a laser. Only a qualified service personnel should remove the cover or attempt to service this unit, due to the possibility of eye injury.

**CAUTION:** USE OF CONTROLS OR ADJUSTMENTS OR PERFORMANCE OF PROCEDURES OTHER THAN THOSE SPECIFIED HEREIN MAY RESULT IN HAZARDOUS RADIATION EXPOSURE.

**CAUTION:** VISIBLE AND INVISIBLE LASER RADIATION WHEN OPEN AND INTERLOCK DEFEATED. DO NOT STARE INTO BEAM.

**LOCATION:** INSIDE, NEAR THE DECK MECHANISM.

## Power Supply

The power supply is connected and the unit is live when the mains cable is plugged into a 220–240 V~, 50 Hz AC outlet. To operate the unit, press [I/⏻ ON / STANDBY].

**WARNING: LIVE PARTS INSIDE.**  
**DO NOT REMOVE ANY SCREWS.**

## Caution

- Do not attempt to open the cabinet. There are no parts inside you can service. Refer all servicing to qualified service personnel.
- Slots and openings in the cabinet at the sides and underneath are provided for ventilation. To ensure reliable operation and to protect the unit from overheating, these openings must not be blocked or covered.  
Avoid installation in enclosed spaces such as bookcases unless suitable ventilation is provided.
- Keep the unit away from radiators and other heat sources.
- Avoid use near strong magnetic fields.
- Do not push objects of any kind into the unit through the cabinet slots or openings as they could touch electrically live parts or short circuit parts resulting in a fire or electric shock.
- Do not spill liquid on the unit. If liquid is spilled and enters the unit, consult qualified service personnel.
- Do not stand the unit vertically. Use the unit in a horizontal (flat) position only.
- Before attempting to operate the unit, make sure that the timer recording mode is off.
- This product is in Stand-by mode when turned off while the mains cable is connected.
- Do not place any combustible objects on the device (candles, etc.).
- Before moving the unit, be sure to remove any discs and unplug the mains cable from the AC outlet.
- Disconnect the mains plug to shut off when find troubles or not in use.
- The mains plug shall remain readily operable.
- Read both manual instructions to ensure correct and safe installation and interconnection of the unit in multimedia systems.
- Keep the distances 20 cm around apparatus of ventilation openings.

**A NOTE ABOUT RECYCLING**

This product's packaging materials are recyclable and can be reused. Please dispose of any materials in accordance with your local recycling regulations.

This product consists of materials which can be recycled and reused if disassembled by a specialised company. Batteries should never be thrown away or incinerated but disposed of in accordance with your local regulations concerning chemical wastes.

**Make your contribution to the environment!!!**

- Exhausted batteries do not belong in the dustbin.
- You can dispose of them at a collection point for exhausted batteries or special waste.
- Contact your council for details.

**For Customer Use:**

Carefully read the Model No. and Serial No. located at the back of the unit and enter the information below. Retain this information for future reference.

Model No. \_\_\_\_\_  
Serial No. \_\_\_\_\_

**Connection to Power**

Before Switching on make sure that the voltage of your electricity supply is the same as that indicated on the rating plate.

**Mains Cord**

This appliance may be fitted with a non-rewireable plug. If it is necessary to change the fuse in a nonrewireable plug the fuse cover must be refitted. If the fuse cover is lost or damaged, the plug must not be used until a replacement available from the appliance manufacturer is obtained.

It is important that the colour of the replacement fuse cover corresponds with the rating marking on the base of the plug.

If the plug has to be changed because it is not suitable for your socket, or becomes damaged, it should be cut off and an appropriate plug fitted following the wiring instructions below. The plug removed must be disposed of safely as insertion into a 13A socket is likely to cause an electrical hazard. For your own safety read the following instructions carefully before attempting to connect this unit to mains.

The wires in this mains lead are coloured in accordance with the following code:

BLUE=NEUTRAL, BROWN=LIVE

**Important**

As the colours of the wires in the mains lead of this appliance may not correspond with the coloured markings identifying the terminals in your plug, proceed as follows:

The wire which is coloured blue must be connected to the terminal which is marked with the letter N or coloured black.

The wire which is coloured brown must be connected to the terminal which is marked with the letter L or coloured red.

No connection is to be made to the earth terminal of the plug.

If a 13 Amp (BS 1363) Plug is used, a 3 Amp Fuse must be fitted, or if any other type of Plug is used a 3 or 5 Amp Fuse must be fitted, either in the Plug or Adaptor, or on the Distribution Board.

Mains Supply: 220 - 240V ~ 50 Hz - AC only

Do not make any connection to the larger pin marked with the letter "E" or by the symbol  $\perp$  or coloured green or green and yellow.

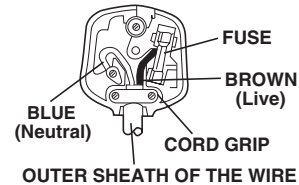
**Installation Location**

For safety and optimum performance of this unit:

- Install the unit in a horizontal and stable position.
- Do not place anything directly on top of the unit.
- Do not place the unit directly on top of the TV.
- Shield the unit from direct sunlight and keep away from sources of intense heat. Avoid dusty or humid locations. Avoid locations with insufficient ventilation for suitable heat dissipation. Do not block the ventilation holes on the sides of the unit. Avoid locations subject to strong vibration or strong magnetic fields.

**Avoid the Hazards of Electrical Shock and Fire**

- Do not handle the mains cable with wet hands.
- Do not pull on the mains cable to disconnect it from AC outlet. Grasp it by the plug.
- If, by accident, water is spilled on the unit, unplug the mains cable immediately and take the unit to an authorised service centre for servicing.

**Moisture Condensation Warning**

Moisture condensation may occur inside the unit when it is moved from a cold place to a warm place, after heating a cold room, or under conditions of high humidity. Do not use the unit for at least 2 hours to allow the inside to dry.

Introduction

Connections

Basic Setup

Recording

Playback

Editing

Function Setup

VCR Functions

Others

## About Copyright

Unauthorised copying, broadcasting, public performance and lending of discs are prohibited. This product incorporates copyright protection technology that is protected by U.S. patents and other intellectual property rights. Use of this copyright protection technology must be authorised by Macrovision, and is intended for home and other limited viewing uses only unless otherwise authorised by Macrovision. Reverse engineering or disassembly is prohibited.

## Notice for the Progressive Scan Outputs

Consumers should note that not all high definition television sets are fully compatible with this product and may cause artifacts to be displayed in the picture. In case of picture problems with 525 or 625 progressive scan output, it is recommended that the user switch the connection to the 'standard definition' output. If there are questions regarding your TV set compatibility with this 525p or 625p DVD recorder, please contact our customer service centre.

Manufactured under license from Dolby Laboratories. "Dolby" and the double-D symbol are trademarks of Dolby Laboratories.

**Dolby Digital Recording**  
"Dolby® Digital Recording enables consumers to record high-quality video with stereo sound on recordable DVD discs. The technology, when utilised instead of PCM recording, also saves recordable disc space, allowing for higher video resolution or extended recording time on each DVD. DVDs created using Dolby Digital Recording will play back on all DVD-Video players."  
Note: This is true when the players are compatible with actual recordable DVD discs.

"DTS" and "DTS Digital Out" are registered trademarks of DTS, Inc.



DivX, DivX Certified, and associated logos are trademarks of DivX, Inc. and are used under license.

## Declaration of Conformity

This product complies with the requirement of the directives

EMC-Directive: 89 / 336 / EEC  
Low Voltage Directive: 73 / 23 / EEC  
CE Marking: 93 / 68 / EEC

We declare that the following product:

DVD Video Recorder / Video Cassette Recorder  
Model D-VR17KB

Trade Name: TOSHIBA

is in compliance with following Regulations.

EN55013: 2001+A1:2003, EN55020:  
2002+A1:2003+A2:2005, EN61000-3-2:  
2003+A2:2005, EN61000-3-3: 1995 + A1: 2001  
EN60065: 2002  
EN60825-1 Edition 1.2: 2001



## Maintenance

### CLEANING THE UNIT

Use a soft cloth slightly moistened with a mild detergent solution. Do not use solutions containing alcohol, spirits, ammonia or abrasive.

### CLEANING DISCS

If a disc becomes dirty, clean it with a cleaning cloth. Wipe the disc from the centre out. Do not wipe in a circular motion.

Do not use solvents such as benzene, thinner, commercially available cleaners, detergent, abrasive cleaning agents or antistatic spray intended for analogue records.

### DISC HANDLING

Handle the discs so that fingerprints and dust do not adhere to the disc surfaces.

Always store the disc in its protective case when it is not in use.

### SERVICING

If the unit becomes inoperative, do not try to correct the problem by yourself. There are no user serviceable parts inside. Turn the unit off, unplug the mains cable, and consult your dealer or an authorised service centre.

### CLEANING THE DISC LENS

If the unit does not perform correctly even though you have referred to "Troubleshooting" and the relevant sections in the Owner's Manual, the laser optical pickup unit may be dirty. Consult your dealer or an authorised service centre for inspection and cleaning of the laser optical pickup unit.

### AUTO HEAD CLEANING

- Automatically cleans video heads as you insert or remove a cassette, so you can see a clear picture.
- Playback picture may become blurred or interrupted while the TV programme reception is clear. Dirt accumulated on the video heads after a long period of use, or the usage of rental or worn tapes can cause this problem. If a streaky or snowy picture appears during playback, the video heads in the unit may need to be cleaned.

1. Please visit your local Audio / Video store and purchase a good quality VHS Video Head Cleaner.
2. If a Video Head Cleaner does not solve the problem, please consult your dealer or an authorised service centre.

#### Note:

- Remember to read the instructions along with the video head cleaner before use.
- Clean video heads only when problems occur.

## Accessories Supplied

- Remote control with two R6 (AA) batteries



- RF cable

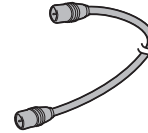

- Owner's Manual

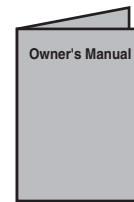

- Quick Setup Guide

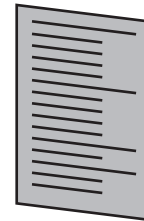

- Registration card

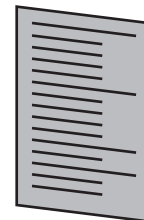

Introduction

Connections

Basic Setup

Recording

Playback

Editing

Function Setup

VCR Functions

Others

## Table of Contents

<b>Introduction .....</b>	<b>2</b>	<b>Playback .....</b>	<b>42</b>
Precautions .....	2	Basic Playback .....	42
Features .....	7	PBC Function for Video CDs .....	47
Guide to the Owner's Manual .....	8	Special Playback .....	48
Functional Overview .....	11	Search .....	52
Installing Batteries in the Remote Control .....	15	Repeat / Random / Programme Playback / Slide Show .....	53
VCR / DVD Recorder Switching .....	15	Selecting the Format of Audio and Video .....	55
Guide to On-Screen Displays .....	16		
Front Panel Display Guide .....	18		
		<b>Editing .....</b>	<b>57</b>
<b>Connections .....</b>	<b>19</b>	Disc Editing .....	57
Connections .....	19	Editing Discs .....	57
<b>Basic Setup .....</b>	<b>22</b>	<b>Function Setup .....</b>	<b>64</b>
Initial Setting .....	22	Playback .....	66
Channel Setting .....	22	Display .....	69
Setting the Clock .....	24	Video .....	69
Selecting the TV Aspect Ratio .....	25	DivX® .....	70
		Reset All .....	71
<b>Recording .....</b>	<b>26</b>	<b>VCR Functions .....</b>	<b>72</b>
Information on DVD Recording .....	26	Playback .....	72
Formatting a Disc .....	27	Recording and One-touch Timer Recording (OTR) .....	72
Selecting the Sound Mode .....	30	Search .....	73
Basic Recording .....	31	Other Operations .....	74
One-touch Timer Recording (OTR) .....	32	Hi-Fi Stereo Sound System .....	74
Timer Recording .....	33		
Satellite Link .....	36		
Settings for External Equipment .....	38		
Dubbing Mode .....	39	<b>Others .....</b>	<b>75</b>
Setting a Disc to Protect .....	40	Troubleshooting .....	75
Finalising Discs .....	41	Language Code .....	79
		Glossary .....	80
		Specifications .....	81

## Features

This unit not only plays back DVDs, CDs and VHS tapes but also offers features for you to record on DVD discs and edit them after that. The following features are offered with this unit.

### Recording

The unit is compatible with DVD-RW, DVD+RW discs, which are recordable repeatedly, and DVD-R, DVD+R discs, which are recordable only once.

Also, this unit allows you to record to the video cassette tape. You can choose either one for your convenience.

**DVD mode**

**VCR mode**

#### Recording up to 12 programmes:

You can programme the unit to record up to 12 programmes, up to a month in advance. Daily or weekly programme recordings are also possible.

#### One-touch Timer Recording:

You can set your required recording time easily. Every time **[REC ●]** is pressed during recording, the recording time will be increased by 30 minutes up to 8 hours. It will be turned off automatically when the recording time you set is finished.

#### Dubbing mode:

You can copy a DVD disc to a videotape or copy a videotape to a DVD disc. This function will be available only if the DVD disc and the videotape are not copy-protected.

#### Left channel stereo recording:

This unit can record the sound of the Left channel monaural input as Left and Right channels automatically (available only for AV3 jacks on the front panel).

**DVD mode**

#### Automatic Chapter marker setting:

Chapter markers will be added to recordings as you set them in the Setup menu before starting to record.

#### Automatic Title menu making (Video, +VR mode only):

The unit creates Title menus automatically when finalising discs.

#### Automatic Playlist making (VR mode DVD-RW disc only):

The unit creates a Playlist automatically after recording.

#### Automatic finalising (Video mode DVD-RW/-R, DVD+R disc):

You can finalise discs automatically at the end of the disc space if you set this in the Setup menu.

### Playback

**DVD mode**

#### Theatre surround sound:

When the unit is connected to an amplifier or a decoder compatible with Dolby Digital or DTS, you can enjoy theatre-quality surround sound from discs recorded with the surround sound system.

#### Chasing Playback during Recording and Simultaneous Playback and Recording:

You can play the already recorded part of the current recording or another title during recording.

#### Quick search:

You can easily find the part you want to watch using the search function. Search for a desired point on a disc by title, chapter / track or time.

#### Playback from Original or a Playlist (VR mode):

You can play back titles using either the Original list or a Playlist.

#### Virtual Surround System:

You can enjoy stereophonic space through your existing 2 channel stereo system.

#### Playing back on MP3 / JPEG / DivX® files:

You can enjoy MP3 files which are recorded on CD-RW/-R.

DivX® files can also be recorded on DVD-RW/-R and DVD+RW/+R discs.

**VCR mode**

#### Quick search for what you want to watch:

You can easily find the part you want to watch using the Index or Time search functions. An index mark will be assigned at the beginning of each recording you make. For Time search function, you can go to a specific point on a tape by entering the exact amount of time you wish to skip.

### Editing

**DVD mode**

#### Set / clear chapter markers (Video mode DVD-RW disc only) [➡ Page 60]

You can easily add chapter markers at every selected time interval in your recordings for easy editing.

#### Adding or Deleting Chapter Marks Manually [➡ Pages 59 - 60]

You can add or delete chapter marks.

#### Creating Titles to a Playlist (VR mode DVD-RW discs only) [➡ Page 62]

You can create a title to the Playlist.

#### Deleting Titles [➡ Page 58]

You can delete titles which you do not need anymore.

#### Deleting a Scene of a Title (VR mode DVD-RW discs only) [➡ Page 63]

You can delete a specific scene of a title.

#### Editing title name [➡ Page 58]

You can name titles or change the title name.

#### Combining Titles (VR mode DVD-RW discs only) [➡ Page 61]

You can combine two titles into a single title.

#### Dividing Titles (VR mode DVD-RW, DVD+RW discs only) [➡ Page 61]

You can divide a title into two new titles.

#### Protecting titles (VR mode DVD-RW disc only):

To avoid accidental editing or erasing of titles, the protect function is useful when set to "ON" in the Original list.

#### Hiding chapters (+VR mode only):

To keep others from playing back some chapters without permission, you can hide chapters.

Introduction

Connections

Basic Setup

Recording

Playback

Editing

Function Setup

VCR Functions

Others

## Compatibility

### DVD mode

#### Playing back discs recorded in Video mode on any regular DVD player:

Discs recorded in Video mode can be played back on regular DVD players, including computer DVD drives compatible with DVD-Video playback. You will need to finalise the discs recorded in Video mode to play back in other DVD players.

Although DVD+RW/+R discs are playable on other units without finalisation in most cases, it is recommended to finalise in order to stabilise the performance.

\* DVD-Video Format (Video mode) is a new format for recording on DVD-RW/-R discs that was approved by the DVD Forum in 2000. Adoption of this format is optional for manufactures of DVD playback devices and there are DVD-Video players, DVD-ROM drives and other DVD playback devices available that cannot play back DVD-RW/-R discs recorded in the DVD-Video Format.

### DVD mode

### VCR mode

#### PDC:

This system assures that the TV programme you wish to record using timer recording will be recorded exactly from beginning to end even if the actual broadcasting time differs.

## Others













#### Progressive scan system:

Unlike conventional interlace scanning, the progressive scan system provides less flickering and images in higher resolution than that of traditional television signals.

## Guide to the Owner's Manual

### Symbols Used in the Owner's Manual

To show what recording mode or disc type applies to each function, the following symbols appear at the beginning of each operating item.

Symbol	Description
	Available to DVD-Videos
	Available to DVD-RW discs in Video mode
	Available to DVD-RW discs in VR mode
	Available to DVD-R discs in Video mode
	Available to DVD+RW discs
	Available to DVD+R discs
	Available to Audio CDs
	Available to Video CDs
	Available to CD-RW/-R discs with MP3 files
	Available to CD-RW/-R, discs with JPEG files
	Available to DVD-RW/-R, DVD+RW/+R and CD-RW/-R discs with DivX® files
	Available to VHS tapes Use only cassettes marked VHS (  ).





Discs for Playing					
Disc Type	DVD-VIDEO	CD-DA	Video CD	CD-RW	CD-R
Logo					
Icon					

Files for Playing			
Type of title	MP3	JPEG	DivX®
Icon			
Media	CD-RW/-R	CD-RW/-R	CD-RW/-R DVD-RW/-R DVD+RW/+R

**DVD** is a trademark of DVD Format/Logo Licensing Corporation.

- Official DivX® Certified product; Plays DivX® 6.0, DivX® 5, DivX® 4, DivX® 3, and DivX®VOD video content (in compliance with DivX Certified™ technical requirements).
- Discs containing the DivX® files with the DivX® GMC (Global Motion Compensation) playback feature, which is DivX® supplemental function, cannot be played back on this unit.
- \* This unit cannot play back the disc contents protected by Windows Media Digital Rights Management (DRM).

### Unplayable Discs

The following discs will not play back on this unit.

- CD-ROM
- Compact Disc-Interactive (CD-I)
- Video Single Disc (VSD)
- DVD-ROM
- DVD-audio
- Unfinalised disc
- DVD contains MP3, Windows Media™ Audio or JPEG files
- DVD-R recorded in VR format or non compatible recording format

On the following disc, the sound may not be heard.

- Super audio CD - Only the sound on the CD layer can be heard. The sound on the high-density super audio CD layer cannot be heard.

### Colour Systems

DVDs are recorded using different colour systems throughout the world. The most common colour system, used primarily in the U.K. and other EU countries, is PAL.

This unit uses the PAL system. However, it is also possible to play back DVDs using other colour systems, such as NTSC.

### Region Codes

This unit has been designed to play DVD with region 2. DVD must be labelled for ALL regions or for region 2 in order to play on the unit. You cannot play back DVD that are labelled for other regions. Look for the symbols on the right on your DVD. If these region symbols do not appear on your DVD, you cannot play back the DVD in this unit.



The number inside the globe refers to region of the world.

A DVD labelled for a specific region can only play back on the unit with the same region code.

Following discs are recommended for good recording quality and are proven to be compatible with this unit. However, depending on the media condition the unit may not read the disc properly.

- Verbatim DVD+R 8x, DVD+RW 4x, DVD-R 8x, DVD-RW 2x
- JVC DVD-RW 4x
- Maxell DVD+R 4x/8x/16x, DVD-R 8x/16x
- SONY DVD+R 4x/8x/16x, DVD+RW 4x
- TDK DVD+R 4x/8x/16x

Performance of any other discs are not guaranteed.

- Toshiba is not liable for any damage or loss caused directly or indirectly by the malfunction of this unit, including, without limitation, any one of the following:
  - Failure to record contents intended to be recorded by the consumer.
  - Failure to edit contents as intended by the consumer.
  - When a DVD-RW/-R, DVD+RW/+R disc created on this unit is used (e.g., insertion, playback, recording or editing) in another DVD player, recorder or personal computer drive.
  - When a DVD-RW/-R, DVD+RW/+R disc that is used in the manner described in the immediately preceding bullet point is used again in this unit.
  - When a DVD-RW/-R, DVD+RW/+R disc that was recorded in another DVD recorder, or in a personal computer drive is used in this unit.
- Some functions may not work with personal computer discs.
- Discs recorded in this unit may not operate as expected on other DVD players, recorders or personal computer drives.

## Functional Overview

### Front Panel

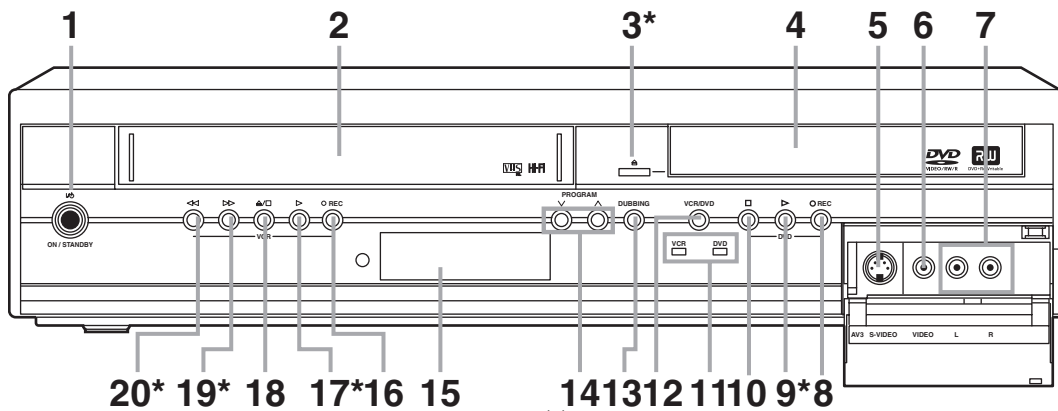

(\*) You can also turn on the unit by pressing these buttons.

- 1 I/⏻ ON / STANDBY button**
  - Press to turn on or off the unit.
  - Green LED lights up when power is ON.
- 2 Cassette compartment (VCR)**
  - Insert a tape here.
- 3 ▲ (OPEN / CLOSE) button\* (DVD)**
  - Press to open or close the disc tray.
- 4 Disc tray (DVD)**
  - Place the disc here when the disc tray is opened.
- 5 S-VIDEO input jack (AV3) (DVD / VCR)**
  - Use to connect the S-Video output of external equipment with an S-Video cable.
- 6 VIDEO input jack (AV3) (DVD / VCR)**
  - Use to connect external equipment with a standard Video cable.
- 7 AUDIO input jacks (AV3) (DVD / VCR)**
  - Use to connect external equipment with a standard Audio cable.
- 8 REC ● button (DVD)**
  - Press once to start recording.
  - Press repeatedly to start a One-touch Timer Recording.
- 9 ► (PLAY) button\* (DVD)**
  - Press to start or resume playback.
- 10 ■ (STOP) button (DVD)**
  - Press to stop a playback or recording.
  - Press to stop a timer recording of DVD.
- 11 VCR/DVD indicator (DVD / VCR)**
  - Indicates the selected component (DVD or VCR).
- 12 VCR/DVD button (DVD / VCR)**
  - Press to select the DVD mode or the VCR mode.
- 13 DUBBING button (DVD / VCR)**
  - Press to start VCR to DVD (DVD to VCR) duplication which you set in the Setup menu.
- 14 PROGRAM ∨ / ∧ buttons (DVD / VCR)**
  - Press to change the channel up or down.
- 15 Display (DVD / VCR)**
  - Refer to "Front Panel Display Guide" on page 18.
- 16 REC ● button (VCR)**
  - Press once to start recording.
  - Press repeatedly to start a One-touch Timer Recording.
- 17 ► (PLAY) button\* (VCR)**
  - Press to start playback.
  - Press to turn on the unit and start playback when the unit is off with a tape playback.
- 18 ▲/■ (STOP / EJECT) button (VCR)**
  - Press to remove the tape from the unit.
  - Press to stop the tape playback.
  - Press to stop the proceeding timer recording in VCR.
- 19 ►► (FWD) button\* (VCR)**
  - Press to rapidly advance the video tape.
  - Press to view the picture rapidly in forward during playback. (Forward Search)
  - Press to turn the unit on when the video tape is inserted and start rapidly advancing the tape.
- 20 ◀◀ (REW) button\* (VCR)**
  - Press to rewind the video tape.
  - Press to view the picture rapidly in reverse during the playback mode. (Rewind Search)
  - Press to turn the unit on when the video tape is inserted and start rewinding the tape.

#### Button names described in the Owner's Manual

The instructions in this manual are described mainly with the operations using the remote control. Some operations can be carried out using the buttons on the front panel.

## Rear Panel

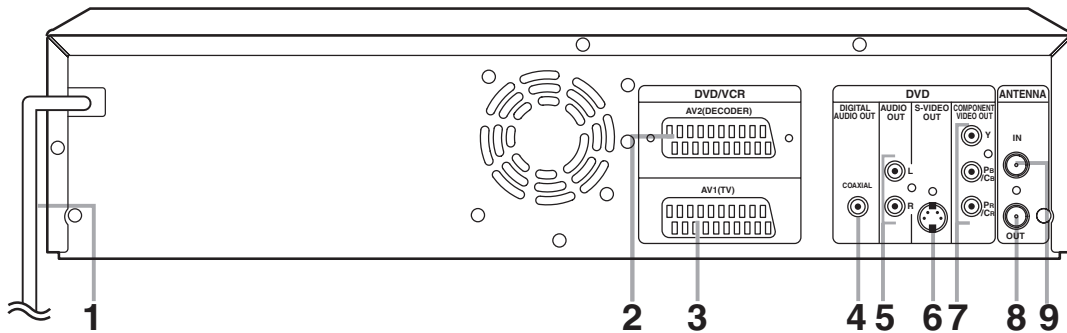

### 1 Mains cable

- Connect to a standard AC outlet.

### 2 AV2 (DECODER) socket (DVD / VCR)

- Connect to VCR, camcorder, or other Audio-Video equipment. Use a commercially available Scart cable.

### 3 AV1 (TV) socket (DVD / VCR)

- Connect to the Scart socket on your TV. Use a commercially available Scart cable.

### 4 DIGITAL AUDIO OUT (COAXIAL) jack (DVD)

- Connect to an amplifier with a digital input jack such as a Dolby Digital decoder, DTS decoder or MPEG decoder. Use a commercially available Coaxial cable.

### 5 AUDIO OUT jacks (DVD)

- Connect to the audio input jacks on your TV. Use a commercially available Audio cable.

### 6 S-VIDEO OUT jack (DVD)

- Connect to the S-Video input jack on your TV. Use a commercially available S-Video cable.

### 7 COMPONENT VIDEO OUT jacks (DVD)

- Connect to the component video input jacks on your TV.
- Use a commercially available Component Video cable.

### 8 ANTENNA OUT (DVD / VCR)

- Connect to the Aerial jack on your TV, cable box or direct broadcast system. Use the supplied RF cable.

### 9 ANTENNA IN (DVD / VCR)

- Connect to an antenna or cable.

#### Note

- Do not touch the inner pins of the jacks on the rear panel. Electrostatic discharge may cause permanent damage to the unit.
- **This unit does not have an RF modulator.**

## Remote Control

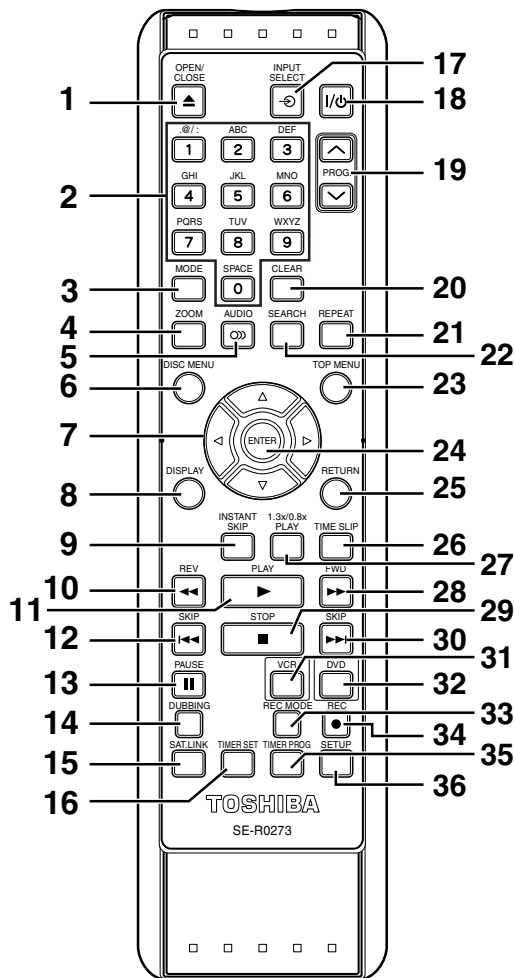

### 1 OPEN/CLOSE $\blacktriangle$ button (DVD / VCR)

- Press to open or close the disc tray.
- Press to remove the tape from the unit.

### 2 Number buttons (DVD / VCR)

- Press to select channel numbers.
- Press to select a title / chapter / track on the display.
- Press to enter values for settings in the Setup menu.
- Press to enter the number in the Index or Time search in VCR mode.
- Press to enter the characters in edit function.

### 3 MODE button

- This button does not work for this unit.

### 4 ZOOM button (DVD)

- During playback, press to enlarge the picture on the screen.

### 5 AUDIO $\infty$ button (DVD / VCR)

#### DVD mode

- When receiving a bilingual broadcast, press to change the audio out setting to "Main", "Sub" and "Main/Sub".
- Press to change the bilingual audio source of an external equipment to "Main", "Sub" or "Main/Sub". (Available only when the "External Input Audio" in the Setup menu is set to "Bilingual" in advance.)
- Press to display the audio menu during playback.
- Press to select the sound mode.

#### VCR mode

- During playback of a Hi-Fi video tape, press to change the audio out setting to "STEREO", "LEFT", "RIGHT" and "MONO".
- When receiving a bilingual broadcast, press to change the audio out setting to "Main", "Sub" and "Main/Sub".
- Press to change the bilingual audio source of an external equipment to "Main", "Sub" or "Main/Sub". (Available only when the "External Input Audio" in the Setup menu is set to "Bilingual" in advance.)

### 6 DISC MENU button (DVD)

- Press to display the Disc menu during playback.
- Press to change the Original and Playlist on the TV screen. (VR mode only)

### 7 Direction $\blacktriangle$ / $\blacktriangledown$ / $\blacktriangleleft$ / $\blacktriangleright$ buttons (DVD / VCR)

- Press to move the cursor and determine items or settings.

### 8 DISPLAY button (DVD / VCR)

- Press to display the On-Screen Display.

### 9 INSTANT SKIP button (DVD)

- During playback, press to skip 30 seconds. (See page 48.)

### 10 REV $\blacktriangleleft\blacktriangleleft$ button (DVD / VCR)

#### DVD mode

- During playback, press to reverse fast.
- When playback is paused, press to reverse slowly.

#### VCR mode

- Press to rewind the video tape.
- Press to view the picture rapidly in reverse during the playback mode.

### 11 PLAY $\blacktriangleright$ button (DVD / VCR)

- Press to start or resume playback.

### 12 SKIP $\blacktriangleleft\blacktriangleleft$ button (DVD)

- During playback, press twice in quick successions to skip to the previous chapter or track.
- When playback is paused, press to play reverse step by step.

### 13 PAUSE $\parallel$ button (DVD / VCR)

- Press to pause playback or recording.

**14 DUBBING button (DVD / VCR)**

- Press to start VCR to DVD (DVD to VCR) duplication which you set in the Setup menu.

**15 SAT.LINK button (DVD / VCR)**

- Press to call up the Satellite Link setting.

**16 TIMER SET button (DVD / VCR)**



- Press to set the unit in timer-standby mode. In the timer-standby mode, press to cancel the mode and to turn on the unit.

**17 INPUT SELECT  button (DVD / VCR)**

- Press to select the appropriate input.

**18 I/O ON / STANDBY button (DVD / VCR)**

- Press to turn on or off the unit.

**19 PROG.  /  buttons (DVD / VCR)****DVD mode**

- Press to change the channel up or down.

**VCR mode**

- Press to change the channel up or down.
- Press to adjust the tracking during playback or in slow motion of the tape.
- While playback is in still mode, you can adjust the vertically blurred picture.

**20 CLEAR button (DVD / VCR)****DVD mode**

- Press to clear the password once entered.
- Press to cancel the programming for a disc.
- Press to clear the selecting marker number in the marker setup mode.
- Press to clear the programme once entered in the timer recording setting mode.

**VCR mode**

- Press to reset the tape counter.

**21 REPEAT button (DVD / VCR)****DVD mode**

- Press to select the repeat mode.

**VCR mode**

- Press to set or release the Auto Repeat Playback.

**22 SEARCH button (VCR)**

- Press to call up the index or time search menu.

**23 TOP MENU button (DVD)**

- Press to display the Title menu.

**24 ENTER button (DVD / VCR)**

- Press to acknowledge or approve a menu selection.

**25 RETURN button (DVD / VCR)**

- Press to return to the previously displayed menu screen.

**26 TIME SLIP button (DVD)**

- Press once to start recording the TV programme you are watching. Press again to watch the content being recorded from the beginning while recording continues. (VCR mode DVD-RW discs with the recording mode of LP, EP or SLP only)

**27 1.3x/0.8x PLAY button (DVD)**

- During playback, press to playback in a slightly faster/slower speed while keeping the audio quality just as normal playback.

**28 FWD  button (DVD / VCR)****DVD mode**

- During playback, press to forward fast.
- When playback is paused, press to forward slowly.

**VCR mode**

- Press to rapidly advance the video tape.
- Press to view the picture rapidly in forward during playback.

**29 STOP  button (DVD / VCR)**

- Press to stop playing back or recording.

**30 SKIP  button (DVD)**

- During playback, press to skip to the next chapter or track.
- When playback is paused, press to advance step by step.

**31 VCR button  (DVD)**

- Press to select the VCR output mode. (See page 15.)

**32 DVD button  (VCR)**

- Press to select the DVD output mode. (See page 15.)

**33 REC MODE button (DVD / VCR)**

- Press to switch the recording mode.

**34 REC  button (DVD / VCR)**

- Press once to start a recording.
- Press repeatedly to start a One-touch Timer Recording.

**35 TIMER PROG button (DVD / VCR)**





- Press to display the timer programme setting menu.

**36 SETUP button (DVD / VCR)**

- Press to display the Setup menu in stop mode.

**Button names described in the Owner's Manual**  
The instructions in this manual are described mainly with the operations using the remote control. Some operations can be carried out using the buttons on the front panel.

**Note**

- If you turn off this unit, [OPEN / CLOSE - Be sure to use [ (OPEN / CLOSE)] or [ / ] (STOP / EJECT)] on the unit.

## Installing Batteries in the Remote Control

Install two R6 (AA) batteries (supplied) into the remote control, carefully match with the polarity indicated inside the battery compartment.

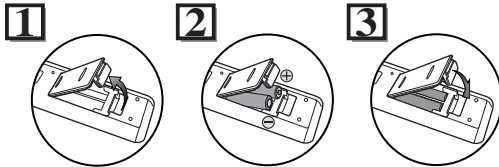

### Caution

- Incorrect use of batteries can result in hazards such as leakage and bursting.
- Do not mix new and old batteries together.
- Do not use different kinds of batteries together.
- Make sure that the plus and minus ends of each battery match the indications inside the battery compartment.
- Remove batteries if the equipment will not be used for a month or more.
- When disposing used batteries, please comply with governmental regulations or the public instructions for environmental protection that apply in your country or area.
- Do not recharge, short-circuit, heat, burn or disassemble batteries.

## About the Remote Control

- Make sure there is no obstacle between the remote control and the remote control sensor on the unit.
- Use within the operating range and angle as shown.

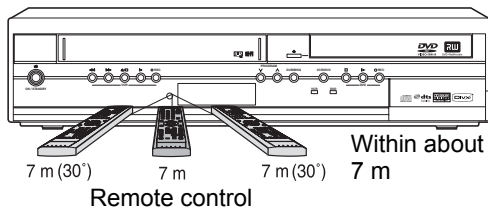

- The maximum operable range as follows:  
**Line of sight:** approximately 7 m  
**Either side of centre:** approximately 7 m within 30 degrees
- Remote control operation may become unreliable if the remote control sensor of the unit is being exposed by the strong sunlight or fluorescent light.
- Remote controls for different devices can interfere with each other. Be careful when using remote controls for other equipment located close to the unit.
- Replace the batteries when the operating range of the remote control reduces.

## VCR / DVD Recorder Switching

Because this product is a combination of a VCR and a DVD recorder, you must select first which component you wish to operate.

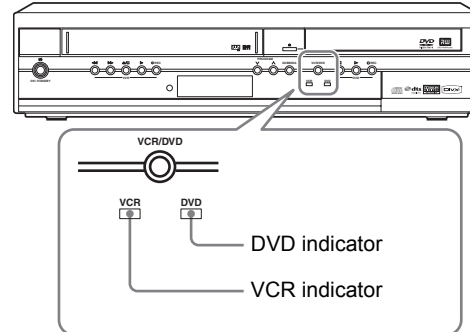

### VCR mode

Press **[VCR]** on the remote control.  
(Verify that the VCR indicator is lit.)

### DVD mode

Press **[DVD]** on the remote control.  
(Verify that the DVD indicator is lit.)

### Note

- You can also press **[VCR/DVD]** on the front panel to switch between DVD and VCR mode.
- You cannot switch to the mode (DVD or VCR) that is in the timer-standby mode.

## Guide to On-Screen Displays

### DISPLAY Menu

#### DVD mode

Press **[DVD]** first.

With a disc inserted into the unit, press **[DISPLAY]** to display the On-Screen Display. The menu shows information about what is recorded on the disc.

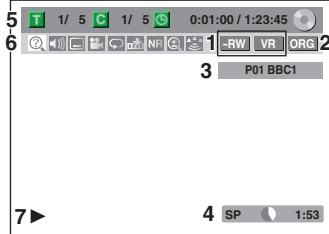

This is an example screen for explanation. Displayed items vary depending on the actual mode.

- 1 Indicates a disc type and format mode.
- 2 Indicates a type of titles for VR mode DVD-RW disc.
- 3 Indicates a channel number, station name or selected external input mode.
- 4 Indicates a recording mode and possible recording time left.
- 5 Indicates a title number, chapter number, elapsed time and total of disc playback.
- 6 Each icon means:
  - : Search
  - : Audio
  - : Subtitle
  - : Angle
  - : Repeat
  - : Marker
  - : Noise Reduction
  - : Zoom
  - : Surround
- 7 Indicates an operation status.

#### Note

- In some descriptions on this manual, only one disc type is indicated as an example.

Press **[DISPLAY]** while the On-Screen Display is displayed to display Title Name Information or File Name Information.

#### <Title Name Information>

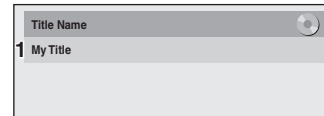

(only when DVD+RW/+R, VR mode DVD-RW/-R, or unfinalised Video mode DVD-RW/-R disc is in playback)

#### <File Name Information>

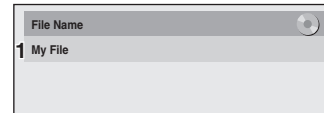

(only when a CD with MP3/JPEG/DivX® files is in playback)

- 1 Displays title/file name.

#### VCR mode

Press **[VCR]** first.

Press **[DISPLAY]** to display the On Screen Display.

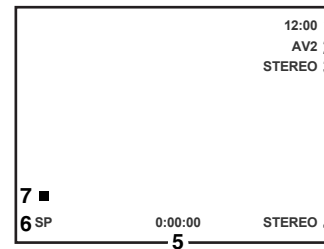

This is an example screen for explanation. Displayed items are depending on the actual mode.

- 1 Current time
- 2 Position number
- 3 Audio status of the receiving broadcast or external equipment
- 4 Audio status of the currently playing back video tape
- 5 Tape counter
- 6 Recording or playing back speed
- 7 Status of the current tape

While in the VCR mode, the On Screen Display of the VCR mode is displayed.



## Main Menu

Press [SETUP] to display the main menu. Then use [▲ / ▼] to select a menu and press [ENTER] to display the sub menu. These menus provide entries to all main functions of the unit.

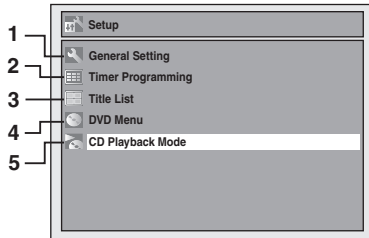

### 1 General Setting:

To go to General Setting menu.

### 2 Timer Programming:

To programme a timer recording.

### 3 Title List:

To call up the title list.

### 4 DVD Menu:

To set up the DVD disc setting.

### 5 CD Playback Mode:

To set up the CD playback setting.

- "CD Playback Mode" is available only when an audio CD, a video CD, a CD-RW/-R with MP3 / JPEG / DivX® files is inserted into the unit.

## General Setting Menu

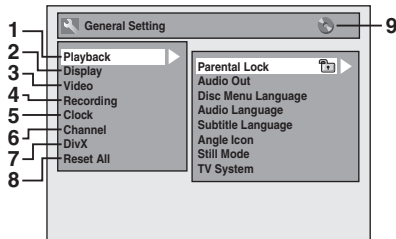

### 1 Playback:

To set up the unit to play discs as you prefer.

### 2 Display:

To set up the OSD screen as you prefer.

### 3 Video:

To set up the video setting.

### 4 Recording:

To set up the unit to record to discs as you prefer.

### 5 Clock:

To set up the clock of the unit as you need.

### 6 Channel:

To adjust the channel setting of the unit as you prefer.

### 7 DivX:

To set up the setting for the DivX® playback.

### 8 Reset All:

To reset the setting to the factory default.

### 9 : DVD

### : VCR

Indicates the available mode for the selected function.

## DVD Menu / CD Playback Mode

### <DVD Menu menu>

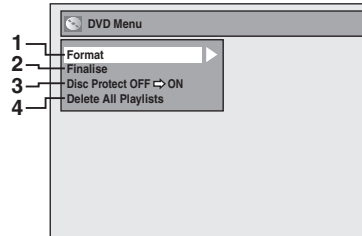

### <CD Playback Mode menu>

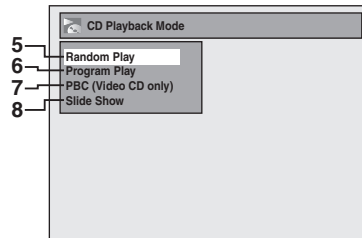

### 1 Format (DVD-RW, DVD+RW only):

Allows you to format the disc.

### 2 Finalise:

Allows you to finalise a disc containing recorded titles.

### 3 Disc Protect (VR mode DVD-RW, DVD+RW/+R disc only):

Allows you to protect a disc from accidental editing or recording.

### 4 Delete All Playlists (VR mode DVD-RW disc only):

Allows you to delete Playlist.

### 5 Random Play:

Allows you to activate the random playback feature.

### 6 Program Play (audio CD/video CD only):

Allows you to activate the programme playback feature.

### 7 PBC (Video CD only):

Allows you to select images or information on the menu screen by activating PBC (playback control) function.

### 8 Slide Show (JPEG files only):

Allows you to select the display time of the slide show mode.

## Front Panel Display Guide

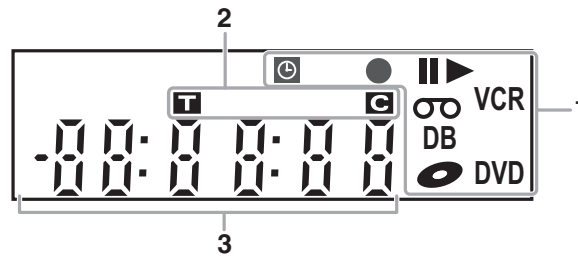

### 1 Current status of the unit

- || :** Appears when disc playback is paused. Appears also during step by step playback.
- ▶ :** Appears when playing back a disc.
- ||▶ :** Appears during slow forward playback.
- ⏻ :** Appears when the timer programming or One-touch Timer Recording (OTR) is set and is operating. Appears when the unit goes into the Satellite Link standby mode. Flashes when all the timer programmes are finished. Flashes when there is an error in programming.
- :** Appears when recording. Flashes when recording being paused.
- ⏻ :** Appears when a tape is in the unit.
- DB :** Appears when dubbing.
- Ⓛ :** Appears when a disc is in this unit.
- DVD :** Appears when this unit is in DVD output mode, or the timer-standby mode for DVD recording. Flashes when switch to the timer-standby mode while programming cannot set. Flashes when a programme cannot be performed for some reasons.

- VCR :** Appears when this unit is in VCR output mode, or the timer-standby mode for VCR recording. Flashes when switch to the timer-standby mode while programming cannot set. Flashes when a programme cannot be performed for some reasons.

\* ●, Ⓛ, DB, Ⓛ and DVD will be displayed simultaneously during VCR to DVD duplication process.  
●, Ⓛ, DB, Ⓛ and VCR will be displayed simultaneously during DVD to VCR duplication process.

### 2 Title / Track and Chapter number

- T :** Title / track number
- C :** Chapter number

### 3 Displays the following

- Playing back time
- Current title / chapter / track number
- Recording time / remaining time
- Clock
- Channel number
- VCR tape counter
- One-touch Timer Recording (OTR) remaining time

## Display Messages

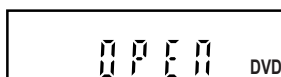

The disc tray is opening.

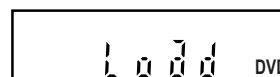

A disc is loading.

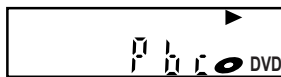

The PBC function of the Video CD is activated.

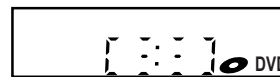

Data is being recorded on a disc.



The disc tray is closing.

# Connections

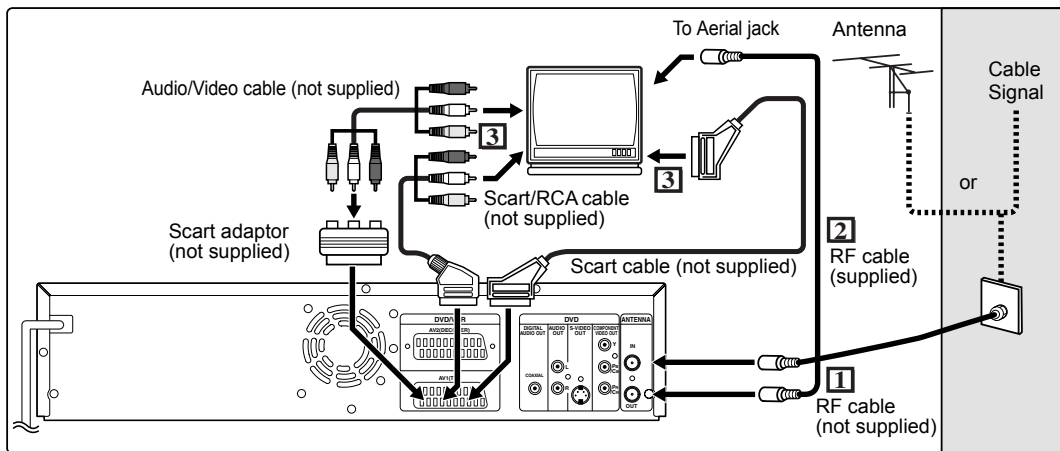

## Connections

### Connecting to a TV

Connect the unit to a TV after considering the capabilities of your existing equipment.

**Before installation, plug off your TV and this unit. Using the Scart socket**

- 1** Connect the antenna or cable to the **ANTENNA IN** jack of this unit.
- 2** Connect the **ANTENNA OUT** jack of this unit to the **Aerial** jack of your TV. Use the supplied RF cable.
- 3** Connect **AV1 (TV) Scart** socket of this unit to the **Scart** socket of your TV. Use a commercially available Scart cable.

#### Note

- If your TV does not have a Scart socket, use a commercially available Scart adaptor or Scart/RCA cable to connect. Use only AV1 (TV) or AV2 (DECODER) socket for the VCR output signals of this unit.
- Connect this unit directly to the TV. If the AV cables are connected to a VCR, pictures may be distorted due to the copy protection system.
- Teletext can only be output in VCR mode through AV1 (TV) out.
- When changing the "Video Out" setting ("SCART (RGB)", "Component Interlace (I)" or "Component Progressive (P)"), connect to the corresponding jack on the TV. If the setting is changed, for example, to "Component Interlace (I)" or "Component Progressive (P)" while the scart cable is connected to the TV, a distorted video signal may be output.

### Selecting Progressive Scan (625p/525p or Interlaced 625i/525i) Playback

- If your TV is compatible with progressive scanning (625p/525p), connect the TV to the COMPONENT VIDEO OUT jacks of the unit and set "Video Out" setting to "Component Progressive (P)" in the setup menu. (See page 69.) Next, set your TV to the progressive scan mode.
- If your TV is not compatible with progressive scan, set "Video Out" setting to "Component Interlace (I)".
- Use a commercially available adaptor if the Video input jacks of your TVs or monitors are the BNC type.

### Using the S-VIDEO OUT or the COMPONENT VIDEO OUT jacks and the AUDIO OUT jacks (Only for DVD)

If your TV has an S-Video or a Component Video input jack, use either an S-Video cable (to connect the S-VIDEO OUT jack) or a Component Video cable (to connect the COMPONENT VIDEO OUT jacks), and an Audio Cable (to connect the AUDIO OUT jacks).

- S-Video connection provides the good quality picture.
- Component connection provides the better quality picture.

- 1** Follow steps 1 and 2 on the left.
- 2** Connect **S-VIDEO OUT** or **COMPONENT VIDEO OUT** jacks of this unit to the **S-Video** or **Component Video** input jacks of your TV. Use a commercially available **S-Video** cable or **Component video** cable.
- 3** Connect the **AUDIO OUT** jacks of this unit to the analogue **Audio** input jacks of your TV. Use a commercially available **Audio** cable.

Introduction

Connections

Basic Setup

Recording

Playback

Editing

Function Setup

VCR Functions

Others

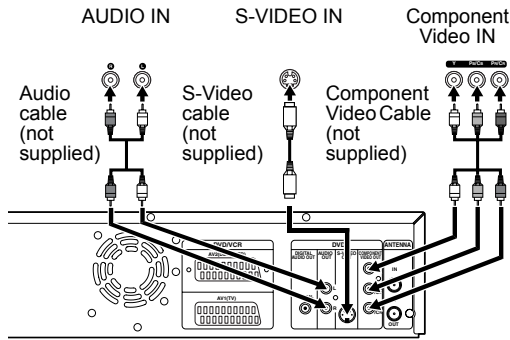

**Note for a TV with no S-Video input jack or Scart socket:**

- This unit has no RF modulator, so this type of TV cannot be used.
- Only component connection is compatible with the Progressive Scan.

**Connecting to External Equipment**

This unit has three input terminals, AV1 or AV2 on the rear panel and AV3 on the front panel. Be sure that all the units are off before making connections.

**Recording from a DVD player, VCR, Satellite Box or other Audio-Video equipment with a Scart output socket (AV2)**

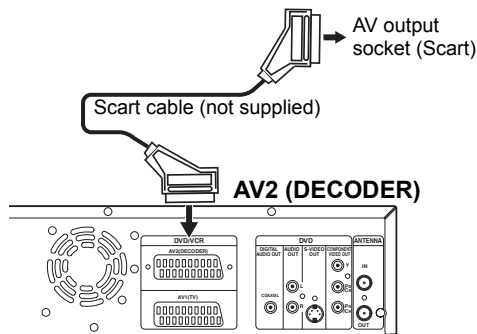

**Note**

- When you record a TV programme from a Satellite Box, you must connect a Scart cable to AV2(DECODER). (See page 36.)
- When AV2 is connected, the signal from the AV2 will be output automatically. If you want to monitor the signal from other input, you must press **[DISPLAY]** first. Then, select the desired input to monitor with **[INPUT SELECT]**.

**Recording from a camcorder or other Audio-Video equipment with no Scart output socket (AV3)**

If no S-Video input jack is available, connect to VIDEO input jack on the front panel using an RCA Video cable. Change the setup when using S-VIDEO input jack. (See page 38.)

**AV3 (Front)**

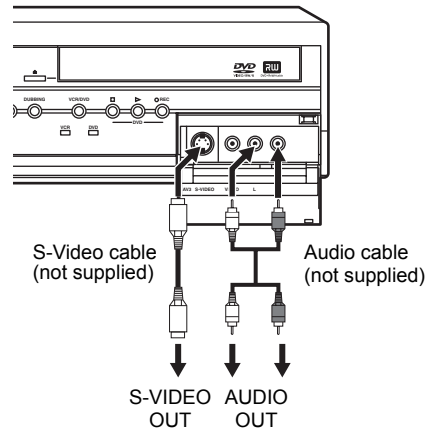

- When connecting an external device of monaural output to this unit, use AUDIO L jack of AV3.

**Digital Audio for Better Sound Quality (Only for DVD)**

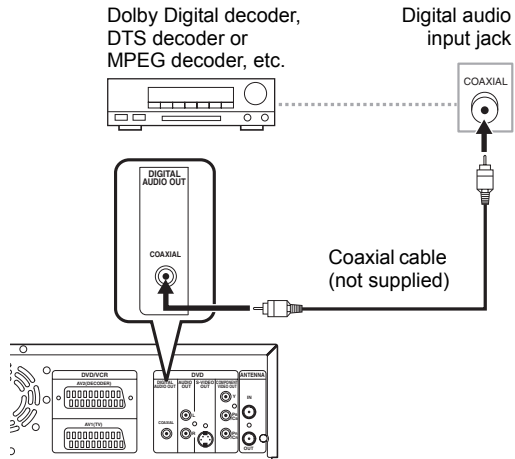

The connections illustrated above are optional for better sound.

**1 For clear digital sound quality, use the DIGITAL AUDIO OUT (COAXIAL) jack to connect your digital audio equipment.**

If the audio format of the digital output does not match the capabilities of your receiver, the receiver will produce a strong, distorted sound or no sound at all.

## Connecting a Dolby Digital™ decoder, DTS decoder or MPEG decoder

- Connecting multi-channel Dolby Digital decoder allows you to enjoy the Multi-channel Dolby Digital surround system as well as DTS decoder, Multi-channel surround system.
- After connecting to a Dolby Digital decoder, set "Dolby Digital" to "Stream" in the Audio Out menu. (See page 67.)
- After connecting to a DTS decoder, set "DTS" to "ON" in the Audio Out menu. (See page 67.)
- After connecting to a MPEG decoder, set "MPEG" to "Stream" in the Audio Out menu. (See page 67.)

## Connecting to an MD deck or DAT deck

- The audio source recorded in Dolby Digital Multi-channel surround format cannot be recorded using an MD or DAT deck as a digital sound.
- If not connected to a Dolby Digital decoder, set "Dolby Digital" to "PCM" in the Audio Out menu. Playing back a DVD using incorrect settings may generate noise distortion and damage speakers.
- Set "Dolby Digital" and "MPEG" to "PCM" and set "DTS" to "OFF" in the Audio Out menu for connecting to an MD or DAT deck.
- You can use AUDIO OUT jacks for the connection of your audio system.

---

## After You Have Completed Connections

Switch the input selector on your TV to an appropriate external input channel. For details, refer to the Owner's Manual of your TV.

### Note

- Connect this unit directly to the TV. If the AV cables are connected to a VCR, pictures may be distorted due to the effects of the copy protection system.

Introduction

**Connections**

Basic Setup

Recording

Playback

Editing

Function Setup

VCR Functions

Others

# Basic Setup

## Initial Setting

Turn on this unit for the first time, you need to follow these steps.

- 1** Press [I/ON / STANDBY].
- 2** Turn the TV on. Select the input to which the unit is connected.
- 3** Press [ENTER] to start Channel Tuning.  
The unit will start getting channels available in your area.

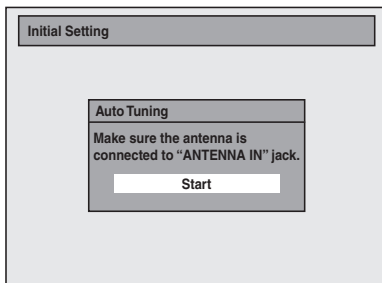

- 4** After finished channel setting, "Clock Setting" will appear. Then press [ENTER].

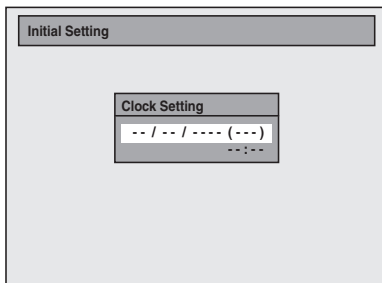

- 5** Follow to step 5 on page 25 in "Manual Clock Setting".

## Channel Setting

Tuning of this unit to broadcast channels can be performed in two ways.

### Auto Tuning

Programme the tuner to scan only the channels you can receive in your area.

- 1** In stop mode, press [SETUP]. Select "General Setting" using [▲ / ▼], then press [ENTER].  
General Setting Menu will appear.
- 2** Select "Channel" using [▲ / ▼], then press [ENTER].
- 3** Select "Auto Tuning" using [▲ / ▼], then press [ENTER].

The unit will start storing channels available in your area.

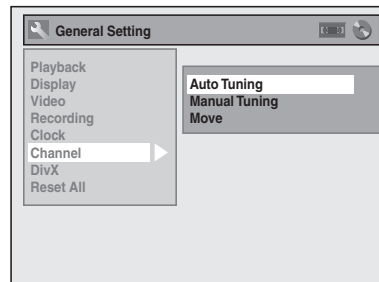

Wait for several minutes to finish channel storing.

- 4** Press [SETUP] to exit.

You can select the channels memorised only in this unit by using [PROG. ^ / v].

#### To cancel auto tuning

Press [RETURN] or [SETUP] during scanning.

#### Note

- The selection will be affected by how you receive TV channels in your local area.
- If the auto tuning is cancelled during scanning, some channels not yet tuned may not be received.
- You cannot change the channel when either VCR or DVD is in any recording mode (normal recording, One-touch Timer Recording or timer recording).
- Sorting of TV channels from P01 to P06 will be performed automatically as follows.  
P01: BBC1    P02: BBC2    P03: ITV  
P04: CH4    P05: CH5    P06: SKY NEWS
- If you are using a satellite receiver, turn it on and select SKY NEWS before commencing tuning.

## Manual Tuning

Manually tune each channel.

- 1** In stop mode, press [SETUP]. Select "General Setting" using [▲ / ▼], then press [ENTER].
- 2** Select "Channel" using [▲ / ▼], then press [ENTER].
- 3** Select "Manual Tuning" using [▲ / ▼], then press [ENTER].
- 4** Select "Position" using [▲ / ▼], then press [▶].

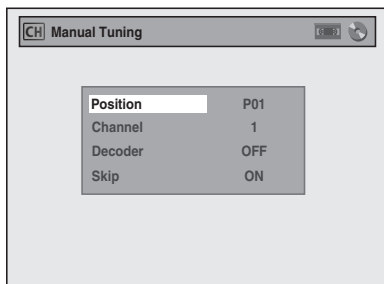

"P01" is highlighted.

- 5** Select the position number you wish to use using [the Number buttons] or [▲ / ▼], then press [◀].  
You can select position numbers 01 to 99.
- 6** Select "Channel" using [▲ / ▼], then press [▶].
- 7** Press [▲ / ▼] to start scanning.

- The tuner will begin to search up or down automatically. When a channel is found, the unit will stop searching and the picture will appear on the TV screen.
- You can select a desired channel number using [the Number buttons]. Refer to the following Channel Plan table and press the three digits to select the channel number.  
(To select channel 4, press [0] first and then press [0] and [4]. Or press [4] and then "-- 4" appears and wait for 2 seconds.)
- If this is the channel you want, press [◀].

Channel Plan	
CH Indication	TV Channel
01 – 10	IRA-IRJ, GAP
21 – 69	E21 – E69
74 – 78	X, Y, Z, Z+1, Z+2
80 – 99, 100	S1 – S20, GAP
121 – 141	S21 – S41

This unit can receive the Hyper and Oscar frequency bands.

- If "Skip" is set to "ON", select "Skip" using [▲ / ▼], then press [▶]. Select "OFF" using [▲ / ▼], then press [◀].
- If you want to decode scrambled signals, select "Decoder" using [▲ / ▼], then press [▶]. Select "ON" using [▲ / ▼], then press [◀].
- To store another channel, repeat steps 4 to 7.

- 8** After completion, press [SETUP] to exit.

## To Select a Channel

You can select a channel using [PROG. ^ / v], or directly enter the channel using [the Number buttons] on the remote control.

### Notes on using [the Number buttons]:

- Enter channel numbers as a two-digit number for the quickest result. For example, to select channel 6, press [0] and [6]. If you only press [6], channel 6 will be selected after 2 seconds. You can only select channels 1 to 99.
- You can select the external input mode "AV1", "AV2" or "AV3".
  - To select "AV1", press [0], [0], [1].
  - To select "AV2", press [0], [0], [2].
  - To select "AV3", press [0], [0], [3].

## To Skip a Preset Channel

You can set the unit to skip channels. You can no longer receive or seldom watch when you access channels using [PROG. ^ / v].

- 1** Follow steps 1 to 3 in "Manual Tuning" on page 23.
- 2** Select "Position" using [▲ / ▼], then press [▶].
- 3** Select the position number you wish to skip using [the Number buttons] or [▲ / ▼], then press [◀].
- 4** Select "Skip" using [▲ / ▼], then press [▶].
- 5** Select "ON" using [▲ / ▼], then press [◀].
  - To skip another channel, repeat steps 2 to 5.
- 6** Press [SETUP] to exit.

Introduction

Connections

Basic Setup

Recording

Playback

Editing

Function Setup

VCR Functions

Others

## Move

You can replace two channels.

- 1** In stop mode, press [SETUP]. Select "General Setting" using [▲ / ▼], then press [ENTER].
- 2** Select "Channel" using [▲ / ▼], then press [ENTER].
- 3** Select "Move" using [▲ / ▼], then press [ENTER].
- 4** Select the position number of which you want to change the channel using [▲ / ▼], then press [ENTER].

You cannot select a position number where "—" appears next to the number, because "Skip" is set to "ON" for that position number.

- 5** Move the channel to another position number using [▲ / ▼], then press [ENTER].
  - To move another channel, repeat steps 4 to 5.
- 6** Press [SETUP] to exit.

## Setting the Clock

### Auto Clock Setting

Channel Tuning must be set before setting Auto Clock.

- 1** In stop mode, press [SETUP]. Select "General Setting" using [▲ / ▼], then press [ENTER].
- 2** Select "Clock" using [▲ / ▼], then press [ENTER].

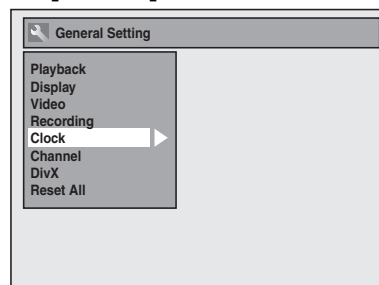

- 3** Select "Auto Clock Setting" using [▲ / ▼], then press [ENTER].
- 4** Select "ON" using [▲ / ▼], then press [ENTER].
  - The current time will be set automatically.
- 5** Press [SETUP] to exit.
- 6** Press [I/⏻ ON / STANDBY] to turn off.

The Auto clock function is activated.

This unit will search for the time every time when the power is turned off. Leave the unit off for several minutes to give it time to set the clock.

#### Hint

- If you want to cancel "Auto Clock Setting," select "OFF" using [▲ / ▼], and then press [ENTER] at step 4.

#### Note

- The default setting of "Auto Clock Setting" is "ON."
- The clock may set itself automatically after you connect the antenna cable to the unit and plug in the mains cable. In this case, the current time will appear on the front panel display.
- To set the clock automatically, the channel assigned to "P04" must receive the PDC signal.
- The clock cannot be set automatically if you are not receiving a channel in your area that carries a time signal. In this case, set the clock manually.
- Once the auto clock setting is performed, the unit will correct the current time by receiving PDC broadcasts whenever the power is turned off.
- The unit will correct the current time automatically at 8:00, if the unit is in standby mode.
- Between 23:00 and 1:00, the Auto Clock function will not operate even when the power is turned off.



## Manual Clock Setting

- 1** In stop mode, press [SETUP]. Select "General Setting" using [▲ / ▼], then press [ENTER].
- 2** Select "Clock" using [▲ / ▼], then press [ENTER].
- 3** Select "Clock Setting" using [▲ / ▼], then press [ENTER].
- 4** Press [ENTER] again.  
Default date will appear.

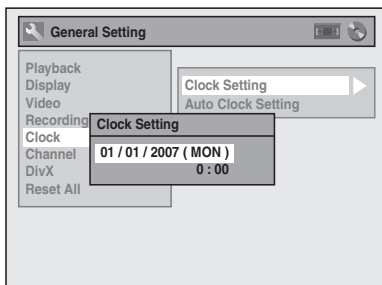

- 5** Enter the date (day / month / year) using [▲ / ▼].

Press [▶] to move the cursor to the next field. If you wish to go back to the previous field, press [◀].

- 6** Enter the time (hours / minutes) using [▲ / ▼], then press [ENTER].

The clock will start.

- Although seconds are not displayed, they will be counted from zero.

- 7** Press [SETUP] to exit.

### Note

- Your clock setting will be lost if either there is a power failure or the unit is unplugged for more than 30 seconds.

## Selecting the TV Aspect Ratio

You can select the TV aspect ratio to match the format of the programme you are playing back with the unit and that of your TV screen (4:3 standard or 16:9 wide screen TV).

- 1** In stop mode, press [SETUP]. Select "General Setting" using [▲ / ▼], then press [ENTER].
- 2** Select "Video" using [▲ / ▼], then press [ENTER].
- 3** Select "TV Aspect" using [▲ / ▼], then press [ENTER].

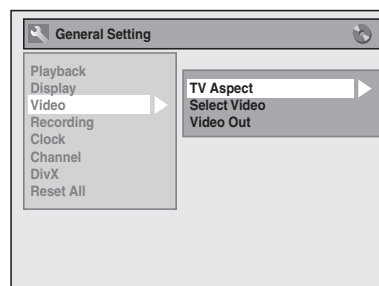

- 4** Select the desired option using [▲ / ▼], then press [ENTER].

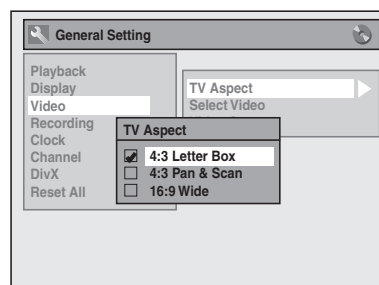

- 5** Press [SETUP] to exit.

### Hint

If you have a standard TV:

- Select "4:3 Letter Box" for a full width picture with black bars at the top and bottom.
- Select "4:3 Pan & Scan" for a full height picture with both sides trimmed.

If you have a wide screen TV:

- Select "16:9 Wide".

Introduction

Connections

Basic Setup

Recording

Playback

Editing

Function Setup

VCR Functions

Others

# Recording

## Information on DVD Recording

### Type of Discs

This unit can record on DVD-RW/-R discs and DVD+RW/+R discs.

DVD-R/+R discs allow you to record programmes only once, and the recorded contents can be erased although the space left on the disc does not change. DVD-RW/+RW discs allow you to record programmes repeatedly, and the recorded contents can be erased. There are 3 recording formats: VR mode, Video mode and +VR mode. VR and Video modes are available for DVD-RW discs while as only Video mode is available for DVD-R discs. +VR mode is available for DVD+RW/+R discs.

Video mode is the same recording format as used on the pre-recorded DVD-Videos you purchase in local shops. You can play back the discs recorded in this format on most of the DVD players. You will need to finalise such discs (see page 41) before playing them back on other DVD players. Unless finalised, you can record additional materials or edit discs recorded in Video mode with this unit.

VR (Video Recording) mode is a basic recording format for DVD-RW discs.

VR mode offers advanced editing, and you can record and edit material repeatedly, however it is playable only on VR mode compatible unit. Finalisation is recommended before playing them back on other unit.

+VR mode is a recording format for DVD+RW/+R disc. +VR mode offers basic editing, and it is playable on most DVD players. Finalisation is recommended before playing them back on other unit.

### Recording Mode

You can select a recording mode from 5 options. The recording time will vary depending on the recording mode you select as follows.

Recording mode	Recording time		Video / Sound Quality
	12 cm	8 cm	
XP	60 min	18 min	☆☆☆☆☆
SP	120 min	36 min	☆☆☆☆
LP	240 min	72 min	☆☆☆
EP	360 min	108 min	☆☆
SLP	480 min	144 min	☆

- This table is intended for a standard new single-sided 12 cm / 8 cm disc. The recording times are estimates and actual recording time may differ.
- The audio and video quality becomes poorer as the recording time gets longer.

### Restrictions on Recording

You cannot record copy-protected video using this unit. Copy-protected video includes DVD-Videos and some satellite broadcasts.

If copy-protected material is detected, recording will pause or stop automatically and an error message appears on the screen.

You can only record "Copy-once only" video using a DVD-RW disc in VR mode with Content Protection for Recordable Media (CPRM).

When recording a TV broadcast or an external input, you can display copy control information on the screen.





CPRM is a scrambling copy protection system for the protection of "copy-once" broadcast programmes.

This unit is CPRM compatible, which means that you can record copy-once broadcast programmes, but you cannot then make a copy of those recordings.

CPRM recordings can only be played back on DVD players that are specifically compatible with CPRM.

### Information on Copy Control

Some satellite broadcasts include copy-protected information. If you wish to record them, refer to the following.

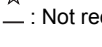
Disc type / format	Copy-free	Copy-once	Copy-prohibited
 ver. 1.1 / ver. 1.2	☆	—	—
ver. 1.1 / ver. 1.2 CPRM compatible	☆	☆	—
 ver. 1.1 / ver. 1.2	☆	—	—
ver. 1.1 / ver. 1.2 CPRM compatible	☆	—	—
 ver. 2.0	☆	—	—
	☆	—	—
	☆	—	—
	☆	☆	☆

☆ : Recordable

— : Not recordable

#### Note

- This unit cannot record on CD-RW or CD-R discs.
- DVD-RW/-R, DVD+RW/+R and CD-RW/-R discs recorded on a personal computer or a DVD or CD recorder may not be played back if the disc is damaged or dirty or if there is condensation on the player's lens.
- If you record a disc using a personal computer, even if it is recorded in a compatible format, it may not be played back because of the settings of the application software used to create the disc. (Check with the software publisher for more detailed information.)
- Discs recorded in Video mode on this unit cannot record additional information using other DVD recorders.

- It is not possible to use a DVD-RW disc formatted with this unit on other DVD recorder unless the content of the disc was also recorded with this unit.
- Since recording is performed using the Variable Bit Rate (VBR) method, the actual remaining time for recording may be a little shorter than the remaining time displayed on the OSD, depending on the picture you are recording.

## Making Discs Playable in Other DVD Players (Finalise)

After recording, you must finalise the disc to play it back in other players. (See page 41.)  
You cannot finalise discs in other DVD recorders.

### After finalising

- After DVD-R discs are finalised:
  - A Title menu is created automatically.
  - Undo finalising is not possible.
  - Additional recording or editing is not possible.
- After DVD-RW (Video mode) discs are finalised:
  - A Title menu is created automatically.
  - Undo finalising is possible. (See page 41.)
  - Additional recording or editing is possible if you undo finalise. (See page 41.)
- After DVD-RW (VR mode) discs are finalised:
  - A Title menu is not created.
  - Undo finalising is possible. (See page 41.)
  - Additional recording or editing is possible if you undo finalise. (See page 41.)
- After DVD+RW discs are finalised:
  - A Title menu is created automatically.
  - Undo finalising is possible. (See page 41.)
  - Additional recording or editing is possible even without undo finalising.
- After DVD+R discs are finalised:
  - A Title menu is created automatically.
  - Undo finalising is not possible.
  - Additional recording or editing is not possible.

## Formatting a Disc

### Choosing the Recording Format of a Blank DVD-RW Disc



When inserting a brand-new DVD-RW/+RW disc, the unit automatically starts to initialise the disc. DVD+RW disc will always be formatted in +VR mode, and DVD-RW disc will be formatted either Video or VR mode according to the recording format mode setting of the unit. Before insert a brand-new DVD-RW disc, you need to set the recording format to the desired mode. You can also manually format a DVD-RW disc once it has been used.

- 1 In stop mode, press [SETUP].**
- 2 Select "DVD Menu" using [▲ / ▼], then press [ENTER].**  
"DVD Menu" menu will appear.
- 3 Select "Format" using [▲ / ▼], then press [ENTER].**  
Format menu will appear.
- 4 Select "Format Mode" using [▲ / ▼], then press [ENTER].**
- 5 Select "Video mode" or "VR mode" using [▲ / ▼], then press [ENTER].**

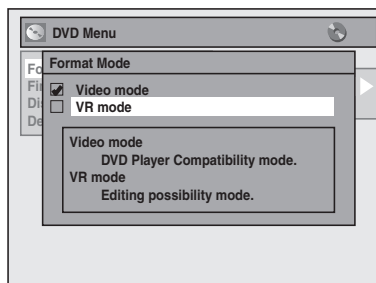

- 6 Press [SETUP] to exit.**
- 7 Insert a blank disc.**  
Formatting will start.
- 8 Formatting is complete.**  
"100%" is indicated.

#### Note

- The recording format setting is effective only for DVD-RW discs. You cannot change the recording format for a DVD-R disc and DVD+RW/+R disc.
- You cannot mix two formats on one DVD-RW disc. If you insert a disc that has been recorded before, the recording format cannot be changed even if you change it in the Setup menu.

Introduction

Connections

Basic Setup

Recording

Playback

Editing

Function Setup

VCR Functions

Others

## Make Recording Compatible



Use this feature to make the unfinalised +VR mode discs recorded on other unit recordable on this unit. When you make an additional recording on this unit with "Make Recording Compatible" set to "ON", the title list is automatically converted to this unit's style.

- 1** In stop mode, press [SETUP]. Select "General Setting" using [▲ / ▼], then press [ENTER].
- 2** Select "Recording" using [▲ / ▼], then press [ENTER].
- 3** Select "Make Recording Compatible" using [▲ / ▼], then press [ENTER].
- 4** Select "ON" or "OFF" using [▲ / ▼], then press [ENTER].

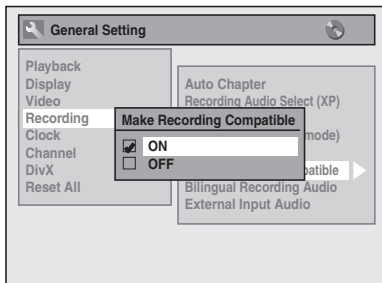

- ON:** Title list will be replaced when you make additional recordings to the discs recorded by other units.
- OFF:** Prohibiting additional record to the disc that has a title list created by other units.

- 5** Press [SETUP] to exit.

## Setting Aspect Ratio for Video Mode Recording



You can set aspect ratio for video mode recording.

- 1** In stop mode, press [SETUP]. Select "General Setting" using [▲ / ▼], then press [ENTER].
- 2** Select "Recording" using [▲ / ▼], then press [ENTER].
- 3** Select "Aspect Ratio (Video mode)" using [▲ / ▼], then press [ENTER].

- 4** Select your desired setting using [▲ / ▼], then press [ENTER].

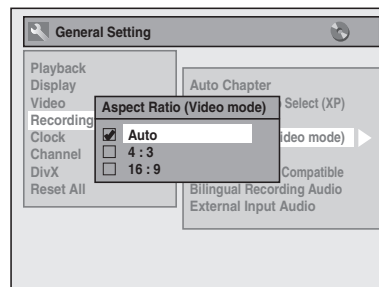

**Auto (default):** It will be recorded with whichever the ratio that the programme you started to record is broadcasted with.

- 4:3 :** Recorded in the aspect ratio of 4:3.  
**16:9 :** Recorded in the aspect ratio of 16:9.

- 5** Press [SETUP] to exit.

### Note

- For VR mode DVD-RW disc, the image will be recorded in whichever the ratio that the programme you record is broadcasted with, regardless of the "Aspect Ratio (Video mode)" setting.
- For DVD+RW/+R disc, the image will always be recorded in aspect ratio of 4:3.

## Setting Auto Chapter



The unit inserts a chapter mark periodically (every 15 minutes by default) during recording. Using the Auto Chapter menu, you can set this function off or change the time period.

- 1** In stop mode, press [SETUP]. Select "General Setting" using [▲ / ▼], then press [ENTER].
- 2** Select "Recording" using [▲ / ▼], then press [ENTER].
- 3** Select "Auto Chapter" using [▲ / ▼], then press [ENTER].

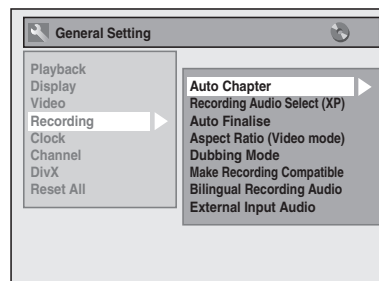

- 4** If you wish to set “Auto Chapter” off, select “OFF” using [▲ / ▼], then press [ENTER].

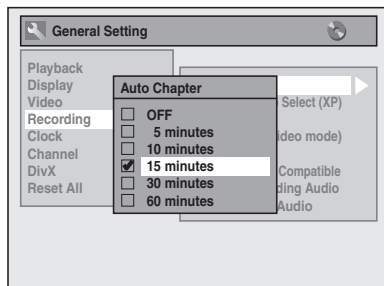

If you wish to change the time period for Auto Chapter, select the required time period using [▲ / ▼], then press [ENTER].

- 5** Press [SETUP] to exit.

#### Note

- The interval for auto chapter marks may slightly deviate from the one you specified on the Auto chapter screen.
- A blank chapter may be created depending on the remaining time of the disc.

## Reformatting a Disc Manually



If you are using a DVD-RW/+RW disc, you can format the disc by performing “Format”. You can format DVD-RW disc for either Video mode recording or VR mode recording. DVD+RW disc can be format in order to erase all content of the disc.

#### Note

- When you reformat the disc, the contents of the disc are erased.
- Make sure that the recording format is set to the desired mode. (See steps 1 to 6 in “Choosing the Recording Format of a Blank DVD-RW Disc” on page 27.)

Insert a recordable disc.

- 1** In stop mode, press [SETUP].
- 2** Select “DVD Menu” using [▲ / ▼], then press [ENTER].
- 3** Select “Format” using [▲ / ▼], then press [ENTER].
- 4** Select “Start” using [▲ / ▼], then press [ENTER].

For DVD+RW, use [▲ / ▼] to select “Yes”, then press [ENTER].

A pop up window will appear and prompt you to confirm.

- 5** Select “Yes” using [▲ / ▼], then press [ENTER].

e.g.) VR mode DVD-RW disc

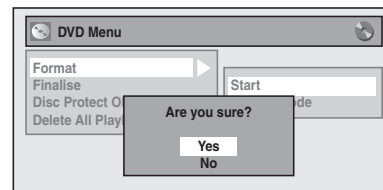

Formatting will start.

If you want to cancel formatting, select “No”.

- 6** Formatting is complete.

#### Note

- It is not possible to use a disc formatted with this unit on other DVD recorder. When you use a disc with another DVD recorder, format a disc using that DVD recorder.

Introduction

Connections

Basic Setup

Recording

Playback

Editing

Function Setup

VCR Functions

Others

## Selecting the Sound Mode

This unit can receive bilingual broadcasts.

You can switch between modes by pressing **[AUDIO **] on the remote control. Each mode is indicated on the TV screen as follows.

- During reception of bilingual broadcasts

Mode	Audio output	Display on the TV screen
Main	Main audio from both speakers	Main
Sub	Sub audio from both speakers	Sub
Main / Sub	<ul style="list-style-type: none"> <li>• Main audio from the left speaker</li> <li>• Sub audio from the right speaker</li> </ul>	Main / Sub

## Setting External Input Audio



When the external input audio is a bilingual broadcast, you can choose "Stereo" or "Bilingual" to record on a DVD.

- 1 In stop mode, press **[SETUP]**. Select "General Setting" using **[▲ / ▼]**, then press **[ENTER]**.
- 2 Select "Recording" using **[▲ / ▼]**, then press **[ENTER]**.
- 3 Select "External Input Audio" using **[▲ / ▼]**, then press **[ENTER]**.

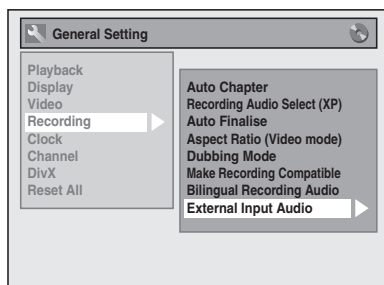

- 4 Select "Stereo" or "Bilingual" using **[▲ / ▼]**, then press **[ENTER]**.

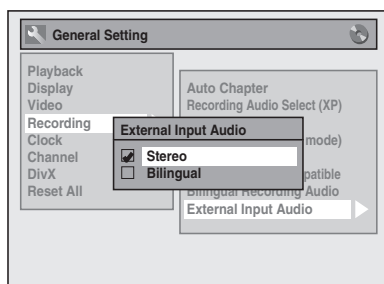

- 5 Press **[SETUP]** to exit.

### Hint

- If you select "Stereo":  
The audio will be recorded as "stereo audio".
- If you select "Bilingual":  
The audio will be recorded as "bilingual audio" (see "Setting Bilingual Recording Audio" below for more detail).

## Setting Bilingual Recording Audio



You can select either "Main" or "Sub" audio to record a bilingual broadcast in Video mode or +VR mode.

- 1 In stop mode, press **[SETUP]**. Select "General Setting" using **[▲ / ▼]**, then press **[ENTER]**.
- 2 Select "Recording" using **[▲ / ▼]**, then press **[ENTER]**.
- 3 Select "Bilingual Recording Audio" using **[▲ / ▼]**, then press **[ENTER]**.
- 4 Select "Main" or "Sub" using **[▲ / ▼]**, then press **[ENTER]**.

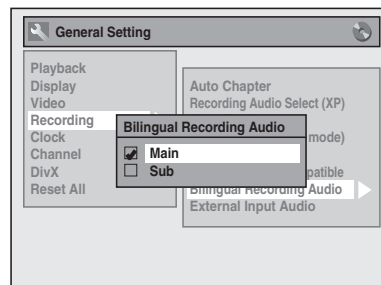

- 5 Press **[SETUP]** to exit.

### Note

- If you are recording onto a VR mode disc, both "Main" and "Sub" will be recorded regardless of your setting here. And when you play back, you can choose either audio format or a combination of both as your playback audio.

## Recording Audio Select (XP)



You can enjoy high quality sound recording. This function works only when the recording mode is set at XP.

- 1 In stop mode, press **[SETUP]**. Select "General Setting" using **[▲ / ▼]**, then press **[ENTER]**.

- 2** Select "Recording" using [**▲** / **▼**], then press [**ENTER**].
- 3** Select "Recording Audio Select (XP)" using [**▲** / **▼**], then press [**ENTER**].
- 4** Select "PCM" or "Dolby Digital" using [**▲** / **▼**], then press [**ENTER**].

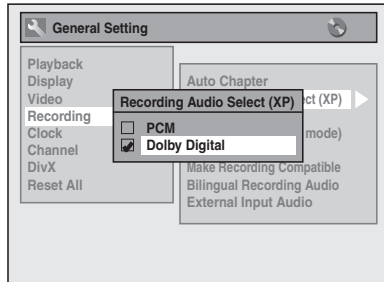

**PCM:** Records PCM audio for the best quality sound.

**Dolby Digital:** Records Dolby Digital audio for good quality sound.

- 5** Press [**SETUP**] to exit.

#### Note

- "PCM" stands for Pulse Code Modulation. It changes analogue sound to digital sound without compressing audio data.
- When the recording mode is set at other than XP, the unit records "Dolby Digital" audio automatically even if you selected "PCM".

## Basic Recording



Follow the steps below to record a TV programme.

- 1** Press [**I/ON** / **STANDBY**] to turn on the unit.  
Turn on the TV and be sure to select the input to which the unit is connected.
- 2** Press [**DVD**].
- 3** Press [**OPEN / CLOSE ▲**] to open the disc tray.
- 4** Place the disc on the disc tray with its label facing up. Be sure to align the disc with the disc tray guide.

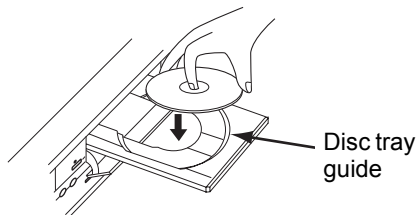

- 5** Press [**OPEN / CLOSE ▲**] to close the disc tray.
- 6** Select the recording mode using [**REC MODE**]. (See page 26.)
- 7** Select the desired channel to record using [**PROG. ^ / v**] or [**the Number buttons**].
- 8** Press [**REC ●**] to start recording.  
The "●" mark will be displayed for 5 seconds.  
To pause the recording, press [**PAUSE III**]. Press [**PAUSE III**] or [**REC ●**] again to restart the recording.
- 9** Press [**STOP ■**] to stop the recording.  
This operation may take a few moments to complete.

#### Hint

- You can change the channel while in the REC pause mode.

#### Note

- Recording starts immediately and continues until the disc is full or you stop recording.
- If the clock is not set, the space for a date and time of title names will be 01/01/07 and 00:00.
- You cannot change the recording mode in the REC or REC pause mode.
- If you want to monitor the programme that you are recording, make sure the device such as a Satellite Box is turned off or press [**DISPLAY**] when it is connected to AV2.
- Up to 99 titles can be recorded on the DVD-RW/R discs.
- Up to 49 titles can be recorded on the DVD+RW/+R discs.
- NTSC recording is prohibited in this unit.
- You can play back a title on one device while making a recording on other device. To do so, simply select the device (DVD or VCR) you like to use for the playback by pressing [**DVD**] or [**VCR**] button during DVD / VCR recording. And then follow the normal DVD / VCR playback procedure.

Introduction

Connections

Basic Setup

Recording

Playback

Editing

Function Setup

VCR Functions

Others

## One-touch Timer Recording (OTR)



This is a simple way to set the recording time in blocks of 30 minutes. Check that the disc you are recording onto has enough space remaining for the time you set.

### 1 Turn on the unit and insert a recordable disc.

Make sure that the TV input is set on the unit.

### 2 Press [DVD].

### 3 Select the recording mode using [REC MODE]. (See page 26.)

### 4 Select the desired channel to record using [PROG. ^ / v] or [the Number buttons].

### 5 Press [REC ●] repeatedly until the desired recording time (30 minutes to 8 hours) appears on the TV screen.

One-touch Timer Recording will start.

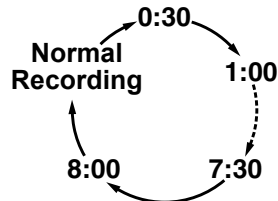

- When the unit reaches the specified time, it will be turned off automatically.
- To change the recording length during One-touch Timer Recording, press [REC ●] repeatedly until the desired length appears.
- To cancel One-touch Timer Recording within the specified time, press [STOP ■].

#### Hint

- The remaining recording time will appear on the TV screen during One-touch Timer Recording. Press [DISPLAY] to see it on the TV screen.
- The remaining recording time will be displayed on the front panel display during One-touch Timer Recording.
- Unlike the timer recording, you can perform the following operations during One-touch Timer Recording.
  - Turn off the power. (One-touch timer recording will be cancelled.)
  - Use [REC ●] or [STOP ■] on the remote control.

#### Note

- You cannot use the pause function during One-touch Timer Recording.
- The unit will be turned off automatically under the following conditions.
  - No space remains on the disc.
  - If a power failure occurs.

- If DVD One-touch Timer Recording is completed during VCR playback or recording, the DVD will be in stop mode and the VCR keeps the current mode.
- When One-touch Timer Recording is finished and the power is turned off, the unit will switch to the timer-standby mode automatically if a timer recording has been programmed. Press [TIMER SET] to cancel the timer-standby mode to use the unit continuously.
- If you want to monitor the programme that you are recording, make sure the device such as a Satellite Box is powered off or press [DISPLAY] when it is connected to AV2.



## Timer Recording



You can set the unit to record up to 12 programmes, up to a month in advance. Daily or weekly programme recordings are also available.

- Be sure to set the clock before entering a timer programming.

**Insert a recordable disc or a tape with a record tab.**

### 1 In stop mode, press [TIMER PROG].

Timer Programming list will appear.

### 2 Select "New Program" using [▲ / ▼], then press [ENTER].

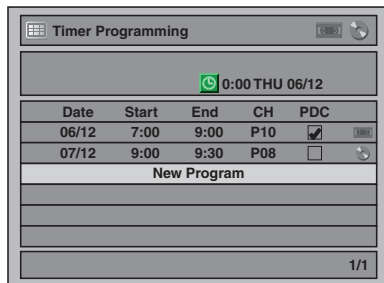

- If there are 7 programmes or more, use [SKIP |◀◀ / ▶▶|] to turn the page.

### 3 Enter the date using [▲ / ▼], then press [▶].

Each time you press [▼] at the current date, the timer recording date will change as follows.

e.g., 1st January

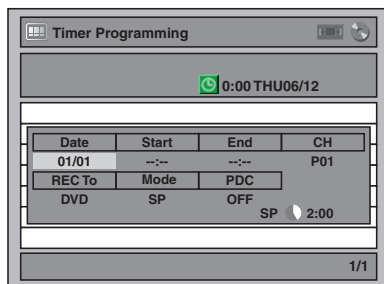
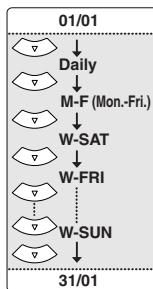

### 4 Enter the time to start and to end using [▲ / ▼], then press [▶].

### 5 Select the channel number to record using [▲ / ▼], then press [▶].

To record from the external input, select "AV1", "AV2", or "AV3".

### 6 Select the recording media ("DVD" or "VCR") using [▲ / ▼], then press [▶].

### 7 Select the recording mode using [▲ / ▼], then press [▶].

Refer to "Recording Mode" on page 26 for DVD or page 72 for VCR.

### 8 Select "PDC" to "ON" or "OFF" using [▲ / ▼].

Refer to "PDC (Programme Delivery Control)" on page 34.

### 9 Press [ENTER] when all information required is entered.

Your programme setting is stored.

- To set another programme, repeat steps 2 to 9.
- To exit, press [TIMER PROG].

• When 2 or more programmes are overlapped, "Timer program overlapped" appears, and the overlapped programme will be displayed in blue. To correct the timer Programme, Refer To "Checking, Cancelling or Correcting the Timer Programming Information" on page 34.

### 10 Press [TIMER SET].

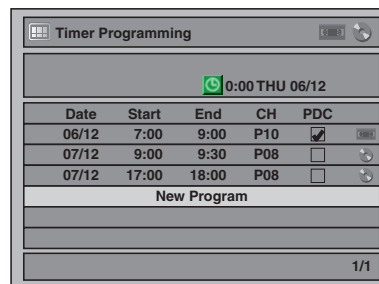

The icon will appear on the front panel display and the unit enters to the timer-standby mode.

#### Note

- If you have not set the clock, the clock setting window will appear instead of the Timer Programming list. Continue from step 4 in "Manual Clock Setting" on page 25 before programming the timer.
- Use [◀ / ▶] to move the cursor to the left and the right in the entry screen for the timer programming.
- If a basic recording or One-touch Timer Recording is in progress on one component (e.g. VCR) and the timer recording set for the other component (e.g. DVD) is about to begin, the unit automatically switches to the programmed channel for timer recording 2 minutes before the programmed starting time, and the recording in progress (for VCR) will be cancelled UNLESS their recording channels are the same. If their recording channels are the same, the timer recording will start without cancelling the recording currently in progress. In this case, the recording of the same channel will be made on both DVD and VCR.

- Cancel the timer-standby mode by pressing **[TIMER SET]** before operation for either DVD or VCR. When finished operating, press **[TIMER SET]** to resume the timer-standby mode.
- In the timer-standby mode, you can turn on the power and use the component (VCR or DVD) which is not currently timer-programmed.

## PDC (Programme Delivery Control)

The Programme Delivery Control (PDC) assures that the TV programmes you have programmed for timer recording are recorded exactly from beginning to end, even if the actual broadcasting time differs from the scheduled time due to a delayed start or extension of the programme duration. Furthermore, if a programme is interrupted, the recording will also be interrupted automatically and resumed when the programme starts again.

If the PDC signal drops out because the broadcast signal is weak, or if a broadcasting station does not transmit a regular PDC signal, the timer recording is performed in normal mode (without PDC) even if it was programmed for PDC. If the starting time of the PDC timer recording is between 0:00 and 3:59 on a given day, the PDC function will operate from 20:00 on the previous day to 4:00 on the next day. If the starting time of the PDC timer recording is between 4:00 and 23:59 on a given day, the PDC function will operate from 0:00 on the given day to 4:00 on the next day. This means that if the relevant programme is broadcasted within this period, it is recorded correctly. If the timer is not programmed correctly, the incorrect timer setting stays in effect unless you cancel it. To cancel an incorrect timer setting, refer to "Checking, Cancelling or Correcting the Timer Programming Information" below.

## Checking, Cancelling or Correcting the Timer Programming Information

- 1 Press [TIMER SET] so that the  icon disappears from the front panel display.**
- 2 Press [TIMER PROG].**  
Timer Programming list will appear.
- 3 Check the information on the list you want to edit.**

## 4 A) To delete the timer programme:

- 1) Select the programme you want to delete using **[▲ / ▼]**, then press **[ENTER]**.
- 2) Select "Delete" using **[▲ / ▼]**, then press **[ENTER]**.  
Confirmation window will appear.
- 3) Select "Yes" using **[▲ / ▼]**, then press **[ENTER]**.

## B) To correct the timer programme:

- 1) Select the programme you want to correct using **[▲ / ▼]**, then press **[ENTER]**.
- 2) Select "Program Change" using **[▲ / ▼]**, then press **[ENTER]**.
- 3) Correct the timer programme by using **[▲ / ▼ / ◀ / ▶]**, then press **[ENTER]**.

## 5 Press [TIMER PROG] to exit.

## 6 Press [TIMER SET] to return to the timer-standby mode.

To check the timer programming in process  
Press **[TIMER PROG]**.

### Note

- If a timer recording is proceeding, that programme is highlighted in red. In such a case, you cannot select any other programmes.
- When you check the timer programming in progress by pressing **[TIMER PROG]** during operations of the component (DVD or VCR) which is not currently used for the timer recording, the programme will not be highlighted. In this case, you cannot select other programmings.

## To Stop the Timer Recording in Progress

On the front panel of the unit, press **[■ (STOP)]** to stop the disc recording or **[▲/■ (STOP / EJECT)]** to stop the tape recording.

### Note

- **[STOP ■]** on the remote control is not effective.

## If the Timer Programming did not Complete Correctly

The error number appears on the Timer Programming list.

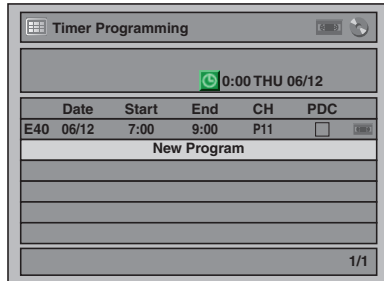

The error programme will be displayed in grey with an error number.

### The error numbers indicate:

- E1–E22,
- E37–E39: Recording error
- E23–E24: Unrecordable disc
- E25 : • Copy prohibited programme
  - Cannot record because of the NTSC / PAL-60 signal is received.
- E26–E28: Copy prohibited programme
- E29 : Disc protected
- E30 : Disc full
- E31 : Already recorded 99 titles (Video mode)
- E32 : Already recorded 99 titles (VR mode)
- E33 : Already recorded 999 chapters
- E34 : No space for Control Information
- E35 : PCA (Power Calibration Area) full
- E36 : Already finalised Video format disc
- E40 : • There are some unrecorded parts due the overlapped timer programmes.
  - Recording did not start at the start time.
  - There is no tape in the cassette compartment.
  - Tape recording reaches to the tape end during timer recording.
- E41 : Power failure
- E42 : No disc
- E43 : Already 49 titles recorded (+VR mode)
- E44 : Already 254 chapters recorded (+VR mode)
- E45 : Copy prohibited programme
- E46 : It is impossible to record additionally on a disc recorded by other units when setting "Make Recording Compatible" to "OFF". (+VR mode)

The error programme will be deleted once you check the error in the programme list, or once you cancel the timer-standby mode and re-enter it.

## Hints for the Timer Recording

- If there is a power failure or the unit is unplugged for more than 30 seconds, the clock setting and all timer settings will be lost.
- If there is no disc or an unrecordable disc in the tray (finalised DVD-RW/-R, finalised DVD+R, a fully recorded disc, etc.), the **DVD** on the front panel display will flash and the timer recording will not occur. Insert a recordable disc.

- If there is no tape or a tape with a record tab is not in the cassette compartment, the **VCR** on the front panel display will flash and the timer recording cannot be performed. Please insert a recordable tape.
- When all timer recordings are complete, the  icon flashes. To play back or eject the recorded disc, press **[TIMER SET]**, and then press **[PLAY ►]** or **[OPEN / CLOSE ▲]**.
- The timer recording cannot be performed in DVD and VCR at the same time. If you set two programmings with the same channel and time both in DVD and VCR, the programming that has priority will be recorded.
- You cannot make any DVD operation during DVD timer recording.
- You cannot make any VCR operation during VCR timer recording.
- If the Start and End times are same, the length of the recording will be set for 24 hours. If the disc or tape becomes full during recording, the unit will turn itself off. To continue recording, press **[TIMER SET]** to cancel the timer-standby mode, insert a recordable disc or tape and press **[TIMER SET]** again.
- When 2 or more programmes are overlapped, "Timer program overlapped" appears, and the overlapped programme will be displayed in blue. To correct the timer programme refer to "Checking, Cancelling or Correcting the Timer Programming Information" on page 34.
- If the Start time is earlier and the End time is later than the current time, the recording will start immediately after you press **[TIMER SET]**.
- If a videotape ends during the timer recording, the unit will automatically stop, eject the videotape, and turn itself off. To continue recording, insert a recordable tape.

### Priority of overlapped settings

The unit records programmes according to priority if the timer programmes overlap.

### If the starting time is same:

- The timer programming set first (PROG. 1) has priority.

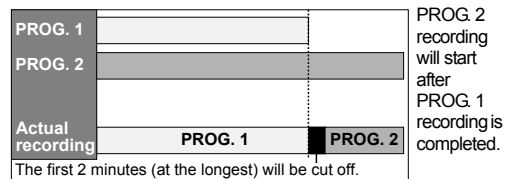

### When the starting time and the ending time for each programmes are different:

- A programme that has earlier start time has priority.

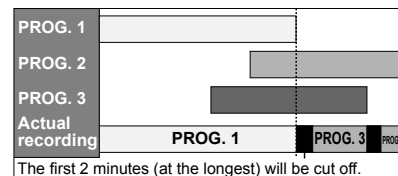

Introduction

Connections

Basic Setup

Recording

Playback

Editing

Function Setup

VCR Functions

Others

**If the recording time is partially overlapped:**

- The timer programming with the earlier start time (PROG. 2) has priority. PROG. 1 will start after PROG. 2 recording is complete.

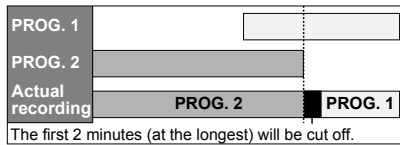
**If the recording time entirely overlaps:**

- The shorter timer programming (PROG. 1) is not recorded.

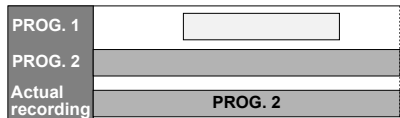
**Note for DVD recording**

- If the recording time of two programmes are overlapped, or the End time of a programme and the Start time of another is same, the first 2 minutes (at the longest) of the subsequent programme will be cut off.

**If the End time of the programme currently being recorded and the Start time of the subsequent programme are same:**

- If PROG. 1 is a DVD recorded programme, the beginning of PROG. 2 may be cut off.

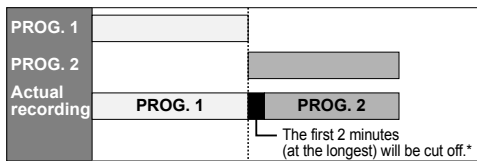

\*If the cut off time exceeds 3 minutes, the error number "E40" will appear in the Timer Programming list.

## Satellite Link

You can set the unit to start recording whenever it detects the video scart control from the external tuner.

**Preparing for the Satellite Link Timer Recording:****[Preparation of the external tuner]**

- The external tuner should be equipped with some kind of timer function. Using timer function of the tuner, set it to be turned on when it comes to the time you want to start recording, and off when it comes to the time you want to finish recording. (Refer to the tuner's manual on how to set the timer.)
- Make sure to turn off the external tuner when you finish setting.

**[Preparation of this unit]**

- Make sure to select the desired Recording mode beforehand.

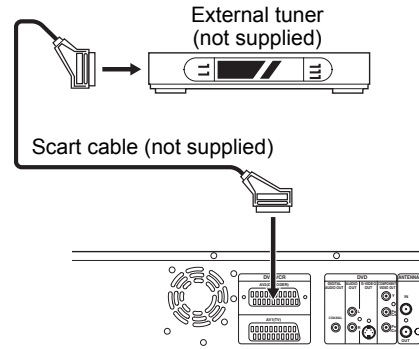

- Press **[SAT.LINK]**.
- Select the time, media or mode using **[▲ / ▼]**, then press **[ENTER]**.

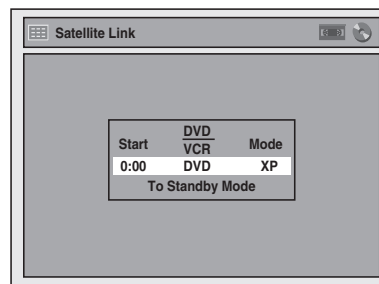

- Set the desired start time using **[▲ / ▼]**, then press **[▶]**.
  - The hour can be selected among 0-23.
  - Repeat this step to set the desired minutes.
- Select the recording media using **[▲ / ▼]**, then press **[▶]**.
- Select the recording mode using **[▲ / ▼]**.
 

Refer to "Recording Mode" on page 26 for DVD or page 72 for VCR.

  - If you want to edit the time, media or mode press **[◀]**, then press **[▲ / ▼]** to correct them.

## 6 Press [ENTER].

"To Standby Mode" is highlighted.

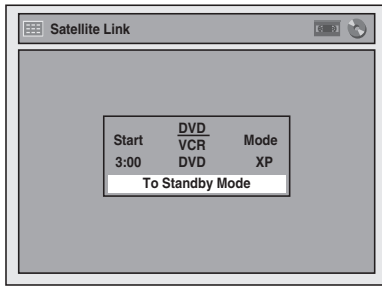

## 7 Press [ENTER] again.

In a second, the unit will be turned off automatically as it goes into the Satellite Link standby mode.

- Until the time you set in "Start", the clock will appear on the front panel display.
- "Sat" will appear on the front panel display at the start time.



**To cancel the Satellite Link function while in the Satellite Link standby mode:**

Press [TIMER SET] to turn on the unit.

**To cancel the Satellite Link function while the Satellite Link Recording is in progress:**

Press [■ (STOP)] on the front panel of the unit.

### Note

- If you have not set the clock, the clock setting window will appear at step 1. Follow to step 4 in "Manual Clock Setting" on page 25.
- You cannot set the End time for the Satellite Link Timer Recording on this unit.
- Recording picture will be distorted if the copy protection signal is being detected during Satellite Link Timer Recording.
- When a regular Timer Recording and the Satellite Link Timer Recording are overlapped, the examples are given below.

	Example 1
Timer Recording	
Satellite Link	
Actual Recording	

	Example 2
Timer Recording	
Satellite Link	
Actual Recording	

	Example 3
Timer Recording	
Satellite Link	
Actual Recording	

Introduction

Connections

Basic Setup

Recording

Playback

Editing

Function Setup

VCR Functions

Others

## Settings for External Equipment

### Connection to External Equipment



Connect the external equipment using either the input jacks, AV1, AV2 (Rear) or AV3 (Front). However, for AV3 jacks, you have to select S-VIDEO input or VIDEO input jacks depending on the connected devices.

Use a commercially available Scart, S-Video or Video cable and an Audio cable for this connection.

- 1** In stop mode, press [SETUP]. Select "General Setting" using [▲ / ▼], then press [ENTER].
- 2** Select "Video" using [▲ / ▼], then press [ENTER].
- 3** Select "Select Video" using [▲ / ▼], then press [ENTER].
- 4** Select the input jack type to be used using [▲ / ▼], then press [ENTER].

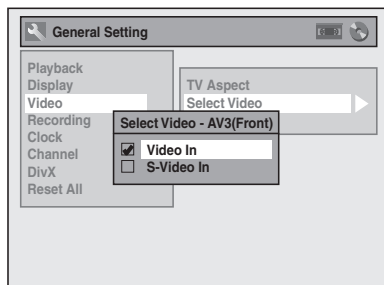

- If you want to use VIDEO input jack (Composite), select "Video In".
- If you want to use S-VIDEO input jack, select "S-Video In".

- 5** Press [SETUP] to exit.

### Recording from External Equipment



Before recording from external equipment, see page 20 for connection instructions.

- 1** Turn the TV and the unit on, and select the input of the TV to which the unit is connected.

- 2** When you want to record to the disc:  
Press [DVD].  
Press [OPEN / CLOSE ▲] to open the disc tray, then place the disc to record on.  
Press [OPEN / CLOSE ▲] again to close the disc tray.

When you want to record to a tape:  
Press [VCR].  
Insert the tape with a record tab into the cassette compartment.

- 3** Select the input terminal to which the external equipment is connected. (AV1, AV2, or AV3)  
To use the input jacks on the back of the unit, select the "AV1" or "AV2" position by pressing [INPUT SELECT -⊖] on the remote control or using [PROG. ^ / ∨].  
To use the input jacks on the front of this unit, select "AV3" position by pressing [INPUT SELECT -⊖] on the remote control or using [PROG. ^ / ∨].  
• You can also select the input terminals by using [the Number buttons].  
- For AV1, press [0], [0], [1].  
- For AV2, press [0], [0], [2].  
- For AV3, press [0], [0], [3].

- 4** Select a recording mode using [REC MODE].

Refer to "Recording Mode" on page 26 for DVD or page 72 for VCR.

- 5** Press [● REC] (DVD / VCR) on the unit to start recording.
- 6** Press the PLAY button on the external recording component.
- 7** For disc:  
Press [■ (STOP)] on the unit to stop recording.

#### For tape:

Press [▲/■ (STOP / EJECT)] on the unit to stop recording.

#### Note

- During recording, if a signal other than PAL is detected (such as NTSC), recording is paused.
- If you want to monitor the programme that you are recording, make sure the device such as a Satellite Box is turned off when it is connected to AV2.

## Dubbing Mode



You can copy a DVD disc to a videotape or copy a videotape to a DVD disc. This function will be available only if the DVD disc or the tape is not copy-protected. Before starting this function, prepare for the recording on the DVD-RW/-R, DVD+RW/+R disc or the videotape. See pages 26 and 72.

### Note for recording to a tape:

- The tape's record tab is intact.
- The videotape is long enough to record the DVD disc.

### Note for recording to a disc:

- The DVD disc is satisfied with the recording status. See page 26.

### Insert a disc and a tape with a record tab.

**1** In stop mode, press [SETUP]. Select "General Setting" using [▲ / ▼], then press [ENTER].

**2** Select "Recording" using [▲ / ▼], then press [ENTER].

**3** Select "Dubbing Mode" using [▲ / ▼], then press [ENTER].

Option window will appear.

#### VCR to DVD

**4** Select "VCR → DVD" using [▲ / ▼], then press [ENTER].

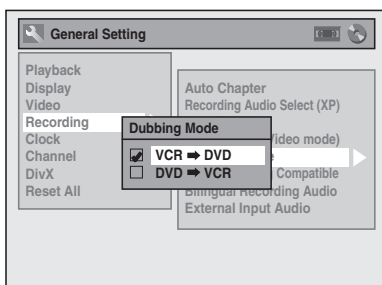

**5** Press [SETUP] to exit.

**6** Press [VCR].

**7** Press [PLAY ►], and then press [PAUSE II] at the point you wish to start recording.

**8** Press [DVD].

Make sure to select a recording mode using [REC MODE]. (See page 26.)

**9** Press [DUBBING].

VCR to DVD duplication will start.

**10** Press [STOP ■] to stop the recording.

#### Note for VCR to DVD duplication:

- After starting VCR to DVD duplication, the picture may be distorted because of the auto tracking function. This is not a malfunction. Be advised to play back the tape until the picture is stabilised, then set the starting point which you wish to start recording, and start VCR to DVD duplication.
- This unit will automatically stop the duplication if playback with no image detected for more than 3 minutes during VCR to DVD duplication.
- If the playback sound mode of VCR is set to "STEREO", "LEFT" or "RIGHT", the sound mode upon dubbing is automatically switched to "STEREO". If the playback sound mode is set to "MONO", the sound mode upon dubbing is also "MONO".
- If you set "External Input Audio" to "Stereo", the sound is recorded in "Stereo" (Video mode, VR mode and +VR mode).
- While in Video mode or +VR mode, if you set "External Input Audio" to "Bilingual", the audio set in "Bilingual Recording Audio" mode is recorded. While in VR mode, if you set "External Input Audio" to "Bilingual", bilingual audio is recorded.
- The main and sub audio will be simultaneously recorded (VR mode). You can select audio modes during playback.
- If you want to watch the duplicated material, after the VCR to DVD duplication, press [DVD] first then press [PLAY ►].

#### DVD to VCR

**4** Select "DVD → VCR" using [▲ / ▼], then press [ENTER].

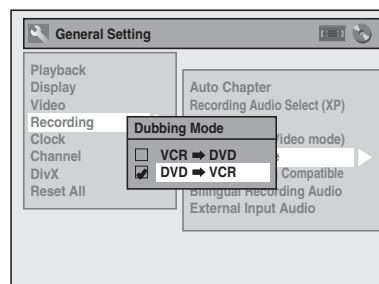

**5** Press [SETUP] to exit the Setup menu.

**6** Press [DVD].

**7** Press [PLAY ►], and then press [PAUSE II] at the point you wish to start recording.

**8 Press [VCR].**

Make sure to select a recording mode using [REC MODE]. (See page 72.)

Rewind or fast forward the tape to the point where you want to start recording.

**9 Press [DUBBING].**

DVD to VCR duplication will start.

**10 Press [STOP ■] to stop the recording.****Note**

- NTSC dubbing is prohibited in this unit.
- Dubbing Mode is available only if the tape or disc is not copy-protected.
- You cannot change the output mode during VCR to DVD or DVD to VCR duplication.
- If you want to watch the duplicated material, after the DVD to VCR duplication, press [VCR] first and then press [PLAY ▶].

**Setting a Disc to Protect**

To prevent accidental over-recording, editing or erasing of recordings, you can protect them using the Setup menu.

Insert a recordable disc.

- 1** In stop mode, press [SETUP].
- 2** Select "DVD Menu" using [▲ / ▼], then press [ENTER].
- 3** Select "Disc Protect OFF ➔ ON" using [▲ / ▼], then press [ENTER].
- 4** Select "Yes" using [▲ / ▼], then press [ENTER].

The disc is protected.

**5 Press [SETUP] to exit.****Note**

- The Disc Protect setting is available only when a disc recorded in VR or +VR mode is inserted.
- You can select only "Disc Protect ON ➔ OFF" when a protected disc is inserted.

**To cancel the disc protect:**

- Select "Disc Protect ON ➔ OFF" at step 3, then select "Yes".
- If you insert a disc protected with this unit, "Disc Protect ON ➔ OFF" will appear instead of "OFF ➔ ON".



## Finalising Discs



You will need to finalise discs to play them back in other players.

Finalising may take from several minutes up to an hour.

A shorter recording period on the disc will require a longer time period for finalisation. Do not unplug the mains cable during finalisation.

### Insert a recordable disc before finalising.

- 1** In stop mode, press [SETUP].
- 2** Select "DVD Menu" using [▲ / ▼], then press [ENTER].
- 3** Select "Finalise" using [▲ / ▼], then press [ENTER].
- 4** Select "Yes" using [▲ / ▼], then press [ENTER].

e.g.) VR mode DVD-RW disc

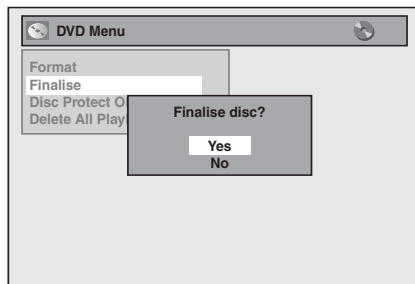

Finalising will start.

### To cancel finalising (DVD-RW disc only):

At step 4, press [STOP ■]. Select "Yes" using [▲ / ▼], then press [ENTER]. Finalising is cancelled and the unit switches to stop mode.

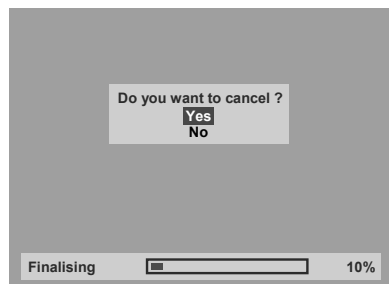

If ⏻ appears when [STOP ■] is pressed, you cannot cancel finalising because the finalising has already reached a critical point in its process.

If "No" is selected and [ENTER] or [RETURN] is pressed, finalising is continued.

You cannot cancel finalising a DVD-R and DVD+RW/+R disc once it has started.

## 5 Finalising is complete.

### Hint

- Finalising a disc in Video mode and +VR mode automatically creates a Title menu.
- After you finalise the DVD+RW disc, you can call up the title list by pressing [TOP MENU], or you can call up the Title menu by pressing [DISC MENU].
- Even after DVD+RW disc is finalised, you can still record or edit. After you finalise DVD-RW/-R or DVD+R disc, you cannot edit or record anything else on that disc.
- To release the finalisation of the disc, select "Undo Finalise" at step 3.
- To release the finalisation of the DVD+RW disc, make an additional recording to the disc.
- For DVD+RW disc, if you have added or deleted chapters, or made chapters hidden, you must finalise the disc before being able to see those effects on other units. To play back discs other than DVD+RW disc on other DVD players, you will need to finalise.

### Note

- If you insert a DVD-RW disc finalised with this unit, "Undo Finalise" will appear instead of "Finalise".
- DO NOT power off during finalising. This may result in a malfunction.

## Auto Finalise



You can finalise discs automatically when the disc space runs out if you set this in the Setup menu.

- 1** In stop mode, press [SETUP]. Select "General Setting" using [▲ / ▼], then press [ENTER].
- 2** Select "Recording" using [▲ / ▼], then press [ENTER].
- 3** Select "Auto Finalise" using [▲ / ▼], then press [ENTER].
- 4** Select "ON" using [▲ / ▼], then press [ENTER].

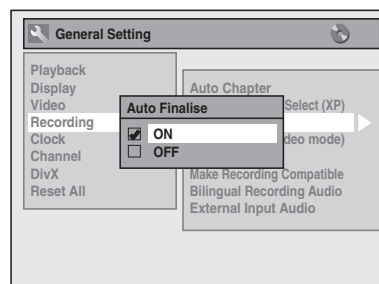

## 5 Press [SETUP] to exit.

### Note

- Auto finalise function is not available for discs formatted in VR mode.

# Playback

## Basic Playback

### Hint for DVD Playback

The contents of a DVD are generally divided into titles. Titles are sometimes further subdivided into chapters.

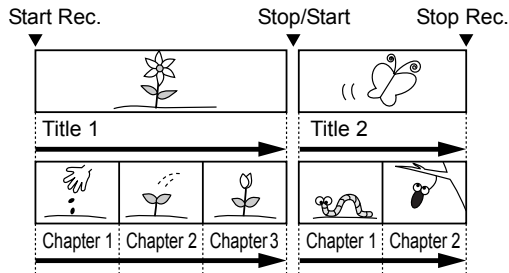

### Playing Back a DVD-RW / DVD-R / DVD+RW / DVD+R Disc



- 1 Press [I/ON / STANDBY] to turn on the unit.

Turn on the TV and be sure to select the input to which the unit is connected.

- 2 Press [DVD].
- 3 Press [OPEN / CLOSE ▲] to open the disc tray.
- 4 Place the disc on the disc tray with its label facing up. Be sure to align the disc with the disc tray guide.

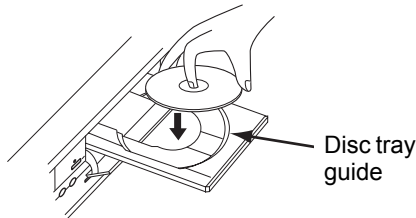

- 5 Press [OPEN / CLOSE ▲] to close the disc tray.
- 6 Press [TOP MENU] to display the title list.

You can switch between the "Original" and "Playlist" in the VR mode using [DISC MENU].

- 7 Select the desired title using [▲ / ▼ / ◀ / ▶], then press [ENTER].  
Pop up window will appear.

- 8 Select "Play From Start" using [▲ / ▼], then press [ENTER].  
Playback will start.

- 9 Press [STOP ■] to stop playback.  
To eject the disc, press [OPEN / CLOSE ▲] to open the disc tray, then remove the disc. Press [OPEN / CLOSE ▲] to close the disc tray before turning off the unit.

#### Hint

- For DVD-R (Video mode), DVD-RW (Video mode) and DVD+R discs that are already finalised, a Title menu will be displayed instead of thumbnails.
- After you finalise the DVD+RW, you can call up the title list by pressing [TOP MENU], or you can call up the Title menu by pressing [DISC MENU].
- You can resume playback from where you stopped playing back the disc (Resume playback). See page 48 for details.
- You can also start playback by pressing [PLAY ▶] instead of [ENTER] at step 7.

#### Note

- Some discs may start playback automatically.

### Playing Back a DVD-V / Video CD (without PBC Function)



- 1 Follow steps 1 to 5 in "Playing Back a DVD-RW / DVD-R / DVD+RW / DVD+R Disc".

- 2 Press [PLAY ▶] to start playback.  
Playback will start.

If you are playing back a DVD-Video, a menu may appear.  
See pages 46 - 47 for details.

- 3 Press [STOP ■] to stop playback.

#### Note

- Some discs may start playback automatically.
- For playing back a Video CD with PBC function, see page 47.

## Playing Back an Audio CD, MP3 or JPEG



### 1 Follow steps 1 to 5 in “Playing Back a DVD-RW / DVD-R / DVD+RW / DVD+R Disc” on page 42.

The File List will appear.

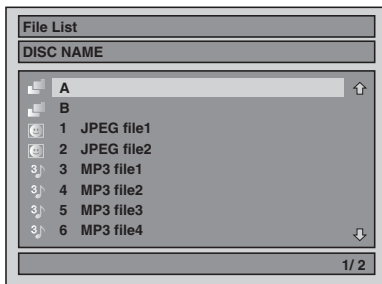

To exit the File List, press [TOP MENU] again or press [STOP ■].

To resume the File List, press [TOP MENU].

### 2 Press [▲ / ▼] to select the desired folder or track / file, then press [ENTER].

**If a track / file is selected:**

Playback will start.

**If a folder is selected:**

The files in the folder will appear.

Press [▲ / ▼] to select the folder you want, then press [ENTER].

- Press [PLAY ►], [ENTER] or [▶] to move to any lower folders.
- Press [◀] or [RETURN] to move back to the folder above.

#### Hints for Audio CD tracks and MP3 / JPEG files:

- Folders are shown with the icon.
- Audio CD tracks are shown by icon.
- MP3 files are shown with the icon. Playback will start from the selected track and continue with each one after.
- JPEG files are shown with the icon.
- The unit can recognise up to 255 folders and up to 99 tracks / 999 files.
- Letters of a file / folder name overflowing the given space will be displayed as “...”.
- Unplayable folders and tracks / files may be displayed depending on the recording conditions.
- For MP3 file recorded in Variable Bit Rate (VBR), the unit may not display the actual elapsed time.
- If there are no files in the folder, “No Files” is displayed.
- High resolution or large-size JPEG files take a few moments to be displayed.
- It is not possible to play back progressive JPEGs (JPEG files saved in progressive format) on this unit.
- It is not possible to play back JPEG files of 12 MB or more.

**It is recommended that files to be played back in this unit are recorded under the following specifications:**

[MP3]

- Sampling frequency : 44.1 kHz or 48 kHz
- Constant Bit Rate : 112 kbps to 320 kbps

[JPEG] Size of picture

- Upper limit : 6,300 x 5,100 dots
- Lower limit : 32 x 32 dots
- Capacity limit : less than 12 MB

#### Note

- MP3 files cannot be recorded as digital sound using an MD or DAT deck.
- Files with extensions other than “.mp3 (MP3)” or “.jpg / .jpeg (JPEG)” will not be listed in the File List.
- Some folders or tracks listed in the File List may be unplayable due to their recording status.
- The File List displays only up to 8 folder and file names.

#### Notes on JPEG:

After file is displayed for 5 seconds or 10 seconds (set in the “Slide Show” on page 54), the display moves to the next file.

During JPEG playback, press [▶] or [◀] to rotate a picture 90 degrees clockwise or counterclockwise respectively. (Not available when the display menu appears.)

## Playing Back a DivX®



### 1 Follow steps 1 to 5 in “Playing Back a DVD-RW / DVD-R / DVD+RW / DVD+R Disc” on page 42.

The File List will appear.

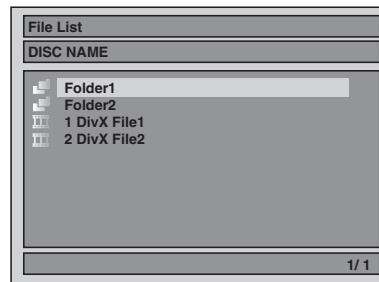

To exit the File List, press [TOP MENU] again or press [STOP ■].

To resume the File List, press [TOP MENU].

### 2 Press [▲ / ▼] to select the desired folder or file, then press [ENTER].

**If a file is selected:**

Playback will start.

**If a folder is selected:**

The files in the folder will appear.

Press [▲ / ▼] to select the file or folder you want, then press [ENTER].

- Press [PLAY ►], [ENTER] or [▶] to move to any lower folders.
- Press [◀] or [RETURN] to move back to the folder above.

Introduction

Connections

Basic Setup

Recording

Playback

Editing

Function Setup

VCR Functions

Others

## DivX® Subtitle

The subtitle created by the user can be displayed during DivX® playback.

### 1 After the DivX® file is selected, the Subtitle List will appear.

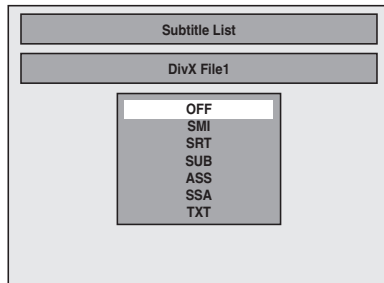

### 2 Select the desired extension you want to display using [▲ / ▼], then press [ENTER]. DivX® with the subtitle starts playback. The subtitle cannot be displayed when the setting is "OFF".

- If there is more than one extension, the extension selection will appear in the Subtitle List.

#### Note

- "DivX Subtitle" must be activated in the DivX Menu. (Refer to "DivX Subtitle" on page 70.)
- Playback file and the subtitle file must have the same name.
- Playback file and the subtitle file must locate in the same folder.
- Only the subtitle files with the following extensions are supported; .smi (.SMI), .srt (.SRT), .sub (.SUB), .ass (.ASS), .ssa (.SSA), .txt (.TXT). (.sub (.SUB) and .txt (.TXT) files may not be recognised.)
- The subtitles that exceed the playback time of the DivX® file will not be displayed.

**It is recommended that files to be played back in this unit are recorded under the following specifications:**

#### [DivX®]

- Official DivX® Certified product
- Playable Codec of AVI files : DivX®3.x,  
DivX®4.x,  
DivX®5.x,  
DivX®6.x
- Maximum size of image : 720 x 480 @30 fps  
720 x 576 @25 fps
- Sampling frequency of audio: 8 kHz - 48 kHz
- Audio type : MPEG1 audio layer 3  
(MP3), MPEG1  
audio layer 2,  
Dolby Digital

## Hint for the purchased or rental official DivX® Certified product

- When you purchased or rental a DivX® file through the official site of DivX® Video which is called DivX® Video-On-Demand (VOD) services, a registration code is required every time you get the new file from the DivX® VOD services. Refer to "DivX® VOD" on page 45.
- Some DivX® VOD files are restricted with the limited playable times (you cannot play them back beyond the limit). If your DivX® VOD file has such limit, the playback confirmation screen will appear.

Use [◀ / ▶] to select "Yes" if you want to play back the file, or to select "No" if you do not wish to play it back. Then press [ENTER] to confirm the selection.

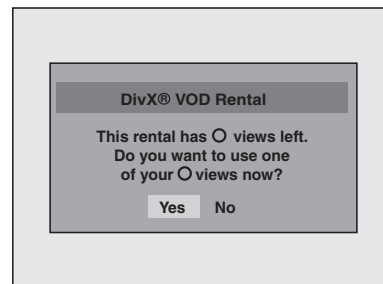

- You cannot play back the DivX® VOD files of which rental period has been expired. In such case, press [TOP MENU] and select other files that can be played back.

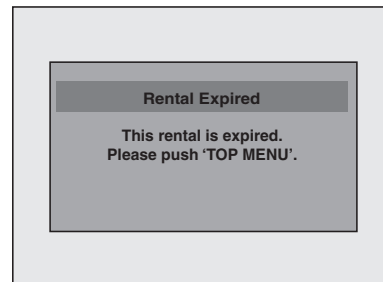

#### Hint

- DivX® is a codec (compression/decompression) that can compress images to a very small amount of data. The software can compress video data from almost any sources to the size that can be sent on the Internet without compromising visual quality of the images.
- A file with an extension of ".avi" and ".divx" is called an DivX® file. All files with the ".avi" extension are recognised as MPEG4.
- Files whose extension other than ".avi" and ".divx" will not be listed on the DivX® menu. However, unplayable groups or tracks may be displayed, depending on the recording conditions.
- Even if the file has an extension of either ".avi" and ".divx", this unit cannot play it back if it is recorded in the format other than DivX®.
- Folders are known as Groups; files are known as tracks.
- A symbol of [ ] is shown on the top of the file name.
- A maximum of 255 folders or 999 files may be recognised in one disc.

- Up to 8 hierarchies can be recognised in one folder. Files in the 9th or deeper hierarchies cannot be played back.
- If the track extends beyond the scope of screen, a down arrow “↓” appears, indicating that the user can view another part on the previous page. The current page number and the number of total pages are shown on the right of the down arrow “↓”.
- Letters of a file / folder name overflowing the given space will be displayed as “...”.
- You can play back the disc recorded in multi-session.
- It may take awhile for audio and images to be output after you inserted a disc and pressed [PLAY ▶].
- When playing back the files recorded in high bit rates, the images can be interrupted in some occasions.
- Although DivX® logo has been obtained for this unit, it may not be able to play back some data, depending on the characteristics, bit rates, or audio format settings, etc.
- Use the software recognised by the DivX, Inc. when you make DivX® files.
- A DivX® file whose file size exceeds 2 GB cannot be played back.
- If you try to play back the DivX® file that has the screen resolution which this unit does not support, the playback will be stopped and error message will appear.
- If a large-sized DivX® file is selected, it may take awhile to start the playback (over 20 seconds sometimes).
- If DivX® files written on CD discs cannot be played back, rewrite them on a DVD disc and try to play back.
- For more information for DivX®, please visit <http://www.divx.com>.
- If you insert a CD-RW/-R with DivX® files that are mixed with MP3 and JPEG files, the Playback Media Selection screen will be displayed. Please select “Video” and proceed to next step.

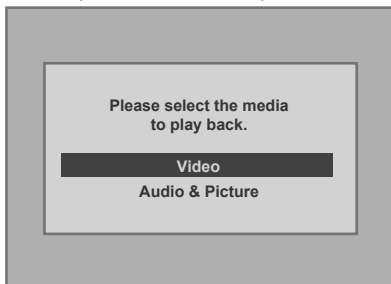

- Press [DISC MENU] to call up the Playback Media Selection screen in stop mode.
- If you select “Audio & Picture” instead of “Video” on the Playback Media Selection screen, this unit can play back MP3/JPEG files.
- You cannot play back the DivX® VOD files obtained with different registration codes this unit. Press [TOP MENU] and select other files that can be played back.
- This unit does not support the DivX® file with UDF format.



## DivX® VOD



This unit allows you to play back the files purchased or rented from DivX® Video-On-Demand (VOD) services. The files are available on the internet. When you purchase or rent DivX® VOD files on the internet, you will be asked to enter a registration code. This menu item provides you with the registration code.

- 1 Press [SETUP].
- 2 Select “General Setting” using [▲ / ▼], then press [ENTER].
- 3 Select “DivX” using [▲ / ▼], then press [ENTER].
- 4 Select “DivX®VOD” using [▲ / ▼], then press [ENTER].

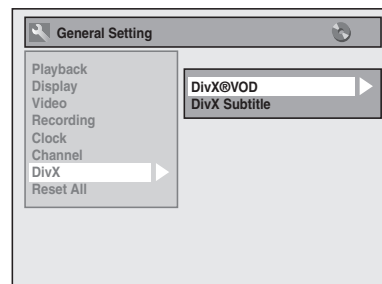

Your registration code will appear.

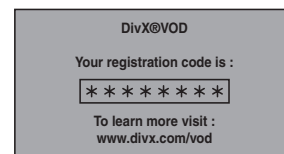

### Note

- One registration code is only valid for one DivX® VOD file.
- You must first download the file from the internet and play it back on this unit before you are able to get another code.
- You must follow this step every time you purchase or rent a DivX® VOD file from the internet.
- For more information for DivX®, please visit <http://www.divx.com/vod>.

Introduction

Connections

Basic Setup

Recording

Playback

Editing

Function Setup

VCR Functions

Others

## Playing Back Discs Using the Disc Menu



A DVD contains a disc menu, which lists the contents and enables you to customise playback. The menu may offer choices for subtitle languages, special features, and chapter selection. Usually this information appears automatically when you start playback, but sometimes you need to press **[DISC MENU]** to display the menu.

Press **[DVD]** first.

### 1 Press **[DISC MENU]**.

If the feature is not available,  may appear on the TV screen.

### 2 Select an item using **[▲ / ▼ / ◀ / ▶]**, then press **[ENTER]**.

Repeat this step until all the features you want are set up or to start playing back the disc from the menu. The following operations are available.

**[DISC MENU] button:**

Displays the disc menu, which will vary among discs.

**[▲ / ▼ / ◀ / ▶] buttons:**

Move the cursor from item to item on the screen.

**[ENTER] button:**

Selects the currently highlighted menu option.

**[the Number buttons]:**

Selects a numbered menu option (available on certain discs).

### 3 Press **[DISC MENU]** to exit the disc menu.

#### Note

- Menus vary among discs. Refer to the information accompanying the disc for details.

## Playing Back a Disc Using the Title Menu



Some DVDs have a Title menu, which lists the titles available on the DVD. You can start playing back such discs at a specific title.

On this unit, if you finalise Video mode or +VR mode discs, a Title menu will be created automatically.

Press **[DVD]** first.

### 1 Press **[TOP MENU]**.

The Title menu will appear.

- For some discs, the Title menu appears automatically.

If the feature is not available,  may appear on the TV screen.

### 2 Select a desired item using **[▲ / ▼ / ◀ / ▶]**, then press **[ENTER]**.

The disc will start playing back at the title you selected. The following operations are available.

**[TOP MENU] button:**

Displays the DVD "Title Menu" which will vary between discs.

**[▲ / ▼ / ◀ / ▶] buttons:**

Move the cursor from item to item on the screen.

**[ENTER] button:**

Selects the currently highlighted menu option.

**[the Number buttons]:**

Selects a numbered menu option (available on certain discs).

### 3 Press **[TOP MENU]** to exit.

#### Note

- **[TOP MENU]** will not be available for some DVDs.
- Menus vary among discs. Refer to the information accompanying the disc for details.
- For DVD+RW discs finalised on this unit, press **[DISC MENU]** to display the Title menu.

## PBC Function for Video CDs



This unit conforms to ver.1.1 and ver.2.0 of the Video CD standard playback control (PBC) function. This enables you to play back interactive software using menu screens. Refer to the information accompanying the Video CD.

Ver.1.1 (without PBC function): You can still enjoy playback of pictures and music from the CD.

Ver.2.0 (with PBC function): "Pbc" will appear on the screen and display when playing back a Video CD with the PBC function.

### Hint

- When playing back Video CDs with the PBC function, "Pbc" is displayed instead of the playing back time and current track indications on the front panel display.

### Note

- Some operations cannot be performed unless the function is cancelled either automatically or intentionally by you.
- Operations that are not available when the PBC function is set to "ON" are indicated by the following symbol in this manual:



## Playing Back a Video CD Using the Title Menu



- 1 When playing back a Video CD with the PBC function, the Title menu will appear automatically.**
- 2 Press [the Number buttons] to select the desired title.**  
Playback will start at the selected title.
- 3 Press [RETURN] to go back to the Title menu.**

### Note

- While the On-Screen Display appears, you cannot perform steps 2 and 3.

## Cancelling and Recalling the PBC Function



### Insert a Video CD.

- 1 In stop mode, press [SETUP].**
- 2 Select "CD Playback Mode" using [▲ / ▼], then press [ENTER].**
- 3 Select "PBC (Video CD only)" using [▲ / ▼], then press [ENTER].**

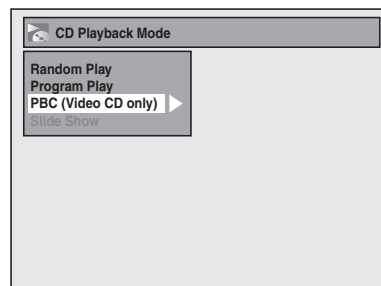

- 4 Select "OFF" using [▲ / ▼], then press [ENTER].**

- 5 Press [SETUP] to exit.**

To recall the PBC function, select "ON" at step 4 above.

### Note

- The default setting of "PBC (Video CD only)" is "ON".

Introduction

Connections

Basic Setup

Recording

Playback

Editing

Function Setup

VCR Functions

Others

## Special Playback

### Resume Playback

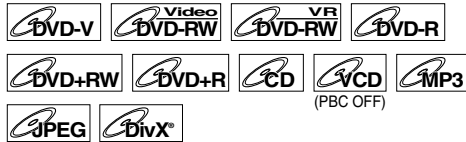

You can resume playback from the point where you stopped it before.

#### 1 During playback, press [STOP ■].

The resume message will appear.

#### 2 Press [PLAY ►].

In a few seconds, playback will resume from the point at which you stopped it before. Even if you turn off the unit, you can resume playback at the same point after turning back on the unit.

#### To cancel the resume playback and start playing back the disc from the beginning:

Press [STOP ■] while playback is stopped.

#### Note

- For Video CDs, if you turn PBC on using the Setup menu, the resume function is cancelled.
- For MP3 and JPEG files, playback will resume from the beginning of the track at which playback was stopped.

### Fast Forward / Fast Reverse



#### 1 During playback, press [FWD ►►] or [REV ◀◀].

Each time you press [FWD ►►] or [REV ◀◀], the approximate speed will change as follows.

Fast forward or fast reverse playback across titles (for DVDs) or tracks / files (for VCD / MP3 / DivX®) is not possible.

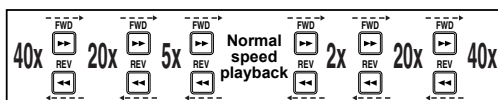

- For Audio CDs and MP3 files approximate speed is fixed at 8x with sound.
- For Video CDs, approximate forward / reverse speeds are 2x, 8x and 16x.
- For DivX® files, approximate forward speeds are 2x, 20x and 40x, and approximate reverse speeds are 5x, 20x and 40x.
- To return to playback at normal speed, press [PLAY ►].
- Picture quality of DivX® files in fast reverse is lower than that in fast forward.
- For some DivX® files, Fast forward/Fast reverse may not function.

#### Hint

- Forward / reverse speeds are indicated with icons as follows.

Forward (Approx. Speed):

2x: ►►

20x: ►►►

40x: ►►►►

Reverse (Approx. Speed):

5x: ◀◀

20x: ◀◀◀

40x: ◀◀◀◀

### Skipping TV Commercials during Playback



To enjoy recorded programmes without any interruptions, press [INSTANT SKIP].

#### 1 During playback, press [INSTANT SKIP].

Normal playback will start 30-second advanced point from the point at which you press [INSTANT SKIP].

Each time you press [INSTANT SKIP], the start point will move another 30 seconds forward and playback resume automatically.

You can press [INSTANT SKIP] up to 6 times (180 seconds).

### Pause



#### 1 During playback, press [PAUSE III].

Playback will pause with the sound muted.

#### 2 Press [PLAY ►] to resume playback.

### Rapid Playback



#### Rapid Play function is available only during playback.

Available only on discs recorded in the Dolby Digital format, Rapid Play plays back in a slightly faster/slower speed while keeping the sound quality just as normal playback.



## 1 During playback, press [1.3x/0.8x PLAY].

- ▶x0.8: Press [1.3x/0.8x PLAY] once during playback.  
Plays back approximately at 0.8 times of normal playback.
- ▶x1.3: Press [1.3x/0.8x PLAY] twice during playback.  
Plays back approximately at 1.3 times of normal playback.
- ▶ : Press [1.3x/0.8x PLAY] thrice to play back in normal speed.  
No effects.

## 2 Press [PLAY ►] to continue the normal playback.

### Note

- Audio (language) setting cannot be changed while using this mode.
- This feature may not work at some point in a disc.
- Audio is PCM during Rapid play mode.
- When you select "PAL" in "TV System" (see page 68), this function is not available with discs recorded using the NTSC system.

## Step by Step Playback



## 1 During playback, press [PAUSE III].

## 2 Press [SKIP ◀◀ / ▶▶] repeatedly.

Each time you press [SKIP ▶▶], playback will go forward one frame (or step) at a time with the sound muted.

To go backward one frame (or step), press [SKIP ◀◀].

Press and hold [SKIP ▶▶] to continue going forward.

To continue going backward, press and hold [SKIP ◀◀].

## 3 Press [PLAY ►] to resume playback.

### Note

- Only step by step forward is available when playing back Video CDs and discs with DivX® files.

## Slow Forward / Slow Reverse Playback



## 1 During playback, press [PAUSE III], then press [FWD ►►] or [REV ◀◀].

Each time you press [FWD ►►] or [REV ◀◀], the approximate speed change as follows.  
(The sound will remain muted.)

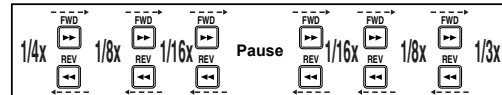

To return to normal playback, press [PLAY ►].

### Hint

- Forward / reverse speeds are indicated with icons as follows.  
Forward (Approx. Speed):  
1 / 16x: ►►►►►  
1 / 8x: ►►►►►  
1 / 3x: ►►►►►  
Reverse (Approx. Speed):  
1 / 16x: ◀◀◀◀◀  
1 / 8x: ◀◀◀◀◀  
1 / 4x: ◀◀◀◀◀

### Note

- For some DivX® files, **Slow forward may not** function.
- Only slow forward is available when playing back Video CDs and discs with DivX® files.

## Zoom



## 1 During playback, press [ZOOM].

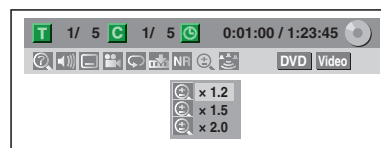

Four options are available, "x1.0", "x1.2", "x1.5" and "x2.0". These are displayed excluding the current zoom rate.

### Hint

- You can also select the zoom function by pressing [DISPLAY]. In this case, press [DISPLAY] first, select the [Z] icon using [◀ / ▶], and then press [ENTER] within 1 second, or wait for 1 second to display the selection menu.

## 2 Select the desired zoom factor to zoom using [▲ / ▼], then press [ENTER].

The zoom area is displayed.

### 3 Select the desired zoom position using [ $\blacktriangle$ / $\blacktriangledown$ / $\blacktriangleleft$ / $\blacktriangleright$ ], then press [ENTER].

Zoom playback will start.

#### Hint

- To exit the zoom menu, press [ZOOM] at step 1.
- To cancel the zoom function, select "x1.0" using [ $\blacktriangle$  /  $\blacktriangledown$ ], then press [ENTER].

#### Note

- If selecting a smaller factor than that currently selected, the zoom area is not displayed.
- You cannot slide the zoomed picture on some JPEG files.

## Marker Setup



You can assign a specific point on a disc to return later.

- 1 During playback, press [DISPLAY].
- 2 Select the  icon using [ $\blacktriangleleft$  /  $\blacktriangleright$ ], then press [ENTER] within 1 second, or wait for 1 second to display the marker list.

Marker setup menu for DVD-Video

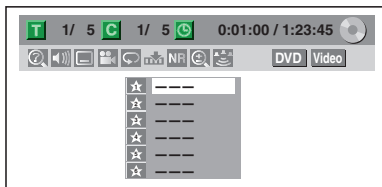

- 3 Select the desired marker number using [ $\blacktriangle$  /  $\blacktriangledown$ ]. When the disc reaches the desired point, press [ENTER].

The title (track) number and the time are displayed.

- 4 To return to the marker, select the desired marker number using [ $\blacktriangle$  /  $\blacktriangledown$ ], then press [ENTER].

#### Hint

- To clear a marker, select the marker number you wish to clear, then press [CLEAR].
- You can mark up to 6 points.

#### Note

- All markers are erased when you perform the following operations.
  - Open the disc tray.
  - Turn off the power.
  - Record on a recordable disc.
  - Change the mode between Original and Playlist. (VR mode)

## Chasing Playback during Recording



You can play back the already recorded part of the currently recording programme without waiting for the recording to the end. This function works from 1 minute after the start of the recording. Make sure to use a DVD-RW disc in VR mode, and the recording mode is set to LP, EP or SLP.

- 1 Press [PLAY  $\blacktriangleright$ ] during recording.

Playback will start from the beginning of the programme that you are currently recording. Screen for the current playback:

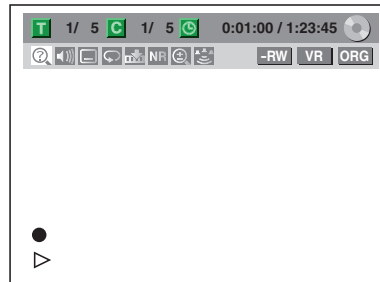

If you play the fast forward playback and the playback reaches the scene recorded 1 minute before, the forwarding playback will automatically return to the normal playback.

- 2 To stop the playback, press [STOP  $\blacksquare$ ] once.

The resume message will appear. Screen for the current recording:

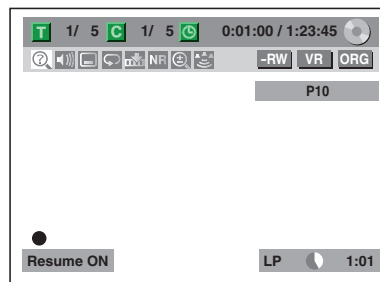

To stop recording, press [STOP  $\blacksquare$ ] again. To cancel the resume, press [STOP  $\blacksquare$ ] again.

## Using the [TIME SLIP] button

With [TIME SLIP] button, even if you leave your couch while you are watching TV through this unit, you can come back and watch rest of the programme from right where you left at any convenient time with just one button. Please make sure to put VR mode DVD-RW disc, and set the recording mode to LP, EP or SLP.

### 1 While viewing a TV broadcast via this unit, press [TIME SLIP].

This unit start to record the TV broadcast.

### 2 Press [TIME SLIP] again.

Playback will start from the point you press [TIME SLIP] first while recording continues.

- While viewing the recorded content, you can pause and resume the playback by pressing [TIME SLIP].

### 3 To stop the recording, press [STOP ■] twice.

#### Note

- Playback image may freeze momentarily using this function. However this does not affect the recording.
- The 2x fast forward playback is not available.
- [REC ●] is not available during this function.
- You must cancel this function first by pressing [STOP ■] once. Then you can use [REC ●] to use OTR (one-touch timer recording) function or change recording time for the OTR.
- "Wait for a moment." will be displayed on the screen if you press [PLAY ►] before 1 minute of recording.
- **This function is available only when you are recording on a DVD-RW disc in VR mode, with the recording mode LP, EP or SLP.**
- Use DVD-RW disc capable of 2x or 4x speed recording.

## Simultaneous Playback and Recording



You can also play back a recorded title during current recording or the Timer Recording on the same disc.

### 1 Press [DISPLAY] during recording.

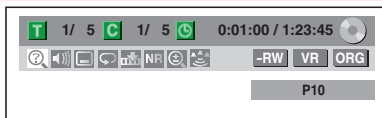

### 2 Select [Q] icon using [◀/▶], then press [ENTER].

The title number next to **T** will be highlighted.

Title:

Enter a desired title number to search using [▲ / ▼] or [the Number buttons], then press [ENTER].

Selected title playback will start.

#### Chapter:

To move to **C** for chapter, press [▶].  
Enter a desired chapter number to search using [▲ / ▼] or [the Number buttons], then press [ENTER].

Selected chapter playback will start.

If you play the currently recording programme and the playback reaches the scene recorded 1 minute before, the forwarding playback will automatically return to the normal playback.

### 3 Press [STOP ■] once to stop playback.

The resume message will appear.

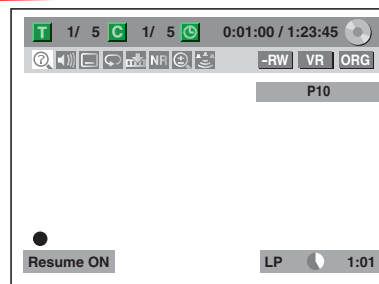

To stop recording, press [STOP ■] again.  
To cancel the resume, press [STOP ■] again.

#### Note

- Playback image may freeze momentarily using this function. However this does not affect the recording.
- The 2x fast forward playback is not available.
- **This function is available only when you are recording on a DVD-RW disc in VR mode, with the recording mode LP, EP or SLP.**
- Only the titles (chapters) in the Original can be selected. You cannot select titles from the title list.
- When you stop the playback after the Timer recording is completed, the unit will be switched to the timer standby mode if another programme has been set (refer to "Hints for the Timer Recording" on page 35).
- Use DVD-RW disc capable of 2x or 4x speed recording.

Introduction

Connections

Basic Setup

Recording

Playback

Editing

Function Setup

VCR Functions

Others

## Search

### Title / Chapter Search



#### Using [SKIP ◀◀ / ▶▶] buttons

- 1 During playback, press [SKIP ▶▶] to skip the current title or chapter and move to the next.

The unit moves to the next title or chapter one after the other.

To go back to the previous title or chapter, press [SKIP ◀◀] twice in quick successions.

#### Using the [DISPLAY] button

- 1 During playback, press [DISPLAY].
- 2 Select the icon using [◀ / ▶], then press [ENTER].  
The title number is highlighted.

#### Searching for a Title:

- 3 Enter the desired title number to search for using [▲ / ▼] or [the Number buttons], then press [ENTER].

Title search will start.

#### Hint

- Total number of chapters and playback time of the selected title are also displayed.

#### Searching for a Chapter:

- 3 Press [◀ / ▶] to highlight the number displayed in the right side of the icon.
- 4 Enter the desired chapter number to search for using [▲ / ▼] or [the Number buttons], then press [ENTER].

Chapter search will start.

#### Hint

- The title number and playback time of the selected chapter are also displayed.

## Track Search



### Using [SKIP ◀◀ / ▶▶] buttons

- 1 During playback, press [SKIP ▶▶] to skip the current track and move to the next.

The unit moves to the next track one after the other.

To go back to the previous track, press [SKIP ◀◀] twice in quick successions. The unit moves backward one track at a time.

### Using the [DISPLAY] button

For audio CD, skip to step 2.

- 1 During playback, press [DISPLAY].
- 2 Select the icon using [◀ / ▶], then press [ENTER].  
The track number is highlighted.
- 3 Enter the desired track number to search for using [▲ / ▼] or [the Number buttons], then press [ENTER].

Track search will start.

#### Hint

- For Video CDs, you can perform the track search function in stop mode without turning PBC off manually.

#### Note

- During Random playback or Programme playback, you cannot search the desired track.

## Direct Search



You can search the desired track directly.

### Using [the Number buttons]

- 1 During playback, if the display menu is not displayed, press [the Number buttons] to enter the desired track number.



#### Note

- During Random playback or Programme playback, you cannot search the desired track directly.

## Time Search



For audio CD, skip to step 2.

- 1** During playback, press [DISPLAY].
- 2** Select the  icon using [◀ / ▶], then press [ENTER].  
 for the title or track number is highlighted.
- 3** Press [◀ / ▶] to highlight .
- 4** Enter the desired time to search for using [▲ / ▼] or [the Number buttons], then press [ENTER].

Time search will start.

### Note

- During Random playback or Programme playback, you cannot search the desired time.
- The title number and chapter number of the setting time are also displayed.
- Time search function is available only in the same track or title.

## Repeat / Random / Programme Playback / Slide Show

### Repeat Playback



For audio CD or MP3, skip to step 2 or press [REPEAT] and skip to step 3.

- 1** During playback, press [DISPLAY].  
Or press [REPEAT] during playback, and follow from step 3.
- 2** Select the  icon using [◀ / ▶], then press [ENTER] within 1 second, or wait for 1 second to display the selection menu.
- 3** Select the desired option to repeat using [▲ / ▼], then press [ENTER].

The selected repeat playback will start.  
The following operations are available.

#### Title:

The current title will be played back repeatedly. (DVD only)

#### Chapter:

The current chapter will be played back repeatedly. (DVD only)

#### All:

The current disc will be played back repeatedly. (DVD-RW (VR mode), Audio CD, Video CD, MP3, JPEG and DivX® only)

#### A-B:

The A-B point will be played back repeatedly. (DVD, Audio CD, Video CD and DivX® only)  
When pressing [ENTER] while A-B is highlighted, A-B repeat is set.

- Press [ENTER] again to decide the starting point (A).
- Press [ENTER] after setting point (A) to select the ending point (B).

#### Track:

The current track will be played back repeatedly. (Audio CD, Video CD, MP3, JPEG and DivX® only)

#### Group:

The current group will be played back repeatedly. (MP3, JPEG (except Picture CD) and DivX® only)

### Hint

- To cancel the repeat playback, select "OFF" at step 3. The repeat setting is also cancelled when you stop playback.
- You can also select the repeat playback by pressing [REPEAT].

### Note

- You can only set A-B repeat playback within the current title (for DVDs) or current track (for Audio CDs, Video CDs and discs with DivX® files).
- You cannot select "Group" during the random playback of MP3 and JPEG files.

- Chapter / Track repeat function is cancelled whenever [SKIP ◀◀ / ▶▶] is pressed.
- For some DivX® files, A-B Repeat playback may not function.
- For Video CDs with PBC function, repeat play does not work while the PBC function is on.

## Random Playback



You can use this function to play back a disc randomly instead of in the recorded order.

Press [DVD] first.

**1** In stop mode, press [SETUP].

**2** Select “CD Playback Mode” using [▲ / ▼], then press [ENTER].

CD Playback Mode menu will appear.

**3** Select “Random Play” using [▲ / ▼], then press [ENTER].

Random playback will start.

### Hint

- To cancel random playback, press [STOP ■] twice during random playback. “OFF” appears on the screen.
- For Video CDs with PBC function, the PBC setting will be switched to off automatically when you start random playback.

### Note

- During random playback, if you forward the track to the end, the playback speed of the next track will be normal.
- During random playback, you cannot use the search function except for the search with [SKIP ◀◀ / ▶▶]. By pressing [SKIP ◀◀], you can return only to the beginning of the current track.

## Programme Playback



You can programme the disc to play back in your desired order.

**1** Follow steps 1 and 2 in “Random Playback”.

**2** Select “Program Play” using [▲ / ▼], then press [ENTER].

**3** Select the desired track using [▲ / ▼], then press [ENTER] or [▶].

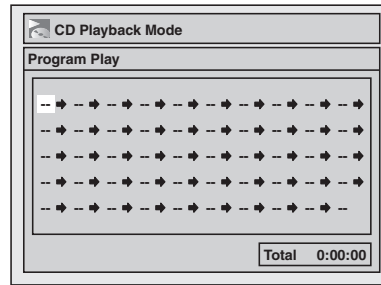

**4** Press [PLAY ▶] to start programme playback.

### Hint

- To erase tracks you selected, press [CLEAR].
- You can make up to 50 track settings.
- To cancel programme playback, press [STOP ■] twice during programme playback. “OFF” appears on the screen.
- You may also select the desired track using [the Number buttons] at step 3.
- For Video CDs with PBC function, the PBC setting will be switched to off automatically when you start programme playback.

### Note

- During programme playback, if you forward the track to the end, the playback speed of the next track will be normal.
- During programme playback, you cannot use the search function except for the search with [SKIP ◀◀ / ▶▶].

## Slide Show



You can select the display time between 5 seconds and 10 seconds.

**1** Follow steps 1 and 2 in “Random Playback”.

**2** Select “Slide Show” using [▲ / ▼], then press [ENTER].

**3** Select the display time using [▲ / ▼], then press [ENTER].

**4** Press [SETUP] to exit.

### Note

- Large-size JPEG files take a few moments to be displayed.

## Selecting the Format of Audio and Video

You can select the format of audio and video to suit the content of the disc you are playing back.

### Switching subtitles



Many DVD-Videos have subtitles in one or more languages. The available languages are usually printed on the disc case. You can switch subtitle languages at any time during playback.

- 1 During playback, press [DISPLAY].
- 2 Select the  icon using [◀/▶], then press [ENTER] within 1 second, or wait for 1 second to display the selection menu.
- 3 Select the desired subtitle language using [▲/▼], then press [ENTER].

Subtitles are displayed in the selected language. If you select "OFF", subtitles will disappear.

#### Note

- With some discs it is only possible to change the subtitle language from the disc menu. Press [TOP MENU] or [DISC MENU] to display the disc menu.
- If a 4-digit language code appears in the subtitle menu at step 3, refer to the "Language Code" on page 79.
- For discs with DivX® files, the screen only displays the number of subtitle languages.

### Switching Audio Soundtrack



When playing back a DVD-Videos recorded with two or more soundtracks (often in different languages), you can switch among them during playback. When playing back DVD-RW discs recorded in VR mode, you can switch to main audio (L), sub audio (R) or a combination of both (L / R). When playing back Audio CDs or Video CDs, you can switch among the left, the right channel and stereo. For audio CD, skip to step 2 or press [AUDIO] and skip to step 3.

- 1 During playback, press [DISPLAY].  
Or press [AUDIO] during playback and follow from step 3.
- 2 Select the  icon using [◀/▶], then press [ENTER] within 1 second, or wait for 1 second to display the selection menu.

- 3 Select a desired audio soundtrack or audio channel using [▲/▼], then press [ENTER].

With a DVD Video, VR mode DVD-RW, or DivX® files:

Audio soundtrack will switch.

Example:  
English → Spanish → French

If the title contains both main and sub audio, you can further select "L" (main), "R" (sub), "L/R" (mixed of main and sub).

With an Audio CD or Video CD:

The Audio channel will switch.

Example:  
L/R → L → R

#### Note

- For some discs, it is only possible to change the soundtrack from the disc menu. Press [TOP MENU] or [DISC MENU] to display the disc menu.

### Switching Virtual Surround System



You can enjoy stereophonic virtual space through your existing 2 channel stereo system.

For audio CD or MP3, skip to step 2.

- 1 During playback, press [DISPLAY].  
Display menu will appear.
- 2 Select the  icon using [◀/▶], then press [ENTER] within 1 second, or wait for 1 second to display the selection menu.

Virtual Surround menu will appear.

e.g.) DVD-Video

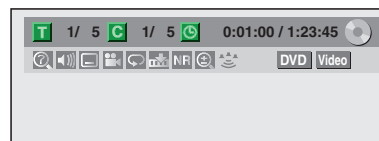

- 3 Select "OFF", "Type 1" or "Type 2" using [▲/▼], then press [ENTER].

e.g.) DVD-Video

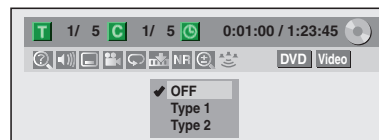

- OFF: No effect
- Type 1: Natural effect
- Type 2: Emphasised effect

**Note**

- Select Virtual Surround to “OFF” in a case the sound is distorted.
- The setting will be kept “OFF” when the unit is turned off.

---

## Switching Camera Angles



Some DVD-Videos feature scenes shot from two or more angles. The disc case is usually marked with an angle icon if the disc has multi-angle scenes.



### 1 During playback, press [DISPLAY].

The angle icon appears when a switching camera angle is available. (Available only when the angle icon appears in bottom right on the TV screen.)

### 2 Select the icon using [◀ / ▶], then press [ENTER].

The angle will switch each time you press [ENTER].

**Hint**

- If the Angle Icon setting is “OFF” in the Setup menu, the  icon will appear only when the disc is played back and the Display menu appears. (See page 68.)
- Even when the  icon is not displayed, you can select the angle if the currently played back title has at least two multi-angle scenes.

---

## Reducing Block Noise



### 1 During playback, press [DISPLAY].

### 2 Select the icon using [◀ / ▶], then press [ENTER] within 1 second, or wait for 1 second to display the selection menu.

Noise Reduction menu will appear.

### 3 Select the desired option using [▲ / ▼], then press [ENTER].

This function reduces noise in the playback picture. When playing back discs recorded in long time modes such as EP or SLP, select “Type 1” or “Type 2”. “Type 2” is more effective. When playing back discs with a little noise, such as DVD-Videos, select “OFF”.



# Editing

## Disc Editing

You can edit a disc recorded using the PAL system. It is not possible to edit discs recorded using the NTSC system.

### Guide to a Title List

Title list allows you to check the titles recorded on the disc easily. You can choose a title to play back from this list and easily edit the titles as you prefer.

Press [TOP MENU].

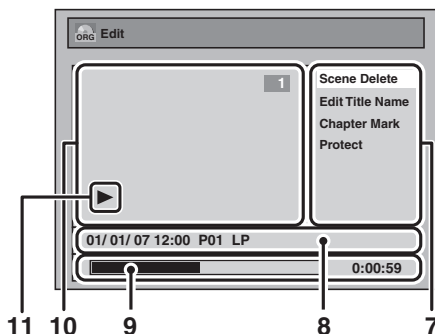
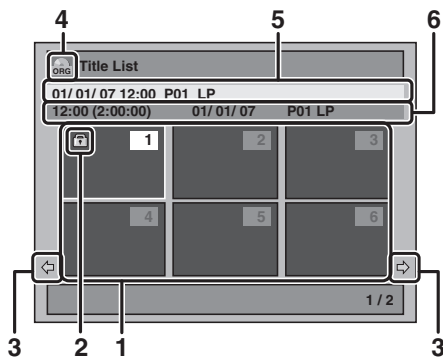

- 1 **Title list:** List of the titles recorded on the disc and their information.  
For DVD+RW/+R, empty title always appears at the last of the title list.
- 2 The protect icon, which appears when the title has been protected. (Original titles only)
- 3 **Arrow:** Indicating there is a previous / next page.
- 4 Title list icon, which indicates a type of the displayed title list.  
  - ORG : VR (original) mode
  - PL : VR (Playlist) mode
  - +VR : +VR mode
  - Video : Video mode
- 5 Title name.
- 6 Title information, which displays recorded time, length of the title, date / month / year, recorded CH, and the recording mode.
- 7 **Submenu:** Submenus for the selected menu are displayed here.

- 8 **Title name** (editable): If you do not name the title, the recorded date, time, channel, and the recording mode are displayed here.
- 9 **Progress bar:** Indicating the progress of the playback.
- 10 **Preview window:** Preview of the selected title is displayed here.
- 11 **Playback status:** Indicating the current playback status of the selected title.

Press [RETURN] to exit the title list.

## Editing Discs

You will find editing discs is easy. This unit offers convenient edit functions which are possible only with DVD-RW/-R and DVD+RW/+R discs.

You can edit the following from a title list.

- Assigning a name to a title
- Dividing a title
- Combining titles
- Adding titles to a Playlist
- Erasing all Playlist
- Setting or releasing the title protection
- Adding or deleting chapter marks
- Deleting titles or parts of titles

(Possible editing functions depend on the recording format and editing method.)

### Original and Playlist (VR mode)

For VR mode DVD-RW disc, you can edit the recordings in Playlist without changing the original recordings. Playlist does not take up much disc space.

### What "Original" or "Playlist" is for?

Throughout this manual, you will find Original and Playlist which refer to the actual content and the edited version.

- **Original** content refers to what's actually recorded on the VR mode DVD-RW disc.
- **Playlist** content refers to the edited version of the VR mode DVD-RW disc; how the Original content is to be played.

### Finalising a Disc

- This will allow a disc that is recorded on this unit to be played back on a different DVD player — without finalisation it will not be playable on another player.
- After finalising a DVD-RW/-R or DVD+R disc, you cannot edit any information that is on that disc.
- If you have recorded in DVD+RW disc, then editing is still permitted after finalising.

**Using these editing functions to modify copyrighted content for any purpose other than your private viewing may be prohibited under the Copyright Laws of the United States and other countries, and may subject you to civil and criminal liability.**

### Note

- A Playlist is not available for DVD-R or Video mode DVD-RW and DVD+RW/+R discs.
- It is not possible to edit a disc recorded in another video system other than PAL, such as NTSC.

## Deleting Titles



You can delete titles you do not want to keep. When an Original is deleted from VR mode DVD-RW disc, the recordable disc space will increase. Even when a Playlist is deleted, the original of the Playlist will remain, and recordable disc space will not increase.

Recordable disc space of Video mode DVD-RW and DVD+RW disc will increase when the last title on the title list is deleted. However, deleting the title will not change recordable disc space for DVD-R and DVD+R disc.

In finalised DVD-R, Video mode DVD-RW or DVD+R discs, you cannot select the title list because it cannot be edited once finalised.

### Note

- It is not possible to retrieve deleted titles.

### Press [DVD] first.

#### 1 In stop mode, press [TOP MENU].

Title list will appear.  
For DVD-RW, press [DISC MENU] to switch between "Original" and "Playlist" if the disc is recorded in VR mode.

#### 2 Press [ENTER] at the desired title with [▲ / ▼ / ◀ / ▶].

e.g.) VR mode DVD-RW disc

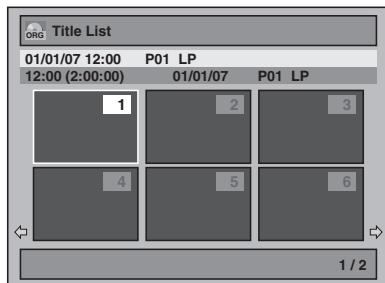

Pop up window will appear.

#### 3 Select "Title Delete" using [▲ / ▼], then press [ENTER].

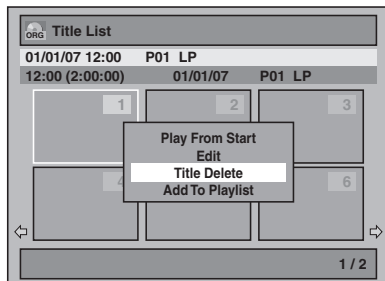

#### 4 Select "Yes" using [▲ / ▼], then press [ENTER].

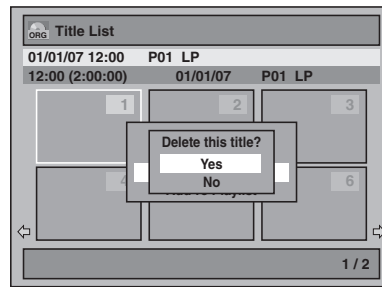

"Are you sure?" will appear. Select "Yes" using [▲ / ▼], and then press [ENTER].

Title is deleted.

#### 5 Press [RETURN] or [STOP ■] to exit.

Writing on the disc starts.

It may take awhile to write the data on a disc.

### Note

- If you delete the title in DVD+RW disc, deleted title will be displayed as "Empty".
- You cannot overwrite on the "Empty".

## Editing Title Name



You can edit the title names from this menu. The title names you edit will appear on the title list.

### Press [DVD] first.

#### 1 In stop mode, press [TOP MENU].

Title list will appear.  
For DVD-RW, press [DISC MENU] to switch between "Original" and "Playlist" if the disc is recorded in VR mode.

#### 2 Press [ENTER] at the desired title with [▲ / ▼ / ◀ / ▶].

e.g.) VR mode DVD-RW disc

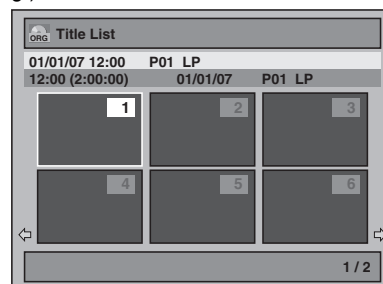

Pop up window will appear.

#### 3 Select "Edit" with [▲ / ▼], then press [ENTER].

Edit menu will appear.

#### 4 Select "Edit Title Name" using [▲ / ▼], then press [ENTER].

A window for entering the title name will appear.

**5 To enter the title name, refer to “Guide to Editing Title Names” on this page.**

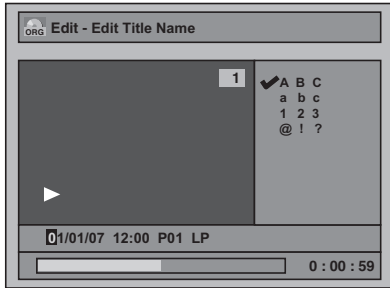

When you finish entering the title name, press [ENTER].

**6 Select “Yes” using [▲ / ▼], then press [ENTER].**

The name you edited becomes the title.

**7 Press [RETURN] and then [RETURN] or [STOP ■] to exit.**

Writing on the disc starts. It may take awhile to write the data on a disc.

**Guide to Editing Title Names**

**Step 1:** Select the desired character set using [▲ / ▼], then press [ENTER].

**Step 2:** Using the list below as a guide, press [the Number buttons] repeatedly until the desired letter appears.

Select Press	ABC	abc	123	@ ! ?
0	<space>	<space>	0	<space>
1	-	-	1	! " # \$ % & ' ( ) * + , - . / : ; < = > ? @ [ ] ^ _ { }
2	ABC	abc	2	-
3	DEF	def	3	-
4	GHI	ghi	4	-
5	JKL	jkl	5	-
6	MNO	mno	6	-
7	PQRS	pqrs	7	-
8	TUV	tuv	8	-
9	WXYZ	wxyz	9	-

• Characters set will be changed to the “@!?” automatically if you press [1] after you selected the “ABC” or “abc” mode.

**Note**

- To delete letters, press [CLEAR] repeatedly. Press and hold [CLEAR] to delete all letters.
- Press [◀ / ▶] to move the cursor to the left or right.
- You can enter up to 30 letters.
- Unrecognisable characters will be replaced with asterisks (\*). If you delete them, adjoining characters may change to asterisks (\*) or other.

**Setting or Clearing Chapter Markers**



You can add chapter markers to a title. After a title is marked with chapters, you can use the chapter search feature.

You can set a chapter marker anywhere you want. You cannot set more than 999 chapter markers in the Playlist.

**Press [DVD] first.**

- 1 Follow the steps 1 to 3 in “Editing Title Name” on page 58.**
- 2 Select “Chapter Mark” using [▲ / ▼], then press [ENTER].**
- 3 Use [SKIP ◀◀ / ▶▶], [REV ◀◀], [FWD ▶▶], [PLAY ▶] and [PAUSE II] to find the point where you will create a new chapter marker. Or, use [SKIP ◀◀ / ▶▶] to find a chapter marker that you wish to delete.**
- 4 Select “Add” or “Delete” accordingly using [▲ / ▼], then press [ENTER].**

e.g.) VR mode DVD-RW disc Original

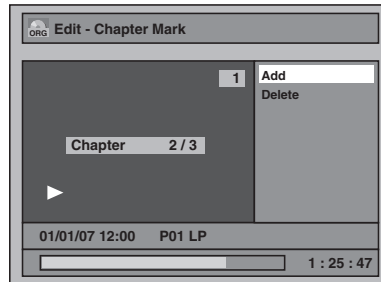

You cannot delete the first chapter of a title.

**5 Select “Yes” using [▲ / ▼], then press [ENTER].**

e.g.) VR mode DVD-RW disc Original

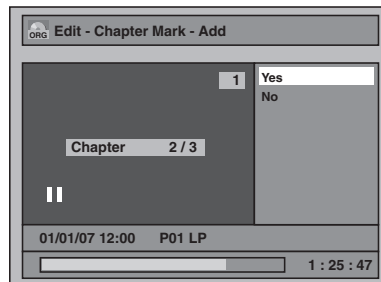

A chapter marker is added.

**Adding a chapter marker:**

If you select “Add” at step 4, a new chapter marker is created at the point you specified.

**Deleting a chapter marker:**

If you select “Delete” at step 4, the chapter marker you selected is deleted.

**6** Press [RETURN].**7** Press [RETURN] again and then [RETURN] or [STOP ■] to exit.

Writing on the disc starts.  
It may take awhile to write the data on a disc.

**Note**

- Maximum numbers of chapter for each DVD:  
VR mode DVD : 999 chapters per entire original and playlist  
+VR mode DVD : 254 chapters per disc, 99 chapters per title
- Besides the above-mentioned, it is not likely to be able to add according to recorded time and number of chapters.

## Setting or Clearing Chapter Markers for Video Mode DVD-RW Disc



For titles in Video mode DVD-RW disc, you set or edit chapter at every time interval. You can clear the chapter mark in once too.

You can specify the interval of chapter marks for titles last more than 5 minutes.

Press [DVD] first.

- 1 Follow the steps 1 to 3 in “Editing Title Name” on page 58.
- 2 Select “Chapter Mark” using [▲ / ▼], then press [ENTER].

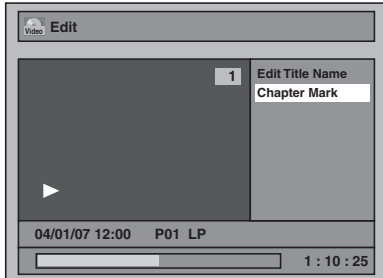

- 3 Select the desired interval using [▲ / ▼], then press [ENTER].

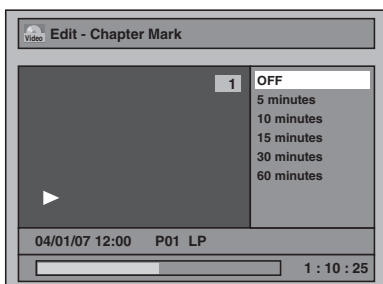

- 4 Select “Yes” using [▲ / ▼], then press [ENTER].

Chapter markers are added.  
If you select “OFF” at step 3, all the chapter markers are erased.

**5** Press [RETURN] and then [RETURN] or [STOP ■] to exit.

Writing on the disc starts.  
It may take awhile to write the data on a disc.

**Note**

- You cannot select the chapter mark of the title which is less than 5 minutes.
- You cannot select a chapter marker interval that exceeds the length of a title.
- The length of chapters may slightly deviate from the one specified at the step 3.
- A chapter marker may be delayed depending on the recording content.
- Maximum number of chapter for Video mode DVD is 99 chapters per disc and title.

## Hiding Chapters



You can hide chapters from the title list.  
Hidden chapters are skipped during playback.

Press [DVD] first.

- 1 Follow the steps 1 to 3 in “Editing Title Name” on page 58.
- 2 Select “Hide Chapter” using [▲ / ▼], then press [ENTER].
- 3 Use [SKIP ◀◀ / ▶▶], [PLAY ▶] and [PAUSE ■] to decide the chapter to be hidden.
- 4 Select “Hidden” using [▲ / ▼], then press [ENTER].

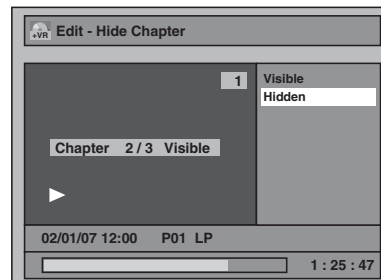

- 5 Press [RETURN].
- 6 Press [RETURN] again and then [RETURN] or [STOP ■] to exit.

Writing on the disc starts.  
It may take awhile to write the data on a disc.

If you want hidden chapters to be “Visible”, select the chapter to be shown. Then use [▲ / ▼] to select “Visible” at the step 4 above. Data will be written onto the disc momentarily.

**Note**

- “Hidden” will be displayed in the preview window while previewing the hidden chapter.
- When you make all chapters in the title “Hidden”, “Hidden” is displayed in a thumbnail of the title list.

## Protecting Titles



To prevent the accidental editing or erasing of the titles, you can protect them in the Original menu.

Press [DVD] first.

- 1 Follow the steps 1 to 3 in “Editing Title Name” on page 58.
- 2 Select “Protect” using [▲ / ▼], then press [ENTER].

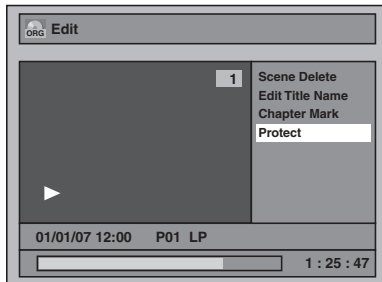

- 3 Press [ENTER] again.

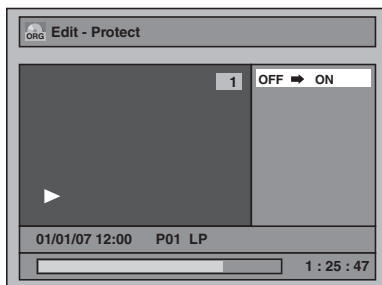

- 4 Press [RETURN] and then [RETURN] or [STOP ■] to exit.

Writing on the disc starts.

It may take awhile to write the data on a disc.

**To protect a whole disc (VR mode DVD-RW and DVD +RW/+R discs only):** Select “Disc Protect OFF → ON” from the Disc Menu, then select “Yes”. Refer to “Setting a Disc to Protect” on page 40.

### Hint

- The protected title is marked with a protect icon in the Original list.

## Dividing a Title



You can divide a title into two new titles.

Press [DVD] first.

- 1 Follow steps 1 to 3 in “Editing Title Name” on page 58.
- 2 Use [SKIP ◀◀ / ▶▶], [REV ◀◀], [FWD ▶▶], [PLAY ▶] and [PAUSE II] to find the point where you wish to divide the title.

- 3 Select “Title Dividing” using [▲ / ▼], then press [ENTER].

- 4 Select “Yes” using [▲ / ▼], then press [ENTER].

e.g.) VR mode DVD-RW disc playlist



The title is divided into two new titles with the same title names.

For DVD+RW : Writing on the disc starts. It may take awhile to write the data on a disc.

For VR mode DVD-RW: Proceed to step 5.

- 5 Press [RETURN] or [STOP ■] to exit.

Writing on the disc starts.

It may take awhile to write the data on a disc.

### Note

- You cannot divide a title of the disc when the number of recording titles reaches the maximum of 99 (-RW) or 49 (+RW), and the number of recording chapters reaches the maximum of 999 (-RW) or 254 (+RW).

## Combining Titles



You can combine two titles into a single title.

Press [DVD] first.

- 1 Follow steps 1 to 3 in “Editing Title Name” on page 58.
- 2 Select “Title Combining” using [▲ / ▼], then press [ENTER].
- 3 Select another title to combine using [▲ / ▼ / ◀ / ▶], then press [ENTER].
- 4 Select “Yes” using [▲ / ▼], then press [ENTER].

The two titles will combine into a single title.

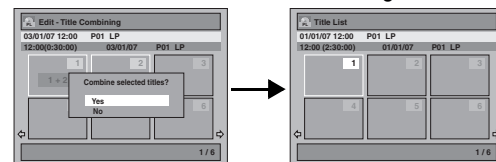

- 5 Press [RETURN] or [STOP ■] to exit.

Writing on the disc starts.

It may take awhile to write the data on a disc.

### Note

- You cannot select the same title twice and combine it into a single title.
- If either one of the two original titles is deleted, the combined new title is also deleted.

Introduction

Connections

Basic Setup

Recording

Playback

Editing

Function Setup

VCR Functions

Others

## Adding Titles to a Playlist



For VR mode DVD-RW disc, you can add a title to the Playlist as you wish.

You can add up to 99 titles to a Playlist (as long as the total number of the Playlist does not exceed 999 chapters).

Press [DVD] first.

**1** Follow the steps 1 to 2 in “Deleting Titles” on page 58.

**2** Select “Add To Playlist” using [▲ / ▼], then press [ENTER].

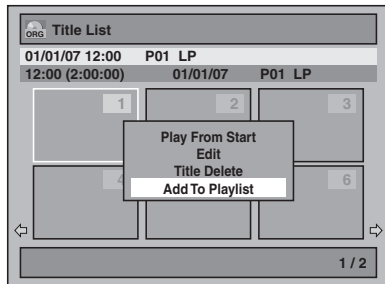

**3** Select “Yes” using [▲ / ▼], then press [ENTER].

The title is added to Playlist.

**4** Press [RETURN] or [STOP ■] to exit.

Writing on the disc starts.  
It may take awhile to write the data on a disc.

### Hint

- To delete a title from the Playlist, refer to “Deleting Titles” on page 58.
- When the disc contains 99 titles or more, or 999 chapters or more, “Add To Playlist” cannot be selected.

## Deleting All Playlists



All Playlists can be deleted if it is no longer needed.

Press [DVD] first.

**1** Press [SETUP].

Main menu will appear.

**2** Select “DVD Menu” using [▲ / ▼], then press [ENTER].

**3** Select “Delete All Playlists” using [▲ / ▼], then press [ENTER].

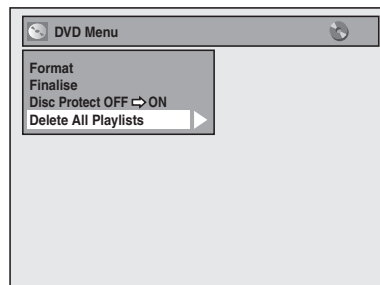

**4** Select “Yes” using [▲ / ▼], then press [ENTER].

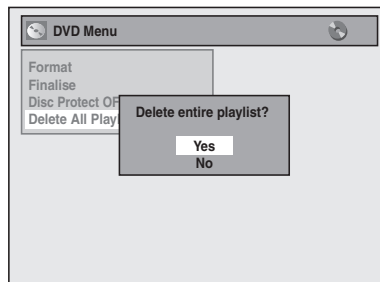

“Are you sure?” will appear.

Select “Yes” using [▲ / ▼], and then press [ENTER].

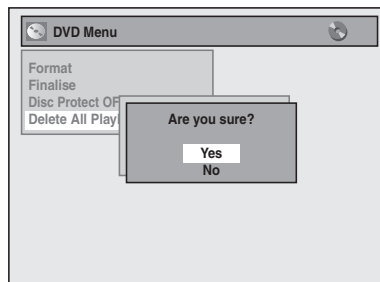

Playlist is deleted.

Writing on the disc starts.

It may take awhile to write the data on a disc.

### Note

- Deleting a Playlist will not increase the available recording time on the disc.

## Deleting Parts of Titles



You can delete a specific part of a title. Even when a title is deleted from the Playlist, the original title will remain as it is. The available recording time on the disc will not increase.

Press [DVD] first.

- Follow the steps 1 to 3 in “Editing Title Name” on page 58.
- Select “Scene Delete” using [▲ / ▼], then press [ENTER].  
e.g.) VR mode DVD-RW disc Playlist

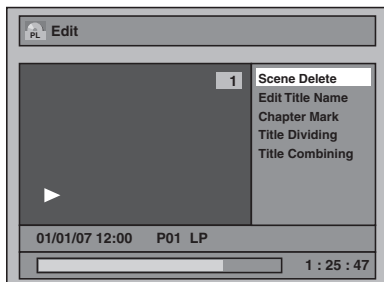

- Use [SKIP ◀◀ / ▶▶], [REV ◀◀], [FWD ▶▶], [PLAY ▶] and [PAUSE II] to find the start point, then press [ENTER].

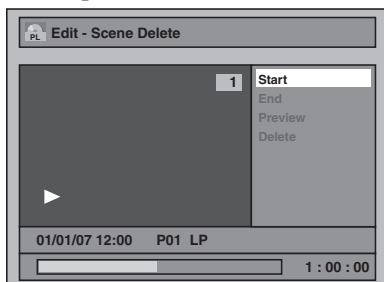

Then use [SKIP ◀◀ / ▶▶], [REV ◀◀], [FWD ▶▶], [PLAY ▶] and [PAUSE II] again to move to the end point, and press [ENTER].

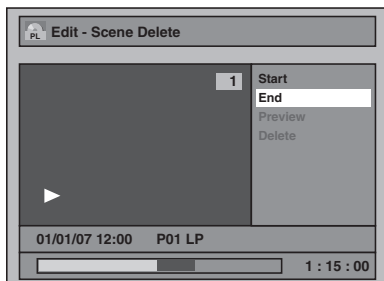

The cursor will move to “Preview”. The bar at the bottom of the screen indicates the total and the elapsed time of the title, and the area selected for deletion is indicated in red.

- You can check the preview by pressing [ENTER].
- Before and after 5 seconds of the deleted point will be playback for preview.

- Select “Delete” using [▲ / ▼], then press [ENTER].

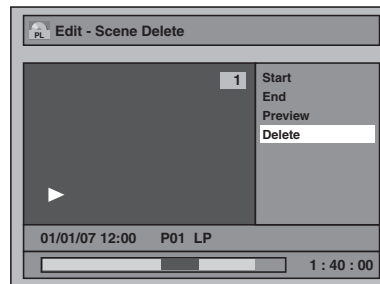

- Select “Yes” using [▲ / ▼], then press [ENTER].  
“Are you sure?” will appear. Select “Yes” using [▲ / ▼], and then press [ENTER].

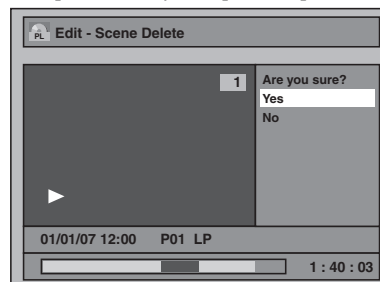

The part of the title is deleted.

- Press [RETURN] and then [RETURN] or [STOP ■] to exit.

Writing on the disc starts. It may take awhile to write the data on a disc.

### Note

- You cannot select “Scene Delete” if the number of chapter markers in the Original or Playlist is more than 900. (Depends on the content, there is a case that you cannot select “Scene Delete” before the number of chapter marks reaches 900.)
- The recordable disc space will not increase after deleting parts of titles.
- When a scene is deleted from an original, the scene on the playlist will also be deleted.

Introduction

Connections

Basic Setup

Recording

Playback

Editing

Function Setup

VCR Functions

Others

# Function Setup

The following table is the contents which you can set and the default settings.  
Refer to the following table for useful operation.

Setup	Items (highlight is the default)	Contents		
General Setting	Playback			
	Parental Lock ➡ page 66	All level 1 to 8	Set the parental level for DVD disc playback.	
	Audio Out ➡ page 66	Dynamic Range Control	ON OFF	Compressing the range of sound volume.
		PCM	48kHz 96kHz	Set whether the sound recorded in 96kHz will be down sampled in 48kHz.
		Dolby Digital	PCM Stream	Set the type of sound signal which outputs from the digital audio output jack.
		MPEG	PCM Stream	Set the digital audio output signal specification.
		DTS	ON OFF	Set whether DTS signal is output or not.
	Disc Menu Language ➡ page 67	English Other	Set the language for Disc Menu.	
	Audio Language ➡ page 67	Original English Other	Set the language for audio.	
	Subtitle Language ➡ page 68	OFF English Other	Set the language for subtitles.	
	Angle Icon ➡ page 68	ON OFF	Set whether or not to display the angle icon.	
	Still Mode ➡ page 68	Auto Field Frame	Set the type of still image in pausing playback.	
	TV System ➡ page 68	PAL Auto	Set the TV system.	
Display				
Screen Saver ➡ page 69	OFF 5 minutes 10 minutes 15 minutes 30 minutes	Set the idling time before the screen saver starts.		
FL Dimmer ➡ page 69	Auto Bright Dark	Set the brightness of the Front Panel Display.		
Video				
TV Aspect ➡ page 69	4:3 Letter Box 4:3 Pan & Scan 16:9 Wide	Set a picture size according to aspect ratio of your TV.		
Select Video ➡ page 38	Video In S-Video In	Set the video input type for the external input.		
Video Out ➡ page 69	SCART (RGB) Component Progressive (P) Component Interface (I)	Sets the video output mode.		



Setup	Items (highlight is the default)	Contents			
General Setting	Recording	Auto Chapter <ul style="list-style-type: none"> <li>➔ page 28</li> </ul>	OFF 5 minutes 10 minutes 15 minutes 30 minutes 60 minutes	Insert chapter marks at even time interval.	
		Recording Audio Select (XP) <ul style="list-style-type: none"> <li>➔ page 30</li> </ul>	PCM Dolby Digital	Set the recording audio type. (Only when the Rec Mode is set to XP.)	
		Auto Finalise <ul style="list-style-type: none"> <li>➔ page 41</li> </ul>	ON OFF	Set the unit to finalise the disc automatically.	
		Aspect Ratio(Video mode) <ul style="list-style-type: none"> <li>➔ page 28</li> </ul>	Auto 4:3 16:9	Set a aspect ratio for Video mode recording.	
		Dubbing Mode <ul style="list-style-type: none"> <li>➔ page 39</li> </ul>	VCR→DVD DVD→VCR	Set the dubbing selection.	
		Make Recording Compatible <ul style="list-style-type: none"> <li>➔ page 28</li> </ul>	ON OFF	Set to prohibiting additional recording (OFF) or to replace the title list after recording (ON).	
		Bilingual Recording Audio <ul style="list-style-type: none"> <li>➔ page 30</li> </ul>	Main Sub	Set the audio type for recording.	
		External Input Audio <ul style="list-style-type: none"> <li>➔ page 30</li> </ul>	Stereo Bilingual	Set the external input audio type for recording.	
		Clock	Clock Setting <ul style="list-style-type: none"> <li>➔ page 25</li> </ul>		Set the clock.
			Auto Clock Setting <ul style="list-style-type: none"> <li>➔ page 24</li> </ul>	ON OFF	Set the clock automatically.
		Channel	Auto Tuning <ul style="list-style-type: none"> <li>➔ page 22</li> </ul>		Tune the channels automatically.
			Manual Tuning <ul style="list-style-type: none"> <li>➔ page 23</li> </ul>		Tune the channels manually.
			Move <ul style="list-style-type: none"> <li>➔ page 24</li> </ul>		Move the channel to different position.
		DivX	DivX®VOD <ul style="list-style-type: none"> <li>➔ page 45</li> </ul>		Provide DivX®VOD registration code.
		DivX Subtitle <ul style="list-style-type: none"> <li>➔ page 70</li> </ul>	OFF English French Spanish German Italian Swedish Dutch Russian1 Russian2 Hungarian Polish Czech Hebrew	Set the language for DivX® Subtitle.	
	Reset All <ul style="list-style-type: none"> <li>➔ page 71</li> </ul>			Set to the default setting.	

**Note**

- Your change to each settings stays on even when the power is switched off.
- An item which is not currently available is grayed in the settings.

Introduction

Connections

Basic Setup

Recording

Playback

Editing

Function Setup

VCR Functions

Others

## Playback

- 1 In stop mode, press [SETUP]. Select "General Setting" using [▲ / ▼], then press [ENTER].
- 2 Select "Playback" using [▲ / ▼], then press [ENTER].

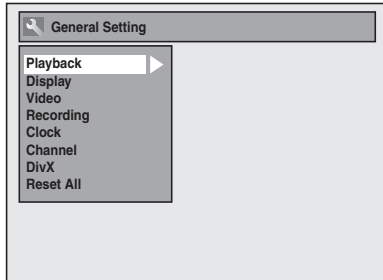

- 3 Select a desired item using [▲ / ▼], then press [ENTER].

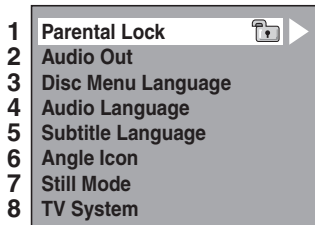

- 4 Refer to 1. to 8. on pages 66 to 68 and set the selected item.
- 5 When you finish with the setting, press [SETUP] to exit.

### 1. Parental Lock (Default: All)

Set the Parental Lock level.

**Change the Parental Lock level using [▲ / ▼], then press [ENTER].**

Proceed with either of the following steps.

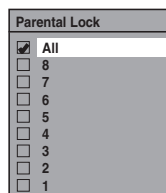

#### Parental level

All: All parental locks are cancelled.

8: DVD software of any grade (adult / general / children) can be played back.

7 to 2: Only DVD software intended for general use and children can be played back.

1: Only DVD softwares intended for children can be played back.

#### Note

- The parental lock function may not be available on some discs.
- It may be difficult to determine if some DVDs support the parental lock function. Be sure to confirm that the parental lock function operates in the way that you have set.
- Record the password in case you forget it.

#### A password is not yet set

Select "Yes" using [▲ / ▼], then press [ENTER]. Enter a new password using [the Number buttons], then press [ENTER].

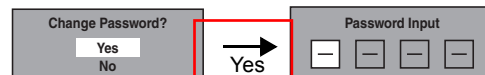

Your setting is activated.

If you select "No", press [SETUP] to exit.

#### A password is already set

Enter the current password using [the Number buttons].



If you want to change the password, select "Yes" using [▲ / ▼], then press [ENTER].

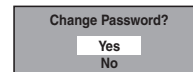

Enter a new password using [the Number buttons], then press [ENTER].



Your setting is activated.

#### Note

- Press [CLEAR] to erase numbers entered incorrectly.
- If you forget your password or you want to clear all settings in Parental Lock, enter [4], [7], [3], [7] using [the Number buttons] at the option window. Your password is cleared and parental levels are set to "All".

### 2. Audio Out

Choose the appropriate audio setting for your external device.

**It will only affect a disc playback.**

Select a desired item using [▲ / ▼], then press [ENTER].

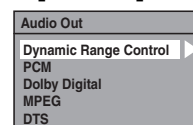

**Dynamic Range Control (Default: ON)**

Set to "ON" to make the dynamic range narrower.

Select a setting using [▲ / ▼], then press [ENTER].

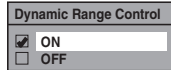

Your setting is activated.

The Dynamic Range Control function is effective only with analogue audio connection.

**Note**

- The Dynamic Range Control function is available only on discs recorded in the Dolby Digital format.

**PCM sampling (Default: 48kHz)**

Select a setting using [▲ / ▼], then press [ENTER].

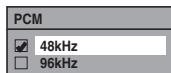

Your setting is activated.

48kHz: If your amplifier / decoder is NOT compatible with 96 kHz PCM, select "48kHz". Sound recorded at 96 kHz is down sampled to 48 kHz.

96kHz: If your amplifier / decoder is compatible with 96 kHz PCM, select "96kHz". Sound is sampled at 96 kHz.

**Note**

When playing back a disc with copyright protection:

- Even if you select "96kHz", the sound is down sampled to 48 kHz.

**Dolby Digital conversion (Default: Stream)**

Select a setting using [▲ / ▼], then press [ENTER].

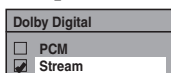

Your setting is activated.

PCM: Converts the Dolby Digital into PCM (2 channel).

If your amplifier / decoder is NOT compatible with Dolby Digital, set to "PCM".

Stream: Outputs Dolby Digital signals.

If your amplifier / decoder is compatible with Dolby Digital, set to "Stream".

**Hint**

When playing back a DVD-RW disc recorded in VR mode:

- If the audio source on a disc is in Dolby Digital format, set "Dolby Digital" to "PCM" so that you can switch to main audio (L), sub audio (R), or a combination of both (L / R) using your amplifier / decoder.

**Settings for MPEG (Default: PCM)**

Select a setting using [▲ / ▼], then press [ENTER].

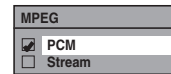

Your setting is activated.

PCM: Converts MPEG into PCM.

If your amplifier / decoder is NOT compatible with MPEG, set to "PCM".

Stream: Outputs MPEG Audio signals.

If your amplifier / decoder is compatible with MPEG, set to "Stream".

**Settings for DTS (Default: ON)**

Select a setting using [▲ / ▼], then press [ENTER].

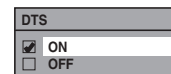

Your setting is activated.

ON: Outputs DTS signals.

If your amplifier / decoder is compatible with DTS, set to "ON".

OFF: No DTS signal is output.

If your amplifier / decoder is NOT compatible with DTS, set to "OFF".

**3. Disc Menu Language (Default: English)**

Set the Disc Menu language.

Select a language using [▲ / ▼], then press [ENTER].

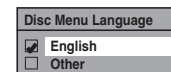

Your setting is activated.

**4. Audio Language (Default: Original)**

Set the Audio language.

Select a language using [▲ / ▼], then press [ENTER].

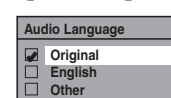

Your setting is activated.

If "Original" is selected, the audio language is the default of the inserted disc.

Introduction

Connections

Basic Setup

Recording

Playback

Editing

Function Setup

VCR Functions

Others

## 5. Subtitle Language (Default: OFF)

Set the Subtitle language.

Select a language using [**▲** / **▼**], then press [**ENTER**].

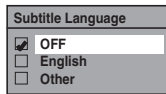

Your setting is activated.

If "Other" is selected, enter the appropriate 4-digit code using [the Number buttons].

Refer to "Language Code" on page 79.

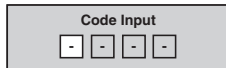

When you finish entering the code, press [**ENTER**].

### Hint

- You can also change or switch off the subtitles on a DVD from the disc menu if it is available.
- Press [**CLEAR**] or [**◀**] to erase numbers entered incorrectly.

### Note

- You can only select the languages supported by the inserted disc.
- The Audio Language setting may not be available for some discs.

## 6. Angle Icon (Default: ON)

Set the angle icon.

Select a setting using [**▲** / **▼**], then press [**ENTER**].

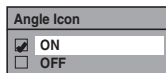

Your setting is activated.

## 7. Still Mode (Default : Auto)

Select a setting using [**▲** / **▼**], then press [**ENTER**].

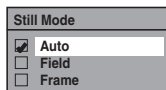

Your setting is activated.

- Auto: Automatically select the best resolution setting ("Frame" or "Field") based on the data characteristics of the pictures.
- Field: Select "Field" when the pictures are still unstable even if "Auto" is selected. "Field" stabilises the pictures, although the picture quality may become coarse due to the limited amount of data.
- Frame: Select "Frame" to display relatively motionless pictures in higher resolution. "Frame" improves the picture quality, although it may unbalance the pictures due to simultaneous output of two Field data.

### Note

- An individual picture on TV screen is called as Frame, which consists of two separate images called as Field. Some pictures may be blurred at the "Auto" setting in still mode due to their data characteristics.

## 8. TV System (Default: PAL)

Select a setting using [**▲** / **▼**], then press [**ENTER**].

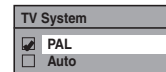

Your setting will be activated.

- PAL: Outputs a modified PAL signal for viewing discs recorded with the NTSC system on a PAL system TV.
- Auto: Changes the video system (PAL / NTSC) automatically according to the format of the inserted disc.

### Note

- With discs recorded using the PAL system, a PAL signal is output for viewing on a PAL system TV.
- Discs recorded with the PAL system cannot be viewed on an NTSC system TV.
- With discs recorded using the NTSC system, an NTSC signal is output for viewing on an NTSC or Multi system TV.
- With discs recorded using the NTSC system, select PAL to view on a PAL system TV.

## Display

- 1 In stop mode, press [SETUP]. Select "General Setting" using [▲ / ▼], then press [ENTER].
- 2 Select "Display" using [▲ / ▼], then press [ENTER].

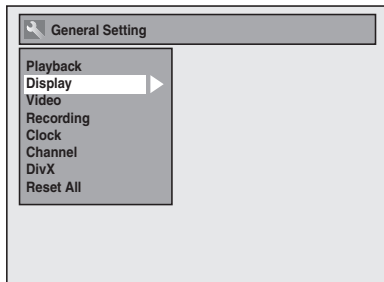

- 3 Select the desired item using [▲ / ▼], then press [ENTER].

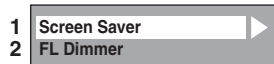

- 4 Refer to 1. and 2. on this page and set the selected item.
- 5 When you finish with the setting, press [SETUP] to exit.

### 1. Screen Saver (Default: 10 minutes)

Set the screen saver time delay.

Select a setting using [▲ / ▼], then press [ENTER].

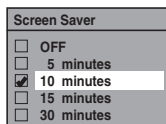

Your setting is activated.

### 2. FL Dimmer (Default: Bright)

Set the front panel display brightness.

Select a setting using [▲ / ▼], then press [ENTER].

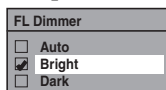

You can choose one from "Auto", "Bright" or "Dark".

If "Auto" is selected, the display gets dark when the power is off.

## Video

- 1 In stop mode, press [SETUP]. Select "General Setting" using [▲ / ▼], then press [ENTER].
- 2 Select "Video" using [▲ / ▼], then press [ENTER].

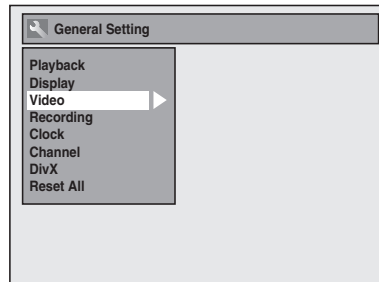

- 3 Select the desired item using [▲ / ▼], then press [ENTER].

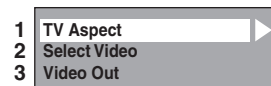

- 4 Refer to 1. and 3. on this page and set the selected item.

For 2., refer to page 38.

- 5 When you finish with the setting, press [SETUP] to exit.

### 1. TV Aspect (Default: 4:3 Letter Box)

You can select the TV aspect ratio to match the formats of what you are playing back with the unit and your TV screen (4:3 standard or 16:9 widescreen TV).

Select the desired setting using [▲ / ▼], then press [ENTER].

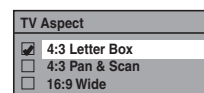

#### If you have a standard TV:

Select "4:3 Letter Box", so that black bars appear on the top and bottom of the TV screen when playing back a wide-screen picture. Select "4:3 Pan & Scan" for a full height picture with both sides trimmed when playing back wide-screen picture.

#### If you have a widescreen TV:

Select "16:9 Wide".

### 3. Video Out (Default: SCART(RGB))

This unit is compatible with the Progressive Scan System. The feature provides you with the higher definition images than the traditional output system does. To utilise this feature, you must set Video Output mode in the Setup menu by following the steps on the right. "SCART (RGB)" is selected as the default.

**1 Select the desired setting using [▲ / ▼], then press [ENTER].**

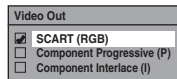

- If you select "Component Progressive (P)", proceed to step 2 below.
- If you select "SCART (RGB)" or "Component Interface (I)", your setting is activated.
- Refer to pages 19 and 20 for more details.

**2 Using [◀ / ▶] to select "Yes". Press [ENTER].**

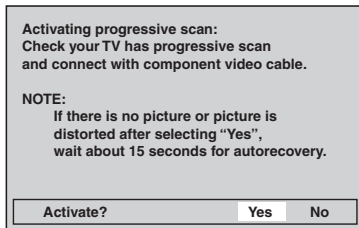

Final confirmation window will appear.

**3 Using [▲ / ▼] to select "Yes". Press [ENTER] within 15 seconds.**

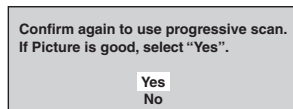

Your setting is activated.

**Note**

- If your TV is compatible with Progressive Scan (625p/525p), you must use the Component Video cable (commercially available) to connect this unit to the TV.
- When changing the Video Out setting ("SCART (RGB)", "Component Interface (I)" or "Component Progressive (P)"), connect to a VIDEO jack or an S-VIDEO jack on the TV. If the setting is changed, for example, to "SCART (RGB)" while the COMPONENT VIDEO OUT jacks are used to connect to the TV, a distorted video signal may be output.

## DivX®

**1 In stop mode, press [SETUP]. Select "General Setting" using [▲ / ▼], then press [ENTER].**

**2 Select "DivX" using [▲ / ▼], then press [ENTER].**

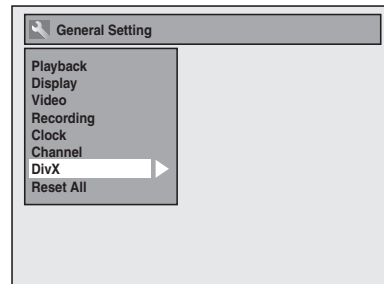

**3 Select the desired item using [▲ / ▼], then press [ENTER].**

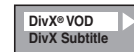

For DviX® VOD, refer to page 45 for details.

### DivX Subtitle (Default: OFF)

Select the desired setting using [▲ / ▼], then press [ENTER].

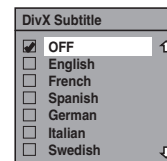

**4 When you finish with the setting, press [SETUP] to exit.**

## Reset All

- 1** In stop mode, press [SETUP]. Select "General Setting" using [▲ / ▼], then press [ENTER].
- 2** Select "Reset All" using [▲ / ▼], then press [ENTER].

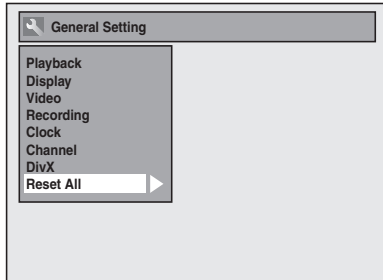

- 3** Select "Yes" using [▲ / ▼], then press [ENTER].

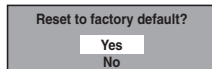

"Are you sure?" will appear. Select "Yes" using [▲ / ▼], and then press [ENTER].

- 4** When you finish with the setting, press [SETUP] to exit.

### Note

- The settings listed below will remain unchanged even after resetting to the factory default.
  - Clock setting
  - Channel setting
  - Parental lock setting
  - DivX® VOD code
  - Timer Programmes

Introduction

Connections

Basic Setup

Recording

Playback

Editing

Function Setup

VCR Functions

Others

# VCR Functions

## Playback



- 1** Press [I/⏻ ON / STANDBY] to turn on the unit.  
To play back a tape, turn on the TV and be sure to select the input to which the unit is connected.
- 2** Press [VCR].
- 3** Insert a pre-recorded tape, then press [PLAY ▶] to begin playback.
- 4** During playback, press [PAUSE II].  
Playback will be paused and sound will be muted.
- 5** Press [PLAY ▶] to resume playback.
- 6** Press [STOP ■] to stop playback.
- 7** Press [OPEN / CLOSE ▲] to eject the tape.

### Note

- When a tape without record tab is inserted, the unit will start playback automatically.
- Tracking will be automatically adjusted upon playback. To adjust the tracking manually, press [PROG. ^ / ∨].

## Recording and One-touch Timer Recording (OTR)

### Basic Recording



#### Before recording, make sure:

- The desired channel is selected by pressing [the Number buttons] or [PROG. ^ / ∨] on the remote control.
- There is a tape with a record tab in the unit.

Tape speed	Recording / Playback Time			
	Type of tape	E60	E120	E180
SP mode	1 hour	2 hours	3 hours	4 hours
LP mode	2 hours	4 hours	6 hours	8 hours

- Refer to page 33 for instructions on timer recording.

- 1** Turn on the unit and insert a recordable tape.  
Make sure that the TV input is set on the unit.
- 2** Press [VCR].
- 3** Select the recording mode using [REC MODE].  
• The desired recording mode is selected in SP (standard play) or LP (long play) mode by pressing [REC MODE].
- 4** Select the desired channel to record using [PROG. ^ / ∨] or [the Number buttons].
- 5** Press [REC ●] to start recording.  
To temporarily stop recording or to resume it, press [PAUSE II].

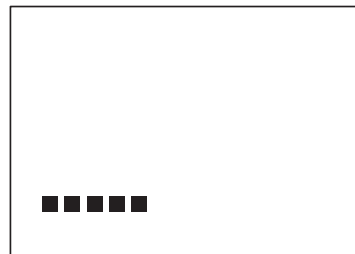

After the unit has been in pause mode for 5 minutes, it will stop automatically to protect the tape and the video head from damage.

- 6** Press [STOP ■] when the recording is completed.



## Accidental erasure prevention

To prevent accidental recording on a recorded cassette, remove its record tab. To record on it later, cover the hole with cellophane tape.

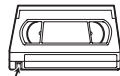

Record tab

## One-touch Timer Recording



This feature allows you to set the recording length simply by pressing [REC ●].

- 1 Turn on the unit and insert a recordable tape.**  
Make sure that the TV input is set on the unit.
- 2 Press [VCR].**
- 3 Select the recording mode using [REC MODE]. (See page 72.)**
- 4 Select the desired channel to record using [PROG. ^ / ∨] or [the Number buttons].**
- 5 Press [REC ●] repeatedly until the desired recording time (30 minutes to 8 hours) appears on the TV screen.**

One-touch Timer Recording will start.

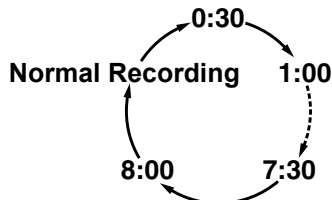

- When the unit reaches the specified time, it will be turned off automatically.
- To change the recording length during One-touch Timer Recording, press [REC ●] repeatedly until the desired length appears.
- To cancel One-touch Timer Recording within the specified time, press [STOP ■].

### Hint

- The remaining recording time will appear on the TV screen during One-touch Timer Recording. Press [DISPLAY] to see it on the TV screen.

### Note

- If VCR One-touch Timer Recording is completed during DVD playback or recording, the VCR will be in stop mode and the DVD keeps the current mode.
- You cannot use the pause function during One-touch Timer Recording.
- When One-touch Timer Recording is finished and the power is turned off, the unit will switch to the timer-standby mode automatically if a timer recording has been programmed. Press [TIMER SET] to cancel the timer-standby mode in order to use the unit continuously.

## Search

### Index Search



- 1 Press [VCR].**
- 2 Press [SEARCH] so that the index search menu appears.**
- 3 Enter the number of recordings you wish to skip using [the Number buttons] within 30 seconds.**
- 4 Press [FWD ►►] or [REV ◄◄] to start index search.**  
If you want to go in the forward direction, press [FWD ►►].  
If you want to go in the reverse direction, press [REV ◄◄].  
After index search, the VCR will play back the tape automatically.

### Note

- This function is not available during recording.
- Every time a tape is recorded, an index mark is written on the tape.
- You can make the index mark up to 20.

### Time Search



This feature allows you to go to a specific point on a tape by entering the exact amount of time you wish to skip in order to reach the point.

- 1 Press [VCR].**
- 2 Press [SEARCH] repeatedly until the time search menu appears.**
- 3 Enter your desired time to skip using [the Number buttons] within 30 seconds.**
- 4 Press [FWD ►►] or [REV ◄◄] to start time search.**  
If you want to go in the forward direction, press [FWD ►►].  
If you want to go in the reverse direction, press [REV ◄◄].  
After time search, the unit will play back the tape automatically.

### Note

- This function is not available during recording.
- Press [STOP ■] to stop the search.
- If the tape reaches the end during the search, this unit will cancel it and rewind the tape.
- You can set the time up to 9:59.

Introduction

Connections

Basic Setup

Recording

Playback

Editing

Function Setup

VCR Functions

Others

## Other Operations



Press **[VCR]** first.

### To cue or review picture during playback

#### (Picture Search):

Press **[FWD ►►]** or **[REV ◀◀]** during playback. Press it again and the unit will search in super high speed (in the LP mode only).

### To freeze the picture on TV screen during playback (Still mode):

Press **[PAUSE II]**. Each time you press the button, the picture will be forwarded frame by frame. If the picture begins to vibrate vertically during the still mode, stabilise the picture by pressing the **[PROG. ^ / ∨]**. If the picture is distorted or rolling vertically, adjust the vertical hold control on your TV, if equipped.

### To reset the tape counter:

Press **[CLEAR]**.

### To play back in slow forward motion:

During playback, press **[PAUSE II]**, then press **[FWD ►►]**. If the noise bars appear on the TV screen, you can reduce it by pressing **[PROG. ^ / ∨]**. Slow reverse is not available in VCR mode.

### To repeat a playback indefinitely without touching

#### **[PLAY ►]** (Auto Repeat Playback):

During normal playback, press **[REPEAT]**. When a tape is played to its end, the tape will rewind to the beginning and start playback itself. To cancel the Auto Repeat Playback, press **[REPEAT]** again.

#### Note

- Still / Slow / Pause mode will be automatically cancelled after 5 minutes to prevent damage to the tape and the video head.
- To return to normal play back from the Picture Search / Still / Slow mode, press **[PLAY ►]**.

## Hi-Fi Stereo Sound System

This unit will record and playback Hi-Fi stereo sound. In addition, it has a NICAM stereo sound decoder. This unit will receive stereo and bilingual broadcasts and it is possible to record in several ways and to play back the sound.

### Selecting the Sound Mode

You can select each mode by pressing **[AUDIO ◯◯]** on the remote control. Each mode is indicated on the TV screen as following.

- During playback of the recorded tape in Hi-Fi mode
- During reception of stereo broadcasts

Mode	Audio output	Display on the TV screen
Stereo	Stereo	STEREO
L	L audio from both speakers	LEFT
R	R audio from both speakers	RIGHT
Normal	Monaural	MONO

- During reception of bilingual broadcasts

Mode	Audio output	Display on the TV screen
Main	Main audio from the both speakers	Main
Sub	Sub audio from the both speakers	Sub
Main / Sub	<ul style="list-style-type: none"> <li>• Main audio from the left speaker</li> <li>• Sub audio from the right speaker</li> </ul>	Main Sub

#### Note

- If you play back non-Hi-Fi tapes, the unit will play back automatically in monaural even if you select any mode.
- If the stereo signal becomes weak, the broadcast is automatically recorded in monaural.

# Others

## Troubleshooting

Before requesting service for this unit, check the table below for a possible cause of the problem you are experiencing. Some simple checks or a minor adjustment by you may eliminate the problem and restore correct operation.

DVD • VCR	
Symptom	Remedy
The power does not turn on.	<ul style="list-style-type: none"> <li>• Check the mains cable is connected securely.</li> <li>• Check the breaker (in case of power failure).</li> </ul>
There is no picture.	<ul style="list-style-type: none"> <li>• Check signal cables are connected securely.</li> <li>• Check if a connecting cable is damaged.</li> <li>• Check connections to your TV. (See page 19.)</li> <li>• Switch the input selector on your TV (to "AV1", for example) until a picture appears on the screen.</li> </ul>
TV programme picture does not fill the screen.	<ul style="list-style-type: none"> <li>• Set channels with "Auto Tuning" from the screen menu. (See page 22.)</li> <li>• Select the channel of a TV programme(s) using [PROG. ^ / v].</li> </ul>
TV programme pictures are distorted.	<ul style="list-style-type: none"> <li>• Adjust the direction of the TV antenna.</li> <li>• Adjust the picture. (See the TV instruction manual.)</li> <li>• Place the antenna and the TV farther apart.</li> <li>• Separate any bunched antenna cables and the TV.</li> </ul>
TV channel cannot be changed.	<ul style="list-style-type: none"> <li>• Switch the TV input.</li> <li>• Check if the antenna cable is connected correctly. (See page 19.)</li> </ul>
The channel cannot be changed from the channel you are recording.	<ul style="list-style-type: none"> <li>• Set the TV input to "TV".</li> </ul>
Playback picture is distorted.	<ul style="list-style-type: none"> <li>• Do not bring equipment that may cause electrical interference, such as a cellular phone, near the unit.</li> </ul>
The playback picture or TV programme from equipment connected through the unit is distorted.	<ul style="list-style-type: none"> <li>• If a DVD player, VCR or tuner is connected to your TV via the unit, the copy-protection signal applied to some programme(s) could affect picture quality. Disconnect the playback equipment in question and connect it directly to your TV.</li> </ul>
Nothing was recorded even though you set the timer setting correctly.	<ul style="list-style-type: none"> <li>• There was a power failure during recording.</li> <li>• The unit's internal clock stopped due to a power failure that lasted for more than 30 seconds.</li> <li>• Reset the clock. (See page 24.)</li> <li>• Unplug the mains cable from the AC outlet and plug it in again.</li> <li>• The programme contains copy protection signals that restrict copying.</li> <li>• The timer setting overlapped with another setting that was set later or has priority.</li> </ul>
Timer recording is not completed or did not start from the beginning.	<ul style="list-style-type: none"> <li>• The timer setting overlapped with another setting that has priority. (See pages 35-36.)</li> <li>• There was not enough disc or tape space.</li> </ul>
Timer recording does not start.	<ul style="list-style-type: none"> <li>• No disc is inserted.</li> <li>• A disc is not recordable (finalised DVD-RW/-R, finalised DVD+R, a fully recorded disc, etc.).</li> </ul>
There is no sound.	<ul style="list-style-type: none"> <li>• The disc is dirty or flawed.</li> <li>• Check if all cables are connected securely.</li> <li>• Check if a connecting cable is damaged.</li> <li>• Check the connections to the amplifier input.</li> <li>• Check if the input source setting on the amplifier is correct.</li> <li>• Check if the recorder is in Pause mode or in Slow-motion Playback mode.</li> <li>• Check if the recorder is in Fast Forward or Fast Reverse mode.</li> </ul>
Timer recording is not possible.	<ul style="list-style-type: none"> <li>• Make sure  indicator appears on the front panel display of this unit. If not, press [TIMER SET].</li> </ul>
The remote control does not function.	<ul style="list-style-type: none"> <li>• Batteries are exhausted.</li> <li>• There are obstacles between the remote control and the unit.</li> <li>• The remote control is too far from the unit.</li> <li>• There are no batteries in the remote control.</li> <li>• The unit is not turned on.</li> <li>• The remote control is not pointed at the remote sensor on the unit.</li> <li>• Press [DVD] or [VCR], whichever you need. Then try again.</li> </ul>
The unit does not operate correctly.	<ul style="list-style-type: none"> <li>• If static electricity or anything else causes the unit to operate abnormally, unplug the mains cable and plug it in again.</li> </ul>

Introduction

Connections

Basic Setup

Recording

Playback

Editing

Function Setup

VCR Functions

Others

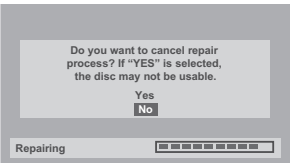
DVD	
Symptom	Remedy
There is no picture.	<ul style="list-style-type: none"> <li>If the Setup menu display appears, press <b>[SETUP]</b> or <b>[RETURN]</b> to turn off the display.</li> </ul>
Picture noise appears.	<ul style="list-style-type: none"> <li>The disc is dirty or flawed.</li> <li>If the unit is connected to your TV via a VCR, or if it is connected to a combination TV / VIDEO player, the copy-protection signal applied to some DVD programme could affect picture quality. If you still experience this problem even when you connect the unit directly to your TV, try connecting the unit to your TV's S-VIDEO input.</li> </ul>
Sound is noisy.	<ul style="list-style-type: none"> <li>The disc is dirty or flawed.</li> </ul>
The unit does not play back the disc.	<ul style="list-style-type: none"> <li>No disc is inserted.</li> <li>A blank disc is inserted.</li> <li>The disc is upside down. Insert the disc with the labelled side facing up.</li> <li>The disc is not correctly inserted.</li> <li>The unit cannot play back certain discs (such as a CD-ROM). (See page 10.)</li> <li>The region codes on the DVD-Video and the unit are not matched. (See page 10.)</li> <li>Moisture has condensed inside the unit. Remove the disc and leave the unit turned on for about two hours until the moisture evaporates. (See page 3.)</li> <li>Check if the disc has been finalised by the same recording device.</li> </ul>
There is no sound.	<ul style="list-style-type: none"> <li>If the audio signal is not output from the DIGITAL AUDIO OUT (COAXIAL) jack, check the Audio setting. (See pages 66-67.)</li> </ul>
Playback image freezes for a moment.	<ul style="list-style-type: none"> <li>During the playback of a two layered disc, the picture may freeze for a moment while playback switches from the first to the second layer. This is not a malfunction.</li> </ul>
The unit does not play back the disc from the beginning.	<ul style="list-style-type: none"> <li>Resume playback is activated. (See page 48.) Press <b>[STOP ■]</b> twice.</li> <li>You have inserted a disc whose Title menu or disc menu automatically appears on the TV screen when it is first inserted.</li> </ul>
The unit starts playing back the disc automatically.	<ul style="list-style-type: none"> <li>The DVD-Video features an auto playback function.</li> </ul>
Some functions such as Stop, Search, or Slow-motion Playback cannot be performed.	<ul style="list-style-type: none"> <li>Depending on the disc, you may not be able to perform some of those operations. See the instruction manual supplied with the disc.</li> </ul>
The language for the sound track cannot be changed.	<ul style="list-style-type: none"> <li>Multilingual tracks are not recorded on the DVD-Video, DVD-RW/R or DVD+RW/+R disc being played back.</li> <li>The DVD-Video prohibits the changing of the language for the sound track.</li> <li>Try changing the language using the DVD-Video menu.</li> </ul>
The subtitle language cannot be changed or turned off.	<ul style="list-style-type: none"> <li>Multilingual subtitles are not recorded on the DVD-Video.</li> <li>The DVD-Video prohibits changing the subtitles.</li> <li>Try changing the subtitles using the DVD-Video menu.</li> </ul>
Angles cannot be changed.	<ul style="list-style-type: none"> <li>You can change the angle only if the disc contains multi-angle scene. Angles can be changed only when the multi-angle scene appears on the screen.</li> <li>The DVD-Video prohibits changing angles.</li> <li>Try changing the angle using the DVD-Video menu.</li> </ul>
Recording does not start immediately after pressing <b>[REC ●]</b> .	<ul style="list-style-type: none"> <li>An unused DVD-RW or DVD+RW disc was inserted. It takes awhile for the unit to automatically format a DVD-RW or DVD+RW.</li> </ul>
Recording does not stop immediately after you press <b>[STOP ■]</b> .	<ul style="list-style-type: none"> <li>It will take a few seconds for the unit to send data to disc before recording can stop.</li> </ul>
The disc tray does not open when you press <b>[OPEN / CLOSE ▲]</b> .	<ul style="list-style-type: none"> <li>It may take a few seconds for the disc tray to open after you have recorded or edited a disc.</li> <li>This is because the unit is sending data to the disc.</li> </ul>
<p>"Repairing" appears on the display.</p>  <p>In a case you intend to cancel the Repairing process.</p> 	<ul style="list-style-type: none"> <li>If a power failure occurs or the mains cable is unplugged during recording, finalising, formatting or editing (even after "Wait for a moment." message disappeared), a repairing process will begin automatically when the unit is turned on next time. It may take several minutes up to about four hours.</li> <li>If you intend to cancel the Repairing process, press <b>[▲ (OPEN / CLOSE)]</b> on the front panel, then select "Yes" with <b>[▲ / ▼]</b> and press <b>[ENTER]</b>. After that, the disc tray will automatically open. <b>In case the Repairing process is cancelled, the disc MAY NOT work.</b></li> </ul>

VCR	
Symptom	Remedy
Picture noise appears.	<ul style="list-style-type: none"> <li>Adjust tracking control for better picture by pressing [<b>PROG.</b> ^ / v] while you are playing back a video tape.</li> <li>Head cleaning for VCR may be necessary. Refer to "AUTO HEAD CLEANING" on page 5.</li> </ul>
The unit does not play back the tape.	<ul style="list-style-type: none"> <li>No video tape is inserted.</li> </ul>
Recording does not start immediately after pressing [ <b>REC</b> ●].	<ul style="list-style-type: none"> <li>Make sure the video tape has a record tab when you record to a video tape. If needed, cover the hole with cellophane tape.</li> </ul>
The remote control does not function.	<ul style="list-style-type: none"> <li>Check if a video tape is in the unit. Press [<b>VCR</b>]. Then try again.</li> </ul>
The motor rotates even when playback / recording is stopped.	<ul style="list-style-type: none"> <li>The motor may rotate for the duration of approximately 5 minutes for efficient operation. This is not a malfunction.</li> </ul>

\* If the above remedies do not solve the problem, please call an authorised service centre.

Introduction

Connections

Basic Setup

Recording

Playback

Editing

Function Setup

VCR Functions

Others

Error message	Cause	Solution
Disc Error — Please eject the disc. — Playback feature may not be available on this disc.	<ul style="list-style-type: none"> <li>An unplayable disc is inserted in the unit.</li> <li>The disc is upside down.</li> </ul>	<ul style="list-style-type: none"> <li>Insert a standard disc shown in pages 9–10.</li> <li>Insert the disc with the labelled side facing up.</li> </ul>
Region Error — Please eject the disc. — Playback is not authorized in your region.	<ul style="list-style-type: none"> <li>Playback is not authorised in the region of the DVD-Video that you inserted in the unit.</li> </ul>	<ul style="list-style-type: none"> <li>Insert a DVD-Video with region codes 2 or ALL.</li> </ul>
Parental Lock On The current selected parental level prohibits playback.	<ul style="list-style-type: none"> <li>The current selected parental level in the Setup menu prohibits playback.</li> </ul>	<ul style="list-style-type: none"> <li>Check the "Parental Lock" setting. (See page 66.)</li> </ul>
Recording Error This program is not allowed to be recorded.	<ul style="list-style-type: none"> <li>The recording function encountered a copy prohibited programme.</li> <li>Original source is in NTSC system.</li> </ul>	<ul style="list-style-type: none"> <li>You cannot record copy prohibited programmes.</li> </ul>
Recording Error This program is not recordable in Video mode.	<ul style="list-style-type: none"> <li>You are trying to record a copy-once programme onto a DVD-RW disc in Video mode.</li> </ul>	<ul style="list-style-type: none"> <li>Set "Format Mode" to "VR mode". (See page 27.)</li> </ul>
Recording Error Cannot record on this disc.	<ul style="list-style-type: none"> <li>You are trying to record onto a disc that is unrecordable, or the disc status does not satisfy recording requirements.</li> <li>The disc is dirty.</li> <li>The disc is damaged.</li> </ul>	<ul style="list-style-type: none"> <li>Insert a recordable disc, and ensure the disc status satisfies the recording requirements. (See page 26.)</li> <li>Clean the disc with a cleaning cloth.</li> <li>Replace the disc.</li> </ul>
Recording Error This program is not allowed to be recorded on this disc.	<ul style="list-style-type: none"> <li>You are trying to record a copy-once programme onto a DVD disc that is not compatible with CPRM.</li> </ul>	<ul style="list-style-type: none"> <li>Insert a ver. 1.1 or ver. 1.2 DVD-RW disc (compatible with CPRM.)</li> </ul>
Recording Error This disc is protected and not recordable.	<ul style="list-style-type: none"> <li>You are trying to record onto a disc that is set as protected in the Setup Menu.</li> </ul>	<ul style="list-style-type: none"> <li>Remove the disc protect setting in the Disc menu. (See page 40.)</li> </ul>
Recording Error Disc is full. (No area for new recording)	<ul style="list-style-type: none"> <li>You are trying to record onto a disc that has no space for recording.</li> </ul>	<ul style="list-style-type: none"> <li>Insert a recordable disc with enough recording space.</li> <li>Delete unnecessary original titles. (See page 58.)</li> </ul>
Recording Error You cannot record more than 99 titles on one disc. (The maximum is 99)	<ul style="list-style-type: none"> <li>You are trying to record onto a disc on which the number of recorded titles has reached the maximum (99).</li> </ul>	<ul style="list-style-type: none"> <li>Delete unnecessary original titles. (See page 58.)</li> </ul>
Recording Error You cannot record more than 999 chapters on one disc. (The maximum is 999)	<ul style="list-style-type: none"> <li>You are trying to record onto a disc on which the number of recorded chapters has reached the maximum (999).</li> </ul>	<ul style="list-style-type: none"> <li>Delete unnecessary chapter marker from an Original list. (See page 59.)</li> </ul>
Recording Error You cannot record more than 49 titles on one disc. (The maximum is 49)	<ul style="list-style-type: none"> <li>You are trying to record onto the DVD+RW/+R disc on which the number of recording titles comes up to the maximum (49).</li> </ul>	<ul style="list-style-type: none"> <li>Delete unnecessary titles. (See page 58.)</li> </ul>
Recording Error You cannot record more than 254 chapters on one disc. (The maximum is 254)	<ul style="list-style-type: none"> <li>You are trying to record onto the DVD+RW disc on which the number of recording chapters comes up to the maximum (254).</li> </ul>	<ul style="list-style-type: none"> <li>Delete unnecessary chapter marks. (See page 59.)</li> </ul>
Recording Error You cannot record on this disc as Control Information is full.	<ul style="list-style-type: none"> <li>This disc has no space to write Control Information when recording or deleting contents.</li> <li>When editing has been repeatedly performed, the control information area may become full even though the recording area has enough space.</li> </ul>	<ul style="list-style-type: none"> <li>Delete unnecessary original titles. (See page 58.)</li> </ul>
Recording Error You cannot record on this disc as Power Calibration Area is full.	<ul style="list-style-type: none"> <li>When recordings are performed repeatedly onto an unstable disc, this area may become full.</li> <li>Every time you insert a disc for recording, part of the disc's working area will be used.</li> <li>If you repeat this frequently, it will be used up quicker and you may not be able to record full 99 titles.</li> </ul>	<ul style="list-style-type: none"> <li>Insert a new disc.</li> </ul>
Recording Error This disc is already finalised.	<ul style="list-style-type: none"> <li>You are trying to record onto a disc that is already finalised.</li> </ul>	<ul style="list-style-type: none"> <li>Release the finalising for the disc. (See page 41.)</li> </ul>
Recording Error The disc has no recording compatibility. Set "Make Recording Compatible" to "ON" to convert the disc.	<ul style="list-style-type: none"> <li>You are trying to record onto the unfinalised +VR mode discs recorded on other unit.</li> </ul>	<ul style="list-style-type: none"> <li>Set "Make Recording Compatible" to "ON" to rewrite the menu, after that you will record to disc. (See page 28.)</li> </ul>

\* If you are still having trouble with the unit after checking all the Troubleshooting points, write down the error code and the error description and consult your dealer or an authorised service centre.

## Language Code

Language	Code	Language	Code	Language	Code	Language	Code
Abkhazian	4748	French	5264	Lithuanian	5866	Sindhi	6550
Afar	4747	Frisian	5271	Macedonian	5957	Singhalese	6555
Afrikaans	4752	Galician	5358	Malagasy	5953	Siswat	6565
Albanian	6563	Georgian	5747	Malay	5965	Slovak	6557
Amharic	4759	German	5051	Malayalam	5958	Slovenian	6558
Arabic	4764	Greek	5158	Maltese	5966	Somali	6561
Armenian	5471	Greenlandic	5758	Maori	5955	Spanish	5165
Assamese	4765	Guarani	5360	Marathi	5964	Sundanese	6567
Aymara	4771	Gujarati	5367	Moldavian	5961	Swahili	6569
Azerbaijani	4772	Hausa	5447	Mongolian	5960	Swedish	6568
Bashkir	4847	Hebrew	5569	Nauru	6047	Tagalog	6658
Basque	5167	Hindi	5455	Nepali	6051	Tajik	6653
Bengali; Bangla	4860	Hungarian	5467	Norwegian	6061	Tamil	6647
Bhutani	5072	Icelandic	5565	Occitan	6149	Tatar	6666
Bihari	4854	Indonesian	5560	Oriya	6164	Telugu	6651
Bislama	4855	Interlingua	5547	Oromo (Afan)	6159	Thai	6654
Breton	4864	Interlingue	5551	Panjabi	6247	Tibetan	4861
Bulgarian	4853	Inupiak	5557	Pashto; Pushto	6265	Tigrinya	6655
Burmese	5971	Irish	5347	Persian	5247	Tonga	6661
Byelorussian	4851	Italian	5566	Polish	6258	Tsonga	6665
Cambodian	5759	Japanese	5647	Portuguese	6266	Turkish	6664
Catalan	4947	Javanese	5669	Quechua	6367	Turkmen	6657
Chinese	7254	Kannada	5760	Rhaeto-Romance	6459	Twi	6669
Corsican	4961	Kashmiri	5765	Romanian	6461	Ukrainian	6757
Croatian	5464	Kazakh	5757	Russian	6467	Urdu	6764
Czech	4965	Kinyarwanda	6469	Samoan	6559	Uzbek	6772
Danish	5047	Kirghiz	5771	Sangho	6553	Vietnamese	6855
Dutch	6058	Kirundi	6460	Sanskrit	6547	Volapuk	6861
English	5160	Korean	5761	Scots Gaelic	5350	Welsh	4971
Esperanto	5161	Kurdish	5767	Serbian	6564	Wolof	6961
Estonian	5166	Laothian	5861	Serbo-Croatian	6554	Xhosa	7054
Faroese	5261	Latin	5847	Sesotho	6566	Yiddish	5655
Fiji	5256	Latvian; Lettish	5868	Setswana	6660	Yoruba	7161
Finnish	5255	Lingala	5860	Shona	6560	Zulu	7267

Introduction

Connections

Basic Setup

Recording

Playback

Editing

Function Setup

VCR Functions

Others

## Glossary

### Analogue audio

An electrical signal that directly represents sound. In contrast, digital audio can also be an electrical signal, but is an indirect representation of sound. See also Digital audio.

### Aspect ratio

The width of a TV screen relative to its height. Conventional TVs are 4:3 (i.e., the screen is almost square). Widescreen models are 16:9 (the screen is almost twice as wide as its height).

### Chapter

Just as a book is split up into several chapters, a title on a DVD disc is usually divided into chapters. See also Title.

### Component video output

Each signal of luminance(Y) and component (Pb/Cb, Pr/Cr) is independent to output so that you can experience picture colour as it is.

Also, due to compatibility with progressive video (625p/525p), you can experience higher-density picture than that in interlace (625i/525i).

### CPRM

#### (Content Protection for Recordable Media)

CPRM is a scrambling copy protection system for the protection of "copy-once" broadcast programmes (e.g. some satellite broadcasts).

### Digital audio

An indirect representation of sound using numbers. During recording, the sound is measured at discrete intervals (44,100 times a second for CD audio) by an analogue-to-digital converter, generating a stream of numbers. On playback, a digital-to-analogue converter generates an analogue signal based on these numbers. See also Sampling frequency and Analogue audio.

### Dolby Digital

A system developed by Dolby Laboratories that compresses digital sound. It works with stereo (2ch) or multi-channel audio.

### DTS

#### (Digital Theater System)

DTS is a multi channel surround sound system. By connecting to DTS decoder, you can enjoy dynamic and realistic sound like movie theatre. DTS surround sound technologies were developed by DTS, Inc.

### Finalise

To make DVDs that have been recorded playable in DVD players. It is possible to finalise DVD-RW/-R and DVD+RW/+R discs with this unit.

### INSTANT SKIP

This unit can skip TV commercials during DVD Video playback. Once [INSTANT SKIP] is pressed, the start point will be set forward 30 seconds and playback resume automatically. (You can press [INSTANT SKIP] up to 6 times.)

### JPEG

#### (Joint Photographic Experts Group)

JPEG is a method of compressing still image files. You can copy JPEG files on CD-RW/-R discs from a computer and play back the files on this unit.

### MP3

#### (MPEG Audio Layer 3)

MP3 is a method of compressing files. You can copy MP3 files on CD-RW/-R discs from a computer and play back the files on this unit.

### PBC (Video CD only)

#### (Playback Control)

This function enables you to play back interactive software using a menu screen. See also Title.

### PCM

#### (Pulse Code Modulation)

PCM is a format that converts audio into digital data. It is mainly used for Audio CDs and DAT. This unit can play back sounds as realistic as possible by converting even compressed Dolby Digital and MPEG audio to PCM.

### Playlist

From this list, you can play back contents of a disc in your desired order or in sequence. It is also possible to directly search for a specific scene.

### Progressive Scan (625p/525p)

A type of display that does not split each frame into fields, and instead scans directly through all the scanlines of each frame in order. Progressive Scan provides less flickering and higher image resolution than traditional (625i/525i) TV signals. Refer to pages 19 and 69 for instructions on the Progressive Scan mode selection.

### Region code

Regions associate discs and players with particular areas of the world. This unit will only play back discs that have compatible region codes. You can find the region code of your unit by looking on the rear panel. Some discs are compatible with more than one region (or all regions).

### Sampling frequency

The rate at which sound is measured by a specified interval to turn it into digital audio data. The number of samples in one second is defined as the sampling frequency. The higher the rate is, the better the possible sound quality.

### S-Video output

Video is output as the individual signals of colour(C) and luminance(Y), so a higher-quality picture will be displayed.

### Title

#### (DVD)

A collection of chapters on a DVD. See also chapter.

### (Video CD)

The contents of a Video CD. When playing back a Video CD with the PBC function, the Title menu will appear automatically.

### Track

Audio CDs and Video CDs use tracks to divide the contents of a disc. The DVD equivalent is called a chapter. See also Chapter.

### Video mode

Video mode is the same recording format as used on the DVD-Videos you purchase in local shops. You can play back the discs recorded in this format in most DVD players, however it offers only limited editing. You will need to finalise discs recorded in Video mode before playing them back on other unit.

### VR mode

A basic recording format for DVD-RW. VR mode offers advanced editing, and you can record and edit material repeatedly, however it is playable only on VR mode compatible unit. Finalisation is recommended before playing them back on other unit.

### +VR mode

A recording format for DVD+RW/+R. +VR mode offers basic editing, and it is playable on most DVD players. Finalisation is recommended before playing them back on other unit.



## Specifications

### General

System	DVD-Video, DVD-RW/-R, DVD+RW/+R, CD-DA, CD-RW/-R, Video Cassette Tape
VCR video heads	Four heads
Power requirements	220–240 V ~ ± 10%, 50 Hz ± 0.5%
Power consumption	35 W (standby: 5.0 W)
Weight	4.3 kg
Dimensions (width x height x depth)	435 x 99.5 x 260 mm
Operating temperature	5°C to 40°C
Operating humidity	Less than 80% (no condensation)
TV format	PAL-I

### Recording

Recording format	Video Recording (VR) format (DVD-RW only), Video format (DVD-RW, DVD-R) +VR format (DVD+RW, DVD+R)
Recordable discs	DVD-ReWritable, DVD-Recordable, DVD+ReWritable, DVD+Recordable
<b>Video recording format</b>	
Sampling frequency	13.5 MHz
Compression format	MPEG
<b>Audio recording format</b>	
Sampling frequency	48 kHz
Compression format	Dolby Digital

### Tuner

Receiveable channels	IRA-E69
----------------------	---------

### Input/Output

#### Front Panel : (AV3)

Video input Input level	One RCA connector 1Vp-p (75 Ω)
S-Video input Input level	One Mini DIN 4-pin jack Y (luminance) 1Vp-p (75 Ω) C (colour) 300mVp-p (75 Ω)
Audio input Input level	Two RCA connectors 2Vrms (input impedance: more than 10kΩ)

#### Rear Panel :

VHF/UHF antenna input/output terminal	VHF/UHF set 75 Ω
Audio input /output	Two 21-pin scart sockets (AV1, AV2)
Video input /output Input /output level	Two 21-pin scart sockets (AV1, AV2) 1Vp-p (75 Ω) each
S-Video output Input /output level	One Mini DIN 4-pin jacks Y (luminance) 1Vp-p (75 Ω) C (colour) 300mVp-p (75 Ω)
Component video output Output level	Three RCA connectors Y: 1.0Vp-p (75 Ω) PB/CB, PR/CR: 0.7Vp-p (75 Ω) each
Audio output Output level	Two RCA connectors 2Vrms (output impedance: 680 Ω)
Digital audio output Output level	One Coaxial pin jack 500mVp-p (75 Ω)

### Note

The specifications and design of this product are subject to change without notice.

Introduction

Connections

Basic Setup

Recording

Playback

Editing

Function Setup

VCR Functions

Others



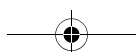

## Free Manuals Download Website

<http://myh66.com>

<http://usermanuals.us>

<http://www.somanuals.com>

<http://www.4manuals.cc>

<http://www.manual-lib.com>

<http://www.404manual.com>

<http://www.luxmanual.com>

<http://aubethermostatmanual.com>

Golf course search by state

<http://golfingnear.com>

Email search by domain

<http://emailbydomain.com>

Auto manuals search

<http://auto.somanuals.com>

TV manuals search

<http://tv.somanuals.com>