

INSTRUCTION MANUAL

INSTALLATION - OPERATION - MAINTENANCE

HV6AS Vacuum Circuit Breakers – Fixed Type 4.8 & 7.2kV Voltage Classes

APPLICABLE MODEL NUMBERS:

(Manual Operation Types)

HV6AS-U
HV6AS-L

(Motor Operation Types)

HV6AS-MU
HV6AS-ML

Issued: 2/2000
Supercedes First Issue Dated 2/99.

INSTRUCTION MANUAL

For the Installation, Operation and Maintenance of

HV6AS Vacuum Circuit Breakers – Fixed Type 4.8 & 7.2kV Voltage Classes



Never attempt to install, operate, maintain or dispose of this equipment until you have first read and understood all of the relevant product warnings and user directions that are contained in this Instruction Manual.

To contact Toshiba, address all correspondence to:

Field Service Department
Toshiba International Corporation
13131 West Little York Road
Houston, Texas 77041 USA

or call:

(713) 466-0277
(800) 231-1412
(800) 527-1204 (Canada)

Fax: (713) 466-8773

Please complete the following information for your records and retain with this manual:

Model: _____

Serial Number: _____

Date of Installation: _____

Inspected by: _____

Reference Number: _____

© TOSHIBA INTERNATIONAL CORPORATION, 2000

IMPORTANT MESSAGES

Read this manual and follow its instructions. Signal words such as DANGER, WARNING and CAUTION will be followed by important safety information that must be carefully reviewed.

 DANGER

Indicates a situation which will result in death, serious injury, and severe property damage if you do not follow instructions.

 WARNING

Means that you might be seriously injured or killed if you do not follow instructions. Severe property damage might also occur.

 CAUTION

Means that you might be injured if you do not follow instructions. Equipment damage might also occur.

NOTE

Gives you helpful information

READ SAFETY SIGNS

To avoid injury, you must read and follow all safety signs.

Keep the safety signs visible and in good shape. Never remove or cover any safety signs.

QUALIFIED OPERATORS ONLY

Only qualified persons are to install, operate, or service this equipment according to all applicable codes and established safety practices.

A qualified person must:

- 1) **Carefully read the entire instruction manual.**
- 2) Be skilled in the installation, construction or operation of the equipment and aware of the hazards involved.
- 3) Be trained and authorized to safely energize, deenergize, clear, ground, lockout and tag circuits in accordance with established safety practices.
- 4) Be trained and authorized to perform the service, maintenance or repair of this equipment.
- 5) Be trained in the proper care and use of protective equipment such as rubber gloves, hard hat, safety glasses, face shield, flash clothing, etc. in accordance with established practices.
- 6) Be trained in rendering first aid.

SAFETY CODES

Toshiba HV6AS vacuum circuit breakers are designed and built in accordance with JIS C 4603-1990 and JEC-2300-1985. Installations must comply with all applicable state and local codes, adhere to all applicable National Electric Code (NFPA 70) standards and instructions provided in this manual.

⚠ DANGER

HAZARDOUS VOLTAGE will cause severe injury, death, fire, explosion and property damage.

- Turn off and lock out Primary and Control Circuit Power before servicing.
- Keep all panels and covers securely in place.
- Never Defeat, Modify, or Bypass any Safety Interlocks
- Qualified Operators only

INTRODUCTION	6
GENERAL DESCRIPTION	7
Components	7
Indicators and Controls	8
RECEIVING, INSPECTION AND HANDLING	9
Receiving and Unpacking	9
Acceptance Inspection	9
Handling and Moving	10
INSTALLATION	11
Rating Verification	11
Mounting the Circuit Breaker to a Panel	12
Mounting Directly to a Shelf	14
Main Circuit Cable Connections	15
Ground Connections	16
Control Circuit Connections	17
Additional Auxiliary Switch	17
PRE-ENERGIZATION CHECK	18
General	18
Electrical Checks	18
OPERATION	19
Manual Operation	19
Electrical Operation	19
Undervoltage Trip	24
MAINTENANCE	25
Maintenance Program	25
Maintenance Record	25
Servicing Equipment	25
Inspection and Maintenance Types	26
Table 1. Tightening Torques	26
Table 2. Check Points for Periodic Inspection	27
Vacuum Check	29
DISPOSAL	31
STORAGE	32
Storage	32

Inspection During Storage.....	32
SPECIFICATIONS	33
Table 3. Ratings – Manual Operation HV6AS-U and HV6AS-L Types	33
Table 4. Ratings – Motor Operation HV6AS-MU and HV6AS-MU Types	33
WARRANTY AND LIMITATION OF LIABILITY	34

It is the intent of this manual to provide a guide for **safely** installing, operating and maintaining Toshiba vacuum circuit breakers. This manual consists of a section of general safety instructions and is marked throughout with warning symbols. Read this manual thoroughly before installation, operation and maintenance of this equipment.

This manual and all accompanying drawings should be considered a permanent part of the equipment. They should be readily available for review and reference at all times. This manual is not intended to cover all details, combinations, or variations of the equipment. Always refer to drawings accompanying the equipment for additional details.

All safety warnings must be followed to ensure personal safety. General safety instructions are found on pages 1 through 3. Read and save these instructions for future reference.

Follow all precautions to attain proper equipment performance and longevity.

Dimensions shown in the manual are in metric and/or their English equivalent.

This manual is divided into major sections of interest, as follows:

GENERAL DESCRIPTION – Provides a description of the equipment, information on major components and how they function, plus rating information.

RECEIVING, INSPECTION AND HANDLING – Describes procedures for receiving, unpacking, inspecting, handling, lifting and moving the circuit breaker.

INSTALLATION – Provides information on installing the circuit breaker in the switchgear cell along with breaker racking procedures.

PRE-ENERGIZATION CHECK – Provides a checklist for preparing the equipment for energization.

OPERATION – Provides information on manual and electrical operation of the circuit breaker, circuit diagrams, operating sequence description and operation of circuit breaker optional accessories.

MAINTENANCE – Lists the basic maintenance procedures for this equipment necessary for safe and reliable operation.

DISPOSAL – Lists procedures for the safe disposal of the equipment when the service life has expired.

STORAGE – Provides guidelines for storing new equipment for an extended period of time.

SPECIFICATIONS – Covers ratings and other specifications of the circuit breaker.

WARRANTY AND LIMITATION OF LIABILITY – Details Toshiba International Corporation's standard warranty terms.

The Toshiba HV6AS vacuum circuit breakers described in this manual are suitable for use on systems of 4.8kV and 7.2kV voltage classes which require interrupting ratings of 16kA and 14kA respectively and a continuous current rating of 630A. The circuit breakers are intended for use in limited applications requiring small physical size and low maintenance.

These breakers are designed for fixed panel mounting and are available with upper main circuit terminals (U, MU types) or rear terminals (L, ML types).

The breakers are available as both manual and motor-operated types. Motor-operated breakers use a motor to charge the closing springs and to close the breaker upon command. Both types can be tripped electrically and also include undervoltage release.

Arc interruption is accomplished inside sealed vacuum interrupters mounted on track-resistant insulators. Vacuum interrupters use low-surge contact materials which exhibit low current chopping levels reducing switching overvoltages.

Fig. 1 and Fig. 2 illustrate and identify the major components of the circuit breakers.

COMPONENTS LEGEND:

- 1) Manual closing handle
- 2) Manual trip lever
- 3) On-Off indicator
- 4) Spring charge indicator (MU and ML only)
- 5) Operations counter
- 6) Secondary control circuit terminal block
- 7) Main circuit terminals
- 8) Auxiliary switch
- 9) Grounding terminal

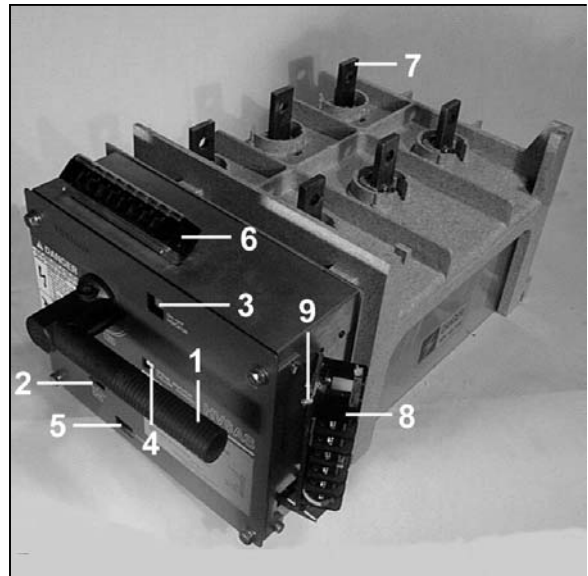

Fig. 1 U and MU Type Circuit Breaker (Upper Main Circuit Terminals)

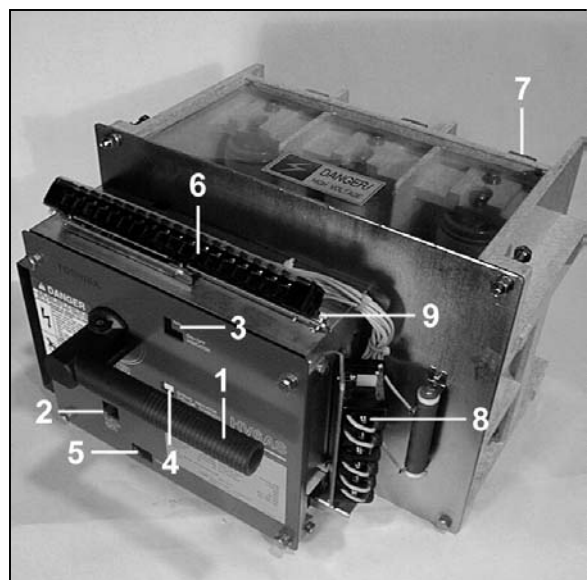

Fig. 2 L and ML Type Circuit Breaker (Rear Main Circuit Terminals)

SAFETY DEVICES

Safety interlocks and guards are provided as an integral part of the equipment design. These devices are provided for safety to the operator.

⚠ DANGER

Never defeat, modify or bypass any safety devices, interlocks or operating mechanism. This would make the equipment unsafe. Fire, explosion, severe injury, death and property damage could occur.

⚠ WARNING

Do not operate this equipment unless all covers and panels are in place.

- 5) Operations Counter - Indicates the total accumulated number of times the circuit breaker has been closed.

INDICATORS AND CONTROLS (Fig. 3)

The following front panel indicators and controls are provided:

- 1) On-Off Indicator - Indicates if the circuit breaker is OFF (Green) or ON (Red). When the indicator reads OFF, the main contacts of the circuit breaker are open. When the indication is ON, the main contacts are closed.
- 2) Closing Spring Status Indicator (MU, ML types only) - Indicates if the closing springs are CHARGED (Yellow) or DISCHARGED (White).
- 3) Manual Closing Handle – Rotating the handle clockwise approximately 75° closes the circuit breaker (On-Off indicator changes to ON). When the handle is released, it returns to its normal position.
- 4) Manual Trip Lever (Red) – Pushing the lever in the direction of the arrow trips the circuit breaker (On-Off indicator changes to OFF).

Fig. 3 Indicators and Controls

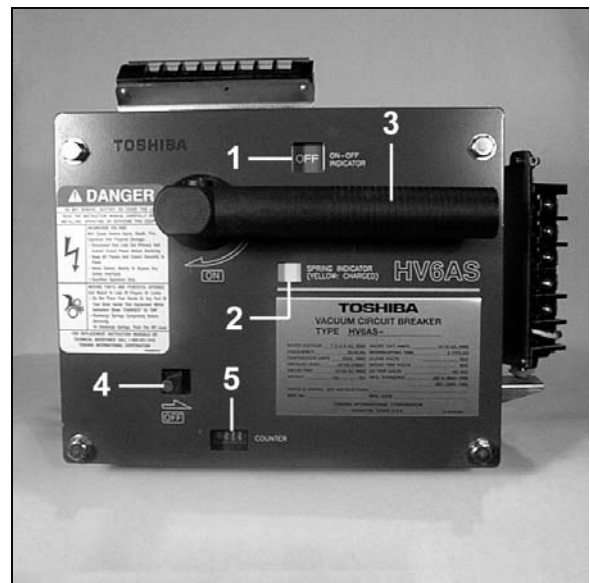

RECEIVING AND UNPACKING

The circuit breaker units are subjected to factory production testing prior to being packed and shipped.

ACCEPTANCE INSPECTION

Confirm that the circuit breaker unit is complete, correct as specified and undamaged from shipment and handling.

Upon receipt of the equipment, do the following:

- 1) Make an immediate inspection for damage which might have occurred during shipment. If damage is discovered, it should be noted with the carrier prior to accepting the shipment, if possible.
- 2) Carefully unpack the equipment sufficiently to check for missing parts or concealed damage.
- 3) Check for the presence of accessories that are shipped with the circuit breaker:
 - Closing Handle (shipped loose with MU and ML type breakers) (Fig. 4)
 - Insulating cylinders (qty-6) (Fig. 5)
- 3) Keep the circuit breaker upright.

CAUTION

Never lay the circuit breaker on its side or upside down. This may cause damage.

- 4) File a claim with the carrier for any damaged or missing items and immediately notify the nearest Toshiba representative.

WARNING

Do not install or energize equipment that has been damaged. Damaged equipment can fail during operation, resulting in fire and explosion.

Fig. 4 Closing Handle



Fig. 5 Insulating Cylinder

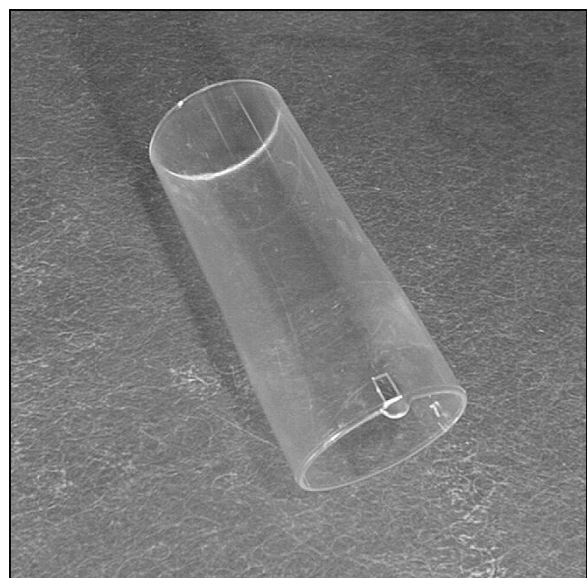

HANDLING AND MOVING

When handling and moving the circuit breaker, the techniques shown in this section may be used.

Care and caution should be used when handling the circuit breaker units to avoid damage to the equipment and personal injury. Always keep the circuit breaker in a generally upright position.

Refer to Fig. 6 and Fig. 7 for the correct methods of lifting and moving the circuit breakers.

Fig. 6 Correct Method for Handling the U and

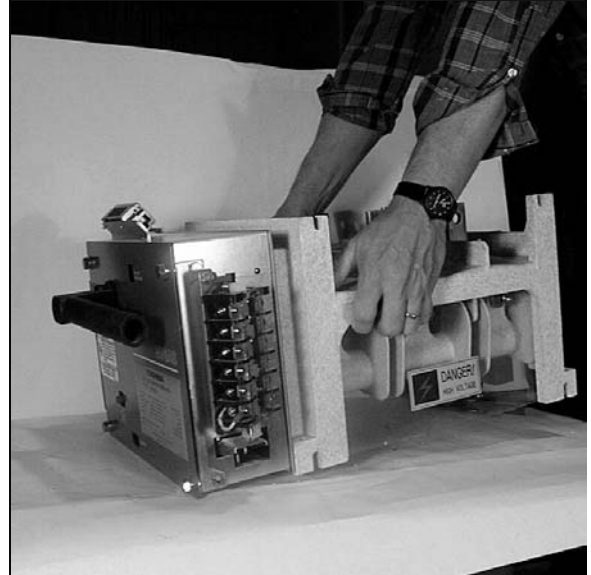

MU Type Circuit Breakers

Fig. 7 Correct Method for Handling the L and

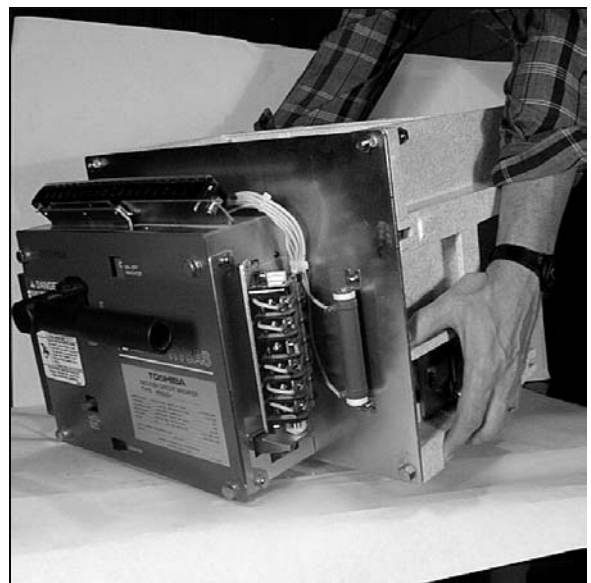

ML Type Circuit Breakers

⚠ WARNING

Do not install this equipment in areas where unusual service conditions exist. Using this equipment in other than usual service conditions can result in equipment failure.

Toshiba HV6AS circuit breakers are intended for use in usual service conditions as defined in IEEE C37.20.2. The temperature of the cooling air (ambient air temperature) surrounding the breaker should be between the limits of -5°C (23°F) and +40°C (104°F). The altitude of the equipment installation should not exceed 3300 ft (1000 m).

In particular, avoid the following installation conditions:

- Excessive dust
- Corrosive gases
- Extreme variations in temperature
- Very high or low humidity
- Vibrations
- Inclined locations

If there is a chance that condensation can occur

at the installation location, a space heater should be installed inside the circuit breaker enclosure.

NOTE: Temperature, altitude or other conditions outside of the usual limits may require derating or other special equipment. Contact your nearest Toshiba representative for additional information.

RATING VERIFICATION

Prior to Installation, the maximum fault current capacity of the power system at the point of installation should be verified. This value must not exceed the symmetrical interrupting capability of the circuit breaker. Fig. 8 illustrates a typical circuit breaker nameplate.

⚠ DANGER

Do not exceed the ratings specified on the circuit breaker nameplate or system accessories. Underrated equipment can fail during operation causing fire, explosion, severe injury, death, and property damage.

Fig. 8 Typical Circuit Breaker Nameplate

TOSHIBA
VACUUM CIRCUIT BREAKER
TYPE HV6AS-MU-VV

RATED VOLTAGE <u>7.2/4.8 kV, RMS</u>	SHORT CKT. AMPS <u>14/16 kA, RMS</u>
FREQUENCY <u>50/60 Hz</u>	INTERRUPTING TIME <u>3 CYCLES</u>
CONTINUOUS AMPS <u>630A, RMS</u>	CLOSE VOLTS <u>120 VAC / 125 VDC</u>
IMPULSE LEVEL <u>60 kV, CREST</u>	SHUNT TRIP VOLTS <u>125 VDC</u>
DIELECTRIC <u>22 kV AC RMS</u>	UV TRIP VOLTS <u>120 VAC</u>
WEIGHT <u>24 kg 53 lbs</u>	MFG. STANDARD <u>JIS C 4603-1990</u> <u>JEC-2300-1985</u>

PARTS & WIRING, SEE INSTRUCTIONS GF07Z301

SER. No. 98700221 **MFG. DATE** 7/98

TOSHIBA INTERNATIONAL CORPORATION
HOUSTON, TEXAS U.S.A.

MOUNTING THE CIRCUIT BREAKER TO A PANEL

The circuit breakers are designed to mount to a panel made from 11 ga. (.12 in.) thick steel. If the breaker must be mounted to a panel of different thickness, contact Toshiba.

Panel cutout dimensions for the circuit breakers are given in Fig. 12. One cutout size is used for all breaker types.

To mount the circuit breaker, follow the steps below:

1. Loosen the small screw (M5) on the closing handle and remove the handle.
2. Remove the four front plate mounting bolts (M8) from the circuit breaker (Fig. 9). Remove the spacer washers between the front plate and breaker and discard them (make sure none are left inside the breaker),
3. Align the breaker with the cutout and mounting holes on the panel to which it is to be mounted (Fig. 10). Some breakers are furnished with two hooks which may be used to temporarily attach the breaker to the panel.
4. Using the four M8 bolts removed in step 2, fasten the breaker and its front plate to the mounting panel (Fig. 11). The tightening torque should be 120-150 kgf-cm (9-11 ft-lb).
5. Replace the closing handle removed in step 1 and the M5 screw. The screw should be tightened to a torque of 40-50 kgf-cm (35-43 in-lb).

Fig. 10 Align Breaker With Panel Cutout



Fig. 11 Fasten Breaker and Front Plate to

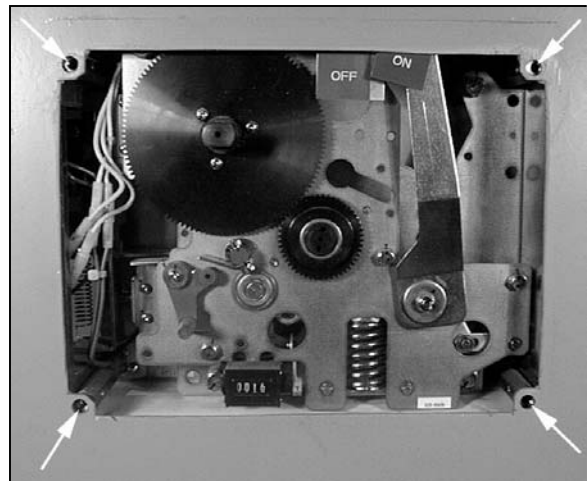

Panel



Fig. 9 Remove Front Plate and Spacer Washers

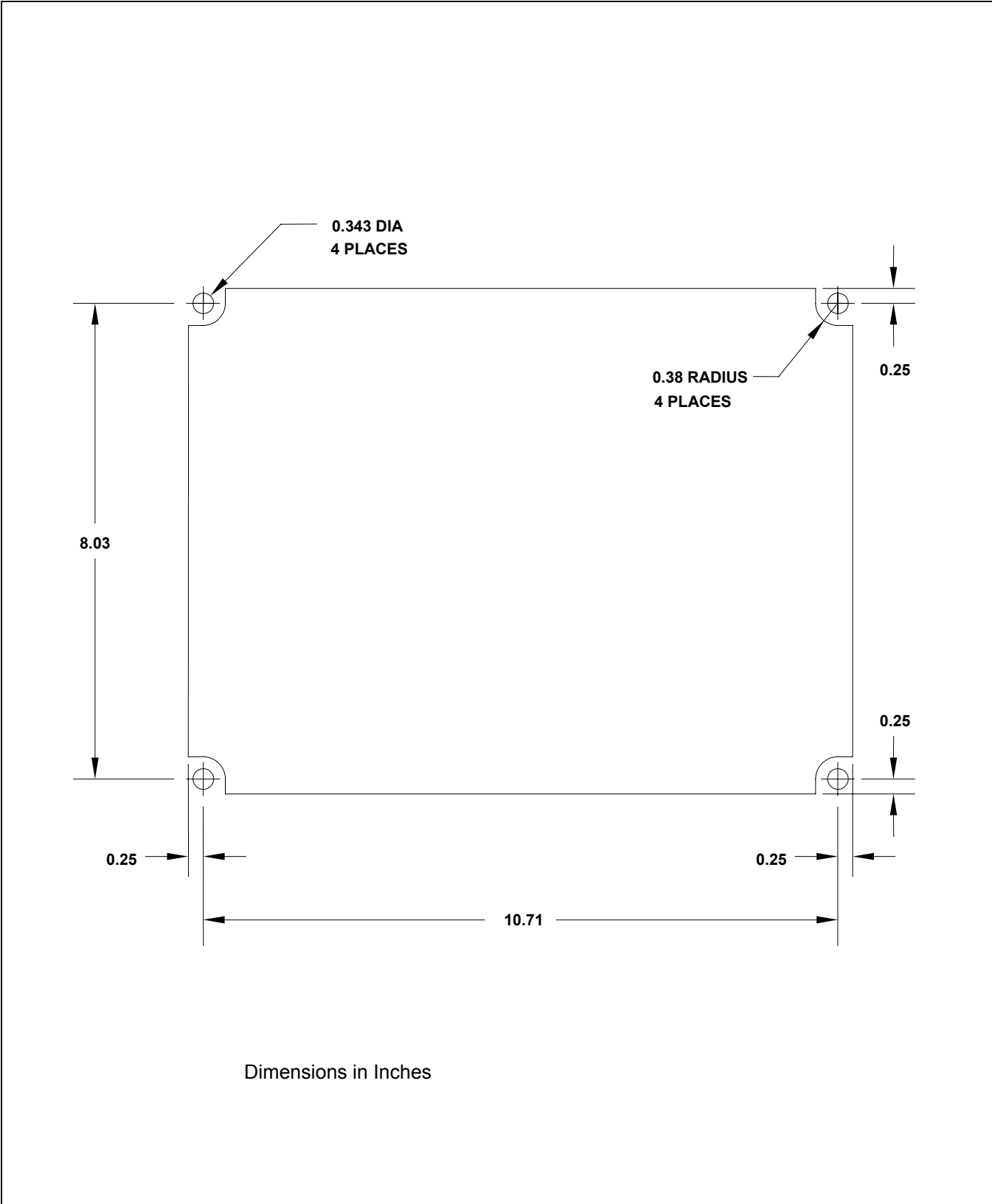

Fig. 12 Panel Cutout Dimensions

MOUNTING DIRECTLY TO A SHELF

The shelf should be flat and level within ± 0.5 mm (± 0.02 in.). If there are any noticeable gaps between the breaker and the shelf, fill them in using flat washers as spacers.

Check to make sure the breaker On-Off indicator shows OFF (green), then mount it by following the steps below:

1. Fasten the breaker onto steel angles or to a flat plate (Fig. 13). Use M8 hex head bolts (either 50 mm or 35 mm). The tightening torque should be 120-150 kgf-cm (9-11 ft-lb).
2. Either mounting method shown in (Fig. 14) may be used.

Fig. 13 Mounting Breaker to Flat Plate or Angles

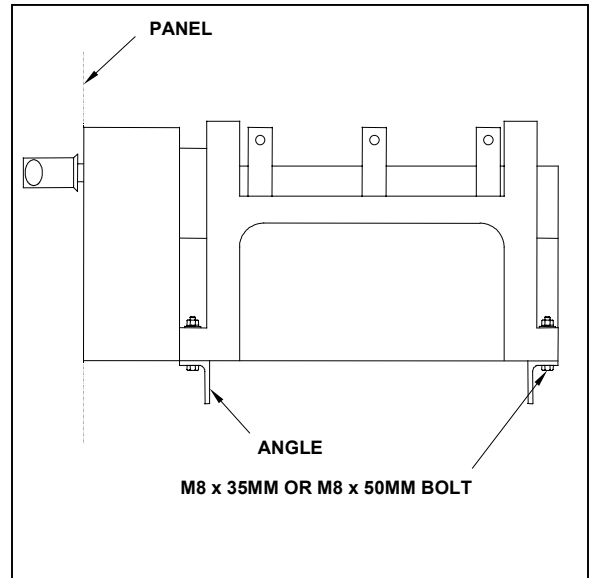
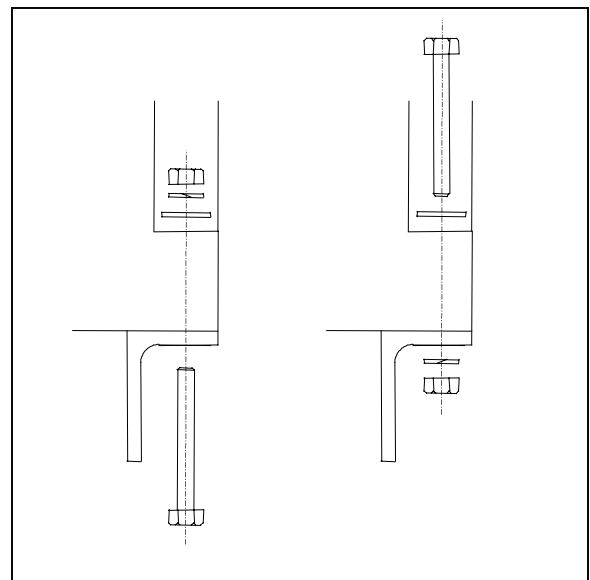

Fig. 14 Optional Hardware Orientation



MAIN CIRCUIT CABLE CONNECTIONS

Cables which connect to the circuit breaker should be routed to avoid interference with sharp edges and moving parts. Minimum bending radius for the type of cable used should be observed.

Power cables should be braced and/or laced to withstand short-circuit forces wherever such cables are unsupported. Power cables should be adequately sized to carry the maximum continuous current in accordance with NEC requirements and should have an adequate voltage rating. Cables should be dressed and terminated as appropriate to the voltage class and cable manufacturer's recommendations. When terminating shielded cables, use termination kits appropriate for the system voltage to taper the insulation and reduce electrical stress. Follow the manufacturer's installation instructions provided with the termination kit.

To connect cables, follow the steps below:

1. Pass the cable through the insulating cylinder (six cylinders are supplied with the circuit breaker) (Fig. 15).
2. Fasten the cable to the main circuit terminal (Fig. 16). Use 35 mm Class 8.8 M10 or M12 hex head bolts, 2 flat washers, a lock washer and a nut. While securely preventing the bolt from rotating with a wrench, torque the nut to 250-315 kgf-cm (18-23 ft-lb) for M10 bolts or 450-565 kgf-cm (32-41 ft-lb) for M12 bolts.

CAUTION

Use two wrenches to torque the connection to prevent applying excessive force to the terminal which can damage the frame.

3. Fasten the insulating cylinder in place, then check to make sure that the hook is engaged (Fig. 17).

Fig. 15 Pass Cable Through Insulating

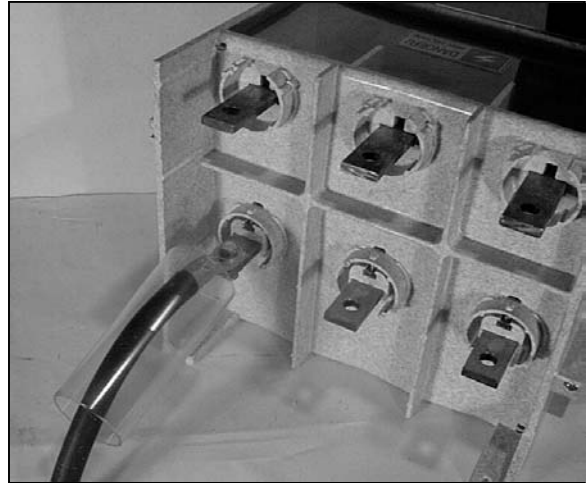

Cylinder

Fig. 16 Fasten Cable to Main Circuit



Terminal

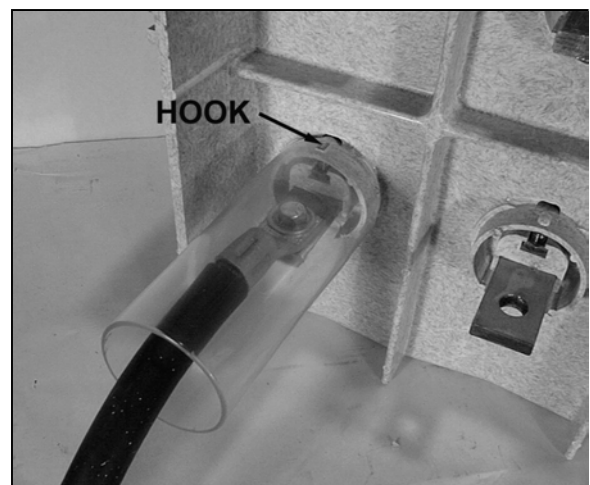

Fig. 17 Fasten Insulating Cylinder

GROUND CONNECTIONS

The circuit breaker must be grounded in accordance with the requirements of the National Electrical Code, Article 250 or applicable local standards.

⚠WARNING

Proper grounding connections must be made to the circuit breaker before incoming power is applied.

It is very important that the circuit breaker and its enclosure be adequately grounded to protect the operator from injury in the event of short circuits or other abnormal occurrences and to ensure that the metal parts of the equipment, other than live parts, remain at ground potential.

For U and MU type circuit breakers, the ground terminal is on the left side of the operating mechanism as viewed from the rear of the breaker. To make the ground connection, first remove the fastening M6 hex head bolt and crimp-on terminal (provided with the breaker) and crimp the terminal to the end of the ground wire (Fig. 18). Then, reattach the terminal using the same bolt previously removed and torque to 50-65 kgf-cm (43-56 in-lb).

For L and ML type circuit breakers, the ground terminal is on the left side of the terminal block as viewed from the rear of the breaker (Fig. 19). The same instructions as for the U and MU breaker above should be followed to attach the ground wire.

Fig. 18 Ground Connection for U and MU Type Breakers

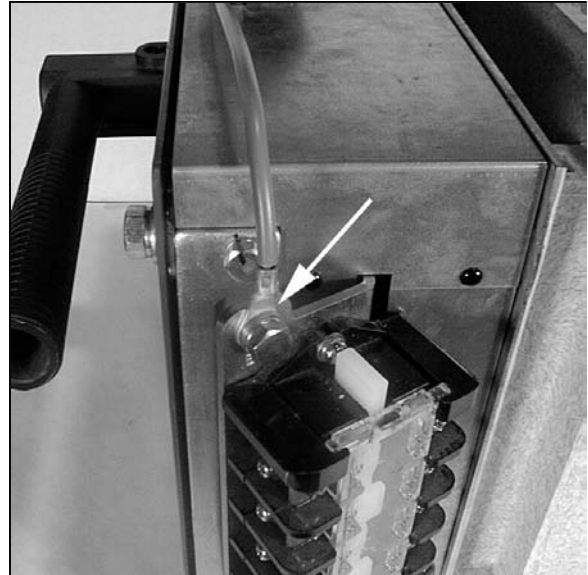
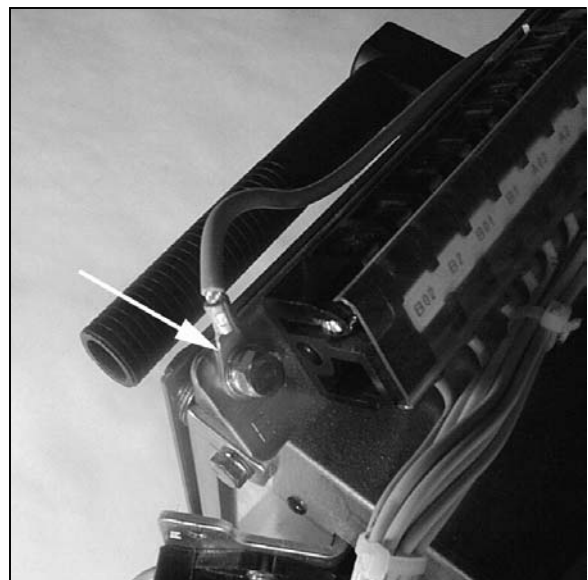

Fig. 19 Ground Connection for L and ML Type Breakers



CONTROL CIRCUIT CONNECTIONS

Control circuit wiring is connected to the terminal block on the top of the operating mechanism (Fig. 20). Connect control wires in accordance with the appropriate wiring diagram shown in Fig. 28 through Fig. 31 in the OPERATION section of this manual.

On the U and MU type breakers, connections to auxiliary contacts are made directly to the auxiliary switch (Fig. 21).

On the L and ML type breakers, connections to auxiliary contacts are made to a terminal block on top of the operating mechanism (Fig. 22).

ADDITIONAL AUXILIARY SWITCH (Optional)

An optional second auxiliary switch may be furnished, located on the right side as viewed from the rear of the breaker.

When a second auxiliary switch is furnished, control wires are connected directly to the switch.

Fig. 20 Connection to Control Terminal

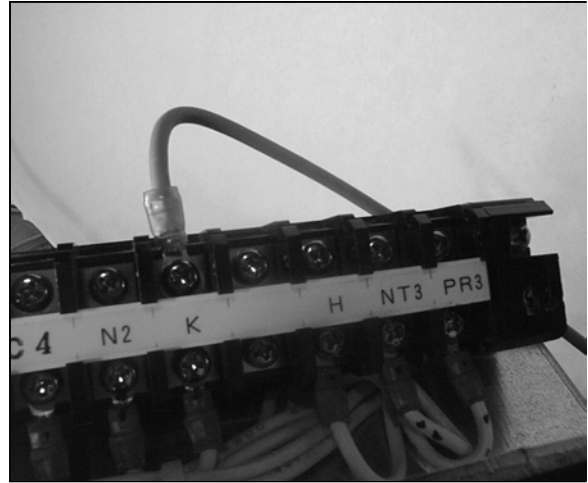

Block

Fig. 21 Auxiliary Contact Connections on U

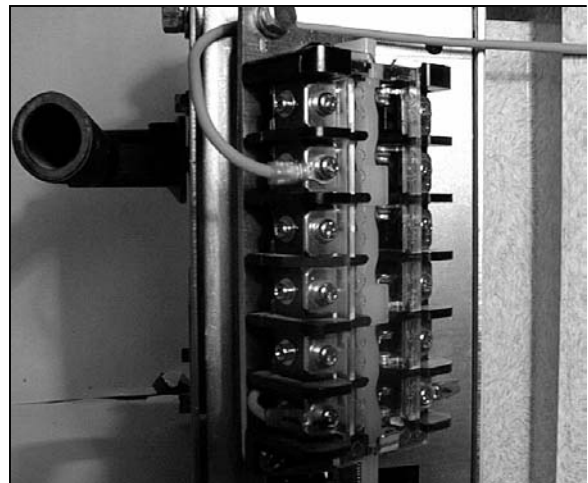

and MU Type Breakers

Fig. 22 Auxiliary Contact Connections on L

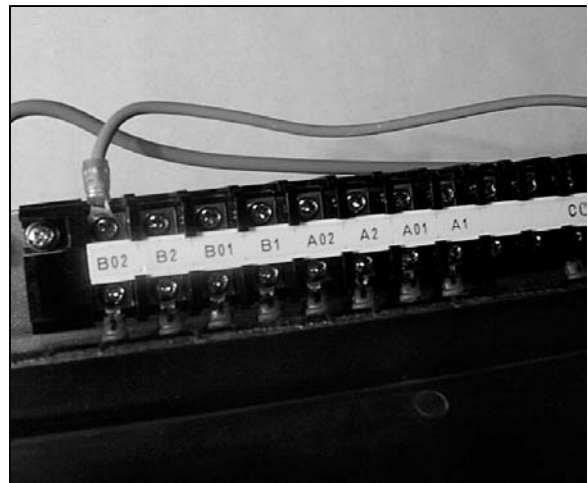

and ML Type Breakers

GENERAL

BEFORE ENERGIZING THE CIRCUIT BREAKER for the first time, follow the procedure below to verify that the equipment is properly installed and functional.

⚠ DANGER Hazardous Voltage. Turn off and lock out all primary and control circuit power sources prior to performing this pre-energization check.

⚠ WARNING Do not operate this equipment until a complete safety inspection has been made.

⚠ WARNING Do not energize damaged equipment that has not been repaired or verified.

⚠ WARNING Do not remove, cover or destroy any safety signs.

⚠ WARNING Do not operate this equipment until all panels and covers have been installed.

- All blocks or other temporary braces used for shipment must be removed.
- Before closing the enclosure, all metal chips, scrap wire and other debris left over from installation must be cleaned out.
- Cover all unused openings. Install all panels, guards and covers.
- A supply of spare parts should be established.
- Instruction manuals and diagrams should be collected and filed.

ELECTRICAL CHECKS

⚠ WARNING Electrical shock hazard. Do not touch energized components during a test using auxiliary power.

- An electrical insulation resistance test should be performed to verify that the circuit breaker and associated field wiring are free from short circuits and grounds. Refer to the MAINTENANCE Section of this manual for additional information.

⚠ WARNING Hazardous voltages are present during dielectric testing which can result in serious injury or death. High potential tests should be performed only by qualified personnel.

- The circuit breaker must be set to the OFF position before energizing incoming power.

MANUAL OPERATION

⚠WARNING

Powerful springs. Do not place your hands or any part of your body inside the circuit breaker while the indicators show **CHARGED** (yellow) or **ON** (red).

⚠CAUTION

To avoid damaging the mechanism, do not close the circuit breaker when the On-Off Indicator shows **ON** (red).

MANUAL CLOSING (Motor-Operated MU and ML Types):

1. Check to make sure that the On-Off indicator shows OFF (green).
2. Attach the closing handle to the breaker if it is not already attached.
3. If the closing spring status indicator shows DISCHARGED (white):

Turn the closing handle clockwise (Fig. 23). The breaker will close (On-Off indicator changes to ON) after the handle is turned approximately 75° (Fig. 24).

NOTE If the handle is turned in small increments, the closing spring will store the energy from the handle action and the circuit breaker will close before 75° of rotation.

If the closing spring status indicator shows CHARGED (yellow):

Turn the closing handle clockwise. The breaker will close after the handle is turned approximately 10°.

4. Release the handle, and it will return to its initial position.

Fig. 23 Preparing to Manually Close Breaker

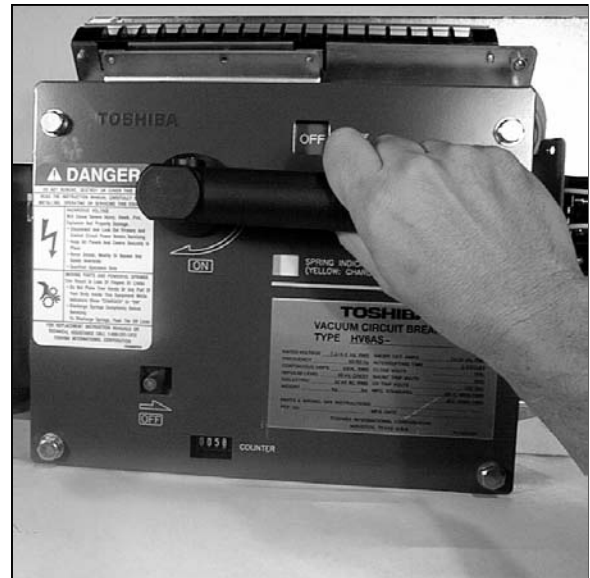

Fig. 24 Manually Closing Breaker



MANUAL CLOSING (Manual Spring-Operated U and L Types):

1. Check to make sure that the On-Off indicator shows OFF (green).
2. Turn the closing handle clockwise. The breaker will close (On-Off indicator changes to ON) after the handle is turned approximately 75°.

NOTE If the handle is turned in small increments, the closing spring will store the energy from the handle action and the circuit breaker will close before 75° of rotation.

3. Release the handle, and it will return to its initial position.

MANUAL OPENING (All Types):

1. Push the trip lever in the direction of the arrow (Fig. 25).
2. The On-Off indicator changes to OFF (green).

ELECTRICAL OPERATION

The flow chart shown in Fig. 27 illustrates the sequence of electrical operation of the MU and ML type circuit breakers.

Refer to Fig. 26 and the circuit breaker schematics shown in Fig. 28 through Fig. 31 for determining external control circuit connections to the circuit breaker.

Fig. 25 Manually Opening Breaker

SYMBOL	DESCRIPTION
M	Motor
TC	Voltage Trip Coil
UV	Undervoltage Trip Coil
a1 to a6	Auxiliary Contacts (N.O.)
b1 to b6	Auxiliary Contacts (N.C.)
X	Control Relay
X-a	Control Relay Contact (N.O.)
X-b	Control Relay Contact (N.C.)
Y	Auxiliary Relay
Y-a	Auxiliary Relay Contact (N.O.)
Y-b	Auxiliary Relay Contact (N.C.)
LS1 to LS3	Limit Switches
R1 to R4	Resistors
REC	Rectifier
D	Diode
C	Capacitor
SP	Surge Protector
RL	Red Lamp
GL	Green Lamp

Fig. 26 Legend for Schematics

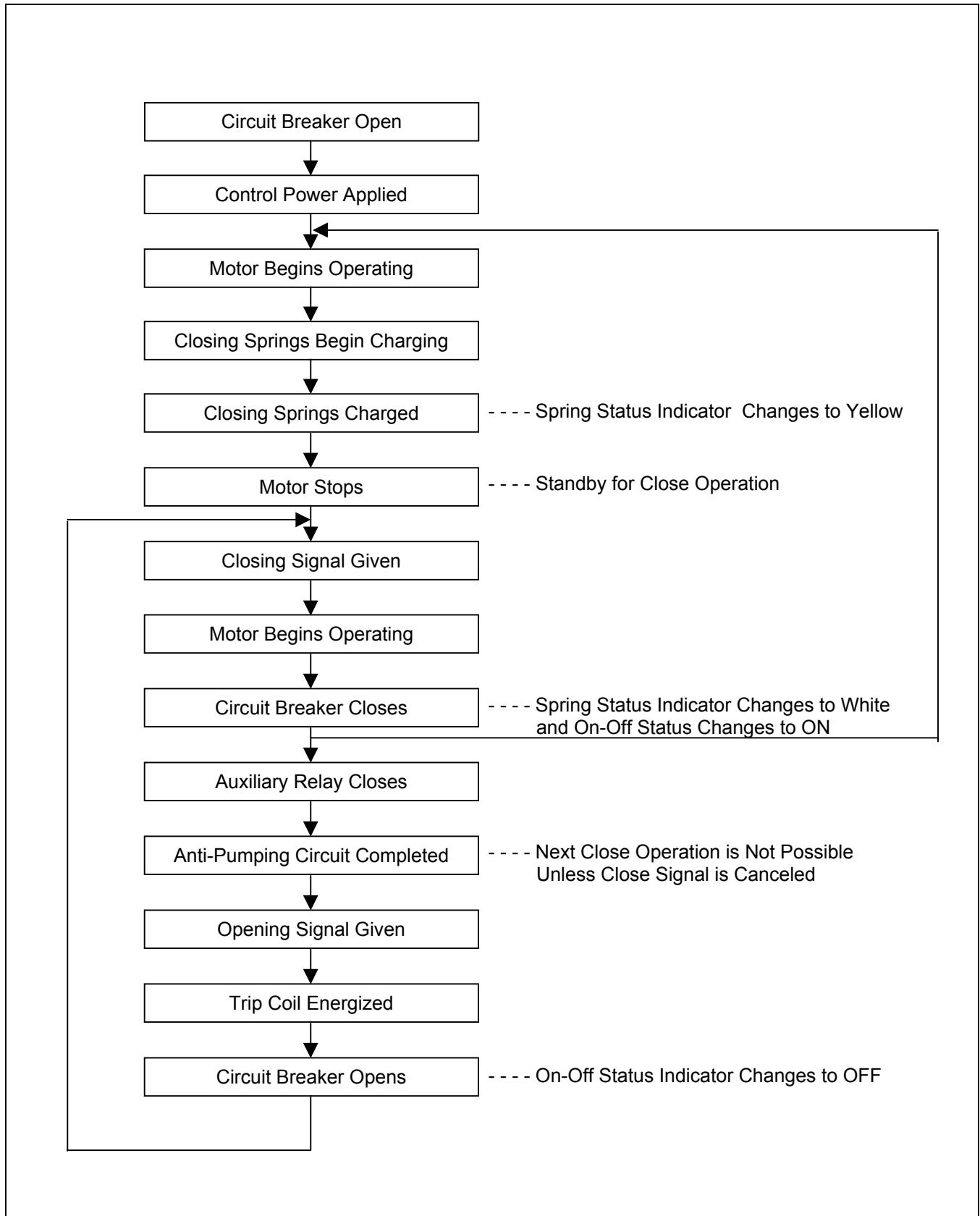

Fig. 27 Electrical Operation Flow Chart for MU and ML Type Breakers

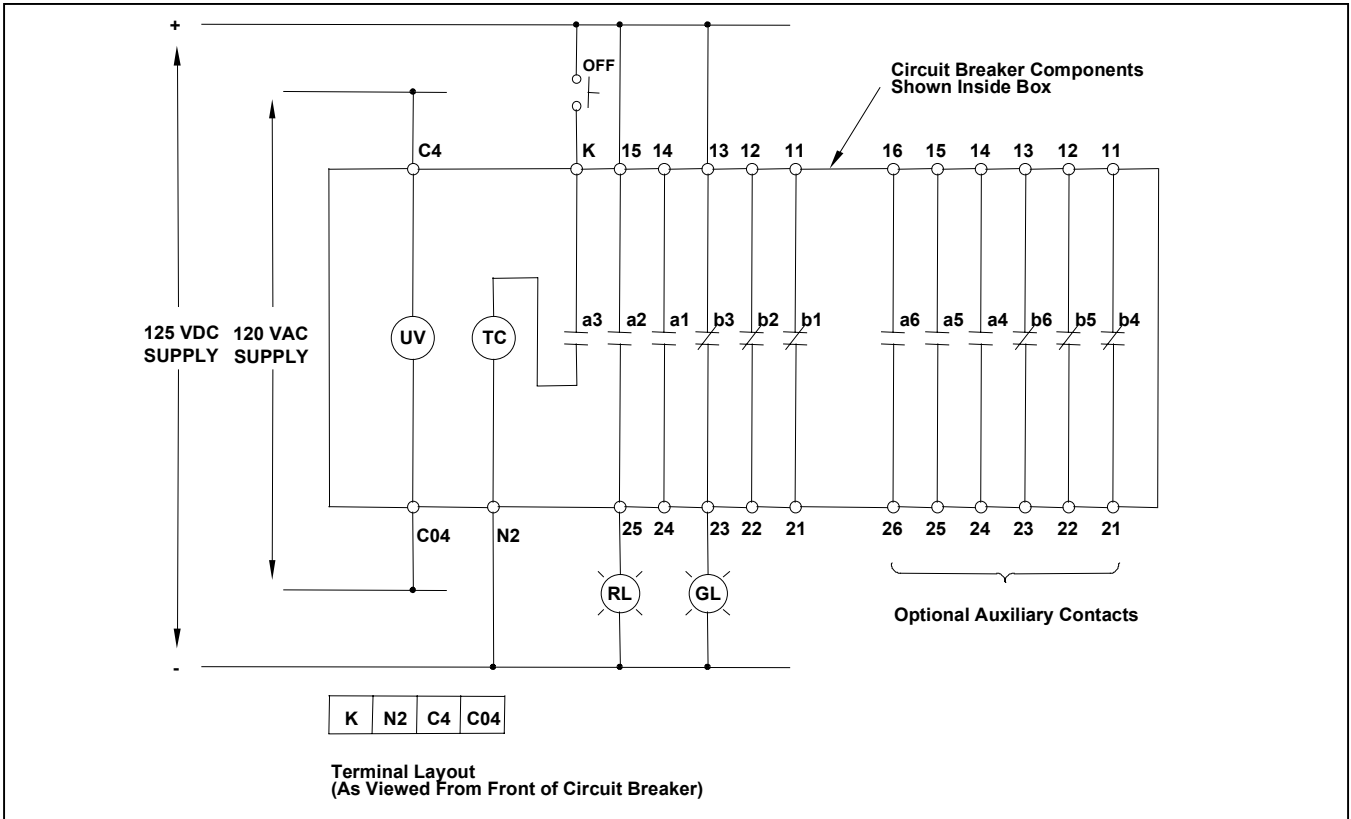
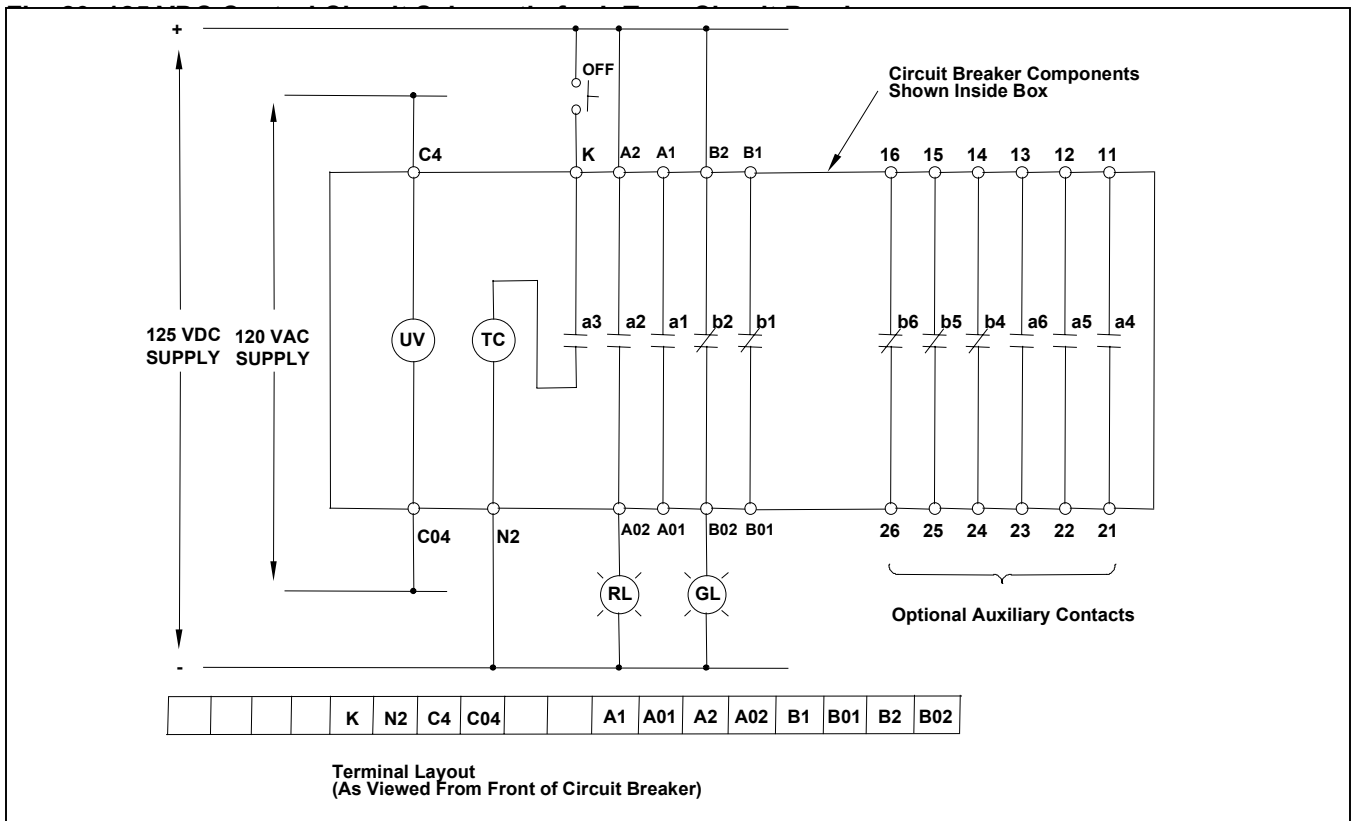
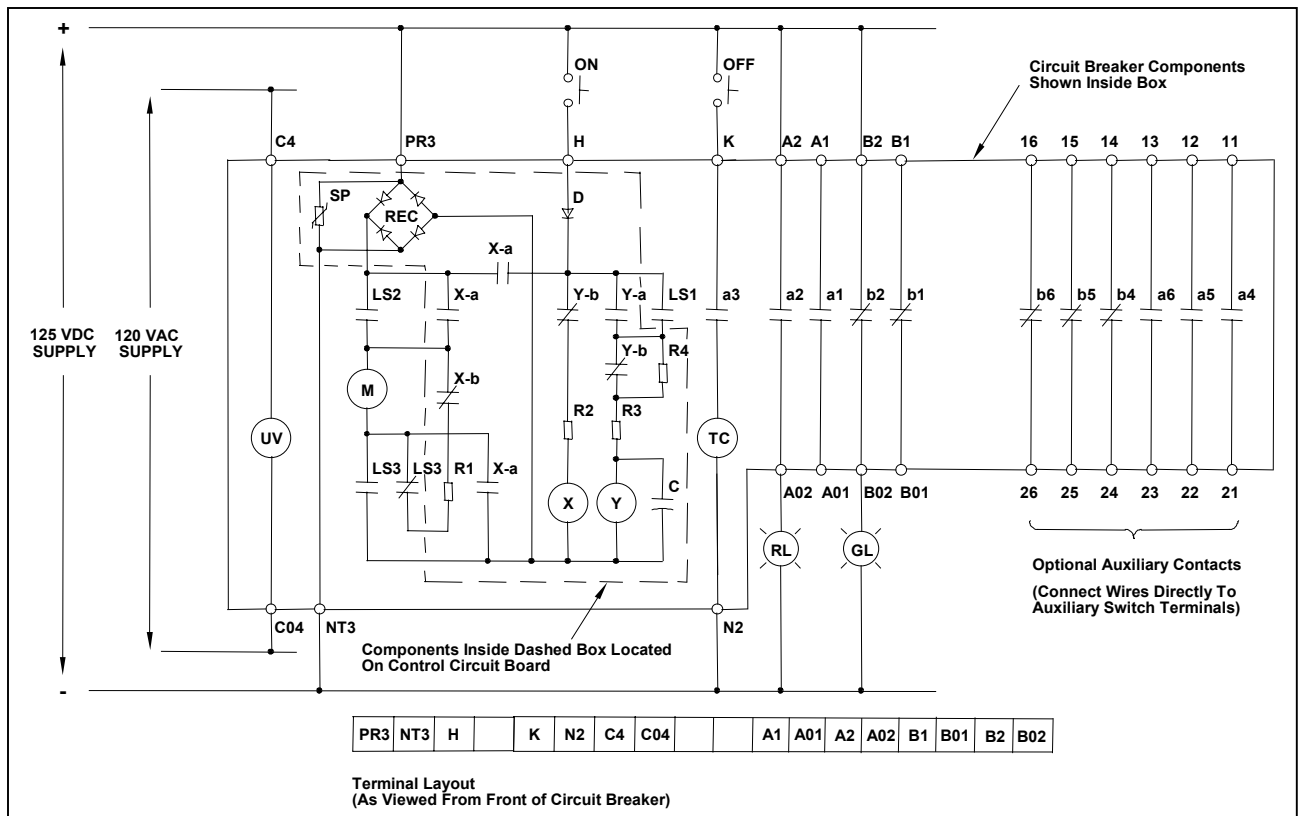
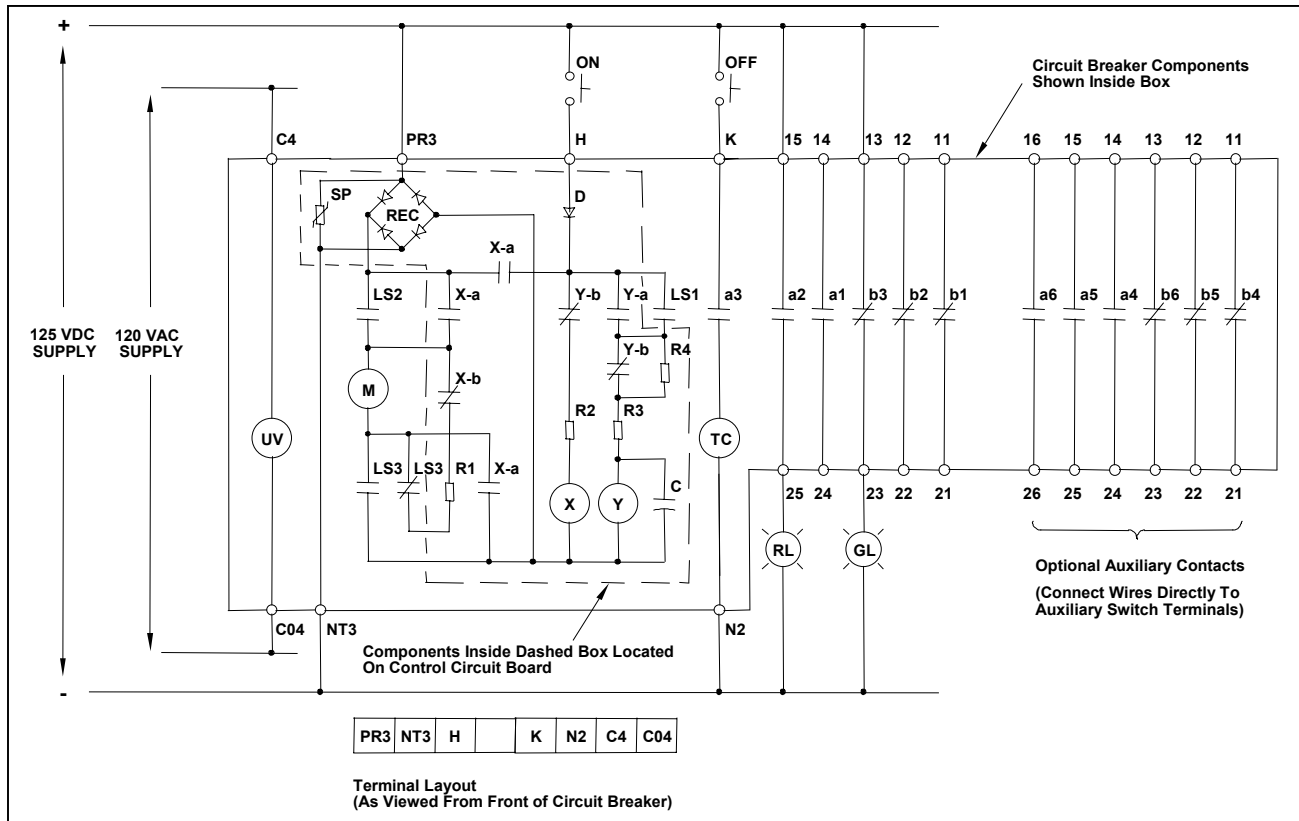

Fig. 28 125 VDC Control Circuit Schematic for U Type Circuit Breaker





UNDervOLTAGE TRIP

All HV6AS fixed mounted circuit breakers are furnished with an undervoltage trip device. The undervoltage trip device operates to trip the circuit breaker OFF unless 120VAC control power is present at the terminals of relay UV.

When the circuit breakers are shipped, the undervoltage trip device is defeated by a factory-installed plug (Fig. 32). If this plug is left in place, the circuit breaker will operate normally without power applied to relay UV. Removing this plug (Fig. 33) activates the undervoltage trip function.

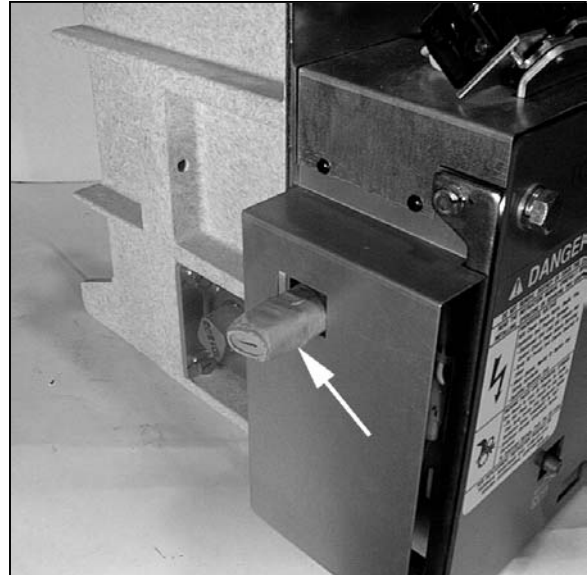

Fig. 33 Removing Plug From UV Trip Device

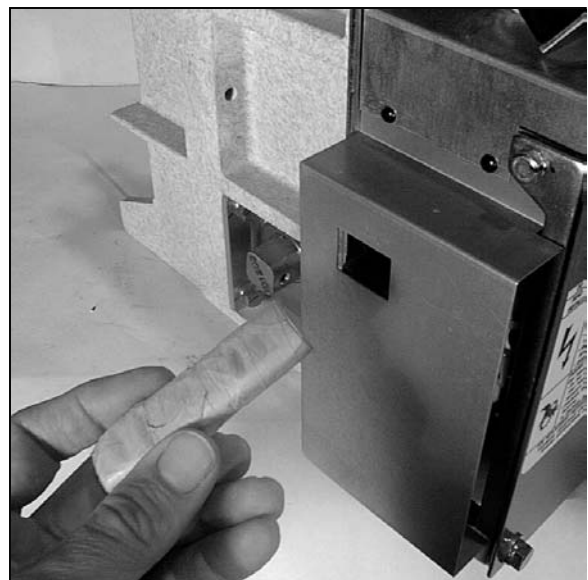

Fig. 32 Plug Installed in UV Trip Device

MAINTENANCE PROGRAM

In order to ensure continued reliable and safe operation of the equipment, a program of periodic maintenance must be established. Operating and environmental conditions will usually dictate the frequency of inspection required. NFPA Publication 70B "Electrical Equipment Maintenance" may be used as a guide for setting up the maintenance program.

⚠ DANGER

Contact with energized components can cause severe injury, death and property damage. Turn off and lock-out primary and control circuit power before servicing.

⚠ WARNING

Improper maintenance can cause severe injury, death and property damage. Only qualified and authorized persons are to install, operate or service this equipment.

⚠ WARNING

Grease is conductive. Do not allow grease or any other substances to contaminate insulating materials. Contaminated insulators can allow a short-circuit or ground fault to occur.

NOTE: Refer to the SAFETY section of this manual for important information.

MAINTENANCE RECORD

Keep a permanent record of all maintenance work. At a minimum, this record should include information on:

- 1) Items inspected
- 2) Reports of any testing
- 3) Equipment condition
- 4) Corrective actions or adjustments
- 5) Date of work

6) Comments

The degree of detail of the record will depend somewhat on the operating conditions.

SERVICING EQUIPMENT

For your safety, turn off and lock out main and control circuit power before servicing the circuit breaker. Certain minimum safety procedures must be followed:

- 1) Only **qualified personnel** should attempt this service.
- 2) **Never** perform service on or next to exposed components energized with line voltage.

Failure to adhere to these safety procedures can result in severe injury, death and property damage.

⚠ WARNING

RECOMMENDED INSPECTION AND MAINTENANCE TYPES

NOTE: Refer to the SAFETY section of this manual for important information.

A. Acceptance Inspection

This inspection confirms that the circuit breaker unit is complete, correct as specified, and undamaged from shipment. The procedure for this inspection is outlined in the RECEIVING, INSPECTION AND HANDLING section of this manual.

B. Patrol Inspection

Inspection is made of the condition of the circuit breaker while it is energized. Check that no unusual sounds or smells exist externally.

Inspection Frequency: Once every 6 months

C. Periodic Inspection

Inspection is performed with the circuit breaker de-energized. The lubrication of sliding and rotating parts is checked and the mechanism is lubricated if needed.

Inspection Frequency: Once every 1-3 years or every 3000 operations (normal). Once every 6 years (detailed).

Refer to Table 2 for the schedule of Periodic Inspections.

D. Unscheduled Inspection

Inspections are implemented as required.

Inspection Frequency: As needed

NOTE: The inspection frequency and points to be inspected may vary from the above recommendations depending on the status of use, frequency of switching, amount of current interrupted and other factors.

Screw Nominal Dia.	Tightening Torque
M4	15-20 kgf-cm 13-17 in-lb
M5	30-40 kgf-cm () 26-34 in-lb
M6	50-65 kgf-cm () 43-56 in-lb
M8	120-150 kgf-cm () 9-11 ft-lb
M10	250-315 kgf-cm () 18-23 ft-lb
M12	450-565 kgf-cm () 32-41 ft-lb

Table 1 Tightening Torques

Table 2 Check Points for Periodic Inspection

Check Point	Check Item	Check Method	Criteria	Disposition
Operating Mechanism	Loose bolts, nuts or screws	Tighten using screwdriver or wrench.	Make sure all bolts, nuts and screws are tight.	Tighten if loose. See Table 1 for tightening torques.
	Dust or foreign matter inside	Visual inspection.	The circuit breaker should be clean and contain no foreign matter.	Wipe with a clean dry cloth.
	Indicator operation	Visual inspection.	Make sure the number of operations is correctly displayed.	Check the cause and repair.
	Warpage	Visual inspection.	There should be no warpage or missing parts.	Check the cause and repair.
	Smooth operation	Manual operation. Visual inspection or touch. Check lubrication.	Make sure moving parts operate smoothly.	Apply a small amount of lubrication.
Main Circuit	Discoloration due to heat from conducting parts	Visual inspection.	Make sure there is no discoloration.	Check the cause and repair. Tighten connections to circuit breaker. See Table 1 for tightening torques.
	Loose bolts, nuts or screws	Tighten using a wrench.	Make sure all bolts, nuts and screws are tight.	See Table 1 for tightening torques.
	Dust on surface of vacuum interrupter	Visual inspection.	Make sure there is no dust on the surface.	Wipe with a clean, dry cloth.
Insulator	Dust, foreign matter or damage	Visual inspection.	Make sure there is no dust, foreign matter or breakage.	Wipe with a clean, dry cloth. If damaged, contact Toshiba.

Table 2. Check Points for Inspection (cont'd)

Check Point	Check Item	Check Method	Criteria	What to do
Auxiliary Switch	Terminals loose or disconnected	Visual inspection. Tighten using a screwdriver.	Make sure terminals are not loose or disconnected.	Repair if disconnected. Tighten if loose. See Table 1 for tightening torques.
	Case/contacts	Visual inspection.	Make sure there is no damage or warping.	Replace if damaged or warped.
Control Circuits	Smooth movement of motor charging mechanism	Energize the control circuit.	Breaker (motor-operated type) should charge quickly and smoothly.	If the circuit fails to operate, check the cause and repair.
	Terminals loose or disconnected	Visual inspection. Tighten using a screwdriver.	Make sure terminals are not loose or disconnected.	Repair if disconnected. Tighten if loose. See Table 1 for tightening torques.
Insulation Resistance Measurement	Meaure main circuit to ground	Megger test at 1000V.	Resistance should be 500MΩ or greater.	If the insulation resistance is low, wipe off the vacuum interrupter and other insulation surfaces with a clean dry cloth and then repeat the test.
	Meaure between main circuit terminals	Megger test at 1000V.	Resistance should be 100MΩ or greater.	
	Meaure control circuits to ground	Megger test at 500V.	Resistance should be 2MΩ or greater.	

VACUUM CHECK

A sufficient level of vacuum is necessary for proper performance of the vacuum interrupters. Although vacuum leaks are rare, the vacuum integrity should be checked periodically. The relationship between dielectric breakdown voltage of the contact gap and internal vacuum interrupter pressure has been found to be generally predictable. Therefore, vacuum interrupter integrity is checked by performing a high potential test across the open gap of the interrupter.

TEST EQUIPMENT:

Toshiba offers a compact vacuum checker (Type CI35-1D) which enables a quick and easy check on vacuum interrupter internal pressure. Alternatively, any commercially available AC high potential tester may be used which is capable of delivering at least 25 milliamperes at 22 kV for a period of one minute.

PRECAUTIONS:

Applying abnormally high voltage across a pair of contacts in vacuum may produce X-rays. The radiation may increase with the increase in voltage and/or decrease in contact spacing. X-radiation produced during this test with recommended voltage and normal contact spacing is extremely low and well below the maximum permitted by standards. As an additional safety measure, however, it is recommended that all personnel keep at least 1 meter (3.3 ft) away from the vacuum circuit breaker while this test is performed.



Radiation exposure hazard. X-rays may cause illness or injury. Stay at least 1 meter (3.3 ft) away from the circuit breaker during the vacuum check test .



Hazardous voltages are present during dielectric testing which can result in severe injury or death. Only qualified personnel should conduct this testing.

TEST PROCEDURE:

1. The circuit breaker should be disconnected from the main circuit and be in the OFF position.
2. Connect all the line side primary terminals together and to the output of the vacuum checker or AC hi-pot machine. Connect all the load side primary terminals together and to the ground terminal of the vacuum checker or AC hi-pot machine.
3. Increase the voltage from zero to 22kV AC at a rate of approximately 2kV per second. Hold the voltage at this value for 1 minute and observe the current drawn by the interrupter.
4. Decrease the voltage back to zero.

Fig. 34 Toshiba Portable Vacuum Checker



CRITERIA:

1. If a current flow above 5 milliamperes is observed or if breakdown occurs, one or more of the interrupters has insufficient vacuum and must be replaced.

Exception: If the current exceeds 5 milliamperes the first time the voltage is brought up, reduce the voltage to zero and increase it again. It may be necessary to repeat this procedure a few times.

2. If the breaker fails to meet criteria 1, then repeat the test on each pole separately to identify the damaged interrupter or interrupters.
3. If the voltage can be held for 1 minute and the current flow does not exceed 5 milliamperes, the interrupter has a sufficient vacuum level.

After the test is complete, discharge any residual static charge from the primary terminals of the circuit breaker.

If a vacuum checker or AC hi-pot tester is not available, a DC hi potential test may be conducted. If a DC test is conducted, the test voltage must be increased to 31kV DC. The test duration for DC tests and the criteria for acceptance remain the same as for AC tests.

⚠WARNING

Do not use DC hi-pot testers which employ unfiltered half-wave rectifiers. The peak voltages produced by these testers may exceed the recommended value of 31kV. This can result in the production of harmful X-rays and may invalidate the test results.

Fig. 35 Application of Test Voltage for Vacuum Check

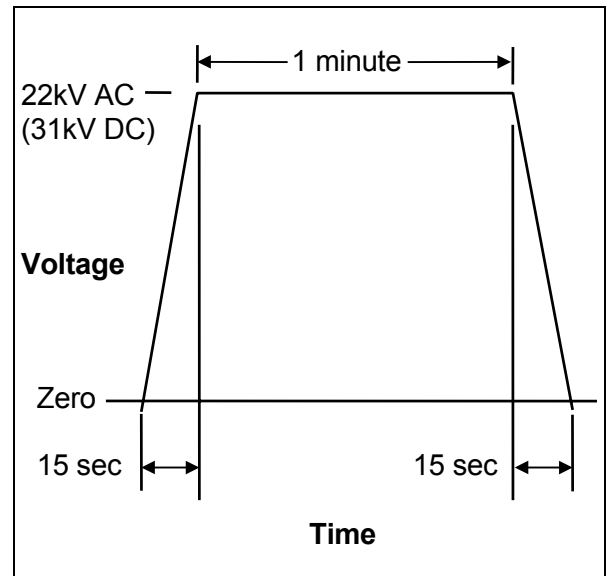

DISPOSAL

Contact your state environmental agency for details on disposal of electrical components and packaging in your particular area.

STORAGE

If the circuit breaker is to be stored for any length of time prior to installation, the following precautions should be taken:

- 1) The original packing should be restored, if possible.
- 2) Do not subject the equipment to moisture or sun rays. Store in cool, clean, and dry location.
- 3) Place a dust cover over the circuit breaker packaging to protect against dirt and moisture.
- 4) Store in an upright position.

INSPECTION DURING STORAGE

Routine scheduled inspection is necessary if storage is for an extended period. The unit should be checked for condensation, moisture, corrosion, and vermin.

Prior to installation, the circuit breaker should be carefully examined for evidence of physical damage, corrosion, or other deterioration. Refer to the PRE-ENERGIZATION Section of this manual.

The MAINTENANCE section of this manual describes various types of inspections recommended for this circuit breaker during the operation period.

Table 3 Circuit Breaker Ratings – Manual Operation HV6AS-U and HV6AS-L Types

Rated Voltage	kV, rms	7.2	4.8
Rated Low Frequency Withstand Voltage	kV, rms	22	
Impulse Withstand Voltage	kV, crest	60	
Rated Continuous Current	A, rms	630	
Rated Frequency	Hz	50/60	
Rated Short-Circuit Breaking Current	kA, rms	14	16
Rated Short-Circuit Making Current	kA, crest	35	40
Rated Short-Time Withstand Current (2 sec)	kA, rms	12.5	
Rated Interrupting Time (60Hz Basis)	cycles	3	
Opening Time	msec	8 - 25	
Rated Control Voltage (Opening)	V	DC 30, 125	
Rated Control Voltage (Undervoltage Trip)	V	AC 120	
Operating Duty		O - 1 min - CO - 3 min - CO	
Auxiliary Contacts		2 N.O. - 2 N.C.	
Weight	kg	22 (U Type)	25 (L Type)

Table 4 Circuit Breaker Ratings – Motor Stored Energy Operation HV6AS-MU and HV6AS-ML Types

Rated Voltage	kV, rms	7.2	4.8
Rated Low Frequency Withstand Voltage	kV, rms	22	
Impulse Withstand Voltage	kV, crest	60	
Rated Continuous Current	A, rms	630	
Rated Frequency	Hz	50/60	
Rated Short-Circuit Breaking Current	kA, rms	14	16
Rated Short-Circuit Making Current	kA, crest	35	40
Rated Short-Time Withstand Current (2 sec)	kA, rms	12.5	
Rated Interrupting Time (60Hz Basis)	cycles	3	
Opening Time	msec	8 - 25	
Closing Time	msec	150 - 300	
Charging Time	sec	1.5 - 3	
Rated Control Voltage (Closing/Charging)	V	AC 120, DC 125	
Rated Control Voltage (Opening)	V	DC 30, 125	
Rated Control Voltage (Undervoltage Trip)	V	AC 120	
Operating Duty		O - 1 min - CO - 3 min - CO	
Auxiliary Contacts		2 N.O. - 2 N.C.	
Weight	kg	24 (MU Type)	27 (ML Type)

Toshiba International Corporation ("Company") warrants that all equipment and parts described herein will be free from defects in materials and workmanship. THIS WARRANTY WILL EXPIRE EIGHTEEN (18) MONTHS AFTER THE DATE ON WHICH SUCH EQUIPMENT AND PARTS (EXCLUDING REPAIRED OR REPLACEMENT EQUIPMENT AND PARTS FURNISHED PURSUANT TO THIS WARRANTY) ARE SHIPPED BY THE COMPANY TO THE INITIAL PURCHASER OR TWELVE (12) MONTHS AFTER SUCH EQUIPMENT AND PARTS (EXCLUDING REPAIRED OR REPLACEMENT EQUIPMENT AND PARTS FURNISHED PURSUANT TO THIS WARRANTY) ARE FIRST PLACED IN OPERATION, WHICHEVER PERIOD FIRST EXPIRES.

The Company will, at its option, repair or replace such equipment or part which is defective under the terms of the foregoing warranty, free of charge; provided the purchaser (1) promptly notifies the Company in writing of such defect, and (2) furnishes the Company satisfactory proof thereof, and (3) establishes that the equipment or part has been properly installed, maintained and operated within the limits of rated capacity and normal usage and in accordance with this manual, and (4) if requested by the Company, returns the defective equipment or part to the Company and pays all expenses incurred in connection with such return. The repaired or replacement equipment or part will be delivered, free of charge, to the purchaser F.O.B. the Company's warehouse or, at the Company's option, F.O.B. a Company authorized service shop, not loaded on truck or other carrier. The purchaser will pay the costs applicable to the equipment or part following such delivery, including, without limitation, all handling, transportation, assembly, insurance, testing and inspection charges.

THE FOREGOING OBLIGATION TO REPAIR OR REPLACE EQUIPMENT PARTS SHALL BE THE SOLE AND EXCLUSIVE REMEDY OF THE PURCHASER, ITS CUSTOMERS AND USERS OF THE EQUIPMENT AND PARTS FOR BREACH OF THE FOREGOING WARRANTY. THE COMPANY WILL HAVE NO OBLIGATIONS TO DISASSEMBLE ANY EQUIPMENT OR PART WHICH IS DEFECTIVE WITHIN THE TERMS OF THE ABOVE WARRANTY OR TO INSTALL ANY REPAIRED OR REPLACEMENT PART OR EQUIPMENT OR TO PAY ANY COSTS INCURRED IN CONNECTION WITH ANY SUCH DISASSEMBLY OR INSTALLATION. THE COMPANY, TOSHIBA CORPORATION AND THEIR SUPPLIERS AND SUBCONTRACTORS HEREBY DISCLAIM ALL OTHER EXPRESS, STATUTORY AND IMPLIED WARRANTIES, INCLUDING, WITHOUT LIMITATION, ALL EQUIPMENT AND PARTS FURNISHED PURSUANT TO THE FOREGOING WARRANTY AND ALL IMPLIED WARRANTIES OF MERCHANTABILITY.

The total liability of the Company, Toshiba Corporation and their suppliers and subcontractors for any loss, damage or claim, whether in contract, tort (including negligence and liability without fault), or otherwise, arising out of, connected with or resulting from the equipment and parts described in this manual or the performance or breach of any contract for the sale or supply of such equipment and parts, or from the design, manufacture, sale, delivery, resale, installation, technical direction or supervision of installation, inspection, testing, repair, replacement, operation, maintenance or use of any such equipment or part or any service relating thereto furnished by the Company shall not in any event exceed the price allocable to the equipment, part or service which gives claim, loss or damage. In no event, whether as a breach of contract or warranty, alleged negligence, liability without fault, or otherwise, shall the Company, Toshiba Corporation or their suppliers or subcontractors be liable for special or consequential damages, including, without limitation, loss or profits or revenue, loss of equipment described herein or any associated equipment, cost of capital, cost of substitute equipment or parts, facilities or services, down-time costs, labor costs or claims of customers of the purchaser for such damages.

TOSHIBA

TOSHIBA INTERNATIONAL CORPORATION
13131 W. Little York Road, Houston, TX 77041,
U.S.A.
Tel: (713) 466-0277 Fax: (713) 466-8773

Free Manuals Download Website

<http://myh66.com>

<http://usermanuals.us>

<http://www.somanuals.com>

<http://www.4manuals.cc>

<http://www.manual-lib.com>

<http://www.404manual.com>

<http://www.luxmanual.com>

<http://aubethermostatmanual.com>

Golf course search by state

<http://golfingnear.com>

Email search by domain

<http://emailbydomain.com>

Auto manuals search

<http://auto.somanuals.com>

TV manuals search

<http://tv.somanuals.com>