

**TOSHIBA**

UM-TS01\*\*\*-E001

PROGRAMMABLE CONTROLLER  
PROSEC **T1/T1S**

**USER'S MANUAL**  
**– Basic Hardware and Function –**

**TOSHIBA CORPORATION**

## Important Information

Misuse of this equipment can result in property damage or human injury. Because controlled system applications vary widely, you should satisfy yourself as to the acceptability of this equipment for your intended purpose. In no event will Toshiba Corporation be responsible or liable for either indirect or consequential damage or injury that may result from the use of this equipment.

No patent liability is assumed by Toshiba Corporation with respect to use of information, illustrations, circuits, equipment or examples of application in this publication.

Toshiba Corporation reserves the right to make changes and improvements to this publication and/or related products at any time without notice. No obligation shall be incurred other than as noted in this publication.

This publication is copyrighted and contains proprietary material. No part of this book may be reproduced, stored in a retrieval system, or transmitted, in any form or by any means — electrical, mechanical, photocopying, recording, or otherwise — without obtaining prior written permission from Toshiba Corporation.

© TOSHIBA Corporation 1995. All rights reserved

PROSEC and TOSLINE are registered trademarks of TOSHIBA Corporation.

IBM is a registered trademark of International Business Machines Corporation.  
MS-DOS and Windows are registered trademarks of Microsoft Corporation.

Publication number: UM-TS01\*\*\*-E001  
1st edition December 1995, 4th edition February 1998

---



---

## CE Marking

---



---

The Programmable Controller PROSEC T1 and T1S (hereafter called T1/T1S) complies with the requirements of the EMC Directive 89/336/EEC and Low Voltage Directive 72/23/EEC under the condition of use according to the instructions described in this manual.  
The contents of the conformity are shown below.

<b>Application of Council Directive</b>	<b>EMC</b> : 89/336/EEC (as amended by 91/263/EEC and 92/31/EEC) <b>LVD</b> : 72/23/EEC (as amended by 93/68/EEC)
<b>Manufacturer's Name</b>	: Toshiba Corporation, Fuchu Works
<b>Address</b>	: 1, Toshiba-Cho Fuchu-shi TOKYO 183 Japan
<i>declares, that the product</i>	
<b>Product Name</b>	: Programmable Controller , T1 Series
<b>Model Number</b>	: TDR116*6S, TAR116*6S, TDR116*3S TDR128*6S, TAR128*6S, TDR128*3S TDR140*6S, TAR140*6S, TDR140*3S TDR140S6S, TAR140S6S, TDR140S3S
<i>conforms to the following Product Specifications:</i>	
<b>EMC</b>	
<b>Radiated Interference</b>	: EN 55011 Group 1 Class A
<b>Mains Interference</b>	: EN 55011 Group 1 Class A
<b>Radiated Susceptibility</b>	: ENV50140
<b>Conducted RFI Susceptibility</b>	: ENV50141, IEC100-4-6.
<b>Electrostatic Discharge</b>	: IEC1000-4-2
<b>Electrical Fast Transient</b>	: IEC1000-4-4
<b>LVD</b>	: EN61131-2:1995    3.10 Dielectric Properties 4.    Mechanical Requirements
<b>Supplementary information</b>	:
(1) Included Handy Programmer THP911A*S.	
(2) Included each type of associated input/output unit in a typical configuration.	
(3) Product must be installed in accordance with manufacturers instructions	

---



---

## ***UL/c-UL Listing***

---



---

The Programmable Controller PROSEC T1 and T1S (hereafter called T1/T1S) are UL/c-UL listed as shown below.

### **UL and c-UL Listing**

**File Number :** E95637  
**Product Name :** Programmable Controller , T1 Series  
**Product Covered :** Main Unit  
 TDR116\*6S, TAR116\*6S, TDR116\*3S,  
 TDR128\*6S, TAR128\*6S, TDR128\*3S,  
 TDR140\*6S, TAR140\*6S, TDR140\*3S,  
 TDR140S6S, TAR140S6S, TDR140S3S  
 Option Card  
 TDI116\*BS, TDD116\*BS, TDO116\*BS,  
 TAD121\*BS, TAD131\*BS, TDA121\*BS, TDA131\*BS,  
 TFR112\*BS  
 Expansion Unit  
 TDR132E\*S, TAR132E\*S  
 Expansion Rack  
 TBU152\*\*S, TBU154\*\*S  
 Peripherals  
 TRM102\*\*S, TCU111\*\*S, THP911A\*S

### **UL and c-UL Listing For Use in Hazardous Locations**

**File Number :** E184034  
**Product Name :** Programmable Controller , T1 Series  
**Product Covered :** Main Unit  
 TDR116\*6S, TAR116\*6S, TDR116\*3S,  
 TDR128\*6S, TAR128\*6S, TDR128\*3S,  
 TDR140\*6S, TAR140\*6S, TDR140\*3S,  
**Locations Class :** Class I, Division 2, Groups A, B, C, D  
**Important Notice :**

1. THIS EQUIPMENT IS SUITABLE FOR USE IN CLASS I, DIVISION 2, GROUPS A, B, C, D OR NON-HAZARDOUS LOCATIONS ONLY.
2. WARNING - EXPLOSION HAZARD - SUBSTITUTION OF COMPONENTS MAY IMPAIR SUITABILITY FOR CLASS I, DIVISION 2.
3. WARNING - EXPLOSION HAZARD - DO NOT DISCONNECT EQUIPMENT UNLESS POWER HAS BEEN SWITCHED OFF OR THE AREA IS KNOWN TO BE NON-HAZARDOUS.

---

---

# ***Safety Precautions***

---

---

This manual is prepared for users of Toshiba's Programmable Controller T1/T1S. Read this manual thoroughly before using the T1/T1S. Also, keep this manual and related manuals so that you can read them anytime while the T1/T1S is in operation.

## **General Information**

1. The T1/T1S has been designed and manufactured for use in an industrial environment. However, the T1/T1S is not intended to be used for systems which may endanger human life. Consult Toshiba if you intend to use the T1/T1S for a special application, such as transportation machines, medical apparatus, aviation and space systems, nuclear controls, submarine systems, etc.
2. The T1/T1S has been manufactured under strict quality control. However, to keep safety of overall automated system, fail-safe systems should be considered outside the T1/T1S.
3. In installation, wiring, operation and maintenance of the T1/T1S, it is assumed that the users have general knowledge of industrial electric control systems. If this product is handled or operated improperly, electrical shock, fire or damage to this product could result.
4. This manual has been written for users who are familiar with Programmable Controllers and industrial control equipment. Contact Toshiba if you have any questions about this manual.
5. Sample programs and circuits described in this manual are provided for explaining the operations and applications of the T1/T1S. You should test completely if you use them as a part of your application system.

## **Hazard Classifications**

In this manual, the following two hazard classifications are used to explain the safety precautions.

 **WARNING** Indicates a potentially hazardous situation which, if not avoided, could result in death or serious injury.

 **CAUTION** Indicates a potentially hazardous situation which, if not avoided, may result in minor or moderate injury. It may also be used to alert against unsafe practices.

Even a precaution is classified as CAUTION, it may cause serious results depending on the situation. Observe all the safety precautions described on this manual.

---

---

## ***Safety Precautions***

---

---

### **Installation:**

 **CAUTION**

1. Excess temperature, humidity, vibration, shocks, or dusty and corrosive gas environment can cause electrical shock, fire or malfunction. Install and use the T1/T1S and related equipment in the environment described in this manual.
2. Improper installation directions or insufficient installation can cause fire or the units to drop. Install the T1/T1S and related equipment in accordance with the instructions described in this manual.
3. Turn off power before installing or removing any units, modules, racks or terminal blocks. Failure to do so can cause electrical shock or damage to the T1/T1S and related equipment.
4. Entering wire scraps or other foreign debris into to the T1/T1S and related equipment can cause fire or malfunction. Pay attention to prevent entering them into the T1/T1S and related equipment during installation and wiring.
5. Turn off power immediately if the T1/T1S or related equipment is emitting smoke or odor. Operation under such situation can cause fire or electrical shock. Also unauthorized repairing will cause fire or serious accidents. Do not attempt to repair. Contact Toshiba for repairing.

### **Wiring:**

 **CAUTION**

1. Turn off power before wiring to minimize the risk of electrical shock.
2. Exposed conductive parts of wire can cause electrical shock. Use crimp-style terminals with insulating sheath or insulating tape to cover the conductive parts. Also close the terminal covers securely on the terminal blocks when wiring has been completed.
3. Operation without grounding may cause electrical shock or malfunction. Connect the ground terminal on the T1/T1S to the system ground.
4. Applying excess power voltage to the T1/T1S can cause explosion or fire. Apply power of the specified ratings described in the manual.
5. Improper wiring can cause fire, electrical shock or malfunction. Observe local regulations on wiring and grounding.

---

---

## ***Safety Precautions***

---

---

### **Operation:**

 **WARNING**

1. Configure emergency stop and safety interlocking circuits outside the T1/T1S. Otherwise, malfunction of the T1/T1S can cause injury or serious accidents.

 **CAUTION**

2. Operate the T1/T1S and the related modules with closing the terminal covers. Keep hands away from terminals while power on, to avoid the risk of electrical shock.
3. When you attempt to perform force outputs, RUN/HALT controls, etc. during operation, carefully check for safety.
4. Turn on power to the T1/T1S before turning on power to the loads. Failure to do so may cause unexpected behavior of the loads.
5. Do not use any modules of the T1/T1S for the purpose other than specified. This can cause electrical shock or injury.
6. Do not modify the T1/T1S and related equipment in hardware nor software. This can cause fire, electrical shock or injury.
7. Configure the external circuit so that the external 24 Vdc power required for transistor output circuits and power to the loads are switched on/off simultaneously. Also, turn off power to the loads before turning off power to the T1/T1S.
8. Install fuses appropriate to the load current in the external circuits for the outputs. Failure to do so can cause fire in case of load over-current.
9. Check for proper connections on wires, connectors and modules. Insufficient contact can cause malfunction or damage to the T1/T1S and related equipment.

---

---

## ***Safety Precautions***

---

---

### **Maintenance:**

 CAUTION

1. Turn off power before removing or replacing units, modules, terminal blocks or wires. Failure to do so can cause electrical shock or damage to the T1/T1S and related equipment.
2. When you remove both input and output terminal blocks with wires for maintenance purpose, pay attention to prevent inserting them upside down.
3. Do not insert your finger into the expansion rack's ventilation hole during power on. This can cause electrical shock.
4. Do not disassemble the T1/T1S because there are hazardous voltage parts inside.
5. Perform daily checks, periodical checks and cleaning to maintain the system in normal condition and to prevent unnecessary troubles.
6. Check by referring "Troubleshooting" section of this manual when operating improperly. Contact Toshiba for repairing if the T1/T1S or related equipment is failed. Toshiba will not guarantee proper operation nor safety for unauthorized repairing.
7. The contact reliability of the output relays will reduce if the switching exceeds the specified life. Replace the unit or module if exceeded.



---

---

## ***Safety Precautions***

---

---

### **Safety Label**

The safety label as shown on the right is attached to the power terminal of the T1/T1S.

Remove the mount paper before wiring.

Peel off the label from the mount paper and stick it near the power terminals where it can be readily seen.

Contact Toshiba if the label is damaged.

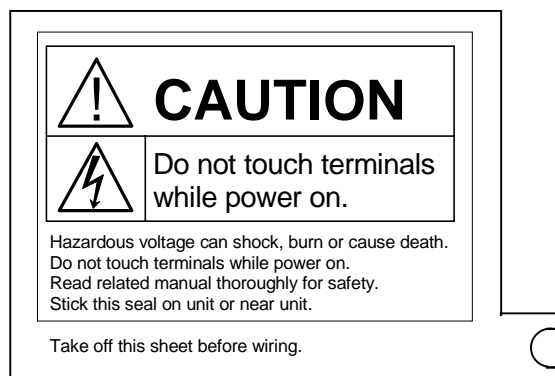

## About This Manual

### About This Manual

This manual has been prepared for first-time users of Toshiba's Programmable Controller T1 and/or T1S to enable a full understanding of the configuration of the equipment, and to enable the user to obtain the maximum benefits of the equipment.

This manual introduces the T1 and T1S, and explains the system configuration, specifications, installation and wiring for T1/T1S's basic hardware. This manual provides the information for designing T1/T1S user program, such as the internal operation, memory configuration, I/O allocation and programming instructions. Information for maintenance and troubleshooting are also provided in this manual.

The specifications of the option cards, expansion units, and I/O modules, and how to use them, are explained in the separate manual. Read the T1/T1S User's Manual - Expansion I/O - when using the option cards, expansion units, and/or I/O modules. The T1/T1S's computer link function and T1S's multi-purpose communication functions are covered by the separate manual. Read the T1/T1S User's Manual - Communication Function - for details.

### Inside This Manual

This manual consists of 10 main sections and an appendix.

Section 1 outlines the T1/T1S configuration. To fully understand the T1/T1S, it is important to read this section carefully. Sections 2, to 4 describe the hardware used in designing external circuits and panels. Sections 5 to 7 are mainly concerned with software. Section 8 explains the T1/T1S's special I/O functions. Sections 9 and 10 describe the maintenance procedure for the T1/T1S, to ensure safe operation and long service life.

### Related Manuals

The following related manuals are available for T1/T1S. Besides this manual, read the following manuals for your better understanding.

**T1/T1S User's Manual - Basic Hardware and Function - (this manual)**

**T1/T1S User's Manual - Expansion I/O -**

**T1/T1S User's Manual - Communication Function -**

**T-Series Handy Programmer (HP911) Operation Manual**

**T-Series Program Development System (T-PDS) User's Manual**



NOTE

Other than the listed above, some T1 related manuals for special I/O modules and data transmission modules are available. Contact Toshiba for more information.

## About This Manual

### Terminology

The following is a list of abbreviations and acronyms used in this manual.

<b>μs</b>	microsecond
<b>ASCII</b>	American Standard Code For Information Interchange
<b>AWG</b>	American Wire Gage
<b>BCC</b>	Block Check Code
<b>CCW</b>	Counter-Clockwise
<b>CPU</b>	Central Processing Unit
<b>CW</b>	Clockwise
<b>EEPROM</b>	Electrically Erasable Programmable Read Only Memory
<b>H</b>	hexadecimal (when it appears in front of an alphanumeric string)
<b>I/O</b>	Input/Output
<b>LED</b>	Light Emitting Diode
<b>LSB</b>	Least Significant Bit
<b>ms</b>	millisecond
<b>MSB</b>	Most Significant Bit
<b>PWM</b>	Pulse Width Modulation
<b>RAM</b>	Random Access Memory
<b>ROM</b>	Read Only Memory
<b>Vac</b>	AC voltage
<b>Vdc</b>	DC voltage

# Contents

## Contents

<b>Safety Precautions</b> .....	<b>3</b>
<b>About This Manual</b> .....	<b>8</b>
<b>1. System Configuration</b> .....	<b>13</b>
1.1 Introducing the T1 and T1S .....	14
1.2 Features .....	16
1.3 System configuration .....	19
1.4 I/O expansion .....	20
1.5 Components .....	22
1.5.1 Basic unit .....	22
1.5.2 Option cards .....	28
1.5.3 Expansion rack .....	29
1.5.4 I/O modules .....	30
1.5.5 Expansion unit .....	31
1.5.6 Options .....	32
1.6 Computer link system .....	33
1.7 T1S communication function .....	34
1.8 Real-time data link system .....	36
1.9 Peripheral tools .....	37
<b>2. Specifications</b> .....	<b>41</b>
2.1 General specifications .....	42
2.2 External dimensions .....	43
2.3 Functional specifications .....	46
2.4 I/O specifications .....	48
2.4.1 T1-16 .....	48
2.4.2 T1-28 .....	52
2.4.3 T1-40/T1-40S .....	56
<b>3. I/O Application Precautions</b> .....	<b>61</b>
3.1 Application precautions for input signals .....	62
3.2 Application precautions for output signals .....	65
<b>4. Installation and Wiring</b> .....	<b>67</b>
4.1 Environmental conditions .....	68
4.2 Installing the unit .....	69
4.3 Wiring terminals .....	71
4.4 Grounding .....	76
4.5 Power supply wiring .....	78
4.6 I/O wiring .....	80

<b>Contents</b>
-----------------

<b>5.</b>	<b>Operating System Overview .....</b>	<b>81</b>
5.1	Operation modes .....	82
5.2	About the built-in EEPROM .....	84
5.3	Scanning .....	87
<b>6.</b>	<b>Programming Information .....</b>	<b>91</b>
6.1	Devices and registers .....	92
6.2	Index modification .....	104
6.3	Real-time clock/calendar .....	106
6.4	I/O allocation .....	107
6.5	T1S memory mode setting .....	109
6.6	User program configuration .....	110
6.6.1	Main program .....	112
6.6.2	Sub-program #1 .....	113
6.6.3	Timer interrupt program .....	113
6.6.4	I/O interrupt programs .....	114
6.6.5	Subroutines .....	115
6.7	Programming language .....	116
6.8	Program execution sequence .....	117
6.9	On-line debug support functions .....	118
6.10	Password protection .....	121
<b>7.</b>	<b>Instructions .....</b>	<b>123</b>
7.1	List of instructions .....	124
7.2	Instruction specifications .....	134
<b>8.</b>	<b>Special I/O Functions .....</b>	<b>267</b>
8.1	Special I/O function overview .....	268
8.2	Variable input filter constant .....	272
8.3	High speed counter .....	273
8.3.1	Single phase up-counter .....	273
8.3.2	Single phase speed-counter .....	275
8.3.3	Quadrature bi-pulse counter .....	277
8.4	Interrupt input function .....	280
8.5	Analog setting function .....	282
8.6	Pulse output function .....	283
8.7	PWM output function .....	285
<b>9.</b>	<b>Maintenance and Checks .....</b>	<b>287</b>
9.1	Precautions during operation .....	288
9.2	Daily checks .....	289
9.3	Periodic checks .....	290
9.4	Maintenance parts .....	291

## Contents

<b>10.</b>	<b>Troubleshooting</b> .....	<b>293</b>
10.1	Troubleshooting procedure .....	294
10.1.1	Power supply check .....	295
10.1.2	CPU check .....	296
10.1.3	Program check .....	296
10.1.4	Input check .....	297
10.1.5	Output check .....	298
10.1.6	Environmental problem .....	299
10.2	Self-diagnostic items .....	300
<b>Appendix</b>	.....	<b>305</b>
A.1	List of models and types .....	306
A.2	Instruction index .....	309

---

---

# *Section 1*

## *System Configuration*

---

---

- 1.1 *Introducing the T1 and T1S, 14*
- 1.2 *Features, 16*
- 1.3 *System configuration, 19*
- 1.4 *I/O expansion, 20*
- 1.5 *Components, 22*
- 1.6 *Computer link system, 33*
- 1.7 *T1S Communication function, 34*
- 1.8 *Real-time data link system, 36*
- 1.9 *Peripheral tools, 37*

## 1. System Configuration

### 1.1 Introducing the T1 and T1S

The T1 Series are compact, block style, high-performance programmable controllers with a range of 16 to 328 input and output points.

The T1 Series are available in two versions, T1 and T1S. The T1S is an enhanced version against the standard T1.

The figure below shows the T1 Series line-up. The T1 Series consists of the total 12 types.

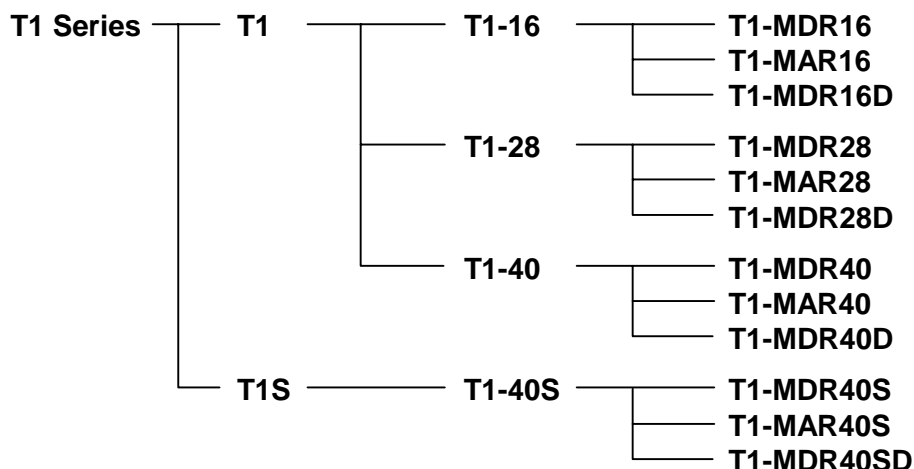

#### I/O points:

The T1 Series are available in four models, T1-16, T1-28, T1-40 and T1-40S. Each model has the following I/O points.

	<b>T1-16</b>	<b>T1-28</b>	<b>T1-40</b>	<b>T1-40S</b>
<b>Input</b>	8 points	14 points	24 points	
<b>Output</b>	8 points (6 relay plus 2 solid-state)	14 points (12 relay plus 2 solid-state)	16 points (14 relay plus 2 solid-state)	
<b>Expansion</b>	No	No	2 option cards plus 1 expansion rack or unit. Total up to 382 points.	

The T1-16 and T1-28 are fixed I/O non-expandable controllers.

The T1-40 and T1-40S, however, provides additional flexibility. They are expandable in three ways, option cards, expansion rack and expansion unit.

The T1-40/T1-40S can hold two option cards. These are approximately 1/2 the size of a credit card. Also, the T1-40/T1-40S can be connected to either one expansion rack or one expansion unit. The expansion rack (2-slot type or 4-slot type) allows the T1-40/T1-40S to use most T2 series I/O modules. The expansion unit is a fixed I/O unit. It has 32 I/O points (16 inputs and 16 outputs).

If two 16 points option cards are inserted and the 4-slot expansion rack with four 64 points modules is connected to the T1-40/T1-40S, it can control up to 328 points.



## 1. System Configuration

### Memory capacity:

Program memory capacity of the T1 is 2 k steps. And that of the T1S is 8 k steps. Whole the program and a part of data registers are stored in built-in EEPROM.

	T1	T1S
<b>Memory</b>	RAM (for execution) and EEPROM (for back-up)	
<b>Program capacity</b>	2 k steps	8 k steps (4 k mode or 8 k mode)
<b>Data capacity</b>	Auxiliary relay: 1024 points Timer: 64 points Counter: 64 points Data register: 1024 words	Auxiliary relay: 4096 points Timer: 256 points Counter: 256 points Data register: 4096 words
<b>EEPROM back-up</b>	Program and leading 512 words of Data register	Program and the user specified range of Data register (0 to 2048 words)
<b>RAM back-up</b>	Capacitor (6 hours or more at 25°C)	Capacitor (168 hours or more at 25°C)

### Control functions:

In addition to the basic relay ladder functions, the T1/T1S provides functions such as data operations, arithmetic operations, various functions, etc. Furthermore, its high speed counter functions, pulse output functions and data communication functions allow its application to a wide scope of control systems.

	T1	T1S
<b>Language</b>	Ladder diagram with function block	
<b>Number of instructions</b>	Basic: 17 types Function: 76 types	Basic: 21 types Function: 99 types
<b>Subroutines</b>	16 (nesting not allowed)	256 (up to 3 levels of nesting)
<b>Execution speed</b>	1.4 $\mu$ s/contact, 2.3 $\mu$ s/coil, 4.2 $\mu$ s/transfer, 6.5 $\mu$ s/addition	
<b>Real-time clock/calendar</b>	No	Yes (year, month, day, week, hours, minutes, seconds)
<b>Communication</b>	RS-232C (programmer port)	RS-232C (programmer port), RS-485 (multi-purpose)

### Construction:

The T1/T1S is a compact, easy-handling block style programmable controller. The T1/T1S has all of the features of a block style controller. In addition, the T1-40/T1-40S has modular expandability. The T1-40/T1-40S provides flexibility into the block style controller.

### Series compatibility:

Programming instructions are upward compatible in the T-Series programmable controllers. The T1/T1S programs can be used for other models of the T-Series, T2, T2E, T2N, T3 and T3H. Peripheral tools can also be shared.

# 1. System Configuration

## 1.2 Features

### Option card support:

The T1-40/T1-40S has two slots for the option card, which is approximately 1/2 the size of a credit card. The following eight types of the option cards are available.

- 16 points DC input
- 16 points DC output
- 8 DC inputs + 8 DC outputs
- 1 channel analog input (0 to 5 V/0 to 20 mA)
- 1 channel analog input ( $\pm 10$  V)
- 1 channel analog output (0 to 20 mA)
- 1 channel analog output ( $\pm 10$  V)
- Field network TOSLINE-F10 remote

By using the 16 points input and 16 points output cards, the T1-40/T1-40S can control up to 72 I/O points without enlarging the mounting space.

### Built-in high speed counter:

Two single-phase or one quadrature (2-phase) pulses can be counted. The acceptable pulse rate is up to 5 kHz. (DC input type only)

### Built-in analog setting adjusters:

Two analog setting adjusters are provided on the T1/T1S. This allows operators to adjust time or other control parameters easily using a screwdriver.

### High speed processing:

Sophisticated machine control applications require high speed data manipulations. The T1/T1S is designed to meet these requirements.

- 1.4  $\mu$ s per contact
- 2.3  $\mu$ s per coil
- 4.2  $\mu$ s per 16-bit transfer
- 6.5  $\mu$ s per 16-bit addition

The T1/T1S also supports interrupt input function (DC input type only). This allows immediate operation independent of program scan.

### High performance software:

The T1 offers 17 basic ladder instructions and 76 function instructions. The T1S offers 21 basic ladder instructions and 99 function instructions.

Subroutines, Interrupt functions, Indirect addressing, For/Next loops, Pre-derivative real PID, etc. are standard on the T1/T1S. These functions allow the T1/T1S to be applied to the most demanding control applications.

### Battery-less operation:

The T1/T1S has a standard built-in EEPROM, permitting operation without need of a battery. Also, the variable data can be written into and/or read from the EEPROM, providing completely maintenance-free back-up operation.

This function is an important feature for OEMs, because it can eliminate the need for changing the battery every few years. The cost of the battery is also eliminated.

## 1. System Configuration

### **Pulse output / PWM output:**

One point of variable frequency pulses (max. 5 kHz) or variable duty pulses can be output. These functions can be used to drive a stepping motor or to simulate an analog output. (DC input type only)

### **Built-in computer link function:**

The T1/T1S's RS-232C programmer port can accept the computer link protocol (data read/write). This results in easy connection to a higher level computer, an operator interface unit, etc.

The parity setting of the programmer port can be selected either odd or none. The none parity mode is provided especially for telephone modem connection. Using modems, remote programming/monitoring is available.

### **Real-time control data link network:**

By inserting the TOSLINE-F10 remote card (option card) into the T1-40/T1-40S, high speed data link network can be established. In this network, upper T-series PLC model (T2/T2E/T2N or T3/T3H) works as master and up to 16 T1-40/T1-40Ss can be connected as remote. Each T1-40/T1-40S can exchange data with the master through 1 word input and 1 word output. The transmission speed can be selected either 750 kbps or 250 kbps.

### **T2 Series I/O module interface:**

In addition to the option cards, the T1-40/T1-40S has a interface for connecting the T2 Series I/O modules. Up to four modules can be connected to the T1-40/T1-40S. The following I/O modules are available.

- 16 points DC input (DI31)
- 32 points DC input (DI32)
- 64 points DC input (DI235)
- 16 points AC input (IN51/IN61)
- 8 points isolated relay output (RO62)
- 4 channels analog input (AI21/AI22/AI31/AI32)
- 1 channel pulse input (PI21)
- Communication interface (CF211)
- 16 points DC output (DO31/DO233P)
- 32 points DC output (DO32)
- 64 points DC output (DO235)
- 12 points AC output (AC61)
- 12 points relay output (RO61)
- 2 channels analog output (AO31/AO22/AO32)
- 1 axis position control (MC11)

### **Sampling trace function:**

The sampling trace is the function to collect the user specified data every user specified timing (minimum every scan), and to display the collected data on the programmer screen in time chart and/or trend graph format. This function is useful for checking the input signals changing.

The collecting capacities between T1 and T1S are different as follows.

- T1 ..... 1 register - 128 times, or 8 devices - 256 times
- T1S ... 3 registers and 8 devices - 256 times

## 1. System Configuration

### **Password protection:**

By registering your passwords, four levels of protection is available according to the security levels required for your application.

Level 4: Reading/writing program and writing data are prohibited

Level 3: Reading/writing program are prohibited

Level 2: Writing program is prohibited

Level 1: No protection (changing passwords is available only in this level)

### **Two points of solid-state output:**

Each model of the T1/T1S has two points of solid-state output (transistors for DC input type and triacs for AC input type). These solid-state outputs are suitable for frequent switching application.

### **Removable terminal blocks:**

The T1-28, T1-40 and T1-40S are equipped with removable terminal blocks. This supports the easy maintenance work.

### **DIN rail mounting:**

The T1/T1S is equipped with brackets for mounting on a standard 35 mm DIN rail. The T1/T1S can be mounted on a DIN rail as well as screw mounting.

### **On-line program changes: (T1S only)**

When the T1S's memory mode is set to 4 k steps mode, on-line (in RUN mode) program changes are available. Furthermore, program writing into the built-in EEPROM is also available in RUN mode. These functions are useful in program debugging stage.

### **Real-time clock/calendar function: (T1S only)**

The T1S has the real-time-clock/calendar function (year, month, day, day of the week, hours, minutes, seconds) that can be used for performing scheduled operations, data gathering with time stamps, etc. The real-time-clock/calendar data is backed up by built-in capacitor for power off. The back-up period is more than 7 days at 25 °C.

### **RS-485 multi-purpose communication port: (T1S only)**

The T1S has an RS-485 multi-purpose communication port. Using this port, one of the following communication modes can be selected.

- **Computer link mode:** T-series computer link protocol can be used in this mode. Up to 32 T1Ss can be connected to a master computer. By using this mode, MMI/SCADA system can be easily configured.
- **Data link mode:** Two PLCs (any combination of T1S, T2E or T2N) can be directly linked together. This direct link is inexpensive, easily configured and requires no special programming.
- **Free ASCII mode:** User defined ASCII messages can be transmitted and received through this port. A terminal, printer, bar-code reader, or other serial ASCII device can be directly connected.

# 1. System Configuration

## 1.3 System configuration

The following figure shows the T1/T1S system configuration.

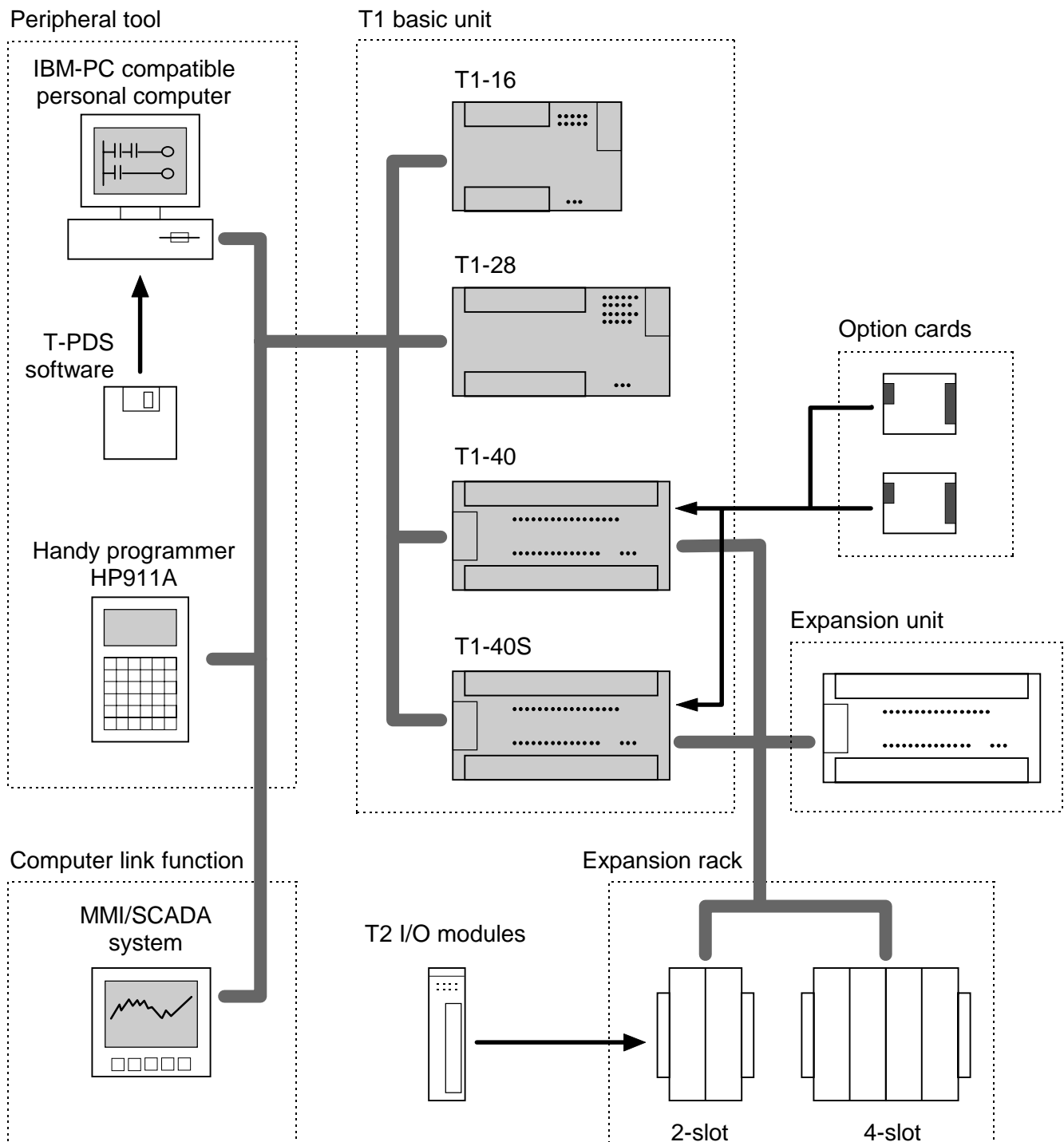

## 1. System Configuration

### 1.4 I/O expansion

The I/O points on the T1-16 and T1-28 are not expandable. The T1-40 and T1-40S, however, provides I/O expandability by using the option cards, expansion rack and expansion unit.

The T1-40/T1-40S can hold up to two option cards. Also, the T1-40/T1-40S can be connected to either one expansion rack (2-slot or 4-slot) or one expansion unit. By using the expansion rack, most of the T2 Series I/O modules can be used with the T1-40/T1-40S.

- Available option cards
  - DI116: 16 points DC input
  - DO116: 16 points DC output
  - DD116: 8 points DC input + 8 points DC output
  - AD121: 1 channel analog input (0 to 5V or 0 to 20mA)
  - AD131: 1 channel analog input (-10 to +10V)
  - DA121: 1 channel analog output (0 to 20mA)
  - DA131: 1 channel analog output (-10 to +10V)
  - FR112: TOSLINE-F10 remote station
- Available expansion racks
  - BU152: Up to 2 I/O modules can be mounted
  - BU154: Up to 4 I/O modules can be mounted
- Available expansion units
  - T1-EDR32: 16 points DC input + 16 points relay output
  - T1-EAR32: 16 points AC input + 16 points relay output
- Available I/O expansion configuration

Model	Unit configuration	I/O points
T1-16	T1-16	16 points (8 in / 8 out)
T1-28	T1-28	28 points (14 in / 14 out)
T1-40 or T1-40S	T1-40(S)	40 points (24 in / 16 out)
	T1-40(S) + DI116	56 points (40 in / 16 out)
	T1-40(S) + DD116	56 points (32 in / 24 out)
	T1-40(S) + DO116	56 points (24 in / 32 out)
	T1-40(S) + DI116 + DI116	72 points (56 in / 16 out)
	T1-40(S) + DI116 + DD116	72 points (48 in / 24 out)

## 1. System Configuration

- Available I/O expansion configuration (continued)

Model	Unit configuration	I/O points
T1-40 or T1-40S	<div style="display: flex; justify-content: space-around; align-items: center;"> <div style="border: 1px solid black; padding: 2px;">T1-40(S)</div> <div>+</div> <div style="border: 1px solid black; padding: 2px;">DI116</div> <div>+</div> <div style="border: 1px solid black; padding: 2px;">DO116</div> </div> <p style="text-align: center;">or</p> <div style="display: flex; justify-content: space-around; align-items: center;"> <div style="border: 1px solid black; padding: 2px;">T1-40(S)</div> <div>+</div> <div style="border: 1px solid black; padding: 2px;">DD116</div> <div>+</div> <div style="border: 1px solid black; padding: 2px;">DD116</div> </div>	72 points (40 in / 32 out)
	<div style="display: flex; justify-content: space-around; align-items: center;"> <div style="border: 1px solid black; padding: 2px;">T1-40(S)</div> <div>+</div> <div style="border: 1px solid black; padding: 2px;">DD116</div> <div>+</div> <div style="border: 1px solid black; padding: 2px;">DO116</div> </div>	72 points (32 in / 40 out)
	<div style="display: flex; justify-content: space-around; align-items: center;"> <div style="border: 1px solid black; padding: 2px;">T1-40(S)</div> <div>+</div> <div style="border: 1px solid black; padding: 2px;">DO116</div> <div>+</div> <div style="border: 1px solid black; padding: 2px;">DO116</div> </div>	72 points (24 in / 48 out)
	<div style="display: flex; justify-content: space-around; align-items: center;"> <div style="border: 1px solid black; padding: 2px;">T1-40(S)</div> <div>+</div> <div style="border: 1px solid black; padding: 2px;">Exp 32</div> </div>	72 points (40 in / 32 out)
	<div style="display: flex; justify-content: space-around; align-items: center;"> <div style="border: 1px solid black; padding: 2px;">T1-40(S)</div> <div>+</div> <div style="border: 1px solid black; padding: 2px;">Exp 32</div> </div> <div style="margin-left: 20px;">+ Option cards (any combinations)</div>	104 points
	<div style="display: flex; justify-content: space-around; align-items: center;"> <div style="border: 1px solid black; padding: 2px;">T1-40(S)</div> <div>+</div> <div style="display: flex; align-items: center;"> <div style="border: 1px solid black; width: 15px; height: 20px; margin-right: 5px;"></div> <div style="border: 1px solid black; width: 15px; height: 20px; margin-right: 5px;"></div> </div> <div style="margin-left: 5px;">(BU152)</div> </div>	168 points
	<div style="display: flex; justify-content: space-around; align-items: center;"> <div style="border: 1px solid black; padding: 2px;">T1-40(S)</div> <div>+</div> <div style="display: flex; align-items: center;"> <div style="border: 1px solid black; width: 15px; height: 20px; margin-right: 5px;"></div> <div style="border: 1px solid black; width: 15px; height: 20px; margin-right: 5px;"></div> </div> <div style="margin-left: 5px;">(BU152)</div> </div> <div style="margin-left: 20px;">+ Option cards (any combinations)</div>	200 points
	<div style="display: flex; justify-content: space-around; align-items: center;"> <div style="border: 1px solid black; padding: 2px;">T1-40(S)</div> <div>+</div> <div style="display: flex; align-items: center;"> <div style="border: 1px solid black; width: 15px; height: 20px; margin-right: 5px;"></div> <div style="border: 1px solid black; width: 15px; height: 20px; margin-right: 5px;"></div> <div style="border: 1px solid black; width: 15px; height: 20px; margin-right: 5px;"></div> <div style="border: 1px solid black; width: 15px; height: 20px;"></div> </div> <div style="margin-left: 5px;">(BU154)</div> </div>	296 points
	<div style="display: flex; justify-content: space-around; align-items: center;"> <div style="border: 1px solid black; padding: 2px;">T1-40(S)</div> <div>+</div> <div style="display: flex; align-items: center;"> <div style="border: 1px solid black; width: 15px; height: 20px; margin-right: 5px;"></div> <div style="border: 1px solid black; width: 15px; height: 20px; margin-right: 5px;"></div> <div style="border: 1px solid black; width: 15px; height: 20px; margin-right: 5px;"></div> <div style="border: 1px solid black; width: 15px; height: 20px;"></div> </div> <div style="margin-left: 5px;">(BU154)</div> </div> <div style="margin-left: 20px;">+ Option cards (any combinations)</div>	328 points



- NOTE**
- (1) When the TOSLINE-F10 remote station (FR112) is used, only one additional option card can be inserted into the T1-40/T1-40S.
  - (2) In the above table, "Exp 32" means the expansion unit (T1-EDR32 or T1-EAR32).
  - (3) In the above table, I/O points of the combinations with an expansion rack show the maximum points using 64 points I/O modules.

## 1. System Configuration

### 1.5 Components

#### 1.5.1 Basic unit

The basic unit is available in four models, the T1-16, T1-28, T1-40 and T1-40S. And each model is available in three types, depending on the power supply and input types.

Model	Type	Power supply	Input	Output
T1-16	T1-MDR16	100-240 Vac, 50/60 Hz	8 points - dry contact (24 Vdc)	6 points - relay, 2 points - transistor
	T1-MAR16	100-240 Vac, 50/60 Hz	8 points - 120 Vac	6 points - relay, 2 points - triac
	T1-MDR16D	24 Vdc	8 points - 24 Vdc	6 points - relay, 2 points - transistor
T1-28	T1-MDR28	100-240 Vac, 50/60 Hz	14 points - 24 Vdc	12 points - relay, 2 points - transistor
	T1-MAR28	100-240 Vac, 50/60 Hz	14 points - 120 Vac	12 points - relay, 2 points - triac
	T1-MDR28D	24 Vdc	14 points - 24 Vdc	12 points - relay, 2 points - transistor
T1-40	T1-MDR40	100-240 Vac, 50/60 Hz	24 points -24 Vdc	14 points - relay, 2 points - transistor
	T1-MAR40	100-240 Vac, 50/60 Hz	24 points - 120 Vac	14 points - relay, 2 points - triac
	T1-MDR40D	24 Vdc	24 points -24 Vdc	14 points - relay, 2 points - transistor
T1-40S	T1-MDR40S	100-240 Vac, 50/60 Hz	24 points -24 Vdc	14 points - relay, 2 points - transistor
	T1-MAR40S	100-240 Vac, 50/60 Hz	24 points - 120 Vac	14 points - relay, 2 points - triac
	T1-MDR40SD	24 Vdc	24 points -24 Vdc	14 points - relay, 2 points - transistor



## 1. System Configuration

### ◆ T1-16

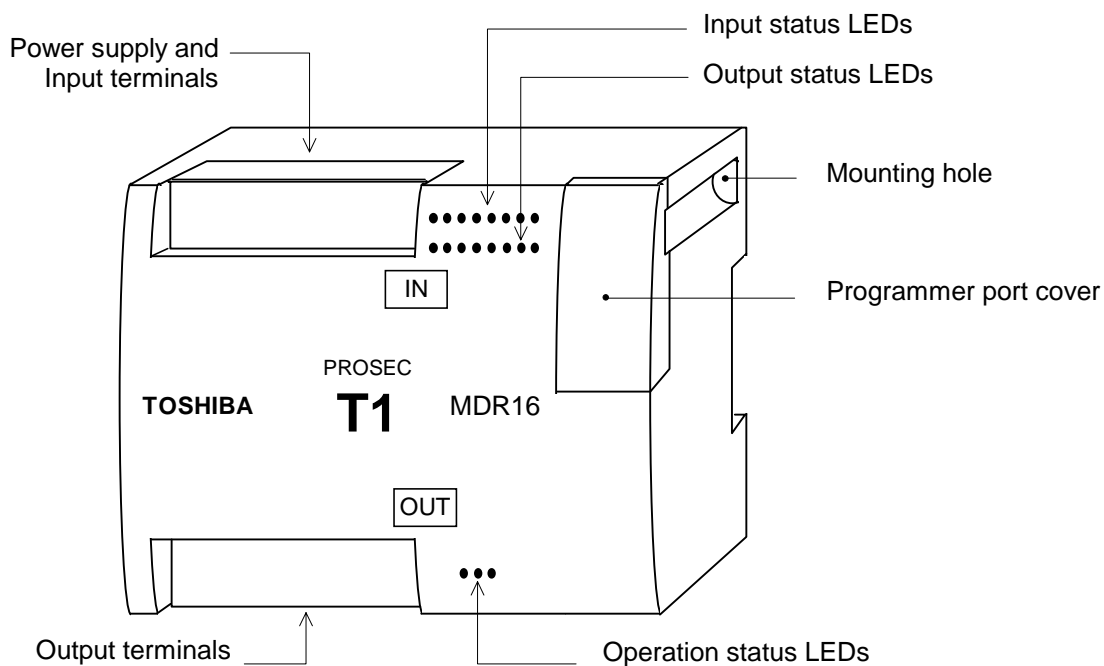

### ◆ T1-28

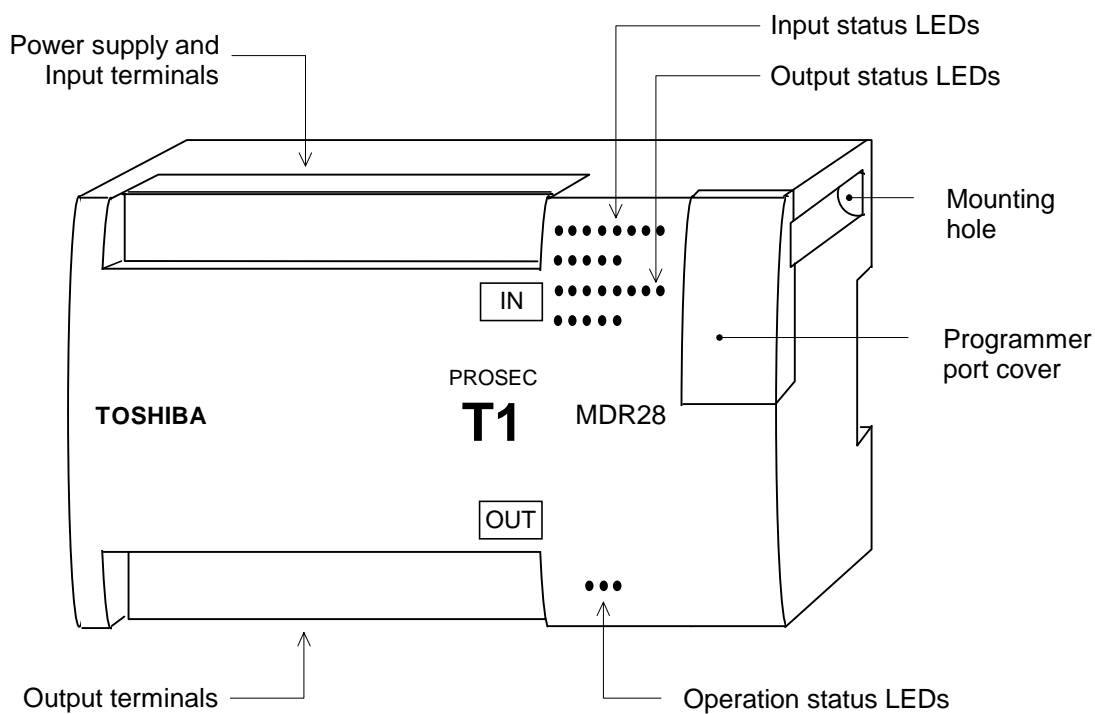

# 1. System Configuration

## ◆ T1-40

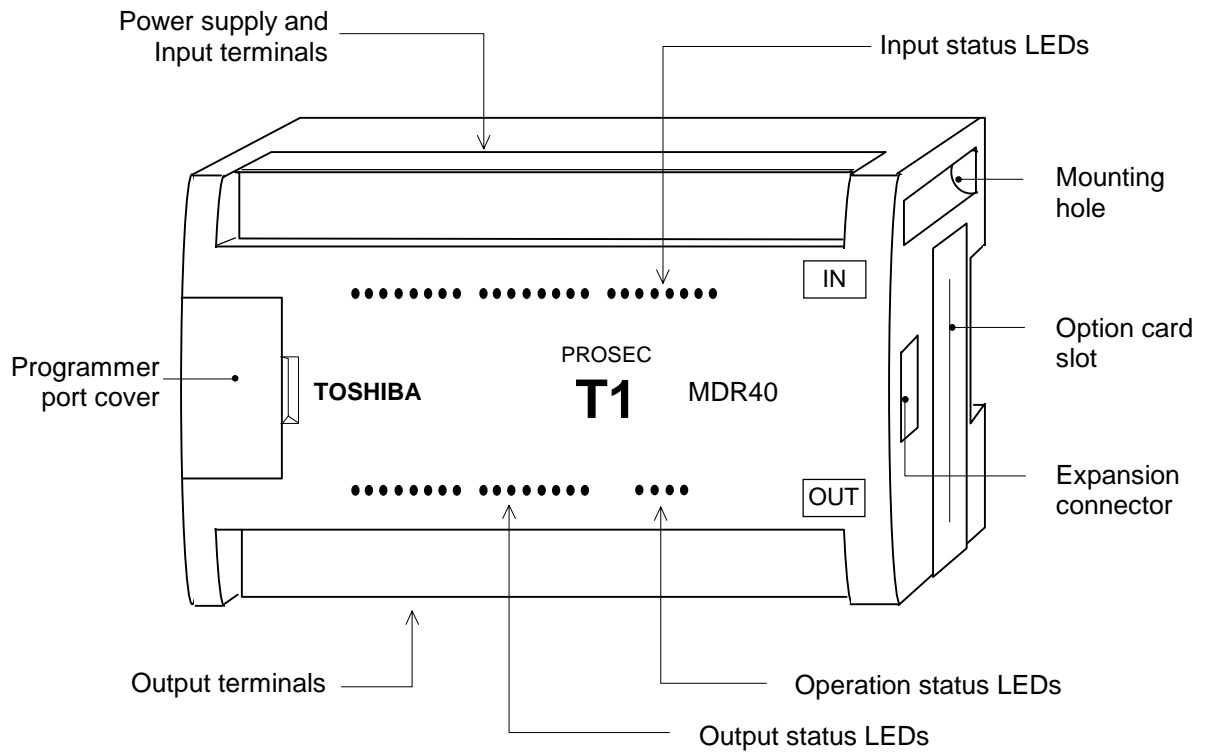

## ◆ T1-40S

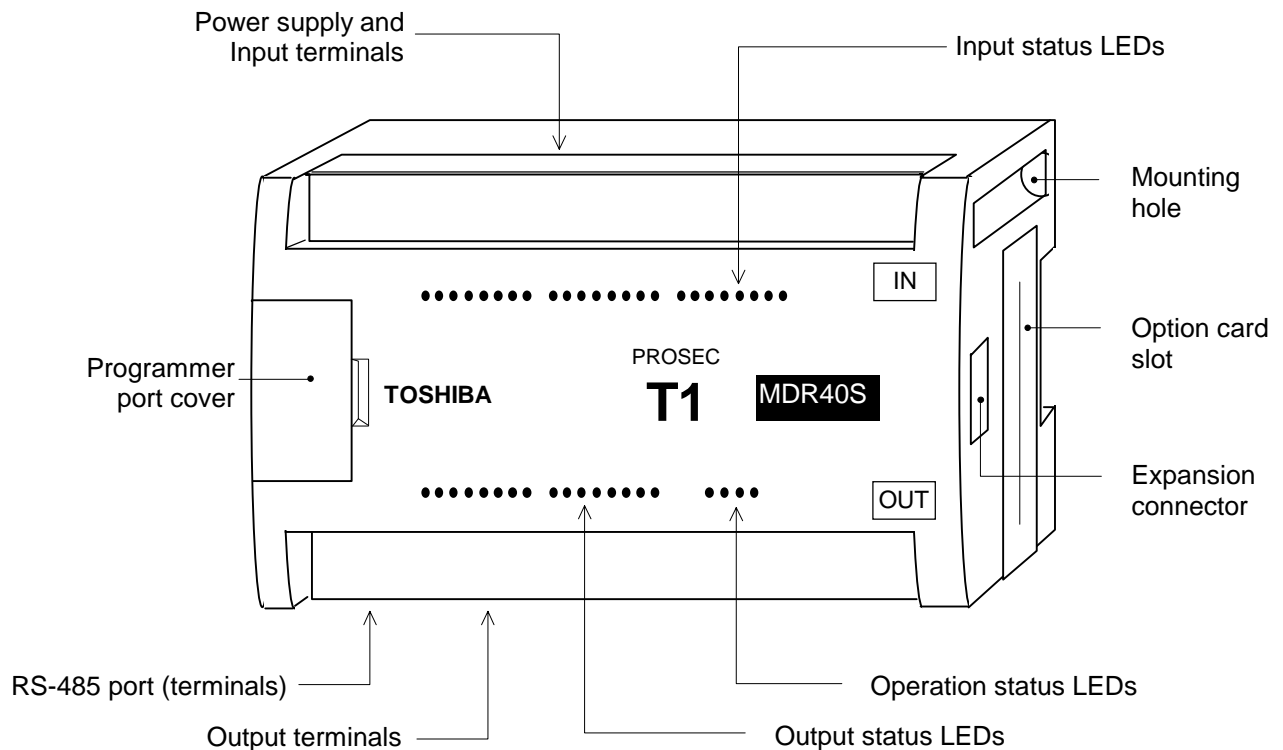

## 1. System Configuration

### ◆ Behind the programmer port cover

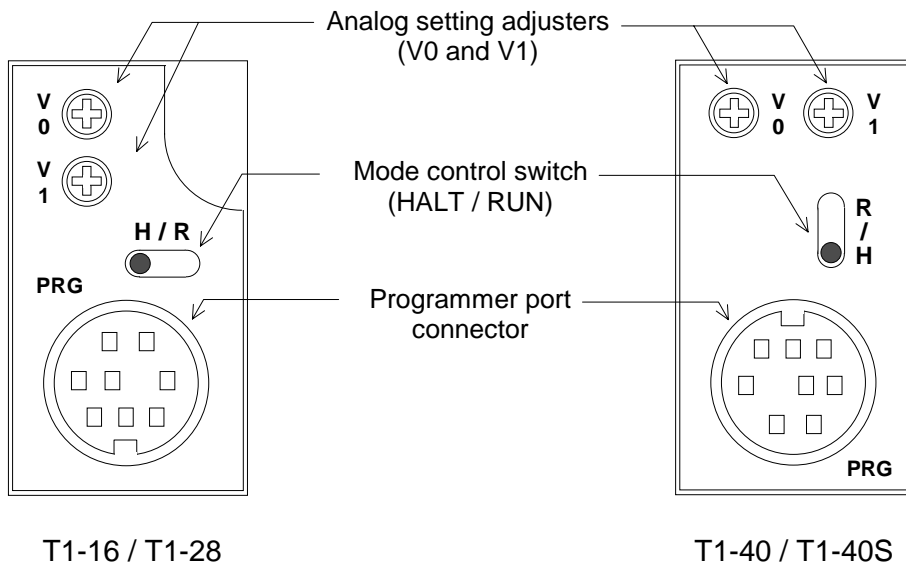

#### Power supply terminals:

Connect the power cable and grounding wire. The terminal screw size is M3.5. See sections 4.4 and 4.5 for wiring.

#### Input terminals:

Connect input signal wires. The terminal screw size is M3.5. See section 2.4 for details.

#### Output terminals:

Connect output signal wires. The terminal screw size is M3.5. See section 2.4 for details.

#### Input status LEDs:

Indicate the ON status of each input signal. (color: red)

#### Output status LEDs:

Indicate the ON status of each output signal. (color: red)

## 1. System Configuration

### Operation status LEDs:

Indicate the operation status of the T1/T1S.

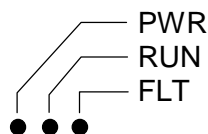

T1-16 / T1-28



T1-40 / T1-40S

PWR (Power) (green)	Lit	Internal 5 Vdc power is normal.
	Not lit	Internal 5 Vdc power is not normal.
RUN (green)	Lit	RUN mode (in operation)
	Blinking	HOLD mode
	Not lit	HALT mode or ERROR mode
FLT (Fault) (red)	Lit	ERROR mode
	Blinking	Hardware error (programmer cannot be connected)
	Not lit	Normal
AUX (Auxiliary) (red)	–	Can be controlled by user program. Lit when S320 is ON and unlit when S320 is OFF. (T1-40/T1-40S)

### Mode control switch:

Controls the operation modes of the T1/T1S.

H (HALT)	When the switch is turned to H (HALT) side, the T1/T1S stops program execution (HALT mode). In this position, RUN/HALT command from the programmer is disabled. In case of the T1, programming is available only in the HALT mode.
R (RUN)	When the switch is turned to R (RUN) side, the T1/T1S starts program execution. This is the position during normal operation. In this position, RUN/HALT command from the programmer is also available.

### Analog setting adjusters:

Two analog setting adjusters are provided. The V0 value is stored in SW30 and the V1 value is stored in SW31. The converted value range is 0 to 1000. Refer to section 8.5 for details of the analog setting function.

### Programmer port connector:

Used to connect the programmer cable. The interface is RS-232C. This port can also be used for the computer link function. Refer to section 1.6 for more information about the computer link function.

## 1. System Configuration

### Option card slot (T1-40/T1-40S):

Used to insert the option cards. Two slots are provided. Refer to separate “T1/T1S Use’s Manual – Expansion I/O –” for details of the option cards.

### Expansion connector (T1-40/T1-40S):

Used to connect the expansion rack or expansion unit. Refer to separate “T1/T1S Use’s Manual – Expansion I/O –” for details of the T2 type I/O modules.

### RS-485 port (T1-40S only):

Used to connect a computer (SCADA system), operator interface unit, other T1S, or many kinds of serial ASCII devices including Toshiba’s Inverter through RS-485 interface. Refer to section 1.7 for more information about the T1S’s RS-485 multi-purpose communication functions.

### Mounting holes:

Used to fix the T1/T1S on a mounting frame by screws. The mounting holes are provided at two opposite corners.

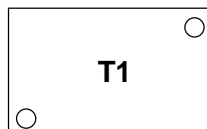

Use two M4 screws for mounting. See section 4.2 for installing the unit.

### DIN rail bracket:

The DIN rail bracket is provided at the rear for mounting the T1/T1S on a 35 mm DIN rail. See section 4.2 for installing the unit.

## 1. System Configuration

### 1.5.2 Option cards

The T1-40/T1-40S can hold up to two option cards for expanding I/O points, etc.

The following eight types of the option cards are available.

For details of the option cards, refer to the separate manual "T1/T1S User's Manual – Expansion I/O –".

Type	Description	Power supply
DI116	16 points input, 24 Vdc - 5 mA	Supplied from the basic unit (5 Vdc)
DO116	16 points output, 24 Vdc - 100 mA	
DD116	8 points input, 24 Vdc - 5 mA + 8 points output, 24 Vdc - 100 mA	
AD121	1 channel analog input, 0 to 5 V / 0 to 20 mA	
AD131	1 channel analog input, $\pm 10$ V	
DA121	1 channel analog output, 0 to 20 mA	
DA131	1 channel analog output, $\pm 10$ V	
FR112	TOSLINE-F10 remote station, 1 word input + 1 word output	

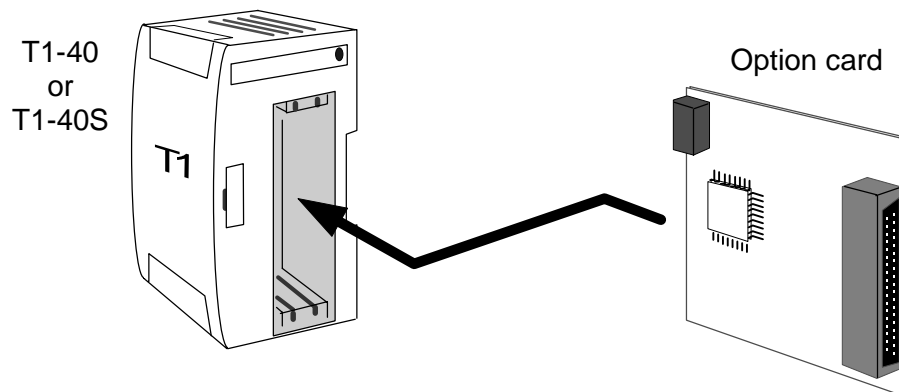

**NOTE** The TOSLINE-F10 remote card (FR112) can be used with other cards. However two FR112s cannot be used together.

## 1. System Configuration

### 1.5.3 Expansion rack

The T1-40/T1-40S can be connected to either one expansion rack or one expansion unit.

The following two types of the expansion racks are available. By using the expansion rack, T2 Series I/O modules can be used with the T1-40/T1-40S.

For details of the expansion rack, refer to the separate manual "T1/T1S User's Manual – Expansion I/O –".

Type	Description	Power supply
BU152	2 slots for I/O modules	Supplied from the basic unit
BU154	4 slots for I/O modules	

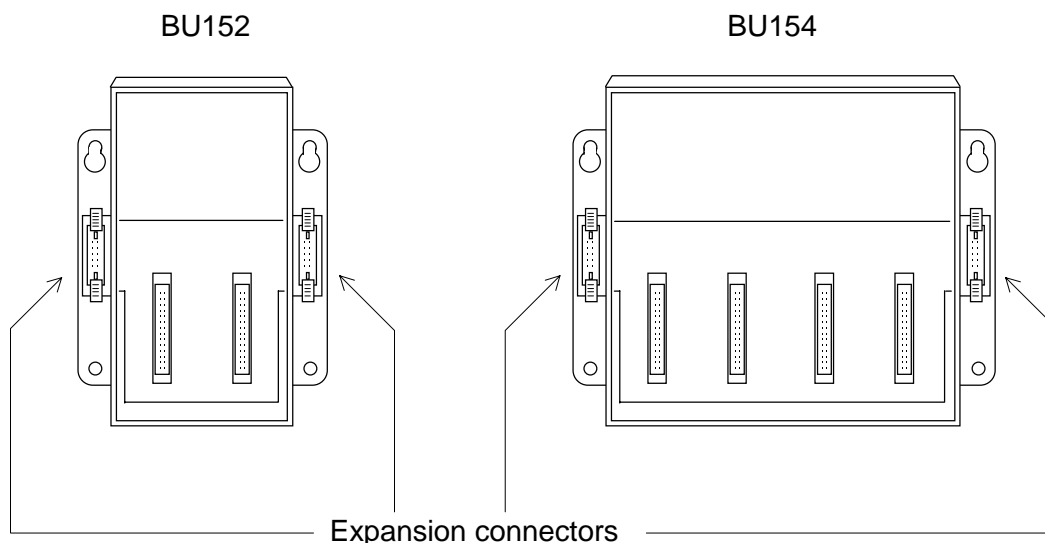

- NOTE**
- (1) A 0.15 m expansion cable is supplied with the expansion rack.
  - (2) Internal 5 Vdc power for I/O modules is supplied from the T1-40/T1-40S basic unit. No power supply module is required on the expansion rack.
  - (3) Expansion connectors are provided on the both sides. However either one can be used at a time.
  - (4) DIN rail bracket is not provided.

## 1. System Configuration

### 1.5.4 I/O modules

As listed below, various I/O modules are available for the T1-40/T1-40S, allowing it to be used for a wide variety of applications. Up to four I/O modules can be used with the T1-40/T1-40S by connecting the expansion rack.

For details of the I/O modules, refer to the separate manual "T1/T1S User's Manual – Expansion I/O –".

Type	Name	Specifications
DI31	DC/AC input	16 points (16 points/common), 12 to 24 Vdc/Vac
DI32	DC input	32 points (4 × 8 points/common), 24 Vdc
DI235		64 points (8 × 8 points/common), 24 Vdc
IN51	AC input	16 points (16 points/common), 100 to 120 Vac
IN61		16 points (16 points/common), 200 to 240 Vac
RO61	Relay output	12 points (3 × 4 points/common), 240 Vac/24 Vdc (max.), 2 A/point, 4 A/common (max.)
RO62		8 points (isolated), 240 Vac/24 Vdc (max.), 2 A/point (max.)
DO31	Transistor output (current sink)	16 points (16 points/common), 5 to 24 Vdc, 1 A/point, 1.2 A/4 points (max.)
DO32		32 points (4 × 8 points/common), 5 to 24 Vdc, 0.1 A/point (max.)
DO235		64 points (8 × 8 points/common), 5 to 24 Vdc, 0.1 A/point (max.)
DO233P	Transistor output (current source)	16 points (16 points/common), 5 to 24 Vdc, 1 A/point, 1.2 A/4 points (max.)
AC61	Triac output	12 points (3 × 4 points/common), 100 to 240 Vac, 0.5 A/point, 0.6 A/SSR (max.)
AI21	Analog input	4 channels, 1 to 5 V / 4 to 20 mA, 8-bit resolution
AI22		4 channels, 1 to 5 V / 4 to 20 mA, 12-bit resolution
AI31		4 channels, 0 to 10 V, 8-bit resolution
AI32		4 channels, ±10 V, 12-bit resolution
AO31	Analog output	2 channels, 1 to 5 V / 4 to 20 mA / 0 to 10 V, 8-bit resolution
AO22		2 channels, 1 to 5 V / 4 to 20 mA, 12-bit resolution
AO32		2 channels, ±10 V, 12-bit resolution
PI21	Pulse input	1 channel (2-phase and zero marker), 5/12 V, 100 kHz (max.), 24-bit counter
MC11	Positioning	1 axis, 200 kHz (max.), 5 to 24 Vdc, ±999999 pulses
CF211	Communication interface	1 port of RS-232C, full-duplex, ASCII code, 300 / 600 / 1200 / 2400 / 4800 / 9600 / 19200 bps



## 1. System Configuration

### 1.5.5 Expansion unit

The T1-40/T1-40S can be connected to either one expansion rack or one expansion unit.

The following two types of the expansion units are available. Each expansion unit has 32 points I/O (16 inputs and 16 outputs).

For details of the expansion unit, refer to the separate manual "T1/T1S User's Manual – Expansion I/O –".

Type	Description	Power supply
T1-EDR32	Input: 16 points, 24 Vdc - 7 mA Output: 16 points, relay, 240 Vac/24 Vdc (max.) - 2 A/point (max.)	Supplied from the basic unit (5Vdc)
T1-EAR32	Input: 16 points, 100 to 120 Vac - 7 mA Output: 16 points, relay, 240 Vac/24 Vdc (max.) - 2 A/point (max.)	



- NOTE**
- (1) A 0.5 m expansion cable is supplied with the expansion unit.
  - (2) Internal 5 Vdc power for expansion unit is supplied from the T1-40/T1-40S basic unit.
  - (3) 24 Vdc power for output relay coils is required externally.
  - (4) DIN rail bracket is provided.

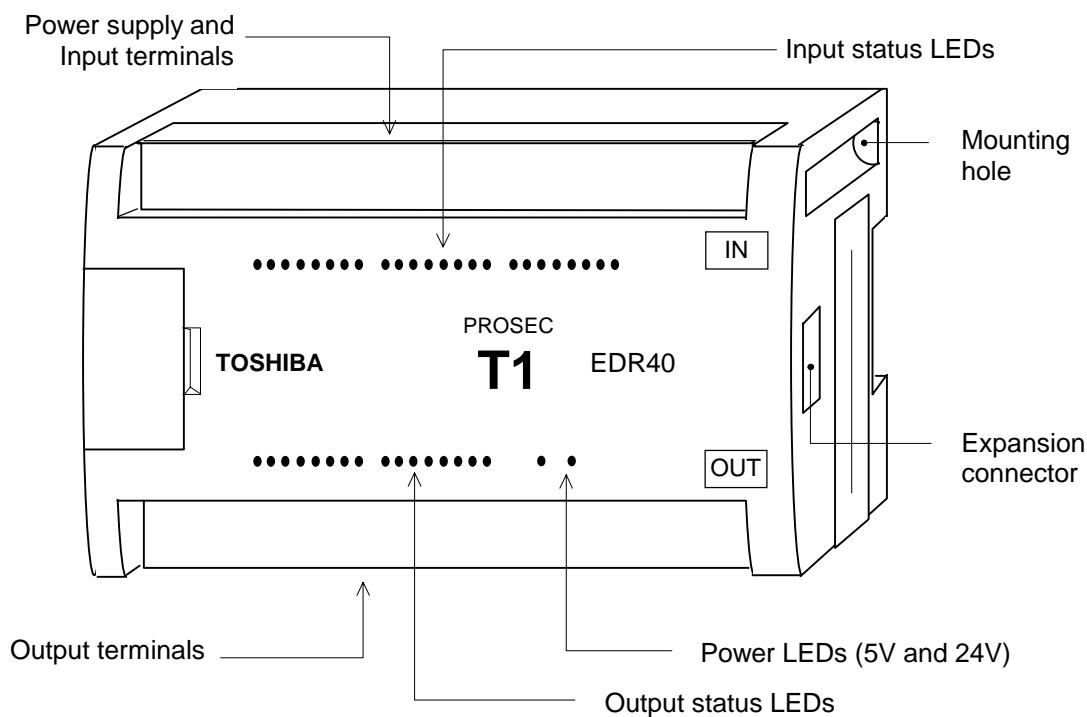

## 1. System Configuration

### 1.5.6 Options

The following optional items are available.

Item	Type	Description	
Programmer port connector	PT16S	For RS-232C computer link, with 2 m cable	
Option card I/O connector	PT15S	Cable side connector for DI116, DO116, or DD116	Soldering type
	PT15F		Flat cable type
Expansion cable	CS1R2	For connecting the expansion rack, 0.15 m length, (spare parts)	
	CS1R5B	For connecting the expansion unit, 0.5m length, (spare parts)	
Empty slot cover	–	For covering empty slot on the expansion rack	

## 1. System Configuration

### 1.6 Computer link system

The interface of the T1/T1S's programmer port is RS-232C. Normally this port is used to connect the programmer. However, this port can also be used for the computer link function.

The computer link is a data communication function between computer or operator interface unit and the T1/T1S. The data in the T1/T1S can be read and written by creating simple communication program on the computer. The computer link protocol of the T1/T1S is published in "T1/T1S User's Manual – Communication Function –".

Item	Specifications
Interface	Conforms to RS-232C
Transmission system	Half-duplex
Synchronization	Start-stop system (asynchronous)
Transmission speed	9600 bps (fixed)
Transmission distance	15 m max.
Framing	Start bit: 1 bit Data bits: 8 bits (fixed) Parity: Odd or none Stop bit: 1 bit (fixed)
Protocol	T-series computer link (ASCII) Programmer (binary)
Transmission delay option	0 to 300 ms

By using the multi-drop adapter (CU111), multiple T1/T1Ss can be connected on an RS-485 line. The T-series PLC programming software (T-PDS) can also be used in this configuration.

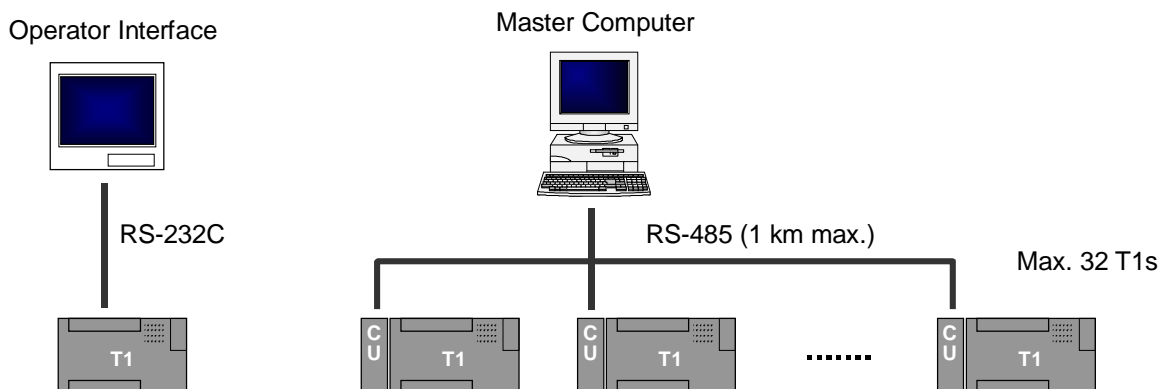

#### NOTE

In case of the T1, there are functional limitations as follows.

- Multi-drop configuration is available with version 1.10 or later.
- Programmer connection in the multi-drop configuration, none parity and transmission delay options are available with version 1.20 or later.

## 1. System Configuration

### 1.7 T1S communication function

The T1S has an RS-485 multi-purpose communication port. This port can work independent of the programmer port.

By using this communication port, one of the following three communication modes is available, computer link mode, data link mode and free ASCII mode.

For details of these functions, refer to the separate manual "T1/T1S User's Manual – Communication Function –".

Item	Computer link	Free ASCII	Data link
Interface	Conforms to RS-458 (4-wire or 2-wire)		
Transmission system	Half-duplex		
Synchronization	Start-stop system (asynchronous)		
Transmission code	ASCII/binary	ASCII	Binary
Transmission speed	300, 600, 1200, 2400, 4800, 9600, or 19200 bps		19200 bps (fixed)
Transmission distance	1 km max.		
Framing	Start bit: 1 bit Data bits: 7 or 8 bits Parity: Odd, even, or none Stop bit: 1 or 2 bits		Special
Protocol	T-series computer link (ASCII), Programmer (binary)	User defined ASCII messages	Special
Link configuration	1-to-N	N/A	1-to-1
Transmission delay option	0 to 300 ms	N/A	N/A

#### Computer link mode

T-series computer link protocol can be used in this mode. A maximum of 32 T1Ss can be connected to a master computer.

By using this mode, all the T1S's data can be accessed by a master computer.

The T-series PLC programming software (T-PDS) can also be used in this configuration.

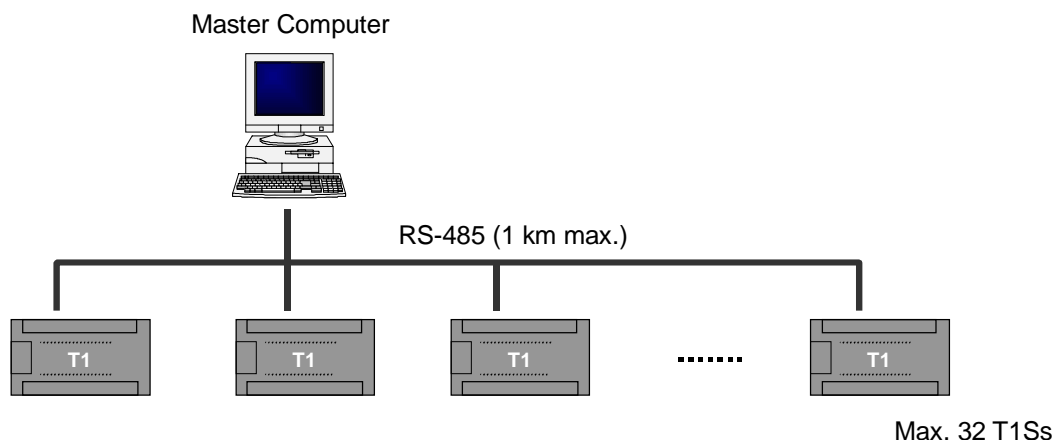

## 1. System Configuration

### Data link mode

Two PLCs (any combination of T1S, T2E or T2N) can be directly linked together. This direct link is inexpensive, easily configured and requires no special programming. Data registers D0000 to D0031 are used for the data transfer.

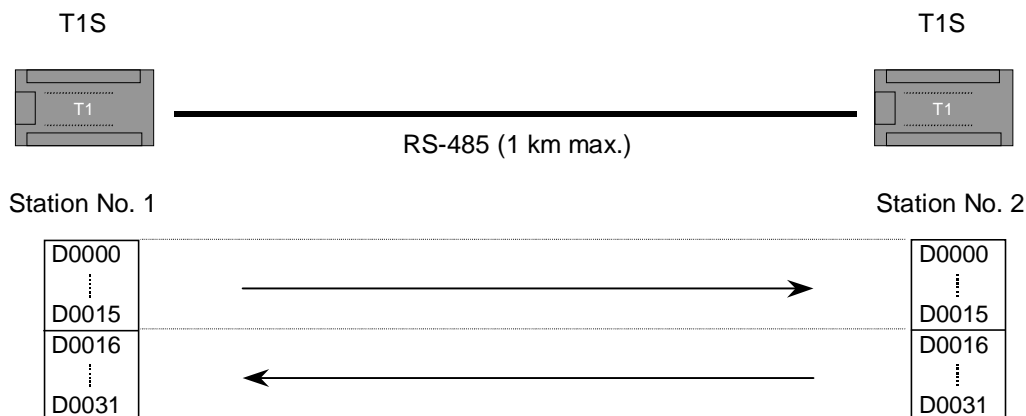

### Free ASCII mode

User defined ASCII messages can be transmitted and received through this port. A terminal, printer, bar-code reader, or other serial ASCII device can be directly connected. This mode also allows the T1S to communicate with other PLCs (T1, T2E, T2N, etc.), Toshiba's Inverters (such as VF-S7/A5, G3), Toshiba's motor protection relay (S2E21), or others.

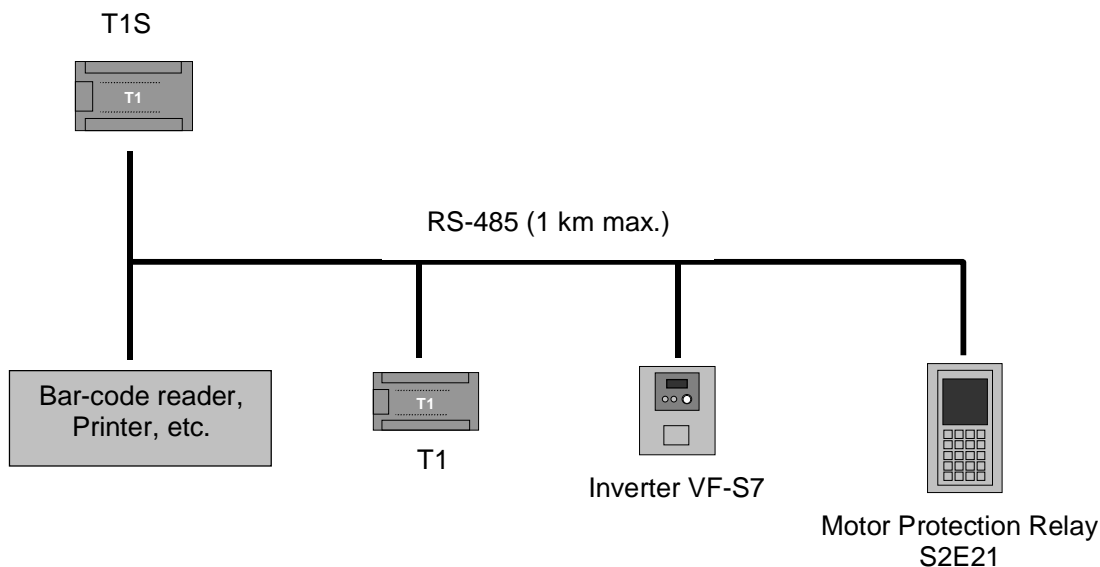

## 1. System Configuration

### 1.8 Real-time data link system

#### TOSLINE-F10

TOSLINE-F10 is a high speed data transmission system suited for small points I/O distribution system. By inserting the TOSLINE-F10 remote card (FR112) into the T1-40/T1-40S, the T1-40/T1-40S can work as a remote station of the TOSLINE-F10 network. On this network, the T1-40/T1-40S sends 1 word data to the master station and receives 1 word data from the master station.

Item	TOSLINE-F10 system specifications	
	High speed mode	Long distance mode
Topology	Bus (terminated at both ends)	
Transmission distance (without repeater)	500 m max. (total)	1 km max. (total)
Transmission speed	750 kbps	250 kbps
Scan transmission capacity	512 points (32 words) max.	
Scan cycle	7 ms/32 words	12 ms/32 words
Error checking	CRC check	



- (1) Refer to the separate "T1 User's Manual – Option Card and I/O Module –" for details of the TOSLINE-F10 remote card (FR112).
- (2) Refer to the separate TOSLINE-F10 User's Manual for details of overall TOSLINE-F10 system.

#### Typical data link configuration

The figure below shows the typical data link configuration.

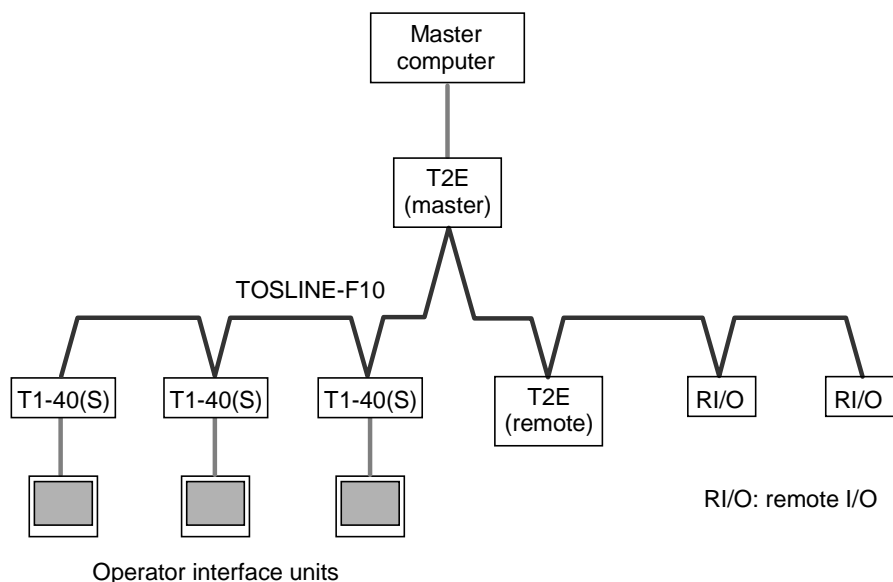

# 1. System Configuration

## 1.9 Peripheral tools

The following peripheral tools are available for the T1/T1S.

### T-Series Program Development System (T-PDS)

The T-Series Program Development System (T-PDS) is a software which runs on any IBM-PC compatible personal computers such as Toshiba's Notebook computers. The same T-PDS software supports on-line/off-line programming, debugging and program documentation for all the T-Series programmable controllers T1/T1S, T2/T2E/T2N and T3/T3H.

- User-friendly program editor includes cut & paste, address search & replace, program block move/copy, etc.
- Group programming – part program development by multiple designers and merging them into a complete program – enhance the software productivity.
- Powerful monitoring, I/O force and data set functions fully support your program debugging.
- Documentation of programs with commentary makes your maintenance work easy.
- Remote monitoring/programming via modem (radio/phone) is possible.

The table below shows the T-PDS versions that support the T1/T1S.

Type	Part number	Versions available for	
		T1	T1S
T-PDS for Windows	TMW33E1SS	Ver 1.0 or later <sup>*1)</sup>	Ver 1.2 or later
T-PDS for MS-DOS	TMM33I1SS	Ver 1.61 or later <sup>*1)</sup>	Ver 2.1 or later

\*1) The T1S can be used with these versions. However, in this case, there are the following functional limitations.

- The program size setting is only available as 2 k. It is set to 4 k mode in the T1S.
- Some of the added instructions (MAVE, DFL, HTOA, ATOH) may not be edited/monitored. (depending on the version)



The connection cable for the T1 Series is different from that for upper T-Series PLCs. These cables are supplied separately.

Connection cable for T1/T1S ... Type: CJ105, 5 m length

Connection cable for T2/T3 .... Type: CJ905, 5 m length

## 1. System Configuration

### T-Series Handy Programmer (HP911A)

The HP911A is a hand-held programmer, that can be used to program the T1/T1S using ladder diagram. Its portability makes it ideal for maintenance use at remote locations.

The HP911A has the following features.

- The HP911A supports ladder diagram programming of T-Series programmable controllers T1/T1S, T2/T2E/T2N and T3.
- Built-in EEPROM allows program copy between T-Series controllers.
- Two display modes are available,
  - Normal: 5 lines and 12 columns
  - Zoom: Full device description
- On-line data set and I/O force are useful for system checking.
- Backlit LCD display allows operation in dim light.

There are two types of the Handy Programmer (HP911) depending on the cable included with.

Type	Part number	Cable included with	Versions available for T1/T1S
HP911A	THP911A*S	2 m cable for T1/T1S	Ver 1.1 or later
HP911	THP911**S	2 m cable for the upper T-series PLCs	Ver 1.1 or later

The T1S can be used with the HP911(A). However, there are the following functional limitations.

- The program size setting is only available as 2 k. It is set to 4 k mode in the T1S.
- Some of the added instructions (MAVE, DFL, HTOA, ATOH) cannot be edited/monitored.



#### NOTE

A 2 m connection cable for the T1/T1S (Type: CJ102) is supplied with the HP911A. The cable for the T2/T3 is available separately. (Type: CJ902, 2 m length)



## 1. System Configuration

### Program Storage Module (RM102)

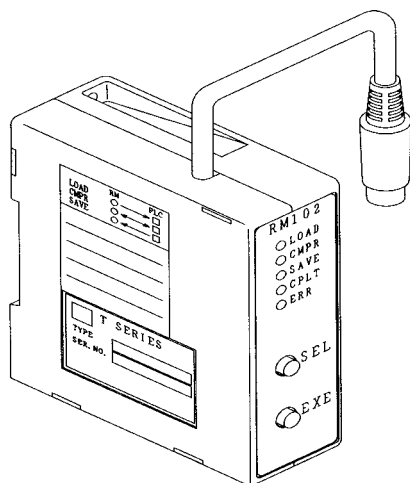

The program storage module (RM102) is an external memory for storing the T1/T1S program. By using the RM102, program saving from the T1/T1S to the RM102, and program loading from the RM102 to the T1/T1S can be done without need of a programmer. Because the RM102 has an EEPROM, maintenance-free program storage and quick saving/loading are available.

### Multi-drop adapter (CU111)

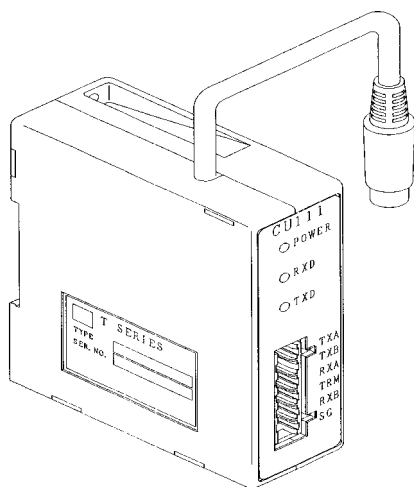

The T1/T1S's RS-232C programmer port supports the computer link function. When two or more T1/T1Ss are connected with a master computer, the multi-drop adapter (CU111) can be used. (One-to-N configuration) The CU111 is an RS-232C/RS-485 converter specially designed for the T1/T1S's programmer port.



---

## *Section 2*

# *Specifications*

---

- 2.1 General specifications, 42*
- 2.2 External dimensions, 43*
- 2.3 Functional specifications, 46*
- 2.4 I/O specifications, 48*

## 2. Specifications

### 2.1 General specifications

Item		T1-16	T1-28	T1-40	T1-40S
AC Power	Power supply voltage	100 to 240 Vac (+10/-15 %), 50/60 Hz			
	Power consumption	30 VA or less		38 VA or less	45 VA or less
	Inrush current	50 A or less (at 240 Vac, cold start)			
	24 Vdc output rating (24 Vdc, $\pm 10\%$ )	0.1 A for service power + power for dry contact inputs	0.2 A (for external devices and/or for input signals)		
	5 Vdc output rating	-		1 A (for option card and/or expansion rack/unit)	
DC Power	Power supply voltage	24 Vdc (+20/-15 %)			
	Power consumption	12 W or less		18 W or less	
	Inrush current	25 A or less (at 24 Vdc)			
	5 Vdc output rating	-		1 A (for option card and/or expansion rack/unit)	
Retentive power interruption	10 ms or less				
Insulation resistance	10 M $\Omega$ or more (between power terminals and ground terminal)				
Withstand voltage	1500 Vac - 1 minute (between power terminals and ground terminal)				
Ambient temperature	0 to 55 °C (operation), -20 to 75 °C (storage)				
Ambient humidity	20 to 90% RH, no condensation				
Noise immunity	1000 V p-p/1 $\mu$ s, Conform to EMC Directive 89/336/EEC				
Vibration immunity	16.7 Hz - 3 mm p-p (3 mutually perpendicular axes)				
Shock immunity	98 m/s <sup>2</sup> (10 g) (3 shocks per axis, on 3 mutually perpendicular axes)				
Approximate weight	500 g	700 g	800 g		
	Option card:	50 g	2-slot expansion rack:	600 g	
	Expansion unit:	600 g	4-slot expansion rack:	800 g	

#### NOTE



- (1) 24 Vdc service power output is not provided on the AC input type and DC power supply type.
- (2) 5 Vdc output capacity of T1-40/T1-40S is reduced by 0.2 A with using HP911A, and by 0.1 A with using RS-485 port.

## 2. Specifications

### 2.2 External dimensions

#### ◆ T1-16

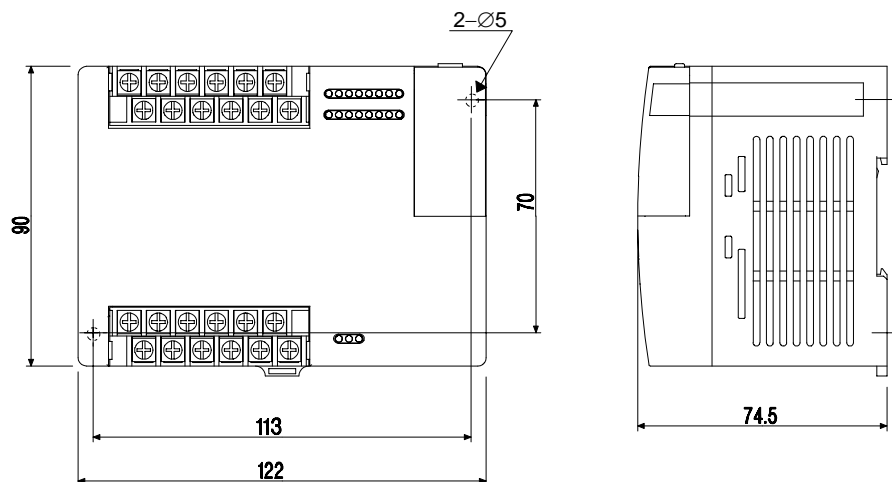

#### ◆ T1-28

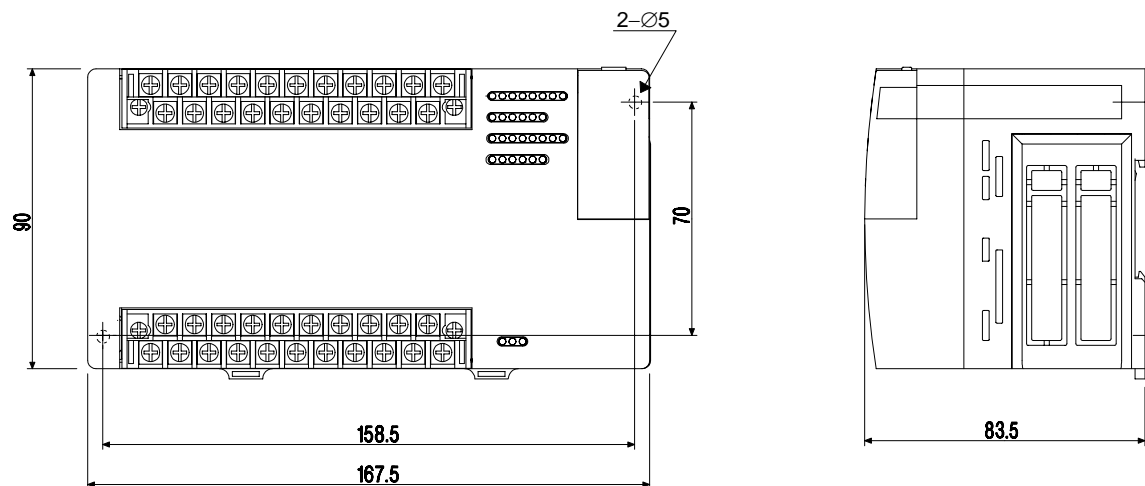

[mm]

## 2. Specifications

◆ T1-40/T1-40S, Expansion unit

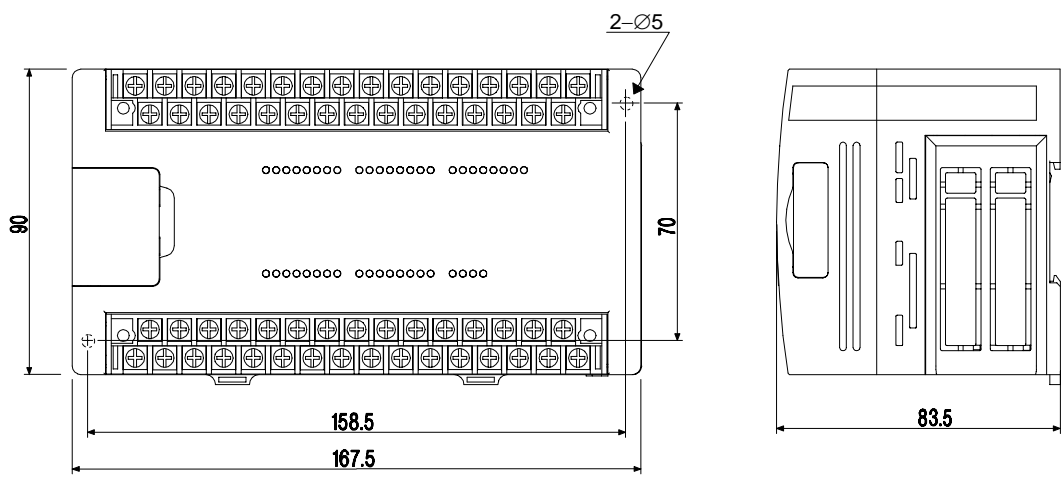

◆ Option card

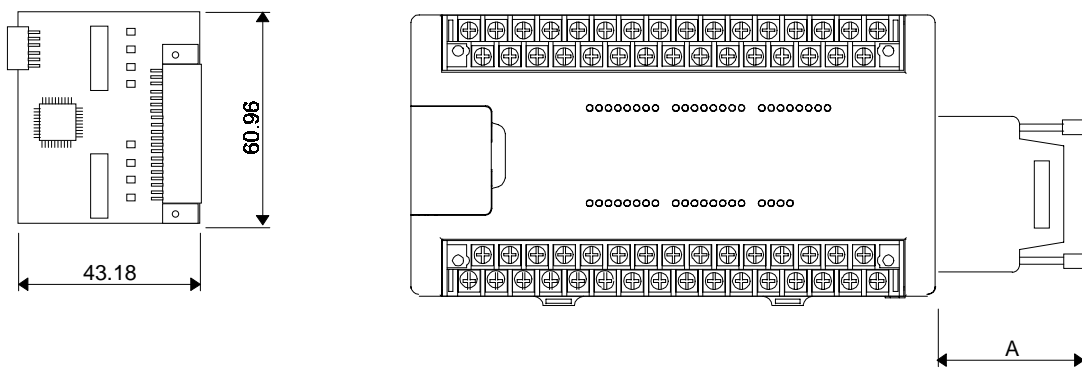

Additional space for Option card connector

Card type	A
DI116, DO116, DD116	55
AD121, AD131, DA121, DA131	16
FR112	11

[mm]

## 2. Specifications

### ◆ 2-slot expansion rack

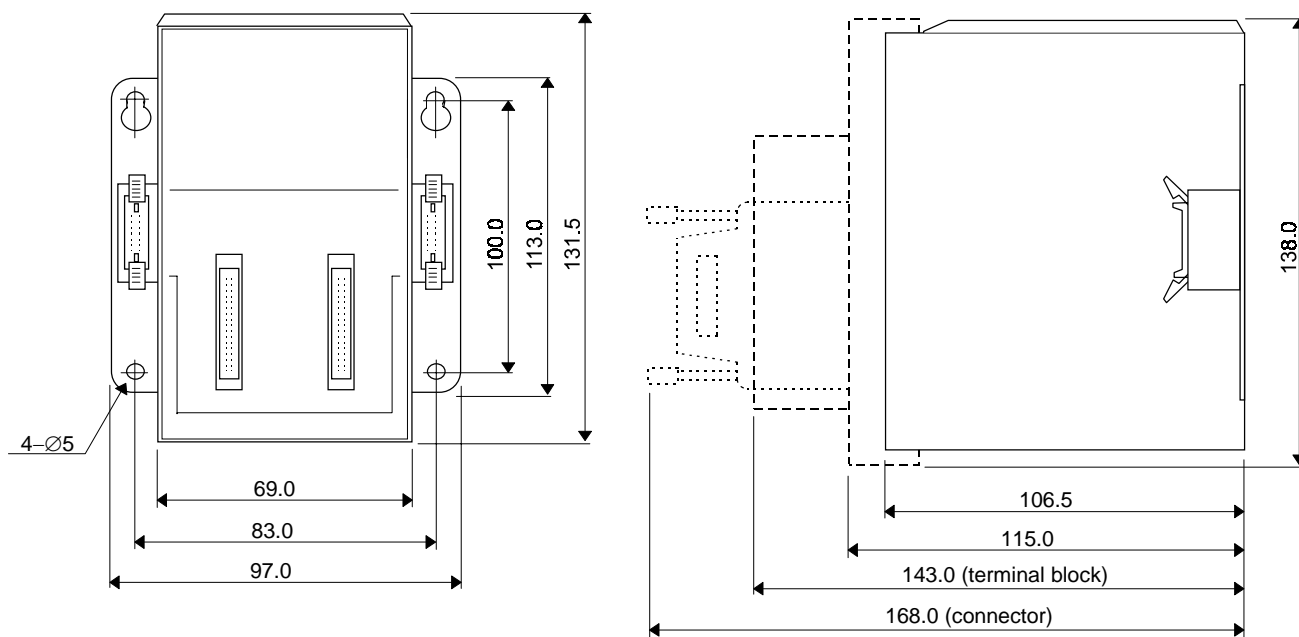

### ◆ 4-slot expansion rack

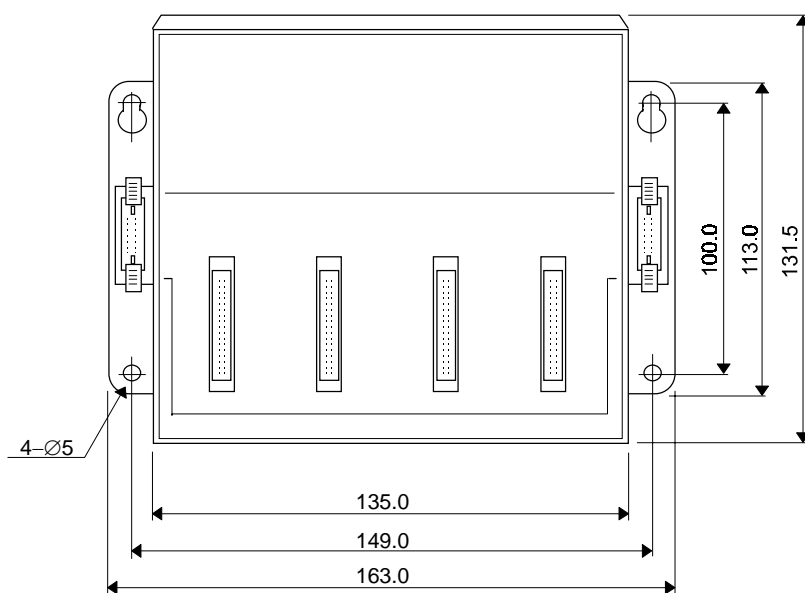

[mm]

## 2. Specifications

### 2.3 Functional specifications

Item		T1-16	T1-28	T1-40	T1-40S
Control method		Stored program, cyclic scan system			
Scan system		Floating scan or constant scan (10 - 200 ms, 10 ms units)			
I/O update		Batch I/O refresh (direct I/O instruction available)			
Program memory		RAM (capacitor back-up) and EEPROM (no back-up battery required)			
RAM memory back-up		6 hours (25°C)			168 hours (25°C)
Program capacity		2 k steps			8 k steps (4 k or 8 k mode)
Programming language		Ladder diagram with function block			
Instructions		Basic ladder instructions: 17 Function block instructions: 76			Basic: 21 Function: 99
Execution speed		1.4 µs/contact, 2.3 µs/coil, 4.2 µs/16-bit transfer, 6.5 µs/16-bit addition			
Program types		1 main program			
		1 sub-program (initial program)			
		1 timer interrupt (interval: 5 to 1000 ms, 5 ms units)			
		4 I/O interrupt (high-speed counter and interrupt input)			
		16 subroutines (nesting not available)			256 subroutines (up to 3 levels of nesting)
User data	I/O register	512 points/32 words (X/XW, Y/YW)			
	Auxiliary relay	1024 points/64 words (R/RW)			4096 points/ 256 words (R/RW)
	Special relay	1024 points/64 words (S/SW)			
	Timer	64 points (T./T), 32 @ 0.01 s, 32 @ 0.1 s			256 points (T./T) 64 @ 0.01 s, 192 @ 0.1 s
	Counter	64 points (C./C)			256 points (C./C)
	Data register	1024 words (D)			4096 words (D)
	Index register	3 words (I, J, K)			
I/O capacity		16 points (fixed)	28 points (fixed)	40 points (basic) + 32 points (option cards) + 16 words (I/O modules)	
Input type	DC input type (Note)	Dry contact input (AC PS), 24 Vdc input (DC PS)		24 Vdc input	
	AC input type	100 - 120 Vac input			
Output type	DC input type	Relay + transistor (2 points)			
	AC input type	Relay + triac (2 points)			
I/O terminal block		Fixed		Removable	



## 2. Specifications

### Functional specifications (cont'd)

Item	T1-16	T1-28	T1-40	T1-40S
Real-time clock /calendar	No			Yes, (±30 s/month)
Special I/O functions (Note)	High speed counter (2 single or 1 quadrature), Interrupt input (2 points), Adjustable analog register (2 points), Pulse output (CW+CCW or pulse+direction), PWM output			
Communications interface	1 port RS-232C (programmer port) - for Programmer or Computer link connection			
	-			1 port RS-485 - Programmer - Computer link - Data link - Free ASCII
	-			TOSLINE-F10 remote (by option card)
Debug support function	Sampling trace (8 devices - 256 times or 1 register - 128 times)			Sampling trace (8 devices and 3 register - 256 times)
	-			On-line programming
	-			On-line EEPROM write

#### NOTE



- (1) The input specification of the T1-16 (AC power type) is dry contact input, which supplies the power for input signals (24 Vdc) from the unit. Other types are DC input, which requires external power for input signals.
- (2) High speed counter, interrupt input, pulse output and PWM output are available in the DC input types.
- (3) High speed counter and interrupt input cannot be used simultaneously.
- (4) Pulse output and PWM output cannot be used simultaneously.

## 2. Specifications

### 2.4 I/O specifications

#### 2.4.1 T1-16

- T1-16 input specifications

Item	Specifications		
	DC input type		AC input type
	AC power type	DC power type	
Input type	Dry contact input, current source or sink <sup>*1</sup>	DC input, current source or sink <sup>*2</sup>	AC input
Number of input points	8 points (8 points/common)		8 points (8 points/common)
Rated input voltage	Supplied from T1-16 (24 Vdc, $\pm 10\%$ )	24 Vdc, $\pm 10\%$	100 - 120 Vac, $\pm 10\%$ - $\pm 15\%$ , 50/60 Hz
Rated input current	7 mA (at 24 Vdc)		7 mA (at 100 Vac)
ON level	Contact close (max. 1.2 k $\Omega$ )	Min. ON voltage: 15 Vdc	Min. ON voltage: 80 Vac
OFF level	Contact open (min. 20 k $\Omega$ )	Min. OFF voltage: 5 Vdc	Max. OFF voltage: 30 Vac
ON delay time	0 to 15 ms <sup>3</sup>		25 ms or less + user setting <sup>4</sup>
OFF delay time	0 to 15 ms <sup>3</sup>		30 ms or less + user setting <sup>4</sup>
Input signal display	LED display for all points, lit at ON, internal logic side		
External connection	Terminal block (fixed), M3.5		
Withstand voltage	1500 Vac, 1 minute (between internal and external circuits)		
Internal circuit	<p style="text-align: center;">24 Vdc (AC power type only)</p>		

- \*1: The input current direction (source or sink) of the dry contact input can be selected by the internal jumper plug. (Factory setting = current source) Refer to section 3.1.
  - ┌ 3 side: current flows from input terminal to (-) terminal (current source)
  - └ 1 side: current flows from (+) terminal to input terminal (current sink)
- \*2: The jumper plug of the DC power supply type must be set to 1 side.
- \*3: The input ON/OFF delay time of the DC input type can be changed by user. The setting range is 0 to 15 ms. (Default value = 10 ms) Refer to section 8.2.
- \*4: The input ON/OFF delay time of the AC input can be extended by user. The extension setting range is 0 to 15 ms. (Default value = 10 ms) Resulting the default delay times are 35 ms (ON delay) and 40 ms (OFF delay). Refer to section 8.2.

## 2. Specifications

- Input signal connections

### < DC input (AC power) type >

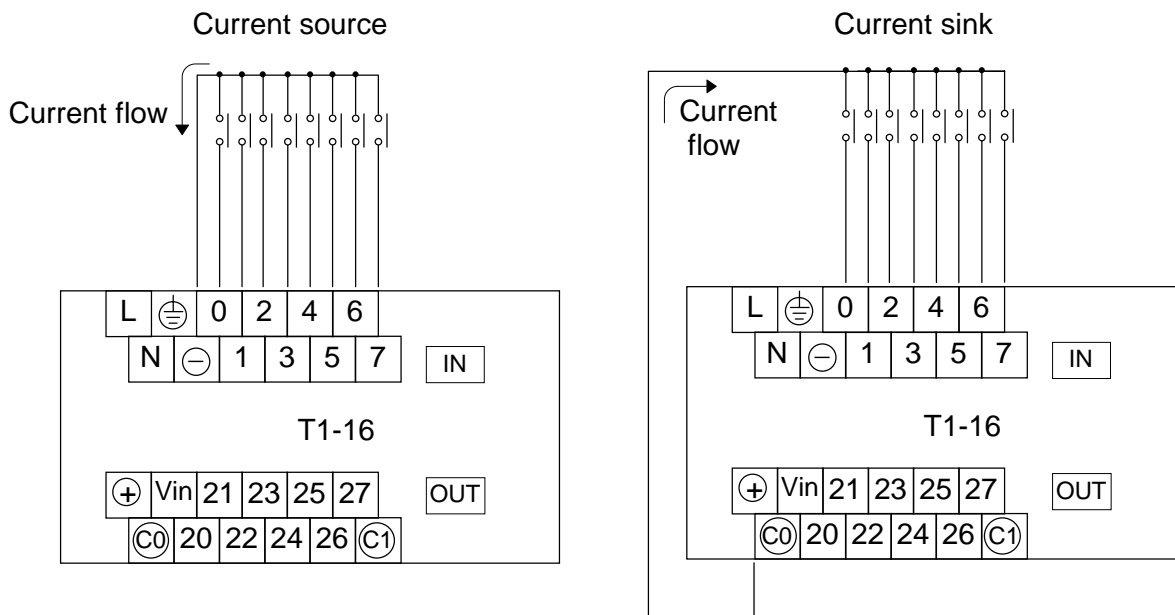

Note) The factory setting is current source.

### < DC input (DC power) type >

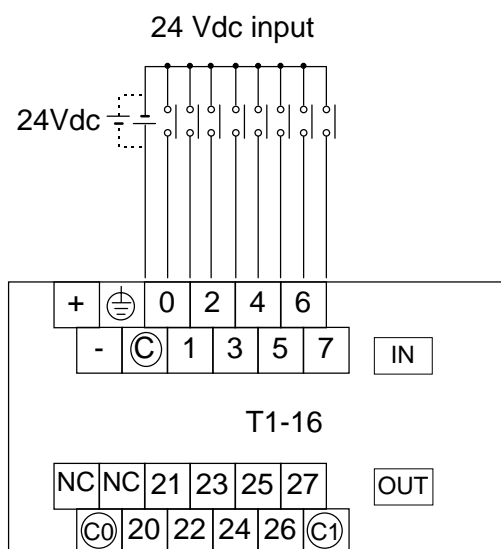

Note) 24 Vdc service power output is not provided on the DC power supply type.

### < AC input type >

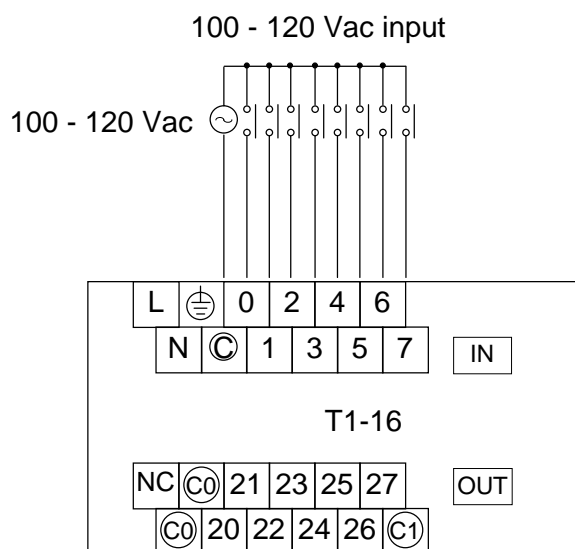

## 2. Specifications

### • T1-16 output specifications

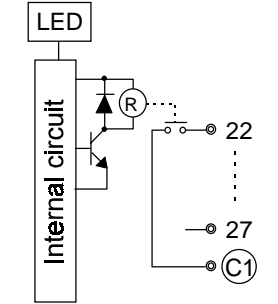
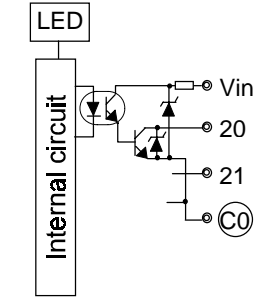
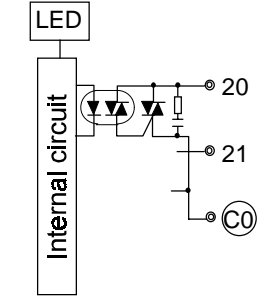
Item	Specifications		
	Relay output (both DC input and AC input types)	Transistor output (DC input type)	Triac output (AC input type)
Output type	Relay contact, normally open	Transistor output, current sink	Triac output
Number of output points	6 points (6 points/common)	2 points (2 points/common)	2 points (2 points/common)
Rated load voltage	240 Vac/24 Vdc (max.)	24 Vdc	100 - 240 Vac (50/60 Hz)
Range of load voltage	Max. 264 Vac/125Vdc	20.0 - 28.0 V	24 - 264 Vac (47 - 63 Hz)
Maximum load current	2 A/point (resistive), 4 A/common	0.5 A/point (resistive)	1.0 A/point (resistive)
ON resistance	50 m $\Omega$ or less (initial value)	–	–
Voltage drop at ON	–	1.5 V or less	1.5 V or less
Leakage current at OFF	None	0.1 mA or less	1 mA or less (at 100 Vac, 50 Hz), 2 mA or less (at 240 Vac, 50 Hz)
Minimum load	5 Vdc, 10 mA (50 mW)	–	100mA (24 Vac), 50mA (100 - 240 Vac)
ON delay time	10 ms or less	0.1 ms or less	1 ms or less
OFF delay time	10 ms or less	0.1 ms or less	1 ms + 1/2 cycle or less
Input signal display	LED display for all points, lit at ON, internal logic side		
External connection	Terminal block (fixed), M3.5		
Withstand voltage	1500 Vac, 1 minute (between internal and external circuits)		
Internal circuit			

- \*1: The switching life of the relay output is as follows.  
 20 million times or more (mechanical)  
 100 thousand times or more (electrical, at maximum rated voltage and current)

## 2. Specifications

- Output signal connections

### < DC input type – 6 relays and 2 transistors >

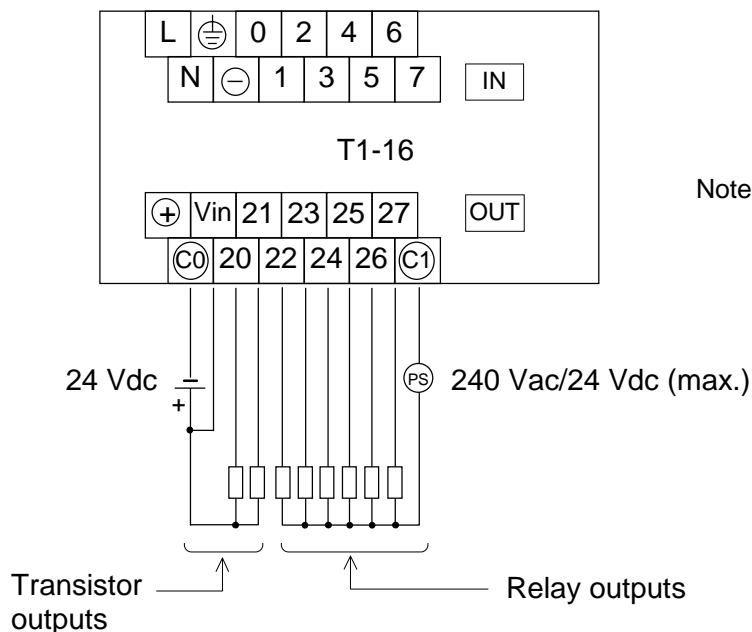

### < AC input type – 6 relays and 2 triacs >

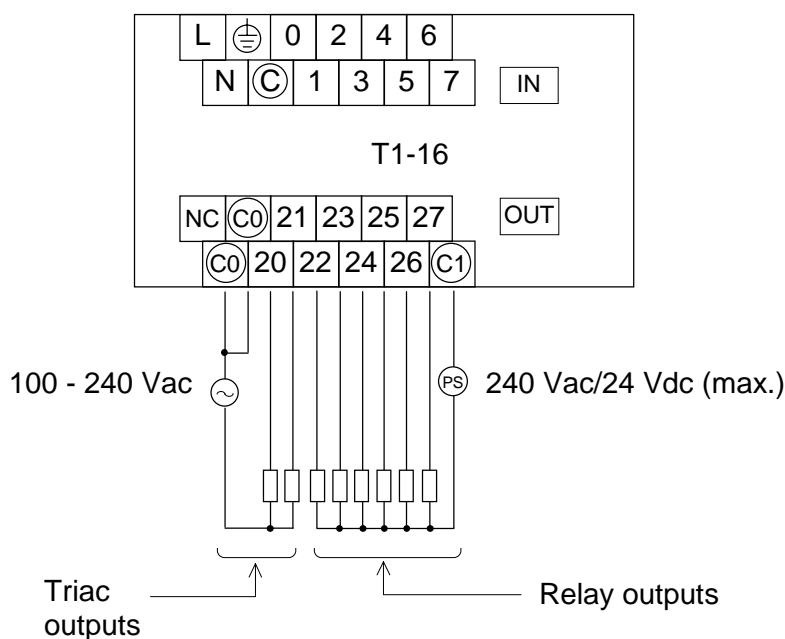

## 2. Specifications

### 2.4.2 T1-28

- T1-28 input specifications

Item	Specifications	
	DC input type	AC input type
Input type	DC input, current source/sink	AC input
Number of input points	14 points (14 points/common)	14 points (14 points/common)
Rated input voltage	24 Vdc, +10/-15 %	100 - 120 Vac, +10/-15 %, 50/60 Hz
Rated input current	7 mA (at 24 Vdc)	7 mA (at 100 Vac)
Min. ON voltage	15 Vdc	80 Vac
Max. OFF voltage	5 Vdc	30 Vac
ON delay time	0 to 15 ms (X00 - X07) <sup>*1</sup> 10 ms or less (X08 - X0D)	25 ms or less + user setting (X00 - X07) <sup>*2</sup> 25 ms or less (X08 - X0D)
OFF delay time	0 to 15 ms (X00 - X07) <sup>*1</sup> 10 ms (X08 - X0D)	30 ms or less + user setting (X00 - X07) <sup>*2</sup> 30 ms or less (X08 - X0D)
Input signal display	LED display for all points, lit at ON, internal logic side	
External connection	Removable terminal block, M3.5	
Withstand voltage	1500 Vac, 1 minute (between internal and external circuits)	
Internal circuit		

\*1: The input ON/OFF delay time of the leading 8 points of the DC input can be changed by user. The setting range is 0 to 15 ms. (Default value = 10 ms) Refer to section 8.2.

\*2: The input ON/OFF delay time of the leading 8 points of the AC input can be extended by user. The extension setting range is 0 to 15 ms. (Default value = 10 ms) Resulting the default delay times of these points are 35 ms (ON delay) and 40 ms (OFF delay). Refer to section 8.2.

## 2. Specifications

- Input signal connections

### < DC input type >

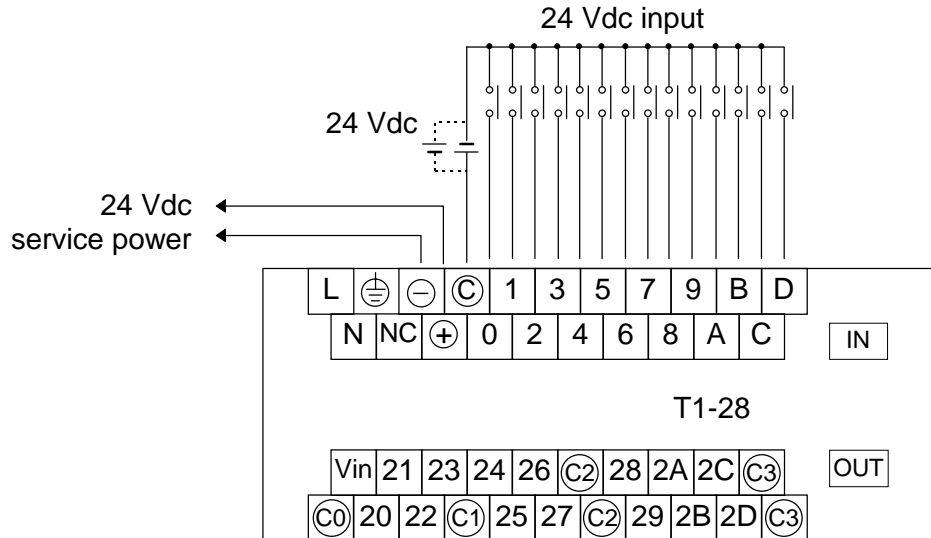

Note) The 24 Vdc service power output is not provided on the DC power supply type.

### < AC input type >

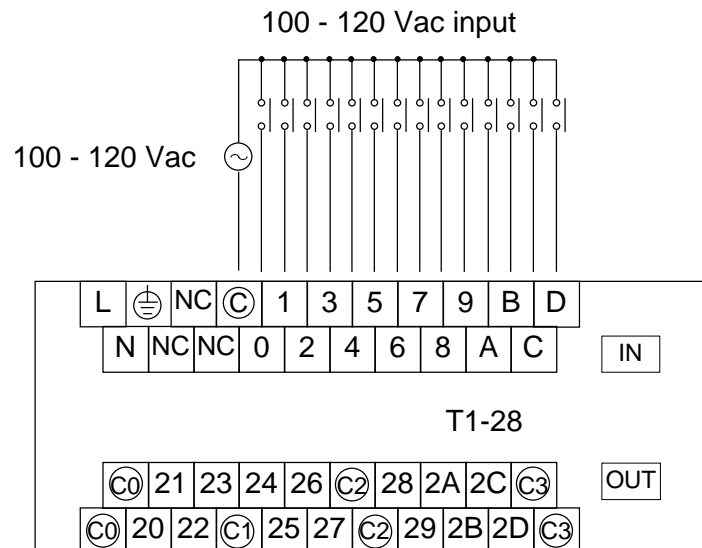

## 2. Specifications

### • T1-28 output specifications

Item	Specifications		
	Relay output (both DC input and AC input types)	Transistor output (DC input type)	Triac output (AC input type)
Output type	Relay contact, normally open	Transistor output, current sink	Triac output
Number of output points	12 points (1 × 2 pts/common, 1 × 4 pts/common, 1 × 6 pts/common)	2 points (2 points/common)	2 points (2 points/common)
Rated load voltage	240 Vac/24 Vdc (max.)	24 Vdc	100 - 240 Vac (50/60 Hz)
Range of load voltage	Max. 264 Vac/125Vdc	20.0 - 28.0 V	24 - 264 Vac (47 - 63 Hz)
Maximum load current	2 A/point (resistive), 4 A/common	0.5 A/point (resistive)	1.0 A/point (resistive)
ON resistance	50 mΩ or less (initial value)	–	–
Voltage drop at ON	–	1.5 V or less	1.5V or less
Leakage current at OFF	None	0.1 mA or less	1 mA or less (at 100 Vac, 50Hz), 2 mA or less (at 240 Vac, 50Hz)
Minimum load	5 Vdc, 10 mA (50 mW)	–	100 mA (24 Vac), 50 mA (100 - 240 Vac)
ON delay time	10 ms or less	0.1 ms or less	1 ms or less
OFF delay time	10 ms or less	0.1 ms or less	1 ms + 1/2 cycle or less
Output signal display	LED display for all points, lit at ON, internal logic side		
External connection	Removable terminal block, M3.5		
Withstand voltage	1500 Vac, 1 minute (between internal and external circuits)		
Internal circuit			

- \*1: The switching life of the relay output is as follows.  
 20 million times or more (mechanical)  
 100 thousand times or more (electrical, at maximum rated voltage and current)



## 2. Specifications

- Output signal connections

< DC input type – 12 relays and 2 transistors >

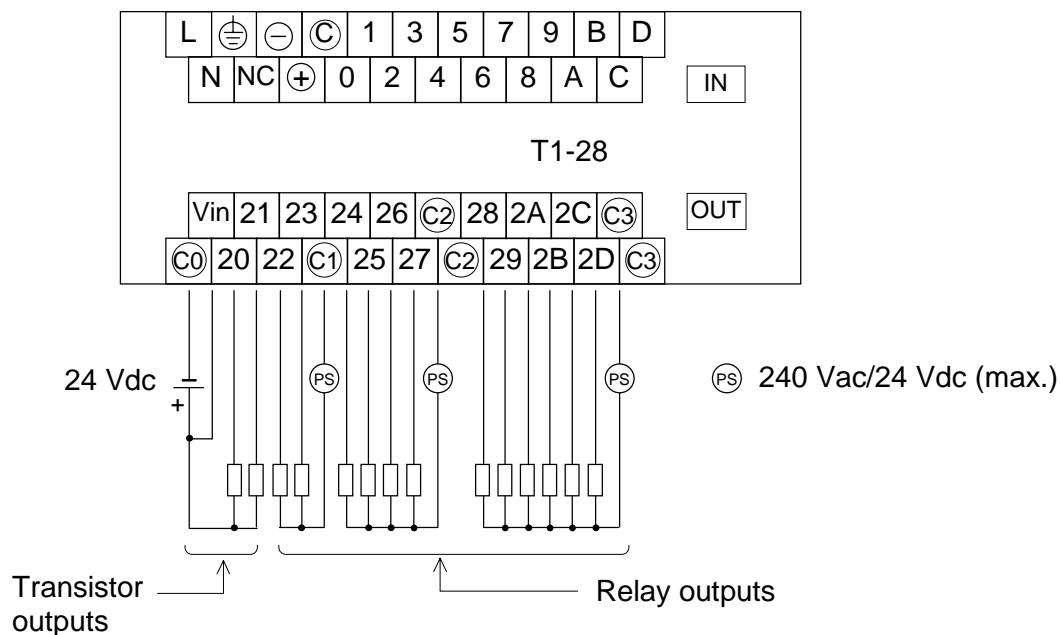

< AC input type – 12 relays and 2 triacs >

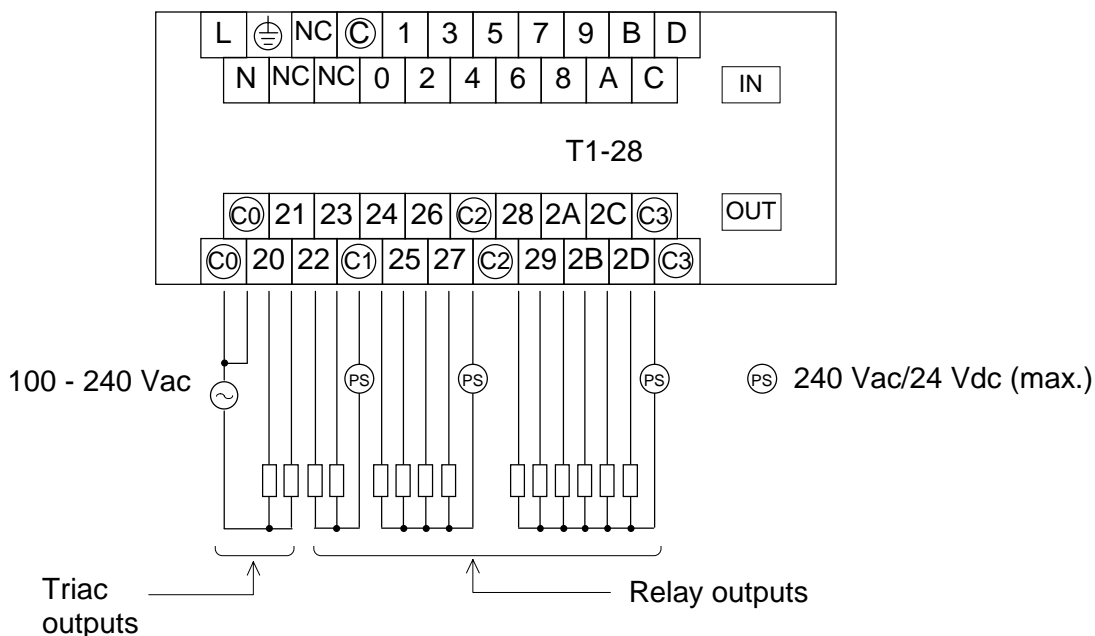

## 2. Specifications

### 2.4.3 T1-40/T1-40S

- T1-40/T1-40S input specifications

Item	Specifications	
	DC input type	AC input type
Input type	DC input, current source/sink	AC input
Number of input points	24 points (24 points/common)	24 points (24 points/common)
Rated input voltage	24 Vdc, +10/-15 %	100 - 120 Vac, +10/-15 %, 50/60 Hz
Rated input current	7 mA (at 24 Vdc)	7 mA (at 100 Vac)
Min. ON voltage	15 Vdc	80 Vac
Max. OFF voltage	5 Vdc	30 Vac
ON delay time	0 to 15 ms (X00 - X07) <sup>*1</sup> 10 ms (X08 - X17)	25 ms or less + user setting (X00 - X07) <sup>*2</sup> 25 ms or less (X08 - X17)
OFF delay time	0 to 15 ms (X00 - X07) <sup>*1</sup> 10 ms (X08 - X17)	30 ms or less + user setting (X00 - X07) <sup>*2</sup> 30 ms or less (X08 - X17)
Input signal display	LED display for all points, lit at ON, internal logic side	
External connection	Removable terminal block, M3.5	
Withstand voltage	1500 Vac, 1 minute (between internal and external circuits)	
Internal circuit		

\*1: The input ON/OFF delay time of the leading 8 points of the DC input can be changed by user. The setting range is 0 to 15 ms. (Default value = 10 ms) Refer to section 8.2.

\*2: The input ON/OFF delay time of the leading 8 points of the AC input can be extended by user. The extension setting range is 0 to 15 ms. (Default value = 10 ms) Resulting the default delay times of these points are 35 ms (ON delay) and 40 ms (OFF delay). Refer to section 8.2.

## 2. Specifications

- Input signal connections

### < DC input type >

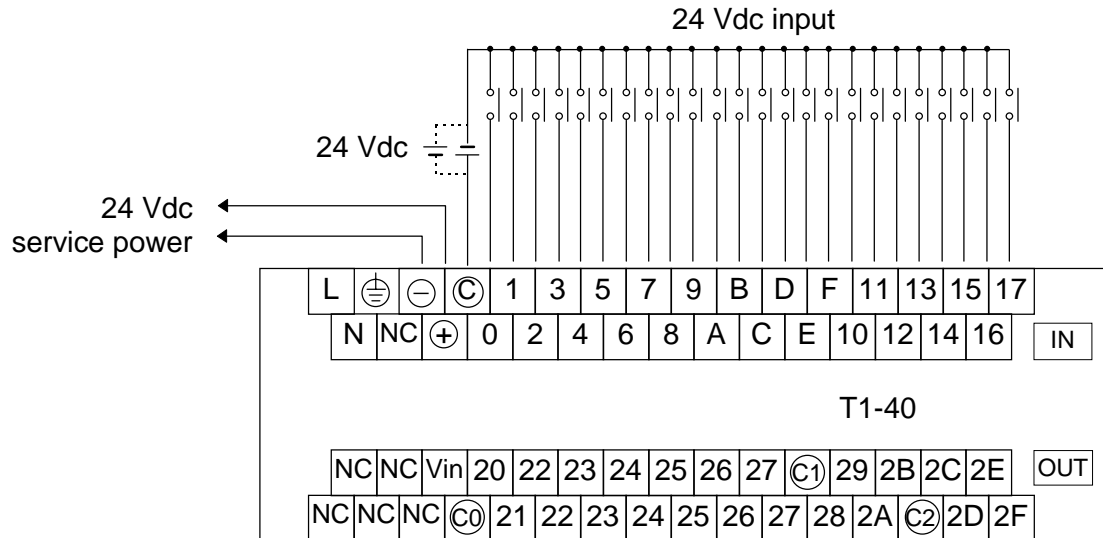

Note) The 24 Vdc service power output is not provided on the DC power supply type.

### < AC input type >

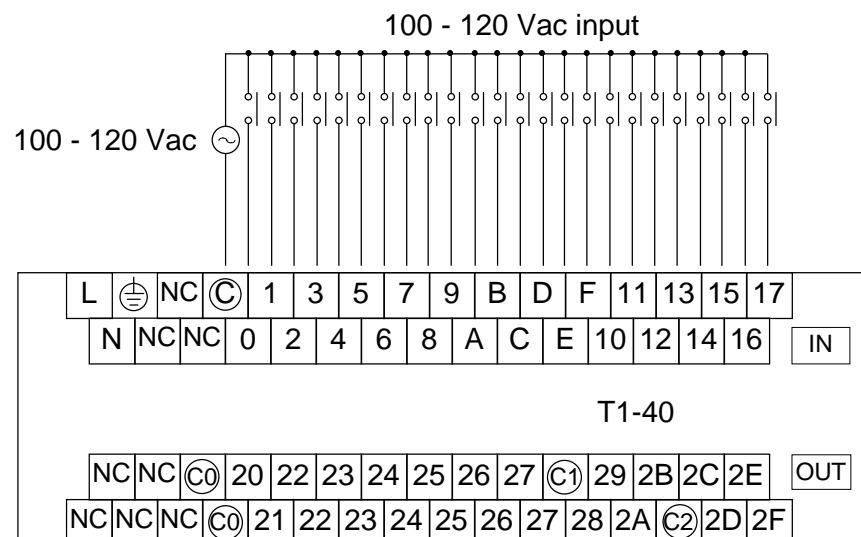

## 2. Specifications

### • T1-40/T1-40S output specifications

Item	Specifications		
	Relay output (both DC input and AC input types)	Transistor output (DC input type)	Triac output (AC input type)
Output type	Relay contact, normally open	Transistor output, current sink	Triac output
Number of output points	14 points (6 × isolated, 2 × 4 pts/common)	2 points (2 points/common)	2 points (2 points/common)
Rated load voltage	240 Vac/24 Vdc (max.)	24 Vdc	100 - 240 Vac (50/60 Hz)
Range of load voltage	Max. 264 Vac/125Vdc	20.0 - 28.0 V	24 - 264 Vac (47 - 63 Hz)
Maximum load current	2 A/point (resistive), 2 A/common	0.5 A/point (resistive)	1.0 A/point (resistive)
ON resistance	50 mΩ or less (initial value)	–	–
Voltage drop at ON	–	1.5 V or less	1.5 V or less
Leakage current at OFF	None	0.1 mA or less	1 mA or less (at 100 Vac, 50Hz) 2 mA or less (at 240 Vac, 50Hz)
Minimum load	5 Vdc, 10 mA (50 mW)	–	100 mA (24 Vac), 50 mA (100 - 240 Vac)
ON delay time	10 ms or less	0.1 ms or less	1 ms or less
OFF delay time	10 ms or less	0.1 ms or less	1 ms + 1/2 cycle or less
Input signal display	LED display for all points, lit at ON, internal logic side		
External connection	Removable terminal block, M3.5		
Withstand voltage	1500 Vac, 1 minute (between internal and external circuits)		
Internal circuit			

\*1: The switching life of the relay output is as follows.  
 20 million times or more (mechanical)  
 100 thousand times or more (electrical, at maximum rated voltage and current)

## 2. Specifications

- Output signal connections

### < DC input type – 14 relays and 2 transistors >

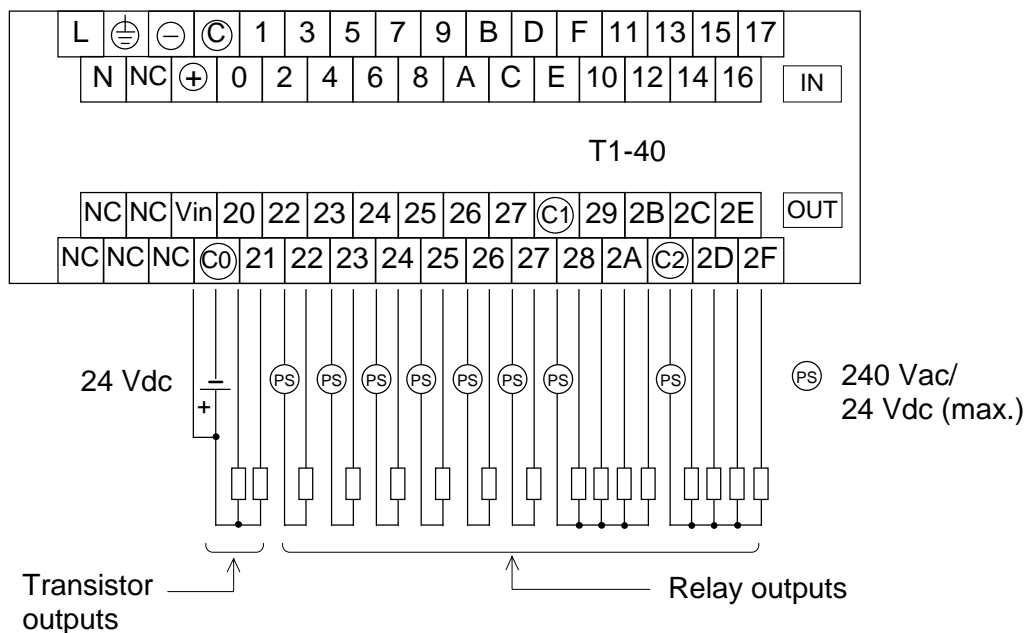

### < AC input type – 14 relays and 2 triacs >

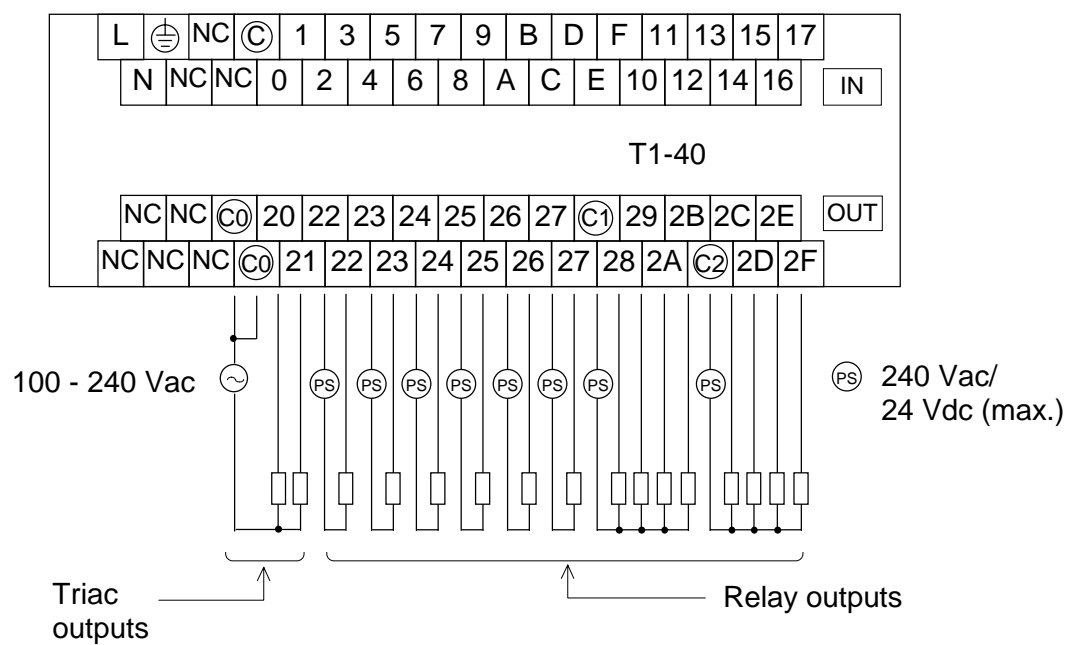



---

## *Section 3*

# *I/O Application Precautions*

---

- 3.1 Application precautions for input signals, 62*
- 3.2 Application precautions for output signals, 65*

### 3. I/O Application Precautions

#### 3.1 Application precautions for input signals

**⚠ WARNING** Configure emergency stop and safety interlocking circuits outside the T1/T1S. Otherwise, malfunction of the T1/T1S can cause injury or serious accidents.

- (1) Current source / sink selection on the T1-16 dry contact input  
 The input current flow direction (source or sink) of the T1-16 dry contact input can be selected by setting the jumper plug on the T1-16 printed circuit board as shown below. The factory setting is current source. Refer to section 2.4.1 for specifications and signal connections.

The tool for opening the cover is attached on the back of the T1-16.

Remove the tool from the unit.

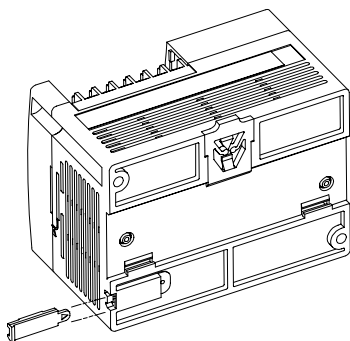

#### ⚠ CAUTION

- (1) Turn off power before opening the cover.
- (2) Take care not to touch any electrical parts on the board. Static electricity can cause damage.
- (3) Use a pair of tweezers to change the jumper plug setting.

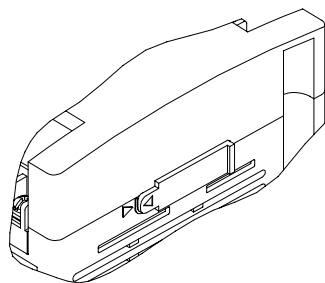

Put the tool on the side of the unit so that the marks ◁ on the tool and the unit are aligned.

Push the tool to unhook the cover. Then remove the cover.

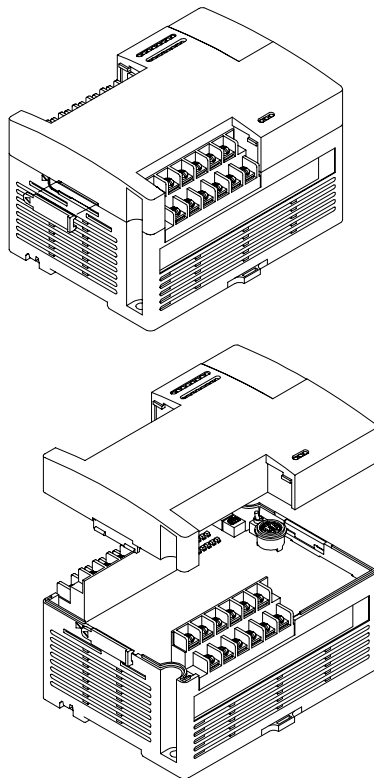

Jumper plug

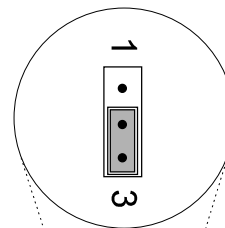

1 side:  
Sink  
3 side:  
Source

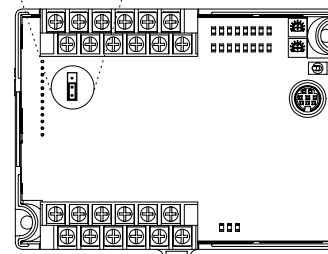



### 3. I/O Application Precautions

(2) Minimum ON/OFF time of the input signal

The following conditions guarantee correct reading of the ON/OFF state of the input signal:

Input ON time: ON delay time + the time for one scan

Input OFF time: OFF delay time + the time for one scan

The ON and OFF times of the input signals must be longer than these intervals.

(3) Increasing the contact current

The reliability of some contacts cannot be guaranteed by the specified input current. In this case, install an external bleeder resistor to increase the contact current.

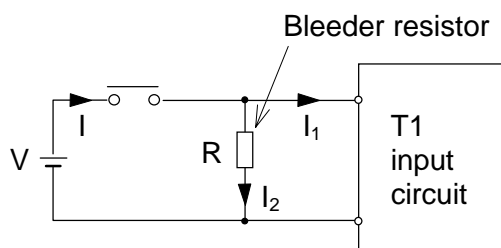

$$R = \frac{V}{I - I_1}$$

$$\text{Wattage} > \frac{V^2}{R} \times 3$$

Note) The above solution cannot be applied to the T1-16 dry contact input.

(4) Connecting transistor output device

An example of connecting a transistor output device to T1/T1S's input circuit is shown below.

• For NPN open collector

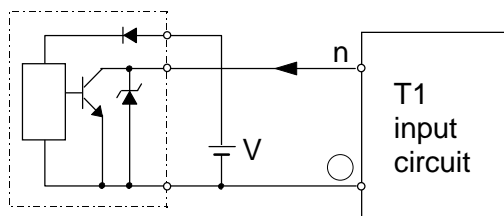

T1-16 dry contact input  
(current source)

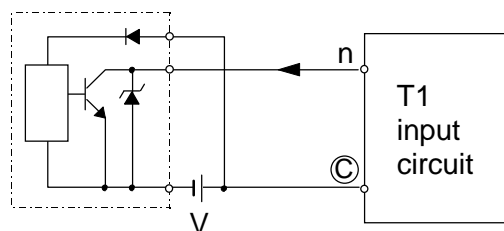

T1-28, T1-40 and T1-40S DC input

• For PNP open collector

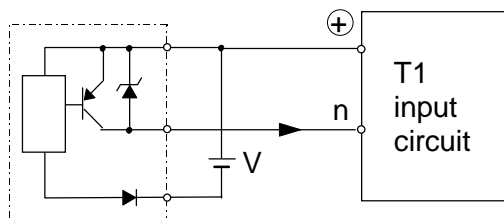

T1-16 dry contact input  
(current sink)

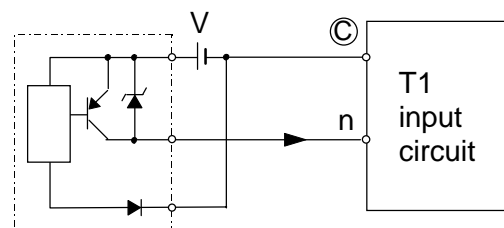

T1-28, T1-40 and T1-40S DC input

### 3. I/O Application Precautions

(5) Countermeasures against leakage current

When a switch with an LED or an AC output sensor is used, the input sometimes cannot recognize that the switch is off due to the current leakage. In this case, install a bleeder resistor to reduce input impedance.

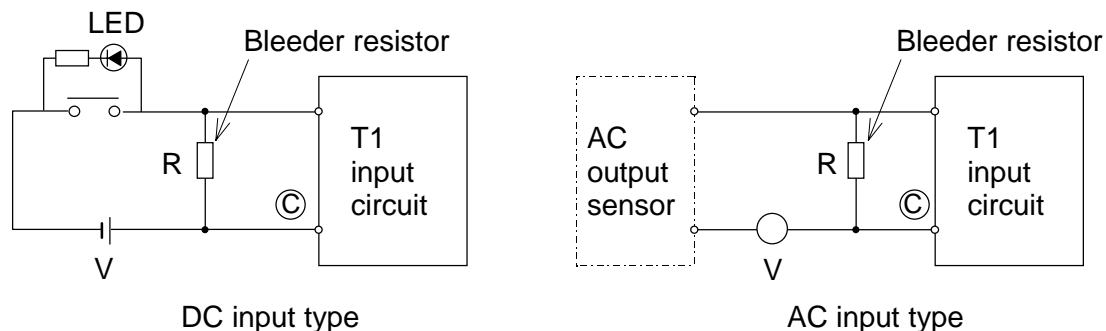

Select a bleeder resistor according to the following criteria:

- The voltage between the input terminals must be lower than the OFF voltage when the sensor is switched off.
- The current must be within the allowable range when the sensor is switched on.
- Calculate the wattage of the bleeder resistor by multiplying the current when the sensor is switched on times three.

Note) The above solution cannot be applied to the T1-16 dry contact input.

(6) Countermeasures against induced current

With ac input signals, if the external cable is long or if a multi-core cable is used, an induced current can flow from the charged wire to the open wire, in proportion to the capacities of the cables. In this case, sometimes the voltage reaches the level of the ON input even though the contact is open, causing the input to malfunction for no apparent reason.

The usual practice when this happens is to reduce input impedance. Install a resistor or a resistor and capacitor between the input and common terminals, or use shielded cables. Such precautions are necessary when dealing with a large number of ac input signals.

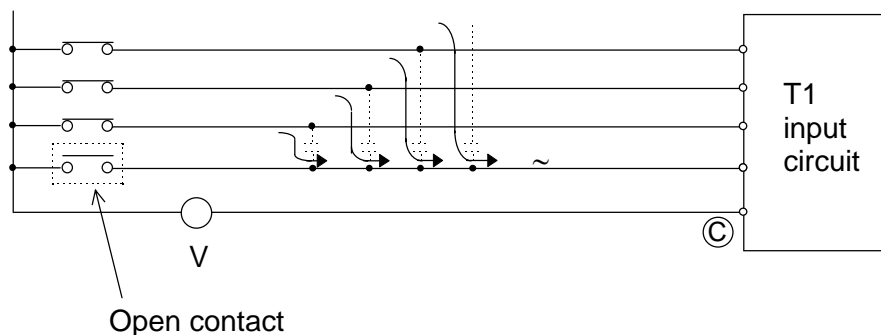

### 3. I/O Application Precautions

#### 3.2 Application precautions for output signals

**⚠ WARNING** Configure emergency stop and safety interlocking circuits outside the T1/T1S. Otherwise, malfunction of the T1/T1S can cause injury or serious accidents

**⚠ CAUTION**

1. Turn on power to the T1/T1S before turning on power to the loads. Failure to do so may cause unexpected behavior of the loads.
2. Configure the external circuit so that the external 24 Vdc power required for the transistor output circuits and power to the loads are switched on/off simultaneously. Also, turn off power to the loads before turning off power to the T1/T1S.
3. Install fuses appropriate to the load current in the external circuits for the outputs. Failure to do so can cause fire in case of load over-current.

(1) 2 points of solid-state output

The leading 2 points of output (Y020 and Y021) are solid-state outputs, transistors on the DC input types and triacs on the AC input types.

These solid-state outputs are suited for frequent switching applications.

Note that the specifications of the solid-state outputs and other outputs (relays) are different.

(2) Switching life of output relays

Expected relay life is more than 100,000 electrical cycles at rated maximum voltage and current, and more than 20 million mechanical cycles. The expected contact life (electrical cycles) is shown on the table below.

	Load voltage	Load current	Expected life (thousand)
AC load	110 Vac, COS $\phi$ = 1	2 A	340
		1 A	720
		0.5 A	1,600
	110 Vac, COS $\phi$ = 0.7	2 A	150
		1 A	320
		0.5 A	700
	220 Vac, COS $\phi$ = 1	2 A	220
		1 A	500
		0.5 A	1,100
	220 Vac, COS $\phi$ = 0.7	2 A	100
		1 A	210
		0.5 A	460

	Load voltage	Load current	Expected life (thousand)
DC load	24 Vdc, L/R = 0 ms	2 A	280
		1 A	600
		0.5 A	1,300
	24 Vdc, L/R = 15 ms	2 A	60
		1 A	150
		0.5 A	350
	48 Vdc, L/R = 0 ms	1 A	200
		0.5 A	420
	48 Vdc, L/R = 15 ms	0.5 A	130
		0.2A	420
	110 Vdc, L/R = 0 ms	0.5 A	200
		0.2 A	550
	110 Vdc, L/R = 15 ms	0.2 A	150
		0.1 A	350

### 3. I/O Application Precautions

#### (3) Over-current protection

The output circuit of the T1/T1S does not contain protective fuses. Fuses rated for the output should be provided by the user.

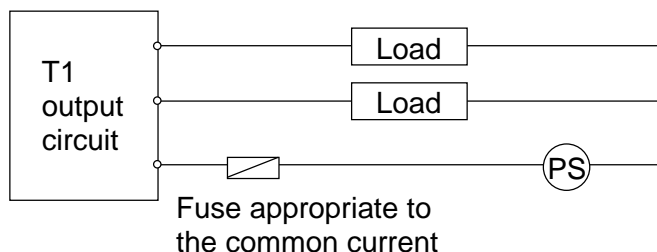

#### (4) Output surge protection

Where an inductive load is connected to the output, a relatively high energy transient voltage will be generated when the relay turns OFF. To prevent the problems caused by this surge, install a surge absorber in parallel to the inductive load.

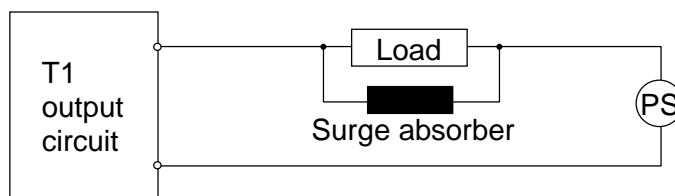

Surge absorber:

- Flywheel diode (for DC output)



Inverse withstand voltage: At least three times that of the power supply

Forward current: Larger than the load current

- Varistor (for AC output)

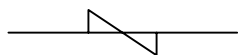

The voltage rating is 1.2 times the maximum (peak) voltage of the power supply

- CR snubber (for DC or AC output)

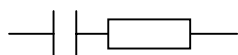

R: 0.5 to 1  $\Omega$  per volt coil voltage

C: 0.5 to 1  $\mu\text{F}$  per ampere of coil current (non-polarity capacitor)

---

## *Section 4*

# *Installation and Wiring*

---

- 4.1 *Environmental conditions, 68*
- 4.2 *Installing the unit, 69*
- 4.3 *Wiring terminals, 71*
- 4.4 *Grounding, 76*
- 4.5 *Power supply wiring, 78*
- 4.6 *I/O wiring, 80*

## 4. Installation and Wiring

### 4.1 Environmental conditions



#### CAUTION

Excess temperature, humidity, vibration, shocks, or dusty and corrosive gas environment can cause electrical shock, fire or malfunction. Install and use the T1/T1S and related equipment in the environment described in this section.

Do not install the T1/T1S in the following locations:

- Where the ambient temperature drops below 0 °C or exceeds 55 °C.
- Where the relative humidity drops below 20 % or exceeds 90 %.
- Where there is condensation due to sudden temperature changes.
- In locations subject to vibration that exceeds tolerance.
- In locations subject to shock that exceeds tolerance.
- Where there are corrosive or flammable gases.
- In locations subject to dust, machining debris or other particles.
- In locations exposed to direct sunlight.

Observe the following precautions when installing enclosures in which the T1/T1S will be installed:

- Provide the maximum possible distance from high-voltage or high-power panels. This distance must be at least 200 mm.
- If installing the enclosures in the vicinity of high-frequency equipment, be sure to correctly ground the enclosures.
- When sharing the channel base with other panels, check for leakage current from the other panels or equipment.

## 4. Installation and Wiring

### 4.2 Installing the unit



#### CAUTION

1. Improper installation directions or insufficient installation can cause fire or the units to drop. Install the T1/T1S and related equipment in accordance with the instructions described in this section.
2. Turn off power before installing or removing any units, modules, racks or terminal blocks. Failure to do so can cause electrical shock or damage to the T1/T1S and related equipment.
3. Entering wire scraps or other foreign debris into to the T1/T1S and related equipment can cause fire or malfunction. Pay attention to prevent entering them into the T1 and related equipment during installation and wiring.



#### NOTE

The T1/T1S basic unit and the expansion unit come equipped with a bracket at the rear for mounting on a 35 mm DIN rail. However, no DIN rail bracket is provided on the expansion rack.

#### Installation precautions:

- Because the T1/T1S is not dust-proof, install it in a dust-proof enclosure.
- Do not install the unit directly above equipment that generates a large amount of heat, such as a heater, transformer, or large-capacity resistor.
- Do not install the unit within 200 mm of a high-voltage or high-power cables.
- Allow at least 70 mm on all sides of the unit for ventilation.
- For safety during maintenance and operation, install the unit as far as possible from high-voltage or power equipment. Alternatively, keep the unit separate using a metal plate or similar separator.
- If a high-frequency equipment is installed in the enclosure together with the T1/T1S, special attention is required for grounding. See section 4.4.
- Be sure to install the unit vertically with keeping the power terminals upside. Do not install the unit horizontally or upside-down for safety reason.
- Use M4 size screws to mount the T1/T1S.  
(Recommended torque: 1.47 N·m = 15 kgf·cm)

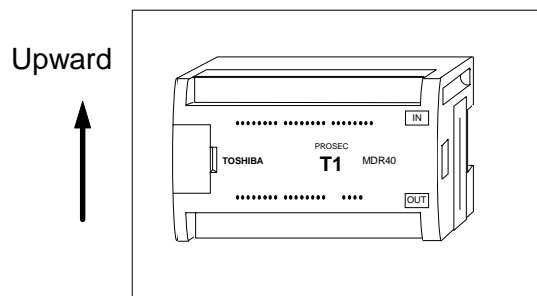

Mount the T1 on a vertical panel.  
All other mounting positions are not acceptable.

## 4. Installation and Wiring

### Dimensions for screw mounting:

- T1-16

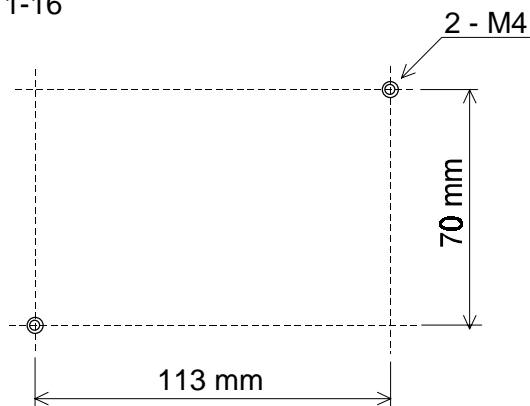

- T1-28 / T1-40 / T1-40S / Expansion unit

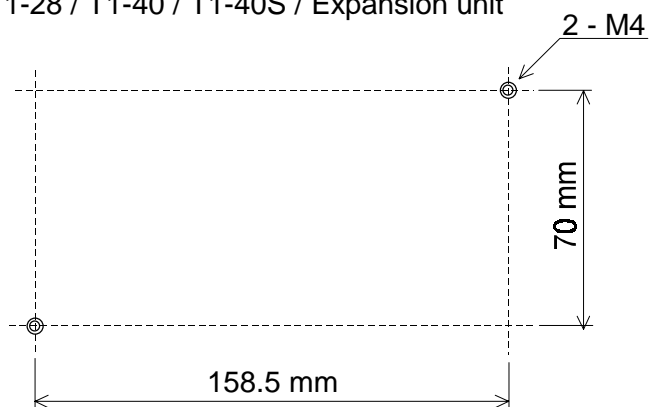

- Expansion rack

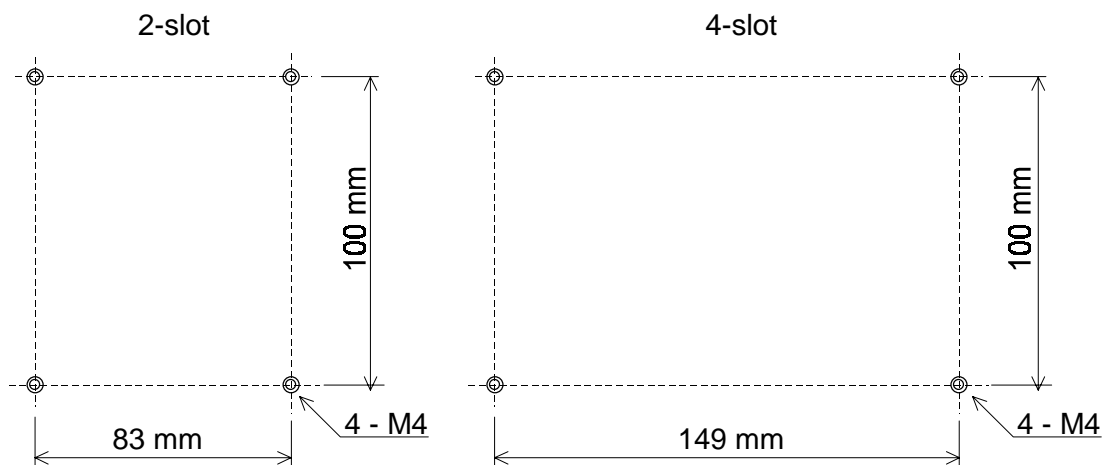



## 4. Installation and Wiring

### 4.3 Wiring terminals



#### CAUTION

1. Turn off power before wiring to minimize the risk of electrical shock.
2. Exposed conductive parts of wire can cause electrical shock. Use crimp-style terminals with insulating sheath or insulating tape to cover the conductive parts. Also close the terminal covers securely on the terminal blocks when wiring has been completed.
3. Turn off power before removing or replacing units, modules, terminal blocks or wires. Failure to do so can cause electrical shock or damage to the T1/T1S and related equipment.

The terminal arrangement of each T1 Series model are shown below.  
The terminal screw size is M3.5. Use crimp-style terminals of 7 mm width or less useable for M3.5.

The terminal blocks of the T1-16 are not removable (fixed). On the other hand, the terminal blocks of the T1-28, T1-40 and T1-40S are removable. However, be sure to turn off power before removing or replacing the terminal blocks.



#### NOTE

For input and output signal connections, refer to sections 2.4 and 3.

- T1-16

T1-MDR16 ... AC power supply, Dry contact input type

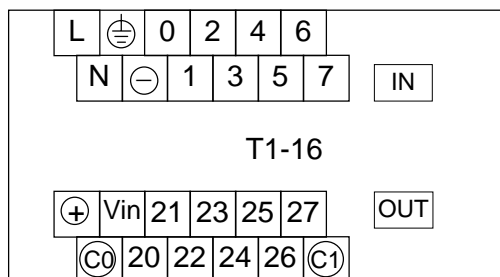

## 4. Installation and Wiring

T1-MAR16 ... AC power supply, AC input type

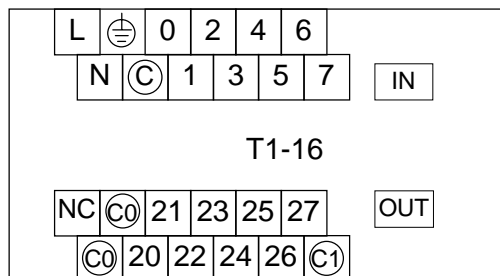

T1-MDR16D ... DC power supply, DC input type

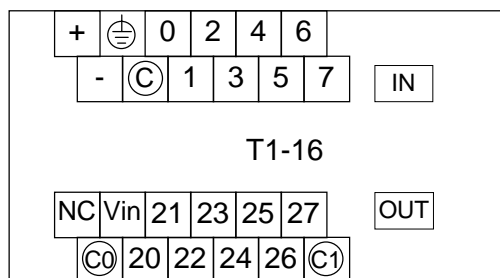

NC stands for "no connect". Do not use the NC terminals for wire relaying or branching.

## 4. Installation and Wiring

- T1-28

T1-MDR28 ... AC power supply, DC input type

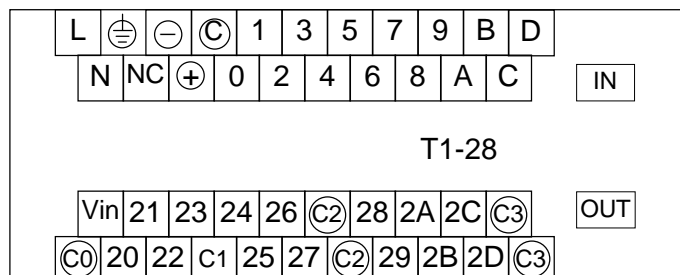

T1-MAR28 ... AC power supply, AC input type

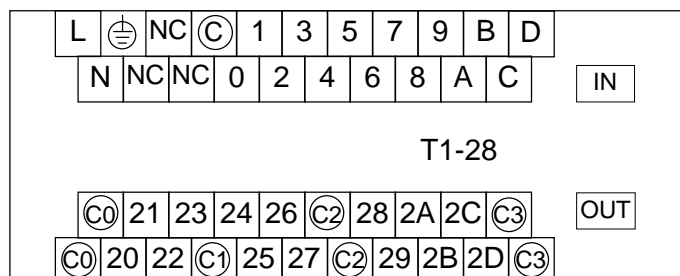

T1-MDR28D ... DC power supply, DC input type

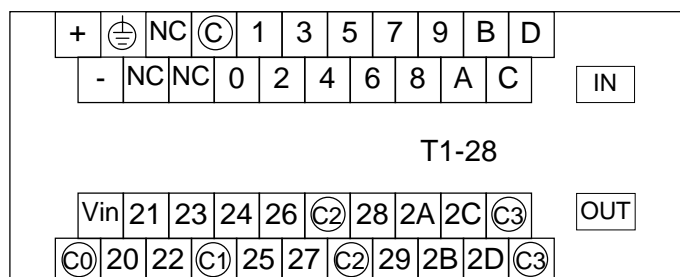

NC stands for "no connect". Do not use the NC terminals for wire relaying or branching.

## 4. Installation and Wiring

- T1-40

T1-MDR40 ... AC power supply, DC input type

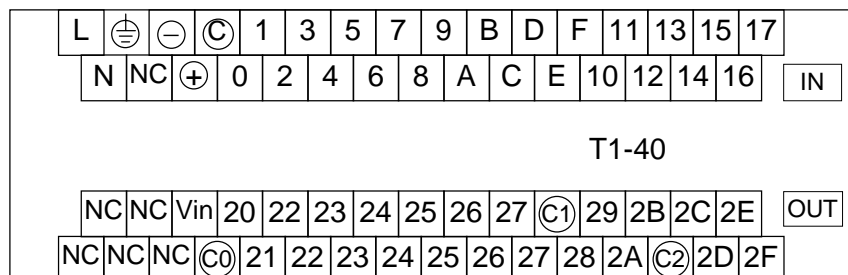

T1-MAR40 ... AC power supply, AC input type

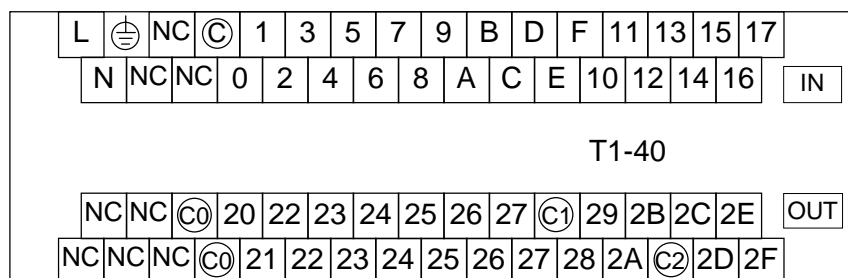

T1-MDR40D ... DC power supply, DC input type

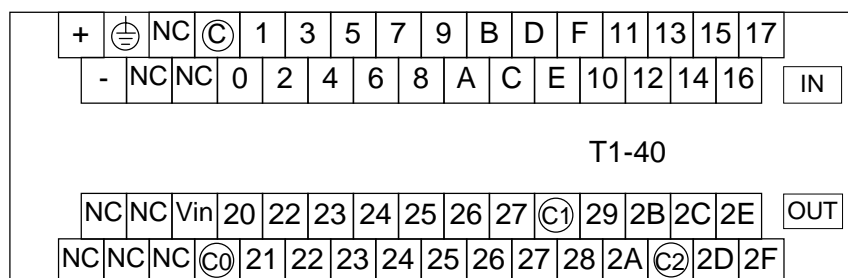

NC stands for "no connect". Do not use the NC terminals for wire relaying or branching.

## 4. Installation and Wiring

- T1-40S

T1-MDR40S ... AC power supply, DC input type

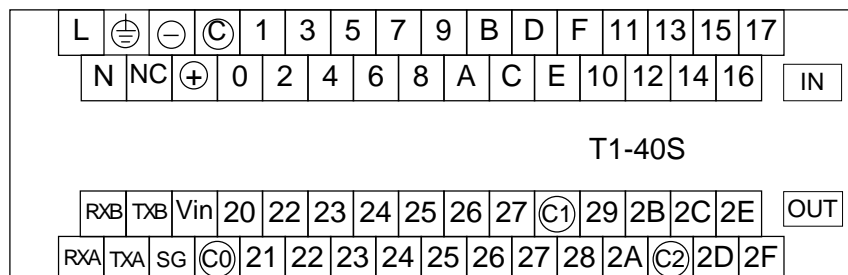

T1-MAR40S ... AC power supply, AC input type

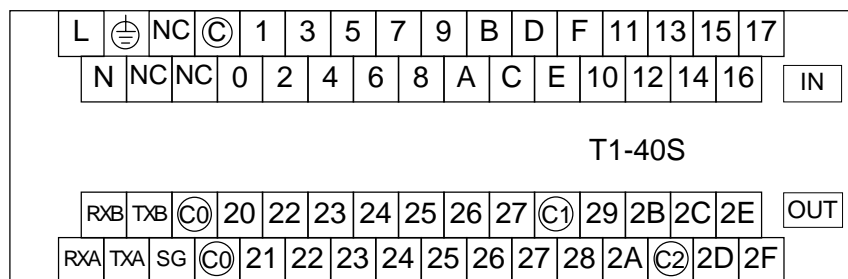

T1-MDR40SD ... DC power supply, DC input type

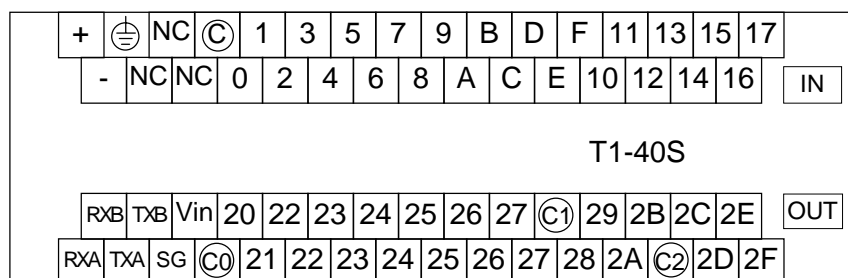

- (1) NC stands for "no connect". Do not use the NC terminals for wire relaying or branching.
- (2) For the connections of the RS-485 communication port (left end 5 terminals of the lower terminal block), refer to the separate manual "T1/T1S User's Manual - Communication Function -".

## 4. Installation and Wiring

The applicable wire size is 0.3 mm<sup>2</sup> (22 AWG) to 1.25 mm<sup>2</sup> (16 AWG). The table below shows the recommended wire size.

Type of signal	Recommended wire size
Power	1.25 mm <sup>2</sup> (16 AWG)
Grounding	1.25 mm <sup>2</sup> (16 AWG)
I/O signals	0.3 mm <sup>2</sup> (22 AWG) to 0.75 mm <sup>2</sup> (18 AWG)

### 4.4 Grounding



#### CAUTION

1. Turn off power before wiring to minimize the risk of electrical shock.
2. Operation without grounding may cause electrical shock or malfunction. Connect the ground terminal on the T1/T1S to the system ground.

The optimum method for grounding electronic equipment is to ground it separately from other high-power systems, and to ground more than one units of electronic equipment with a single-point ground.

Although the T1/T1S has noise immunity to be used in industrial operating conditions, grounding is important for safety and reliability.

Check the grounding against the following criteria.

1. The T1/T1S must not become a path for a ground current. A high-frequency current is particularly harmful.
2. Equalize the ground potentials when the expansion rack or unit is connected. Ground the T1/T1S and the expansion rack or unit at a single point.
3. Do not connect the ground of the T1/T1S to that of high-power systems.
4. Do not use a ground that has an unstable impedance, such as painted screws, or ground subject to vibration.

The grounding marked terminal (see below) is provided on the T1/T1S basic unit and the expansion unit for grounding purpose.



## 4. Installation and Wiring

In case of the expansion rack is connected to the T1/T1S, the rack mounting screw is used for this purpose.

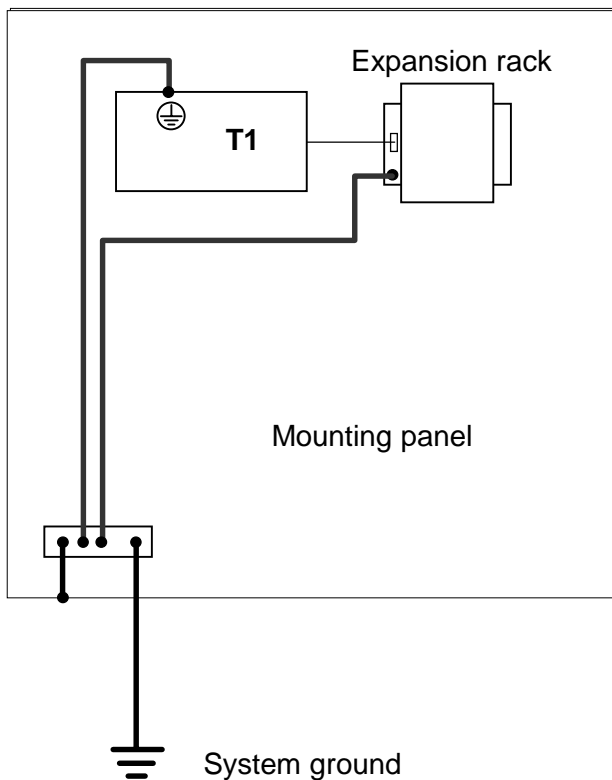

- 1.25 mm<sup>2</sup> (16 AWG) wire should be used to connect the T1/T1S and the expansion rack/unit with the enclosure grounding bus bar.
- 100 Ω or less to ground is required.

## 4. Installation and Wiring

### 4.5 Power supply wiring



#### CAUTION

1. Turn off power before wiring to minimize the risk of electrical shock.
2. Applying excess power voltage to the T1/T1S can cause explosion or fire. Apply power of the specified ratings described below.

Wire the power source to the T1/T1S power supply terminals.

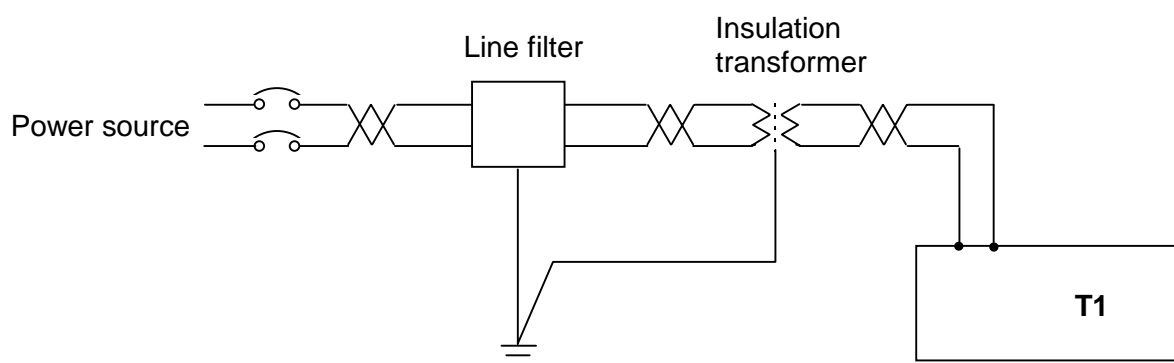

- Power conditions:

	AC power supply type	DC power supply type
Rated voltage	100 to 240 Vac, +10/-15 %	24 Vdc, +20/-15 %
Frequency	50/60 Hz, ±5 %	-
Power consumption	30 VA or less (T1-16/T1-28) 38 VA or less (T1-40) 45 VA or less (T1-40S)	12 W or less (T1-16/T1-28) 18 W or less (T1-40) 18 W or less (T1-40S)
Retentive power interruption	Continuous operation for less than 10 ms	

- 1.25 mm<sup>2</sup> (16 AWG) twisted-pair cable should be used for the power cable.
- The power cable should be separated from other cables.



## 4. Installation and Wiring

Connections of the power supply terminals are shown below.

- AC power supply type

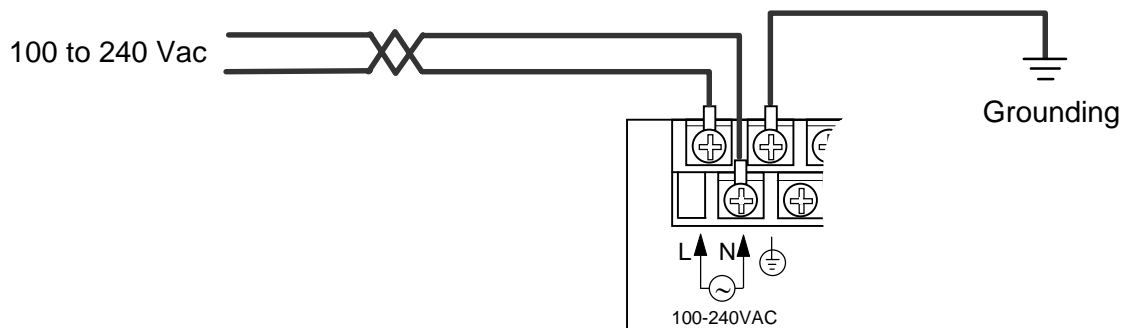

- DC power supply type

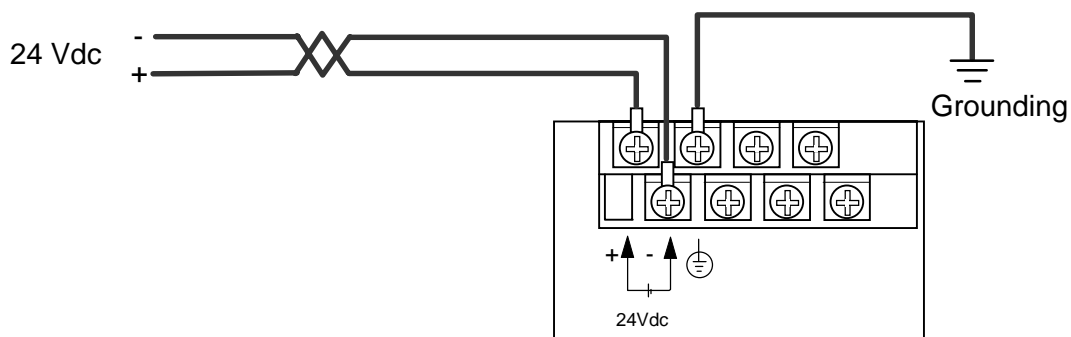

## 4. Installation and Wiring

### 4.6 I/O wiring

#### ⚠ CAUTION

1. Turn off power before wiring to minimize the risk of electrical shock.
2. Exposed conductive parts of wire can cause electrical shock. Use crimp-style terminals with insulating sheath or insulating tape to cover the conductive parts. Also close the terminal covers securely on the terminal blocks when wiring has been completed.
3. Turn off power before removing or replacing units, modules, terminal blocks or wires. Failure to do so can cause electrical shock or damage to the T1/T1S and related equipment.

- Refer to sections 2.4 and 3 for instructions on how to properly wire the I/O terminals.
- 0.75 mm<sup>2</sup> (18 AWG) to 0.3 mm<sup>2</sup> (22 AWG) wires are recommended for I/O signals.
- Separate the I/O signal cables from high-power cables by at least 200 mm.
- If expansion rack or unit is used, separate the expansion cable from the power and I/O signal cables by or unit at least 50 mm.
- It is recommended to separate the input signal cables from output signal cables.

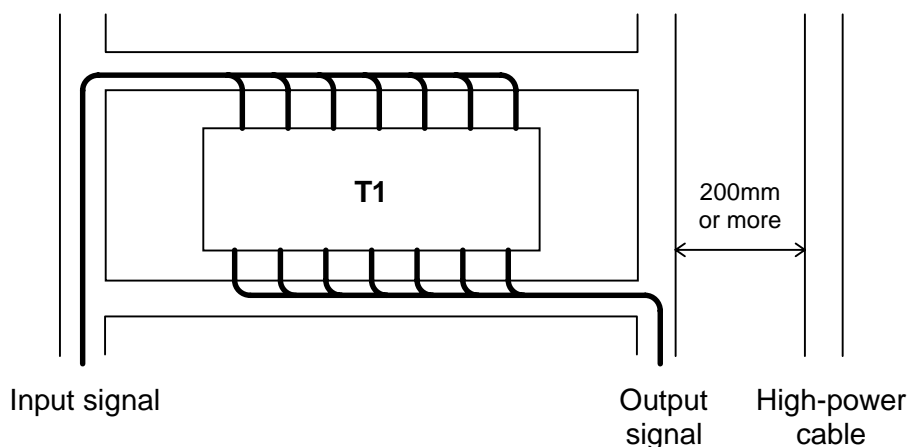

---

## *Section 5*

# *Operating System Overview*

---

- 5.1 Operation modes, 82*
- 5.2 About the built-in EEPROM, 84*
- 5.3 Scanning, 87*

## 5. Operating System Overview

### 5.1 Operation modes

The T1/T1S has three basic operation modes, the RUN mode, the HALT mode and the ERROR mode. The T1/T1S also has the HOLD and RUN-F modes mainly for system checking.

- RUN:** The RUN mode is a normal control-operation mode. In this mode, the T1/T1S reads external signals, executes the user program stored in the RAM, and outputs signals to the external devices according to the user program. It is in the RUN mode that the T1/T1S performs scans the user program logic, which is the basic operation of a PLC. In case of the T1S, program changes and EEPROM write are possible while the T1S is in the RUN mode. Refer to section 6.9. On the other hand, in case of the standard T1, program changes and EEPROM write are not possible in the RUN mode.
- HALT:** The HALT mode is a programming mode. In this mode, user program execution is stopped and all outputs are switched off. Program loading into the T1/T1S is possible only in the HALT mode. For the standard T1, program changes and EEPROM write are possible only when the T1 is in the HALT mode.
- ERROR:** The ERROR mode is a shut-down mode as a result of self-diagnosis. The T1/T1S enters the ERROR mode if internal trouble is detected by self-diagnosis. In this mode, program execution is stopped and all outputs are switched off. The cause of the shut-down can be confirmed by connecting the programming tool. To exit from the ERROR mode, execute the Error Reset command from the programming tool, or cycle power off and then on again.
- HOLD:** The HOLD mode is provided mainly for checking the external I/O signals. In this mode, user program execution is stopped, with input and output updating is executed. It is therefore possible to suspend program execution while holding the output state. Moreover, a desired output state can be established by setting any data by using the programming tool.
- RUN-F:** The RUN-F mode is a forced RUN mode provided for program checking. This mode is effective when using the expansion I/Os. Deferent from the normal RUN mode, the RUN-F mode allows operation even if the registered option cards, expansion unit and/or I/O modules are not actually mounted.

## 5. Operating System Overview

The operation modes are switched by the mode control switch provided on the T1/T1S and the mode control commands issued from the programming tool.

The mode transition conditions are shown below.

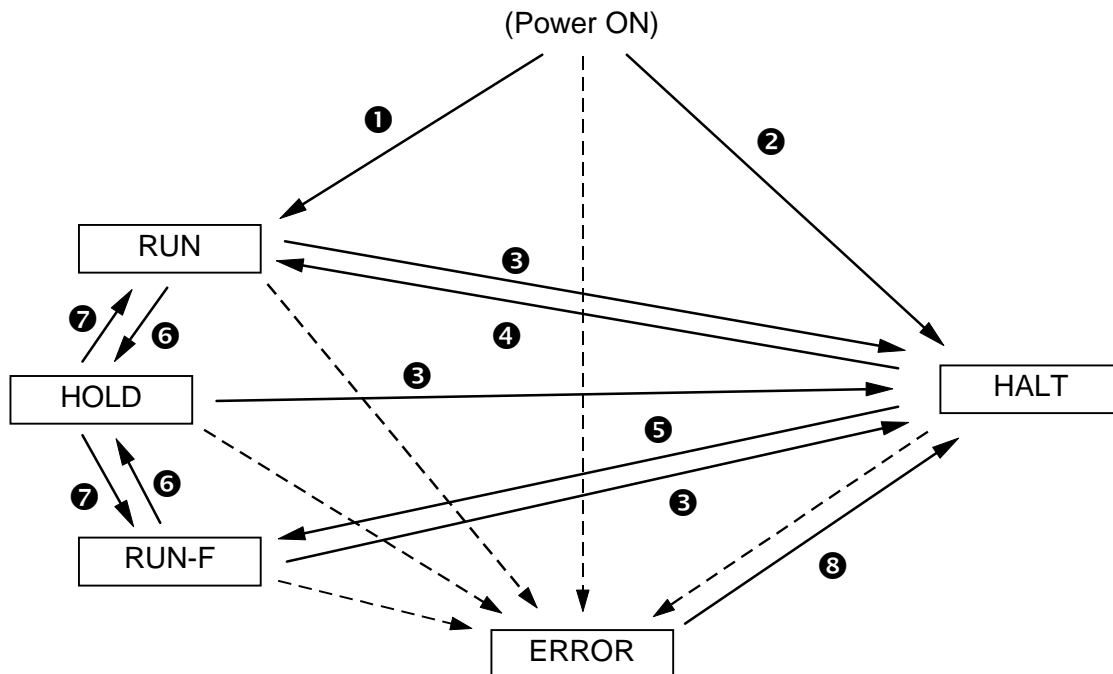

- ① Mode control switch is in R (RUN) side.
  - ② Mode control switch is in H (HALT) side.
  - ③ Mode control switch is turned to H (HALT) side, or HALT command is issued from the programming tool.
  - ④ Mode control switch is turned to R (RUN) side, or RUN command is issued from the programming tool.
  - ⑤ Force RUN (RUN-F) command is issued from the programming tool.
  - ⑥ HOLD command is issued from the programming tool.
  - ⑦ HOLD Cancel command is issued from the programming tool.
  - ⑧ Error Reset command is issued from the programming tool.
- > (dotted line) Error is detected by self-diagnosis.



**NOTE** The commands from the programming tool are available when the mode control switch is in R (RUN) side.

## 5. Operating System Overview

### 5.2 About the built-in EEPROM

The T1/T1S is equipped with a built-in EEPROM and a RAM as standard features. The user program is stored in the EEPROM so that the user program can be maintained without the need of a battery. A part of the Data register can also be stored in the EEPROM.

The table below shows the contents stored in the built-in EEPROM.

	T1	T1S
User program	Entire program (2 k steps) and System information	Entire program (8 k steps) and System information
User data	Leading 512 words of Data register (fixed). D0000 - D0511	User specified number of Data register starting with address 0. It is set by SW55. D0000 - Dnnnn (up to 2048 words)
Other data	–	SW36 - SW38: Programmer port settings SW55: Number of Data register to be saved in the EEPROM SW56 - SW57: RS-485 port settings

The user program and the data stored in the EEPROM is transferred to the RAM when power is turned on. Subsequent program execution is done based on the RAM contents. Program editing is also performed on the RAM contents.

***Therefore, if the program is modified, it is necessary to issue the EEPROM Write command from the programming tool. Otherwise, the modified program is overwritten by original EEPROM contents when the power is turned off and on again.***

## 5. Operating System Overview

< T1 >

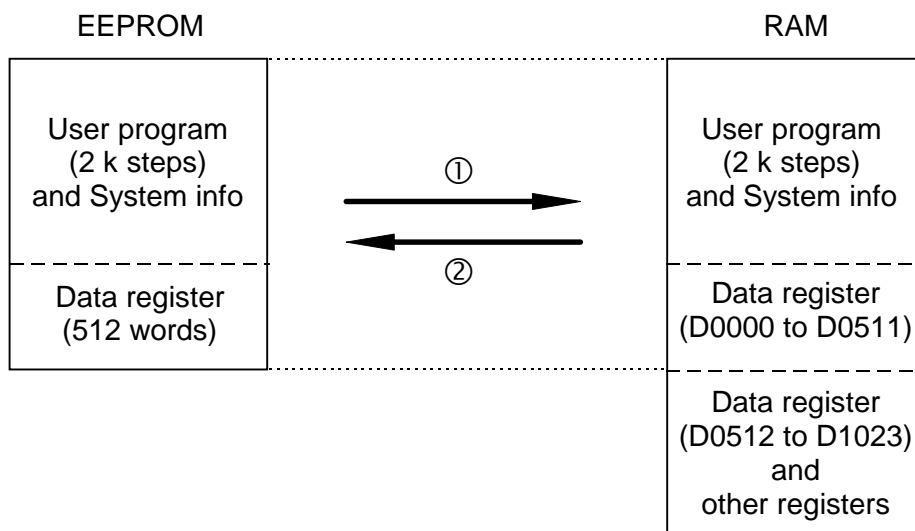

< T1S >

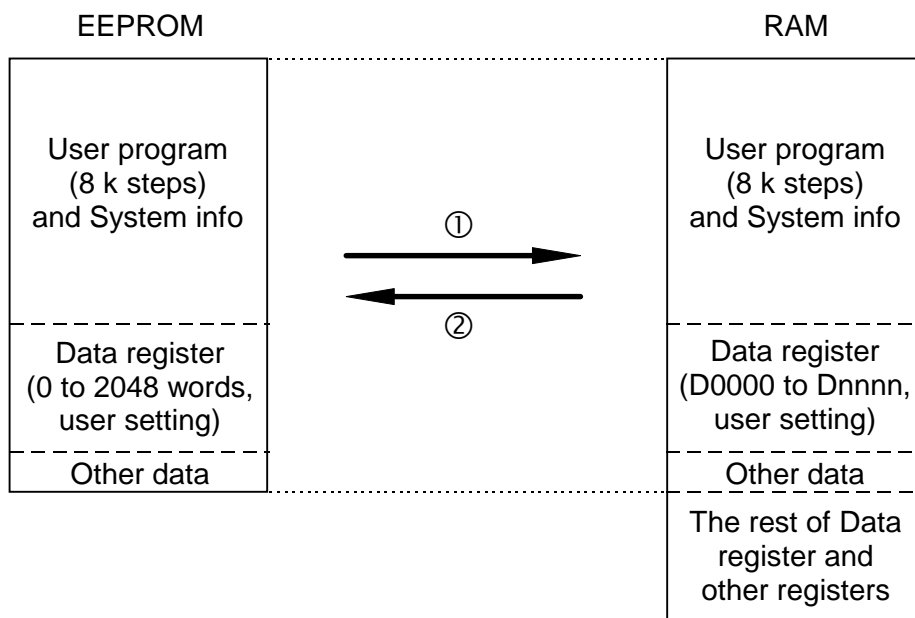

- ① When power is turned on (it is called initial load) or EEPROM Read command is issued from the programming tool. The EEPROM Read is possible only in the HALT mode.
- ② When EEPROM Write command is issued from the programming tool. It is possible only in the HALT mode (T1), or in other than the ERROR mode (T1S).

## 5. Operating System Overview

In case of the T1S, Special register SW55 is used to specify the number of Data registers to be stored in the EEPROM. The allowable setting value is 0 to 2048.

The table below shows the correspondence between the SW55 value and Data registers saved in the EEPROM.

SW55 setting value	Range of Data registers saved in EEPROM	Remarks
0	None	
1	D0000 only	
2	D0000 to D0001	
3	D0000 to D0002	
:	:	
2047	D0000 to D2046	
2048	D0000 to D2027	Default value
Others	D0000 to D2027	Regarded as 2048

When the EEPROM Write command is executed, the T1S checks the value of SW55 and saves the Data registers into the EEPROM depending on the SW55 value. The value of SW55 itself is also saved in the EEPROM.

At the initial load or the EEPROM Read command is executed, the T1S checks the value for SW55 in the EEPROM and transfers the corresponding number of data to the Data registers of the RAM.



- (1) The EEPROM has the life limit for writing. It is 100,000 times. Pay attention not to exceed the limit. If the number of execution of EEPROM Write command exceeds 100,000 times, EEPROM alarm flag (S007) comes ON.
- (2) In the T1S, if the EEPROM Write command is executed in RUN mode, only the user program is written into the EEPROM.
- (3) The data in the EEPROM (D0000 to D0511 or D0000 to D2047) can also be read or written by using the program instruction (FUN236 XFER instruction).
- (4) The SW55 setting is available only for the T1S.



## 5. Operating System Overview

### 5.3 Scanning

The flowchart below shows the basic internal operations performed by the T1/T1S from the time power is turned on through program execution. As the diagram shows, executing a program consists of continuous scanning operations. One scan is a cycle starting with the self-diagnosis and ending with the completion of peripheral support.

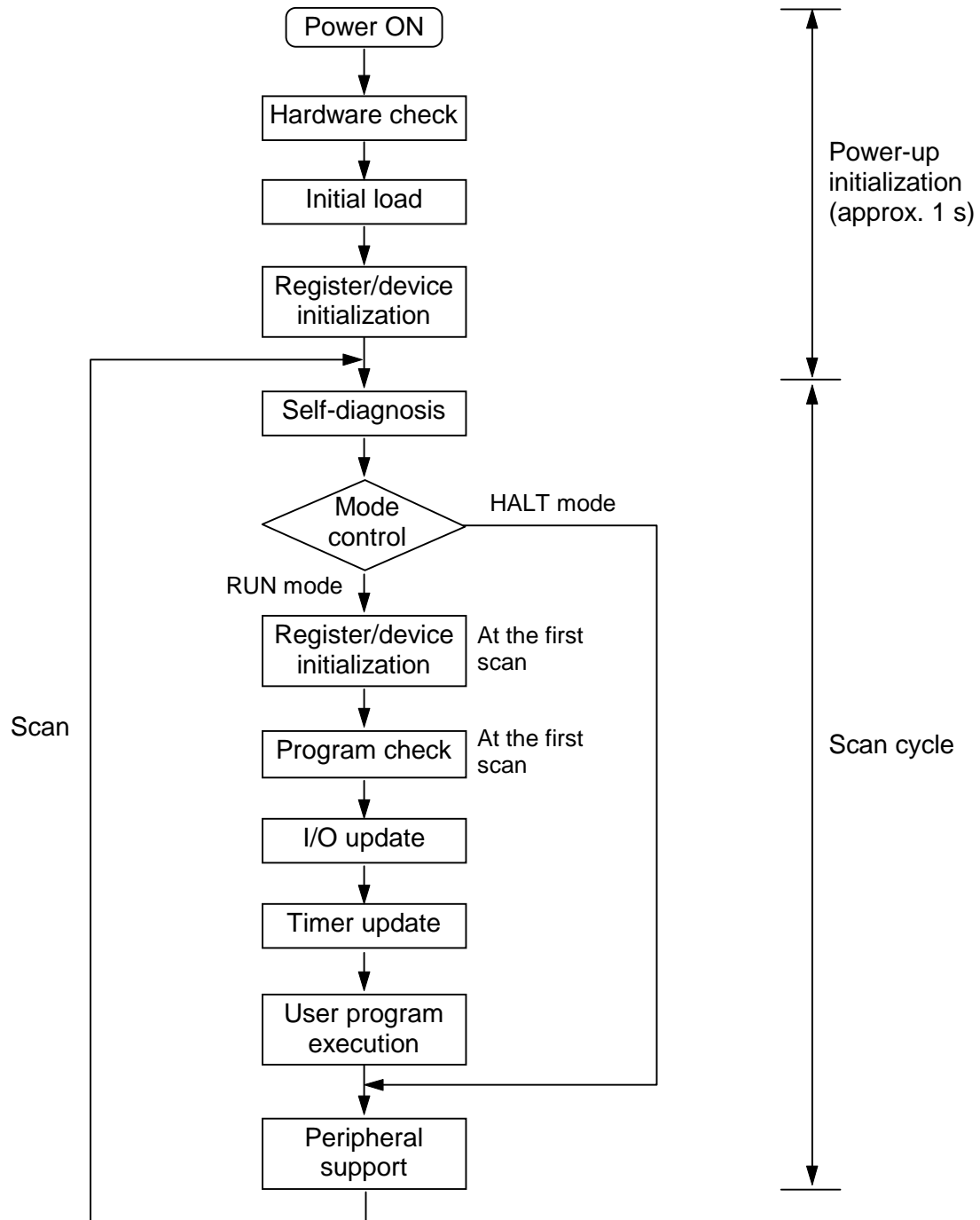

## 5. Operating System Overview

### Hardware check:

Performs checking and initialization of the system ROM, the system RAM and the peripheral LSIs.

### Initial load:

Transfers the user program and user data from the EEPROM to the RAM. (Refer to section 5.2)

### Register/device initialization:

Initializes registers and devices as shown below.

Register/device	Initialization
External input (X/XW)	Forced inputs are retained. Others are cleared to 0.
External output (Y/YW)	Forced coil devices are retained. Others are cleared to 0.
Auxiliary device/register (R/RW)	User specified retentive registers and forced coil devices are retained. Others are cleared to 0.
Special device/register (S/SW)	Special setting data are retained. Others are cleared to 0.
Timer device/register (T./T)	User specified retentive registers are retained. Others are cleared to 0.
Counter device/register (C./C)	User specified retentive registers are retained. Others are cleared to 0.
Data register (D)	User specified retentive registers are retained. Others are cleared to 0.
Index register (I, J, K)	Cleared to 0.



- (1) When the data stored in the EEPROM (Data registers) are used, these registers should be specified as retentive. Otherwise, these data are transferred from EEPROM to RAM, but then cleared to 0 at the initialization.
- (2) The data in the retentive registers are stored in RAM and backed up by built-in capacitor. The back-up period is 6 hours or more at 25 °C (T1), or 168 hours or more at 25 °C (T1S).  
The T1/T1S checks the validity of the retentive data at the power-up initialization, and if they are not valid, sets the special device (S00F) to ON. Therefore, it is recommended to check the status of S00F in the user program and to initialize the retentive registers if S00F is ON.
- (3) The retentive registers can be set by the programming tool for RW, T, C and D registers. The registers from address 0 to the designated address for each type are set as retentive registers. Refer to the separate manual for the programming tool for setting the retentive registers.
- (4) The input force and the forced coil are functions for program debugging. For details, refer to section 6.7.

## 5. Operating System Overview

### Self-diagnosis:

Checks the proper operation of the T1/T1S itself. If an error has detected and cannot be recovered by re-tries, the T1/T1S moves into ERROR mode. For the self-diagnosis items, refer to section 10.2.

### Mode control:

Checks the mode control switch status and the mode control request commands from the programming tool.

The scan mode – floating scan or fixed-time scan – is also controlled here.



#### The floating scan:

When one scan is finished, immediately starts the next scan. The scan time is shortest, but may vary depending on the program execution status.

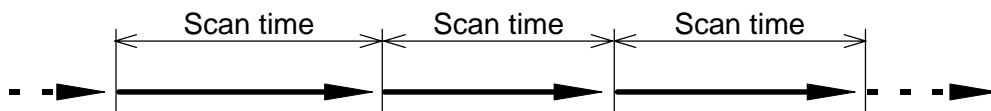

#### The fixed-time scan:

The scan operation is started every user-specified time. The time setting range is 10 to 200 ms (10 ms units). If an actual scan needs longer time than the setting time, it works as the floating scan.

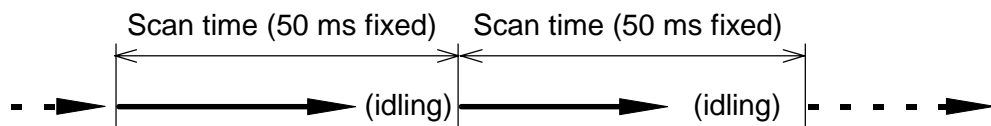

### Program check:

At the beginning of the RUN mode, the user program is compiled and its validity is checked.

### I/O update:

Reads the external input signals into the external input devices/registers (X/XW), and sends the data of the external output devices/registers (Y/YW) to the external output circuits. Then the outputs (relays, etc.) changes the states and latches until the next I/O update timing.

The states of the forced input devices are not updated by this operation.

### Timer update:

Updates the timer registers which are activated in the user program, and the timing devices (S040 to S047).

## 5. Operating System Overview

### **User program execution:**

Executes the programmed instructions from the beginning to the END instruction.

This is the essential function of the T1/T1S.

In this section, only the main program execution is mentioned. For other program types, such as timer interrupt, etc., refer to section 6.5.

### **Peripheral support:**

Supports the communications with the programming tool or an external devices connected by the computer link function. The time for this operation is limited within approx. 2 ms in the floating scan mode, and within allowable idling time in the fixed-time scan mode.

In case of the T1S, if the special relay S158 is set to ON, the peripheral support priority mode is selected. In the peripheral support priority mode, the peripheral support time is not limited. As the result, the communication response is improved although the scan time becomes long at the time.

---

---

## *Section 6*

# *Programming Information*

---

---

- 6.1 *Devices and registers, 92*
- 6.2 *Index modification, 104*
- 6.3 *Real-time clock/calendar, 106*
- 6.4 *I/O allocation, 107*
- 6.5 *T1S memory mode setting, 109*
- 6.6 *User program configuration, 110*
- 6.7 *Programming language, 116*
- 6.8 *Program execution sequence, 117*
- 6.9 *On-line debug support functions, 118*
- 6.10 *Password protection, 121*

## 6. Programming Information

### 6.1 Devices and registers

The T1/T1S program consists of bit-based instructions that handle ON/OFF information, such as contact and coil instructions, and register-based (16-bit) instructions, such as those for data transfer and arithmetic operations.

Devices are used to store the ON/OFF information of contacts and coils, and registers are used to store 16-bit data.

Devices are divided into six types:

- X External input devices
- Y External output devices
- R Auxiliary relay devices
- S Special devices
- T. Timer devices
- C. Counter devices

Registers are divided into eight types:

- XW External input registers
- YW External output registers
- RW Auxiliary relay registers
- SW Special registers
- T Timer registers
- C Counter registers
- D Data registers
- I, J, K Index registers

#### Device and register numbers

X devices share the same memory area as XW registers. Device X014, for example, represents the number 4 bit in the XW01 register.

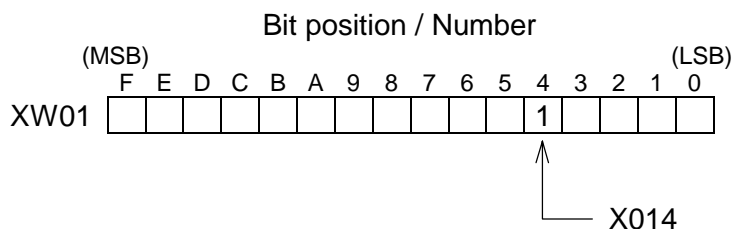

Thus, "X014 is ON" means that bit number 4 of XW01 is 1. Y, R, and S devices work in a similar manner.

## 6. Programming Information

### Addressing devices

A device number of X, Y, R and S devices consists of a register number and bit position as follows.

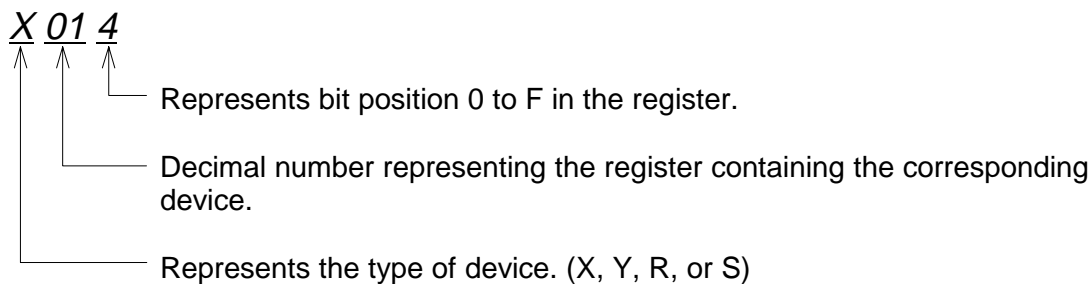

As for the timer (T.) and the counter (C.) devices, a device number is expressed as follows.

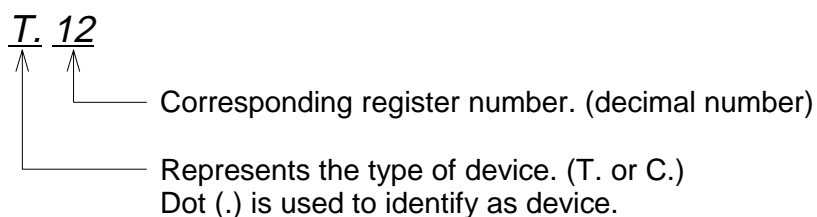

### Addressing registers

A register number except the index registers is expressed as follows.

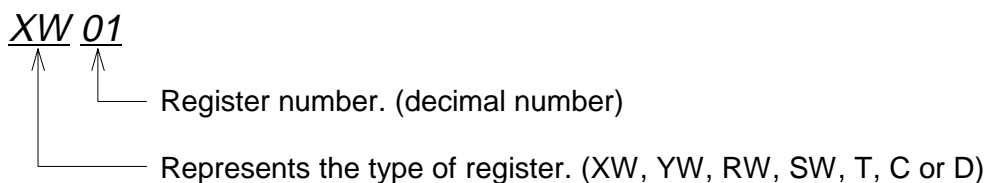

The index registers (I, J and K) do not have the number.

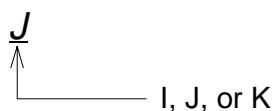

## 6. Programming Information

### Available address range

Device/register	Symbol	T1		T1S	
		Number of points	Address range	Number of points	Address range
External input device	X	Total 512 points	X000 - X31F	Total 512 points	X000 - X31F
External output device	Y		Y020 - Y31F		Y020 - Y31F
External input register	XW	Total 32 words	XW00 - XW31	Total 32 words	XW00 - XW31
External output register	YW		YW02 - YW31		YW02 - YW31
Auxiliary relay device	R	1024 points	R000 - R63F	4096 points	R000 - R255F
Auxiliary relay register	RW	64 words	RW00 - RW63	256 words	RW000 - RW255
Special device	S	1024 points	S000 - S63F	1024 points	S000 - S63F
Special register	SW	64 words	SW00 - SW63	64 words	SW00 - SW63
Timer device	T.	64 points	T.00 - T.63	256 points	T.000 - T.255
Timer register	T	64 words	T00 - T63	256 words	T000 - T255
Counter device	C.	64 points	C.00 - C.63	256 points	C.000 - C.255
Counter register	C	64 words	C00 - C63	256 words	C000 - C255
Data register	D	1024 words	D0000 - D1023	4096 words	D0000 - D4095
Index register	I	1 word	I (no address)	1 word	I (no address)
	J	1 word	J (no address)	1 word	J (no address)
	K	1 word	K (no address)	1 word	K (no address)

#### NOTE



- (1) 1 word = 16 bits
- (2) The available data range in each register is -32768 to 32767 (H8000 to H7FFF) except for the timer and the counter registers. The data range of the timer register is 0 to 32767. That of the counter register is 0 to 65535.
- (3) Double-word (32 bits) data is available in two consecutive registers. In this case, lower address register stores the lower 16 bits data.

(MSB) F ..... 0 F ..... 0 (LSB)

D0101     D0100

Upper                  Lower  
 16 bits                  16 bits

In this manual, a double-word register is expressed by using ‘.’.  
For example, D0101.D0100.



## 6. Programming Information

### External input devices (X)

These devices (X) indicate the ON/OFF states of external input signals through the input circuits. External input devices can be used many times in a program.

### External output devices (Y)

The external output devices (Y) store the ON/OFF signals that drive the external devices through the output circuits. They can be used for coils in a program.

### External input registers (XW)

These (XW) are 16-bit registers for storing values which are received from the input circuits.

### External output registers (YW)

These 16-bit registers (YW) are used for storing values which are sent to the output circuits.

### Auxiliary relay devices and registers (R/RW)

The auxiliary relay devices (R) are used to store intermediate results of sequences. The auxiliary relay registers (RW) are used to store temporary results of function instructions. The data in R/RW cannot be output directly to the output circuits. It is necessary to move the data to Y/YW.

It is possible to make these registers retentive so that they retain data in the event of a power failure. See section 5.3.

### Timer devices and registers (T./T)

The timer registers (T) are used for storing the elapsed time of timer instructions, the on-delay (TON), off-delay (TOF) and single-shot (SS) timers.

0.01 s base timers and 0.1 s base timers are provided.

Time base	T1	T1S
0.01 s	T000 to T031	T000 to T063
0.1 s	T032 to T063	T064 to T255

The timer devices (T.) works as the output of the timer instructions.

It is possible to specify the T registers as retentive to retain their data in the event of a power failure. See section 5.3.

## 6. Programming Information

### Counter devices and registers (C./C)

The counter registers (C) are used for storing the count value of the counter (CNT) and the up-down counter (U/D) instructions.

The counter devices (C.) works as the output of the counter instructions.

It is possible to specify the C registers as retentive to retain their data in the event of a power failure. See section 5.3.

### Data registers (D)

Functionally the data registers (D) are the same as auxiliary relay registers (RW) except that the D registers cannot be used as devices.

A part of the data registers are saved in the built-in EEPROM as fixed data and transferred into the RAM at the initial load. See section 5.2.

Range of the data registers saved in the EEPROM:

T1	T1S
D0000 to D0511	User specified range starting with D0000 (up to 2048 words)

It is possible to specify the D registers as retentive to retain their data in the event of a power failure. See section 5.3.

### Index registers (I, J, and K)

These index registers are used for indirect addressing for a register.

For example, if the value of I is 100 in the following register expression, it designates D0100. For details, refer to section 6.2.

$$D0000 \xrightarrow{I} D0100 \text{ if } I=100$$

## 6. Programming Information

### Special devices and registers (S/SW)

The special devices (S) and special registers (SW) are used for special purposes. See list below.

Device/ register	Name	Function
S000	T1/T1S operation mode	0: Initialization 4: HOLD mode
S001		1: HALT mode                      6: ERROR mode
S002		2: RUN mode
S003		3: RUN-F mode
S004	CPU error (down)	ON at error state (related to SW01)
S005	I/O error (down)	ON at error state (related to SW02)
S006	Program error (down)	ON at error state (related to SW03)
S007	EEPROM alarm (alarm)	ON when EEPROM write exceeds 100,000 times
S008	Fixed-time scan time-over (alarm)	ON when actual scan time is longer than the setting time as fixed-time scan
S009	–	Reserved
S00A	Clock/calendar error (alarm)	ON when clock/calendar data is illegal (T1S only)
S00B	–	Reserved
S00C	–	Reserved
S00D	TL-F10 error (alarm)	ON when TOSLINE-F10 transmission error occurs
S00E	–	Reserved
S00F	Retentive data invalid (alarm)	ON when retentive data in RAM are invalid



- NOTE**
- (1) These devices are set by the T1/T1S operating system. These devices are read only for user.
  - (2) Devices marked as (down) are set in the ERROR mode. Therefore these devices cannot be used in the user program.
  - (3) Devices marked as (alarm) are set in the normal operation mode. These devices can be used in the user program.

## 6. Programming Information

Device/ register	Name	Function
S010	System ROM error (down)	ON at error state
S011	System RAM error (down)	ON at error state
S012	Program memory error (down)	ON at error state
S013	EEPROM error (down)	ON at error state
S014	–	Reserved
S015	–	Reserved
S016	–	Reserved
S017	–	Reserved
S018	–	Reserved
S019	–	Reserved
S01A	–	Reserved
S01B	–	Reserved
S01C	–	Reserved
S01D	–	Reserved
S01E	–	Reserved
S01F	Watchdog timer error (down)	ON at error state
S020	I/O bus error (down)	ON at error state (for T2 I/O modules)
S021	I/O mismatch (down)	ON at error state
S022	I/O no answer (down)	ON at error state (for T2 I/O modules)
S023	I/O parity error (down)	ON at error state (for T2 I/O modules)
S024	–	Reserved
S025	–	Reserved
S026	–	Reserved
S027	–	Reserved
S028	–	Reserved
S029	–	Reserved
S02A	–	Reserved
S02B	–	Reserved
S02C	–	Reserved
S02D	–	Reserved
S02E	–	Reserved
S02F	–	Reserved



- (1) These devices are set by the T1/T1S operating system. These devices are read only for user.
- (2) Devices marked as (down) are set in the ERROR mode. Therefore these devices cannot be used in the user program.

## 6. Programming Information

Device/ register	Name	Function
S030	Program error	ON at error state (related to SW06)
S031	Scan time over (down)	ON when the scan time exceeds 200 ms
S032	–	Reserved
S033	–	Reserved
S034	–	Reserved
S035	–	Reserved
S036	–	Reserved
S037	–	Reserved
S038	–	Reserved
S039	–	Reserved
S03A	–	Reserved
S03B	–	Reserved
S03C	–	Reserved
S03D	–	Reserved
S03E	–	Reserved
S03F	–	Reserved
S040	Timing relay 0.1 s	OFF 0.05 s / ON 0.05 s (0.1 s interval)
S041	Timing relay 0.2 s	OFF 0.1 s / ON 0.1 s (0.2 s interval)
S042	Timing relay 0.4 s	OFF 0.2 s / ON 0.2 s (0.4 s interval)
S043	Timing relay 0.8 s	OFF 0.4 s / ON 0.4 s (0.8 s interval)
S044	Timing relay 1.0 s	OFF 0.5 s / ON 0.5 s (1.0 s interval)
S045	Timing relay 2.0 s	OFF 1.0 s / ON 1.0 s (2.0 s interval)
S046	Timing relay 4.0 s	OFF 2.0 s / ON 2.0 s (4.0 s interval)
S047	Timing relay 8.0 s	OFF 4.0 s / ON 4.0 s (8.0 s interval)
S048	–	Reserved
S049	–	Reserved
S04A	–	Reserved
S04B	–	Reserved
S04C	–	Reserved
S04D	–	Reserved
S04E	Always OFF	Always OFF
S04F	Always ON	Always ON



- (1) These devices are set by the T1/T1S operating system. These devices are read only for user.
- (2) Devices marked as (down) are set in the ERROR mode. Therefore these devices cannot be used in the user program.

## 6. Programming Information

Device/ register	Name	Function
S050	CF (carry flag)	Used for instructions which manipulate carry
S051	ERF (instruction error flag)	ON when instruction execution error is occurred (related to alarm flags of SW06)
S052	–	Reserved
S053	–	Reserved
S054	–	Reserved
S055	–	Reserved
S056	–	Reserved
S057	–	Reserved
S058	–	Reserved
S059	–	Reserved
S05A	–	Reserved
S05B	–	Reserved
S05C	–	Reserved
S05D	–	Reserved
S05E	–	Reserved
S05F	–	Reserved
S060	Illegal instruction (down)	ON when illegal instruction is detected
S061	–	Reserved
S062	–	Reserved
S063	–	Reserved
S064	Boundary error (alarm)	ON when illegal address is designated by indirect addressing (operation continued)
S065	–	Reserved
S066	–	Reserved
S067	–	Reserved
S068	Division error (alarm)	ON when error occurs in division instruction (operation continued)
S069	BCD data error (alarm)	ON when BCD data error has detected in BCD operation instructions (operation continued)
S06A	Table operation error (alarm)	ON when table size error has detected in table operation instructions (operation continued) (T1S only)
S06B	Encode error (alarm)	ON when error occurs in encode instruction (operation continued)
S06C	–	Reserved
S06D	–	Reserved
S06E	–	Reserved
S06F	–	Reserved



- (1) Devices marked as (down) are set in the ERROR mode. Therefore these devices cannot be used in the user program.
- (2) CF, ERF and devices marked as (alarm) can be reset by the user program.

## 6. Programming Information

Device/ register	Name	Function	
SW07	Clock/calendar (Year)	Lower 2 digits of the calendar year (98, 99, 00, 01, ... )	They are stored in the lower 8 bits by BCD code (T1S only)
SW08	Clock/calendar (Month)	Month (01, 02, ... 12)	
SW09	Clock/calendar (Day)	Day (01, 02, ... 31)	
SW10	Clock/calendar (Hour)	Hour (00, 01, ... 59)	
SW11	Clock/calendar (Minute)	Minute (00, 01, ... 59)	
SW12	Clock/calendar (Second)	Second (00, 01, ... 59)	
SW13	Clock/calendar (Week)	Day of the week (Sun = 00, Mon = 01, ... Sat = 06)	
SW14	–	Reserved	
SW15	Peripheral support priority	Bit 8 (S158) is used to select peripheral support priority (T1S only)	
SW16	Mode of special input functions	Used to select the special input functions	
SW17	Input filter constant	Used to set the input filter constant	
SW18	Preset values for high speed counter	Used to set the preset values for high speed counters	
SW19			
SW20			
SW21			
SW22	Count values for high speed counter	Present count values of the high speed counters are stored	
SW23			
SW24	High speed counter control flags	Control flags for the high speed counters	
SW25	–	Reserve	
SW26	Mode of special output functions	Used to select the special output functions	
SW27	Special output control flags	Control flags for the pulse/PWM output	
SW28	Special output frequency setting	Output frequency setting for the pulse/PWM output	
SW29	PWM output duty setting	Pulse duty setting for the PWM output	
SW30	Analog setting value 1	Input value of the analog setting adjuster V0	
SW31	Analog setting value 2	Input value of the analog setting adjuster V1	
SW32	AUX LED control	Bit 0 (S320) is used to control AUX LED (T1-40/T1-40S only)	
SW33	–	Reserved	
SW34	TL-F10 send data	TOSLINE-F10 transmission data (send to master)	
SW35	TL-F10 receive data	TOSLINE-F10 transmission data (receive from master)	
SW36	PRG port station address	Used to set the programmer port station address (1 to 32) (T1S only)	
SW37	PRG port parity	Used to set the programmer port parity (0=none, 1=odd) (T1S only)	
SW38	PRG port response delay	Used to set the programmer port response delay time (0 to 30: 0 to 300ms)	



- (1) For details of SW16 though SW31, refer to section 8.  
 (2) For details of SW34 and SW35, refer to the Expansion I/O manual.  
 (3) For details of SW36 through SW38, refer to the Communication function manual.

## 6. Programming Information

Device/ register	Name	Function
S390	Timer interrupt execution status	ON during execution
S391	I/O interrupt #1 execution status	ON during execution
S392	I/O interrupt #2 execution status	ON during execution
S393	I/O interrupt #3 execution status	ON during execution
S394	I/O interrupt #4 execution status	ON during execution
S395	–	Reserved
S396	–	Reserved
S397	–	Reserved
S398	–	Reserved
S399	–	Reserved
S39A	–	Reserved
S39B	–	Reserved
S39C	–	Reserved
S39D	–	Reserved
S39E	–	Reserved
S39F	–	Reserved
S400	–	Reserved
S401	HOLD device	ON during HOLD mode (setting by user program is also available)
S402	–	Reserved
S403	–	Reserved
S404	–	Reserved
S405	–	Reserved
S406	–	Reserved
S407	–	Reserved
S408	–	Reserved
S409	–	Reserved
S40A	–	Reserved
S40B	–	Reserved
S40C	–	Reserved
S40D	–	Reserved
S40E	–	Reserved
S40F	–	Reserved



## 6. Programming Information

Device/ register	Name	Function
SW41	Sub-program #1 execution status	Bit 0 (S410) is ON during the sub-program #1 is executed
SW42	–	Reserved
SW43	–	Reserved
SW44	–	Reserved
SW45	–	Reserved
SW46	–	Reserved
SW47	–	Reserved
SW48	–	Reserved
SW49	–	Reserved
SW50	–	Reserved
SW51	–	Reserved
SW52	–	Reserved
SW53	–	Reserved
SW54	–	Reserved
SW55	Number of EEPROM write data	Used to set the number of data registers to be saved in the EEPROM (0 to 2048, initial value is 2048) (T1S only)
SW56	RS-485 port operation mode	Used to set the RS-485 port operation mode (T1S only)
SW57	RS-485 port response delay	Used to set the RS-485 port response delay time (0 to 30: 0 to 300ms) (T1S only)
SW58	RS-485 port Free ASCII flags	Used for the RS-485 port Free ASCII function (T1S only)
SW59	–	Reserved
SW60	–	Reserved
SW61	–	Reserved
SW62	–	Reserved
SW63	–	Reserved



- (1) For details of SW55, refer to section 5.2.  
 (2) For details of SW56 through SW58, refer to the Communication function manual.

## 6. Programming Information

### 6.2 Index modification

When registers are used as operands of instructions, the method of directly designating the register address as shown in Example 1) below is called 'direct addressing'.

As opposed to this, the method of indirectly designating the register by combination with the contents of the index register (I, J, or K) as shown in Example 2) below is called 'indirect addressing'. In particular, in this case, since the address is modified using an index register, this is called 'index modification'.

Example 1)

—[ RW10 MOV D1000 ]—

Data transfer instruction  
Transfer data of RW10 to D1000

Example 2)

          I          J  
—[ RW10 MOV D0000 ]—

Data transfer instruction (with index modification)  
Transfer data of RW(10 + I) to D(0000 + J)  
(If I = 3 and J = 200, the data of RW13 is transferred to D0200)

There are 3 types of index register, I, J and K. Each type processes 16-bit integers (-32768 to 32767). There are no particular differences in function between these 3 types of index register.

There is no special instruction for substituting values in these index registers. These are designated as destination of data transfer instructions, etc.

—[ 00064 MOV I ]—           (substitutes 64 in index register I)  
—[ D0035 MOV J ]—           (substitutes the data of D0035 in index register J)  
—[ RW20 + 00030 → K ]— (substitutes the result of addition in index register K)



- NOTE**
- (1) The index modification is available for RW, T, C and D registers.
  - (2) If index registers are used as a double-length register, only the combinations J-I and K-J are allowed.

## 6. Programming Information

The followings are examples of index modifications.

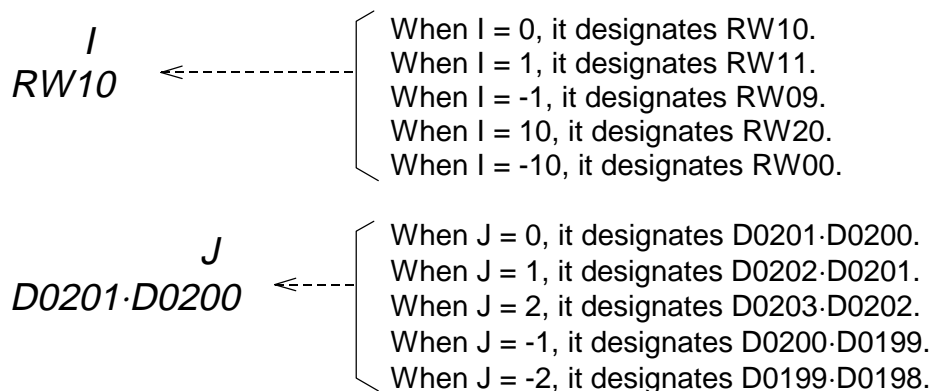

### CAUTION

Be careful that the registers do not exceed the address range by the index modification. The address range is not checked by the T1/T1S.



### NOTE

Substitutions of values into index registers and index modifications can be used any times in a program. Normally, the program will be easier to see if a value substitution into an index register is positioned immediately before the index modification.

## 6. Programming Information

### 6.3 Real-time clock/calendar (T1S only)

The T1S is equipped with the real-time clock/calendar for year, month, day, day of the week, hour, minute, and second.

These data are stored in the special registers SW07 to SW13 by 2-digit BCD format as follows.

Register	Function	Data
SW07	Year	1998 = H0098, 1999 = H0099, 2000 = H0000, 2001 = H0001, ...
SW08	Month	Jan. = H0001, Feb. = H0002, Mar. = H0003, ... Dec. = H0012
SW09	Day	1st = H0001, 2nd = H0002, 3rd = H0003, ... 31st = H0031
SW10	Hour	H0000, H0001, H0002, ... H0022, H0023
SW11	Minute	H0000, H0001, H0002, ... H0058, H0059
SW12	Second	H0000, H0001, H0002, ... H0058, H0059
SW13	Week	Sun. = H0000, Mon. = H0001, Tue. = H0002, ... Sat. = H0006

#### Program example:

In the following circuit, output Y030 turns ON for 1 minute at every Sunday 6 pm.

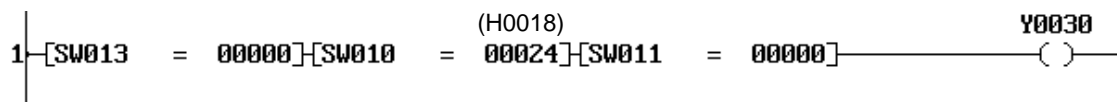

#### Clock/calendar back-up:

The clock/calendar continues updating even while the power to the T1S is off by built-in capacitor. Its back-up period is as follows.

Temperature	Expected value	Guarantee value
25 °C	300 hours	168 hours
40 °C	144 hours	72 hours

In the T1S, the validity of the clock/calendar is checked. If the data is not valid by excess power off period, special relay S00A is set to ON. Therefore, when the clock/calendar is used, it is recommended to check the status of S00A in the user program.

#### Setting the clock/calendar:

To set the clock/calendar data, the following 2 ways are available. In both cases, the week data is automatically calculated.

- (a) Setting the clock/calendar data on the system information screen of the programming tool.
- (2) Using the Calendar Set instruction (CLND) in the user program.

## 6. Programming Information

### 6.4 I/O allocation

The external input signals are allocated to the external input devices/registers (X/XW). The external output signals are allocated to the external output devices/registers (Y/YW). The register numbers of the external input and output registers are consecutive. Thus one register number can be assigned for either input or output.

As for the T1/T1S basic unit, I/O allocation is fixed as follows.

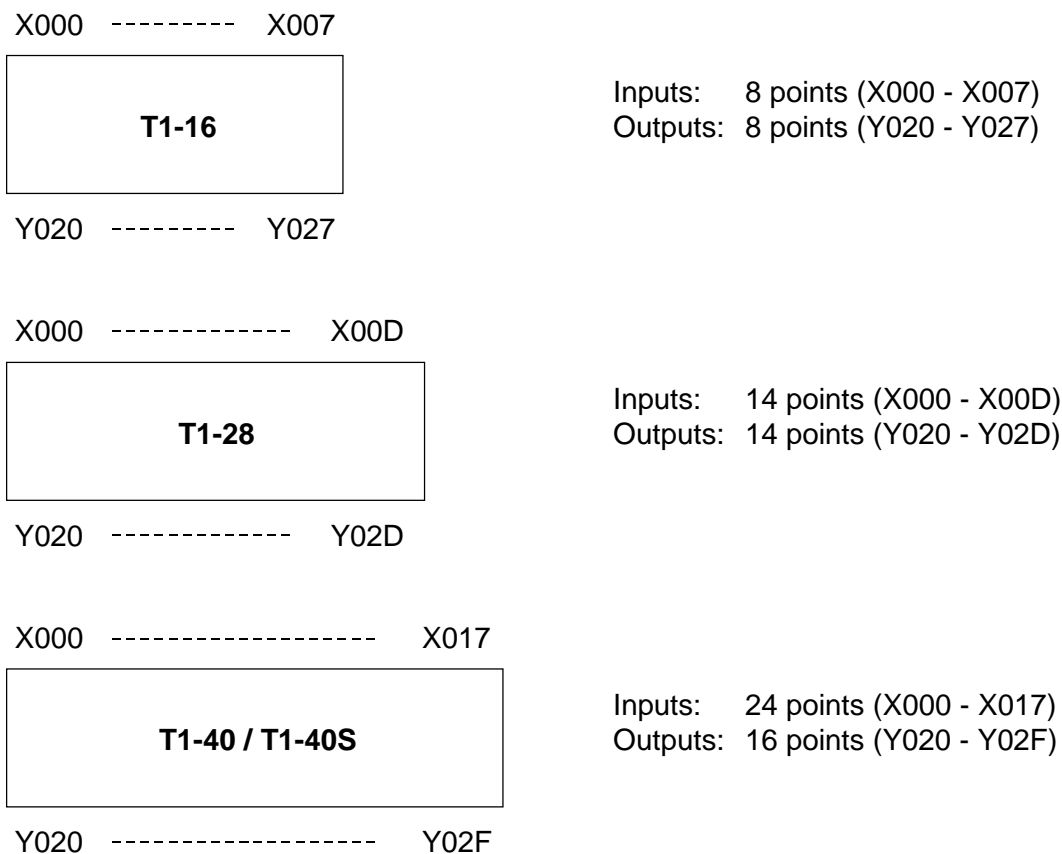

Any operation for the I/O allocation are not required if only the T1/T1S basic unit is used.

However, if the option cards, the Expansion unit and/or the T2 I/O modules are used with the T1-40/T1-40S, the I/O allocation operation is necessary. For this information, refer to the separate manual for Expansion I/O.

## 6. Programming Information

Internally, the T1/T1S has an information called 'I/O allocation table' in its memory. This I/O allocation table shows the correspondence between I/O hardware and software, i.e. register/device.

The contents of the I/O allocation table are as follows.

Slot	I/O type	
PU		← PU slot must be blank
0	X+Y 4W	← Slot 0 is for basic unit (XW00, XW01, YW02 and YW03 are assigned internally)
1		← Slots 1 to 3 are reserved for option cards
2		
3		
4		← Slots 4 and 5 are reserved for Expansion unit
5		
6		← Slots 4 to 7 are reserved for T2 I/O modules
7		

The T1/T1S operating system automatically sets the I/O type 'X+Y 4W' on the slot 0 position when the memory clear is executed for the T1/T1S.

When the T1/T1S program is developed in off-line, the above I/O allocation table should be set before programming. For this operation (called manual I/O allocation), refer to the programming tool manual.

## 6. Programming Information

### 6.5 T1S memory mode setting

The program capacity of the T1S is 8 k steps. However, user can set the T1S's program capacity to 4 k steps. It is called the T1S's memory mode.

That is, the T1S has two memory modes, 8 k mode and 4 k mode.

In the 4 k mode, on-line program changes become available, although the program capacity is limited to 4 k steps. Refer to section 6.9 for the on-line debug support functions.

To set the T1S's memory mode, write 4 k or 8 k on the Program Size Setting of the System Parameters using the programming tool. Then execute the EEPROM write command.



NOTE There is no memory mode setting for the standard T1. The program capacity of the standard T1 is 2 k steps fixed.

## 6. Programming Information

### 6.6 User program configuration

A group of instructions for achieving the PLC-based control system is called 'user program'. The T1 has 2 k steps capacity for storing the user program. And the T1S has 8 k steps capacity for storing the user program.

A 'step' is the minimum unit which composes an instruction. Number of steps required for one instruction is depending on the type of instruction. Refer to section 7.1.

The figure below shows the T1/T1S's memory configuration.

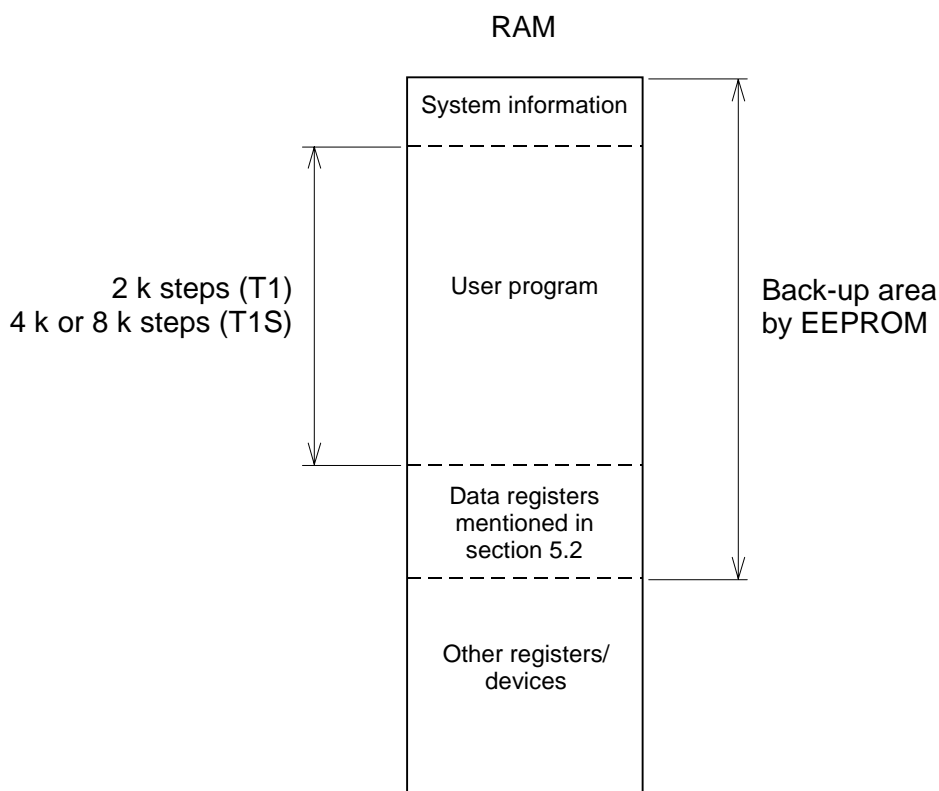

For conditions of transfer between RAM and EEPROM, see section 5.2.



## 6. Programming Information

### System information

System information is the area which stores execution control parameters. The following contents are included in the system information.

- (1) Machine parameters (hardware type, memory type)
- (2) User program information (program ID, system comments, number of steps used)
- (3) Passwords
- (4) Retentive register area information
- (5) T1S program memory mode, 4 k steps or 8 k steps (T1S only)
- (6) Execution control parameters (scan mode, timer interrupt interval)
- (7) Station number setting for programmer port (T1), or RS-485 port communication parameters (T1S)
- (8) I/O allocation table
- (9) Input force table

The system information is stored in the built-in EEPROM. Therefore, when these information is modified, the EEPROM write operation is necessary. Otherwise, these are over-written by original EEPROM contents at the next initial load timing.

### User program

The T1 has a capacity of 2 k steps of the user program. And the T1S has a capacity of 8 k steps of the user program.

The user program is stored by each program types as shown in the following diagram, and is managed by units called blocks in each program types.

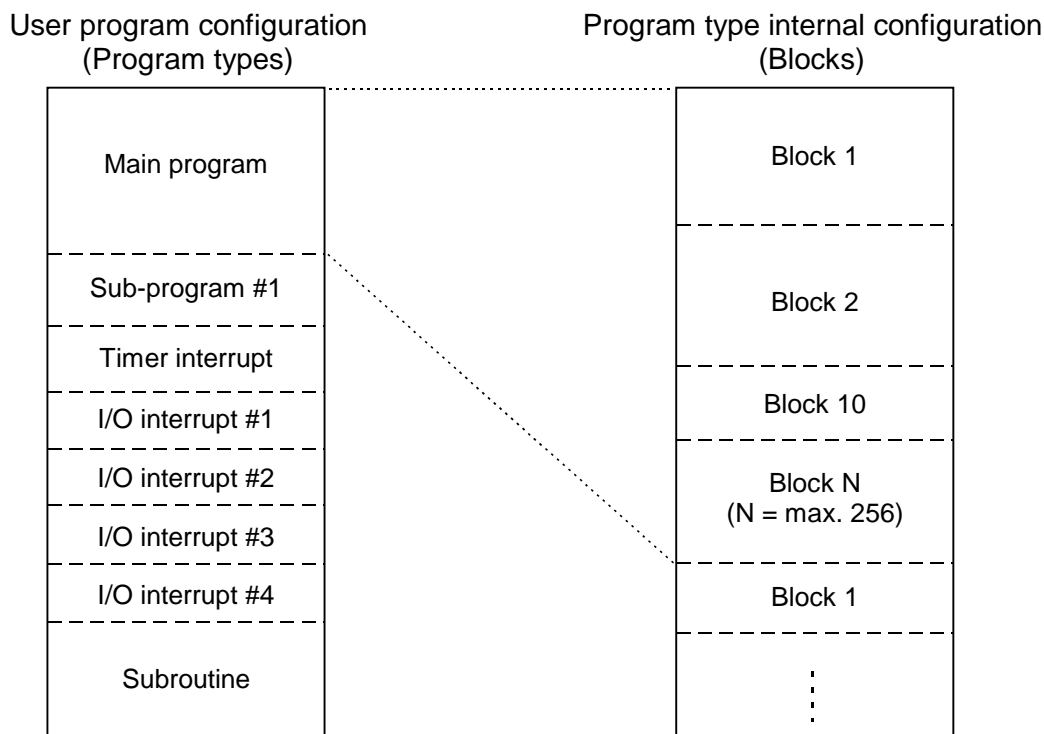

## 6. Programming Information

In the user program, the main program is the core. The scan operation explained in section 5.3 is for the main program. The operation of other program types are explained in the following sections.

The following 8 program types are supported by the T1/T1S.

- (1) Main program
- (2) Sub-program #1
- (3) Timer interrupt program
- (4) I/O interrupt program #1
- (5) I/O interrupt program #2
- (6) I/O interrupt program #3
- (7) I/O interrupt program #4
- (8) Subroutine

The blocks are just separators of the program, and have no effect on the program execution. However, by dividing the user program into some blocks, the program becomes easy to understand. The block numbers need not be consecutive.

In each program type and block, there is no limit of program capacity. The only limit is the total capacity.

### 6.6.1 Main program

The main program is the core of the user program. It is executed once in each scan.

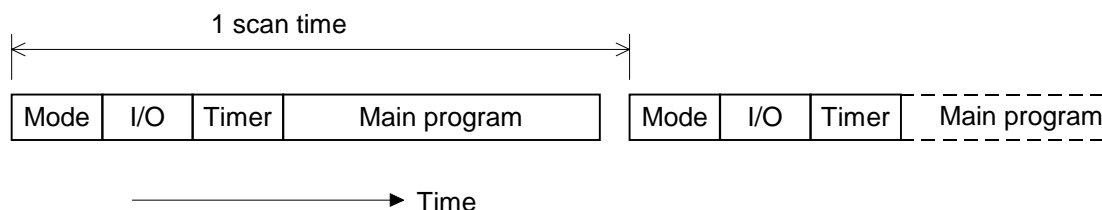

In the above figure,

Mode means the mode control operation

I/O means the I/O update processing

Timer means the timer up date processing

Main program means the main program execution

the self-diagnostic check and peripheral support are omitted in this figure.

The end of the main program is recognized by the END instruction.

Although instructions may be present after the END instruction, these portions will not be executed.

## 6. Programming Information

### 6.6.2 Sub-program #1

If the sub-program #1 is programmed, it is executed once at the beginning of the first scan (before main program execution).

Therefore, the sub-program #1 can be used to set the initial value into the registers. The sub-program #1 is called the initial program.

The figure below shows the first scan operation.

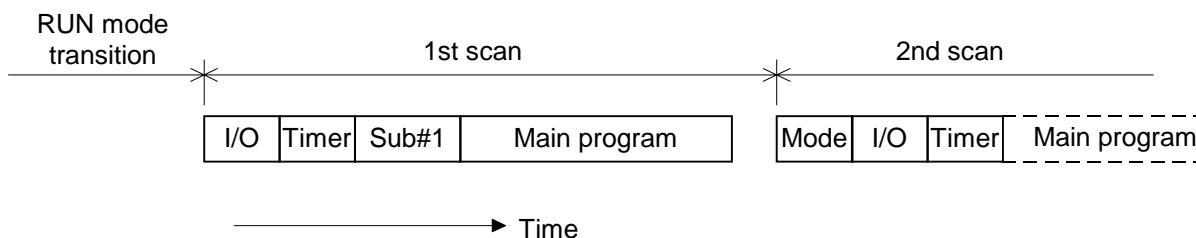

The end of the sub-program #1 is recognized by the END instruction.

### 6.6.3 Timer interrupt program

The timer interrupt is the highest priority task. It is executed cyclically with a user specified interval, with suspending other operation.

The interrupt interval is set in the system information. (5 to 1000 ms, 5 ms units)

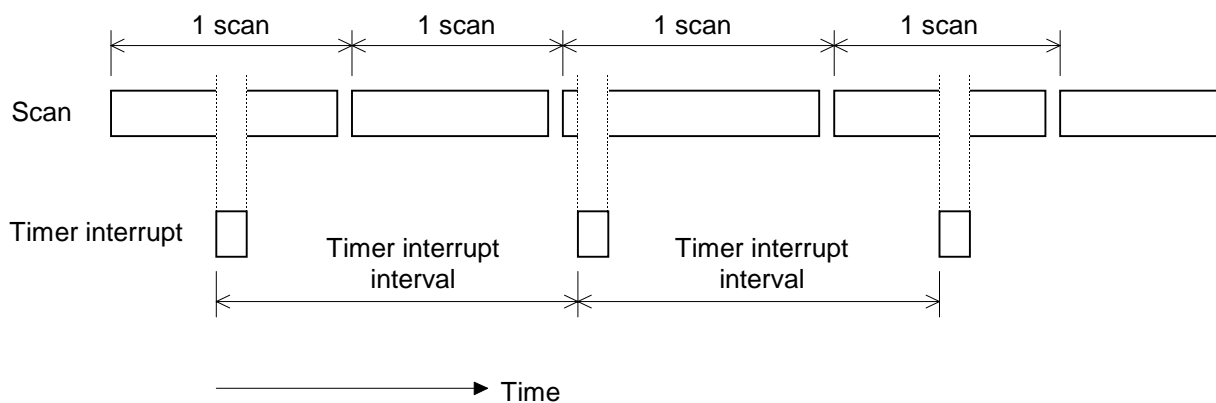

The end of the timer interrupt is recognized by the IRET instruction.

## 6. Programming Information

### 6.6.4 I/O interrupt programs

The I/O interrupt program is also the highest priority task. It is executed immediately when the interrupt factor is generated, with suspending other operation.

the following 4 types I/O interrupt programs are supported in the T1/T1S.

- (1) I/O interrupt #1  
The I/O interrupt #1 is used with the high speed counter function. When the count value reaches the preset value, etc., the I/O interrupt #1 is activated immediately with suspending other operation. The end of the I/O interrupt #1 is recognized by the IRET instruction. For detailed information, refer to section 8.3.
- (2) I/O interrupt #2  
The I/O interrupt #2 is also used with the high speed counter function. Refer to section 8.3 for details.
- (3) I/O interrupt #3  
The I/O interrupt #3 is used with the interrupt input function. When the state of the interrupt input is changed from OFF to ON (or ON to OFF), the I/O interrupt #3 is activated immediately with suspending other operation. The end of the I/O interrupt #3 is also recognized by the IRET instruction. For detailed information, refer to section 8.4.
- (4) I/O interrupt #4  
The I/O interrupt #4 is also used with the interrupt input function. Refer to section 8.4 for details.

If an interrupt factor is generated while other interrupt program is executing (including the timer interrupt), the interrupt factor is held. Then it will be activated after finishing the other interrupt program execution.

If two or more interrupt factors are generated at the same time, the priority is as follows.

Timer > I/O #1 > I/O #2 > I/O #3 > I/O #4

## 6. Programming Information

### 6.6.5 Subroutines

In the program type 'Subroutine', The following number of subroutines can be programmed.

T1	T1S
Up to 16 subroutines	Up to 256 subroutines

The subroutine is not a independent program. It is called from other program types (main program, sub-program, interrupt program) and from other subroutines (T1S only).

One subroutine is started with the SUBR instruction, and ended by the RET instruction.

It is necessary to assign a subroutine number to the SUBR instruction. The available subroutine numbers are 0 to 15 for the T1, or 0 to 255 for the T1S.

—[ SUBR (000) ]—  
 ↑  
 Subroutine number

The RET instruction has no subroutine number.

The instruction that calls a registered subroutine is the CALL instruction. The CALL instruction has the subroutine number to be called.

—[ CALL N.000 ]—  
 ↑  
 Subroutine number

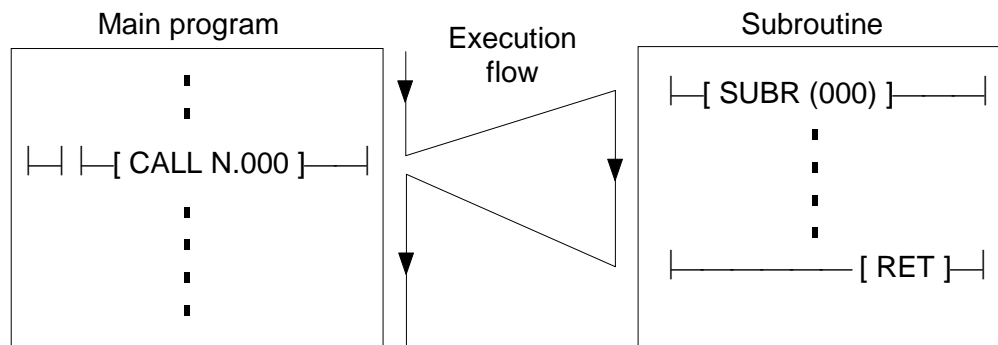

- (1) Multiple subroutines can be programmed in a block. However, one subroutine in one block is recommended.
- (2) In case of the T1S, other subroutines can be called from a subroutine (nesting), up to 3 levels. In the T1, nesting is not allowed.

## 6. Programming Information

### 6.7 Programming language

The programming language of the T1/T1S is 'ladder diagram'.

Ladder diagram is a language which composes program using relay symbols as a base in an image similar to a hard-wired relay sequence. In the T1/T1S, in order to achieve an efficient data-processing program, ladder diagram which are combinations of relay symbols and function blocks are used.

The ladder diagram program is constructed by units called 'rung'. A rung is defined as one network which is connected each other.

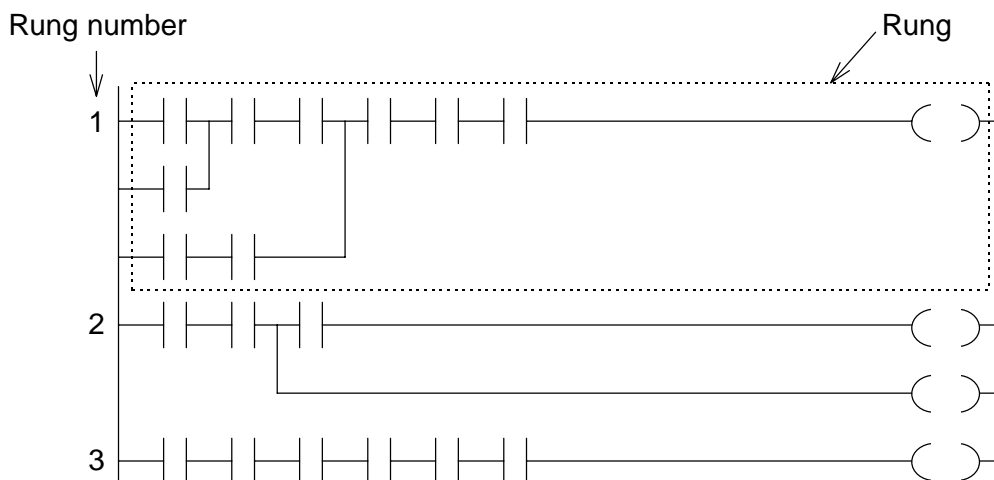

The rung numbers are a series of numbers (decimal number) starting from 1, and cannot be skipped. There is no limit to the number of rungs.

The size of any one rung is limited to 11 lines  $\times$  12 columns.

An example of a ladder diagram program is shown below.



When X005 is ON or the data of D0100 is greater than 200, Y027 comes ON.  
Y027 stays ON even if X005 is OFF and the data of D0100 is 200 or less.  
Y027 will come OFF when X006 comes ON.

## 6. Programming Information

### 6.8 Program execution sequence

The instructions execution sequence is shown below.

- (1) They are executed in the sequence from block 1 through the final block which contains the END instruction (or IRET in an interrupt program).
- (2) They are executed in the sequence from rung 1 through the final rung in a block (or the END instruction).
- (3) They are executed according to the following rules in any one rung.

- ① When there is no vertical connection, they are executed from left to right.

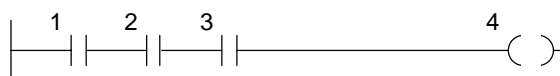

- ② When there is an OR connection, the OR logic portion is executed first.

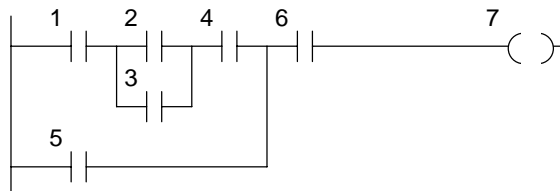

- ③ When there is a branch, they are executed in the order from the upper line to the lower line.

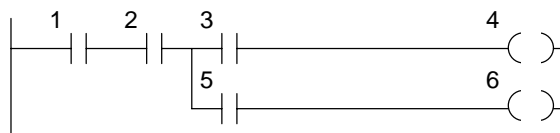

- ④ A combination of ② and ③ above.

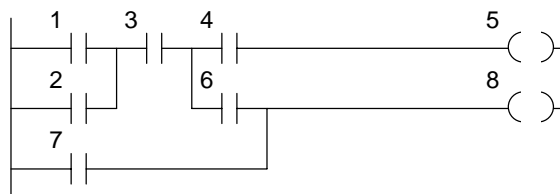

The instructions execution sequence in which function instructions are included also follows the above rules. However, for program execution control instructions, such as jumps (JCS), loops (FOR-NEXT), subroutines (CALL-SUBR-RET), it will depend the specifications of each instruction.

## 6. Programming Information

### 6.9 On-line debug support functions

The following on-line (during RUN) functions are supported in the T1/T1S for effective program debugging.

On-line function	T1	T1S	
		4 k mode	8 k mode
Force function	Yes	Yes	Yes
Sampling trace function	Yes	Yes	Yes
Changing timer /counter preset value	Yes	Yes	Yes
Changing constant operand of function instruction	No	Yes	Yes
Changing device directly	No	Yes	Yes
Program changing in edit mode	No	Yes	No
EEPROM write command	No	Yes	Yes



Refer to section 6.5 for 4 k/8 k mode of the T1S.

#### Force function

Two types of force functions are available, input force and coil force.

The input force is used to disable the external input signals. When an external input device is designated as forced input, the ON/OFF state of the device can be changed manually by using the data setting function of the programming tool, regardless of the corresponding external signal state. The input force designation is available for the external input devices (X).

The coil force is used to disable the coil instruction. When a coil instruction on the program is designated as forced coil, the ON/OFF state of the coil device can be changed manually by using the data setting function of the programming tool, regardless of the coil circuit execution status.

On the programming tool, the forced input and forced coil are expressed as follows.

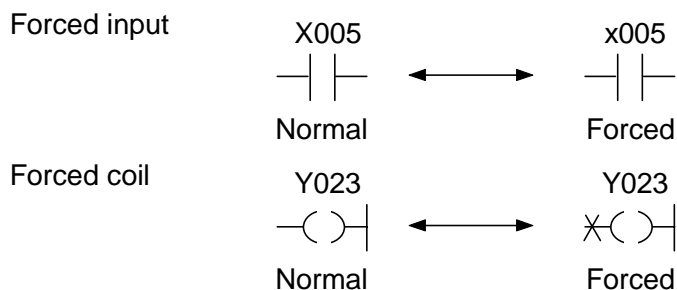

If EEPROM write operation is executed with remaining the force designation, the force designation is also saved into the built-in EEPROM. Because the force function is debugging function, release all force designation before executing the EEPROM write operation. The force batch release command is available when the T1/T1S is in HALT mode.



## 6. Programming Information

### Sampling trace function

The sampling trace function collects the status of specified devices or register at every specified sampling timing. The collected data can be displayed on the programmer (T-PDS) screen in the format of timing chart (for devices) or trend graph (for register). The minimum sampling timing is the T1/T1S's scan cycle.

This function is useful for program debugging and troubleshooting.

	T1	T1S
Sampling target	Devices (up to 8) or Register (only 1)	Devices (up to 8) and Registers (up to 3)
Sampling capacity	256 times for device 128 times for register	256 times

The collected data is stored in the T1/T1S internal buffer.

The buffer works as a ring buffer, and latest collected data can be displayed.

The sampling start/stop condition (arm condition) and the collection timing (trigger condition) can be specified by status changing of devices.

For detailed key operations for arm/trigger conditions setting on the T-PDS, refer to the manual for T-PDS.

T-PDS screen example of device timing chart

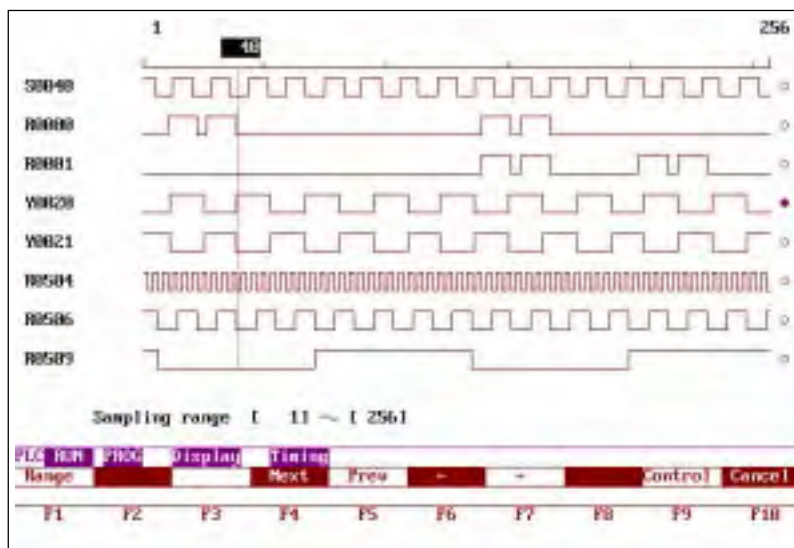

- NOTE**
- (1) On the T-PDS, select '3 registers + 8 devices' as the sampling type.
  - (2) As the arm and trigger conditions, register values cannot be used.
  - (3) The After times setting is not effective for the T1/T1S.

## 6. Programming Information

### Timer/counter preset value (constant data) changing

The preset value (constant data) of timer or counter instruction can be changed in on-line (during RUN) by using the programming tool.

### Function instruction constant operand changing (T1S only)

The constant operand of function instruction can be changed in on-line (during RUN) by using the programming tool.

### Device changing (T1S only)

The device of contact or coil instruction can be changed in on-line (during RUN) by using the programming tool.

### On-line program changing (T1S only)

When the T1S's memory mode is 4 k mode, the program can be changed using normal edit mode. (rung by rung)

In the on-line program changing, it is not allowed to change the number or order of the following instructions.

END, MCS, MCR, JCS, JCR, FOR, NEXT, CALL, SUBR, RET, IRET



The above on-line functions are performed on the RAM memory. Therefore, when program has been changed, execute the EEPROM write operation before turning off power. Otherwise, program stored in the EEPROM will be overwritten.

### On-line EEPROM write (T1S only)

The EEPROM write is possible in on-line (during RUN) as well as in HALT mode.

In the on-line EEPROM write, user data is not written into the EEPROM.

During this operation, the T1S's scan time becomes longer. However, as it has the time limit per scan, the T1S's control operation is not stopped.



In case of the standard T1, the EEPROM write is possible only in the HALT mode.

## 6. Programming Information

### 6.10 Password protection

The T1/T1S has the password function to protect the user program and data from unauthorized operations.

There are four levels of protection. Accordingly, three levels of passwords can be registered to control the protection levels.

These passwords are stored in the built-in EEPROM. Therefore, if you entered, changed or cleared the passwords, the EEPROM write operation is necessary.

The outline of the protection levels are shown below. For details, refer to the manual for the programming tool.

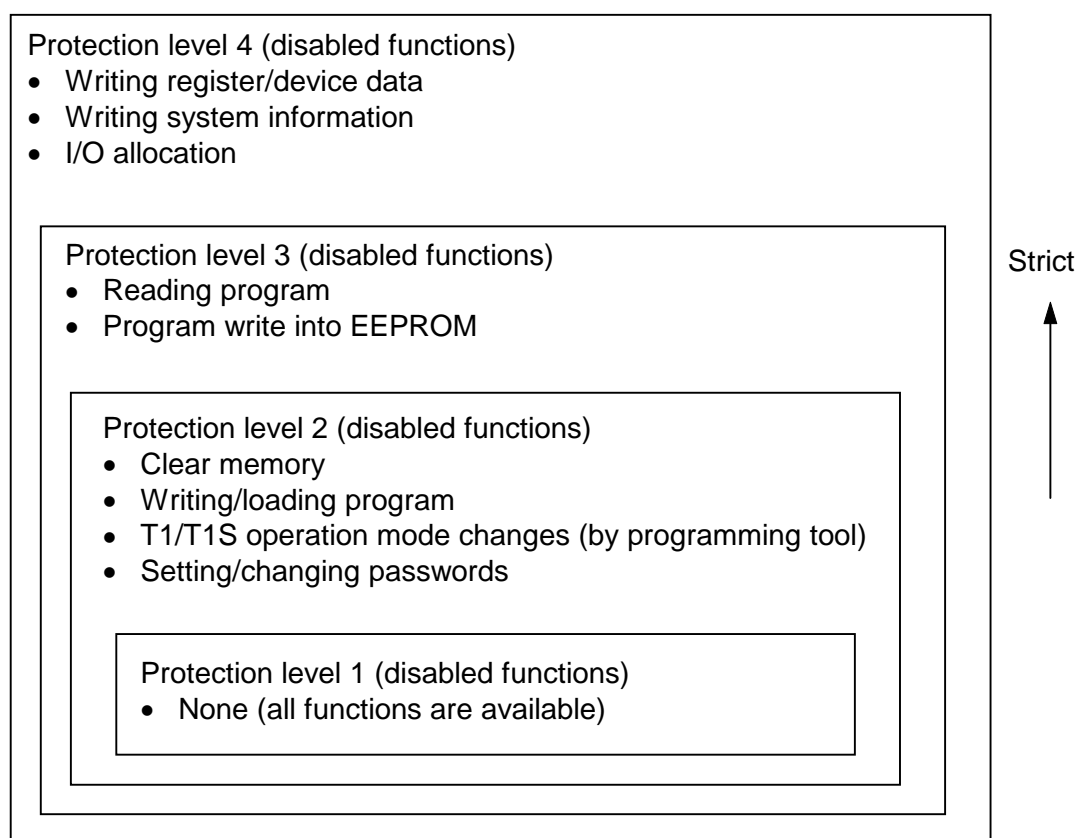

When the level 1, 2 and 3 passwords are registered, the T1/T1S will be started as protection level 4. In this state, for example, entering the level 2 password changes the protection level to 2.



When you use the password function, do not forget the level 1 password. Otherwise, you cannot change/release the registered passwords.



---

# *Section 7*

## *Instructions*

---

- 7.1 List of instructions, 124*
- 7.2 Instruction specifications, 134*

## 7. Instructions

### 7.1 List of instructions

The T1 has 17 types of basic ladder instructions and 76 types of function instructions, the T1S has 21 types of basic ladder instructions and 99 types of function instructions as listed below. The specifications of each instruction will be described in detail later.

The tables listing these instructions are provided as a quick reference. (Note: In the following table, italic character means operand, i.e. register, device or constant value.)

#### Basic ladder instructions

FUN No.	Name	Expression	Function	Steps	Speed (μs)	Available		Page
						T1	T1S	
-	NO contact	A 	NO (normally open) contact of device A.	1	1.4 - 3.3	√	√	135
-	NC contact	A 	NC (normally closed) contact of device A.	1	1.4 - 3.3	√	√	136
-	Transitional contact (rising)	A 	Turns ON output for 1 scan when input changes from OFF to ON.	1	3.0	√	√	137
-	Transitional contact (falling)	A 	Turns ON output for 1 scan when input changes from ON to OFF.	1	3.0	√	√	138
-	Coil	A 	Relay coil of device A.	1	2.3	√	√	139
-	Forced coil	A 	Forced coil of device A. State of device A is retained regardless of the input state.	1	2.3	√	√	140
-	Inverter		Inverts the input state.	1	1.4 - 3.3	√	√	141
-	Invert coil	A 	Stores the inverse state of input into device A.	1	2.3	√	√	142
-	Positive pulse contact	A 	Turns ON output for 1 scan when input is ON and device A changes from OFF to ON.	1			√	143
-	Negative pulse contact	A 	Turns ON output for 1 scan when input is ON and device A changes from ON to OFF.	1			√	144
-	Positive pulse coil	A 	Turns ON device A for 1 scan when input changes from OFF to ON.	1			√	145
-	Negative pulse coil	A 	Turns ON device A for 1 scan when input changes from ON to OFF.	1			√	146
-	ON delay timer	-[ A TON B ]-	Turns ON output when the time specified by A has elapsed after the input came ON. B is a timer register.	2	12.6	√	√	147
-	OFF delay timer	-[ A TOF B ]-	Turns OFF output when the time specified by A has elapsed after the input came OFF. B is a timer register.	2	12.8	√	√	148
-	Single shot timer	-[ A SS B ]-	Turns ON output for the time specified by A when the input comes ON. B is a timer register.	2	13.0	√	√	149

## 7. Instructions

FUN No.	Name	Expression	Function	Steps	Speed (μs)	Available		Page
						T1	T1S	
–	Counter	C $\left[ \begin{array}{c} \text{CNT} \\ \text{A B} \end{array} \right]$ –Q E	Counts the number of cycles the count input (C) comes ON while the enable input (E) is ON, and turns ON output (Q) when the count reaches to the value specified by A. B is a counter register.	2	22.6	√	√	150
–	Master control set	–[ MCS ]–	Turns OFF power rail between MCS and MCR when MCS input is OFF.	1	3.75 (in a pair)	√	√	151
–	Master control reset	–[ MCR ]–		1				
–	Jump control set	–[ JCS ]–	Jumps from JCS to JCR when JCS input is ON.	1	2.75 (in a pair)	√	√	152
–	Jump control reset	–[ JCR ]–		1				
–	End	–[ END ]–	Indicates end of main program or sub-program.	1	1.4	√	√	153

### Data transfer instructions

FUN No.	Name	Expression	Function	Steps	Speed (μs)	Available		Page
						T1	T1S	
018	Data transfer	–[ A MOV B ]–	Transfers data of A to B.	3	4.2	√	√	154
019	Double-word data transfer	–[ A+1·A DMOV B+1·B ]–	Transfers double-word data of A+1·A to B+1·B.	3	7.2	√	√	155
020	Invert transfer	–[ A NOT B ]–	Transfers bit-inverted data of A to B.	3	4.6	√	√	156
022	Data exchange	–[ A XCHG B ]–	Exchanges data of A with B.	3	6.5	√	√	157
024	Table initialize	–[ A TINZ (n) B ]–	Transfers data of A to n registers starting with B.	3			√	158
025	Table transfer	–[ A TMOV (n) B ]–	Transfers data of n registers starting with A to n registers starting with B.	3			√	159
026	Table invert transfer	–[ A TNOT (n) B ]–	Transfers bit-inverted data of n registers starting with A to n registers starting with B.	3			√	160
090	Multiplexer	–[ A MPX (n) B → C ]–	Transfers data from the register specified by B in the table, size n starting with A, to C.	5	70.6	√	√	194
091	Demultiplexer	–[ A DPX (n) B → C ]–	Transfers data from A to the register specified by B in the table, size n starting with C.	5	71.5	√	√	195

## 7. Instructions

### Arithmetic operations

FUN No.	Name	Expression	Function	Steps	Speed (μs)	Available		Page
						T1	T1S	
027	Addition	$-[A + B \rightarrow C]-$	Adds data of $A$ and $B$ , and stores the result in $C$ .	4	6.5	√	√	161
028	Subtraction	$-[A - B \rightarrow C]-$	Subtracts data of $B$ from $A$ , and stores the result in $C$ .	4	6.5	√	√	162
029	Multiplication	$-[A * B \rightarrow C+1.C]-$	Multiplies data of $A$ and $B$ , and stores the result in double-length register $C+1.C$ .	4	8.8	√	√	163
030	Division	$-[A / B \rightarrow C]-$	Divides data of $A$ by $B$ , and stores the quotient in $C$ and the remainder in $C+1$ .	4	9.7	√	√	164
031	Double-word addition	$-[A+1.A D+ B+1.B \rightarrow C+1.C]-$	Adds data of $A+1.A$ and $B+1.B$ , and stores the result in $C+1.C$ .	4	11.6	√	√	165
032	Double-word subtraction	$-[A+1.A D- B+1.B \rightarrow C+1.C]-$	Subtracts data of $B+1.B$ from $A+1.A$ , and stores the result in $C+1.C$ .	4	11.7	√	√	166
035	Addition with carry	$-[A +C B \rightarrow C]-$	Adds data of $A$ , $B$ and the carry, and stores the result in $C$ . The carry flag changes according to the result.	4	9.7	√	√	167
036	Subtraction with carry	$-[A -C B \rightarrow C]-$	Subtracts data of $B$ and the carry from $A$ , and stores the result in $C$ . The carry flag changes according to the result.	4	9.7	√	√	168
039	Unsigned multiplication	$-[A U* B \rightarrow C+1.C]-$	Multiplies data of $A$ and $B$ , and stores the result in double-length register $C+1.C$ . (Unsigned integer operation)	4			√	169
040	Unsigned division	$-[A U/ B \rightarrow C]-$	Divides data of $A$ by $B$ , and stores the quotient in $C$ and the remainder in $C+1$ . (Unsigned integer operation)	4			√	170
041	Unsigned double/single division	$-[A+1.A DIV B \rightarrow C]-$	Divides data of $A+1.A$ by $B$ , and stores the quotient in $C$ and the remainder in $C+1$ . (Unsigned integer operation)	4	15.3	√	√	171
043	Increment	$-[+1 A]-$	Increments data of $A$ by 1.	2	4.6	√	√	172
044	Decrement	$[-1 A]-$	Decrements data of $A$ by 1.	2	4.6	√	√	173



## 7. Instructions

### Logical operations

FUN No.	Name	Expression	Function	Steps	Speed (μs)	Available		Page
						T1	T1S	
048	AND	$\neg[A \text{ AND } B \rightarrow C]$	Finds logical AND of <i>A</i> and <i>B</i> , and stores it in <i>C</i> .	4	5.7	√	√	174
050	OR	$\neg[A \text{ OR } B \rightarrow C]$	Finds logical OR of <i>A</i> and <i>B</i> , and stores it in <i>C</i> .	4	5.7	√	√	175
052	Exclusive OR	$\neg[A \text{ EOR } B \rightarrow C]$	Finds logical exclusive OR of <i>A</i> and <i>B</i> , and stores it in <i>C</i> .	4	5.7	√	√	176
064	Bit test	$\neg[A \text{ TEST } B]$	Turns ON output if logical AND of <i>A</i> and <i>B</i> is not 0.	3	5.0	√	√	181

### Shift operations

FUN No.	Name	Expression	Function	Steps	Speed (μs)	Available		Page
						T1	T1S	
068	1 bit shift right	$\neg[\text{SHR1 } A]$	Shifts data of <i>A</i> 1 bit to the right (LSB direction). The carry flag changes according to the result.	2	6.8	√	√	182
069	1 bit shift left	$\neg[\text{SHL1 } A]$	Shifts data of <i>A</i> 1 bit to the left (MSB direction). The carry flag changes according to the result.	2	6.8	√	√	183
070	<i>n</i> bit shift right	$\neg[A \text{ SHR } n \rightarrow B]$	Shifts data of <i>A</i> <i>n</i> bits to the right (LSB direction) and stores the result in <i>B</i> . The carry flag changes according to the result.	4	10.2	√	√	184
071	<i>n</i> bit shift left	$\neg[A \text{ SHL } n \rightarrow B]$	Shifts data of <i>A</i> <i>n</i> bits to the left (MSB direction) and stores the result in <i>B</i> . The carry flag changes according to the result.	4	10.2	√	√	185
074	Shift register	$\begin{array}{c} D \\ S \\ E \end{array} \left[ \begin{array}{c} \text{SR} \\ (n) \\ A \end{array} \right] \text{---} Q$	When shift input (S) comes ON, shifts the data of specified shift register 1 bit to the left, and stores data input (D) state into <i>A</i> . This operation is enabled while enable input (E) is ON. The carry flag changes according to the result. Shift register: <i>n</i> devices starting with device <i>A</i> .	3	65.9 - 76.2	√	√	186
075	Bi-directional shift register	$\begin{array}{c} D \\ S \\ E \\ L \end{array} \left[ \begin{array}{c} \text{DSR} \\ (n) \\ A \end{array} \right] \text{---} Q$	When shift input (S) comes ON, shifts the data of specified shift register 1 bit to the left or to the right depending on direction input (L). This operation is enabled while enable input (E) is ON. The carry flag changes according to the result. Shift register: <i>n</i> devices starting with device <i>A</i> . Direction: Left when L is ON, right when L is OFF	3	69.0 - 79.3	√	√	188

## 7. Instructions

### Rotate operations

FUN No.	Name	Expression	Function	Steps	Speed (μs)	Available		Page
						T1	T1S	
078	1 bit rotate right	$-\text{[RTR1 A]}-$	Rotates data of A 1 bit to the right (LSB direction). The carry flag changes according to the result.	2	6.8	√	√	190
079	1 bit rotate left	$-\text{[RTL1 A]}-$	Rotates data of A 1 bit to the left (MSB direction). The carry flag changes according to the result.	2	6.8	√	√	191
080	n bit rotate right	$-\text{[A RTR } n \rightarrow B]-$	Rotates data of A n bits to the right (LSB direction) and stores the result in B. The carry flag changes according to the result.	4	10.2	√	√	192
081	n bit rotate left	$-\text{[A RTL } n \rightarrow B]-$	Rotates data of A n bits to the left (MSB direction) and stores the result in B. The carry flag changes according to the result.	4	10.2	√	√	193

### Compare instructions

FUN No.	Name	Expression	Function	Steps	Speed (μs)	Available		Page
						T1	T1S	
096	Greater than	$-\text{[A > B]}-$	Turns ON output if $A > B$ .	3	6.1	√	√	196
097	Greater than or equal	$-\text{[A >= B]}-$	Turns ON output if $A \geq B$ .	3	5.3	√	√	197
098	Equal	$-\text{[A = B]}-$	Turns ON output if $A = B$ .	3	5.0	√	√	198
099	Not equal	$-\text{[A <> B]}-$	Turns ON output if $A \neq B$ .	3	5.0	√	√	199
100	Less than	$-\text{[A < B]}-$	Turns ON output if $A < B$ .	3	6.1	√	√	200
101	Less than or equal	$-\text{[A <= B]}-$	Turns ON output if $A \leq B$ .	3	5.3	√	√	201
102	Double-word greater than	$-\text{[A+1.A D > B+1.B]}-$	Turns ON output if $A+1.A > B+1.B$ .	3	6.1	√	√	202
103	Double-word greater than or equal	$-\text{[A+1.A D >= B+1.B]}-$	Turns ON output if $A+1.A \geq B+1.B$ .	3	5.3	√	√	203
104	Double-word equal	$-\text{[A+1.A D = B+1.B]}-$	Turns ON output if $A+1.A = B+1.B$ .	3	5.0	√	√	204
105	Double-word not equal	$-\text{[A+1.A D <> B+1.B]}-$	Turns ON output if $A+1.A \neq B+1.B$ .	3	5.0	√	√	205
106	Double-word less than	$-\text{[A+1.A D < B+1.B]}-$	Turns ON output if $A+1.A < B+1.B$ .	3	6.1	√	√	206
107	Double-word less than or equal	$-\text{[A+1.A D <= B+1.B]}-$	Turns ON output if $A+1.A \leq B+1.B$ .	3	5.3	√	√	207

## 7. Instructions

FUN No.	Name	Expression	Function	Steps	Speed (μs)	Available		Page
						T1	T1S	
108	Unsigned greater than	$\neg[A \text{ U} > B]$	Turns ON output if $A > B$ . (Unsigned integer compare)	3			√	208
109	Unsigned greater than or equal	$\neg[A \text{ U} \geq B]$	Turns ON output if $A \geq B$ . (Unsigned integer compare)	3			√	209
110	Unsigned equal	$\neg[A \text{ U} = B]$	Turns ON output if $A = B$ . (Unsigned integer compare)	3			√	210
111	Unsigned not equal	$\neg[A \text{ U} <> B]$	Turns ON output if $A \neq B$ . (Unsigned integer compare)	3			√	211
112	Unsigned less than	$\neg[A \text{ U} < B]$	Turns ON output if $A < B$ . (Unsigned integer compare)	3			√	212
113	Unsigned less than or equal	$\neg[A \text{ U} \leq B]$	Turns ON output if $A \leq B$ . (Unsigned integer compare)	3			√	213

### Special data processing

FUN No.	Name	Expression	Function	Steps	Speed (μs)	Available		Page
						T1	T1S	
114	Device/register set	$\neg[\text{SET } A]$	If $A$ is a device: Sets device $A$ to ON. ----- If $A$ is a register: Stores HFFF in register $A$ .	2	4.2	√	√	214
115	Device/register reset	$\neg[\text{RST } A]$	If $A$ is a device: Resets device $A$ to OFF. ----- If $A$ is a register: Stores 0 in register $A$ .	2	4.2	√	√	215
118	Set carry	$\neg[\text{SETC}]$	Sets the carry flag to ON.	1	4.2	√	√	216
119	Reset carry	$\neg[\text{RSTC}]$	Resets the carry flag to OFF.	1	4.2	√	√	217
120	Encode	$\neg[A \text{ ENC } (n) B]$	Finds the uppermost ON bit position in the bit file of size $2^n$ bits starting with register $A$ , and stores it in $B$ .	4	57.0 - 141.4	√	√	218
121	Decode	$\neg[A \text{ DEC } (n) B]$	In the bit file of size $2^n$ bits starting with register $B$ , sets ON the bit position indicated by lower $n$ bits of $A$ , and resets OFF all other bits.	4	69.5 - 99.1	√	√	219
122	Bit count	$\neg[A \text{ BC } B]$	Counts the number of ON bits of $A$ and stores it in $B$ .	3			√	220
147	Flip-flop	$S \begin{array}{l} \text{F/F} \\ \text{R} \end{array} \begin{array}{l} \text{A} \\ \text{A} \end{array} \text{ Q}$	Sets ON device $A$ when set input (S) is ON, and resets OFF device $A$ when reset input (R) is ON. (Reset takes priority)	2	26.7	√	√	233
149	Up-down counter	$U \begin{array}{l} \text{U/D} \\ \text{C} \\ \text{E} \end{array} \begin{array}{l} \text{A} \\ \text{A} \end{array} \text{ Q}$	While enable input (E) is ON, counts up or down the number of cycles the count input (C) comes ON, depending on the up/down select input (U). Up when U is ON, down when U is OFF.	2	30.1	√	√	234

## 7. Instructions

### Program control instructions

FUN No.	Name	Expression	Function	Steps	Speed (μs)	Available		Page	
						T1	T1S		
128	Subroutine call	-[ CALL N. <i>n</i> ]-	Calls the subroutine number <i>n</i> .	2	21.0	√	√	221	
129	Subroutine return	-[ RET ]-	Indicates the end of a subroutine.	1	(in a pair)	√	√	222	
132	FOR	-[ FOR <i>n</i> ]-	When the input of FOR is ON, executes the segment from FOR to NEXT the number of times specified by <i>n</i> .	2	22.0	√	√	223	
133	NEXT	-[ NEXT ]-		1	(in a pair)	√	√	224	
137	Subroutine entry	-[ SUBR ( <i>n</i> ) ]-	Indicates the start of the subroutine number <i>n</i> .	2	included in CALL	√	√	225	
140	Enable interrupt	-[ EI ]-	Enables execution of interrupt program.	1	27.6	√	√	226	
141	Disable interrupt	-[ DI ]-	Disables execution of interrupt program.	1	(in a pair)	√	√	227	
142	Interrupt return	-[ IRET ]-	Indicates the end of an interrupt program.	1	1.4	√	√	228	
143	Watchdog timer reset	-[ WDT <i>n</i> ]-	Extends the scan time over detection time.	2	16.1	√	√	229	
144	Step sequence initialize	-[ STIZ ( <i>n</i> ) A ]-	Resets OFF the <i>n</i> devices stating with A, and sets ON A.	These configure a series of step sequence	3	59.9 - 65.0	√	√	230
145	Step sequence input	-[ STIN A ]-	Turns ON output if input is ON and A is ON.		2	27.0	√	√	231
146	Step sequence output	-[ STOT A ]-	When input is ON, resets OFF the devices of STIN on the same rung, and sets ON A.		2	27.0 - 119.0	√	√	232

### RAS

FUN No.	Name	Expression	Function	Steps	Speed (μs)	Available		Page
						T1	T1S	
154	Set calendar	-[ A CLND ]-	Sets 6 registers data starting with A into clock/calendar.	2			√	235
155	Calendar operation	-[ A CLDS B ]-	Calculates difference between present date & time and past date & time stored in 6 registers starting with A, and stores the result in 6 registers starting with B.	3			√	236

## 7. Instructions

### Functions

FUN No.	Name	Expression	Function	Steps	Speed ( $\mu$ s)	Available		Page
						T1	T1S	
056	Moving average	-[ A MAVE (n) B $\rightarrow$ C ]-	Calculates the average value of latest $n$ scan values of $A$ , and stores the result in $C$ .	5			√	177
061	Digital filter	-[ A DFL B $\rightarrow$ C ]-	Filters the value of $A$ by filter constant specified by $B$ , and stores the result in $C$ .	4			√	178
156	Pre-derivative real PID	-[ A PID3 B $\rightarrow$ C ]-	Performs PID control. (pre-derivative real PID algorithm) Process value (PV): $A$ Set value (SV): $A+1$ PID parameters: $B$ and after Manipulation value (MV): $C$	4	85.0 - 428.0	√	√	237
160	Upper limit	-[ A UL B $\rightarrow$ C ]-	Upper limits the value of $A$ by $B$ , and stores the result in $C$ .	4			√	242
161	Lower limit	-[ A LL B $\rightarrow$ C ]-	Lower limits the value of $A$ by $B$ , and stores the result in $C$ .	4			√	243
162	Maximum value	-[ A MAX (n) B ]-	Finds the maximum value of $n$ registers data starting with $A$ , and stores the value in $C$ and the pointer in $C+1$ .	4			√	244
163	Minimum value	-[ A MIN (n) B ]-	Finds the minimum value of $n$ registers data starting with $A$ , and stores the value in $C$ and the pointer in $C+1$ .	4			√	245
164	Average value	-[ A AVE (n) B ]-	Calculates the average value of $n$ registers data starting with $A$ , and stores the result in $C$ .	4			√	246
165	Function generator	-[ A FG (n) B $\rightarrow$ C ]-	Finds $f(x)$ for given $x=A$ , and stores it in $C$ . The function $f(x)$ is defined by parameters stored in a table $2 \times n$ registers starting with $B$ .	5	77.7 - 142.1	√	√	247

## 7. Instructions

### Conversion instructions

FUN No.	Name	Expression	Function	Steps	Speed ( $\mu$ s)	Available		Page
						T1	T1S	
062	Hex to ASCII conversion	-[ A HTOA (n) B ]-	Converts the hexadecimal data of $n$ words starting with $A$ into ASCII characters, and stores them in $nx2$ registers starting with $B$ .	4			√	179
063	ASCII to Hex conversion	-[ A ATOH (n) B ]-	Converts the ASCII characters stored in $n$ registers starting with $A$ into hexadecimal data, and stores them in $n/2$ registers starting with $B$ .	4			√	180
180	Absolute value	-[ A ABS B ]-	Stores the absolute value of $A$ in $B$ .	3	5.0	√	√	249
182	2's complement	-[ A NEG B ]-	Stores the 2's complement value of $A$ in $B$ .	3	4.6	√	√	250
183	Double-word 2's complement	-[ A+1·A DNEG B+1·B ]-	Stores the 2's complement value of $A+1·A$ in $B+1·B$ .	3	4.6	√	√	251
185	7-segment decode	-[ A 7SEG B ]-	Converts lower 4 bits of $A$ into 7-segment code, and stores it in $B$ .	3	43.9	√	√	252
186	ASCII conversion	-[ A ASC B ]-	Converts the alphanumerics (max. 16 characters) of $A$ into ASCII codes, and stores them in registers starting with $B$ .	3 - 10	29.8 - 49.6	√	√	254
188	Binary conversion	-[ A BIN B ]-	Converts the BCD data in $A$ into binary data, and stores it in $B$ .	3	65.5	√	√	255
190	BCD conversion	-[ A BCD B ]-	Converts the binary data in $A$ into BCD data, and stores it in $B$ .	3	55.6	√	√	256

## 7. Instructions

### Special I/O instructions

FUN No.	Name	Expression	Function	Steps	Speed (μs)	Available		Page
						T1	T1S	
235	Direct I/O	-[ I/O (n) A ]-	Performs the immediate block I/O transfer of $n$ registers starting with $A$ .	3	$20.7 + 21.3 \times n$	√	√	257
236	Expanded data transfer	-[ A XFER B → C ]-	Writes data into the built-in EEPROM, or reads data from the EEPROM. The transfer source and destination are indirectly designated by $A$ and $C$ . The transfer register size is designated by $B$ .	4	54.0 1w read - 7130 16w write	√	√	259
237	Special module data read	-[ A READ B → C ]-	Reads data from the special module indicated by $A$ and stores the data in a table starting with $C$ . The transfer source address and size are designated by $B$ and $B+1$ .	4	$126.0 + 7.9 \times N$ (N: size)	√	√	263
238	Special module data write	-[ A WRITE B → C ]-	Writes data stored in a table starting with $A$ into the special module indicated by $C$ . The transfer destination address and size are designated by $B$ and $B+1$ .	4	$126.0 + 7.9 \times N$ (N: size)	√	√	265



The index modification is available for some instructions. The values in the execution speed column show the execution time without index modification. If index modification is used, approx. 20 μs is added per one indexed operand.

## 7. Instructions

### 7.2 Instruction specifications

The following pages in this section describe the detailed specifications of each instruction. On each page, the following items are explained.

#### **Expression**

Shows the operands required for the instruction as italic characters.

#### **Function**

Explains the functions of the instruction with referring the operands shown on the Expression box.

#### **Execution condition**

Shows the execution condition of the instruction and the instruction output status.

#### **Operand**

Shows available register, device or constant value for each operand. For constant operand, available value range is described. If the constant column is just marked (√), it means normal value range (-32768 to 32767 in 16-bit integer or -2147483648 to 2147483647 in 32-bit integer) is available.

Whether index modification for a register operand is usable or not is also shown for each operand.

#### **Example**

Explains the operation of the instruction by using a typical example.

#### **Note**

Explains supplementary information, limitations, etc. for the instruction.



## 7. Instructions

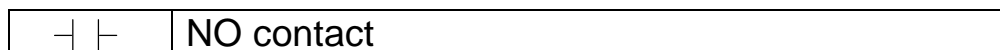

### Expression

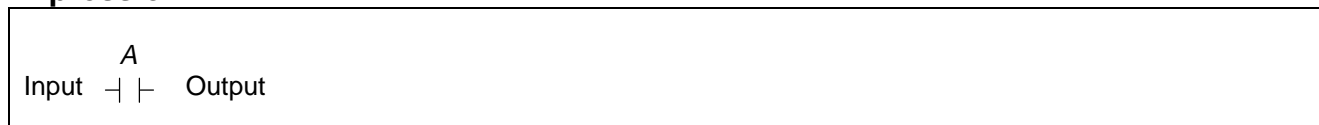

### Function

NO (normally open) contact of device A.

When the input is ON and the device A is ON, the output is turned ON.

### Execution condition

Input	Operation	Output
OFF	Regardless of the state of device A	OFF
ON	When device A is OFF	OFF
	When device A is ON	ON

### Operand

	Name	Device						Register							Constant	Index			
		X	Y	R	S	T	C	XW	YW	RW	SW	T	C	D			I	J	K
A	Device	√	√	√	√	√	√												

### Example

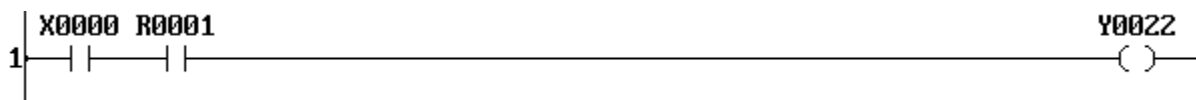

Coil Y022 comes ON when the devices X000 and R001 are both ON.

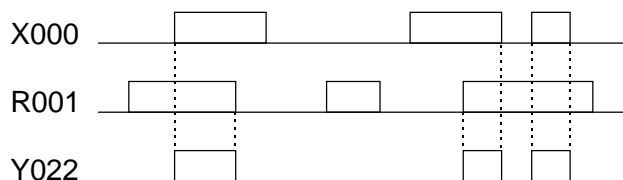

## 7. Instructions

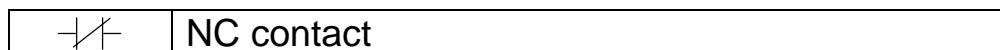

### Expression



### Function

NC (normally closed) contact of device A.

When the input is ON and the device A is OFF, the output is turned ON.

### Execution condition

Input	Operation	Output
OFF	Regardless of the state of device A	OFF
ON	When device A is OFF	ON
	When device A is ON	OFF

### Operand

	Name	Device						Register							Constant	Index		
		X	Y	R	S	T	C	XW	YW	RW	SW	T	C	D			I	J
A	Device	√	√	√	√	√	√											

### Example

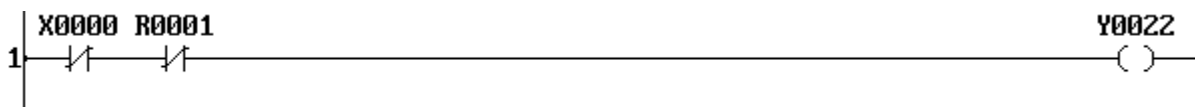

Coil Y022 comes ON when the devices X000 and R001 are both OFF.

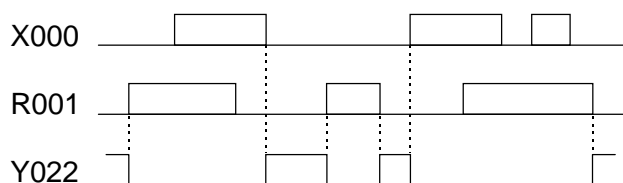

## 7. Instructions



Transitional contact (Rising edge)

### Expression

Input Output

### Function

When the input at last scan is OFF and the input at this scan is ON, the output is turned ON. This instruction is used to detect the input changing from OFF to ON.

### Execution condition

Input	Operation	Output
OFF	Regardless of the input state at last scan	OFF
ON	When the input state at last scan is OFF	ON
	When the input state at last scan is ON	OFF

### Operand

No operand is required.

### Example

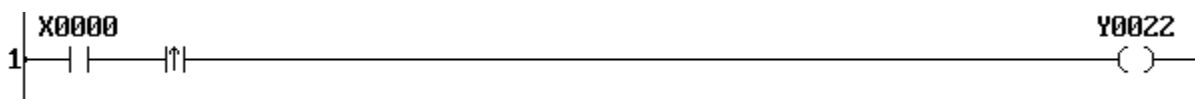

Coil Y022 comes ON for only 1 scan when the device X000 comes ON.

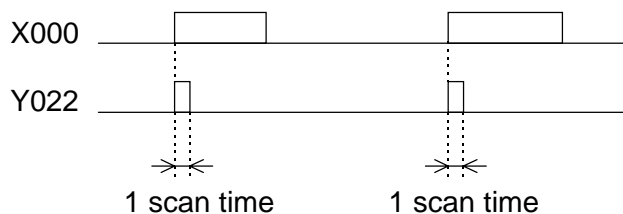

### Note

- In case of T1, the maximum usable number in a program is 512. ( and total)
- In case of T1S, the maximum usable number in a program is 2048. ( total)

## 7. Instructions



Transitional contact (Falling edge)

### Expression

Input  Output

### Function

When the input at last scan is ON and the input at this scan is OFF, the output is turned ON. This instruction is used to detect the input changing from ON to OFF.

### Execution condition

Input	Operation	Output
OFF	When the input state at last scan is OFF	OFF
	When the input state at last scan is ON	ON
ON	Regardless of the input state at last scan	OFF

### Operand

No operand is required.







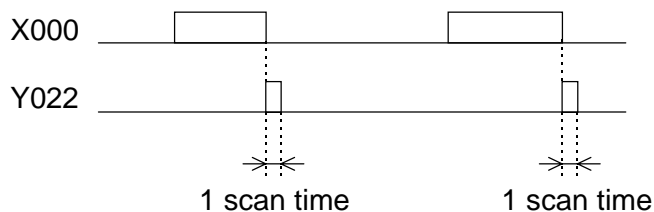

### Example



Coil Y022 comes ON for only 1 scan when the device X000 comes OFF.



### Note

- In case of T1, the maximum usable number in a program is 512. ( and  total)
- In case of T1S, the maximum usable number in a program is 2048. (, , , , ,  total)

## 7. Instructions

-( )H | Coil

### Expression

A  
Input -( )H

### Function

Relay coil of device A.

When the input is ON, the device A is set to ON.

### Execution condition

Input	Operation	Output
OFF	Sets device A to OFF	-
ON	Sets device A to ON	-

### Operand

	Name	Device						Register								Constant	Index		
		X	Y	R	S	T	C	XW	YW	RW	SW	T	C	D	I			J	K
A	Device		√	√	√														

### Example

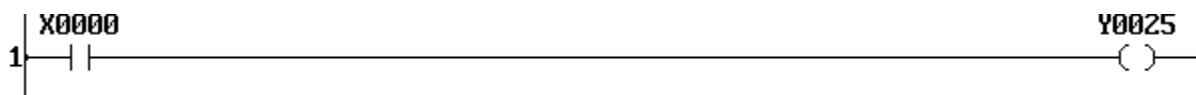

Coil Y025 comes ON when the devices X000 is ON.



## 7. Instructions

※( ) Forced coil

### Expression

A  
Input ※( )

### Function

Regardless of the input state the state of device A is retained.

### Execution condition

Input	Operation	Output
OFF	No operation	–
ON	No operation	–

### Operand

	Name	Device						Register							Constant	Index		
		X	Y	R	S	T	C	XW	YW	RW	SW	T	C	D			I	J
A	Device		√	√	√													

### Example

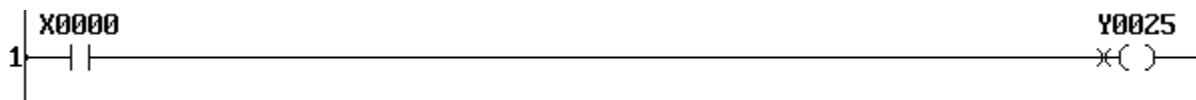

Device Y025 retains the preceding state regardless of the device X000 state.

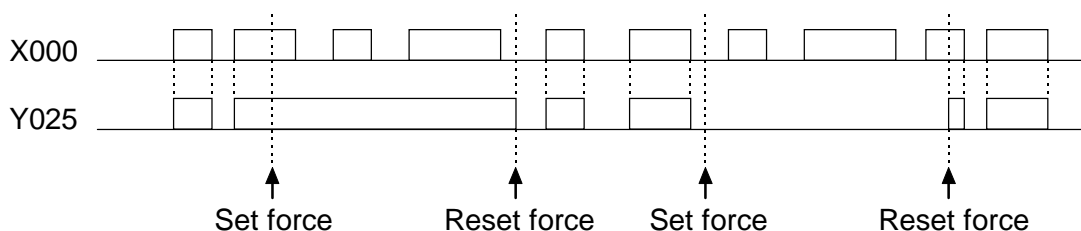

### Note

- The forced coil is a debugging function. The state of a forced coil device can be set ON or OFF by the programming tool.

## 7. Instructions

	Inverter
---	----------

### Expression

Input  Output
--

### Function

When the input is OFF, the output is turned ON, and when the input is ON, the output is turned OFF. This instruction inverts the link state.

### Execution condition

Input	Operation	Output
OFF	Inverts the input state	ON
ON	Inverts the input state	OFF

### Operand

No operand is required.

### Example



Y022 comes ON when X000 is OFF, and Y022 comes OFF when X000 is ON.

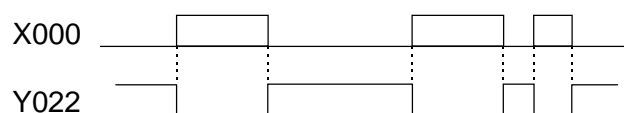

## 7. Instructions

-(I)-| Invert coil

### Expression

A  
Input -(I)-|

### Function

When the input is OFF, the device A is set to ON, and when the input is ON, the device A is set to OFF. This instruction inverts the input state and store it in the device A.

### Execution condition

Input	Operation	Output
OFF	Sets device A to ON	-
ON	Sets device A to OFF	-

### Operand

	Name	Device						Register							Constant	Index		
		X	Y	R	S	T	C	XW	YW	RW	SW	T	C	D			I	J
A	Device		√	√	√													

### Example

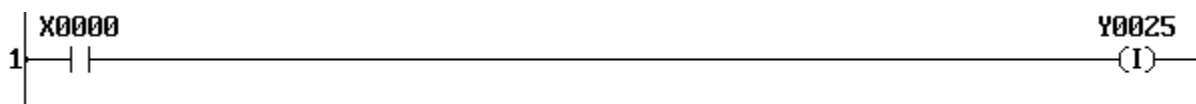

Y025 comes ON when X000 is OFF, and Y025 comes OFF when X000 is ON.

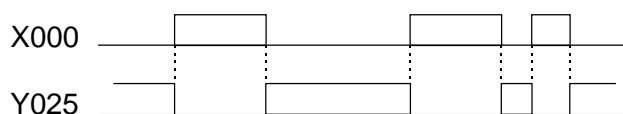



## 7. Instructions



Positive pulse contact

T1S only

### Expression

A

Input Output

### Function

When the input is ON and the device A is changed from OFF to ON (OFF at last scan and ON at this scan), the output is turned ON.

This instruction is used to detect the device changing from OFF to ON.

### Execution condition

Input	Operation	Output	
OFF	Regardless of the state of device A	OFF	
ON	State of device A is OFF	OFF	
	State of device A is ON	A is OFF at last scan	ON
		A is ON at last scan	OFF

### Operand

	Name	Device						Register							Constant	Index		
		X	Y	R	S	T	C	XW	YW	RW	SW	T	C	D			I	J
A	Device	√	√	√	√	√	√											

### Example



R100 comes ON for only 1 scan when X000 is ON and X003 changes to ON.

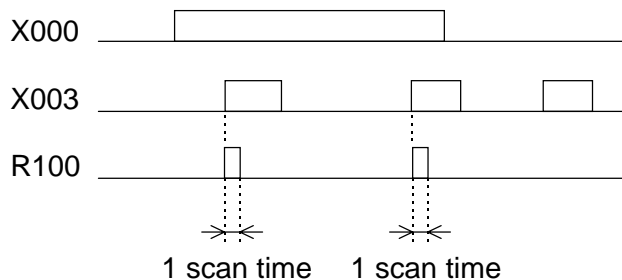

### Note

- The maximum usable number in a program is 2048.  
( total)

## 7. Instructions



Negative pulse contact

T1S only

### Expression

Input  $\overline{A}$  Output

### Function

When the input is ON and the device A is changed from ON to OFF (ON at last scan and OFF at this scan), the output is turned ON.

This instruction is used to detect the device changing from ON to OFF.

### Execution condition

Input	Operation		Output
OFF	Regardless of the state of device A		OFF
ON	State of device A is OFF	A is OFF at last scan	OFF
		A is ON at last scan	ON
	State of device A is ON		OFF

### Operand

	Name	Device						Register							Constant	Index		
		X	Y	R	S	T	C	XW	YW	RW	SW	T	C	D			I	J
A	Device	√	√	√	√	√	√											

### Example

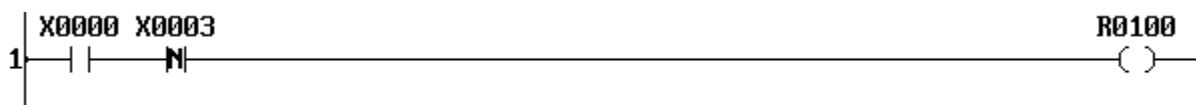

R100 comes ON for only 1 scan when X000 is ON and X003 changes to OFF.



### Note

- The maximum usable number in a program is 2048.  
( $\overline{\uparrow}$   $\overline{\downarrow}$   $\overline{P}$   $\overline{N}$   $\overline{(P)}$   $\overline{(N)}$  total)

## 7. Instructions

-( P )-	Positive pulse coil
---------	---------------------

T1S only

### Expression

<div style="text-align: center;">A</div> Input -( P )-
--

### Function

When the input is changed from OFF to ON, the device A is set to ON for 1 scan time. This instruction is used to detect the input changing from OFF to ON.

### Execution condition

Input	Operation	Output
OFF	Sets device A to OFF	-
ON	When the input at last scan is OFF, sets A to ON	-
	When the input at last scan is ON, sets A to OFF	-

### Operand

	Name	Device						Register							Constant	Index		
		X	Y	R	S	T	C	XW	YW	RW	SW	T	C	D			I	J
A	Device		√	√	√													

### Example



R101 comes ON for only 1 scan when X000 is changed from OFF to ON.

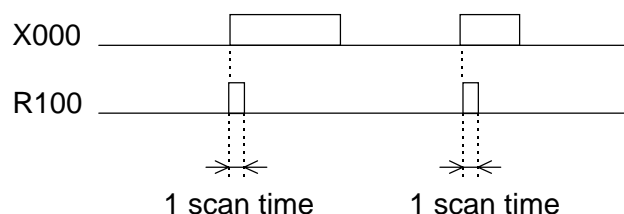

### Note

- The maximum usable number in a program is 2048.  
 (-(↑)- (↓)- (P)- (N)- -(P)- -(N)- total)

## 7. Instructions

$\neg(N)$  Negative pulse coil

T1S only

### Expression

Input  $\neg(N)$  A

### Function

When the input is changed from ON to OFF, the device A is set to ON for 1 scan time. This instruction is used to detect the input changing from ON to OFF.

### Execution condition

Input	Operation	Output
OFF	When the input at last scan is OFF, sets A to OFF	–
	When the input at last scan is ON, sets A to ON	–
ON	Sets device A to OFF	–

### Operand

	Name	Device						Register							Constant	Index		
		X	Y	R	S	T	C	XW	YW	RW	SW	T	C	D			I	J
A	Device		√	√	√													

### Example

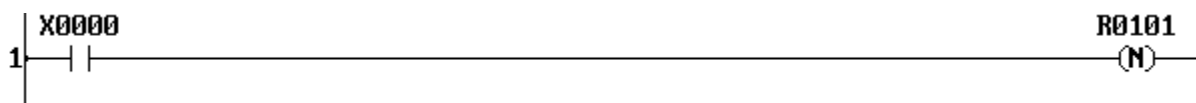

R101 comes ON for only 1 scan when X000 is changed from ON to OFF.

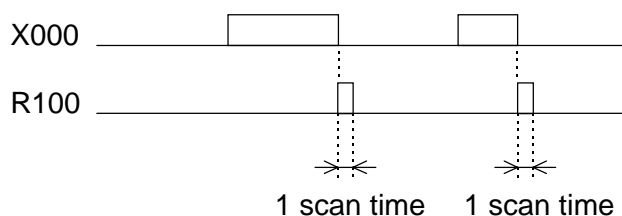

### Note

- The maximum usable number in a program is 2048.  
( $\neg$ ↑  $\neg$ ↓  $\neg$ P  $\neg$ N  $\neg$ (P)  $\neg$ (N) total)

## 7. Instructions

TON	ON delay timer
-----	----------------

### Expression

Input —[ A TON B ]— Output
----------------------------

### Function

When the input is changed from OFF to ON, timer updating for the timer register *B* is started. The elapsed time is stored in *B*. When the specified time by *A* has elapsed after the input came ON, the output and the timer device corresponding to *B* are turned ON. (Timer updating is stopped)

When the input is changed from ON to OFF, *B* is cleared to 0, and the output and the timer device are turned OFF.

The available data range for operand *A* is 0 to 32767.

### Execution condition

Input	Operation	Output
OFF	No operation (timer is not updating)	OFF
ON	Elapsed time < preset time (timer is updating)	OFF
	Elapsed time ≥ preset time (timer is not updating)	ON

### Operand

	Name	Device						Register								Constant	Index		
		X	Y	R	S	T	C	XW	YW	RW	SW	T	C	D	I			J	K
<i>A</i>	Preset time							√	√	√	√	√	√	√	√	√	√	0 - 32767	
<i>B</i>	Elapsed time											√							

### Example

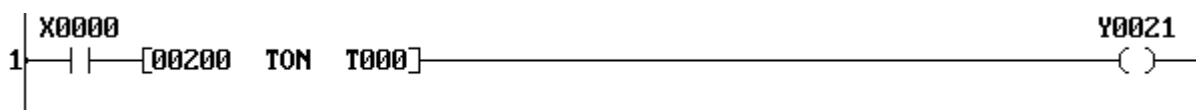

Y021 (and the timer device T.000) is turned ON 2 seconds after X000 came ON.

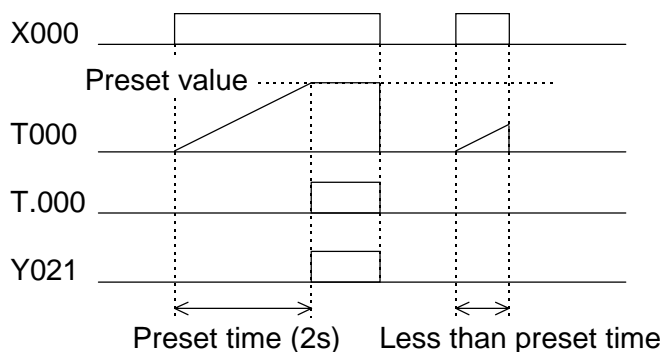

### Note

- Time is set in 10 ms units for;  
T1: T000 to T031 (0 to 327.67 s)  
T1S: T000 to T063 (0 to 327.67 s)
- Time is set in 100 ms units for;  
T1: T032 to T063 (0 to 3276.7 s)  
T1S: T064 to T255 (0 to 3276.7 s)
- Multiple timer instructions (TON, TOF or SS) with the same timer register are not allowed.

## 7. Instructions

TOF    OFF delay timer

### Expression

Input —[ A TOF B ]— Output

### Function

When the input is changed from OFF to ON, the output and the timer device corresponding to the timer register *B* are set to ON. When the input is changed from ON to OFF, timer updating for *B* is started. The elapsed time is stored in *B*. When the specified time by *A* has elapsed after the input came OFF, the output and the timer device are turned OFF. (Timer updating is stopped)  
The available data range for operand *A* is 0 to 32767.

### Execution condition

Input	Operation	Output
OFF	Elapsed time < preset time (timer is updating)	ON
	Elapsed time ≥ preset time (timer is not updating)	OFF
ON	No operation (timer is not updating)	ON

### Operand

	Name	Device						Register								Constant	Index		
		X	Y	R	S	T	C	XW	YW	RW	SW	T	C	D	I			J	K
A	Preset time							√	√	√	√	√	√	√	√	√	√	0 - 32767	
B	Elapsed time												√						

### Example

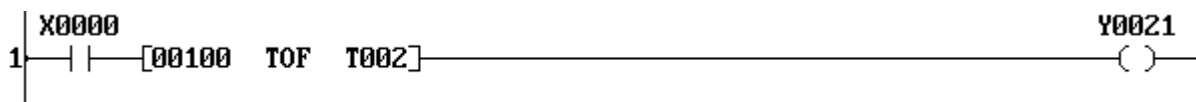

Y021 (and the timer device T.002) is turned OFF 1 second after X000 came OFF.

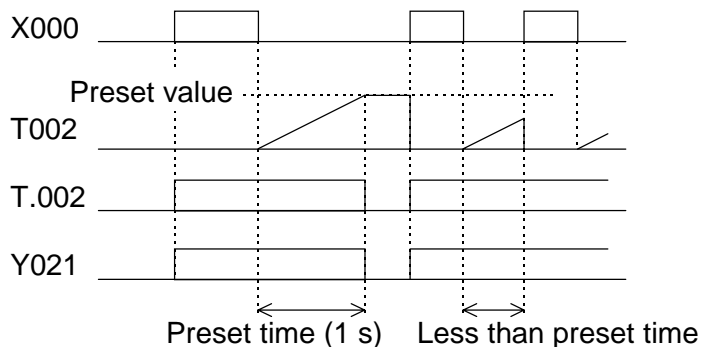

### Note

- Time is set in 10 ms units for;  
T1: T000 to T031 (0 to 327.67 s)  
T1S: T000 to T063 (0 to 327.67 s)
- Time is set in 100 ms units for;  
T1: T032 to T063 (0 to 3276.7 s)  
T1S: T064 to T255 (0 to 3276.7 s)
- Multiple timer instructions (TON, TOF or SS) with the same timer register are not allowed.

## 7. Instructions

SS	Single shot timer
----	-------------------

### Expression

Input —[ A SS B ]— Output

### Function

When the input is changed from OFF to ON, the output and the timer device corresponding to the timer register *B* are set to ON, and timer updating for *B* is started. The elapsed time is stored in *B*. When the specified time by *A* has elapsed after the input came ON, the output and the timer device are turned OFF. (Timer updating is stopped)

The available data range for operand *A* is 0 to 32767.

### Execution condition

Input	Operation	Output
OFF	Elapsed time < preset time (timer is updating)	ON
	Elapsed time ≥ preset time (timer is not updating)	OFF
ON	Elapsed time < preset time (timer is updating)	ON
	Elapsed time ≥ preset time (timer is not updating)	OFF

### Operand

	Name	Device							Register							Constant	Index	
		X	Y	R	S	T	C	XW	YW	RW	SW	T	C	D	I			J
<i>A</i>	Preset time							√	√	√	√	√	√	√	√	√	0 - 32767	
<i>B</i>	Elapsed time											√						

### Example

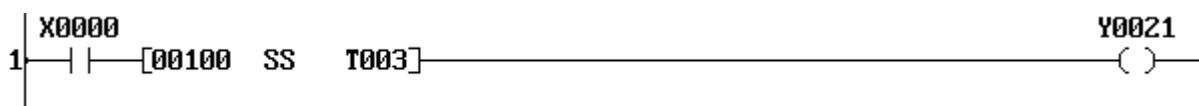

Y021 (and the timer device T.003) is turned OFF 1 second after X000 came ON.

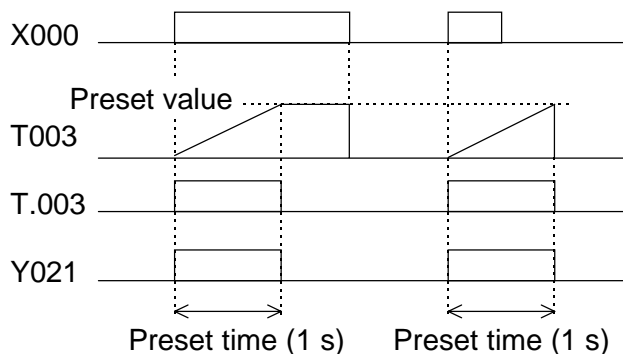

### Note

- Time is set in 10 ms units for;  
T1: T000 to T031 (0 to 327.67 s)  
T1S: T000 to T063 (0 to 327.67 s)
- Time is set in 100 ms units for;  
T1: T032 to T063 (0 to 3276.7 s)  
T1S: T064 to T255 (0 to 3276.7 s)
- Multiple timer instructions (TON, TOF or SS) with the same timer register are not allowed.

## 7. Instructions

CNT	Counter
-----	---------

### Expression

Count input	[C CNT Q]	Output
Enable input	[E A B]	

### Function

While the enable input is ON, this instruction counts the number of the count input changes from OFF to ON. The count value is stored in the counter register *B*. When the count value reaches the set value *A*, the output and the counter device corresponding to *B* are turned ON. When the enable input comes OFF, *B* is cleared to 0 and the output and the counter device are turned OFF. The available data range for operand *A* is 0 to 65535.

### Execution condition

Enable input	Operation	Output
OFF	No operation ( <i>B</i> is cleared to 0)	OFF
ON	Count value ( <i>B</i> ) < set value ( <i>A</i> )	OFF
	Count value ( <i>B</i> ) ≥ set value ( <i>A</i> )	ON

### Operand

	Name	Device						Register								Constant	Index		
		X	Y	R	S	T	C	XW	YW	RW	SW	T	C	D	I			J	K
<i>A</i>	Set value							√	√	√	√	√	√	√	√	√	√	0 - 65535	
<i>B</i>	Count value												√						

### Example

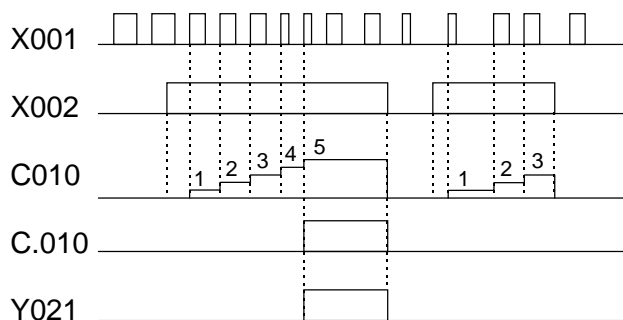

### Note

- No transitional contact is required for the count input. The count input rising edge is detected by this instruction.
- For the count input, direct linking to a connecting point is not allowed. In this case, insert a dummy contact (always ON = S04F, etc.) just before the input. Refer to Note of Shift register FUN 074.
- Multiple counter instructions (CNT) with the same counter register are not allowed.



## 7. Instructions

MCS MCR	Master control set / reset
------------	----------------------------

### Expression

Input	$\neg [MCS]$ $[MCR]$
-------	-------------------------

### Function

When the MCS input is ON, ordinary operation is performed. When the MCS input is OFF, the state of left power rail between MCS and MCR is turned OFF.

### Execution condition

MCS input	Operation	Output
OFF	Sets OFF the left power rail until MCR	-
ON	Ordinary operation	-

### Operand

No operand is required.

### Example

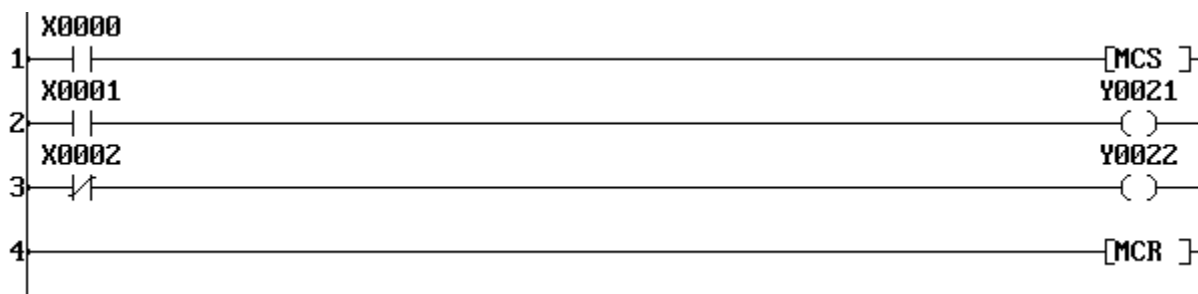

When X000 is OFF, Y021 and Y022 are turned OFF regardless of the states of X001 and X002.

Equivalent circuit

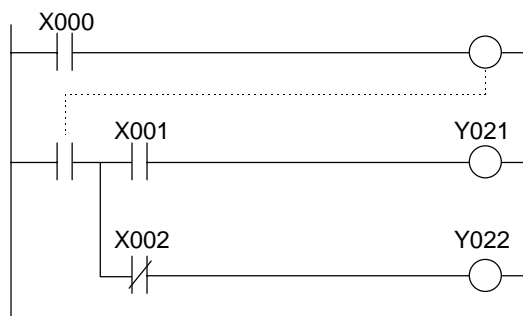

### Note

- MCS and MCR must be used as a pair.
- Nesting is not allowed.

## 7. Instructions

JCS JCR	Jump control set / reset
------------	--------------------------

### Expression

Input     - [ JCS ]  
          |-----|  
          |-----|  
          |-----| [ JCR ]

### Function

When the JCS input is ON, instructions between JCS and JCR are skipped (not executed). When the JCS input is OFF, ordinary operation is performed.

### Execution condition

JCS input	Operation	Output
OFF	Ordinary operation	-
ON	Skips until JCR	-

### Operand

No operand is required.

### Example

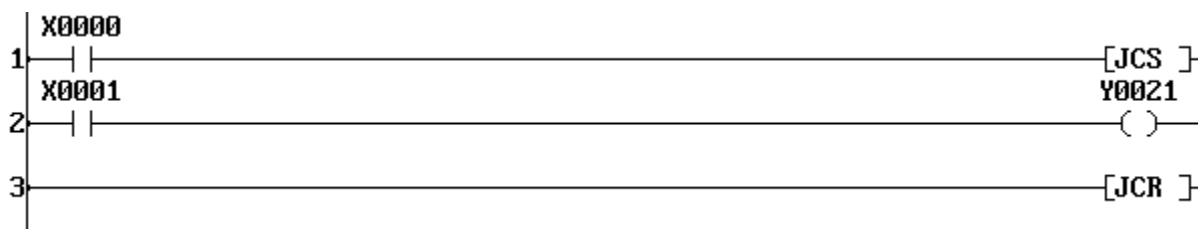

When X000 is ON, the rung 2 circuit is skipped, therefore Y021 is not changed its state regardless of the X001 state. When X000 is OFF, Y021 is controlled by the X001 state.

### Note

- JCS and JCR must be used as a pair.
- Nesting is not allowed.

## 7. Instructions

END	End
-----	-----

### Expression

[ END ]
---------

### Function

Indicates the end of main program or sub-program. Instructions after the END instruction are not executed. At least one END instruction is necessary in a program.

### Execution condition

Input	Operation	Output
–	–	–
–	–	–

### Operand

No operand is required.

### Example

135	[ END ]	
-----	---------	--

### Note

- For debugging purpose, 2 or more END instructions can be written in a program.
- Instructions after END instruction are not executed. Those steps are, however, counted as used steps.

## 7. Instructions

FUN 018	MOV	Data transfer
---------	-----	---------------

### Expression

Input  $\neg$ [ A MOV B ] $\neg$  Output

### Function

When the input is ON, the data of A is stored in B.

### Execution condition

Input	Operation	Output
OFF	No execution	OFF
ON	Execution	ON

### Operand

	Name	Device						Register								Constant	Index				
		X	Y	R	S	T	C	XW	YW	RW	SW	T	C	D	I			J	K		
A	Source							√	√	√	√	√	√	√	√	√	√	√	√	√	√
B	Destination								√	√	√	√	√	√	√	√	√	√	√	√	√

### Example 1 (constant to register)

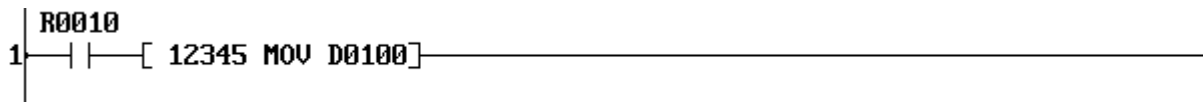

When R010 is ON, a constant data (12345) is stored in D0100 and the output is turned ON.

### Example 2 (register to register)



When X005 is ON, the data of SW30 is stored in RW45 and the output is turned ON. If SW30 is 500, the data 500 is stored in RW45.

### Example 3 (index modification)

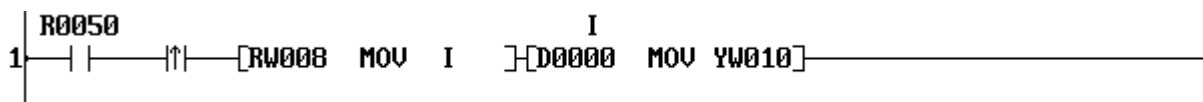

When R050 is changed from OFF to ON, the data of RW08 is stored in the index register I and the data of D(0000+I) is stored in YW10. If RW08 is 300, the data of D0300 is stored in YW10.

## 7. Instructions

FUN 019	DMOV	Double-word data transfer
---------	------	---------------------------

### Expression

Input  $-\lceil A+1\cdot A \text{ MOV } B+1\cdot B \rceil$ – Output

### Function

When the input is ON, the double-word (32-bit) data of  $A+1\cdot A$  is stored in double-word register  $B+1\cdot B$ . The data range is -2147483648 to 2147483647.

### Execution condition

Input	Operation	Output
OFF	No execution	OFF
ON	Execution	ON

### Operand

	Name	Device						Register									Constant	Index		
		X	Y	R	S	T	C	XW	YW	RW	SW	T	C	D	I	J			K	
<i>A</i>	Source							√	√	√	√	√	√	√	√	√	√	√	√	√
<i>B</i>	Destination								√	√	√	√	√	√	√	√	√	√	√	√

### Example

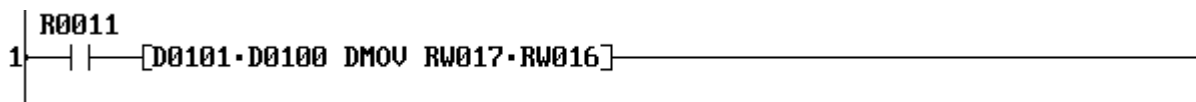

When R011 is ON, a double-word data of D0101·D0100 is stored in RW17·RW16 and the output is turned ON. If D0101·D0100 is 1234567, the data 1234567 is stored in RW17·RW16.

## 7. Instructions

FUN 020	NOT	Invert transfer
---------	-----	-----------------

### Expression

Input  $\neg[A \text{ NOT } B]$ – Output

### Function

When the input is ON, the bit-inverted data of *A* is stored in *B*.

### Execution condition

Input	Operation	Output
OFF	No execution	OFF
ON	Execution	ON

### Operand

	Name	Device						Register								Constant	Index										
		X	Y	R	S	T	C	XW	YW	RW	SW	T	C	D	I			J	K								
<i>A</i>	Source							√	√	√	√	√	√	√	√	√	√	√	√	√	√	√	√	√	√	√	√
<i>B</i>	Destination								√	√	√	√	√	√	√	√	√	√	√	√	√	√	√	√	√	√	√

### Example

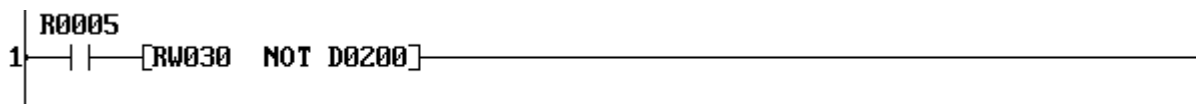

When R010 is ON, the bit-inverted data of RW30 is stored in D0200 and the output is turned ON. If RW30 is H4321, the bit-inverted data (HBCDE) is stored in D0200.

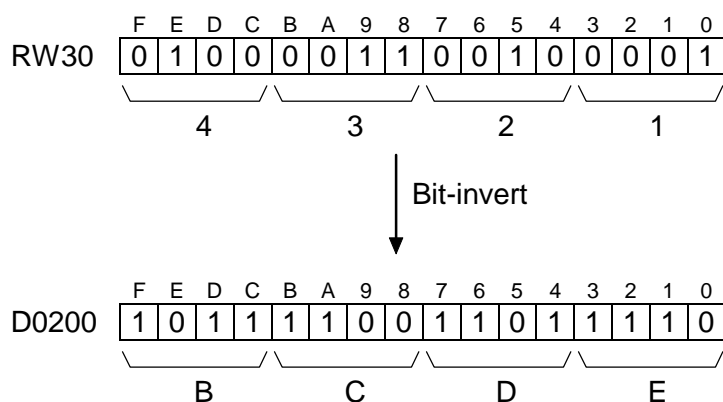

## 7. Instructions

FUN 022	XCHG	Data exchange
---------	------	---------------

### Expression

Input  $\neg[A \text{ XCHG } B]$ – Output

### Function

When the input is ON, the data of *A* and the data of *B* is exchanged.

### Execution condition

Input	Operation	Output
OFF	No execution	OFF
ON	Execution	ON

### Operand

	Name	Device						Register								Constant	Index		
		X	Y	R	S	T	C	XW	YW	RW	SW	T	C	D	I			J	K
<i>A</i>	Operation data								√	√	√	√	√	√	√	√	√		√
<i>B</i>	Operation data								√	√	√	√	√	√	√	√	√		√

### Example

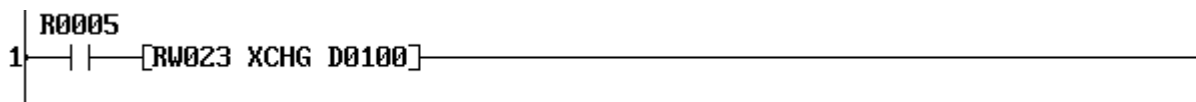

When R005 is ON, the data of RW23 and D0100 is exchanged. If the original data of RW23 is 23456 and that of D0100 is 291, the operation result is as follows.

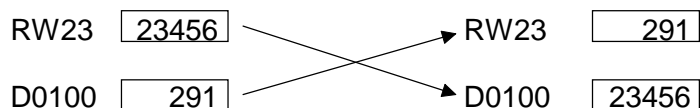

Before operation

After operation





## 7. Instructions

FUN 025	TMOV	Table transfer
---------	------	----------------

T1S only

### Expression

Input $\text{--[ } A \text{ TMOV } (n) \text{ B ]--}$ Output
--

### Function

When the input is ON, the data of  $n$  registers starting with  $A$  are transferred to  $n$  registers starting with  $B$  in a block. The allowable range of the table size  $n$  is 1 to 1024 words.

### Execution condition

Input	Operation	Output
OFF	No execution	OFF
ON	Execution	ON

### Operand

	Name	Device						Register								Constant	Index			
		X	Y	R	S	T	C	XW	YW	RW	SW	T	C	D	I			J	K	
$A$	Start of source							√	√	√	√	√	√	√						
$n$	Table size																		1 - 1024	
$B$	Start of destination								√	√	√	√	√	√						

### Example

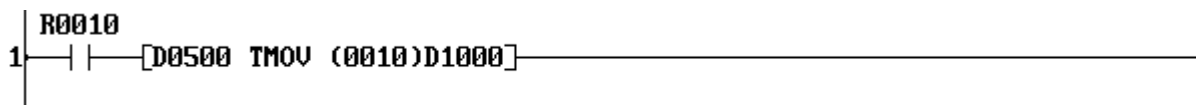

When R010 is ON, the data of D0500 to D0509 (10 registers) are block transferred to D1000 to D1009, and the output is turned ON.

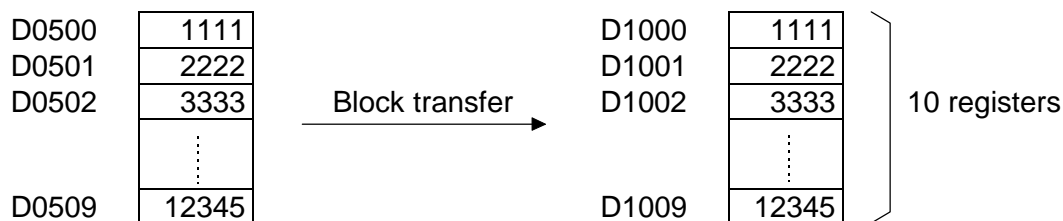

### Note

- The source and destination tables can be overlapped.

## 7. Instructions

FUN 026	TNOT	Table invert transfer
---------	------	-----------------------

T1S only

### Expression

Input  $\neg[A \text{ TNOT } (n) B]$  Output

### Function

When the input is ON, the data of  $n$  registers starting with  $A$  are bit-inverted and transferred to  $n$  registers starting with  $B$  in a block. The allowable range of the table size  $n$  is 1 to 1024 words.

### Execution condition

Input	Operation	Output
OFF	No execution	OFF
ON	Execution	ON

### Operand

	Name	Device						Register								Constant	Index			
		X	Y	R	S	T	C	XW	YW	RW	SW	T	C	D	I			J	K	
$A$	Start of source							√	√	√	√	√	√	√						
$n$	Table size																		1 - 1024	
$B$	Start of destination								√	√	√	√	√	√						

### Example

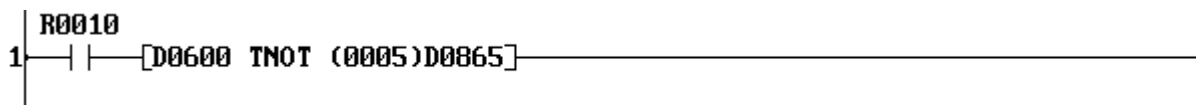

When R010 is ON, the data of D0600 to D0604 (5 registers) are bit-inverted and transferred to D0865 to D0869, and the output is turned ON.

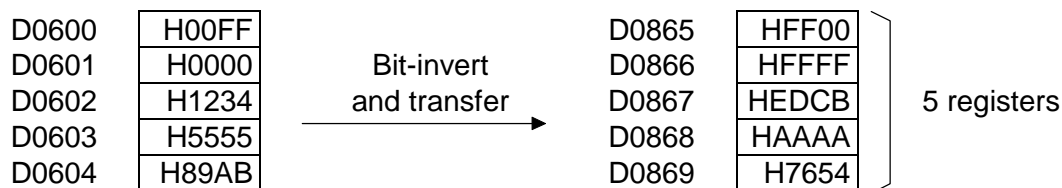

### Note

- The source and destination tables can be overlapped.

## 7. Instructions

FUN 027	+	Addition
---------	---	----------

### Expression

Input  $-[A + B \rightarrow C]$ - Output

### Function

When the input is ON, the data of *A* and the data of *B* are added, and the result is stored in *C*. If the result is greater than 32767, the upper limit value 32767 is stored in *C*, and the output is turned ON. If the result is smaller than -32768, the lower limit value -32768 is stored in *C*, and the output is turned ON.

### Execution condition

Input	Operation	Output
OFF	No execution	OFF
ON	Execution (normal)	OFF
	Execution (overflow or underflow occurred)	ON

### Operand

	Name	Device						Register								Constant	Index		
		X	Y	R	S	T	C.	XW	YW	RW	SW	T	C	D	I			J	K
<i>A</i>	Augend							√	√	√	√	√	√	√	√	√	√	√	√
<i>B</i>	Addend							√	√	√	√	√	√	√	√	√	√	√	√
<i>C</i>	Sum								√	√	√	√	√	√	√	√		√	

### Example

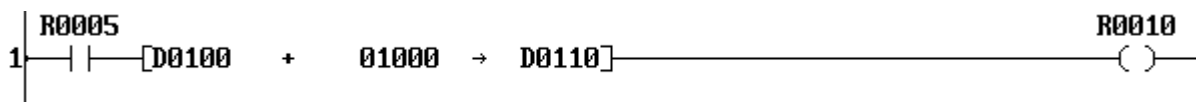

When R005 is ON, the data of D0100 and the constant data 1000 is added, and the result is stored in D0110.

If the data of D0100 is 12345, the result 13345 is stored in D0110, and R010 is turned OFF.

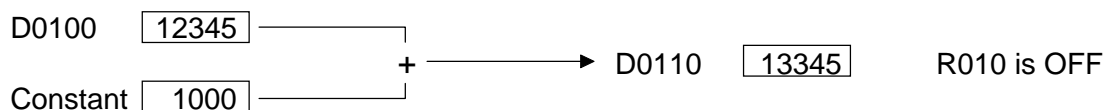

If the data of D0100 is 32700, the result exceeds the limit value, therefore 32767 is stored in D0110, and R010 is turned ON.

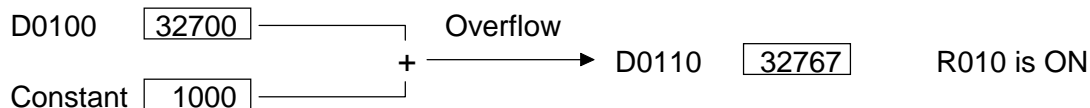

## 7. Instructions

FUN 028	–	Subtraction
---------	---	-------------

### Expression

Input  $-[A - B \rightarrow C]$ – Output

### Function

When the input is ON, the data of  $B$  is subtracted from the data of  $A$ , and the result is stored in  $C$ . If the result is greater than 32767, the upper limit value 32767 is stored in  $C$ , and the output is turned ON. If the result is smaller than -32768, the lower limit value -32768 is stored in  $C$ , and the output is turned ON.

### Execution condition

Input	Operation	Output
OFF	No execution	OFF
ON	Execution (normal)	OFF
	Execution (overflow or underflow occurred)	ON

### Operand

	Name	Device						Register									Constant	Index									
		X	Y	R	S	T	C	XW	YW	RW	SW	T	C	D	I	J			K								
$A$	Minuend							√	√	√	√	√	√	√	√	√	√	√	√	√	√	√	√	√	√	√	√
$B$	Subtrahend							√	√	√	√	√	√	√	√	√	√	√	√	√	√	√	√	√	√	√	√
$C$	Difference								√	√	√	√	√	√	√	√	√	√	√	√	√	√	√	√	√	√	√

### Example

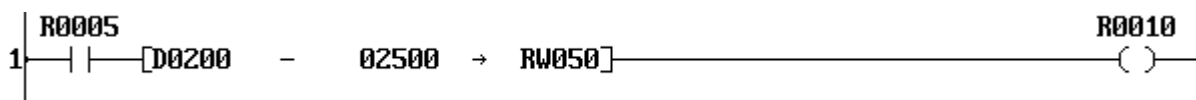

When R005 is ON, the constant data 2500 is subtracted from the data of D0200, and the result is stored in RW50.

If the data of D0200 is 15000, the result 12500 is stored in RW50, and R010 is turned OFF.

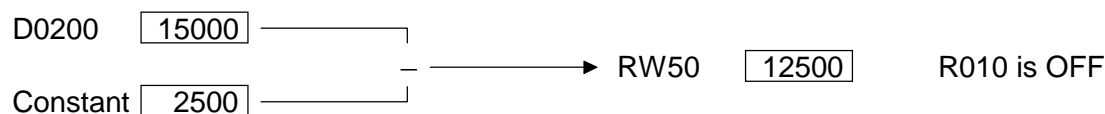

If the data of D0200 is -31000, the result is smaller than the limit value, therefore -32768 is stored in RW50, and R010 is turned ON.

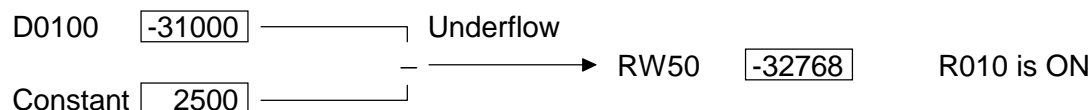

## 7. Instructions

FUN 029	*	Multiplication
---------	---	----------------

### Expression

Input  $-[A * B \rightarrow C+1.C]$ - Output

### Function

When the input is ON, the data of  $A$  is multiplied by the data of  $B$ , and the result is stored in double-length register  $C+1.C$ .

### Execution condition

Input	Operation	Output
OFF	No execution	OFF
ON	Execution	ON

### Operand

	Name	Device						Register										Constant	Index		
		X	Y	R	S	T	C	XW	YW	RW	SW	T	C	D	I	J	K				
$A$	Multiplicand							√	√	√	√	√	√	√	√	√	√	√	√	√	√
$B$	Multiplier							√	√	√	√	√	√	√	√	√	√	√	√	√	√
$C$	Product								√	√	√	√	√	√	√	√	√	√			√

### Example

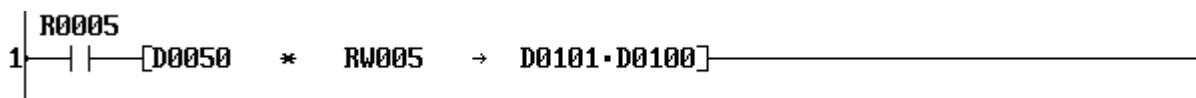

When  $R005$  is ON, the data of  $D0050$  is multiplied by the data of  $RW05$ , and the result is stored in double-length register  $D0101.D0100$  (upper 16-bit in  $D0101$  and lower 16-bit in  $D0100$ ).

If the data of  $D0050$  is 1500 and the data of  $RW05$  is 20, the result 30000 is stored in  $D0101.D0100$ .

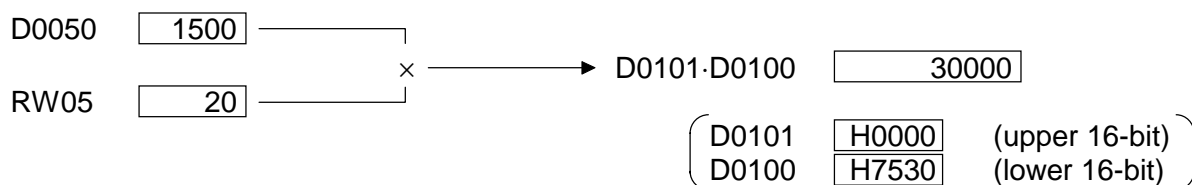

## 7. Instructions

FUN 030	/	Division
---------	---	----------

### Expression

Input  $-[ A / B \rightarrow C ]-$  Output

### Function

When the input is ON, the data of  $A$  is divided by the data of  $B$ , and the quotient is stored in  $C$  and the remainder in  $C+1$ .

### Execution condition

Input	Operation	Output	ERF
OFF	No execution	OFF	-
ON	Normal execution ( $B \neq 0$ )	ON	-
	No execution ( $B = 0$ )	OFF	Set

### Operand

	Name	Device						Register										Constant	Index		
		X	Y	R	S	T	C	XW	YW	RW	SW	T	C	D	I	J	K				
A	Dividend							√	√	√	√	√	√	√	√	√	√	√	√	√	√
B	Divisor							√	√	√	√	√	√	√	√	√	√	√	√	√	√
C	Quotient								√	√	√	√	√	√	√	√	√	√	√		√

### Example

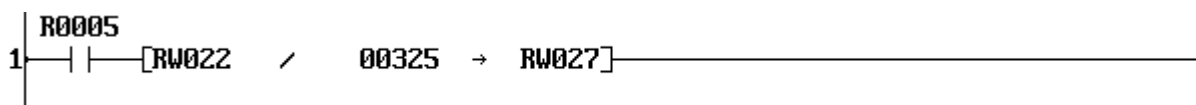

When R005 is ON, the data of RW22 is divided by the constant data 325, and the quotient is stored in RW27 and the remainder is stored in RW28.

If the data of RW22 is 2894, the quotient 8 is stored in RW27 and the remainder 294 is stored in RW28.



### Note

- If divisor (operand  $B$ ) is 0, ERF (instruction error flag = S051) is set to ON. The ERF (S051) can be reset to OFF by user program, e.g.  $-[ RST S051 ]-$ .
- If the index register K is used as operand  $C$ , the remainder is ignored.
- If operand  $A$  is -32768 and operand  $B$  is -1, the data -32768 is stored in  $C$  and 0 is stored in  $C+1$ .

## 7. Instructions

FUN 031	D+	Double-word addition
---------	----	----------------------

### Expression

Input  $-(A+1 \cdot A \text{ D+ } B+1 \cdot B \rightarrow C+1 \cdot C)$ - Output

### Function

When the input is ON, the double-word data of  $A+1 \cdot A$  and  $B+1 \cdot B$  are added, and the result is stored in  $C+1 \cdot C$ . The data range is -2147483648 to 2147483647.

If the result is greater than 2147483647, the upper limit value 2147483647 is stored in  $C+1 \cdot C$ , and the output is turned ON. If the result is smaller than -2147483648, the lower limit value -2147483648 is stored in  $C+1 \cdot C$ , and the output is turned ON.

### Execution condition

Input	Operation	Output
OFF	No execution	OFF
ON	Execution (normal)	OFF
	Execution (overflow or underflow occurred)	ON

### Operand

	Name	Device						Register									Constant	Index	
		X	Y	R	S	T	C	XW	YW	RW	SW	T	C	D	I	J			K
A	Augend							√	√	√	√	√	√	√				√	
B	Addend							√	√	√	√	√	√	√				√	
C	Sum								√	√	√	√	√	√					

### Example



When R005 is ON, the data of D0011·D0010 and the constant data 100000 is added, and the result is stored in D0101·D0100.

If the data of D0011·D0010 is 300000, the result 400000 is stored in D0101·D0100, and R010 is turned OFF. (No overflow/underflow)

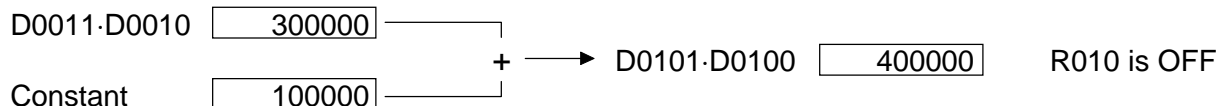

## 7. Instructions

FUN 032	D-	Double-word subtraction
---------	----	-------------------------

### Expression

Input  $-(A+1 \cdot A \text{ D- } B+1 \cdot B \rightarrow C+1 \cdot C)$ - Output

### Function

When the input is ON, the double-word data of  $B+1 \cdot B$  is subtracted from  $A+1 \cdot A$ , and the result is stored in  $C+1 \cdot C$ . The data range is -2147483648 to 2147483647.

If the result is greater than 2147483647, the upper limit value 2147483647 is stored in  $C+1 \cdot C$ , and the output is turned ON. If the result is smaller than -2147483648, the lower limit value -2147483648 is stored in  $C+1 \cdot C$ , and the output is turned ON.

### Execution condition

Input	Operation	Output
OFF	No execution	OFF
ON	Execution (normal)	OFF
	Execution (overflow or underflow occurred)	ON

### Operand

	Name	Device						Register								Constant	Index		
		X	Y	R	S	T	C	XW	YW	RW	SW	T	C	D	I			J	K
A	Minuend							√	√	√	√	√	√	√				√	
B	Subtrahend							√	√	√	√	√	√	√				√	
C	Difference								√	√	√	√	√	√					

### Example



When R005 is ON, the double-word data of RW25·RW24 is subtracted from the double-word data of D0101·D0100, and the result is stored in D0103·D0102.

If the data of D0101·D0100 is 1580000 and the data of RW25·RW24 is 80000, the result 1500000 is stored in D0103·D0102, and R010 is turned OFF. (No overflow/underflow)

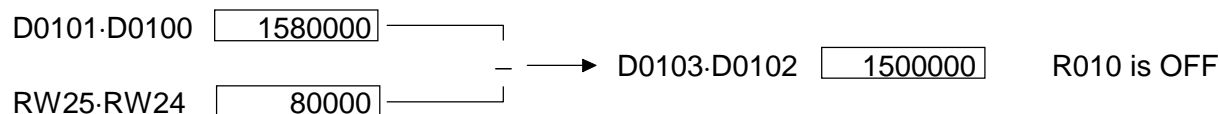



## 7. Instructions

FUN 035	+C	Addition with carry
---------	----	---------------------

### Expression

Input  $-(A +C B \rightarrow C)-$  Output

### Function

When the input is ON, the data of *A*, *B* and the carry flag (CF = S050) are added, and the result is stored in *C*. If carry is occurred in the operation, the carry flag is set to ON. If the result is greater than 32767 or smaller than -32768, the output is turned ON.

This instruction is used to perform unsigned addition or double-length addition.

### Execution condition

Input	Operation				Output	CF
OFF	No execution				OFF	–
ON	Execution	Normal	No carry		OFF	Reset
			Carry occurred		OFF	Set
	Overflow / underflow	No carry		ON	Reset	
		Carry occurred		ON	Set	

### Operand

	Name	Device						Register										Constant	Index
		X	Y	R	S	T	C	XW	YW	RW	SW	T	C	D	I	J	K		
<i>A</i>	Augend							√	√	√	√	√	√	√	√	√	√	√	√
<i>B</i>	Addend							√	√	√	√	√	√	√	√	√	√	√	√
<i>C</i>	Sum								√	√	√	√	√	√	√	√		√	

### Example

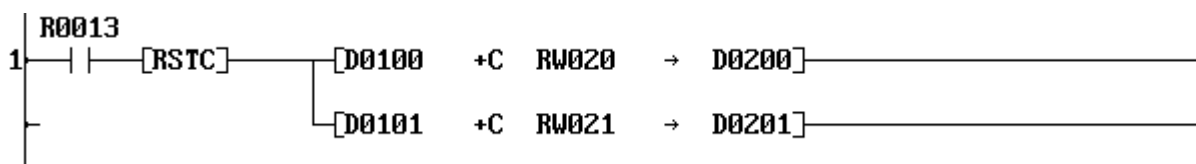

When R013 is ON, the data of double-length registers D0101·D0100 and RW21·RW20 are added, and the result is stored in D0201·D0200. The RSTC is a instruction to reset the carry flag before starting the calculation.

If the data of D0101·D0100 is 12345678 and RW21·RW20 is 54322, the result 12400000 is stored in D0201·D0200.

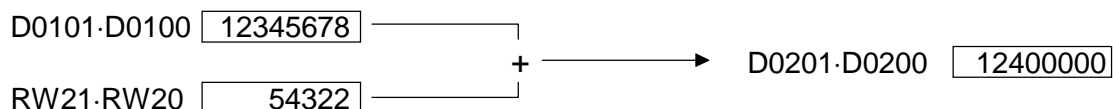

## 7. Instructions

FUN 036	-C	Subtraction with carry
---------	----	------------------------

### Expression

Input  $-[A -C B \rightarrow C]$ - Output

### Function

When the input is ON, the data of  $B$  and the carry flag (CF = S050) are subtracted from  $A$ , and the result is stored in  $C$ . If borrow is occurred in the operation, the carry flag is set to ON. If the result is greater than 32767 or smaller than -32768, the output is turned ON.

This instruction is used to perform unsigned subtraction or double-length subtraction.

### Execution condition

Input	Operation				Output	CF
OFF	No execution				OFF	-
ON	Execution	Normal	No borrow		OFF	Reset
			Borrow occurred		OFF	Set
		Overflow / underflow	No borrow		ON	Reset
			Borrow occurred		ON	Set

### Operand

	Name	Device						Register									Constant	Index	
		X	Y	R	S	T	C	XW	YW	RW	SW	T	C	D	I	J			K
A	Minuend							√	√	√	√	√	√	√	√	√	√	√	√
B	Subtrahend							√	√	√	√	√	√	√	√	√	√	√	√
C	Difference								√	√	√	√	√	√	√	√		√	

### Example

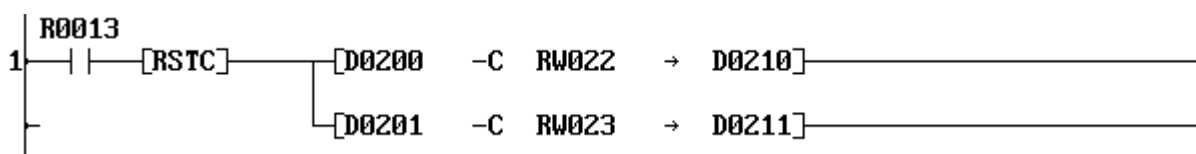

When R013 is ON, the data of double-length register RW23-RW22 is subtracted from the data of D0201·D0200, and the result is stored in D0211·D0210. The RSTC is a instruction to reset the carry flag before starting the calculation.

If the data of D0201·D0200 is 12345678 and RW23·RW22 is 12340000, the result 5678 is stored in D0211·D0210.

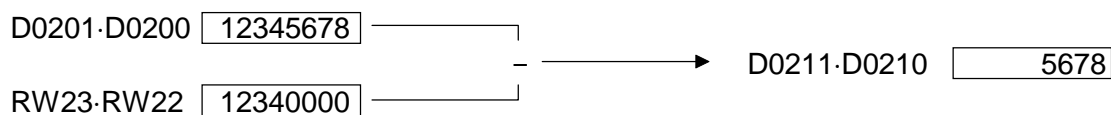

## 7. Instructions

FUN 039	U*	Unsigned multiplication	T1S only
---------	----	-------------------------	----------

### Expression

Input  $-[A \text{ U* } B \rightarrow C+1 \cdot C]$ – Output

### Function

When the input is ON, the unsigned data of  $A$  and  $B$  are multiplied, and the result is stored in double-length register  $C+1 \cdot C$ . The data range of  $A$  and  $B$  is 0 to 65535 (unsigned 16-bit data)

### Execution condition

Input	Operation	Output
OFF	No execution	OFF
ON	Execution	ON

### Operand

	Name	Device						Register										Constant	Index		
		X	Y	R	S	T	C	XW	YW	RW	SW	T	C	D	I	J	K				
$A$	Multiplicand							√	√	√	√	√	√	√	√	√	√	√	√	√	√
$B$	Multiplier							√	√	√	√	√	√	√	√	√	√	√	√	√	√
$C$	Product								√	√	√	√	√	√	√	√	√	√			√

### Example

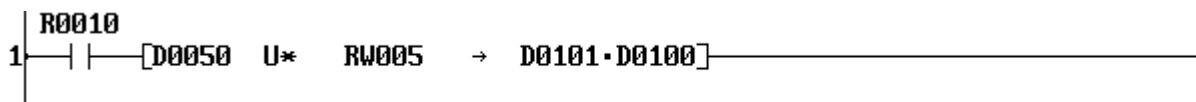

When R010 is ON, the data of D0050 is multiplied by the data of RW05, and the result is stored in double-length register D0101·D0100 (upper 16-bit in D0101 and lower 16-bit in D0100).

If the data of D0050 is 52500 and the data of RW05 is 30, the result 1575000 is stored in D0101·D0100.



### Note

- This instruction handles the register data as unsigned integer.

## 7. Instructions

FUN 040	U/	Unsigned division	T1S only
---------	----	-------------------	----------

### Expression

Input  $-[ A \text{ U/ } B \rightarrow C ]-$  Output

### Function

When the input is ON, the unsigned data of  $A$  is divided by the unsigned data of  $B$ , and the quotient is stored in  $C$  and the remainder in  $C+1$ . The data range of  $A$  and  $B$  is 0 to 65535 (unsigned 16-bit data)

### Execution condition

Input	Operation	Output	ERF
OFF	No execution	OFF	-
ON	Normal execution ( $B \neq 0$ )	ON	-
	No execution ( $B = 0$ )	OFF	Set

### Operand

	Name	Device						Register										Constant	Index		
		X	Y	R	S	T	C	XW	YW	RW	SW	T	C	D	I	J	K				
A	Dividend							√	√	√	√	√	√	√	√	√	√	√	√	√	√
B	Divisor							√	√	√	√	√	√	√	√	√	√	√	√	√	√
C	Quotient								√	√	√	√	√	√	√	√	√	√		√	

### Example

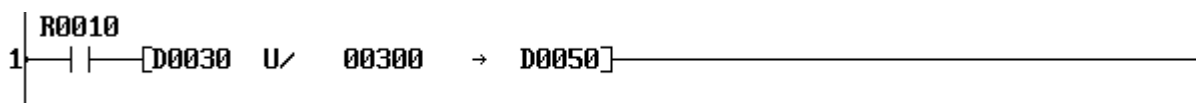

When R010 is ON, the data of D0030 is divided by the constant data 300, and the quotient is stored in D0050 and the remainder is stored in D0051.

If the data of D0030 is 54321, the quotient 181 is stored in D0050 and the remainder 21 is stored in D0051.

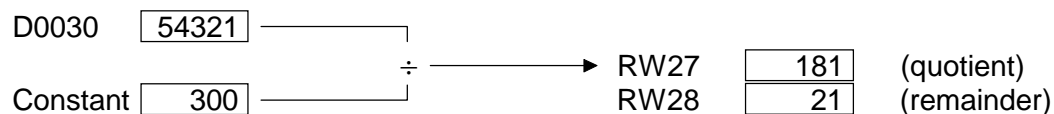

### Note

- If divisor (operand  $B$ ) is 0, ERF (instruction error flag = S051) is set to ON. The ERF (S051) can be reset to OFF by user program, e.g.  $-[ RST \ S051 ]-$ .
- If the index register K is used as operand  $C$ , the remainder is ignored.
- This instruction handles the register data as unsigned integer.

## 7. Instructions

FUN 041	DIV	Unsigned double/single division
---------	-----	---------------------------------

### Expression

Input  $\neg[A+1:A \text{ DIV } B \rightarrow C]$ – Output

### Function

When the input is ON, the double-word data of  $A+1:A$  is divided by the data of  $B$ , and the quotient is stored in  $C$  and the remainder in  $C+1$ . The data range of  $A+1:A$  is 0 to 4294967295, and the data range of  $B$  and  $C$  is 0 to 65535.

If the quotient is greater than 65535 (overflow), the limit value 65535 is stored in  $C$ , 0 is stored in  $C+1$ , and the instruction error flag (ERF = S051) is set to ON.

### Execution condition

Input	Operation	Output	ERF
OFF	No execution	OFF	–
ON	Normal execution ( $B \neq 0$ )	ON	–
	Overflow ( $B \neq 0$ )	ON	Set
	No execution ( $B = 0$ )	OFF	Set

### Operand

	Name	Device						Register										Constant	Index
		X	Y	R	S	T	C	XW	YW	RW	SW	T	C	D	I	J	K		
A	Dividend							√	√	√	√	√	√	√				√	
B	Divisor							√	√	√	√	√	√	√				√	
C	Quotient								√	√	√	√	√	√					

### Example

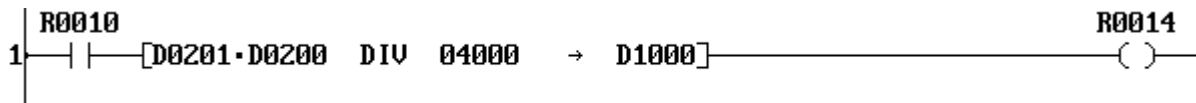

When R010 is ON, the double-word data of D0201·D0200 is divided by the constant data 4000, and the quotient is stored in D1000 and the remainder is stored in D1001.

If the data of D0201·D0200 is 332257, the quotient 83 is stored in D1000 and the remainder 257 is stored in D1001.

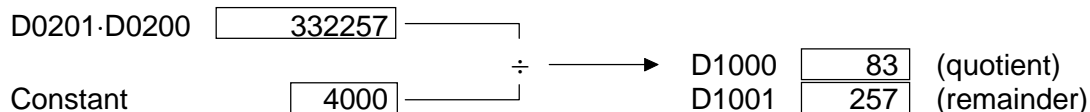

### Note

- If divisor (operand  $B$ ) is 0, ERF (instruction error flag = S051) is set to ON. The ERF (S051) can be reset to OFF by user program, e.g.  $\neg[\text{RST S051}]$ .
- This instruction handles the register data as unsigned integer.

## 7. Instructions

FUN 043	+1	Increment
---------	----	-----------

### Expression

Input $-\text{[+1 A]}$ – Output
---------------------------------

### Function

When the input is ON, the data of A is increased by 1 and stored in A.

### Execution condition

Input	Operation	Output
OFF	No execution	OFF
ON	Execution	ON

### Operand

	Name	Device						Register								Constant	Index			
		X	Y	R	S	T	C	XW	YW	RW	SW	T	C	D	I			J	K	
A	Operation data								√	√	√	√	√	√	√	√	√	√	√	√

### Example



At the rising edge of X004 changes from OFF to ON, the data of D0050 is increased by 1 and stored in D0050.

If the data of D0050 is 750 before the execution, it will be 751 after the execution.



### Note

- There is no limit value for this instruction. When the data of operand A is 32767 before the execution, it will be -32768 after the execution.

## 7. Instructions

FUN 045	-1	Decrement
---------	----	-----------

### Expression

Input  $[-1 A]$  - Output

### Function

When the input is ON, the data of A is decreased by 1 and stored in A.

### Execution condition

Input	Operation	Output
OFF	No execution	OFF
ON	Execution	ON

### Operand

	Name	Device						Register								Constant	Index		
		X	Y	R	S	T	C	XW	YW	RW	SW	T	C	D	I			J	K
A	Operation data								√	√	√	√	√	√	√	√	√	√	√

### Example

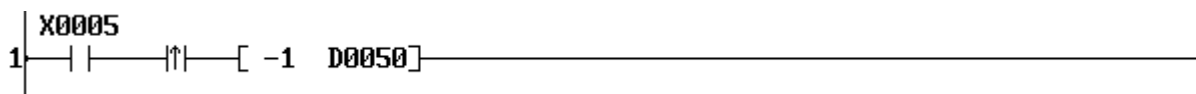

At the rising edge of X005 changes from OFF to ON, the data of D0050 is decreased by 1 and stored in D0050.

If the data of D0050 is 1022 before the execution, it will be 1021 after the execution.



### Note

- There is no limit value for this instruction. When the data of operand A is -32768 before the execution, it will be 32767 after the execution.





## 7. Instructions

FUN 050	OR	OR
---------	----	----

### Expression

Input  $\neg[A \text{ OR } B \rightarrow C]$  Output

### Function

When the input is ON, this instruction finds logical OR of  $A$  and  $B$ , and stores the result in  $C$ .

### Execution condition

Input	Operation	Output
OFF	No execution	OFF
ON	Execution	ON

### Operand

	Name	Device						Register								Constant	Index		
		X	Y	R	S	T	C	XW	YW	RW	SW	T	C	D	I			J	K
$A$	Source							√	√	√	√	√	√	√	√	√	√	√	√
$B$	source							√	√	√	√	√	√	√	√	√	√	√	√
$C$	OR								√	√	√	√	√	√	√	√		√	

### Example

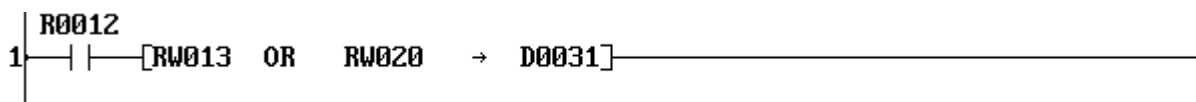

When  $R012$  is ON, logical OR operation is executed for the data of  $RW13$  and  $RW20$ , and the result is stored in  $D0031$ .

If the data of  $RW13$  is  $H5678$  and  $RW20$  is  $H4321$ , the result  $H5779$  is stored in  $D0031$ .

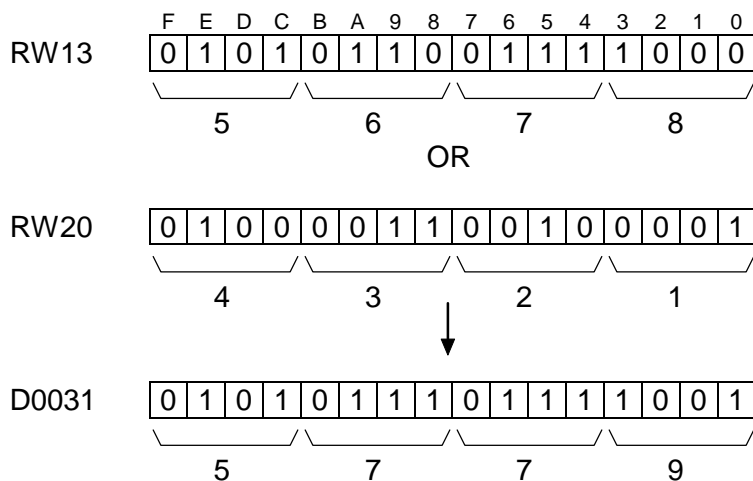



## 7. Instructions

FUN 056	MAVE	Moving average
---------	------	----------------

T1S only

### Expression

Input  $-\lbrack A \text{ MAVE } (n) B \rightarrow C \rbrack$ – Output

### Function

When the input is ON, this instruction calculates the average value of the latest  $n$  scan's register  $A$  data, and stores it in  $C$ . The allowable range of  $n$  is 1 to 64.

This instruction is useful for filtering the analog input signal.

The latest  $n$  scan's data of  $A$  are stored in  $n$  registers starting with  $B$ , and  $C+1$  are used as pointer.

### Execution condition

Input	Operation	Output
OFF	No execution	OFF
ON	Execution	ON

### Operand

	Name	Device						Register								Constant	Index		
		X	Y	R	S	T	C	XW	YW	RW	SW	T	C	D	I			J	K
$A$	Input data							√	√	√	√	√	√	√	√	√	√	√	
$n$	Data size																	1 - 64	
$B$	Start of table								√	√	√	√	√						
$C$	Output data								√	√	√	√	√	√	√	√			

### Example

1-  $\lbrack XW004 \text{ MAVE } (05) \text{ D0900} \rightarrow \text{D0010} \rbrack$

The latest 5 scan's data of XW04 is stored in D0900 to D0904 (5 registers), and the average value of them is calculated and stored in D0010.

D0011 is used as internal work data.

	XW04	D0010	
1st scan	1000	200	= (1000) / 5
2nd scan	1005	401	= (1000 + 1005) / 5
3rd scan	1009	603	= (1000 + 1005 + 1009) / 5
4th scan	1012	805	= (1000 + 1005 + 1009 + 1012) / 5
5th scan	1007	1006	= (1000 + 1005 + 1009 + 1012 + 1007) / 5
6th scan	1004	1007	= (1005 + 1009 + 1012 + 1007 + 1004) / 5
7th scan	998	1006	= (1009 + 1012 + 1007 + 1004 + 998) / 5
8th scan	994	1003	= (1012 + 1007 + 1004 + 998 + 994) / 5
	⋮		



## 7. Instructions

FUN 062	HTOA	Hex to ASCII conversion
---------	------	-------------------------

T1S only

### Expression

Input $\rightarrow$ [ A HTOA (n) B ] $\rightarrow$ Output
---

### Function

When the input is ON, the hexadecimal data of  $n$  registers starting with  $A$  is converted into ASCII characters and stored in  $B$  and after. The uppermost digit of source  $A$  is stored in lower byte of destination  $B$ , and followed in this order. The allowable range of  $n$  is 1 to 32.

### Execution condition

Input	Operation	Output
OFF	No execution	OFF
ON	Execution	ON

### Operand

	Name	Device						Register								Constant	Index		
		X	Y	R	S	T	C	XW	YW	RW	SW	T	C	D	I			J	K
$A$	Source							√	√	√	√	√	√	√	√	√	√	√	
$n$	Data size																	1 - 32	
$B$	Destination								√	√	√	√	√	√					

### Example

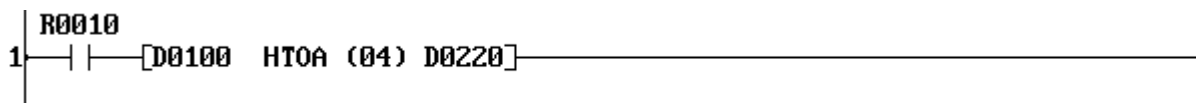

When R010 is ON, 4 words data of D0100 to D0103 are converted into ASCII characters, and stored in 8 words registers starting with D0200.

	<table border="1" style="border-collapse: collapse; width: 100%;"> <tr><td style="text-align: center;">F</td><td style="text-align: center;">0</td></tr> <tr><td>D0100</td><td style="text-align: center;">H0123</td></tr> <tr><td>D0101</td><td style="text-align: center;">H4567</td></tr> <tr><td>D0102</td><td style="text-align: center;">H89AB</td></tr> <tr><td>D0103</td><td style="text-align: center;">HCDEF</td></tr> </table>	F	0	D0100	H0123	D0101	H4567	D0102	H89AB	D0103	HCDEF	Converted $\rightarrow$	<table border="1" style="border-collapse: collapse; width: 100%;"> <tr><td style="text-align: center;">F</td><td style="text-align: center;">8</td><td style="text-align: center;">7</td><td style="text-align: center;">0</td></tr> <tr><td>D0220</td><td style="text-align: center;">"1" (H31)</td><td style="text-align: center;">"0" (H30)</td><td></td></tr> <tr><td>D0221</td><td style="text-align: center;">"3" (H33)</td><td style="text-align: center;">"2" (H32)</td><td></td></tr> <tr><td>D0222</td><td style="text-align: center;">"5" (H35)</td><td style="text-align: center;">"4" (H34)</td><td></td></tr> <tr><td>D0223</td><td style="text-align: center;">"7" (H37)</td><td style="text-align: center;">"6" (H36)</td><td></td></tr> <tr><td>D0224</td><td style="text-align: center;">"9" (H39)</td><td style="text-align: center;">"8" (H38)</td><td></td></tr> <tr><td>D0225</td><td style="text-align: center;">"B" (H42)</td><td style="text-align: center;">"A" (H41)</td><td></td></tr> <tr><td>D0226</td><td style="text-align: center;">"D" (H44)</td><td style="text-align: center;">"C" (H43)</td><td></td></tr> <tr><td>D0227</td><td style="text-align: center;">"F" (H46)</td><td style="text-align: center;">"E" (H45)</td><td></td></tr> </table>	F	8	7	0	D0220	"1" (H31)	"0" (H30)		D0221	"3" (H33)	"2" (H32)		D0222	"5" (H35)	"4" (H34)		D0223	"7" (H37)	"6" (H36)		D0224	"9" (H39)	"8" (H38)		D0225	"B" (H42)	"A" (H41)		D0226	"D" (H44)	"C" (H43)		D0227	"F" (H46)	"E" (H45)	
F	0																																																
D0100	H0123																																																
D0101	H4567																																																
D0102	H89AB																																																
D0103	HCDEF																																																
F	8	7	0																																														
D0220	"1" (H31)	"0" (H30)																																															
D0221	"3" (H33)	"2" (H32)																																															
D0222	"5" (H35)	"4" (H34)																																															
D0223	"7" (H37)	"6" (H36)																																															
D0224	"9" (H39)	"8" (H38)																																															
D0225	"B" (H42)	"A" (H41)																																															
D0226	"D" (H44)	"C" (H43)																																															
D0227	"F" (H46)	"E" (H45)																																															

### Note

- If index register (I, J or K) is used for the operand  $A$ , only  $n = 1$  is allowed. Otherwise, boundary error will occur.

## 7. Instructions

FUN 063	ATOH	ASCII to Hex conversion
---------	------	-------------------------

T1S only

### Expression

Input  $-[ A \text{ ATOH } (n) B ]-$  Output

### Function

When the input is ON, the ASCII characters stored in  $n$  registers starting with  $A$  is converted into hexadecimal data and stored in  $B$  and after. The lower byte of source  $A$  is stored as uppermost digit of destination  $B$ , and followed in this order. The allowable ASCII character in the source table is "0" (H30) to "9" (H39) and "A" (H41) to "F" (H46). The allowable range of  $n$  is 1 to 64.

### Execution condition

Input	Operation	Output	ERF
OFF	No execution	OFF	–
ON	Normal execution	ON	–
	Conversion data error (no execution)	OFF	Set

### Operand

	Name	Device						Register								Constant	Index		
		X	Y	R	S	T	C	XW	YW	RW	SW	T	C	D	I			J	K
$A$	Source							√	√	√	√	√	√	√	√	√	√	√	
$n$	Data size																	1 - 64	
$B$	Destination								√	√	√	√	√	√					

### Example

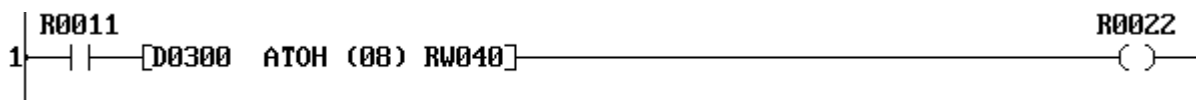

When R011 is ON, the ASCII characters stored in 8 words of D0300 to D0307 are converted into hexadecimal data, and stored in 4 words registers starting with RW040.

	F	8	7	0		F	0
D0300	"1" (H31)	"0" (H30)			Converted →	RW040	H0123
D0301	"3" (H33)	"2" (H32)				RW041	H4567
D0302	"5" (H35)	"4" (H34)				RW042	H89AB
D0303	"7" (H37)	"6" (H36)				RW043	HCDEF
D0304	"9" (H39)	"8" (H38)					
D0305	"B" (H42)	"A" (H41)					
D0306	"D" (H44)	"C" (H43)					
D0307	"F" (H46)	"E" (H45)					

### Note

- If index register (I, J or K) is used for the operand  $A$ , only  $n = 1$  is allowed.
- If  $n$  is odd number, lower 2 digits of the last converted data will not be fixed, Use even for  $n$ .

## 7. Instructions

FUN 064	TEST	Bit test
---------	------	----------

### Expression

Input  $\neg[A \text{ TEST } B]$ – Output

### Function

When the input is ON, this instruction finds logical AND of *A* and *B*. Then if the result is not 0, sets the output to ON.

### Execution condition

Input	Operation	Output
OFF	No execution	OFF
ON	Execution	When the result is not 0
		When the result is 0
		ON
		OFF

### Operand

	Name	Device						Register									Constant	Index	
		X	Y	R	S	T	C	XW	YW	RW	SW	T	C	D	I	J			K
<i>A</i>	Source							√	√	√	√	√	√	√	√	√	√	√	√
<i>B</i>	Test data							√	√	√	√	√	√	√	√	√	√	√	√

### Example

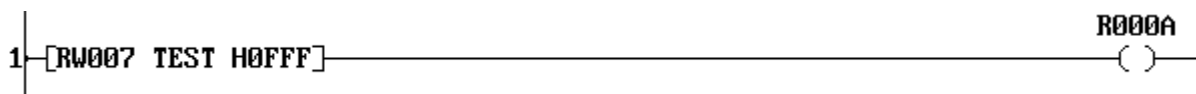

Logical AND operation is executed for the data of RW07 and the constant data H0FFF, and if the result is not 0, R00A is turned ON. (R00A is turned ON when any device from R070 to R07B is ON.)

If the data of RW07 is H4008, R00A is turned ON.

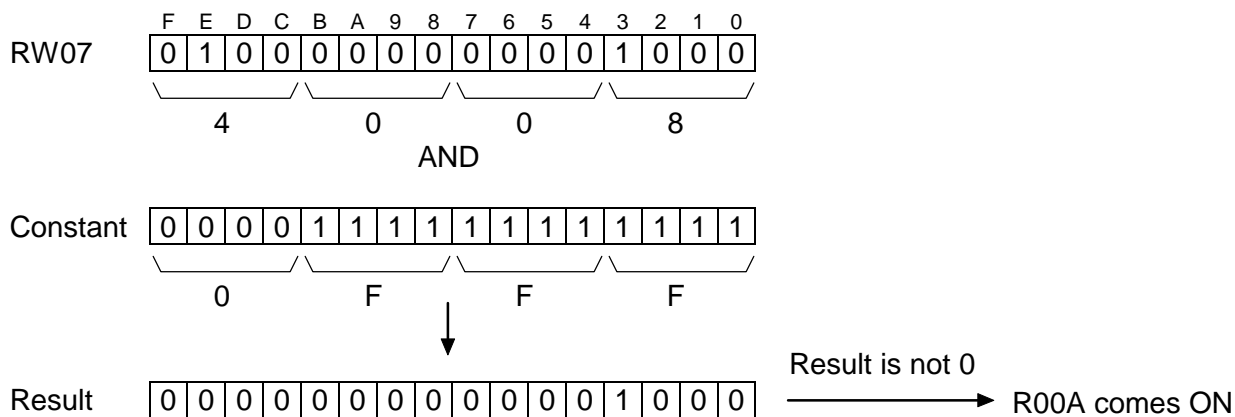

## 7. Instructions

FUN 068	SHR1	1 bit shift right
---------	------	-------------------

### Expression

Input  $\neg$ [ SHR1 A ] $\neg$  Output

### Function

When the input is ON, the data of register A is shifted 1 bit to the right (LSB direction). 0 is stored in the left most bit (MSB). The pushed out bit state is stored in the carry flag (CF = S050). After the operation, if the right most bit (LSB) is ON, the output is turned ON.

### Execution condition

Input	Operation		Output	CF
OFF	No execution		OFF	-
ON	Execution	When LSB = 1	ON	Set or reset
		When LSB = 0	OFF	Set or reset

### Operand

	Name	Device						Register								Constant	Index		
		X	Y	R	S	T	C.	XW	YW	RW	SW	T	C	D	I			J	K
A	Operation data								√	√	√	√	√	√	√	√	√		√

### Example

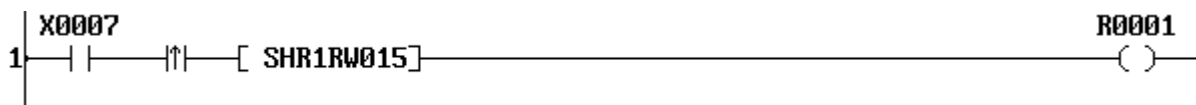

When X007 is changed from OFF to ON, the data of RW15 is shifted 1 bit to the right.

The figure below shows an operation example.

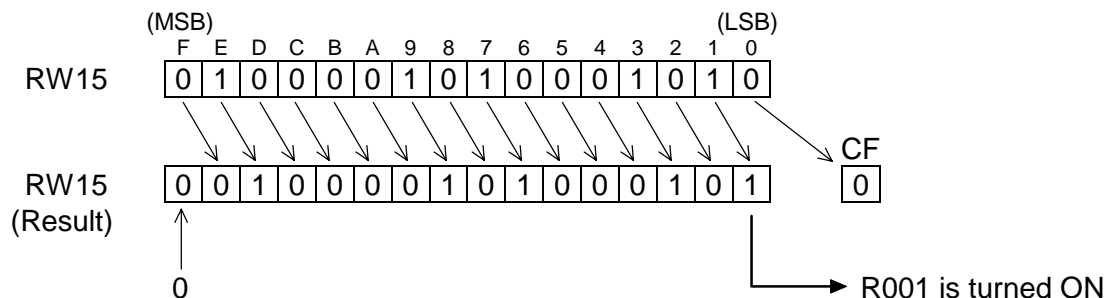



## 7. Instructions

FUN 069	SHL1	1 bit shift left
---------	------	------------------

### Expression

Input  $\neg$ [ SHL1 A ]- Output

### Function

When the input is ON, the data of register A is shifted 1 bit to the left (MSB direction). 0 is stored in the right most bit (LSB). The pushed out bit state is stored in the carry flag (CF = S050). After the operation, if the left most bit (MSB) is ON, the output is turned ON.

### Execution condition

Input	Operation	Output	CF
OFF	No execution	OFF	-
ON	Execution	When MSB = 1	ON
		When MSB = 0	OFF

### Operand

	Name	Device						Register								Constant	Index		
		X	Y	R	S	T	C.	XW	YW	RW	SW	T	C	D	I			J	K
A	Operation data								√	√	√	√	√	√	√	√	√		√

### Example

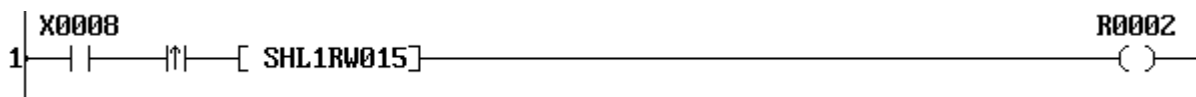

When X008 is changed from OFF to ON, the data of RW15 is shifted 1 bit to the left.

The figure below shows an operation example.

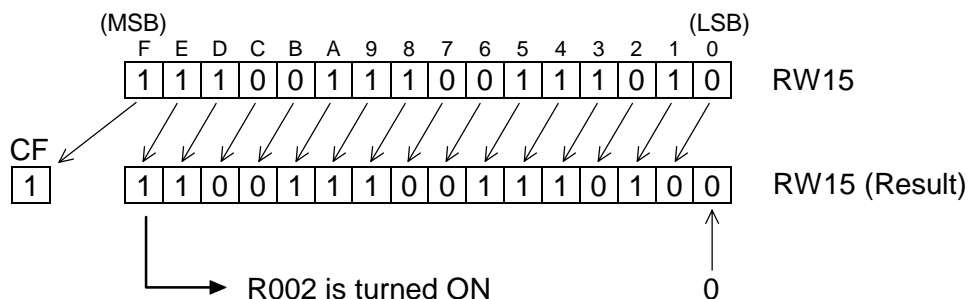

## 7. Instructions

FUN 070	SHR	n bit shift right
---------	-----	-------------------

### Expression

Input  $\rightarrow [A \text{ SHR } n \rightarrow B]$  Output

### Function

When the input is ON, the data of register *A* is shifted *n* bits to the right (LSB direction) including the carry flag (CF = S050), and stored in *B*. 0 is stored in upper *n* bits. After the operation, if the right most bit (LSB) is ON, the output is turned ON.

### Execution condition

Input	Operation		Output	CF
OFF	No execution		OFF	-
ON	Execution	When LSB = 1	ON	Set or reset
		When LSB = 0	OFF	Set or reset

### Operand

	Name	Device						Register										Constant	Index
		X	Y	R	S	T	C.	XW	YW	RW	SW	T	C	D	I	J	K		
<i>A</i>	Source							√	√	√	√	√	√	√	√	√	√	√	√
<i>n</i>	Shift bits																	1 - 16	
<i>B</i>	Destination								√	√	√	√	√	√	√	√		√	

### Example



When X007 is changed from OFF to ON, the data of RW18 is shifted 5 bits to the right and the result is stored in RW20.

The figure below shows an operation example.

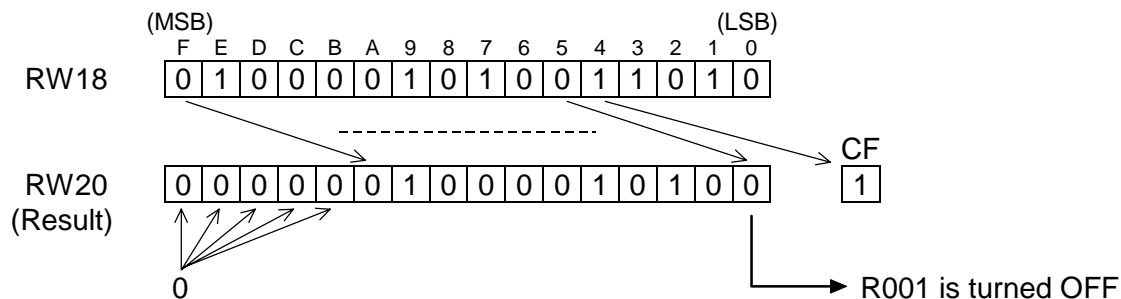

## 7. Instructions

FUN 071	SHL	n bit shift left
---------	-----	------------------

### Expression

Input  $\neg [A \text{ SHL } n \rightarrow B]$  - Output

### Function

When the input is ON, the data of register *A* is shifted *n* bits to the left (MSB direction) including the carry flag (CF = S050), and stored in *B*. 0 is stored in lower *n* bits. After the operation, if the left most bit (MSB) is ON, the output is turned ON.

### Execution condition

Input	Operation		Output	CF
OFF	No execution		OFF	-
ON	Execution	When MSB = 1	ON	Set or reset
		When MSB = 0	OFF	Set or reset

### Operand

	Name	Device						Register								Constant	Index		
		X	Y	R	S	T	C.	XW	YW	RW	SW	T	C	D	I			J	K
<i>A</i>	Source							√	√	√	√	√	√	√	√	√	√	√	√
<i>n</i>	Shift bits																	1 - 16	
<i>B</i>	Destination								√	√	√	√	√	√	√	√		√	

### Example



When X008 is changed from OFF to ON, the data of RW18 is shifted 3 bits to the left and the result is stored in RW20.

The figure below shows an operation example.

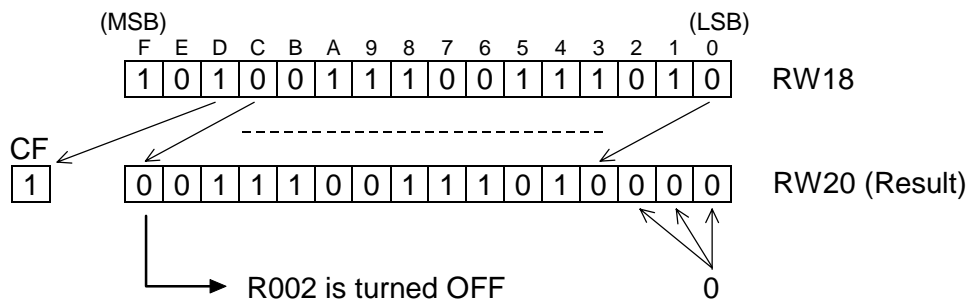

## 7. Instructions

FUN 074	SR	Shift register
---------	----	----------------

### Expression

Data input	—[D SR Q]	Output
Shift input	—[S (n)]	
Enable input	—[E A]	

### Function

While the enable input is ON, this instruction shifts the data of the bit table, size  $n$  starting with  $A$ , 1 bit to the left (upper address direction) when the shift input is ON. The state of the data input is stored in  $A$ . The pushed out bit state is stored in the carry flag (CF = S050).

When the enable input is OFF, all bits in the table and the carry flag are reset to OFF.

### Execution condition

Enable input	Operation	Output	CF
OFF	Resets all bits in the bit table	OFF	Reset
ON	When the shift input is ON	Shift execution	Last bit
	When the shift input is OFF	No execution	state
			Set or reset
			—

### Operand

	Name	Device						Register								Constant	Index		
		X	Y	R	S	T	C	XW	YW	RW	SW	T	C	D	I			J	K
$A$	Leading device		√	√	√														
$n$	Device size																		1 - 64

### Example



32 devices starting with R100 (R100 to R11F) is specified as a shift register.

When R010 is OFF, the data of the shift register is reset to 0. (R100 to R11F are reset to OFF)

The carry flag (CF = S050) is also reset to OFF.

While R010 is ON, the data of the shift register is shifted 1 bit to the upper address direction when X009 is changed from OFF to ON. At the same time, the state of X008 is stored in the leading bit (R100).

The output (R011) indicates the state of the last bit (R11F).

## 7. Instructions

The figure below shows an operation example. (When X009 is changed from OFF to ON)

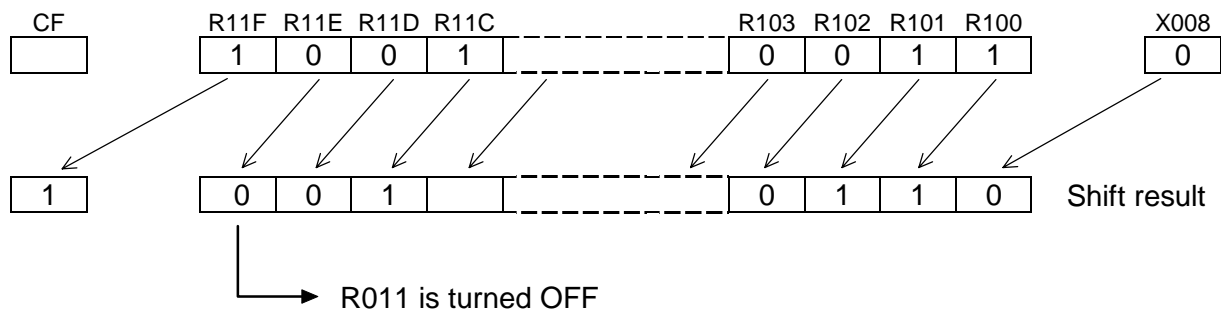

### Note

- When the shift input is ON, the shift operation is performed every scan. Use a transitional contact for the shift input to detect the state changing.
- For the data input and the shift input, direct linking to a connecting point is not allowed. In this case, insert a dummy contact (always ON special device = S04F, etc.) just before the input.

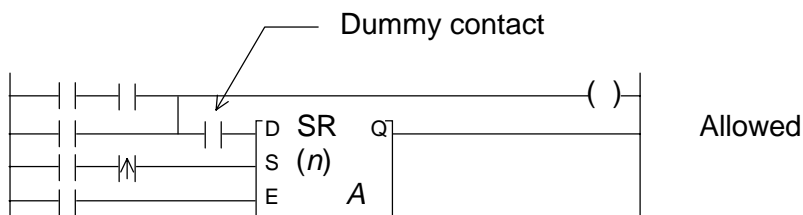
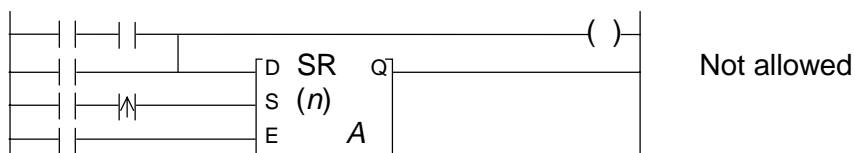

## 7. Instructions

FUN 075	DSR	Bi-directional shift register
---------	-----	-------------------------------

### Expression

Data input	-[D DSR Q]	Output
Shift input	-S (n)	
Enable input	-E	
Direction input	-[L A]	

### Function

While the enable input (E) is ON, this instruction shifts the data of the bit table, size  $n$  starting with  $A$ , 1 bit when the shift input (S) is ON. The shift direction is determined by the state of the direction input (L).

When L is OFF, the direction is right (lower address direction).

When L is ON, the direction is left (upper address direction).

The state of the data input (D) is stored in the highest bit if right shift, and stored in the lowest bit  $A$  if left shift. The pushed out bit state is stored in the carry flag (CF = S050).

When the enable input (E) is OFF, all bits in the table and the carry flag are reset to OFF.

### Execution condition

Enable input	Operation		Output	CF	
OFF	Resets all bits in the bit table		OFF	Reset	
ON	S = ON	L = ON	Shift left execution	Highest bit state	Set or reset
		L = OFF	Shift right execution	Lowest bit state	Set or reset
	S = OFF	No execution	Highest bit state	-	

### Operand

	Name	Device						Register								Constant	Index				
		X	Y	R	S	T	C	XW	YW	RW	SW	T	C	D	I			J	K		
$A$	Leading device		√	√	√																
$n$	Device size																			1 - 64	

### Example

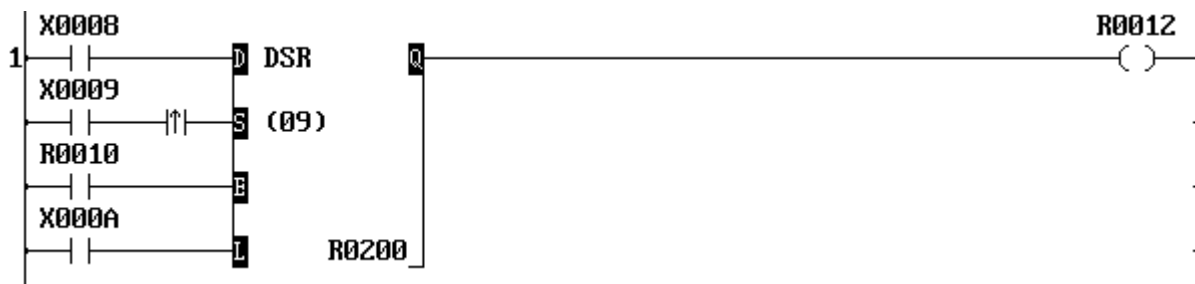

## 7. Instructions

9 devices starting with R200 (R200 to R208) is specified as a shift register.

When R010 is OFF, the data of the shift register is reset to 0. (R200 to R208 are reset to OFF)

The carry flag (CF = S050) is also reset to OFF.

While R010 is ON the following operation is enabled.

- When X00A is ON (shift left), the data of the shift register is shifted 1 bit to the upper address direction when X009 is changed from OFF to ON. At the same time, the state of X008 is stored in the leading bit (R200). The output (R012) indicates the state of the highest bit (R208).
- When X00A is OFF (shift right), the data of the shift register is shifted 1 bit to the lower address direction when X009 is changed from OFF to ON. At the same time, the state of X008 is stored in the highest bit (R208). The output (R012) indicates the state of the lowest bit (R200).

The figure below shows an operation example.

(When X00A is ON and X009 is changed from OFF to ON)

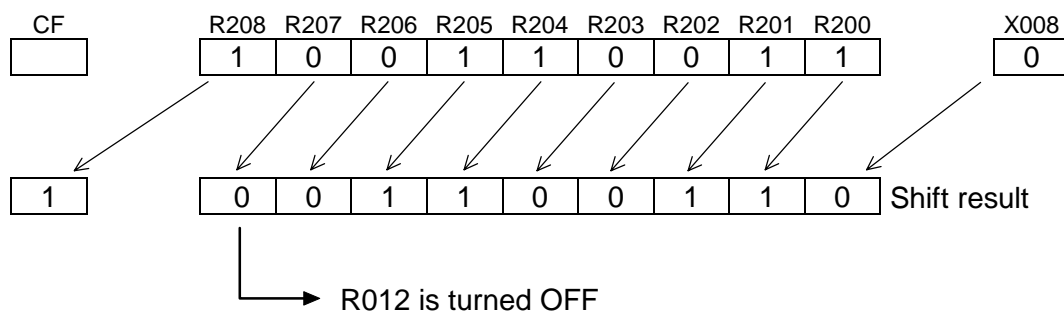

(When X00A is OFF and X009 is changed from OFF to ON)

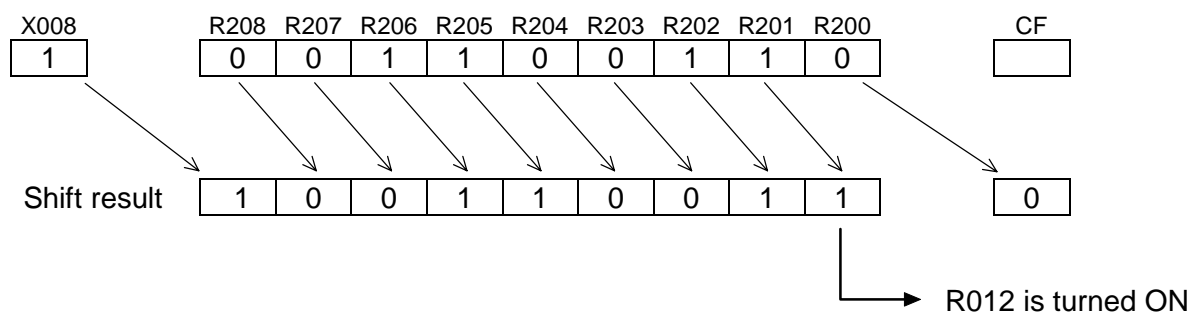

### Note

- When the shift input is ON, the shift operation is performed every scan. Use a transitional contact for the shift input to detect the state changing.
- For the data input, the shift input and the enable input, direct linking to a connecting point is not allowed. In this case, insert a dummy contact (always ON special device = S04F, etc.) just before the input. Refer to Note of Shift register FUN 074.

## 7. Instructions

FUN 078	RTR1	1 bit rotate right
---------	------	--------------------

### Expression

Input  $\neg$ [ RTR1 A ]- Output

### Function

When the input is ON, the data of register A is rotated 1 bit to the right (LSB direction). The pushed out bit state is stored in the left most bit (MSB) and in the carry flag (CF = S050). After the operation, if the right most bit (LSB) is ON, the output is turned ON.

### Execution condition

Input	Operation		Output	CF
OFF	No execution		OFF	-
ON	Execution	When LSB = 1	ON	Set or reset
		When LSB = 0	OFF	Set or reset

### Operand

	Name	Device						Register								Constant	Index		
		X	Y	R	S	T	C.	XW	YW	RW	SW	T	C	D	I			J	K
A	Operation data								√	√	√	√	√	√	√	√	√		√

### Example



When X007 is changed from OFF to ON, the data of RW15 is rotated 1 bit to the right.

The figure below shows an operation example.

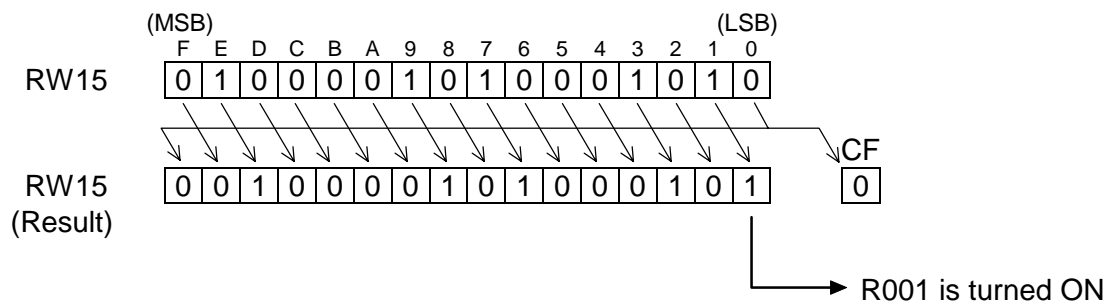



## 7. Instructions

FUN 079	RTL1	1 bit rotate left
---------	------	-------------------

### Expression

Input  $\neg$ [ RTL1 A ]- Output

### Function

When the input is ON, the data of register A is rotated 1 bit to the left (MSB direction). The pushed out bit state is stored in the right most bit (LSB) and in the carry flag (CF = S050). After the operation, if the left most bit (MSB) is ON, the output is turned ON.

### Execution condition

Input	Operation	Output	CF
OFF	No execution	OFF	-
ON	Execution	When MSB = 1	ON
		When MSB = 0	OFF

### Operand

	Name	Device						Register								Constant	Index		
		X	Y	R	S	T	C.	XW	YW	RW	SW	T	C	D	I			J	K
A	Operation data								√	√	√	√	√	√	√	√	√		√

### Example

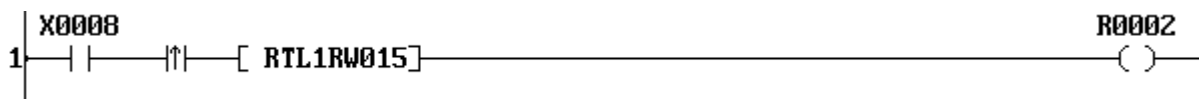

When X008 is changed from OFF to ON, the data of RW15 is rotated 1 bit to the left.

The figure below shows an operation example.

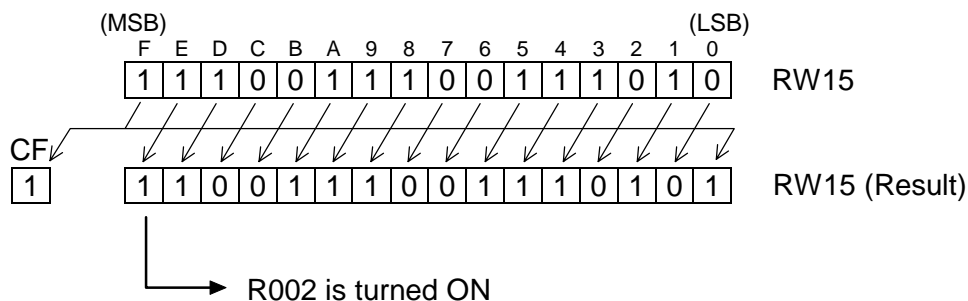

## 7. Instructions

FUN 080	RTR	n bit rotate right
---------	-----	--------------------

### Expression

Input  $\rightarrow [A \text{ RTR } n \rightarrow B]$  Output

### Function

When the input is ON, the data of register *A* is rotated *n* bits to the right (LSB direction), and stored in *B*. After the operation, if the right most bit (LSB) is ON, the output is turned ON.

### Execution condition

Input	Operation		Output	CF
OFF	No execution		OFF	-
ON	Execution	When LSB = 1	ON	Set or reset
		When LSB = 0	OFF	Set or reset

### Operand

	Name	Device						Register								Constant	Index		
		X	Y	R	S	T	C	XW	YW	RW	SW	T	C	D	I			J	K
<i>A</i>	Source							√	√	√	√	√	√	√	√	√	√	√	√
<i>n</i>	Shift bits																	1 - 16	
<i>B</i>	Destination								√	√	√	√	√	√	√	√		√	

### Example



When X007 is changed from OFF to ON, the data of RW18 is rotated 5 bits to the right and the result is stored in RW20.

The figure below shows an operation example.

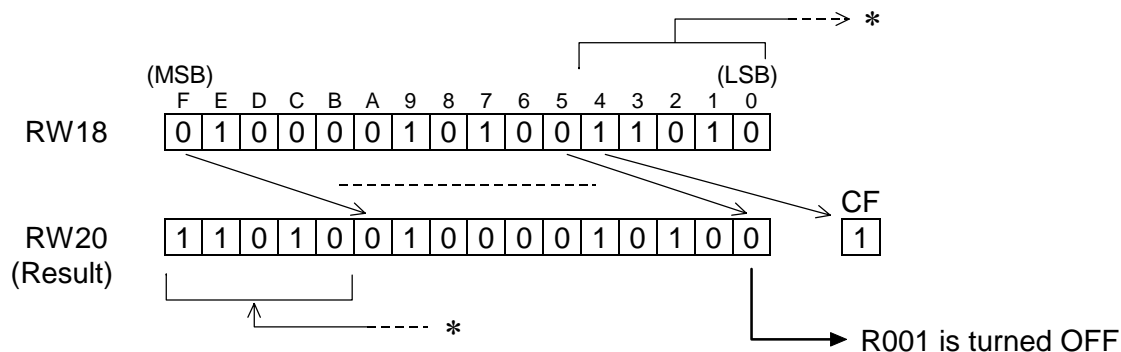

## 7. Instructions

FUN 081	RTL	n bit rotate left
---------	-----	-------------------

### Expression

Input  $\neg[A \text{ RTL } n \rightarrow B]$ – Output

### Function

When the input is ON, the data of register *A* is rotated *n* bits to the left (MSB direction), and stored in *B*. After the operation, if the left most bit (MSB) is ON, the output is turned ON.

### Execution condition

Input	Operation	Output	CF
OFF	No execution	OFF	–
ON	Execution	When MSB = 1	ON
		When MSB = 0	OFF

### Operand

	Name	Device						Register								Constant	Index		
		X	Y	R	S	T	C	XW	YW	RW	SW	T	C	D	I			J	K
<i>A</i>	Source							√	√	√	√	√	√	√	√	√	√	√	√
<i>n</i>	Shift bits																	1 - 16	
<i>B</i>	Destination								√	√	√	√	√	√	√	√		√	

### Example

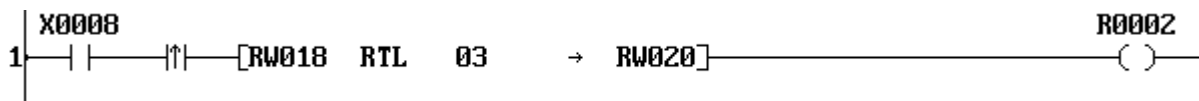

When X008 is changed from OFF to ON, the data of RW18 is rotated 3 bits to the left and the result is stored in RW20.

The figure below shows an operation example.

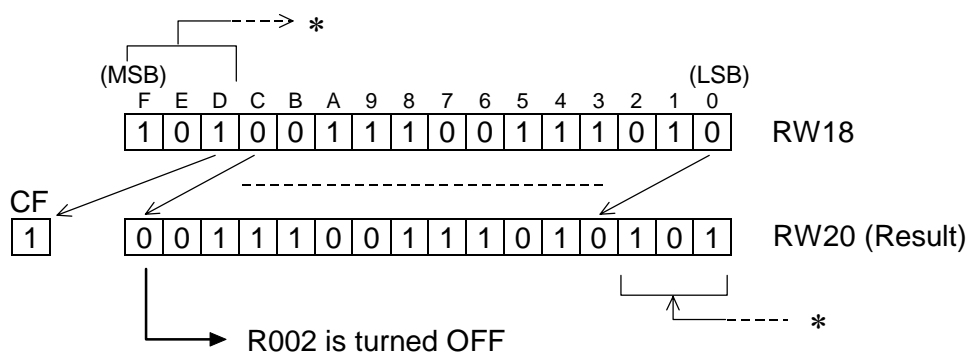

## 7. Instructions

FUN 090	MPX	Multiplexer
---------	-----	-------------

### Expression

Input  $-\{ A \text{ MPX } (n) B \rightarrow C \}$  - Output

### Function

When the input is ON, the data of the register which is designated by  $B$  in the table, size  $n$  starting with  $A$ , is transferred to  $C$ .

### Execution condition

Input	Operation	Output
OFF	No execution	OFF
ON	Normal execution	OFF
	Pointer over (no execution)	ON

### Operand

	Name	Device						Register								Constant	Index			
		X	Y	R	S	T	C	XW	YW	RW	SW	T	C	D	I			J	K	
$A$	Start of table							√	√	√	√	√	√	√						
$n$	Table size																		1 - 64	
$B$	Pointer							√	√	√	√	√	√	√	√	√	√	√	0 - 63	
$C$	Destination								√	√	√	√	√	√	√	√	√			

### Example

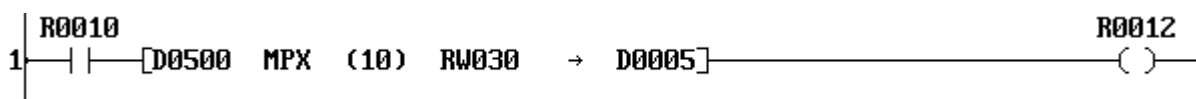

When R010 is ON, the register data which is designated by RW30 is read from the table D0500 to D0509 (10 registers size), and stored in D0005.

If the data of RW30 is 7, D0507 data is transferred to D0005.

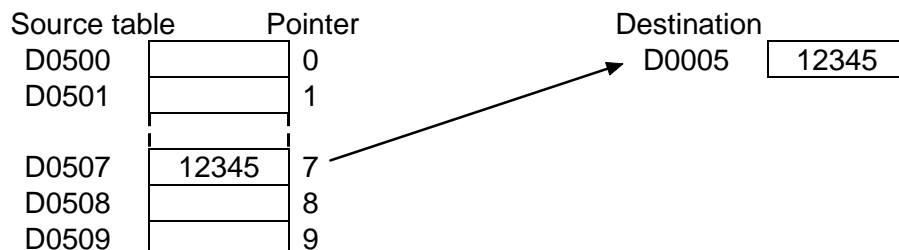

### Note

- If the pointer data designates outside the table (10 or more in the above example), the transfer is not executed and the output comes ON.
- The table must be within the effective range of the register address.

## 7. Instructions

FUN 091	DPX	Demultiplexer
---------	-----	---------------

### Expression

Input  $\neg[A \text{ DPX } (n) B \rightarrow C]$  - Output

### Function

When the input is ON, the data of  $A$  is transferred to the register which is designated by  $B$  in the table, size  $n$  starting with  $C$ .

### Execution condition

Input	Operation	Output
OFF	No execution	OFF
ON	Normal execution	OFF
	Pointer over (no execution)	ON

### Operand

	Name	Device						Register								Constant	Index		
		X	Y	R	S	T	C	XW	YW	RW	SW	T	C	D	I			J	K
$A$	Source							√	√	√	√	√	√	√	√	√	√	√	
$n$	Table size																	1 - 64	
$B$	Pointer							√	√	√	√	√	√	√	√	√	√	0 - 63	
$C$	Start of table								√	√	√	√	√	√					

### Example

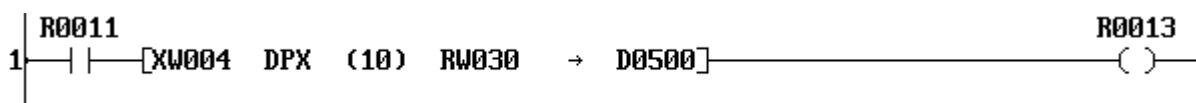

When R011 is ON, the data of XW04 is transferred to the register which is designated by RW30 in the table D0500 to D0509 (10 registers size).

If the data of RW30 is 8, XW04 data is transferred to D0508.

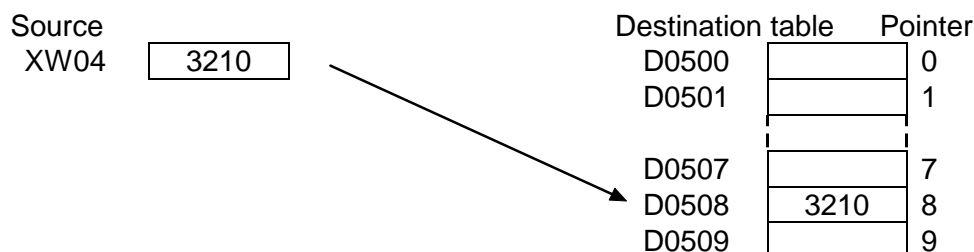

### Note

- If the pointer data designates outside the table (10 or more in the above example), the transfer is not executed and the output comes ON.
- The table must be within the effective range of the register address.

## 7. Instructions

FUN 096	>	Greater than
---------	---	--------------

### Expression

Input  $-[A > B]$ - Output

### Function

When the input is ON, the data of  $A$  and the data of  $B$  are compared, and if  $A$  is greater than  $B$ , the output is turned ON.

### Execution condition

Input	Operation		Output
OFF	No execution		OFF
ON	Execution	$A > B$	ON
		$A \leq B$	OFF

### Operand

	Name	Device						Register									Constant	Index	
		X	Y	R	S	T	C	XW	YW	RW	SW	T	C	D	I	J			K
A	Compared data							√	√	√	√	√	√	√	√	√	√	√	√
B	Reference data							√	√	√	√	√	√	√	√	√	√	√	√

### Example

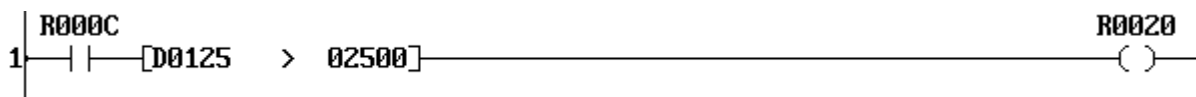

When R00C is ON, the data of D0125 is compared with the constant data 2500, and if the data of D0125 is greater than 2500, R020 is turned ON.

If the data of D0125 is 3000, the comparison result is true. Consequently, R020 is turned ON.

D0125 3000 > Constant 2500  $\longrightarrow$  R020 is ON

If the data of D0125 is -100, the comparison result is false. Consequently, R020 is turned OFF.

D0125 -100  $\leq$  Constant 2500  $\longrightarrow$  R020 is OFF

### Note

- This instruction deals with the data as signed integer (-32768 to 32767).

## 7. Instructions

FUN 097	>=	Greater than or equal
---------	----	-----------------------

### Expression

Input  $\neg [A \geq B]$  - Output

### Function

When the input is ON, the data of *A* and the data of *B* are compared, and if *A* is greater than or equal to *B*, the output is turned ON.

### Execution condition

Input	Operation		Output
OFF	No execution		OFF
ON	Execution	$A \geq B$	ON
		$A < B$	OFF

### Operand

	Name	Device						Register									Constant	Index	
		X	Y	R	S	T	C	XW	YW	RW	SW	T	C	D	I	J			K
<i>A</i>	Compared data							√	√	√	√	√	√	√	√	√	√	√	√
<i>B</i>	Reference data							√	√	√	√	√	√	√	√	√	√	√	√

### Example

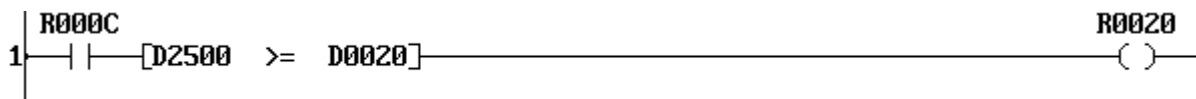

When R00C is ON, the data of D0125 is compared with the data of D0020, and if the data of D0125 is greater than or equal to the data of D0020, R020 is turned ON.

If the data of D0125 is 3000 and that of D0020 is 3000, the comparison result is true. Consequently, R020 is turned ON.

D0125 3000  $\geq$  D0020 3000  $\longrightarrow$  R020 is ON

If the data of D0125 is -1500 and that of D0020 is 0, the comparison result is false. Consequently, R020 is turned OFF.

D0125 -1500  $<$  D0020 0  $\longrightarrow$  R020 is OFF

### Note

- This instruction deals with the data as signed integer (-32768 to 32767).

## 7. Instructions

FUN 098	=	Equal
---------	---	-------

### Expression

Input  $-[A = B]$ - Output

### Function

When the input is ON, the data of  $A$  and the data of  $B$  are compared, and if  $A$  is equal to  $B$ , the output is turned ON.

### Execution condition

Input	Operation		Output
OFF	No execution		OFF
ON	Execution	$A = B$	ON
		$A \neq B$	OFF

### Operand

	Name	Device						Register									Constant	Index	
		X	Y	R	S	T	C	XW	YW	RW	SW	T	C	D	I	J			K
A	Compared data							√	√	√	√	√	√	√	√	√	√	√	√
B	Reference data							√	√	√	√	√	√	√	√	√	√	√	√

### Example

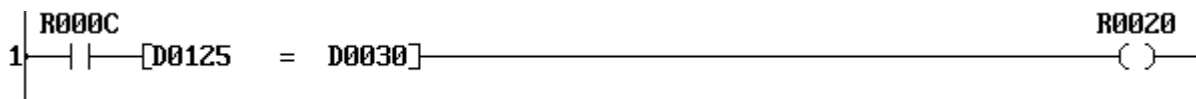

When R00C is ON, the data of D0125 is compared with the data of D0030, and if the data of D0125 is equal to the data of D0030, R020 is turned ON.

If the data of D0125 is 3000 and that of D0020 is 3000, the comparison result is true. Consequently, R020 is turned ON.

D0125  = D0030   $\longrightarrow$  R020 is ON

If the data of D0125 is -1500 and that of D0020 is 0, the comparison result is false. Consequently, R020 is turned OFF.

D0125   $\neq$  D0030   $\longrightarrow$  R020 is OFF

### Note

- This instruction deals with the data as signed integer (-32768 to 32767).



## 7. Instructions

FUN 099	◁ ▷	Not equal
---------	-----	-----------

### Expression

Input  $\neg[A \triangleleft B]$ – Output

### Function

When the input is ON, the data of *A* and the data of *B* are compared, and if *A* is not equal to *B*, the output is turned ON.

### Execution condition

Input	Operation	Output
OFF	No execution	OFF
ON	$A \neq B$	ON
	$A = B$	OFF

### Operand

	Name	Device						Register									Constant	Index	
		X	Y	R	S	T	C	XW	YW	RW	SW	T	C	D	I	J			K
<i>A</i>	Compared data							√	√	√	√	√	√	√	√	√	√	√	√
<i>B</i>	Reference data							√	√	√	√	√	√	√	√	√	√	√	√

### Example

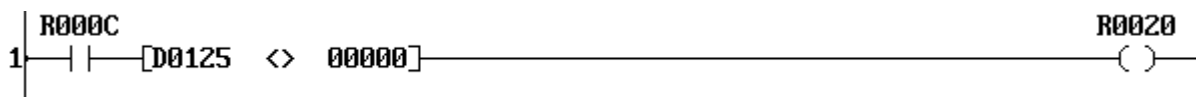

When R00C is ON, the data of D0125 is compared with the constant data 0, and if the data of D0125 is not 0, R020 is turned ON.

If the data of D0125 is 10, the comparison result is true. Consequently, R020 is turned ON.

D0125 10  $\neq$  Constant 0  $\longrightarrow$  R020 is ON

If the data of D0125 is 0, the comparison result is false. Consequently, R020 is turned OFF.

D0125 0  $=$  Constant 0  $\longrightarrow$  R020 is OFF

### Note

- This instruction deals with the data as signed integer (-32768 to 32767).

## 7. Instructions

FUN 100	<	Less than
---------	---	-----------

### Expression

Input  $\neg[A < B]$ – Output

### Function

When the input is ON, the data of *A* and the data of *B* are compared, and if *A* is less than *B*, the output is turned ON.

### Execution condition

Input	Operation		Output
OFF	No execution		OFF
ON	Execution	$A < B$	ON
		$A \geq B$	OFF

### Operand

	Name	Device						Register										Constant	Index
		X	Y	R	S	T	C	XW	YW	RW	SW	T	C	D	I	J	K		
A	Compared data							√	√	√	√	√	√	√	√	√	√	√	√
B	Reference data							√	√	√	√	√	√	√	√	√	√	√	√

### Example

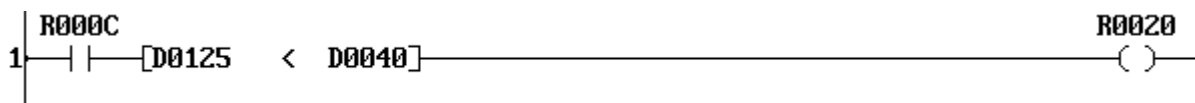

When R00C is ON, the data of D0125 is compared with the data of D0040, and if the data of D0125 is less than the data of D0040, R020 is turned ON.

If the data of D0125 is 10 and that of D0040 is 15, the comparison result is true. Consequently, R020 is turned ON.

D0125  < D0040   $\longrightarrow$  R020 is ON

If the data of D0125 is 0 and that of D0040 is -50, the comparison result is false. Consequently, R020 is turned OFF.

D0125   $\geq$  D0040   $\longrightarrow$  R020 is OFF

### Note

- This instruction deals with the data as signed integer (-32768 to 32767).

## 7. Instructions

FUN 101	<=	Less than or equal
---------	----	--------------------

### Expression

Input  $\neg[A \leq B]$ – Output

### Function

When the input is ON, the data of  $A$  and the data of  $B$  are compared, and if  $A$  is less than or equal to  $B$ , the output is turned ON.

### Execution condition

Input	Operation		Output
OFF	No execution		OFF
ON	Execution	$A \leq B$	ON
		$A > B$	OFF

### Operand

	Name	Device						Register									Constant	Index	
		X	Y	R	S	T	C	XW	YW	RW	SW	T	C	D	I	J			K
$A$	Compared data							√	√	√	√	√	√	√	√	√	√	√	√
$B$	Reference data							√	√	√	√	√	√	√	√	√	√	√	√

### Example



When R00C is ON, the data of D0125 is compared with the constant data -100, and if the data of D0125 is less than or equal to -100, R020 is turned ON.

If the data of D0125 is -150, the comparison result is true. Consequently, R020 is turned ON.

D0125 -150 < Constant -100  $\longrightarrow$  R020 is ON

If the data of D0125 is 0, the comparison result is false. Consequently, R020 is turned OFF.

D0125 0  $\geq$  Constant -100  $\longrightarrow$  R020 is OFF

### Note

- This instruction deals with the data as signed integer (-32768 to 32767).

## 7. Instructions

FUN 102	D>	Double-word greater than
---------	----	--------------------------

### Expression

Input  $-[A+1 \cdot A \text{ D} > B+1 \cdot B]$ – Output

### Function

When the input is ON, the double-word data of  $A+1 \cdot A$  and  $B+1 \cdot B$  are compared, and if  $A+1 \cdot A$  is greater than  $B+1 \cdot B$ , the output is turned ON.

### Execution condition

Input	Operation		Output
OFF	No execution		OFF
ON	Execution	$A+1 \cdot A > B+1 \cdot B$	ON
		$A+1 \cdot A \leq B+1 \cdot B$	OFF

### Operand

	Name	Device						Register								Constant	Index		
		X	Y	R	S	T	C	XW	YW	RW	SW	T	C	D	I			J	K
A	Compared data							√	√	√	√	√	√	√				√	
B	Reference data							√	√	√	√	√	√	√				√	

### Example

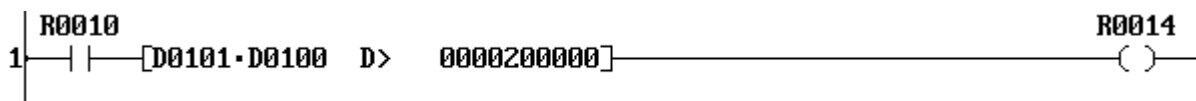

When R010 is ON, the data of D0101-D0100 is compared with the constant data 200000, and if the data of D0101-D0100 is greater than 200000, R014 is turned ON.

If the data of D0101-D0100 is 250000, the comparison result is true. Consequently, R014 is turned ON.

D0101-D0100  > Constant  → R014 is ON

If the data of D0101-D0100 is -100, the comparison result is false. Consequently, R014 is turned OFF.

D0101-D0100  ≤ Constant  → R014 is OFF

### Note

- This instruction deals with the data as double-word integer (-2147483648 to 2147483647).

## 7. Instructions

FUN 103	D>=	Double-word greater than or equal
---------	-----	-----------------------------------

### Expression

Input  $-[A+1 \cdot A \text{ D}>= B+1 \cdot B]$ – Output

### Function

When the input is ON, the double-word data of  $A+1 \cdot A$  and  $B+1 \cdot B$  are compared, and if  $A+1 \cdot A$  is greater than or equal to  $B+1 \cdot B$ , the output is turned ON.

### Execution condition

Input	Operation	Output
OFF	No execution	OFF
ON	Execution	
	$A+1 \cdot A \geq B+1 \cdot B$	ON
	$A+1 \cdot A < B+1 \cdot B$	OFF

### Operand

	Name	Device						Register								Constant	Index		
		X	Y	R	S	T	C	XW	YW	RW	SW	T	C	D	I			J	K
A	Compared data							√	√	√	√	√	√	√				√	
B	Reference data							√	√	√	√	√	√	√				√	

### Example

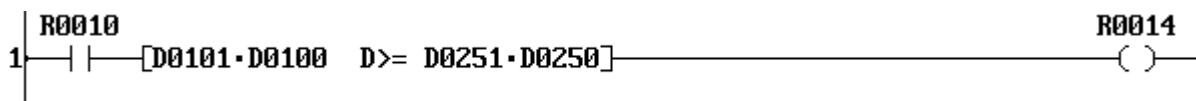

When R010 is ON, the double-word data of D0101·D0100 is compared with the double-word data of D0251·D0250, and if the data of D0101·D0100 is greater than or equal to the data of D0251·D0250, R014 is turned ON.

If the data of D0101·D0100 is 250000 and D0251·D0250 is 200000, R014 is turned ON.

D0101·D0100 250000  $\geq$  D0251·D0250 200000  $\longrightarrow$  R014 is ON

If the data of D0101·D0100 is -100 and D0251·D0250 is 0, R014 is turned OFF.

D0101·D0100 -100  $<$  D0251·D0250 0  $\longrightarrow$  R014 is OFF

### Note

- This instruction deals with the data as double-word integer (-2147483648 to 2147483647).

## 7. Instructions

FUN 104	D=	Double-word equal
---------	----	-------------------

### Expression

Input  $-(A+1 \cdot A = B+1 \cdot B)$  - Output

### Function

When the input is ON, the double-word data of  $A+1 \cdot A$  and  $B+1 \cdot B$  are compared, and if  $A+1 \cdot A$  is equal to  $B+1 \cdot B$ , the output is turned ON.

### Execution condition

Input	Operation		Output
OFF	No execution		OFF
ON	Execution	$A+1 \cdot A = B+1 \cdot B$	ON
		$A+1 \cdot A \neq B+1 \cdot B$	OFF

### Operand

	Name	Device						Register								Constant	Index		
		X	Y	R	S	T	C	XW	YW	RW	SW	T	C	D	I			J	K
A	Compared data							√	√	√	√	√	√	√				√	
B	Reference data							√	√	√	√	√	√	√				√	

### Example

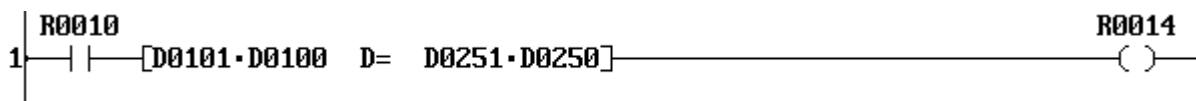

When R010 is ON, the double-word data of D0101·D0100 is compared with the double-word data of D0251·D0250, and if the data of D0101·D0100 is equal to the data of D0251·D0250, R014 is turned ON.

If the data of D0101·D0100 is 250000 and D0251·D0250 is 250000, R014 is turned ON.

D0101·D0100  = D0251·D0250  → R014 is ON

If the data of D0101·D0100 is -100 and D0251·D0250 is 0, R014 is turned OFF.

D0101·D0100  ≠ D0251·D0250  → R014 is OFF

### Note

- This instruction deals with the data as double-word integer (-2147483648 to 2147483647).

## 7. Instructions

FUN 105	D<>	Double-word not equal
---------	-----	-----------------------

### Expression

Input  $-(A+1 \cdot A \text{ D}<> B+1 \cdot B)$  - Output

### Function

When the input is ON, the double-word data of  $A+1 \cdot A$  and  $B+1 \cdot B$  are compared, and if  $A+1 \cdot A$  is not equal to  $B+1 \cdot B$ , the output is turned ON.

### Execution condition

Input	Operation	Output
OFF	No execution	OFF
ON	Execution	$A+1 \cdot A \neq B+1 \cdot B$
		$A+1 \cdot A = B+1 \cdot B$
		ON
		OFF

### Operand

	Name	Device						Register								Constant	Index		
		X	Y	R	S	T	C	XW	YW	RW	SW	T	C	D	I			J	K
A	Compared data							√	√	√	√	√	√	√				√	
B	Reference data							√	√	√	√	√	√	√				√	

### Example

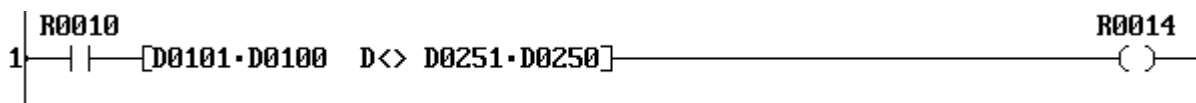

When R010 is ON, the double-word data of D0101·D0100 is compared with the double-word data of D0251·D0250, and if the data of D0101·D0100 is not equal to the data of D0251·D0250, R014 is turned ON.

If the data of D0101·D0100 is 250000 and D0251·D0250 is 200000, R014 is turned ON.

D0101·D0100 250000  $\neq$  D0251·D0250 250000  $\longrightarrow$  R014 is ON

If the data of D0101·D0100 is -100 and D0251·D0250 is -100, R014 is turned OFF.

D0101·D0100 -100  $=$  D0251·D0250 -100  $\longrightarrow$  R014 is OFF

### Note

- This instruction deals with the data as double-word integer (-2147483648 to 2147483647).

## 7. Instructions

FUN 106	D<	Double-word less than
---------	----	-----------------------

### Expression

Input  $-[A+1 \cdot A \text{ D} < B+1 \cdot B]$ – Output

### Function

When the input is ON, the double-word data of  $A+1 \cdot A$  and  $B+1 \cdot B$  are compared, and if  $A+1 \cdot A$  is less than  $B+1 \cdot B$ , the output is turned ON.

### Execution condition

Input	Operation		Output
OFF	No execution		OFF
ON	Execution	$A+1 \cdot A < B+1 \cdot B$	ON
		$A+1 \cdot A \geq B+1 \cdot B$	OFF

### Operand

	Name	Device						Register								Constant	Index		
		X	Y	R	S	T	C	XW	YW	RW	SW	T	C	D	I			J	K
A	Compared data							√	√	√	√	√	√	√				√	
B	Reference data							√	√	√	√	√	√	√				√	

### Example

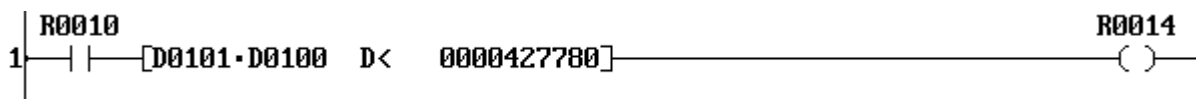

When R010 is ON, the data of D0101·D0100 is compared with the constant data 427780, and if the data of D0101·D0100 is less than 427780, R014 is turned ON.

If the data of D0101·D0100 is 250000, R014 is turned ON.

D0101·D0100  < Constant  → R014 is ON

If the data of D0101·D0100 is 430000, R014 is turned OFF.

D0101·D0100  ≥ Constant  → R014 is OFF

### Note

- This instruction deals with the data as double-word integer (-2147483648 to 2147483647).



## 7. Instructions

FUN 107	D<=	Double-word less than or equal
---------	-----	--------------------------------

### Expression

Input  $-(A+1 \cdot A \text{ D} \leq B+1 \cdot B)$  - Output

### Function

When the input is ON, the double-word data of  $A+1 \cdot A$  and  $B+1 \cdot B$  are compared, and if  $A+1 \cdot A$  is less than or equal to  $B+1 \cdot B$ , the output is turned ON.

### Execution condition

Input	Operation	Output
OFF	No execution	OFF
ON	Execution	$A+1 \cdot A \leq B+1 \cdot B$
		$A+1 \cdot A > B+1 \cdot B$

### Operand

	Name	Device						Register								Constant	Index		
		X	Y	R	S	T	C	XW	YW	RW	SW	T	C	D	I			J	K
A	Compared data							√	√	√	√	√	√	√				√	
B	Reference data							√	√	√	√	√	√	√				√	

### Example

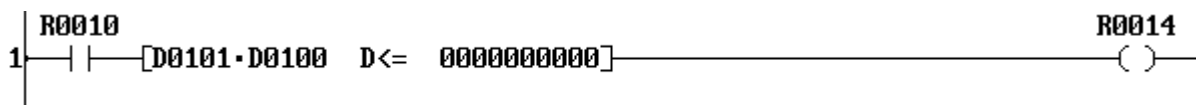

When R010 is ON, the data of D0101·D0100 is compared with the constant data 0, and if the data of D0101·D0100 is less than or equal to 0, R014 is turned ON.

If the data of D0101·D0100 is -1, R014 is turned ON.

D0101·D0100 -1 ≤ Constant 0 → R014 is ON

If the data of D0101·D0100 is 10000, R014 is turned OFF.

D0101·D0100 10000 > Constant 0 → R014 is OFF

### Note

- This instruction deals with the data as double-word integer (-2147483648 to 2147483647).

## 7. Instructions

FUN 108	U>	Unsigned greater than	T1S only
---------	----	-----------------------	----------

### Expression

Input  $-[A \text{ U} > B]$ - Output

### Function

When the input is ON, the data of  $A$  and the data of  $B$  are compared, and if  $A$  is greater than  $B$ , the output is turned ON.

### Execution condition

Input	Operation		Output
OFF	No execution		OFF
ON	Execution	$A > B$	ON
		$A \leq B$	OFF

### Operand

	Name	Device						Register								Constant	Index		
		X	Y	R	S	T	C	XW	YW	RW	SW	T	C	D	I			J	K
A	Compared data							√	√	√	√	√	√	√	√	√	√	√	√
B	Reference data							√	√	√	√	√	√	√	√	√	√	√	√

### Example

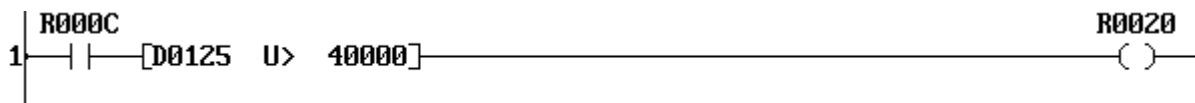

When R00C is ON, the data of D0125 is compared with the constant data 40000, and if the data of D0125 is greater than 40000, R020 is turned ON.

If the data of D0125 is 52000, the comparison result is true. Consequently, R020 is turned ON.

D0125  > Constant  → R020 is ON

If the data of D0125 is 21000, the comparison result is false. Consequently, R020 is turned OFF.

D0125  ≤ Constant  → R020 is OFF

### Note

- This instruction deals with the data as unsigned integer (0 to 65535).

## 7. Instructions

FUN 109	U>=	Unsigned greater than or equal	T1S only
---------	-----	--------------------------------	----------

### Expression

Input  $-[ A \geq B ]$ - Output

### Function

When the input is ON, the data of *A* and the data of *B* are compared, and if *A* is greater than or equal to *B*, the output is turned ON.

### Execution condition

Input	Operation		Output
OFF	No execution		OFF
ON	Execution	$A \geq B$	ON
		$A < B$	OFF

### Operand

	Name	Device						Register									Constant	Index	
		X	Y	R	S	T	C	XW	YW	RW	SW	T	C	D	I	J			K
A	Compared data							√	√	√	√	√	√	√	√	√	√	√	√
B	Reference data							√	√	√	√	√	√	√	√	√	√	√	√

### Example

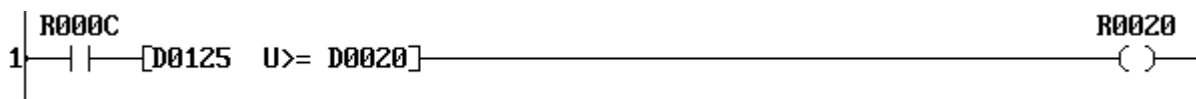

When R00C is ON, the data of D0125 is compared with the data of D0020, and if the data of D0125 is greater than or equal to the data of D0020, R020 is turned ON.

If the data of D0125 is 40000 and that of D0020 is 40000, the comparison result is true. Consequently, R020 is turned ON.

D0125 40000  $\geq$  D0020 40000  $\longrightarrow$  R020 is ON

If the data of D0125 is 15000 and that of D0020 is 20000, the comparison result is false. Consequently, R020 is turned OFF.

D0125 15000  $<$  D0020 20000  $\longrightarrow$  R020 is OFF

### Note

- This instruction deals with the data as unsigned integer (0 to 65535).

## 7. Instructions

FUN 110	U=	Unsigned equal	T1S only
---------	----	----------------	----------

### Expression

Input  $\neg[A \text{ U= } B]$ – Output

### Function

When the input is ON, the data of *A* and the data of *B* are compared, and if *A* is equal to *B*, the output is turned ON.

### Execution condition

Input	Operation		Output
OFF	No execution		OFF
ON	Execution	$A = B$	ON
		$A \neq B$	OFF

### Operand

	Name	Device						Register									Constant	Index	
		X	Y	R	S	T	C	XW	YW	RW	SW	T	C	D	I	J			K
A	Compared data							√	√	√	√	√	√	√	√	√	√	√	√
B	Reference data							√	√	√	√	√	√	√	√	√	√	√	√

### Example



When R00C is ON, the data of D0125 is compared with the data of D0030, and if the data of D0125 is equal to the data of D0030, R020 is turned ON.

If the data of D0125 is 35000 and that of D0020 is 35000, the comparison result is true. Consequently, R020 is turned ON.

D0125 35000 = D0030 35000  $\longrightarrow$  R020 is ON

If the data of D0125 is 1500 and that of D0020 is 4000, the comparison result is false. Consequently, R020 is turned OFF.

D0125 1500  $\neq$  D0030 4000  $\longrightarrow$  R020 is OFF

### Note

- This instruction deals with the data as unsigned integer (0 to 65535).

## 7. Instructions

FUN 111	U<>	Unsigned not equal	T1S only
---------	-----	--------------------	----------

### Expression

Input  $-[A \text{ U}<> B]$ - Output

### Function

When the input is ON, the data of  $A$  and the data of  $B$  are compared, and if  $A$  is not equal to  $B$ , the output is turned ON.

### Execution condition

Input	Operation		Output
OFF	No execution		OFF
ON	Execution	$A \neq B$	ON
		$A = B$	OFF

### Operand

	Name	Device						Register								Constant	Index		
		X	Y	R	S	T	C	XW	YW	RW	SW	T	C	D	I			J	K
$A$	Compared data							√	√	√	√	√	√	√	√	√	√	√	√
$B$	Reference data							√	√	√	√	√	√	√	√	√	√	√	√

### Example

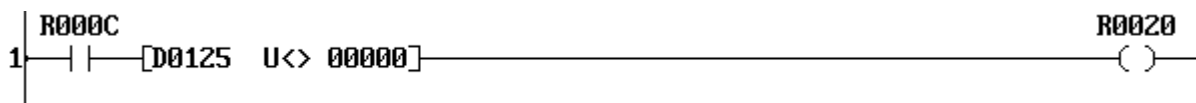

When R00C is ON, the data of D0125 is compared with the constant data 0, and if the data of D0125 is not 0, R020 is turned ON.

If the data of D0125 is 41000, the comparison result is true. Consequently, R020 is turned ON.

D0125 41000  $\neq$  Constant 0  $\longrightarrow$  R020 is ON

If the data of D0125 is 0, the comparison result is false. Consequently, R020 is turned OFF.

D0125 0  $=$  Constant 0  $\longrightarrow$  R020 is OFF

### Note

- This instruction deals with the data as unsigned integer (0 to 65535).

## 7. Instructions

FUN 112	U<	Unsigned less than	T1S only
---------	----	--------------------	----------

### Expression

Input  $\neg[A \text{ U} < B]$ – Output

### Function

When the input is ON, the data of *A* and the data of *B* are compared, and if *A* is less than *B*, the output is turned ON.

### Execution condition

Input	Operation		Output
OFF	No execution		OFF
ON	Execution	$A < B$	ON
		$A \geq B$	OFF

### Operand

	Name	Device						Register									Constant	Index	
		X	Y	R	S	T	C	XW	YW	RW	SW	T	C	D	I	J			K
A	Compared data							√	√	√	√	√	√	√	√	√	√	√	√
B	Reference data							√	√	√	√	√	√	√	√	√	√	√	√

### Example

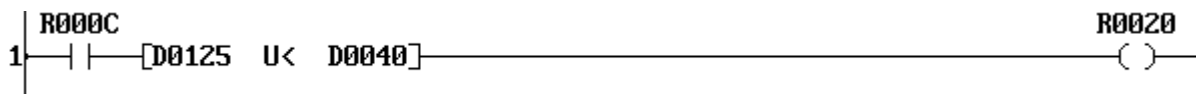

When R00C is ON, the data of D0125 is compared with the data of D0040, and if the data of D0125 is less than the data of D0040, R020 is turned ON.

If the data of D0125 is 43000 and that of D0040 is 45000, the comparison result is true. Consequently, R020 is turned ON.

D0125 43000 < D0040 45000  $\longrightarrow$  R020 is ON

If the data of D0125 is 50000 and that of D0040 is 50000, the comparison result is false. Consequently, R020 is turned OFF.

D0125 50000  $\geq$  D0040 50000  $\longrightarrow$  R020 is OFF

### Note

- This instruction deals with the data as unsigned integer (0 to 65535).

## 7. Instructions

FUN 113	U<=	Unsigned less than or equal	T1S only
---------	-----	-----------------------------	----------

### Expression

Input  $\neg[A \text{ U} \leq B]$  - Output

### Function

When the input is ON, the data of  $A$  and the data of  $B$  are compared, and if  $A$  is less than or equal to  $B$ , the output is turned ON.

### Execution condition

Input	Operation		Output
OFF	No execution		OFF
ON	Execution	$A \leq B$	ON
		$A > B$	OFF

### Operand

	Name	Device						Register									Constant	Index	
		X	Y	R	S	T	C	XW	YW	RW	SW	T	C	D	I	J			K
$A$	Compared data							√	√	√	√	√	√	√	√	√	√	√	√
$B$	Reference data							√	√	√	√	√	√	√	√	√	√	√	√

### Example



When R00C is ON, the data of D0125 is compared with the constant data 35000, and if the data of D0125 is less than or equal to 35000, R020 is turned ON.

If the data of D0125 is 35000, the comparison result is true. Consequently, R020 is turned ON.

D0125 35000 ≤ Constant 35000 → R020 is ON

If the data of D0125 is 0, the comparison result is false. Consequently, R020 is turned OFF.

D0125 38000 > Constant 35000 → R020 is OFF

### Note

- This instruction deals with the data as unsigned integer (0 to 65535).

## 7. Instructions

FUN 114	SET	Device/register set
---------	-----	---------------------

### Expression

Input  $\neg$ [ SET A]- Output

### Function

When the input is ON, the device A is set to ON if A is a device, or the data HFFFF is stored in the register A if A is a register.

### Execution condition

Input	Operation	Output
OFF	No execution	OFF
ON	Execution	ON

### Operand

	Name	Device						Register								Constant	Index	
		X	Y	R	S	T	C	XW	YW	RW	SW	T	C	D	I			J
A	Device or register		√	√	√				√	√	√	√	√	√	√	√		

### Example 1 (device set)

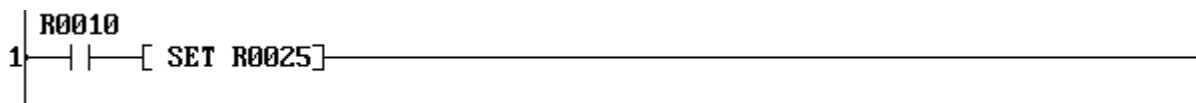

When R010 is ON, R025 is set to ON. The state of R025 is remained even if R010 comes OFF.

### Example 2 (register set)

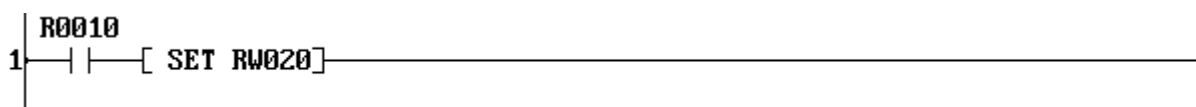

When R010 is ON, the data HFFFF is stored in RW20. (R200 to R20F are set to ON)  
The state of RW20 is remained even if R010 comes OFF.



## 7. Instructions

FUN 115	RST	Device/register reset
---------	-----	-----------------------

### Expression

Input  $\neg$ [ RST A ]- Output

### Function

When the input is ON, the device *A* is reset to OFF if *A* is a device, or the data 0 is stored in the register *A* if *A* is a register.

### Execution condition

Input	Operation	Output
OFF	No execution	OFF
ON	Execution	ON

### Operand

	Name	Device						Register								Constant	Index		
		X	Y	R	S	T	C	XW	YW	RW	SW	T	C	D	I			J	K
A	Device or register		√	√	√				√	√	√	√	√	√	√	√	√		

### Example 1 (device reset)

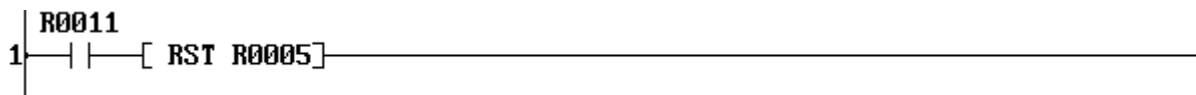

When R011 is ON, R005 is reset to OFF. The state of R025 is remained even if R011 comes OFF.

### Example 2 (register reset)

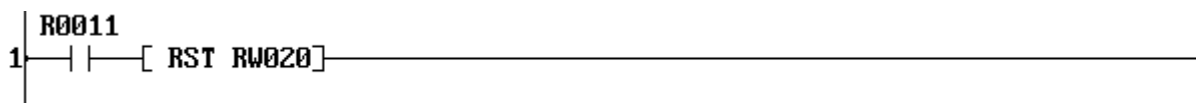

When R011 is ON, the data 0 is stored in RW20. (R200 to R20F are reset to OFF)  
The state of RW20 is remained even if R011 comes OFF.

## 7. Instructions

FUN 118	SETC	Set carry
---------	------	-----------

### Expression

Input  $\neg$ [ SETC ]- Output

### Function

When the input is ON, the carry flag (CF = S050) is set to ON.

### Execution condition

Input	Operation	Output	CF
OFF	No execution	OFF	-
ON	Execution	ON	Set

### Operand

No operand is required.

### Example

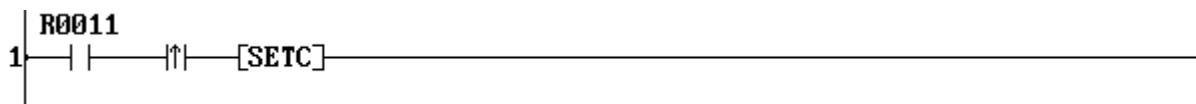

When R011 is changed from OFF to ON, the carry flag S050 is set to ON.

## 7. Instructions

FUN 119	RSTC	Reset carry
---------	------	-------------

### Expression

Input  $\neg$ [ RSTC ]- Output

### Function

When the input is ON, the carry flag (CF = S050) is reset to OFF.

### Execution condition

Input	Operation	Output	CF
OFF	No execution	OFF	-
ON	Execution	ON	Reset

### Operand

No operand is required.

### Example

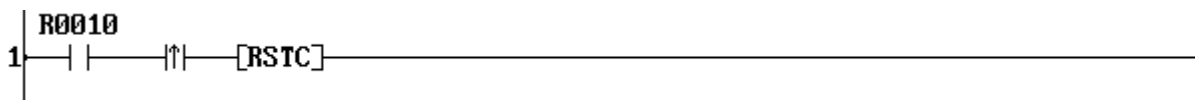

When R010 is changed from OFF to ON, the carry flag S050 is reset to OFF.

## 7. Instructions

FUN 120	ENC	Encode
---------	-----	--------

### Expression

Input  $\text{--[ A ENC (n) B ]}$ – Output

### Function

When the input is ON, this instruction finds the bit position of the most significant ON bit in the bit table, size  $2^n$  bits starting with 0 bit (LSB) of A, and stores it in B.

### Execution condition

Input	Operation	Output	ERF
OFF	No execution	OFF	–
ON	Normal execution	ON	–
	There is no ON bit (no execution)	OFF	Set

### Operand

	Name	Device						Register								Constant	Index			
		X	Y	R	S	T	C	XW	YW	RW	SW	T	C	D	I			J	K	
A	Start of table							√	√	√	√	√	√	√						
n	Table size																		1 - 8	
B	Encode result								√	√	√	√	√	√	√	√	√			

### Example

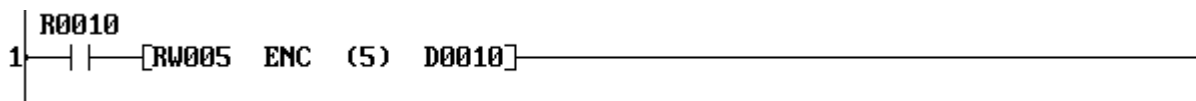

$2^5$  (=32) bits starting with 0 bit of RW05 (R050 to R06F) are defined as the bit table. When R010 is ON, the most significant ON (1) bit position in the bit table is searched, and the position is stored in D0010.

The following figure shows an operation example.

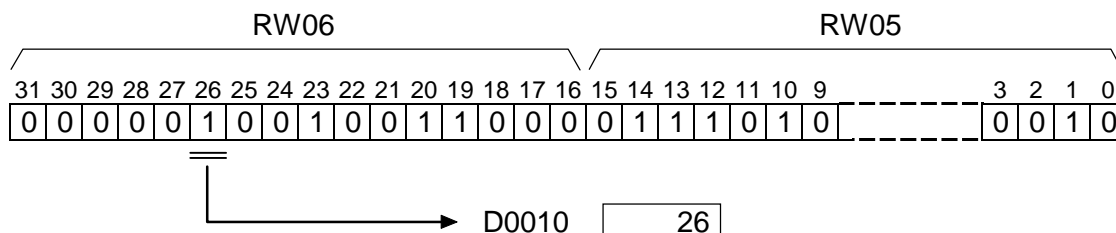

### Note

- If there is no ON bit in the bit table, the instruction error flag (ERF = S051) is set to ON.

## 7. Instructions

FUN 121	DEC	Decode
---------	-----	--------

### Expression

Input  $\text{--[ A DEC (n) B ]}$ – Output

### Function

When the input is ON, this instruction sets the bit position which is designated by lower  $n$  bits of  $A$  to ON in the bit table, size  $2^n$  bits starting with 0 bit (LSB) of  $B$ , and resets all other bits to OFF.

### Execution condition

Input	Operation	Output
OFF	No execution	OFF
ON	Execution	ON

### Operand

	Name	Device						Register								Constant	Index	
		X	Y	R	S	T	C	XW	YW	RW	SW	T	C	D	I			J
$A$	Decode source							√	√	√	√	√	√	√	√	√		
$n$	Table size																1 - 8	
$B$	Start of table								√	√	√	√	√	√				

### Example



$2^5 (=32)$  bits starting with 0 bit of RW05 (R050 to R06F) are defined as the bit table. When R011 is ON, the bit position designated by lower 5 bits of D0011 in the bit table is set to ON, and all other bits in the table are reset to OFF. The following figure shows an operation example.

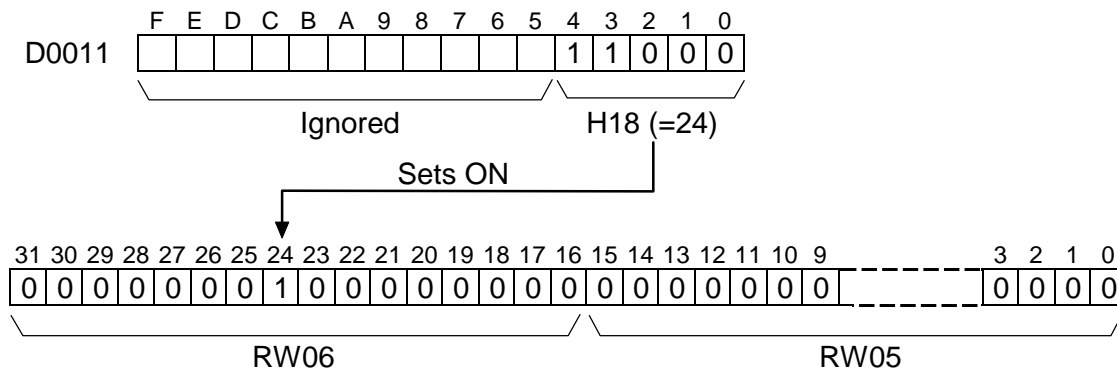

## 7. Instructions

FUN 122	BC	Bit count	T1S only
---------	----	-----------	----------

### Expression

Input  $\neg[A \text{ BC } B]$ – Output

### Function

When the input is ON, this instruction counts the number of ON (1) bits of *A*, and stores the result in *B*.

### Execution condition

Input	Operation	Output
OFF	No execution	OFF
ON	Execution	ON

### Operand

	Name	Device						Register								Constant	Index		
		X	Y	R	S	T	C	XW	YW	RW	SW	T	C	D	I			J	K
<i>A</i>	Source							√	√	√	√	√	√	√	√	√	√	√	
<i>B</i>	Count data								√	√	√	√	√	√					

### Example

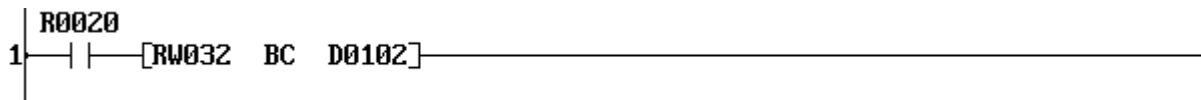

When R020 is ON, the number of ON (1) bits of the register RW032 is counted, and the result is stored in D0102.

The following figure shows an operation example.

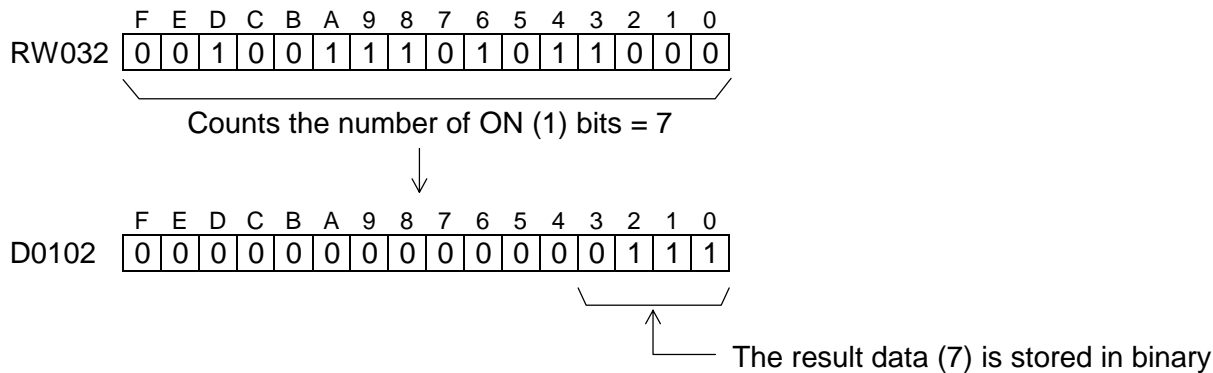

## 7. Instructions

FUN 128	CALL	Subroutine call
---------	------	-----------------

### Expression

Input  $\neg$ [ CALL N. *n* ]- Output

### Function

When the input is ON, this instruction calls the subroutine number *n*.

### Execution condition

Input	Operation	Output
OFF	No execution	OFF
ON	Execution	ON

### Operand

	Name	Device						Register							Constant	Index			
		X	Y	R	S	T	C	XW	YW	RW	SW	T	C	D			I	J	K
<i>n</i>	Subroutine number																	$\surd$ (Note)	

### Example

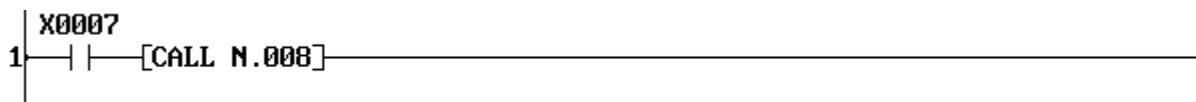

When X007 is ON, the subroutine number 8 is called. When the program execution is returned from the subroutine, the output is turned ON.

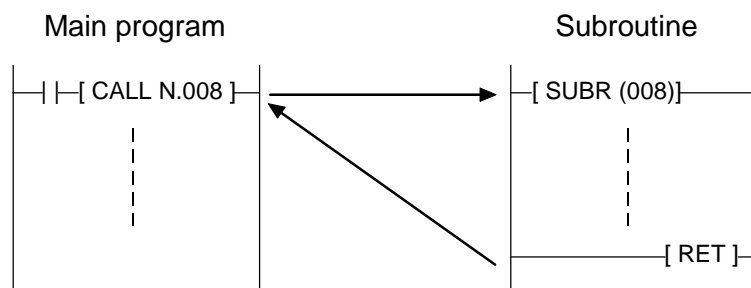

### Note

- The possible subroutine number is 0 to 15 (T1) or 0 to 255 (T1S).
- Refer to the SUBR instruction (FUN 137).
- In case of T1, nesting of subroutines is not allowed. That is, the CALL instruction cannot be used in a subroutine.
- In case of T1S, nesting of subroutines is possible. (up to 3 levels)
- The CALL instruction can be used in an interrupt program. However, it is not allowed that the same subroutine is called from an interrupt program and from main program.

## 7. Instructions

FUN 129	RET	Subroutine return
---------	-----	-------------------

### Expression

|-[ RET ]|

### Function

This instruction indicates the end of a subroutine. When program execution is reached this instruction, it is returned to the original CALL instruction.

### Execution condition

Input	Operation	Output
-	Execution	-

### Operand

No operand is required.

### Example

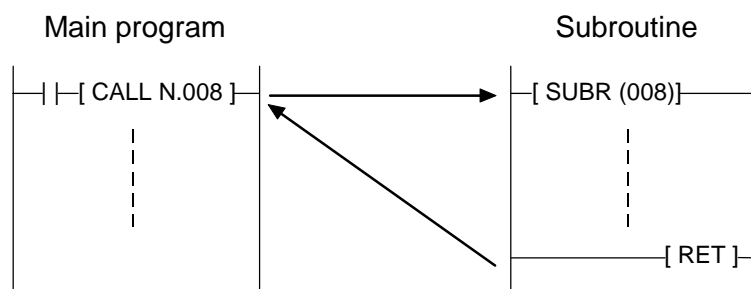
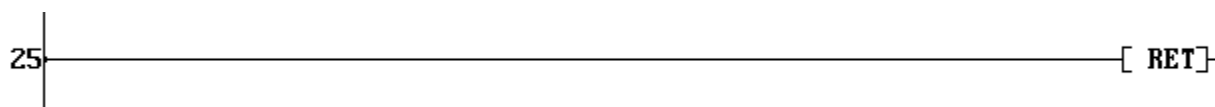

### Note

- Refer to the SUBR instruction (FUN 137).
- The RET instruction can be programmed only in the program type 'Subroutine'.
- The RET instruction must be connected directly to the left power rail.



## 7. Instructions

FUN 132	FOR	FOR (FOR-NEXT loop)
---------	-----	---------------------

### Expression

Input  $\neg$ [FOR  $n$ ]- Output

### Function

When the input is ON, the program segment between FOR and NEXT is executed  $n$  times repeatedly in a scan.

When the input is OFF, the repetition is not performed. (the segment is executed once)

### Execution condition

Input	Operation	Output
OFF	No repetition	OFF
ON	Repetition	ON

### Operand

	Name	Device						Register								Constant	Index		
		X	Y	R	S	T	C	XW	YW	RW	SW	T	C	D	I			J	K
$n$	Repetition times							√	√	√	√	√	√	√	√	√	√	1 - 32767	

### Example

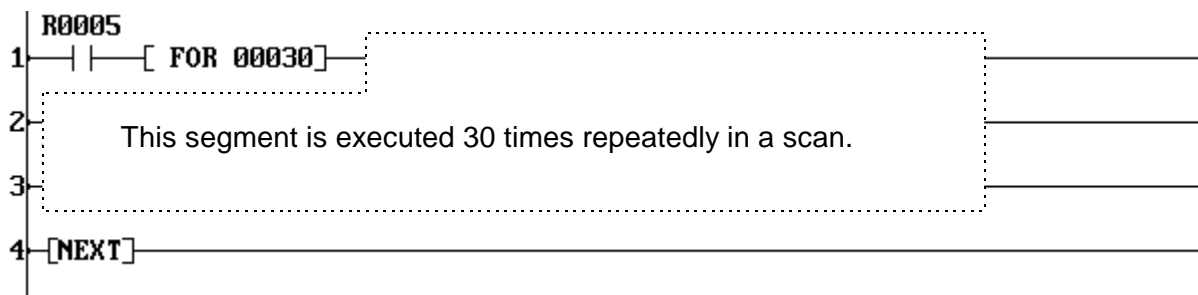

When R005 is ON, the program segment between FOR and NEXT is executed 30 times in a scan.

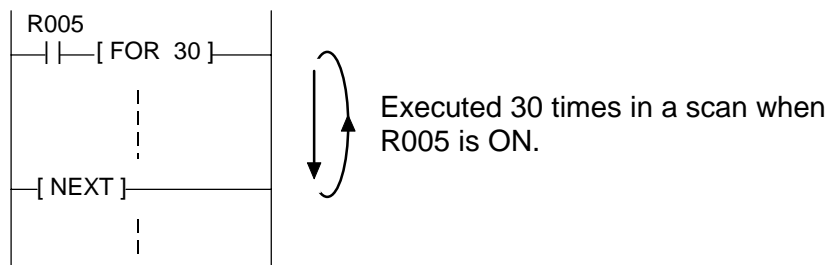

## 7. Instructions

FUN 133	NEXT	NEXT (FOR-NEXT loop)
---------	------	----------------------

### Expression

Input  $\neg$ [ NEXT ] $\neg$  Output

### Function

This instruction configures a FOR-NEXT loop.

If the input is OFF, The repetition is forcibly broken. and the program execution is moved to the next instruction.

### Execution condition

Input	Operation	Output
OFF	Forcibly breaks the repetition	OFF
ON	Repetition	ON

### Operand

No operand is required.

### Example

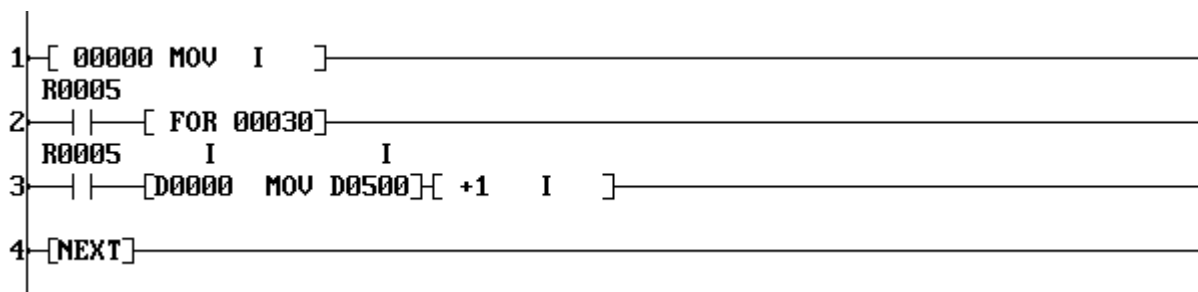

When R005 is ON, the program segment between FOR and NEXT is executed 30 times in a scan. In the above example, the rung 3 is executed 30 times. As a result, the data of D0000 to D0029 are transferred to D0500 to D0529. (Block transfer)

### Note

- The FOR instruction must be used with a corresponding NEXT instruction one by one.
- Nesting of the FOR-NEXT loop is not allowed. That is, the FOR instruction cannot be used in a FOR-NEXT loop.
- The FOR and NEXT instructions cannot be programmed on the same rung.
- The following connection is not allowed.



## 7. Instructions

FUN 137	SUBR	Subroutine entry
---------	------	------------------

### Expression

$\text{--[ SUBR (n) ]--}$

### Function

This instruction indicates the begging of a subroutine.

### Execution condition

Input	Operation	Output
-	Execution	-

### Operand

	Name	Device						Register								Constant	Index		
		X	Y	R	S	T	C	XW	YW	RW	SW	T	C	D	I			J	K
<i>n</i>	Subroutine number																	$\sqrt{\text{(Note)}}$	

### Example

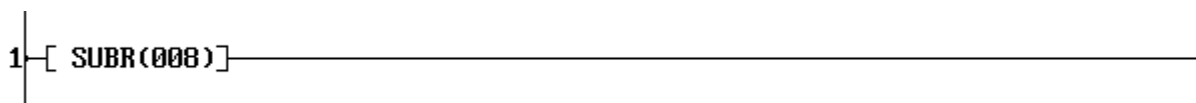

The begging of the subroutine number 8 is indicated.

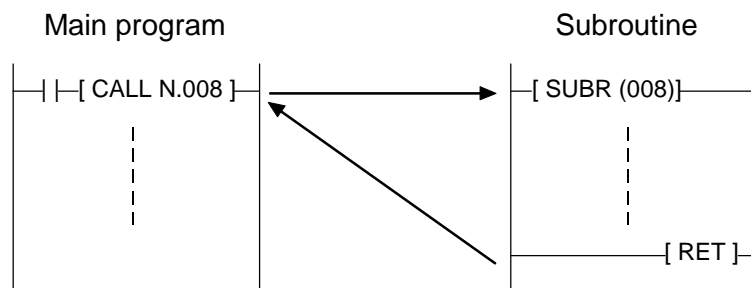

### Note

- The possible subroutine number is 0 to 15 (T1) or 0 to 255 (T1S).
- Refer to the CALL instruction (FUN 128) and the RET instruction (FUN 129).
- The SUBR instruction can be programmed only in the program type 'Subroutine'.
- Nesting of subroutine is not allowed. That is, the CALL instruction cannot be used in a subroutine.
- No other instruction cannot be placed on the rung of the SUBR instruction.

## 7. Instructions

FUN 140	EI	Enable interrupt
---------	----	------------------

### Expression

Input  $-\text{[ EI ]}$ - Output

### Function

When the input is ON, this instruction enables the execution of user designated interrupt operation, i.e. timer interrupt program and I/O interrupt programs.

### Execution condition

Input	Operation	Output
OFF	No execution	OFF
ON	Execution	ON

### Operand

No operand is required.

### Example

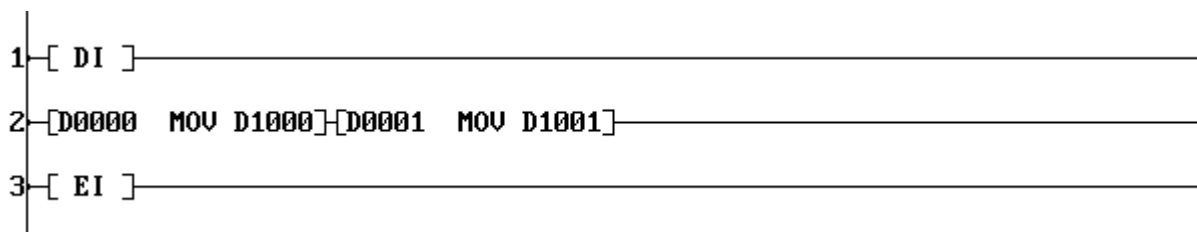

In the above example, the DI instruction disables the interrupt. Then the EI instruction enables the interrupt again. As a result, the rung 2 instructions can be executed without interruption between each instructions.

### Note

- Refer to the DI instruction (FUN 141).
- If an interrupt factor is occurred during the interrupt disabled state, the interrupt is kept waiting and it will be executed just after the EI instruction is executed.
- The EI instruction can be used only in the main program.

## 7. Instructions

FUN 141	DI	Disable interrupt
---------	----	-------------------

### Expression

Input  $\neg$ [ DI ]- Output

### Function

When the input is ON, this instruction disables the execution of user designated interrupt operation, i.e. timer interrupt program and I/O interrupt programs.

### Execution condition

Input	Operation	Output
OFF	No execution	OFF
ON	Execution	ON

### Operand

No operand is required.

### Example

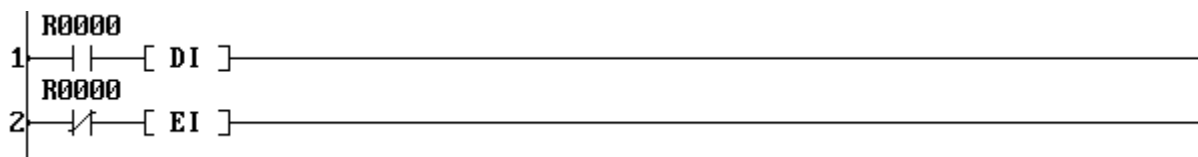

In the above example, the interrupt is disabled when R000 is ON, and it is enabled when R000 is OFF.

### Note

- Refer to the EI instruction (FUN 140).
- If an interrupt factor is occurred during the interrupt disabled state, the interrupt is kept waiting and it will be executed just after the EI instruction is executed.
- The DI instruction can be used only in the main program.

## 7. Instructions

FUN 142	IRET	Interrupt return
---------	------	------------------

### Expression

┌─[ IRET ]─┐

### Function

This instruction indicates the end of an interrupt program. When program execution reaches this instruction, it returns to the original location of the main program (or subroutine).

### Execution condition

Input	Operation	Output
-	Execution	-

### Operand

No operand is required.

### Example

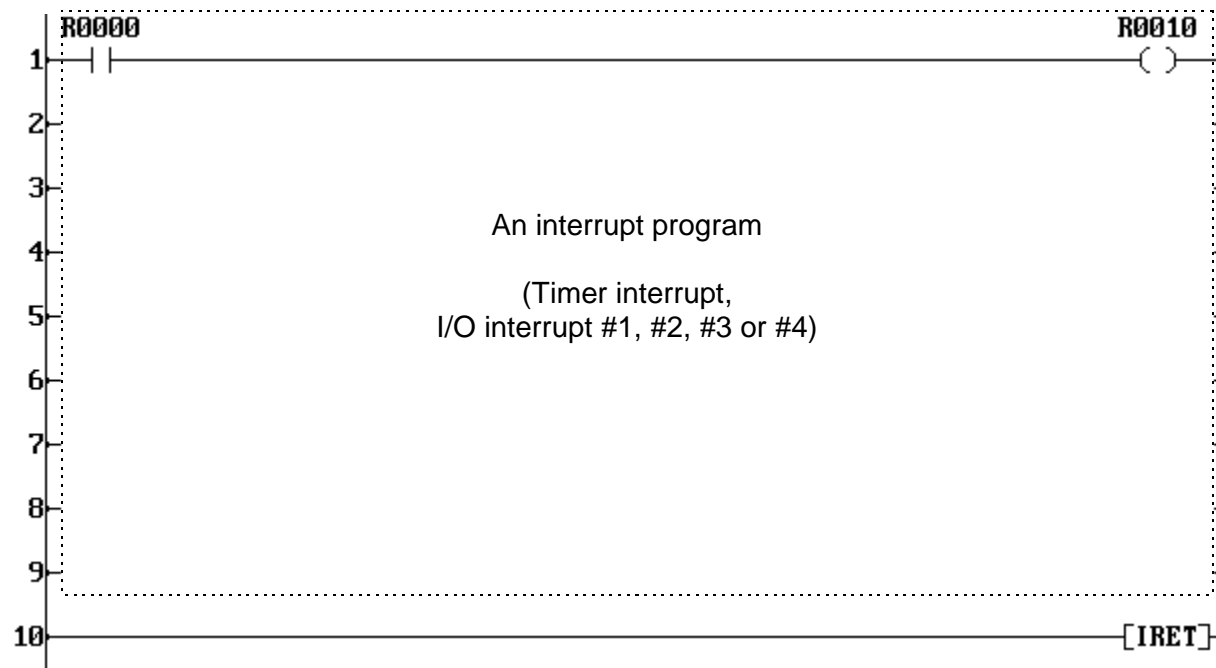

### Note

- The IRET instruction can be used only in an interrupt program.
- There is no specific instruction which indicates the beginning of the interrupt program.

## 7. Instructions

FUN 143	WDT	Watchdog timer reset
---------	-----	----------------------

### Expression

Input  $-\text{[ WDT } n \text{ ]}$ - Output

### Function

When the input is ON, this instruction extend the scan time over detection time by 200 ms. Normally, T1/T1S detects the scan time-over if a scan is not finished within 200 ms. This instruction can be used to extend the detection time.

### Execution condition

Input	Operation	Output
OFF	No execution	OFF
ON	Execution	ON

### Operand

	Name	Device						Register								Constant	Index		
		X	Y	R	S	T	C	XW	YW	RW	SW	T	C	D	I			J	K
$n$	Extend time																	1 - 100	

### Example



When R020 is ON, the scan time detection time is extended by 200 ms. The operand  $n$  has no effect on the extended time. It is fixed as 200 ms.

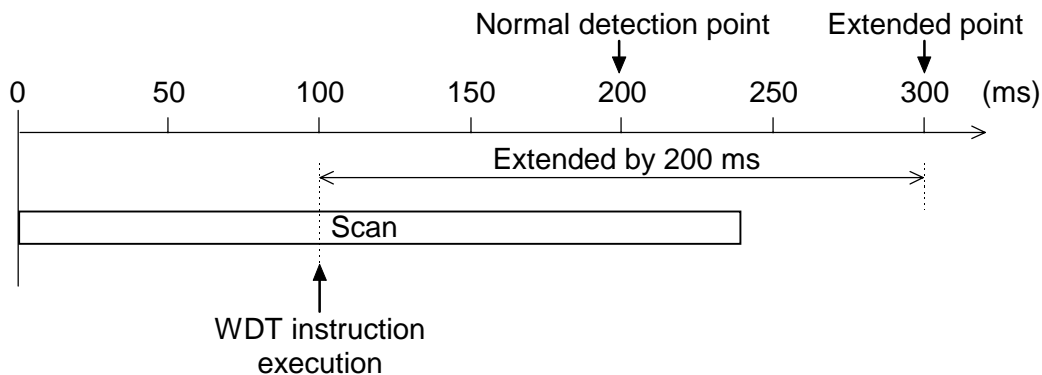

### Note

- As for the upper T-series PLCs, the operand  $n$  specifies the extended time. However in the T1/T1S, it is fixed as 200 ms regardless of the operand  $n$ .

## 7. Instructions

FUN 144	STIZ	Step sequence initialize
---------	------	--------------------------

### Expression

Input  $\neg$ [ STIZ (*n*) A ]- Output

### Function

When the input is ON, *n* devices starting with *A* are reset to OFF, and *A* is set to ON.

This instruction is used to initialize a series of step sequence. The step sequence is useful to describe a sequential operation.

### Execution condition

Input	Operation	Output
OFF	No execution	OFF
ON	Execution at the rising edge of the input	ON

### Operand

	Name	Device						Register							Constant	Index			
		X	Y	R	S	T	C	XW	YW	RW	SW	T	C	D			I	J	K
<i>n</i>	Size of step sequence																	1 - 64	
<i>A</i>	Start device			√															

### Example

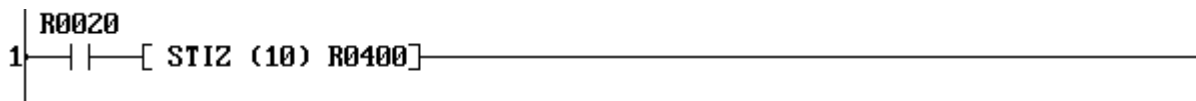

When R020 is changed from OFF to ON, R400 is set to ON and subsequent 9 devices (R401 to R409) are reset to OFF.

This instruction initializes a series of step sequence, 10 devices starting with R400.

R409	R408	R407	R406	R405	R404	R403	R402	R401	R400
OFF	OFF	OFF	OFF	OFF	OFF	OFF	OFF	OFF	ON

10 devices starting with R400

### Note

- The STIZ instruction is used together with STIN (FUN 145) and STOT (FUN 146) instructions to configure the step sequence.
- The STIZ instruction is executed only when the input is changed from OFF to ON.



## 7. Instructions

FUN 145	STIN	Step sequence input
---------	------	---------------------

### Expression

Input  $\neg$ [ STIN A ]- Output

### Function

When the input is ON and the device A is ON, the output is set to ON.

### Execution condition

Input	Operation	Output
OFF	No execution	OFF
ON	When A is ON	ON
	When A is OFF	OFF

### Operand

	Name	Device						Register							Constant	Index			
		X	Y	R	S	T	C	XW	YW	RW	SW	T	C	D			I	J	K
A	Step device			√															

### Example

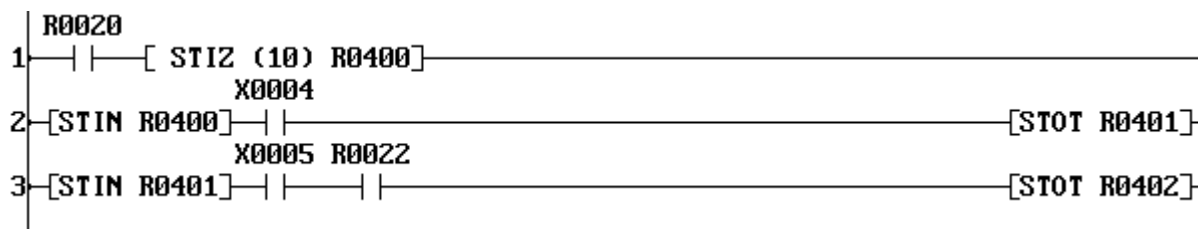

The following sequential operation is performed.

When R020 is changed from OFF to ON, R400 is set to ON and subsequent 9 devices (R401 to R409) are reset to OFF.

When X004 comes ON, R400 is reset to OFF and R401 is set to ON.

When both X005 and R022 are ON, R401 is reset to OFF and R402 is set to ON.

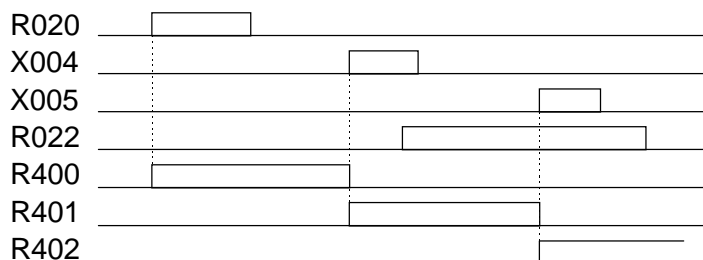

## 7. Instructions

FUN 146	STOT	Step sequence output
---------	------	----------------------

### Expression

Input  $\neg$ [ STOT A ]

### Function

When the input is ON, the device A is set to ON and the devices of STIN instructions on the same rung are reset to OFF.

### Execution condition

Input	Operation	Output
OFF	No execution	-
ON	Execution	-

### Operand

	Name	Device						Register							Constant	Index		
		X	Y	R	S	T	C	XW	YW	RW	SW	T	C	D			I	J
A	Step device			√														

### Example

See example on STIN (FUN 145) instruction.

### Note

- The STIZ, STIN and STOT instructions are used together to configure the step sequence.
- Two or more STOT instructions can be placed on one rung to perform simultaneous sequences.

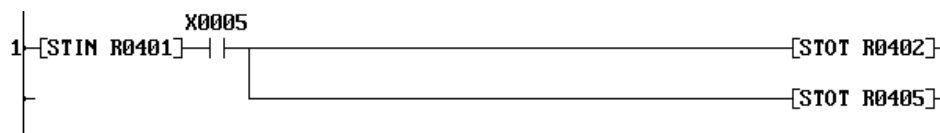

- Two or more STIN instructions can be placed on one rung in parallel or in series to perform loop or convergence of sequences. (Max. 11 STIN instructions on one rung)

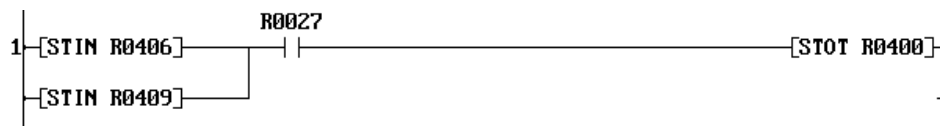

- To perform the conditional branch (sequence selection), separate the rungs as follows. This limitation is applied to T1 version 1.00 only.

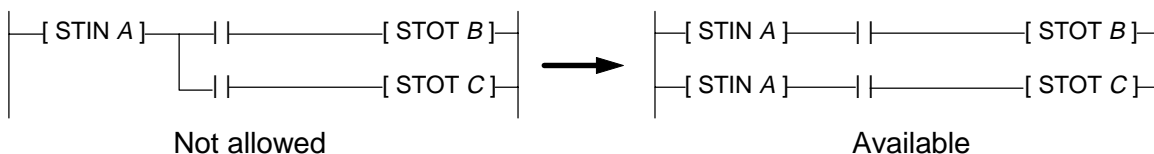

## 7. Instructions

FUN 147	F/F	Flip-flop
---------	-----	-----------

### Expression

Set input	-	S	F/F	Q	-	Output
Reset input	-	R	A			

### Function

When the set input is ON, the device A is set to ON. When the reset input is ON, the device A is reset to OFF. When both the set and reset inputs are OFF, the device A remains the state. If both the set and reset inputs are ON, the device A is reset to OFF.

The state of the output is the same as the device A.

### Execution condition

Set input	Reset input	Operation	Output
OFF	OFF	No execution (A remains previous state)	Same as A
	ON	Resets A to OFF	
ON	OFF	Sets A to ON	
	ON	Resets A to OFF	

### Operand

	Name	Device						Register								Constant	Index		
		X	Y	R	S	T	C	XW	YW	RW	SW	T	C	D	I			J	K
A	Device		√	√	√														

### Example



When X003 is ON, R10E is set to ON. When X004 is ON, R10E is reset to OFF. If both are ON, R10E is reset to OFF.

An example timing diagram is shown below.

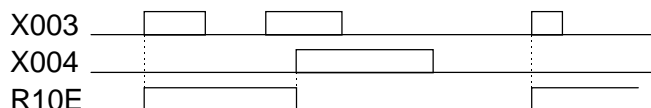

### Note

- For the set input, direct linking to a connecting point is not allowed. In this case, insert a dummy contact (always ON = S04F, etc.) just before the input. Refer to Note of Shift register FUN 074.

## 7. Instructions

FUN 149	U/D	Up-down counter
---------	-----	-----------------

### Expression

Direction input	—[U U/D q]	Output
Count input	—C	
Enable input	—[E A]	

### Function

While the enable input is ON, this instruction counts the number of the count input changes from OFF to ON. The count direction (up count or down count) is selected by the state of the direction input. The count value is stored in the counter register A. The count value range is 0 to 65535.

- Up count when the direction input is ON
- Down count when the direction input is OFF

When the enable input is OFF, the counter register A is cleared to 0.

### Execution condition

Enable input	Operation	Output
OFF	No operation (A is cleared to 0)	OFF
ON	Count value is not limit value (0 or 65535)	OFF
	Count value is limit value and count input is ON	ON

### Operand

	Name	Device						Register							Constant	Index				
		X	Y	R	S	T	C	XW	YW	RW	SW	T	C	D			I	J	K	
A	Count value													√						

### Example

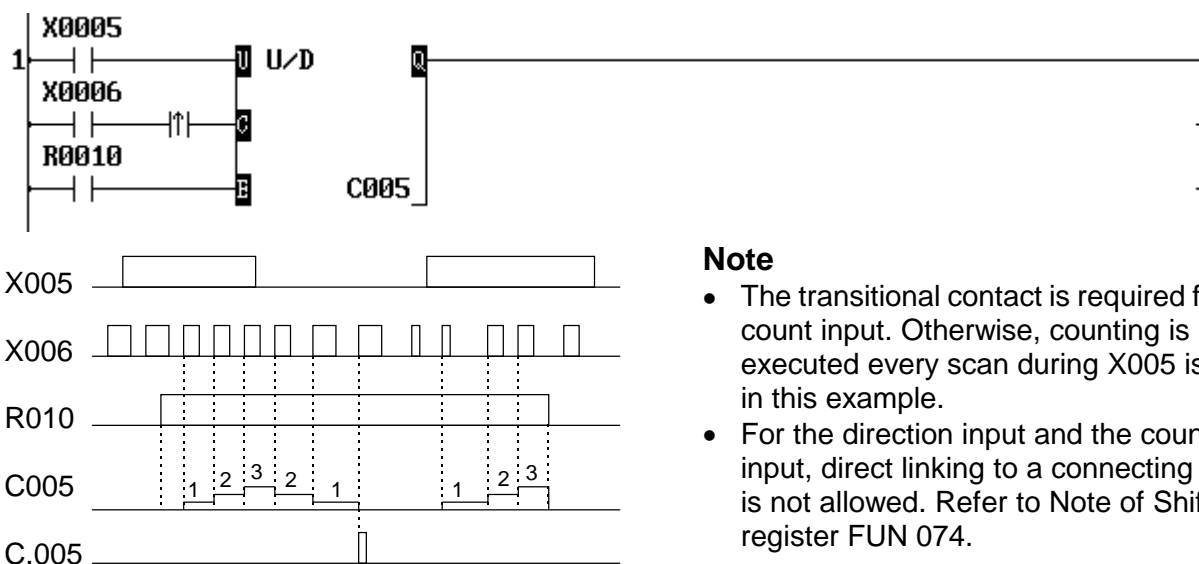

### Note

- The transitional contact is required for the count input. Otherwise, counting is executed every scan during X005 is ON in this example.
- For the direction input and the count input, direct linking to a connecting point is not allowed. Refer to Note of Shift register FUN 074.

## 7. Instructions

FUN 154	CLND	Set calendar
---------	------	--------------

T1S only

### Expression

Input $\neg$ [ A CLND ]- Output
---------------------------------

### Function

When the input is ON, the built-in clock/calendar is set to the date and time specified by 6 registers starting with A. If an invalid data is contained in the registers, the operation is not executed and the output is turned ON.

### Execution condition

Input	Operation	Output
OFF	No operation	OFF
ON	Execution (data is valid)	OFF
	No execution (data is not valid)	ON

### Operand

	Name	Device						Register										Constant	Index	
		X	Y	R	S	T	C	XW	YW	RW	SW	T	C	D	I	J	K			
A	Start of table							√	√	√	√	√	√	√						

### Example

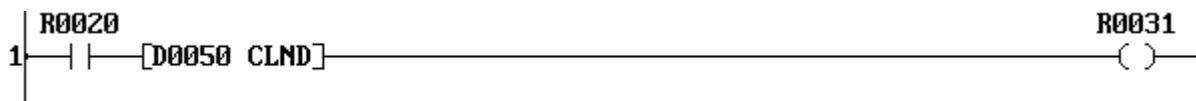

When R020 is ON, the clock/calendar is set according to the data of D0050 to D0055, and the output is OFF (R0031 is OFF).

If D0050 to D0055 contains invalid data, the setting operation is not executed and the output is turned ON (R0031 comes ON).

	F		8	7		0		
D0050		H00				Year	Allowable data range (2-digit BCD) H00 to H99 (1990 - 2089) H01 to H12 H01 to H31 H00 to H23 H00 to H59 H00 to H59	→
D0051		H00			Month			
D0052		H00			Day			
D0053		H00			Hour			
D0054		H00			Minute			
D0055		H00			Second			
		Calendar LSI						

### Note

- The day of the week is automatically.

## 7. Instructions

FUN 155	CLDS	Calendar operation
---------	------	--------------------

T1S only

### Expression

Input  $\text{--[ A CLDS B ]}$ – Output

### Function

When the input is ON, this instruction subtracts the date and time stored in 6 registers starting with *A* from the current date and time, and stores the result in 6 registers starting with *B*.

If an invalid data is contained in the registers, the operation is not executed and the output is turned ON.

### Execution condition

Input	Operation	Output
OFF	No operation	OFF
ON	Execution (data is valid)	OFF
	No execution (data is not valid)	ON

### Operand

	Name	Device						Register								Constant	Index		
		X	Y	R	S	T	C	XW	YW	RW	SW	T	C	D	I			J	K
A	Subtrahend							√	√	√	√	√	√	√					
B	Result								√	√	√	√	√	√					

### Example

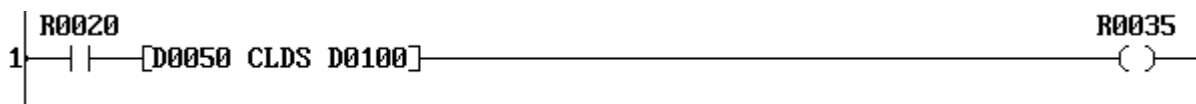

When R020 is ON, the date and time data recorded in D0050 to D0055 are subtracted from the current date and time of clock/calendar, and the result is stored in D0100 to D0105.

In normal operation, the output is OFF (R0035 is OFF). If D0050 to D0055 contains invalid data, the operation is not executed and the output is turned ON (R0035 comes ON).

Current date & time

H0098
H0001
H0015
H0017
H0000
H0000

minus

	F	0
D0050	H0097	
D0051	H0010	
D0052	H0010	
D0053	H0015	
D0054	H0030	
D0055	H0000	



	F	0	
D0100	H0000	(Year)	
D0101	H0003	(Month)	
D0102	H0007	(Day)	
D0103	H0001	(Hour)	
D0104	H0030	(Minute)	
D0105	H0000	(Second)	

### Note

- Future date and time cannot be used as subtrahend *A*.
- In the calculation result, it means that 1 year is 365 days and 1 month is 30 days.

## 7. Instructions

FUN 156	PID3	Pre-derivative real PID
---------	------	-------------------------

### Expression

Input  $-[A \text{ PID3 } B \rightarrow C]$ - Output

### Function

Performs PID (Proportional, Integral, Derivative) control which is a fundamental method of feed-back control. (Pre-derivative real PID algorithm) This PID3 instruction has the following features.

- For derivative action, incomplete derivative is used to suppress interference of high-frequency noise and to expand the stable application range,
- Controllability and stability are enhanced in case of limit operation for MV, by using digital PID algorithm succeeding to benefits of analog PID.
- Auto, cascade and manual modes are supported in this instruction.
- Digital filter is available for PV.
- Direct / reverse operation is selectable.

### Execution condition

Input	Operation	Output
OFF	Initialization	OFF
ON	Execute PID every setting interval	ON when execution

### Operand

	Name	Device							Register									Constant	Index
		X	Y	R	S	T	C	XW	YW	RW	SW	T	C	D	I	J	K		
A	Top of input data							√	√	√	√	√	√	√					
B	Top of parameter							√	√	√	√	√	√	√					
C	Top of output data								√	√	√	√	√	√					

Input data			Control parameter			Output data		
A	Process input value	<b>PVC</b>	B	Proportional gain	<b>K<sub>P</sub></b>	C	Manipulation value	<b>MV</b>
A+1	A-mode set value	<b>ASV</b>	B+1	Integral time	<b>T<sub>I</sub></b>	C+1	Last error	<b>e<sub>n-1</sub></b>
A+2	C-mode set value	<b>CSV</b>	B+2	Derivative time	<b>T<sub>D</sub></b>	C+2	Last derivative value	<b>D<sub>n-1</sub></b>
A+3	M-mode MV input	<b>MMV</b>	B+3	Dead-band	<b>GP</b>	C+3	Last PV	<b>PV<sub>n-1</sub></b>
A+4	MV tracking input	<b>TMV</b>	B+4	A-mode initial SV	<b>ISV</b>	C+4	Last SV	<b>SV<sub>n-1</sub></b>
A+5	Mode setting	<b>MODE</b>	B+5	Input filter constant	<b>FT</b>	C+5	Integral remainder	<b>I<sub>r</sub></b>
			B+6	ASV differential limit	<b>DSV</b>	C+6	Derivative remainder	<b>D<sub>r</sub></b>
			B+7	MMV differential limit	<b>DMMV</b>	C+7	Internal MV	<b>MV<sub>n</sub></b>
			B+8	Initial status	<b>STS</b>	C+8	Internal counter	<b>C</b>
			B+9	MV upper limit	<b>MH</b>	C+9	Control interval	<b>Δt</b>
			B+10	MV lower limit	<b>ML</b>			
			B+11	MV differential limit	<b>DMV</b>			
			B+12	Control interval setting	<b>n</b>			

A-mode: Auto mode  
 C-mode: Cascade mode  
 M-mode: Manual mode

## 7. Instructions

### Control block diagram

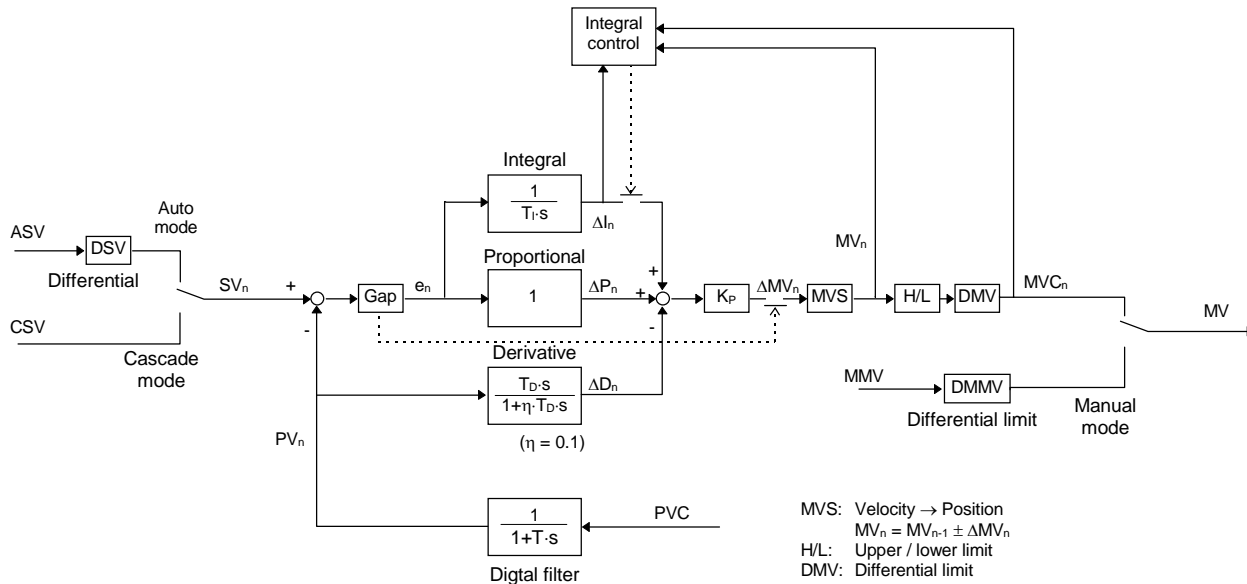

#### Integral action control:

When MV is limited (H/L, DMV) and the integral value has same sign as limit over, integral action is stopped.

#### Velocity $\rightarrow$ Position conversion:

In Direct mode, MV increases when PV is increased.

$$\rightarrow MV_n = MV_{n-1} - \Delta MV_n$$

In Reverse mode, MV decreases when PV is increased.

$$\rightarrow MV_n = MV_{n-1} + \Delta MV_n$$

#### Gap (dead-band) operation:

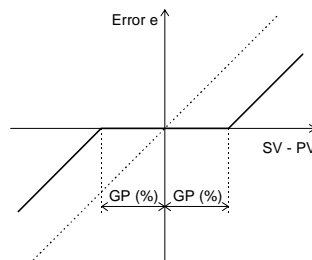

### Algorithm

#### Digital filter:

$$PV_n = (1 - FT) \cdot PVC + FT \cdot PV_{n-1}$$

Here,

$$0.000 \leq FT \leq 0.999$$



## 7. Instructions

PID algorithm:

$$\Delta MV_n = K_P \cdot (\Delta P_n + \Delta I_n + \Delta D_n)$$

$$MV_n = MV_{n-1} \pm \Delta MV_n$$

Here,

$$\Delta P_n = e_n - e_{n-1}$$

$$e_n = SV_n - PV_n \quad (\text{If } GP \neq 0, \text{ Gap is applied})$$

$$\Delta I_n = \frac{e_n \cdot \Delta t + I_r}{T_I} \quad (\text{If } T_I = 0, \text{ then } \Delta I_n = 0)$$

$$\Delta D_n = \frac{T_D \cdot (PV_{n-1} - PV_n) - \Delta t \cdot D_{n-1} + D_r}{\Delta t + \eta \cdot T_D}$$

$$D_n = D_{n-1} + \Delta D_n$$

$$\eta = 0.1 \quad (\text{Fixed})$$

### Parameter details

A	Process input value PVC (0.00 to 100.00 %)	Data range: 0 to 10000
A+1	Auto mode set value ASV (0.00 to 100.00 %)	Data range: 0 to 10000
A+2	Cascade mode set value CSV (0.00 to 100.00 %)	Data range: 0 to 10000
A+3	Manual mode MV MMV (-25.00 to 125.00 %)	Data range: -2500 to 12500
A+4	MV tracking input TMV (-25.00 to 125.00 %)	Data range: -2500 to 12500
A+5	Mode setting MODE	

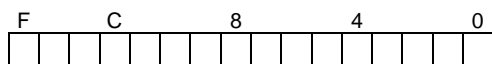

Operation mode  
 00 : Manual mode  
 01 : Auto mode  
 10 : Cascade mode  
 11 : (Reserve)

Tracking designation  
 0 : No  
 1 : Yes

B	Proportional gain $K_P$ (0.00 to 327.67)	Data range: 0 to 32767
B+1	Integral time $T_I$ (0.000 to 32.767 min., $\Delta I_n=0$ if $T_I=0$ )	Data range: 0 to 32767
B+2	Derivative time $T_D$ (0.000 to 32.767 min.)	Data range: 0 to 32767
B+3	Gap (dead-band) GP (0.00 to 10.00 %)	Data range: 0 to 1000
B+4	Auto mode initial set value ISV (0.00 to 100.00 %)	Data range: 0 to 10000
B+5	Input filter constant FT (0.000 to 0.999)	Data range: 0 to 999
B+6	ASV differential limit DSV (0.00 to 100.00 %/ $\Delta t$ )	Data range: 0 to 10000
B+7	MMV differential limit DMMV (0.00 to 100.00 %/ $\Delta t$ )	Data range: 0 to 10000

## 7. Instructions

*B+8* Initial status STS

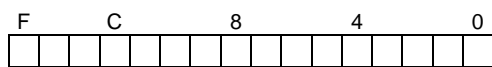

Initial operation mode  
 00 : Manual mode  
 01 : Auto mode  
 10 : Cascade mode  
 11 : (Reserve)

Direct / reverse selection  
 0 : Direct  
 1 : Reverse

<i>B+9</i>	MV upper limit MH (-25.00 to 125.00 %)	Data range: -2500 to 12500
<i>B+10</i>	MV lower limit ML (-25.00 to 125.00 %)	Data range: -2500 to 12500
<i>B+11</i>	MV differential limit DMV (0.00 to 100.00 %/ $\Delta t$ )	Data range: 0 to 10000
<i>B+12</i>	Control interval setting n (1 to 32767 times)	Data range: 1 to 32767

Executes PID every n scan. Therefore, control interval  $\Delta t = n \times \text{constant scan interval}$   
 (It is treated as  $n = 1$  when  $n \leq 0$ )

<i>C</i>	Manipulation value MV (-25.00 to 125.00 %)	Data range: -2500 to 12500
<i>C+1</i>	Internal work area	
:		
:		
<i>C+9</i>		

### Operation

- When the instruction input is OFF:

Initializes the PID3 instruction.

Operation mode is set as specified by *B+8*.

Auto mode SV is set as specified by *B+4*.

Manual mode MV is set as current MV.

Internal calculation data is initialized.

MV remains unchanged.

$A+5$  bit 0, 1  $\leftarrow B+8$  bit 0, 1

ASV  $\leftarrow$  ISV

MMV  $\leftarrow$  MV

- When the instruction input is ON:

Executes PID calculation every n scan which is specified by *B+12*. The following operation modes are available according to the setting of *A+5*.

- Auto mode

This is a normal PID control mode with ASV as set value.

Set value differential limit DSV, manipulation value upper/lower limit MH/ML and differential limit DMV are effective.

Bump-less changing from auto mode to manual mode is available. (Manual mode manipulation value MMV is over-written by current MV automatically. MMV  $\leftarrow$  MV)

## 7. Instructions

- **Manual mode**  
In this mode, the manipulation value MV can be directly controlled by the input value of MMV.  
MV differential limit for manual mode DMMV is effective. MH/ML and DMV are not effective.  
When mode is changed from manual to auto or cascade, the operation is started from the current MV.
- **Cascade mode**  
This is a mode for PID cascade connection. PID is executed with CSV as set value.  
Different from the auto mode, set value differential limit is not effective. Manipulation value upper/lower limit MH/ML and differential limit DMV are effective.  
Bump-less changing from cascade mode to manual mode is available. (Manual mode manipulation value MMV is over-written by current MV automatically.  $MMV \leftarrow MV$ )  
And, bump-less changing from cascade mode to auto mode is available. (Auto mode set value ASV is over-written by current CSV automatically.  $ASV \leftarrow CSV$ )
- **MV tracking**  
This function is available in auto and cascade modes. When the tracking designation (A+5 bit 2) is ON, tracking input TMV is directly output as MV.  
Manipulation value upper/lower limit MH/ML is effective, but differential limit DMV is not effective.  
When the tracking designation is changed to OFF, the operation is started from the current MV.

### Note

- PID3 instruction is only usable on the main-program.
- PID3 instruction must be used under the constant scan mode. The constant scan interval can be selected in the range of 10 to 200 ms, 10 ms increments.
- The data handled by the PID3 instruction are % units. Therefore, process input value PVC, manipulation value MV, etc., should be converted to % units (scaling), before and/or after the PID3 instruction. For this purpose, the function generator instruction (FUN165 FG) is convenient.

## 7. Instructions

FUN 160	UL	Upper limit	T1S only
---------	----	-------------	----------

### Expression

Input  $-[A \text{ UL } B \rightarrow C]-$  Output

### Function

When the input is ON, the following operation is executed. (Upper limit for A by B)

If  $A \leq B$ , then  $C = A$ .

If  $A > B$ , then  $C = B$ .

### Execution condition

Input	Operation	Output
OFF	No operation	OFF
ON	Execution: not limited ( $A \leq B$ )	OFF
	Execution: limited ( $A > B$ )	ON

### Operand

	Name	Device						Register									Constant	Index		
		X	Y	R	S	T	C	XW	YW	RW	SW	T	C	D	I	J			K	
A	Operation data							√	√	√	√	√	√	√	√	√	√	√	√	√
B	Upper limit							√	√	√	√	√	√	√	√	√	√	√	√	√
C	Destination								√	√	√	√	√	√	√	√	√	√		√

### Example

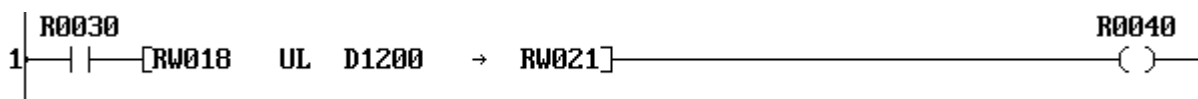

When R030 is ON, the upper limit operation is executed for the data of RW018 by the data of D1200, and the result is stored in RW021.

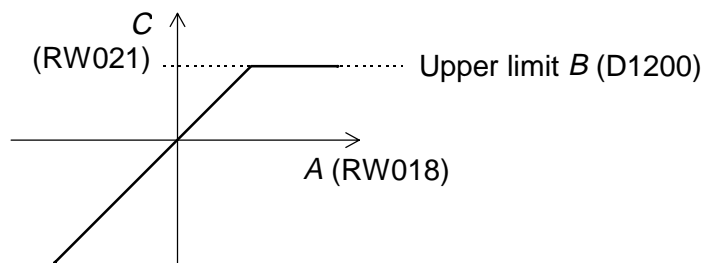

When RW018 is 3000 and D1200 is 4000, 3000 is stored in RW021 and R0040 is OFF.

When RW018 is 4500 and D1200 is 4000, the limit value 4000 is stored in RW021 and R0040 is ON.

### Note

- This instruction deals with the data as signed integer (-32768 to 32767).

## 7. Instructions

FUN 161	LL	Lower limit	T1S only
---------	----	-------------	----------

### Expression

Input  $-[A \text{ LL } B \rightarrow C]$ - Output

### Function

When the input is ON, the following operation is executed. (Lower limit for A by B)

If  $A \geq B$ , then  $C = A$ .

If  $A < B$ , then  $C = B$ .

### Execution condition

Input	Operation	Output
OFF	No operation	OFF
ON	Execution: not limited ( $A \geq B$ )	OFF
	Execution: limited ( $A < B$ )	ON

### Operand

	Name	Device						Register									Constant	Index	
		X	Y	R	S	T	C	XW	YW	RW	SW	T	C	D	I	J			K
A	Operation data							√	√	√	√	√	√	√	√	√	√	√	√
B	Lower limit							√	√	√	√	√	√	√	√	√	√	√	√
C	Destination								√	√	√	√	√	√	√	√	√		√

### Example

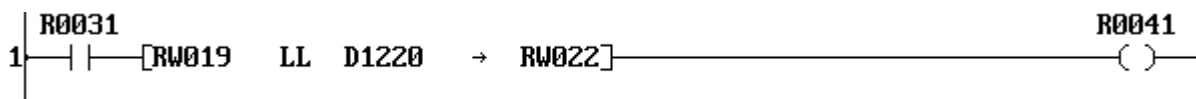

When R031 is ON, the lower limit operation is executed for the data of RW019 by the data of D1220, and the result is stored in RW022.

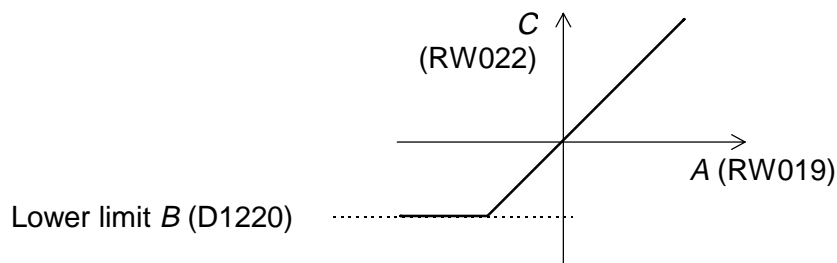

When RW019 is -1000 and D1220 is -1800, -1000 is stored in RW022 and R0041 is OFF.

When RW019 is 800 and D1220 is 1200, the limit value 1200 is stored in RW022 and R0041 is ON.

### Note

- This instruction deals with the data as signed integer (-32768 to 32767).

## 7. Instructions

FUN 162	MAX	Maximum value	T1S only
---------	-----	---------------	----------

### Expression

Input  $-[A \text{ MAX } (n) B]$ – Output

### Function

When the input is ON, this instruction searches for the maximum value from the table of size  $n$  words starting with  $A$ , and stores the maximum value in  $B$  and the pointer indicating the position of the maximum value in  $B+1$ . The allowable range of the table size  $n$  is 1 to 64.

### Execution condition

Input	Operation	Output
OFF	No execution	OFF
ON	Execution	ON

### Operand

	Name	Device						Register								Constant	Index		
		X	Y	R	S	T	C	XW	YW	RW	SW	T	C	D	I			J	K
$A$	Start of table							√	√	√	√	√	√						
$n$	Table size																	1 - 64	
$B$	Result								√	√	√	√	√	√	√	√			

### Example

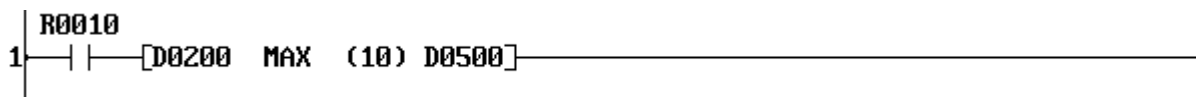

When R010 is ON, the maximum value is found from the register table D0200 to D0209 (10 words), and the maximum value is stored in D0500 and the pointer is stored in D0501.

		Pointer	
D0200	100	0	
D0201	10000	1	
D0202	-1000	2	
D0203	10	3	
D0204	0	4	
D0205	200	5	
D0206	-300	6	
D0207	20000	7	→ D0500
D0208	-30	8	→ D0501
D0209	20	9	

D0500	20000	(Maximum value)
D0501	7	(Pointer)

### Note

- This instruction deals with the data as signed integer (-32768 to 32767).
- If there are two or more maximum value in the table, the lowest pointer is stored.
- If Index register K is used as operand  $B$ , the pointer data is discarded.

## 7. Instructions

FUN 163	MIN	Minimum value
---------	-----	---------------

T1S only

### Expression

Input $\rightarrow [A \text{ MIN } (n) B]$ Output
---

### Function

When the input is ON, this instruction searches for the minimum value from the table of size  $n$  words starting with  $A$ , and stores the minimum value in  $B$  and the pointer indicating the position of the minimum value in  $B+1$ . The allowable range of the table size  $n$  is 1 to 64.

### Execution condition

Input	Operation	Output
OFF	No execution	OFF
ON	Execution	ON

### Operand

	Name	Device						Register								Constant	Index			
		X	Y	R	S	T	C	XW	YW	RW	SW	T	C	D	I			J	K	
$A$	Start of table							√	√	√	√	√	√	√						
$n$	Table size																		1 - 64	
$B$	Result								√	√	√	√	√	√	√	√	√			

### Example

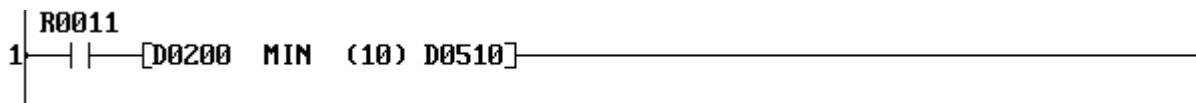

When R011 is ON, the minimum value is found from the register table D0200 to D0209 (10 words), and the minimum value is stored in D0510 and the pointer is stored in D0511.

		Pointer			
D0200	100	0			
D0201	10000	1			
D0202	-1000	2	→		
D0203	10	3			
D0204	0	4			
D0205	200	5			
D0206	-300	6			
D0207	20000	7			
D0208	-30	8			
D0209	20	9			
				D0510	-1000
				D0511	2
					(Minimum value)
					(Pointer)

### Note

- This instruction deals with the data as signed integer (-32768 to 32767).
- If there are two or more minimum value in the table, the lowest pointer is stored.
- If Index register K is used as operand  $B$ , the pointer data is discarded.

## 7. Instructions

FUN 164	AVE	Average value	T1S only
---------	-----	---------------	----------

### Expression

Input  $-[ A \text{ AVE } (n) B ]-$  Output

### Function

When the input is ON, this instruction calculates the average value of the data stored in the  $n$  registers starting with  $A$ , and stores the average value in  $B$ . The allowable range of the table size  $n$  is 1 to 64.

### Execution condition

Input	Operation	Output
OFF	No execution	OFF
ON	Execution	ON

### Operand

	Name	Device						Register								Constant	Index		
		X	Y	R	S	T	C	XW	YW	RW	SW	T	C	D	I			J	K
$A$	Start of table							√	√	√	√	√	√						
$n$	Table size																	1 - 64	
$B$	Result								√	√	√	√	√	√	√	√			

### Example

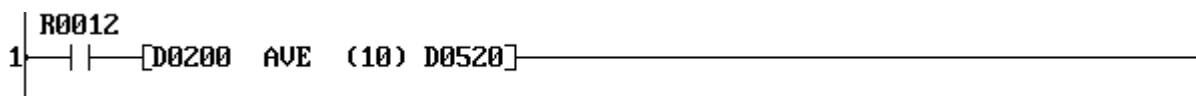

When R012 is ON, the average value of the data stored in the register table D0200 to D0209 (10 words), and the average value is stored in D0520.





## 7. Instructions

FUN 165	FG	Function generator
---------	----	--------------------

### Expression

Input  $-\lceil A \text{ FG } (n) B \rightarrow C \rceil$ - Output

### Function

When the input is ON, this instruction finds the function value  $f(x)$  for  $A$  as  $x$ , and stores it in  $C$ . The function  $f(x)$  is defined by the parameters stored in  $2 \times n$  registers starting with  $B$ .

### Execution condition

Input	Operation	Output
OFF	No execution	OFF
ON	Execution	ON

### Operand

	Name	Device						Register								Constant	Index		
		X	Y	R	S	T	C	XW	YW	RW	SW	T	C	D	I			J	K
$A$	Input value $x$							√	√	√	√	√	√	√	√	√	√	√	
$n$	Parameter size																	1 - 32	
$B$	Start of parameters							√	√	√	√	√	√						
$C$	Function value $f(x)$								√	√	√	√	√	√	√	√			

### Example

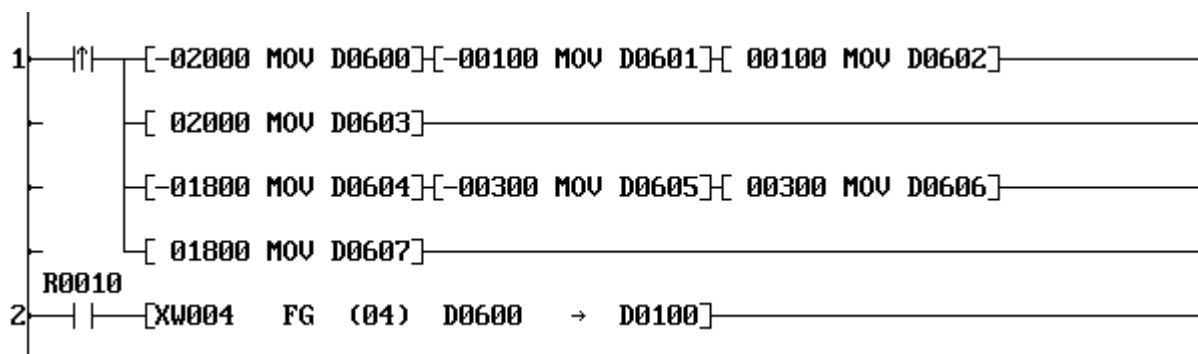

When R010 is ON, the FG instruction finds the function value  $f(x)$  for  $x = XW004$ , and stores the result in D0100.

The function  $f(x)$  is defined by  $2 \times 4 = 8$  parameters stored in D0600 to D0607. In this example, these parameters are set at the first scan.

## 7. Instructions

Parameter table

4 registers for  $x$  parameters and subsequent 4 registers for corresponding  $f(x)$  parameters

D0600	-2000	$x_1$
D0601	-100	$x_2$
D0602	100	$x_3$
D0603	2000	$x_4$
D0604	-1800	$y_1$
D0605	-300	$y_2$
D0606	300	$y_3$
D0607	1800	$y_4$

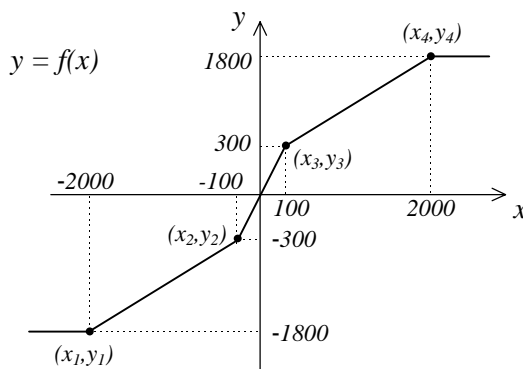

The FG instruction interpolates  $f(x)$  value for  $x$  based on the  $n$  parameters of  $(x_i, y_i)$ .

For example, if XW04 is 1500 ( $x = 1500$ ), the result 1405 ( $f(x) = 1405$ ) is stored in D0100.

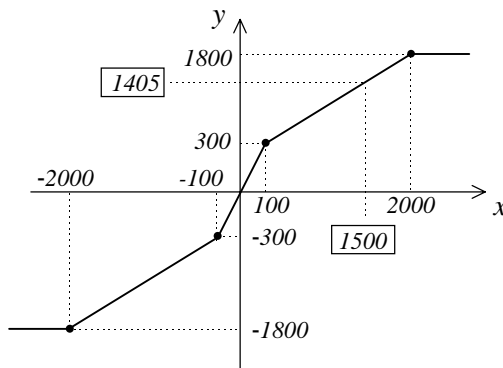

### Note

- The order of the  $x$  parameters should be  $x_1 \leq x_2 \leq \dots \leq x_i \leq \dots \leq x_n$ . In the above example, the data of D0600 to D0603 should be  $D0600 \leq D0601 \leq D0602 \leq D0603$ .
- If  $x$  is smaller than  $x_1$ ,  $y_1$  is given as  $f(x)$ . In this example, D0604 data (-1800) is stored in D0100 if XW04 is smaller than D0600 (-2000).
- If  $x$  is greater than  $x_n$ ,  $y_n$  is given as  $f(x)$ . In this example, D0607 data (1800) is stored in D0100 if XW04 is greater than D0603 (2000).
- The valid data range is -32768 to 32767.





## 7. Instructions

FUN 183	DNEG	Double-word 2's complement
---------	------	----------------------------

### Expression

Input  $\neg[A+1\cdot A \text{ DNEG } B+1\cdot B]$ – Output

### Function

When the input is ON, this instruction finds the 2's complement value of double-word data  $A+1\cdot A$ , and stores it in  $B+1\cdot B$ .

### Execution condition

Input	Operation	Output
OFF	No execution	OFF
ON	Execution	ON

### Operand

	Name	Device						Register								Constant	Index		
		X	Y	R	S	T	C	XW	YW	RW	SW	T	C	D	I			J	K
A	Source							√	√	√	√	√	√	√				√	
B	Destination								√	√	√	√	√	√					

### Example

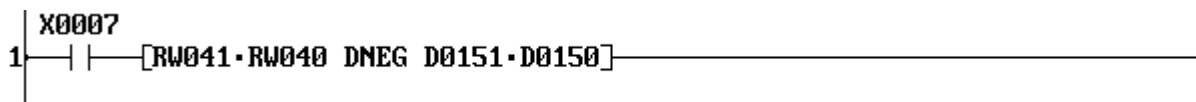

When X007 is ON, the 2's complement value (sign inverted data) of double-word register RW41·RW40 is stored in double-word register D0151·D0150.

For example, if RW41·RW40 is -1234567890, the 2's complement value 1234567890 is stored in D0151·D0150.

### Note

- The data range of  $A+1\cdot A$  is -2147483648 to 2147483647. If the data of  $A+1\cdot A$  is -2147483648, the same data -2147483648 is stored in  $B+1\cdot B$ .



## 7. Instructions

Operand A (lower 4 bits)		7 segment LED composition	Operand B (lower 8 bits)								Display
Hex	Binary		B7	B6	B5	B4	B3	B2	B1	B0	
0	0000		0	0	1	1	1	1	1	1	0
1	0001		0	0	0	0	0	1	1	0	1
2	0010		0	1	0	1	1	0	1	1	2
3	0011		0	1	0	0	1	1	1	1	3
4	0100		0	1	1	0	0	1	1	0	4
5	0101		0	1	1	0	1	1	0	1	5
6	0110		0	1	1	1	1	1	0	1	6
7	0111		0	0	1	0	0	1	1	1	7
8	1000		0	1	1	1	1	1	1	1	8
9	1001		0	1	1	0	1	1	1	1	9
A	1010		0	1	1	1	0	1	1	1	A
B	1011		0	1	1	1	1	1	0	0	b
C	1100		0	0	1	1	1	0	0	1	c
D	1101		0	1	0	1	1	1	1	0	d
E	1110		0	1	1	1	1	0	0	1	e
F	1111		0	1	1	1	0	0	0	1	F

## 7. Instructions

FUN 186	ASC	ASCII conversion
---------	-----	------------------

### Expression

Input  $\text{--[ A ASC B ]}$ – Output

### Function

When the input is ON, this instruction converts the alphanumeric characters into the ASCII codes, and stores them in the register table starting with *B*. (16 characters maximum)

### Execution condition

Input	Operation	Output
OFF	No execution	OFF
ON	Execution	ON

### Operand

	Name	Device						Register								Constant	Index		
		X	Y	R	S	T	C	XW	YW	RW	SW	T	C	D	I			J	K
<i>A</i>	Characters																	√	
<i>B</i>	Start of destination								√	√	√	√	√	√					

### Example



When R030 is ON, the characters 'ABCDEFGHJKLMN' is converted into the ASCII codes, and the result is stored in 8 registers starting with lower 8 bits (byte) of D0200 (D0200 to D0207).

	High	Low
	F 8 7	0
D0200	H42 (B)	H41 (A)
D0201	H44 (D)	H43 (C)
D0202	H46 (F)	H45 (E)
D0203	H48 (H)	H47 (G)
D0204	H4A (J)	H49 (I)
D0205	H4C (L)	H4B (K)
D0206	H4E (N)	H4D (M)
D0207		

← Previous data is remained

### Note

- Only the number of bytes converted are stored. The rest are not changed. In the above example, 14 characters are converted into 14 bytes of ASCII code, and these ASCII codes are stored in 7 registers (D0200 to D0206). The data of D0207 remains unchanged.



## 7. Instructions

FUN 188	BIN	Binary conversion
---------	-----	-------------------

### Expression

Input  $\rightarrow$  [ A BIN B ]  $\rightarrow$  Output

### Function

When the input is ON, this instruction converts the 4 digits of BCD data of *A* into binary, and stores in *B*. If any digit of *A* contains non-BCD code (other than H0 through H9), the conversion is not executed and the instruction error flag (ERF = S051) is set to ON.

### Execution condition

Input	Operation	Output	ERF
OFF	No execution	OFF	–
ON	Normal execution	ON	–
	BCD data error	OFF	Set

### Operand

	Name	Device						Register										Constant	Index
		X	Y	R	S	T	C	XW	YW	RW	SW	T	C	D	I	J	K		
A	Source (BCD)							√	√	√	√	√	√	√	√	√	√	H0000 - H9999	
B	Destination (Binary)								√	√	√	√	√	√	√	√	√		

### Example



When R017 is ON, the BCD data of RW28 is converted into binary data, and the result is stored in D0127.

For example, if RW28 is H1234, the binary data 1234 is stored in D0127.

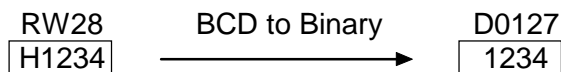

### Note

- If any digit of operand *A* contains non-BCD data, e.g. H13A6, the conversion is not executed and the instruction error flag (ERF = S051) is set to ON.

## 7. Instructions

FUN 190	BCD	BCD conversion
---------	-----	----------------

### Expression

Input  $-\{A \text{ BCD } B\}$ - Output

### Function

When the input is ON, this instruction converts the binary data of *A* into BCD, and stores in *B*. If the data of *A* is not in the range of 0 to 9999, the conversion is not executed and the instruction error flag (ERF = S051) is set to ON.

### Execution condition

Input	Operation	Output	ERF
OFF	No execution	OFF	-
ON	Normal execution	ON	-
	Binary data error	OFF	Set

### Operand

	Name	Device						Register										Constant	Index	
		X	Y	R	S	T	C	XW	YW	RW	SW	T	C	D	I	J	K			
A	Source (Binary)							√	√	√	√	√	√	√	√	√	√	√	0 - 9999	
B	Destination (BCD)								√	√	√	√	√	√	√	√	√	√		

### Example

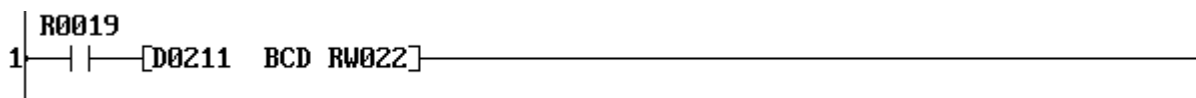

When R019 is ON, the data of D0211 is converted into 4-digit BCD, and the result is stored in RW22.

For example, if D0211 is 5432, the BCD data H5432 is stored in RW22.

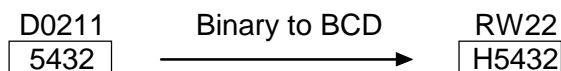

### Note

- If the data of *A* is smaller than 0 or greater than 9999, the conversion is not executed and the instruction error flag (ERF = S051) is set to ON.

## 7. Instructions

FUN 235	I/O	Direct I/O
---------	-----	------------

### Expression

Input  $-\text{[ I/O (n) A ]}$ - Output

### Function

When the input is ON, this instruction immediately updates the external input (XW) and output (YW) registers which are in the range of  $n$  registers starting with A.

- For XW register ... reads the data from corresponding input circuit
- For YW register ... writes the data into corresponding output circuit

### Execution condition

Input	Operation	Output
OFF	No execution	OFF
ON	Execution	ON

### Operand

	Name	Device						Register									Constant	Index	
		X	Y	R	S	T	C	XW	YW	RW	SW	T	C	D	I	J			K
$n$	Register size																	1 - 32	
A	Start of registers							√	√										

### Example

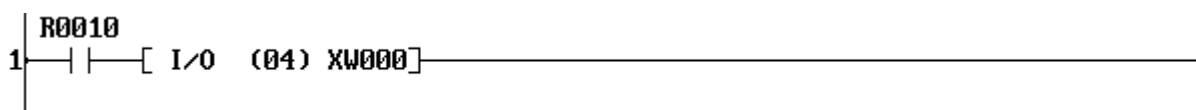

When R010 is ON, the 4 registers starting with XW00 (XW00 to YW03) are updated immediately.

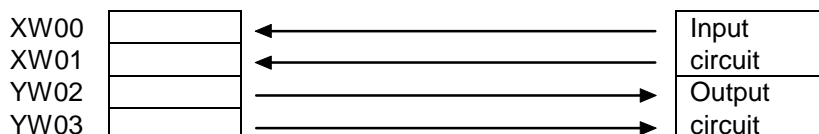

## 7. Instructions

### Note

- In the T1/T1S, the following register/device range is only effective for this Direct I/O instruction.

	Input on basic unit	Output on basic unit	Option card	T2 I/O modules
T1-16	X000 - X007	Y020 - Y027	–	–
T1-28	X000 - X00D	Y020 - Y02D	–	–
T1-40	X000 - X007	Y020 - Y027	Not effective	Effective
T1-40S	X000 - X007	Y020 - Y027	Not effective	Effective

- The Direct I/O instruction can be programmed in the main program and in the interrupt program. If this instruction is programmed in both, the instruction in the main program should be executed in interrupt disable state. Refer to EI (FUN 140) and DI (FUN 141) instructions.

## 7. Instructions

FUN 236	XFER	Expanded data transfer
---------	------	------------------------

### Expression

Input  $\text{--[ } A \text{ XFER } B \text{ --> } C \text{ ]--}$  Output

### Function

When the input is ON, data block transfer is performed between the source which is indirectly designated by  $A$  and  $A+1$  and the destination which is indirectly designated by  $C$  and  $C+1$ . The transfer size (number of words) is designated by  $B$ .

The transfer size is 1 to 256 words. (except for writing into EEPROM)

Data transfer between the following objects are available.

- CPU register (RW or D)  $\leftrightarrow$  EEPROM (D register)
- CPU register (RW or D)  $\leftrightarrow$  T1S RS-485 port (T1S only)

### Execution condition

Input	Operation	Output	ERF
OFF	No execution	OFF	–
ON	Normal execution	ON	–
	When error is occurred (see Note)	ON	Set

### Operand

	Name	Device						Register									Constant	Index		
		X	Y	R	S	T	C	XW	YW	RW	SW	T	C	D	I	J			K	
$A$	Source parameter							√	√	√	√	√	√	√						
$B$	Transfer size							√	√	√	√	√	√	√						
$C$	Destination parameter								√	√	√	√	√	√						

### Parameters

<p style="text-align: center;">Source parameter</p> <table border="1" style="width: 100%; border-collapse: collapse;"> <tr> <td style="width: 10%;"><math>A</math></td> <td style="width: 80%;">Type</td> </tr> <tr> <td><math>A+1</math></td> <td>Leading address</td> </tr> </table>	$A$	Type	$A+1$	Leading address	<p style="text-align: center;">Transfer size and status</p> <table border="1" style="width: 100%; border-collapse: collapse;"> <tr> <td style="width: 10%;"><math>B</math></td> <td style="width: 80%;">Transfer size</td> </tr> <tr> <td><math>B+1</math></td> <td>Status flag for RS-485 port</td> </tr> <tr> <td><math>B+2</math></td> <td>(max. 2 words)</td> </tr> </table>	$B$	Transfer size	$B+1$	Status flag for RS-485 port	$B+2$	(max. 2 words)	<p style="text-align: center;">Destination parameter</p> <table border="1" style="width: 100%; border-collapse: collapse;"> <tr> <td style="width: 10%;"><math>C</math></td> <td style="width: 80%;">Type</td> </tr> <tr> <td><math>C+1</math></td> <td>Leading address</td> </tr> </table>	$C$	Type	$C+1$	Leading address
$A$	Type															
$A+1$	Leading address															
$B$	Transfer size															
$B+1$	Status flag for RS-485 port															
$B+2$	(max. 2 words)															
$C$	Type															
$C+1$	Leading address															

Register type	Type code	Leading address	Transfer size
RW register (RAM)	H0003	0 to 63 (T1) 0 to 255 (T1S)	1 to 64 (T1) 1 to 256 (T1S)
D register (RAM)	H0004	0 to 1023 (T1) 0 to 4095 (T1S)	1 to 256
D register (EEPROM)	H0020	0 to 511 (T1) 0 to 2047 (T1S)	1 to 16 (if destination, T1) 1 to 32 (if destination, T1S) 1 to 256 (if source)
T1S RS-485 port	H0030	0 (fixed)	1 to 256

## 7. Instructions

### CPU register ↔ built-in EEPROM

In the EEPROM, the D registers are divided into pages as follows.

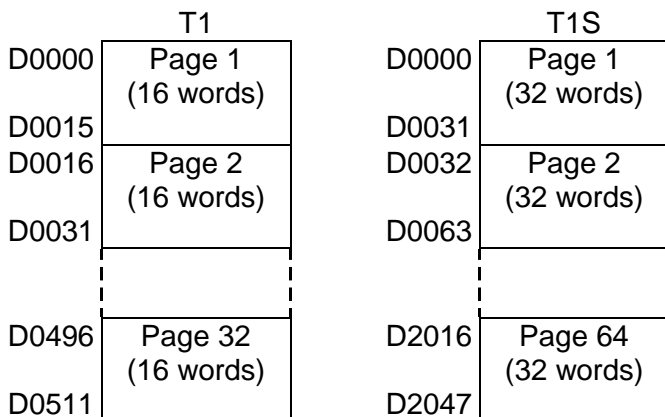

- Writing data into the EEPROM is available within one page at a time. (max. 16 words for T1 and max. 32 words for T1S)
- For data reading from the EEPROM, there is no need to consider the pages.

### Example

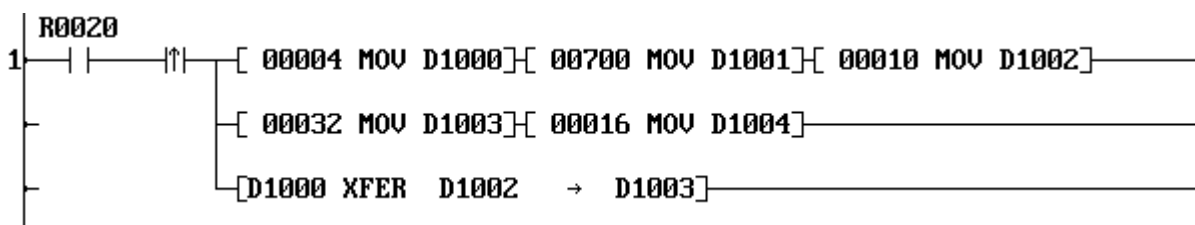

When R020 is changed from OFF to ON, 10 words of RAM data (D0700 to D0709) are written into the EEPROM (D0016 to D0025).

D1000 (H0004) and D1001 (700) indicate the leading register of the source table (D0700 in RAM). D1002 (10) indicates the transfer size (10 words = 10 registers). D1003 (H0020 = 32) and D1004 (16) indicate the leading register of the destination table (D0016 in EEPROM).

### Note

- The XFER instruction is not executed as error in the following cases. In these cases, the instruction error flag (ERF = S051) is set to ON. If the ERF is set to ON once, it remains ON until resetting to OFF by user program.
  - (1) When the number of words transferred exceeds limit.
  - (2) When the source/destination table of transfer is out of the valid range.
  - (3) When the transfer combination is invalid.
- The EEPROM has a life limit for data writing into an address. It is 100,000 times. Pay attention not to exceed the limit. (EEPROM alarm flag = S007 is not updated by this instruction)
- Once data writing into the EEPROM is executed, EEPROM access (read/write) is prohibited for the duration of 10 ms. Therefore, minimum 10 ms interval is necessary for data writing.
- The XFER instruction can be programmed in the main program and in the interrupt program. If this instruction is programmed in both, the instruction in the main program should be executed in interrupt disable state. Refer to EI (FUN 140) and DI (FUN 141) instructions.

## 7. Instructions

### CPU register ↔ T1S RS-485 port (T1S only)

#### <Receiving>

When the instruction input is ON, one set of message (from start character to the trailing code) which is received by the RS-485 port is read from the receive buffer, and stored in the CPU registers. The transfer size is fixed to 256 words. The execution status and the message length (in bytes) are stored in the status flag.

The instruction input must be kept ON until the receiving operation is complete.

#### Example

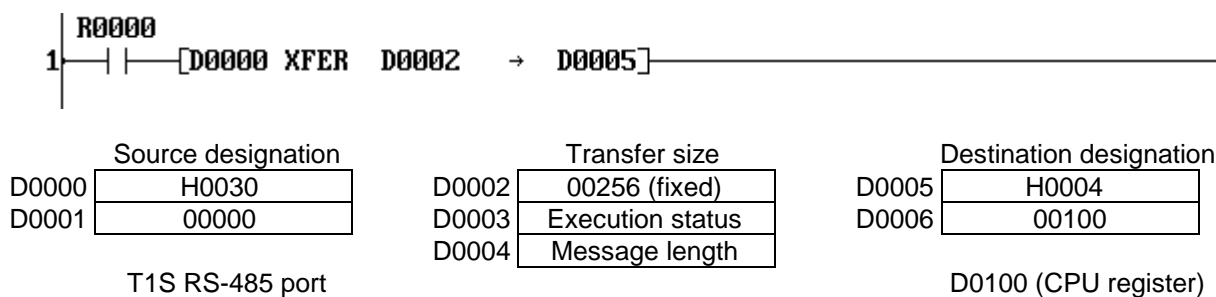

When R0000 is ON, one set of received message is read and stored in D0100 and after.

Execution status: H0000 ... Normal complete

H0001 ... Communication error (parity error, framing error)

H0002 ... Message length over (more than 512 bytes)

H0003 ... Receive buffer over flow

H0004 ... Receive time-out (from start character to the trailing code)

Baudrate	Time-out setting
300, 600, 1200 bps	30 seconds
2400 bps	15 seconds
4800 bps	7 seconds
9600 bps	3 seconds
19200 bps	1.5 seconds

Message length: 0 ..... No receive message

1 to 512 ... Message length in bytes

#### Note

- The XFER instruction is not executed as error in the following cases. In these cases, the instruction error flag (ERF = S051) is set to ON. If the ERF is set to ON once, it remains ON until resetting to OFF by user program.
  - (1) The leading address for the RS-485 port designation is other than 0.
  - (2) Transfer size is other than 256.
  - (3) Mode setting of the RS-485 port is not the free ASCII mode.
  - (4) This instruction is programmed in the sub-program #1.

## 7. Instructions

### <Transmitting>

When the instruction input is ON, one set of message which is stored in the source table (from start character to the trailing code) is transmitted through the RS-485 port. The execution status is stored in the status flag.

The instruction input must be kept ON until the transmitting operation is complete.

### Example

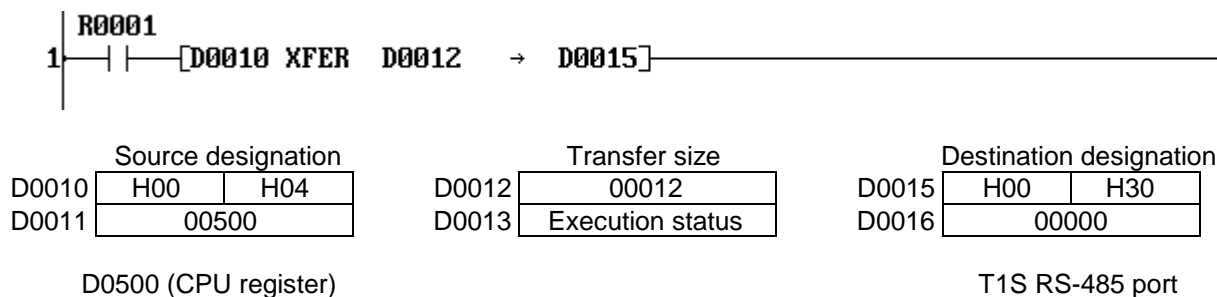

When R0001 is ON, one set of message (ended by the trailing code) stored in the range of D0500 to D0511 (12 words) is transmitted through the RS-485 port.

Execution status: H0000 ... Normal complete

H0001 ... During transmitting the message

H0002 ... Communication busy

H0003 ... During the reset operation

H0004 ... Send time-out (from start character to the trailing code)

H0005 ... Send message length error (no trailing code in the source table)

Baudrate	Time-out setting
300, 600, 1200 bps	30 seconds
2400 bps	15 seconds
4800 bps	7 seconds
9600 bps	3 seconds
19200 bps	1.5 seconds

### Note

- The XFER instruction is not executed as error in the following cases. In these cases, the instruction error flag (ERF = S051) is set to ON. If the ERF is set to ON once, it remains ON until resetting to OFF by user program.
  - (1) The leading address for the RS-485 port designation is other than 0.
  - (2) Transfer size is out of the range of 1 to 256.
  - (3) Mode setting of the RS-485 port is not the free ASCII mode.
  - (4) This instruction is programmed in the sub-program #1.



## 7. Instructions

FUN 237	READ	Special module data read
---------	------	--------------------------

### Expression

Input  $\text{--[ A READ B } \rightarrow \text{ C ]--}$  Output

### Function

When the input is ON, this instruction reads data from the buffer memory of the special module that is designated by operand *A*, and stores them in registers starting with operand *C*.

The transfer source address (buffer memory address) is designated by operand *B*.

The transfer size (number of words) is designated by operand  $B+1$ .

This instruction is only effective for the T2 I/O modules connected to the T1-40 or T1-40S.

### Execution condition

Input	Operation	Output	ERF
OFF	No execution	OFF	–
ON	Normal execution	ON	–
	When error is occurred (see Note)	ON	Set

### Operand

	Name	Device						Register								Constant	Index		
		X	Y	R	S	T	C	XW	YW	RW	SW	T	C	D	I			J	K
A	Special module							√	√									H0004 - H0007	
B	Transfer parameter							√	√	√	√	√	√						
C	Destination								√	√	√	√	√						

### Example

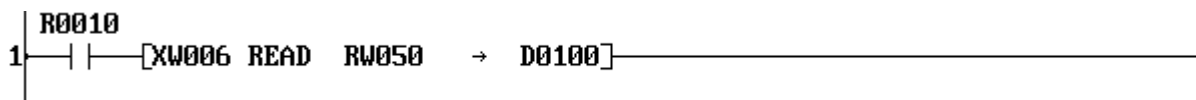

When R010 is ON, the buffer memory data of the size indicated by RW51, starting with the address indicated by RW50 of the special module allocated to XW06, are read and stored in D0100 and after.

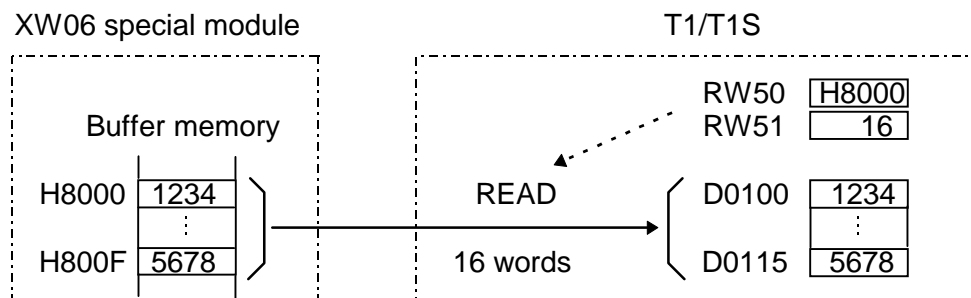

## 7. Instructions

### Note

- This instruction is only effective for the T2 I/O modules connected to the T1-40 or T1-40S by using the expansion rack.
- The special module can be designated not only by the assigned register, but also by the mounting position. The mounting position is designated by a constant data for the operand A as follows.

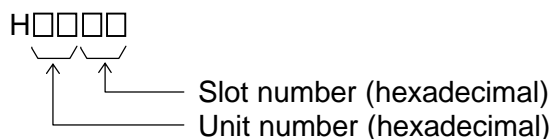

In the T1-40/T1-40S, 0 is only available for the unit number and 4 to 7 are available for the slot number. The first slot (left most slot) of the expansion rack is recognized as slot 4. Consequently, available designation is H0004 to H0007.

- The READ instruction is not executed as error in the following cases. In these cases, the instruction error flag (ERF = S051) is set to ON. If the ERF is set to ON once, it remains ON until resetting to OFF by user program.
  - (1) When the operand A is other than a valid constant (see above) or XW/YW register.
  - (2) When no answer error occurs with the designated special module.
  - (3) When the number of words transferred exceeds 256 words.
  - (4) When the source table of transfer is out of the valid range.
  - (5) When the destination table of transfer is out of the valid range.
- The READ instruction can be programmed in the main program and in the interrupt program. If this instruction is programmed in both, the instruction in the main program should be executed in interrupt disable state. Refer to EI (FUN 140) and DI (FUN 141) instructions.

## 7. Instructions

FUN 238	WRITE	Special module data write
---------	-------	---------------------------

### Expression

Input  $\text{--[ A WRITE B } \rightarrow \text{ C ]--}$  Output

### Function

When the input is ON, this instruction transfers data stored in registers starting with operand *A* into the buffer memory of the special module that is designated by operand *C*.

The destination address (buffer memory address) is designated by operand *B*.

The transfer size (number of words) is designated by operand  $B+1$ .

This instruction is only effective for the T2 I/O modules connected to the T1-40 or T1-40S.

### Execution condition

Input	Operation	Output	ERF
OFF	No execution	OFF	–
ON	Normal execution	ON	–
	When error is occurred (see Note)	ON	Set

### Operand

	Name	Device						Register								Constant	Index			
		X	Y	R	S	T	C	XW	YW	RW	SW	T	C	D	I			J	K	
A	Source							√	√	√	√	√	√	√						
B	Transfer parameter							√	√	√	√	√	√	√						
C	Special module							√	√										H0004 - H0007	

### Example

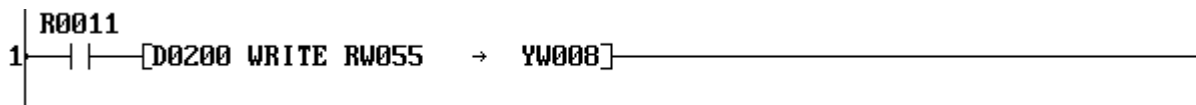

When R011 is ON, the register data of the size indicated by RW56, starting with D0200, are transferred to the buffer memory starting with the address indicated by RW55 of the special module allocated to YW08.

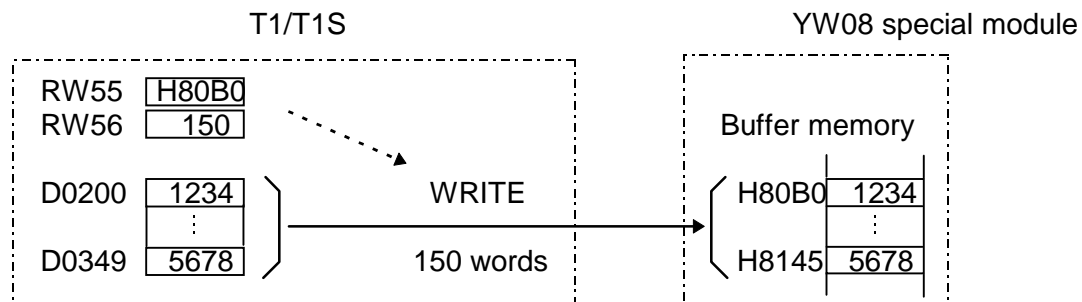

## 7. Instructions

### Note

- This instruction is only effective for the T2 I/O modules connected to the T1-40 or T1-40S by using the expansion rack.
- The special module can be designated not only by the assigned register, but also by the mounting position. The mounting position is designated by a constant data for the operand *C* as follows.

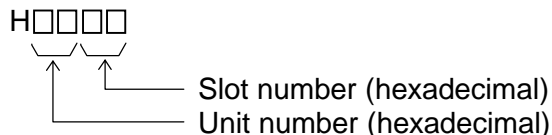

In the T1-40/T1-40S, 0 is only available for the unit number and 4 to 7 are available for the slot number. The first slot (left most slot) of the expansion rack is recognized as slot 4. Consequently, available designation is H0004 to H0007.

- The WRITE instruction is not executed as error in the following cases. In these cases, the instruction error flag (ERF = S051) is set to ON. If the ERF is set to ON once, it remains ON until resetting to OFF by user program.
  - (1) When the operand *C* is other than a valid constant (see above) or XW/YW register.
  - (2) When no answer error occurs with the designated special module.
  - (3) When the number of words transferred exceeds 256 words.
  - (4) When the source table of transfer is out of the valid range.
  - (5) When the destination table of transfer is out of the valid range.
- The WRITE instruction can be programmed in the main program and in the interrupt program. If this instruction is programmed in both, the instruction in the main program should be executed in interrupt disable state. Refer to EI (FUN 140) and DI (FUN 141) instructions.

---

---

## *Section 8*

# *Special I/O Functions*

---

---

- 8.1 Special I/O function overview, 268*
- 8.2 Variable input filter constant, 272*
- 8.3 High speed counter, 273*
- 8.4 Interrupt input function, 280*
- 8.5 Analog setting function, 282*
- 8.6 Pulse output function, 283*
- 8.7 PWM output function, 285*

## 8. Special I/O Functions

### 8.1 Special I/O function overview

The T1/T1S supports the special I/O functions as listed below.

Function name		Function summary	Remarks
Variable input filter constant		Input filter constant (ON/OFF delay time) can be set by user program. The setting range is 0 to 15 ms (1 ms units). Default value is 10 ms. This function is applied for X000 to X007 (8 points as a block).	SW16 setting is necessary to use this function. (Note)
High speed counter	Single phase up-counter	Counts the number of pulses of single phase pulse train. 2 channels of pulse input are available. The countable pulse rate is up to 5 kHz for each channel. Channel 1 ... X000 count input, X002 reset input Channel 2 ... X001 count input, X003 reset input	Only one among these 4 functions can be selected. SW16 is used to select the function. (Note)
	Single phase speed-counter	Counts the number of pulses in a specified sampling time. The sampling time setting is 10 to 1000 ms (10 ms units). 2 channels of pulse input are available. The countable pulse rate is up to 5 kHz for each channel. Channel 1 ... X000 count input Channel 2 ... X001 count input	
	Quadrature bi-pulse counter	Counts the 2-phase pulses whose phases are shifted 90° each other. Counts up when phase A precedes, and counts down when phase B precedes. The countable pulse rate is up to 5 kHz. Phase A ... X000 Phase B ... X001 Reset ..... X002	
Interrupt input function		Immediately activates the corresponding I/O interrupt program when the interrupt input is changed from OFF to ON (or ON to OFF). 2 points of interrupt input are available. X002 ... Interrupt 1 (I/O interrupt program #3) X003 ... Interrupt 2 (I/O interrupt program #4)	
Analog setting function		The value of the analog setting adjuster is converted into digital value (0 to 1000) and stored in the SW register. 2 adjusters are provided on the T1/T1S. V0 ... SW30 V1 ... SW31	No function selection is required.
Pulse output function		Variable frequency pulse train can be output. The available pulse rate is 50 to 5000 Hz (1 Hz units). Y020 ... CW or Pulse (PLS) Y021 ... CCW or Direction (DIR)	Either one between these 2 functions can be used.
PWM output function		Variable duty cycle pulse train can be output. The available ON duty setting is 0 to 100 % (1 % units). Y020 ... PWM output	SW26 is used to select the function. (Note)



The above special I/O functions, except the variable input filter constant and analog setting functions, are available only in the DC input types.

### Mode setting for the special I/O functions

These functions, except the analog setting function, are selected by setting data into SW16 and SW26 by user program. These registers work as mode setting registers for the special I/O functions. The data setting for these registers, i.e. mode setting for the special I/O functions, is effective only at the first scan.

Note) In the explanation below, HSC and INT mean the high speed counter and the interrupt input functions respectively.

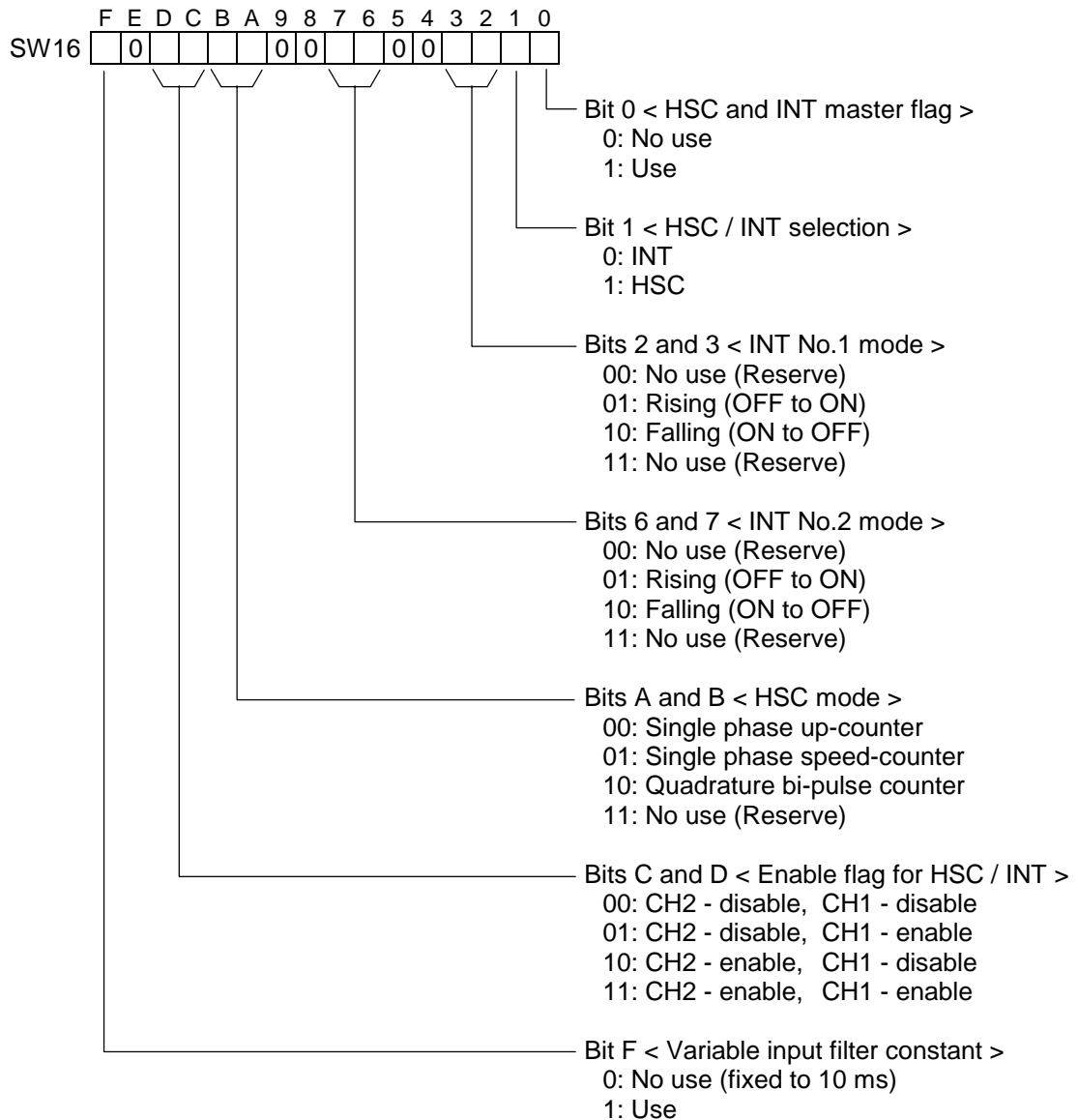

## 8. Special I/O Functions

Note) In the explanation below, P-OUT means the pulse output function.

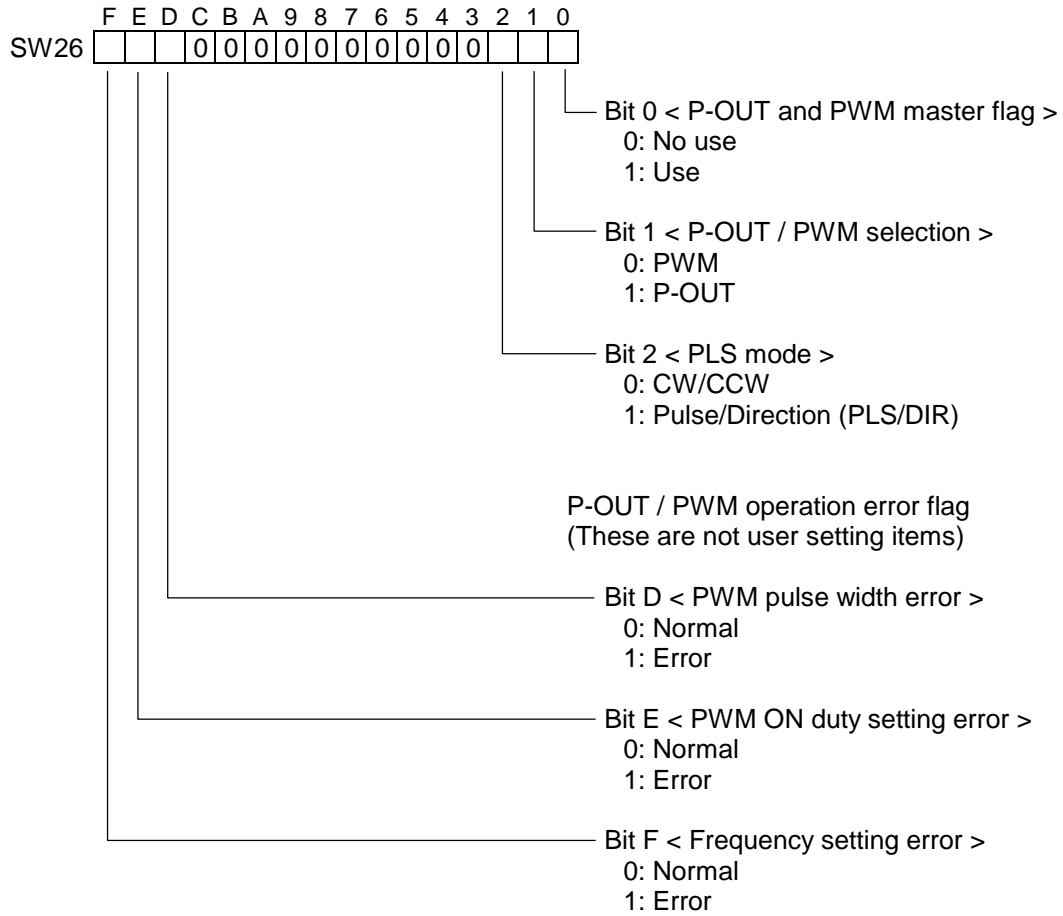







### 8.3 High speed counter

#### 8.3.1 Single phase up-counter

##### Function

When the count input is changed from OFF to ON, the count value is increased by 1. When the count value reaches the set value, the count value is reset to 0, and I/O interrupt program is activated (if the interrupt enable flag is ON). The count value is reset to 0 when the reset input comes ON.

This counter operation is enabled while the soft-gate is ON. The count value is reset to 0 when the soft-gate is changed from ON to OFF.

The set value is set internally at the timing of the soft-gate changing from OFF to ON.

When the soft-gate is OFF, the count value can be changed by writing the data into the set value register and setting the count preset flag to ON.

The count value range is H0000 to HFFFF (16-bit data).

##### Hardware condition

Count input (X000 and X001)

ON/OFF pulse width: 100  $\mu$ s or more (max. 5 kHz)

Reset input (X002 and X003)

ON/OFF duration: 2 ms or more

##### Related registers

SW16: Function selection. Refer to section 8.1.

Function	Register/device		Remarks
	Channel 1	Channel 2	
Count input	X000	X001	(Note)
Reset input	X002	X003	
Set value	SW18	SW20	Data range: H0000 to HFFFF
Count value	SW22	SW23	
Soft-gate	S240	S248	Operation is enabled when ON
Interrupt enable	S241	S249	Interrupt is enabled when ON
Count preset	S243	S24B	Used to preset the counter value

Note) When both channels are used, X000 to X003 cannot be used as normal input devices. However, if either one channel is used, these inputs for unused channel can be used as normal input devices.

##### Interrupt assignment

Channel 1 ... I/O interrupt program #1

Channel 2 ... I/O interrupt program #2

## 8. Special I/O Functions

### Operation

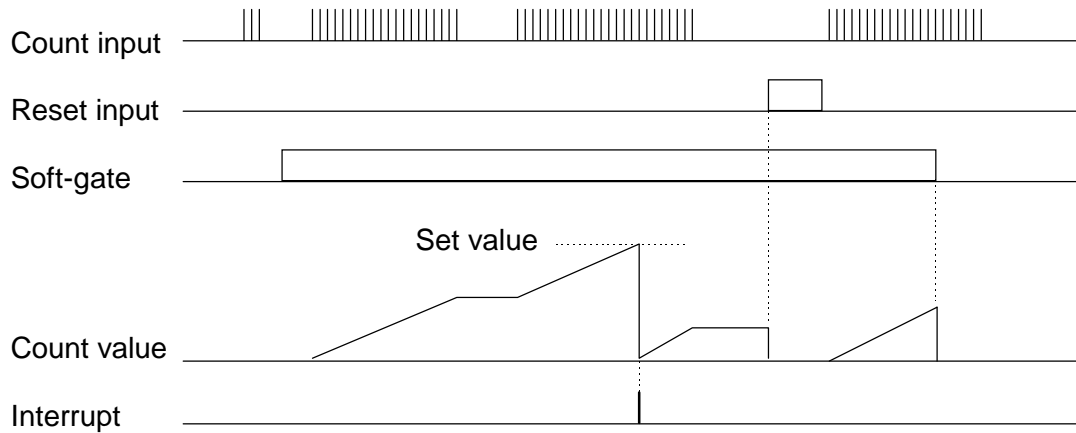

### Sample program

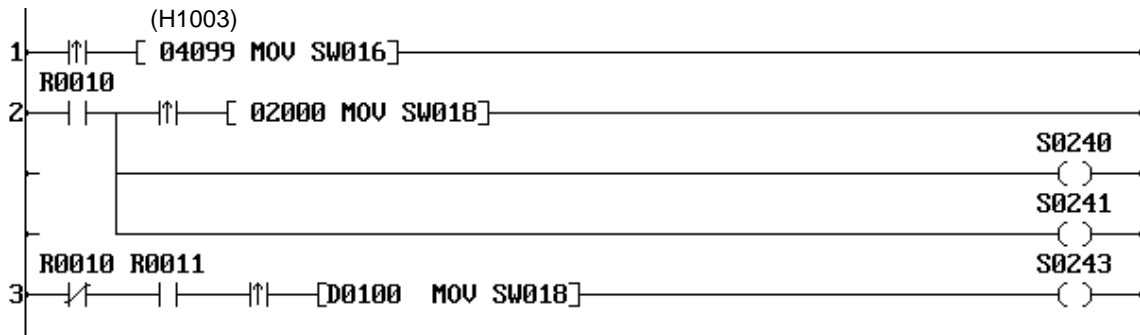

In this example, 4099 (H1003) is set in SW16. As a result, the single phase up-counter (channel 1 only) is selected.

When R010 comes ON, the data 2000 is written into the set value register (SW18).

While R010 is ON, the soft-gate (S240) and the interrupt enable flag (S241) are set to ON to enable the counter operation.

The counter works as a ring counter with the set value 2000. The count value is stored in SW22.

When R010 is OFF and R011 comes ON, the count value is preset to the data of D0100.

### 8.3.2 Single phase speed-counter

#### Function

This function counts the number of changes of the count input from OFF to ON during the every specified sampling time. The count value in a sampling time is stored in the hold value register.

This counter operation is enabled while the soft-gate is ON. When the soft-gate is OFF, the hold value is cleared to 0.

The setting range of the sampling time is 10 to 1000 ms (10 ms units).

The count value range is H0000 to HFFFF (16-bit).

#### Hardware condition

Count input (X000 and X001)

ON/OFF pulse width: 100  $\mu$ s or more (max. 5 kHz)

#### Related registers

SW16: Function selection. Refer to section 8.1.

Function	Register/device		Remarks
	Channel 1	Channel 2	
Count input	X000	X001	(Note 2)
Sampling time	SW18	SW20	Data range: 1 to 100 (Note 1)
Hold value	SW22	SW23	Data range: H0000 to HFFFF
Soft-gate	S240	S248	Operation is enabled when ON

Note 1) The setting data range of the sampling time is 1 to 100. (10 ms multiplier)

Note 2) When both channels are used, X000 and X001 cannot be used as normal input devices. However, if either one channel is used, the input for unused channel can be used as normal input devices.

#### Interrupt assignment

No interrupt function.

## 8. Special I/O Functions

### Operation

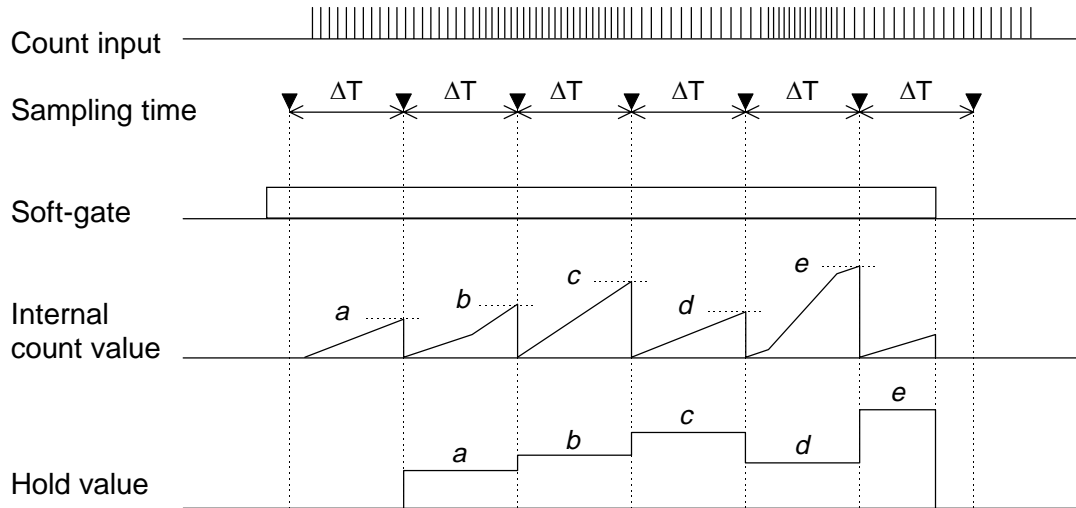

### Sample program

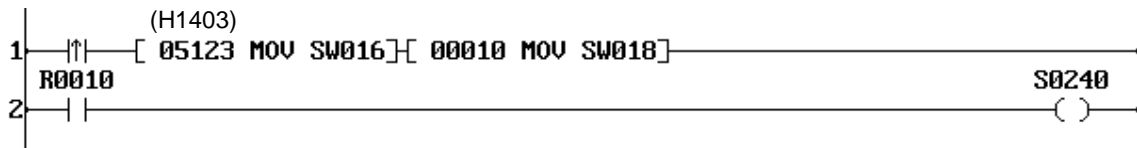

In this example, 5123 (H1403) is set in SW16. As a result, the single phase speed-counter (channel 1 only) is selected.

The sampling time is set as 100 ms, because 10 is written in SW18.

While R010 is ON, the soft-gate (S240) is set to ON, and the speed-counter works.

The hold value is stored in SW22.

### 8.3.3 Quadrature bi-pulse counter

#### Function

This function counts up or down the quadrature bi-pulse (2-phase pulses whose phases are shifted 90° each other). Counts up when phase A precedes, and counts down when phase B precedes. Both rising and falling edges of each phase are counted. Consequently, 4 times count value against the pulse frequency is obtained.

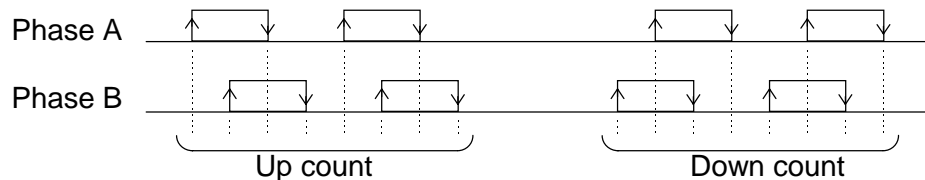

When the count value reaches the comparison value 1 (or 2), the I/O interrupt program #1 (or #2) is activated (if the interrupt enable flag for each is ON).

This counter operation is enabled while the soft-gate is ON. The count value is reset to 0 when the soft-gate is changed from ON to OFF. The count value is also reset to 0 when the reset input comes ON.

When the soft-gate is OFF, the count value can be changed by writing the data into the comparison value 1 (or 2) register and setting the count preset flag 1 (or 2) to ON.

The comparison value 1 and 2 can be changed even when the soft-gate is ON.

The count value range is -2147483648 to 2147483647 (32-bit data).

#### Hardware condition

Phase A and phase B (X000 and X001)

ON/OFF pulse width: 100 μs or more (max. 5 kHz)

Reset input (X002)

ON/OFF duration: 2 ms or more

#### Related registers

SW16: Function selection. Refer to section 8.1.

Function	Register/device	Remarks
Phase A	X000	
Phase B	X001	
Reset input	X002	
Comparison value 1	SW19-SW18	Data range: -2147483648 to 2147483647
Comparison value 2	SW21-SW20	
Count value	SW23-SW22	
Soft-gate	S240	Operation is enabled when ON
Interrupt enable 1	S241	Interrupt 1 is enabled when ON
Count preset 1	S243	Used to preset the count value
Interrupt enable 2	S249	Interrupt 2 is enabled when ON
Count preset 2	S24B	Used to preset the count value

## 8. Special I/O Functions

### Interrupt assignment

Comparison value 1 ... I/O interrupt program #1  
Comparison value 2 ... I/O interrupt program #2

### Operation

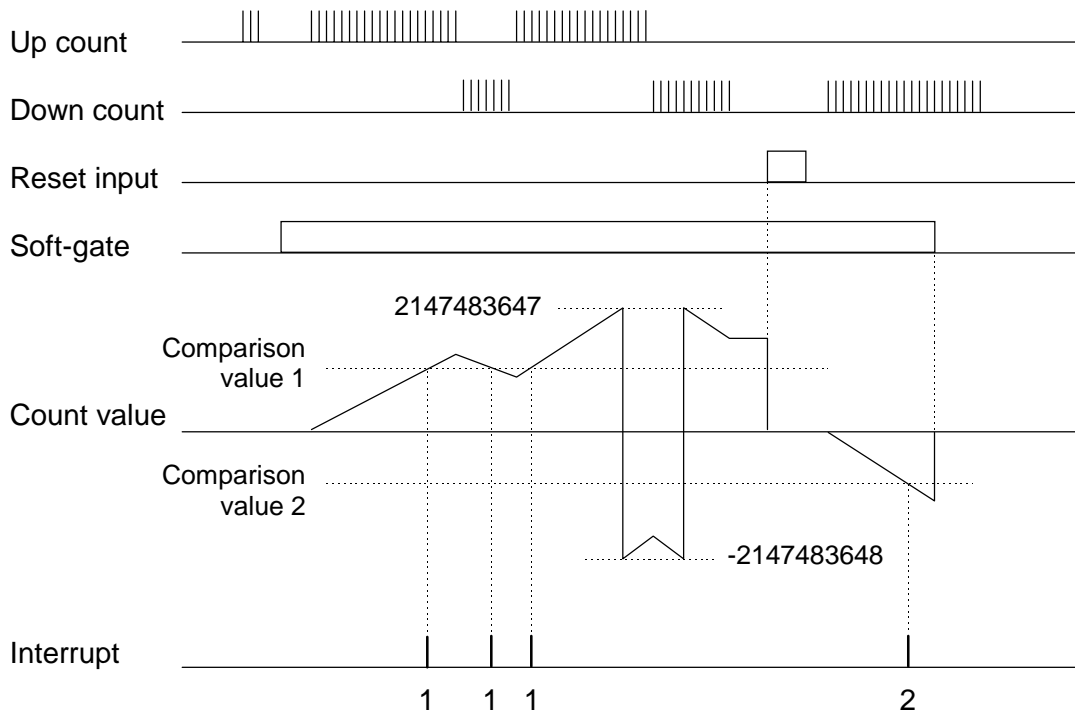



### Sample program

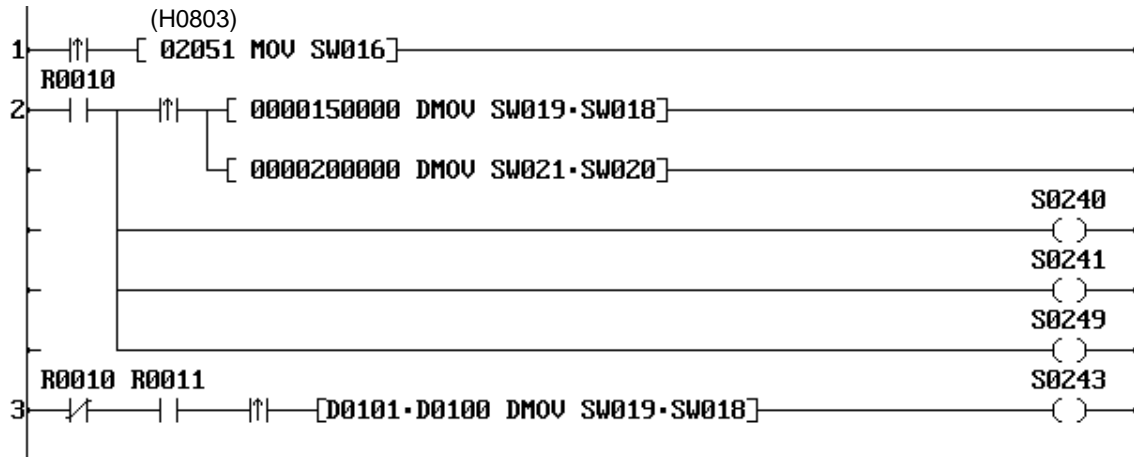

In this example, 2051 (H0803) is set in SW16. As a result, the quadrature bi-pulse counter is selected.

When R010 comes ON, the data 150000 is set into the comparison value 1 register (SW19-SW18), and 200000 is set into the comparison value 2 register (SW21-SW20). While R010 is ON, the soft-gate (S240), the interrupt enable flag 1 (S241) and the interrupt enable flag 2 (S249) are set to ON to enable the counter operation. The count value is stored in SW23-SW22.

When R010 is OFF and R011 comes ON, the count value is preset to the data of D0101-D0100.

## 8. Special I/O Functions

### 8.4 Interrupt input function

#### Function

When the signal state of the interrupt input is changed from OFF to ON (or ON to OFF), the corresponding I/O interrupt program is activated immediately.

Up to 2 interrupt inputs can be used. The interrupt generation condition can be selected either rising edge (OFF to ON) or falling edge (ON to OFF) for each input.

The I/O interrupt program #3 is corresponding to the interrupt input 1, and the I/O interrupt program #4 is corresponding to the interrupt input 2.

#### Hardware condition

Interrupt input (X002 and X003)

ON/OFF pulse width: 100  $\mu$ s or more

#### Related registers

SW16: Function selection. Refer to section 8.1.

Interrupt input 1	X002
Interrupt input 2	X003

#### Interrupt assignment

Interrupt input 1 ... I/O interrupt program #3

Interrupt input 2 ... I/O interrupt program #4

#### Operation

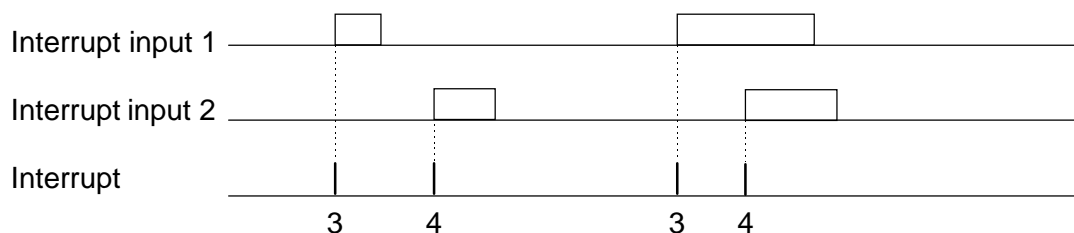

The above operation example is the case of rising edge setting for both inputs.

## 8. Special I/O Functions

### Sample program

#### Main program

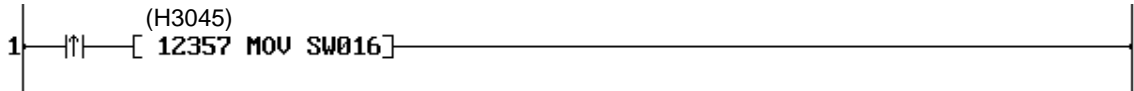

#### I/O interrupt program #3

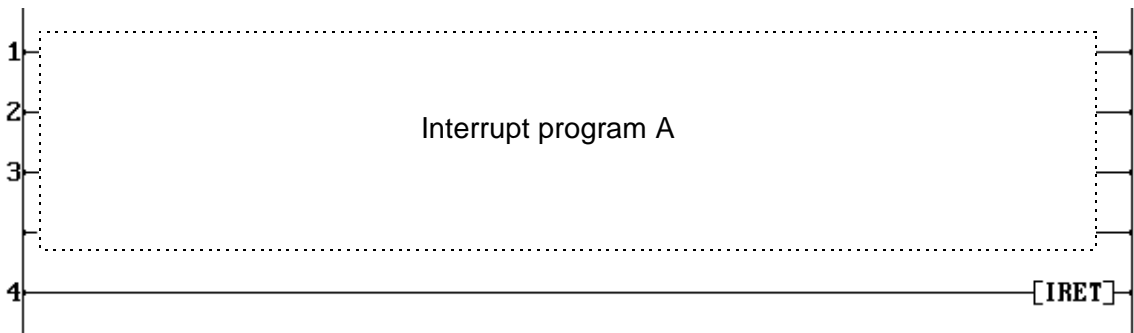

#### I/O interrupt program #4

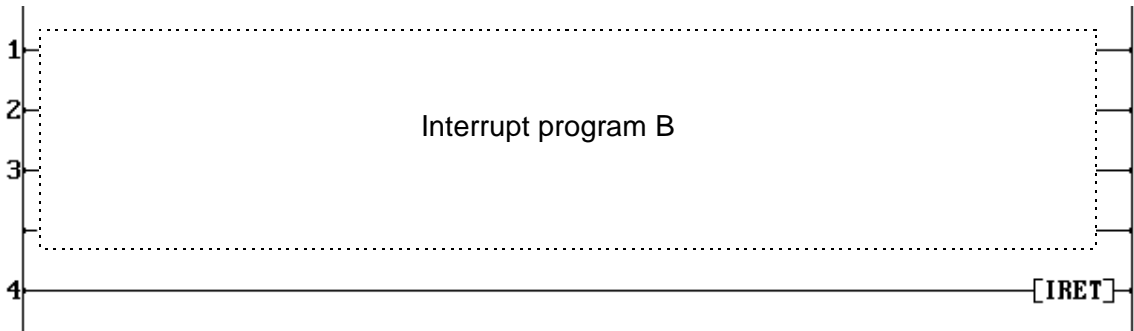

In this example, 12357 (H3045) is set in SW16. As a result, the interrupt input function (2 points, rising for both) is selected.

When X002 is changed from OFF to ON, the interrupt program A is executed. When X003 is changed from OFF to ON, the interrupt program B is executed.



**NOTE** Even if the Direct I/O instruction is used in the interrupt program, the corresponding input state (X002 or X003) cannot be confirmed. Because the interrupt is generated before internal updating of the input states.



### 8.6 Pulse output function

#### Function

This function is used to output a variable frequency pulse train. The controllable pulse frequency is 50 to 5000 Hz (1 Hz units).

The output mode can be selected either CW/CCW or Pulse/Direction (PLS/DIR).

In the CW/CCW mode, CW pulse is output when the frequency setting is positive (50 to 5000), and CCW pulse is output when it is negative (-50 to -5000).

In the PLS/DIR mode, DIR is OFF when the frequency setting is positive (50 to 5000), and DIR is ON when it is negative (-50 to -5000).

< CW/CCW mode >

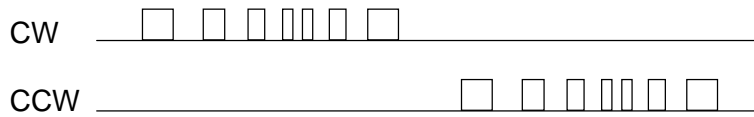

< PLS/DIR mode >

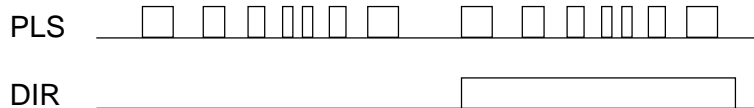

In the both modes, pulse output is enabled when the pulse enable flag is ON. While the pulse enable flag is ON, the pulse frequency can be changed by changing the frequency setting value. However, the pulse direction (the sign of the frequency setting) cannot be changed when the pulse enable flag is ON.

This function can be used to control the speed of a stepping motor, etc.

#### Related registers

SW26: Function selection. Refer to section 8.1.

Function		Register/ device	Remarks
CW/CCW	PLS/DIR		
CW pulse	PLS	Y020	
CCW pulse	DIR	Y021	
Pulse enable flag		S270	Output is enabled when ON
Frequency setting register		SW28	Data range: -5000 to -50, 50 to 5000
Frequency setting error flag		S26F	ON at error (reset OFF automatically)

Note) The allowable value range of the frequency setting (SW28) is -5000 to -50 and 50 to 5000. If the value is out of this range or the sign is changed while the pulse enable flag (S270) is ON, the frequency setting error flag (S26F) comes ON. (Pulse output operation is continued with previous frequency setting)

## 8. Special I/O Functions

### Operation

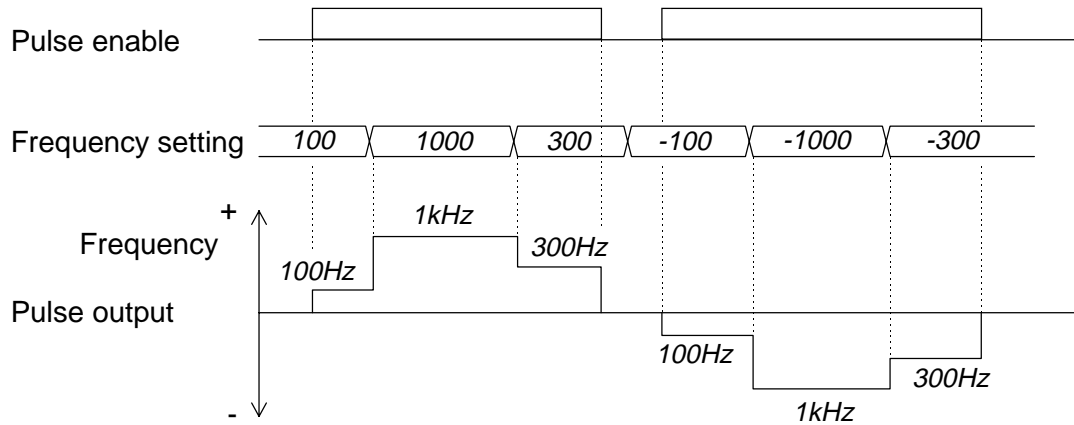

### Sample program

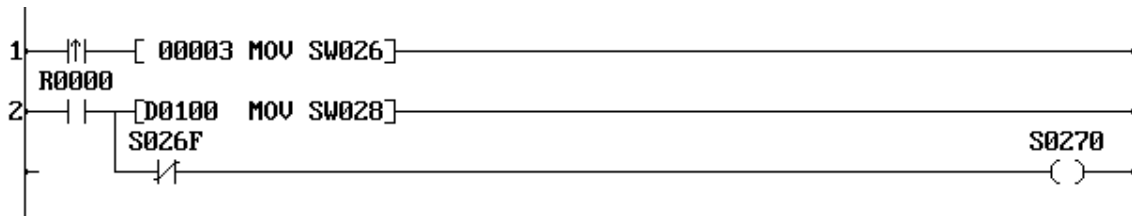

In this example, 3 (H0003) is set in SW26. As a result, the CW/CCW mode pulse output function is selected.

When R000 is ON, the pulse output is started with the frequency designated by D0100. If an invalid frequency is designated, the frequency setting error flag (S26F) comes ON and the pulse enable flag (S270) is turned OFF. Then the pulse output is stopped.

### 8.7 PWM output function

#### Function

This function is used to output a variable duty cycle pulse train. The controllable duty cycle is 0 to 100 % (1 % units).

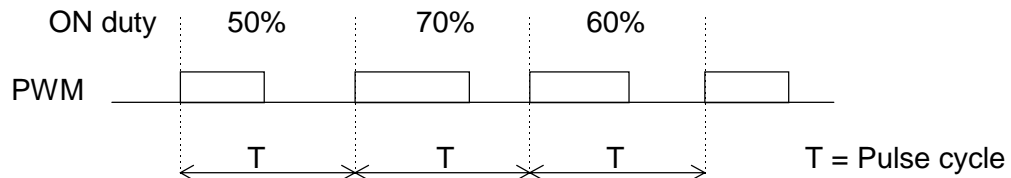

The PWM output is enabled when the pulse enable flag is ON. While the pulse enable flag is ON, the duty cycle (ON duty) can be changed by changing the duty setting value (0 to 100).

The frequency setting is available in the range of 50 to 5000 Hz (1 Hz units) before turning ON the pulse enable flag. The frequency changing is not allowed while the pulse enable is ON.

Note that the minimum ON/OFF pulse duration is 100  $\mu$ s. Therefore, the controllable ON duty range is limited depending on the frequency setting as follows. If the ON duty setting value is not available (within 0 to 100), the pulse width error flag comes ON. (PWM output operation is continued but the duty cycle is not guaranteed)

Frequency	Cycle time	Available ON duty
50 - 100 Hz	20 - 10 ms	0 to 100 %
200 Hz	5 ms	0, 2 to 98, 100 %
1000 Hz	1 ms	0, 10 to 90, 100 %
5000 Hz	200 $\mu$ s	0, 50, 100 %

#### Related registers

SW26: Function selection. Refer to section 8.1.

Function	Register/ device	Remarks
PWM pulse	Y020	
Pulse enable flag	S270	Output is enabled when ON
Frequency setting register	SW28	Data range: 50 to 5000
ON duty setting register	SW29	Data range: 0 to 100
Pulse width error flag	S26D	ON at error (reset OFF automatically)
ON duty setting error flag	S26E	ON at error (reset OFF automatically)
Frequency setting error flag	S26F	ON at error (reset OFF automatically)

Note) If the setting value of SW28 or SW29 is out of the allowable range, the frequency setting error flag (S26F) or the ON duty setting error flag (S26E) comes ON. (PWM output operation is continued with previous ON duty setting)

## 8. Special I/O Functions

### Operation

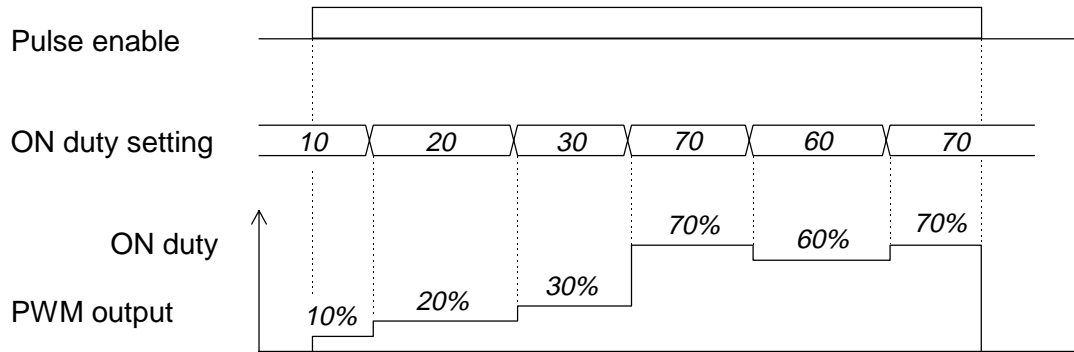

### Sample program

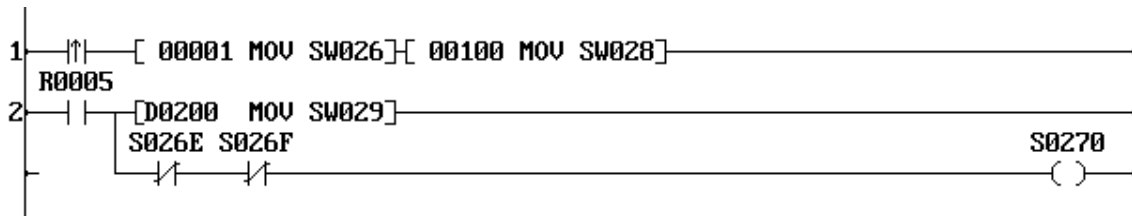

In this example, 1 (H0001) is set in SW26 and 100 is set in SW28. As a result, 100 Hz PWM output function is selected.

When R005 is ON, the PWM output is started with the duty cycle designated by D0200. If an invalid ON duty is designated, the ON duty setting error flag (S26E) comes ON and the pulse enable flag (S270) is turned OFF. Then the PWM output is stopped.



---

## *Section 9*

# *Maintenance and Checks*

---

- 9.1 Precautions during operation, 288*
- 9.2 Daily checks, 289*
- 9.3 Periodic checks, 290*
- 9.4 Maintenance parts, 291*

## 9. Maintenance and Checks

### 9.1 Precautions during operation

When the T1/T1S is in operation, you should pay attention to the following items.

- (1) The programmer cable can be plugged or unplugged while the T1/T1S is in operation. When you try to do it, do not touch the connector pins. This may cause malfunction of the T1/T1S owing to static electricity.
- (2) Do not plug nor unplug the expansion cable during power on. This can cause damage to the equipment. Furthermore, to avoid malfunction of the T1/T1S owing to static electricity, do not touch the cable ends.
- (3) Do not touch any terminals while the T1/T1S is in operation, even if the terminals are not live parts. This may cause malfunction of the T1/T1S owing to static electricity.
- (4) Do not touch the expansion connector pins while the T1/T1S is in operation. This may cause malfunction of the T1/T1S owing to static electricity.  
Fix the expansion connector cover if the expansion connector is not used.
- (5) Do not insert your finger into the option card slot while the T1/T1S is in operation. This may cause malfunction of the T1/T1S owing to static electricity.  
Fix the option card slot cover securely.
- (6) Do not insert your finger into the expansion rack's ventilation hole during power on. This may cause malfunction of the T1/T1S owing to static electricity.

### 9.2 Daily checks



#### CAUTION

1. Pay special attention during the maintenance work to minimize the risk of electrical shock.
2. Turn off power immediately if the T1/T1S or related equipment is emitting smoke or odor. Operation under such situation can cause fire or electrical shock.

To maintain the system and to prevent troubles, check the following items on daily basis.

Item	Check		Corrective measures
Status LEDs	PWR (power)	Lit when internal 5 V is normal.	If the LEDs are not normal, see 10. Troubleshooting.
	RUN	Lit when operating normally.	
	FLT (fault)	Not lit when operating normally.	
Mode control switch	Check that the mode control switch is in R (RUN) side. Normal operation is performed when this switch is in R (RUN) side.		Turn this switch to R (RUN) side.
Input LEDs	Lit when the corresponding input is ON.		<ul style="list-style-type: none"> <li>• Check that the input terminal screw is not loose.</li> <li>• Check that the input terminal block is not loose.</li> <li>• Check that the input voltage is within the specified range.</li> </ul>
Output LEDs	Lit when the output is ON and the corresponding load should operate.		<ul style="list-style-type: none"> <li>• Check that the output terminal screw is not loose.</li> <li>• Check that the output terminal block is not loose.</li> <li>• Check that the output voltage is within the specified range.</li> </ul>

## 9. Maintenance and Checks

### 9.3 Periodic checks



#### CAUTION

1. Pay special attention during the maintenance work to minimize the risk of electrical shock.
2. Turn off power immediately if the T1/T1S or related equipment is emitting smoke or odor. Operation under such situation can cause fire or electrical shock.

Check the T1/T1S based on the following items every six months. Also perform checks when the operating environment is changed.

Item	Check	Criteria
Power supply	Measure the power voltage at the T1/T1S's power terminals.	85 - 132/170 - 264 Vac (AC PS) 20.4 - 28.8 Vdc (DC PS)
	Check that the terminal screw is not loose.	Not loose
	Check that the power cable is not damaged.	Not damaged
Installation condition	Check that the unit is installed securely.	Not loose, no play
	Check that the option card is inserted securely. (if any)	Not loose, no play
	Check that the expansion rack/unit is installed securely. (if any)	Not loose, no play
	Check that the expansion cable is connected securely and the cable is not damaged. (if any)	Not loose, not damaged
	Check that the I/O module on the expansion rack is inserted securely. (if any)	Not loose, no play
Input/output	Measure the input/output voltage at the T1/T1S's terminals.	The voltage must be within the specified range.
	Check the input status LEDs.	The LED must light normally.
	Check the output status LEDs.	The LED must light normally.
	Check that the terminal block is installed securely.	Not loose, no play
	Check that the terminal screw is not loose and the terminal has a sufficient distance to the next terminal.	Not loose, not contacting the next terminal
	Check that the each I/O wire is not damaged.	Not damaged

## 9. Maintenance and Checks

(Periodic checks - continued)

Item	Check	Criteria
Environment	Check that the temperature, humidity, vibration, dust, etc. are within the specified range.	Must be within the range of general specification.
Programming tool	Check that the functions of the programming tool are normal.	Monitoring and other operations are available.
	Check that the connector and cable are not damaged.	Not damaged
User program	Check that the T1/T1S program and the master program (saved on a floppy disk, etc.) are the same.	No compare error

### 9.4 Maintenance parts

To recover from trouble quickly, it is recommended to keep the following spare parts.

Item	Quantity	Remarks
T1/T1S basic unit	1	Prepare at least one to minimize the down-time of the controlled system.
Programming tool	1	Useful for the troubleshooting procedure.
Master program	As required	Saved on a floppy disk, etc.
Expansion rack or unit (if any)	1	
I/O module (if any)	One of each type used	
Fuse for I/O module (if any)	One of each type used	

These spare parts should not be stored in high temperature and/or humidity locations.



---

# *Section 10*

## *Troubleshooting*

---

- 10.1 Troubleshooting procedure, 294*
- 10.2 Self-diagnostic items, 300*

## 10. Troubleshooting

### 10.1 Troubleshooting procedure

#### ⚠ CAUTION

1. Pay special attention during the troubleshooting to minimize the risk of electrical shock.
2. Turn off power immediately if the T1/T1S or related equipment is emitting smoke or odor. Operation under such situation can cause fire or electrical shock.
3. Turn off power before removing or replacing units, modules, terminal blocks or wires. Failure to do so can cause electrical shock or damage to the T1 and related equipment.
4. Contact Toshiba for repairing if the T1/T1S or related equipment is failed. Toshiba will not guarantee proper operation nor safety for unauthorized repairing.

If a trouble occurs, determine whether the cause lies in the mechanical side or in the control system (PLC) side. A problem may cause a secondary problem, therefore, try to determine the cause of trouble by considering the whole system.

If the problem is found in the T1/T1S, check the following points:

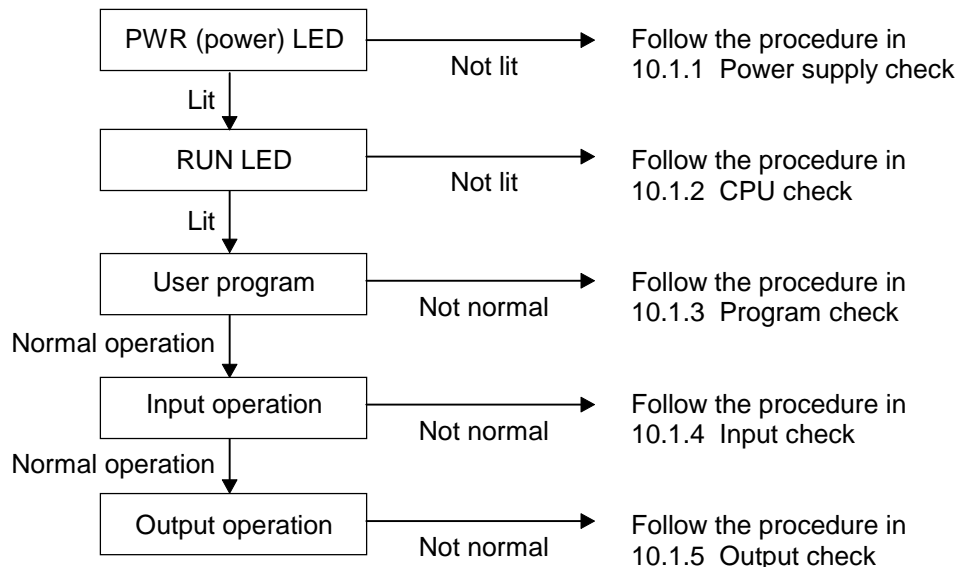

Also refer to section 10.1.6 for environmental problem.



## 10.1.1 Power supply check

If the PWR (power) LED is not lit after power on, check the following points.

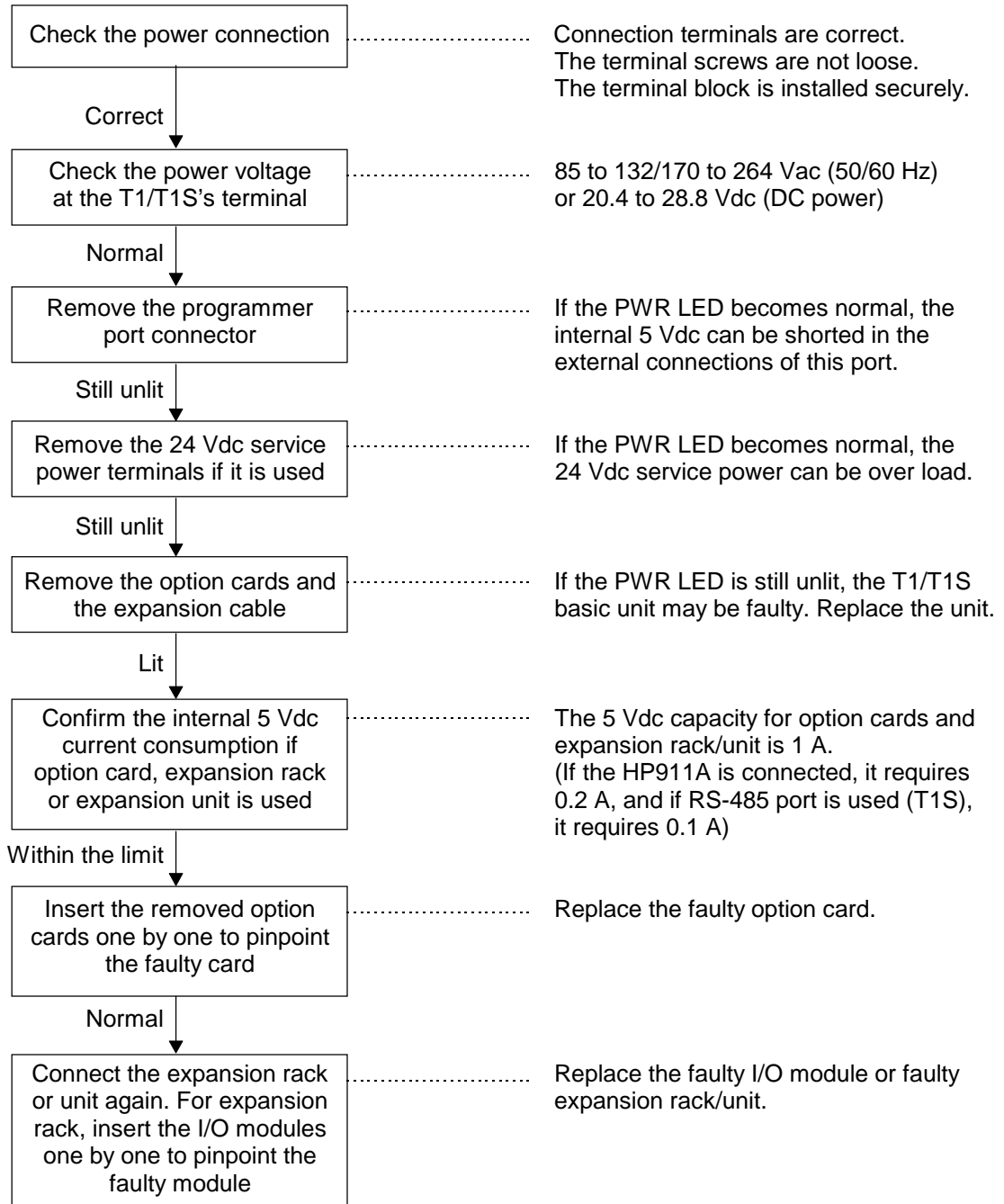

## 10. Troubleshooting

### 10.1.2 CPU check

If the PWR (power) LED is lit but the RUN LED is not lit, check the following points.

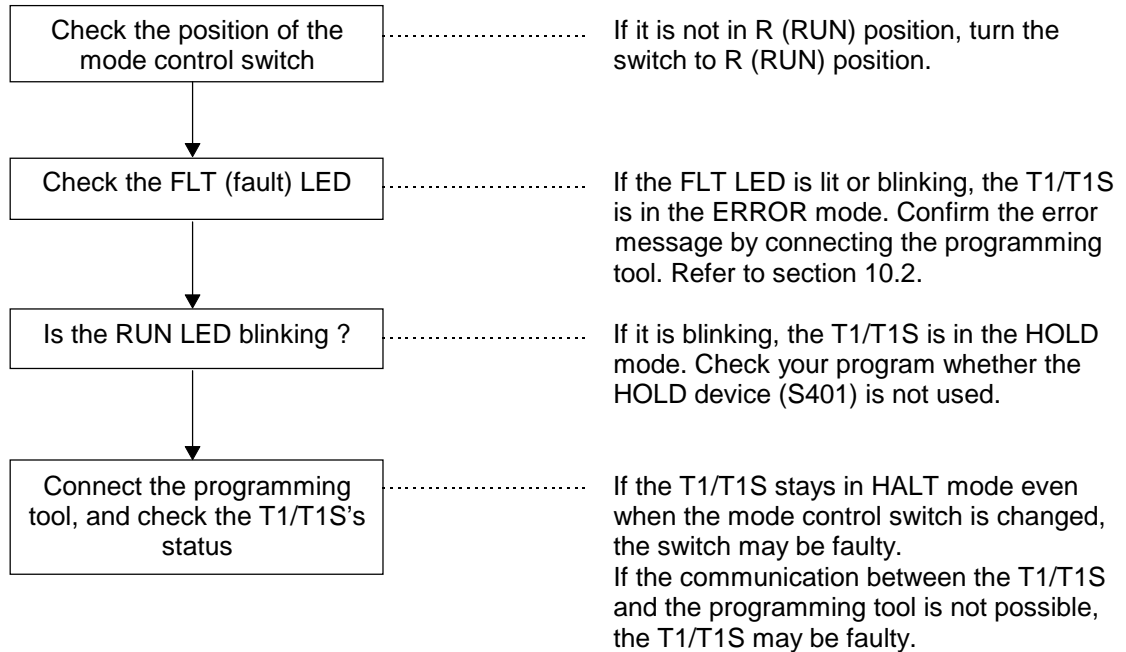

### 10.1.3 Program check

Check the user program based on the following points if it is running but the operation does not work as intended.

1. Whether duplicated coils are not programmed.
2. Whether a coil device and a destination of a function instruction are not overlapping.
3. Whether the ON/OFF duration of an external input signal is not shorter than the T1/T1S's scan time.
4. Whether a register/device which is used in the main program is not operated erroneously in the interrupt program.



#### NOTE

When you write/modify the program, it is necessary to execute the EEPROM write operation before turning off power to the T1. Otherwise the old program stored in the built-in EEPROM will be over-written, and your program modification will disappear.

## 10.1.4 Input check

If the program is running but the external input signal is not read normally, check the following points:

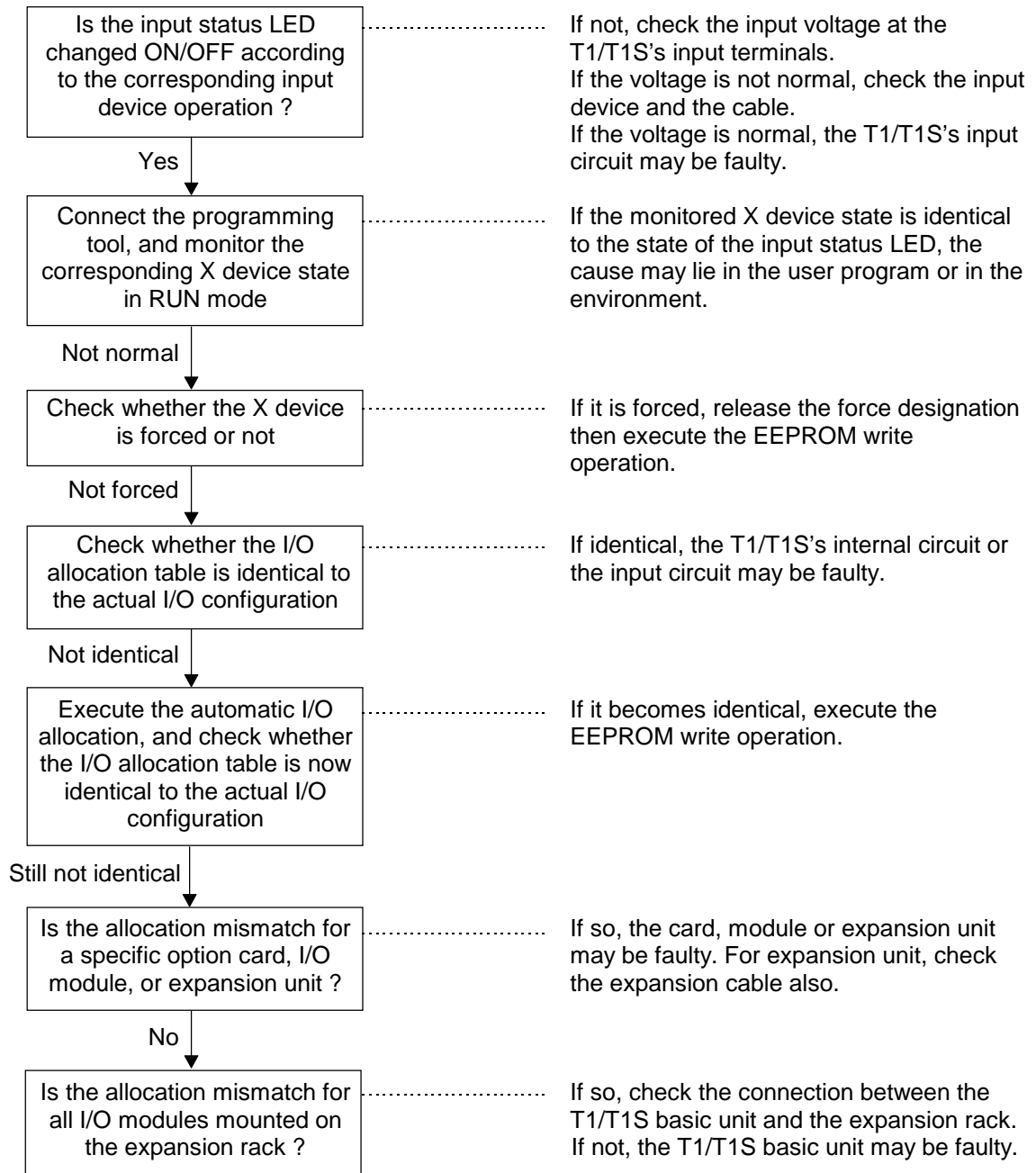

## 10. Troubleshooting

### 10.1.5 Output check

If the output status monitored on the programming tool is normal but the external output device (load) is not operated normally, check the following points:

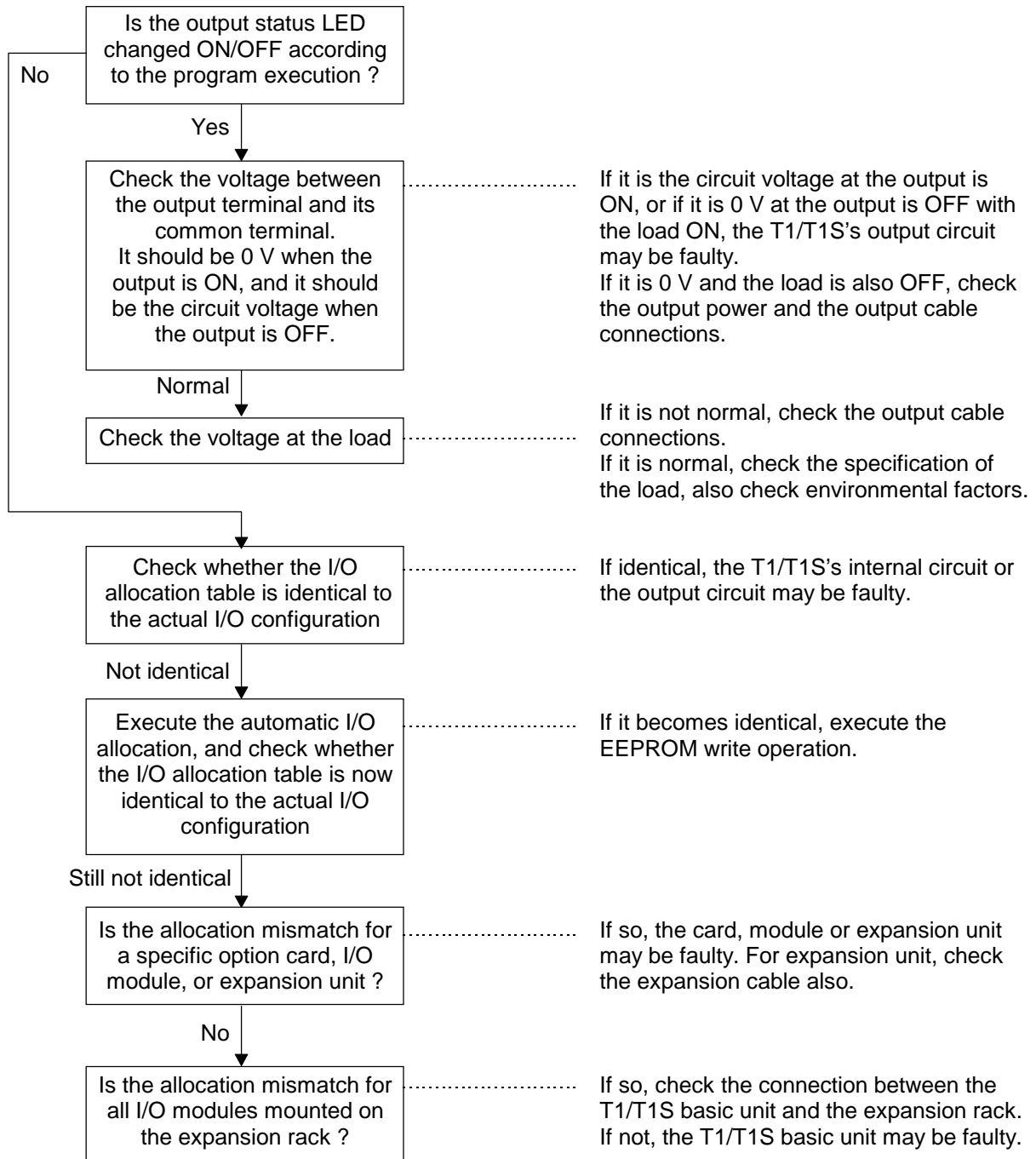

### 10.1.6 Environmental problem

If the following improper operations occur in the controlled system, check possible environmental factors.

- (1) If an improper operation occurs synchronously with the operation of I/O devices:  
The noise generated at ON/OFF of the output device (load) may be the cause of the problem. Take necessary measures mentioned in section 3.
- (2) If an improper operation occurs synchronously with the operation of surrounding equipment or high-frequency equipment:  
The noise induced in I/O signal lines may be the cause of the problem. The surge voltage, voltage fluctuations, or differences of grounding potentials may cause the problem, depending on the power supply system or the grounding system. Check the operation in accordance with the precautions in section 4. For some cases, isolation from the ground may lead to the stable operation.
- (3) If an improper operation occurs synchronously with the operation of machinery:  
The vibration of the equipment may cause the problem. Check that the installation status of the units and take necessary measures.
- (4) If a similar failure is repeated after the unit is replaced:  
Check that no metal debris or water drops has been entered into the unit/module.

Apart from the above points, consider climatic conditions. If the ambient temperature is beyond the specified range, stable operation of the system is not guaranteed.

## 10. Troubleshooting

### 10.2 Self-diagnostic items

If an error is detected by the self-diagnostic check of the T1/T1S CPU, the error messages and the related information shown on the following pages will be recorded in the T1/T1S's event history table. If the error is severe and continuation of operation is not possible, the T1/T1S turns OFF all outputs and stops the operation (ERROR mode). The latest 15 error messages are stored in the event history table. This event history table can be displayed on the programming tool. (Power ON/OFF is also registered)

If the T1/T1S has entered into ERROR mode, connect the programming tool to the T1/T1S to confirm the error message in the event history table. This information is important to recover from a trouble. For the key operations on the programming tool to display the event history table, refer to the separate manual for the programming tool.

(An example of the event history)

< Event History >

	Date	Time	Event	Count	Info 1	Info 2	Info 3	Mode
1.	98-02-21	16:48:01	I/O no answer	3	#00-04			RUN <b>Down</b>
2.	98-02-21	15:55:26	System power on	1				INIT.
3.	98-02-21	12:03:34	System power off	1				RUN
4.	98-01-15	09:27:12	System power on	1				INIT.
5.	98-01-14	19:11:43	System power off	1				HALT
6.	98-01-14	10:39:11	No END/IRET error	3	M-001	H0024		HALT <b>Down</b>
			⋮					
			⋮					

In the event history table, No.1 message indicates the latest event recorded. Each column shows the following information.

Date: The date when the error has detected (T1S only)

Time: The time when the error has detected (T1S only)

Event: Error message

Count: Number of times the error has detected by retry action

Info n: Related information to the error detected

Mode: T1/T1S's operation mode in which the error has detected (INIT. means the power-up initialization)

Down: Shows the T1/T1S has entered into ERROR mode by the error detected

If the T1/T1S is in the ERROR mode, operations to correct the program are not accepted.

In this case, execute the Error reset operation by the programming tool to return the HALT mode before starting the correction operation.

## 10. Troubleshooting

Error message and related information				Special device	Meaning and countermeasures
Event	Info 1	Info 2	Info 3		
Batt voltage drop				S00F	In the power-up initialization, data invalidity of RAM (back-up area) has been detected. If retentive registers are used, these validity are not guaranteed. (No error down)
Boundary error	Program type - block No.	Address in the block	FUN No.		The register of index modification is other than RW, T, C and D. (Error down)
				S064	The register designated by index modification has exceeded the allowable range. That is, out of RW, T, C and D. (No error down) Check the value of the index register.
Clock-calendar error				S00A	The data of built-in calendar LSI is illegal. (No error down) Set the date and time. (T1S only)
Duplicate entry No.	Program type - block No.	Address in the block	Entry No.		Multiple SUBR instructions which have the same subroutine number are programmed. (Error down) Check the program.
EEPROM BCC error	Illegal BCC			S004 S013	BCC error has been detected in the user program of the EEPROM. (Error down) Reload the program and execute EEPROM write operation again.
EEPROM warning	Number of excess writing			S007	The number of times of writing into EEPROM has exceeded the life (100,000 times). (No error down) Replace the unit because the data reliability of the EEPROM will decrease.
I/O bus error	Unit No.	Data		S005 S020	An abnormality has been detected in I/O bus checking. (Error down) Check the expansion cable connection and I/O module mounting status.
I/O mismatch	Unit No. - slot No.	Register No.		S005 S021	The I/O allocation information and the actual I/O configuration are not identical. (Error down) Check the I/O allocation and the option card mounting status.
I/O no answer	Unit No. - slot No.	Register No.		S005 S022	No response from the T2 I/O module has been received. (Error down) Check the I/O allocation, the expansion cable connection and the T2 I/O module mounting status.
I/O parity error	Unit No. - slot No.	Register No.		S005 S023	I/O bus parity error has been detected in data read/write for T2 I/O modules. (Error down) Check the expansion cable connection and the T2 I/O module mounting status.
Illegal I/O reg	Unit No. - slot No.	Register No.		S005 S021	The allocated I/O register address exceeds the limit, 32 words. (Error down) Check the I/O allocation.

## 10. Troubleshooting

Error message and related information				Special device	Meaning and countermeasures
Event	Info 1	Info 2	Info 3		
Illegal inst	Program type - block No.	Address in the block		S006 S030 S060	An illegal instruction has been detected in the program. (Error down) Reload the program and execute EEPROM write operation again.
Illegal sys intrpt	Interrupt address 1	Interrupt address 2			Unregistered interrupt has occurred. (No error down) If the error occurs frequently, replace the unit.
Invalid Fun inst	Program type - block No.	Address in the block	Fun No.		A function instruction which is not supported by the T1/T1S is programmed. (Error down) Correct the program.
Invalid program	Program type - block No.				A basic ladder instruction which is not supported by the T1/T1S is programmed. (Error down) Correct the program. ----- SUBR instruction is not programmed before RET instruction. (Error down) Correct the program. ----- An abnormality is detected in the program management information. (Error down) Reload the program and execute EEPROM write operation again.
Loop nesting error	Program type - block No.	Address in the block			A FOR-NEXT loop is programmed inside other FOR-NEXT loop. (Error down) Correct the program.
Memory full					The program exceeds the executable memory capacity. (Error down) Reduce the program steps.
No END/IRET error	Program type - block No.	Address in the block			The END instruction is not programmed in the main program or in the sub-program. (Error down) Correct the program. ----- The IRET instruction is not programmed in the interrupt program. (Error down) Correct the program.
No RET error	Program type - block No.	Address in the block	Sub-r No.		The RET instruction is not programmed in the subroutine program. (Error down) Correct the program.
No sub-r entry	Program type - block No.	Address in the block	Sub-r No.		The subroutine corresponding to CALL instruction is not programmed. (Error down) Correct the program.



## 10. Troubleshooting

Error message and related information				Special device	Meaning and countermeasures
Event	Info 1	Info 2	Info 3		
Operand error	Program type - block No.	Address in the block			A register/device which is not supported by the T1/T1S is programmed. (Error down) Correct the program.
					The timer or counter register is duplicated in the program. (Error down) Correct the program.
					The subroutine number programmed with CALL or SUBR instruction is out of the range. (Error down) T1 ..... 0 to 15 T1S .... 0 to 255 Correct the program.
					Index modification is programmed for instructions in which the index modification is not allowed. (Error down) Correct the program.
Pair inst error	Program type - block No.	Address in the block			The combination is illegal for MCS-MCR, JCS-JCR or FOR-NEXT instructions. (Error down) Correct the program.
					A MCS-MCR is programmed inside other MCS-MCR segment. (Error down ) Correct the program.
					A JCS-JCR is programmed inside other JCS-JCR segment. (Error down ) Correct the program.
Peripheral LSI err	Error code			S004 S016	CPU hardware error has been detected in the power-up initialization. (Error down and programming tool cannot be connected) Replace the unit if the error remains after power OFF and ON again.
Program BCC error	Illegal BCC			S006 S030	BCC error has been detected in the user program in the RAM. (Error down) If the error remains after power OFF and ON again, reload the program and execute EEPROM write operation.
RAM check error	Error address	Error data	Test data	S004 S012	In the power-up initialization, an error has detected by RAM read/write checking. (Error down) Replace the unit if the error remains after power OFF and ON again.
Scan time over	Scan time			S006 S031	The scan time has exceeded 200 ms. (Error down) Correct the program to reduce the scan time or use WDT instruction to extend the check time.

## 10. Troubleshooting

Error message and related information				Special device	Meaning and countermeasures
Event	Info 1	Info 2	Info 3		
Sys RAM check err	Error address	Error data	Test data	S004 S011	In the power-up initialization, an error has detected by system RAM read/write checking. (Error down and programming tool cannot be connected) Replace the unit if the error remains after power OFF and ON again.
Sys ROM BCC error	Illegal BCC			S004 S010	BCC error has been detected in the system program in the ROM. (Error down and programming tool cannot be connected) Replace the unit if the error remains after power OFF and ON again.
System power off					Power OFF (no error)
System power on					Power ON (no error)
Sub-r nesting err	Program type - block No.	Address in the block	Sub-r No.		T1: CALL instruction is programmed in a subroutine program. (Error down) Correct the program. ----- T1S: The nesting of subroutines exceeds 3 levels. (Error down) Correct the program.
WD timer error	Address 1	Address 2		S004 S01F	The watchdog timer error has occurred. (Error down) If the error occurs frequently, replace the unit.

---

---

# *Appendix*

---

---

- A.1 List of models and types, 306*
- A.2 Instruction index, 309*

## Appendix

### A.1 List of models and types

- **Basic unit**

Model	Power supply	Input type	Type code	Part number
T1-16	100 - 240 Vac	Dry contact	T1-MDR16	TDR116*6S
		120 Vac	T1-MAR16	TAR116*6S
	24 Vdc	24 Vdc	T1-MDR16D	TDR116*3S
T1-28	100 - 240 Vac	24 Vdc	T1-MDR28	TDR128*6S
		120 Vac	T1-MAR28	TAR128*6S
	24 Vdc	24 Vdc	T1-MDR28D	TDR128*3S
T1-40	100 - 240 Vac	24 Vdc	T1-MDR40	TDR140*6S
		120 Vac	T1-MAR40	TAR140*6S
	24 Vdc	24 Vdc	T1-MDR40D	TDR140*3S
T1-40S	100 - 240 Vac	24 Vdc	T1-MDR40S	TDR140S6S
		120 Vac	T1-MAR40S	TAR140S6S
	24 Vdc	24 Vdc	T1-MDR40SD	TDR140S3S

- **Option card**

Description	Type code	Part number
16 points 24 Vdc input	DI116	TDI116*BS
16 points 24 Vdc output	DO116	TDO116*BS
8 points 24 Vdc input and 8 points 24 Vdc output	DD116	TDD116*BS
2 channels analog input, 0 - 5 V/0 - 20 mA	AD121	TAD121*BS
2 channels analog input, $\pm 10$ V	AD131	TAD131*BS
2 channels analog output, 0 - 20 mA	DA121	TDA121*BS
2 channels analog output, $\pm 10$ V	DA131	TDA131*BS
TOSLINE-F10 remote station	FR112	TFR112*BS

- **Expansion unit**

Description	Type code	Part number
16 points 24 Vdc input and 16 points relay output (with 0.5 m cable)	T1-EDR32	TDR132E*S
16 points 120 Vac input and 16 points relay output (with 0.5 m cable)	T1-EAR32	TAR132E*S

- **Expansion rack**

Description	Type code	Part number
2-slot for T2 I/O modules (with 0.15 m cable)	BU152	TBU152**S
4-slot for T2 I/O modules (with 0.15 m cable)	BU154	TBU154**S

• **T2 I/O modules**

Description			Type code	Part number
16 points 24 Vdc/ac input			DI31	EX10*MDI31
32 points 24 Vdc input			DI32	EX10*MDI32
64 points 24 Vdc input			DI235	TDI235**S
16 points 120 Vac input			IN51	EX10*MIN51
16 points 240 Vac input			IN61	EX10*MIN61
12 points relay output			RO61	EX10*MRO61
8 points isolated relay output			RO62	EX10*MRO62
16 points transistor output			DO31	EX10*MDO31
32 points transistor output			DO32	EX10*MDO32
64 points transistor output			DO235	TDO235**S
16 points transistor output (current source)			DO233P	TDO233P*S
12 points triac output			AC61	EX10*MAC61
4 channel analog input	8-bit resolution	4 - 20 mA / 1 - 5 V	AI21	EX10*MAI21
		0 - 10 V	AI31	EX10*MAI31
	12-bit resolution	4 - 20 mA / 1 - 5 V	AI22	EX10*MAI22
		±10 V	AI32	EX10*MAI32
2 channel analog output	8-bit resolution	4 - 20 mA / 1 - 5 V /	AO31	EX10*MAO31
		0 - 5 V / 0 - 10 V		
	12-bit resolution	4 - 20 mA / 1 - 5 V	AO22	EX10*MAO22
		±10 V	AO32	EX10*MAO32
1 channel pulse input, 5/12 V, 100 kHz max.			PI21	EX10*MPI21
1 axis position control, pulse output, 200 kHz max.			MC11	EX10*MMC11
Communication interface, 1 port of RS-232C			CF211	TCF211**S

• **Peripherals**

Description	Type code	Part number
Handy programmer (with 2 m cable for T1/T1S)	HP911A	THP911A*S
T-PDS software (MS-DOS version)	T-PDS	TMM33I1SS
T-PDS software (Windows version)	T-PDS Windows	TMW33E1SS
Program storage module	RM102	TRM102**S
Multi-drop adapter for computer link	CU111	TCU111**S

## Appendix

- **Cable and others**

Description	Type code	Part number
T-PDS cable for T1/T1S, 5m length	CJ105	TCJ105*CS
HP911A cable for T1/T1S, 2m length (spare parts)	CJ102	TCJ102*CS
RS-232C connector for computer link (with 2 m cable)	PT16S	TPT16S*AS
Option card I/O connector for DI116/DO116/DD116, soldering type	PT15S	TPT15S*AS
Option card I/O connector for DI116/DO116/DD116, flat cable type	PT15F	TPT15F*AS
Expansion rack cable, 0.15 m (spare parts)	CS1R2	TCS1R2*CS
Empty slot cover for expansion rack	–	EX10*ABP1

## A.2 Instruction index

### • Instruction name

1 bit rotate left 191  
 1 bit rotate right 190  
 1 bit shift left 183  
 1 bit shift right 182  
 2's complement 250  
 7-segment decode 252  
 Absolute value 249  
 Addition 161  
 Addition with carry 167  
 AND 174  
 ASCII conversion 254  
 ASCII to Hex conversion 180  
 Average value 246  
 BCD conversion 256  
 Bi-directional shift register 188  
 Binary conversion 255  
 Bit count 220  
 Bit test 181  
 Calendar operation 236  
 Coil 139  
 Counter 150  
 Data exchange 157  
 Data transfer 154  
 Decode 219  
 Decrement 173  
 Demultiplexer 195  
 Device/register reset 215  
 Device/register set 214  
 Digital filter 178  
 Direct I/O 257  
 Disable interrupt 227  
 Division 164  
 Double-word 2's complement 251  
 Double-word addition 165  
 Double-word data transfer 155  
 Double-word equal 204  
 Double-word greater than 202  
 Double-word greater than or equal 203  
 Double-word less than 206  
 Double-word less than or equal 207  
 Double-word not equal 205  
 Double-word subtraction 166  
 Enable interrupt 226  
 Encode 218  
 End 153  
 Equal 198  
 Exclusive OR 176  
 Expanded data transfer 259  
 Flip-flop 233  
 FOR 223  
 Forced coil 140  
 Function generator 247  
 Greater than 196  
 Greater than or equal 197  
 Hex to ASCII conversion 179  
 Increment 172  
 Interrupt return 228  
 Invert coil 142  
 Invert transfer 156  
 Inverter 141  
 Jump control reset 152  
 Jump control set 152  
 Less than 200  
 Less than or equal 201  
 Lower limit 243  
 Master control reset 151  
 Master control set 151  
 Maximum value 244  
 Minimum value 245  
 Moving average 177  
 Multiplexer 194  
 Multiplication 163  
 n bit rotate left 193  
 n bit rotate right 192  
 n bit shift left 185  
 n bit shift right 184  
 NC contact 136  
 Negative pulse coil 146  
 Negative pulse contact 144  
 NEXT 224  
 NO contact 135  
 Not equal 199  
 OFF delay timer 148  
 ON delay timer 147  
 OR 175  
 Positive pulse coil 145  
 Positive pulse contact 143  
 Pre-derivative real PID 237  
 Reset carry 217  
 Set calendar 235  
 Set carry 216  
 Shift register 186

## Appendix

Single shot timer [149](#)  
Special module data read [263](#)  
Special module data write [265](#)  
Step sequence initialize [230](#)  
Step sequence input [231](#)  
Step sequence output [232](#)  
Subroutine call [221](#)  
Subroutine entry [225](#)  
Subroutine return [222](#)  
Subtraction [162](#)  
Subtraction with carry [168](#)  
Table initialize [158](#)  
Table invert transfer [160](#)  
Table transfer [159](#)  
Transitional contact (falling) [138](#)  
Transitional contact (rising) [137](#)  
Unsigned division [170](#)  
Unsigned double/single division [171](#)  
Unsigned equal [210](#)  
Unsigned greater than [208](#)  
Unsigned greater than or equal [209](#)  
Unsigned less than [212](#)  
Unsigned less than or equal [213](#)  
Unsigned multiplication [169](#)  
Unsigned not equal [211](#)  
Up-down counter [234](#)  
Upper limit [242](#)  
Watchdog timer reset [229](#)



- Instruction symbol

* 163	FG 247	U/D 234
+ 161	FOR 223	U< 212
+1 172	HTOA 179	U<= 213
+C 167	I/O 257	U<> 211
- 162	IRET 228	U= 210
-1 173	JCR 152	U> 208
-C 168	JCS 152	U>= 209
/ 164	LL 243	UL 242
< 200	MAVE 177	WDT 229
<= 201	MAX 244	WRITE 265
<> 199	MCR 151	XCHG 157
= 198	MCS 151	XFER 259
> 196	MIN 245	
>= 197	MOV 154	
7SEG 252	MPX 194	
ABS 249	NEG 250	
AND 174	NEXT 224	
ASC 254	NOT 156	
ATOH 180	OR 175	
AVE 246	PID3 237	
BC 220	READ 263	
BCD 256	RET 222	
BIN 255	RST 215	
CALL 221	RSTC 217	
CLDN 235	RTL 193	
CLDS 236	RTL1 191	
CNT 150	RTR 192	
D+ 165	RTR1 190	
D- 166	SET 214	
D< 206	SETC 216	
D<= 207	SHL 185	
D<> 205	SHL1 183	
D= 204	SHR 184	
D> 202	SHR1 182	
D>= 203	SR 186	
DEC 219	SS 149	
DFL 178	STIN 231	
DI 227	STIZ 230	
DIV 171	STOT 232	
DMOV 155	SUBR 225	
DNEG 251	TEST 181	
DPX 195	TINZ 158	
DSR 188	TMOV 159	
EI 226	TNOT 160	
ENC 218	TOF 148	
END 153	TON 147	
EOR 176	U* 169	
F/F 233	U/ 170	

## Free Manuals Download Website

<http://myh66.com>

<http://usermanuals.us>

<http://www.somanuals.com>

<http://www.4manuals.cc>

<http://www.manual-lib.com>

<http://www.404manual.com>

<http://www.luxmanual.com>

<http://aubethermostatmanual.com>

Golf course search by state

<http://golfingnear.com>

Email search by domain

<http://emailbydomain.com>

Auto manuals search

<http://auto.somanuals.com>

TV manuals search

<http://tv.somanuals.com>