

Quick Installation Guide

AV600 Gigabit Powerline Adapter

MODEL NO. TL-PA6010

Package Contents

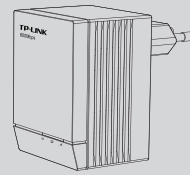

Powerline Adapter*



QIG

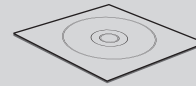

Resource CD



Ethernet Cable

*The provided power plug may differ from the picture due to different regional power specifications. Here we take the EU version as an example.

Warning on Final Location

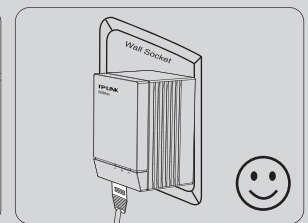
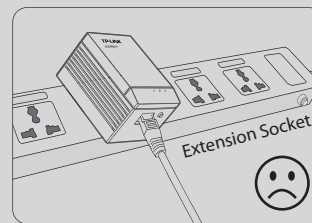

NOTE: It's strongly recommended that you plug the adapter directly into the wall socket, for some power strips have surge protector which can filter data.

7106504321 REV1.0.0

1 LED and Button Descriptions

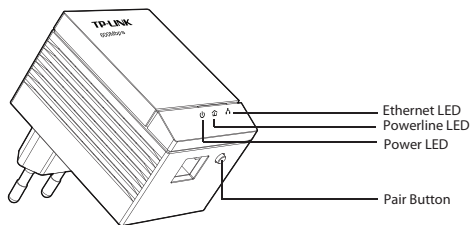

Item	Status	Description
	Solid	The adapter is on.
	Blinking	The adapter is in power-saving mode or in pairing procedure.
	Off	The adapter is off.
	Solid	The adapter is connected to a powerline network.
	Blinking	The adapter is transferring data.
	Off	The adapter isn't connected to any powerline network or is in power-saving mode.*
	Solid	The Ethernet port is connected, but there is no data being transferred.
	Blinking	The Ethernet port is transferring data.
	Off	The Ethernet port isn't connected.

* Five minutes after the device connected to the adapter is turned off, the adapter will automatically switch to power-saving mode.

Item	Description
Pair Button	Pair button is used to secure a powerline network. To secure your network, please refer to Appendix: Using the Pair Button .

2 Network Installation

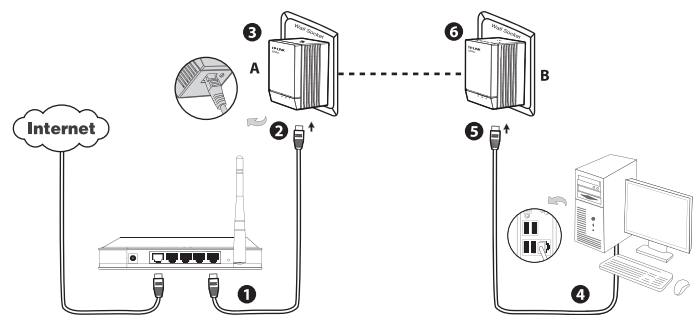

TP-LINK powerline adapters are Plug and Play. After taking the steps above, you can surf the Internet.

To add another adapter

Plug an additional adapter into the wall socket, and the connection will be established automatically within 60 seconds.

NOTE:

- To surf the Internet, please make sure that your network is properly connected to the Internet.
- If the adapters fail to automatically link to each other, you can establish a private network by using the pair button. To set up a private network, please go to **Appendix: Using the Pair Button** for detailed instructions.

Appendix: Using the Pair Button (Setting up a private network)

To set up a private network :

1. Press the pair button on adapter A for 1 second and the Power LED will begin flashing. If pressed till all the LEDs turn off (about 10 seconds), the adapter will leave the network.
 2. Within 2 minutes, press the pair button on adapter B for 1 second and the Power LED will begin flashing as well.
 3. In about 60 seconds you'll see the Powerline LEDs on both adapters light up, indicating the two adapters have intercommunicated with each other successfully.
- * It is highly recommended to first set up the two adapters in the same room or on the same power strip and then place them in a suitable location.

To join an existing private network:

If you want to add adapter C to the existing private network, please follow the steps.

1. Press the pair button on the adapter A or B for 1 second (do not press both), and the Power LED will begin flashing.
2. Within 2 minutes press the pair button on adapter C for 1 second, the Powerline LED on the adapter C will light up in about 60 seconds.

* You can follow the steps above to add more adapters to the private network one by one.

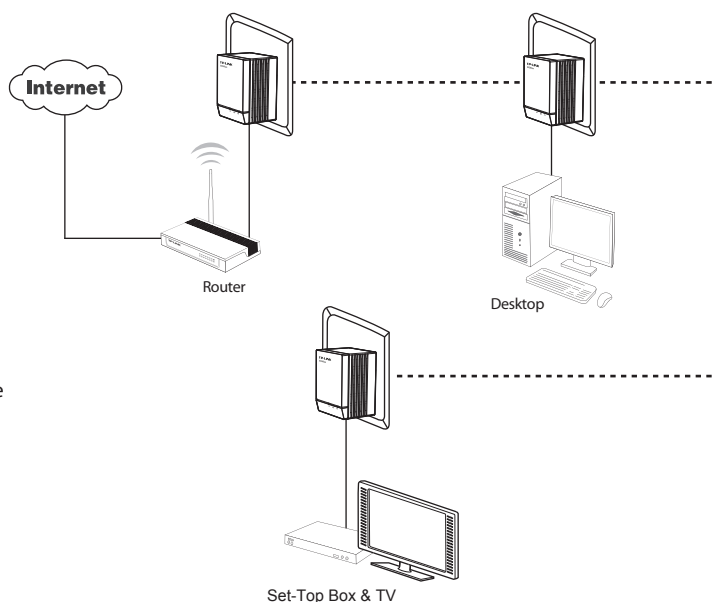

NOTE:

More advanced configuration, such as reset, firmware upgrade and QoS configuration can be accessed through the utility, so install the Powerline Utility if necessary. (Only for Windows).

For detailed instructions, please refer to the User Guide on the Resource CD.

Troubleshooting

Q1. I have followed the above instructions but my dapters are still not working. What can I do?

1. Make sure all the adapters are under the same electric meter.
2. If the Power LED does not light up at all, there may be a hardware problem.
3. The PLC devices might not communicate with each other if they are in different phases of a four-wire three-phase circuit.
4. As some power strips have surge protector, please make sure the adapters are not separated by the power strips.

Q2. The adapters were working fine but no longer work now that they've been moved. How do I make them work again?

Plug the adapters into the same power strip and follow **Appendix: Using the Pair Button** to pair them. If they still don't work, please check for possible interference causes:

1. Air-conditioners, washing machines, and other similar household appliances are working too close to the adapters.
2. Air switch may lead to failed communication among PLC devices; check whether there are air switches hindering communication.

Technical Support

- For more troubleshooting help, go to www.tp-link.com/en/support/faq
- To download the latest Firmware, Driver, Utility and User Guide, go to www.tp-link.com/en/support/download
- For all other technical support, please contact us by using the following details:

Global

Tel: +86 755 26504400
E-mail: support@tp-link.com
Service time: 24hrs, 7 days a week

Singapore

Tel: +65 62840493
E-mail: support.sg@tp-link.com
Service time: 24hrs, 7 days a week

Italy

Tel: +39 023 051 9020
E-mail: support.it@tp-link.com
Service time: Monday to Friday,
09:00 to 13:00; 14:00 to 18:00

UK

Tel: +44 (0) 845 147 0017
E-mail: support.uk@tp-link.com
Service time: 24hrs, 7days a week

USA/Canada

Toll Free: +1 866 225 8139
E-mail: support.usa@tp-link.com
Service time: 24hrs, 7days a week

Malaysia

Tel: 1300 88 875465
E-mail: support.my@tp-link.com
Service time: 24hrs, 7days a week

Russian Federation

Tel: 8 (499) 754-55-60
8 (800) 250-55-60 (toll-free call from any RF region)
E-mail: support.ru@tp-link.com
Service time: From 10:00 to 18:00
(Moscow time)

*Except weekends and holidays in Russian Federation

Germany / Austria

Tel :+49 1805 875465 (German Service)
+49 1805 TPLINK +43 820 820 360
E-mail: support.de@tp-link.com
Fee: 0.14 EUR/min from the German fixed phone network and up to 0.42EUR/min from mobile phone.
Service Time: Monday to Friday, 09:00 to 12:30 and 13:30 to 17:30. GMT+1 or GMT+2 (Daylight Saving Time in Germany)
* Except bank holidays in Hesse

Australia & New Zealand

Tel: AU 1300 87 5465 NZ 0800 87 5465
E-mail: support.au@tp-link.com (Australia)
support.nz@tp-link.com (New Zealand)
Service time: 24hrs, 7 days a week

Turkey

Tel: 0850 7244 488 (Turkish Service)
E-mail: support.tr@tp-link.com
Service time: 09:00 to 21:00 7days a week

Ukraine

Tel: 0800 505 508
E-mail: support.ua@tp-link.com
Service time: Monday to Friday 10:00 to 22:00

France

Tel: +33 (0) 820 800 860 (French service)
E-mail: support.fr@tp-link.com
Fee: 0.118 EUR/min from France
Service time: Monday to Friday, 09:00 to 18:00
*Except French Bank holidays

Brazil

Toll Free: 0800 608 9799 (Portuguese Service)
E-mail: suporte.br@tp-link.com
Service time: Monday to Friday 09:00 to 20:00; Saturday, 09:00 to 15:00

Indonesia

Tel: (+62) 021 6386 1936
E-mail: support.id@tp-link.com
Service time: Monday to Friday
9:00 -18:00

*Except public holidays

Switzerland

Tel: +41 (0)848 800998 (German Service)
E-mail: support.ch@tp-link.com
Fee: 4-8 Rp/min, depending on rate of different time

Service time: Monday to Friday 09:00 to 12:30 and 13:30 to 17:30. GMT+ 1 or GMT+ 2 (Daylight Saving Time)

Poland

Tel: +48 (0) 801 080 618 / +48 223 606 363 (if calls from mobile phone)
E-mail: support.pl@tp-link.com
Service time: Monday to Friday 9:00 to 17:00. GMT+1 or GMT+2 (Daylight Saving Time)

Free Manuals Download Website

<http://myh66.com>

<http://usermanuals.us>

<http://www.somanuals.com>

<http://www.4manuals.cc>

<http://www.manual-lib.com>

<http://www.404manual.com>

<http://www.luxmanual.com>

<http://aubethermostatmanual.com>

Golf course search by state

<http://golfingnear.com>

Email search by domain

<http://emailbydomain.com>

Auto manuals search

<http://auto.somanuals.com>

TV manuals search

<http://tv.somanuals.com>