

Quick Installation Guide

H.264 Megapixel Surveillance Camera/
Wireless N H.264 Megapixel Surveillance Camera

MODEL NO. TL-SC3430/TL-SC3430N

Package Contents

The product model shown in this QIG is TL-SC3430N, as an example.

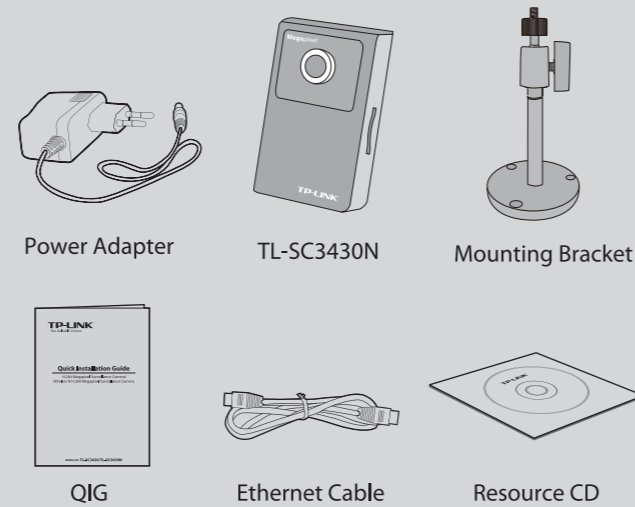

(*The pictures are for reference only.)

System Requirement

The following operating systems are supported:

- Windows 2000
- Windows 2003
- Windows XP
- Windows Vista
- Windows 7
- Mac

The following browsers are supported:

- Internet Explorer 6 or higher
- Safari
- Firefox
- Chrome

(*Windows and Internet Explore Browser are recommended.)

1 Warning Before Installation

- Do not keep the Camera exposed to direct sunlight.
- Do not place the Camera in high humidity environments such as in a kitchen.
- Do not place the Camera where there are high temperatures such as near an oven.
- Do not place the Camera near devices that emit radio waves, such as mobile phones.

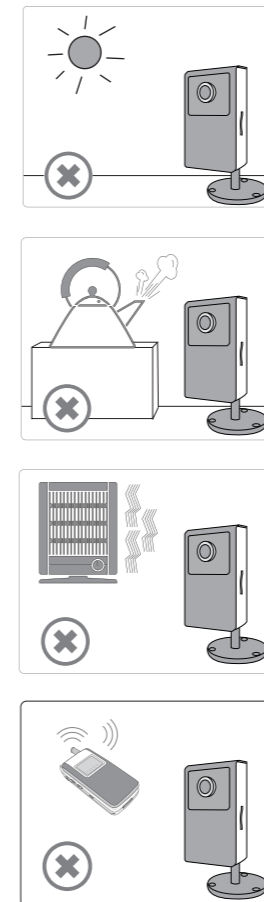

* It is recommended to mount the Camera where objects often pass, and the direction towards the door or passage is much better, see the illustration below:

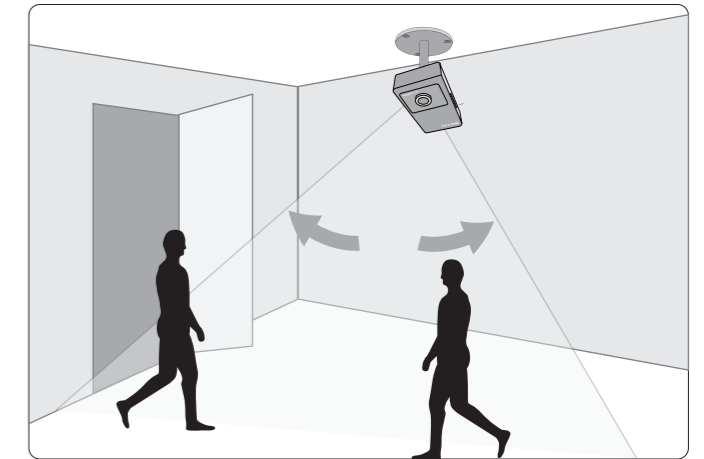

2 Physical Description

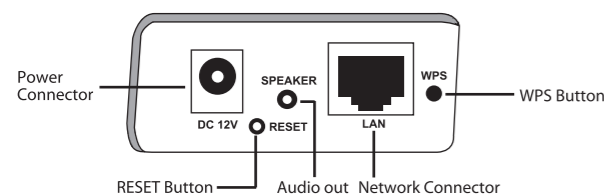
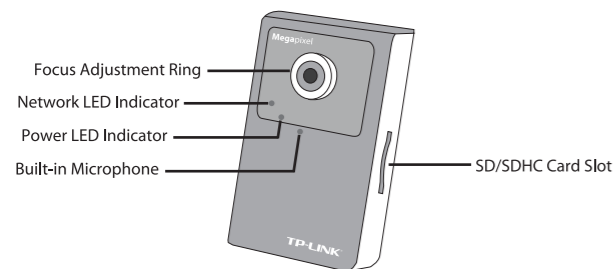

| Item | Description |
|-------------------|--|
| Power LED | Red - The IP Camera boots up. Blue - The IP Camera is working. |
| Network LED | Solid - The network port is linked, but there is no activity. Blinking - There is traffic between the Camera and the network. Off - There is no network connection. |
| SD/SDHC Card Slot | Used to plug SD/SDHC memory card. |
| RESET Button | Press the button for more than 15 seconds, then it will be restored to factory defaults after rebooting automatically. |
| WPS | Used to easily connect the Camera to the router supporting WPS. |

* There is no SD/SDHC Card Slot or WPS button on TL-SC3430.

3 Hardware Connection

- * 1. For TL-SC3430, please go to **Wired Connection** to set up a network connection.
- 2. For TL-SC3430N, if your router supports **WPS** (Wi-Fi Protected Setup), you can also use WPS to set up a wireless connection quickly.

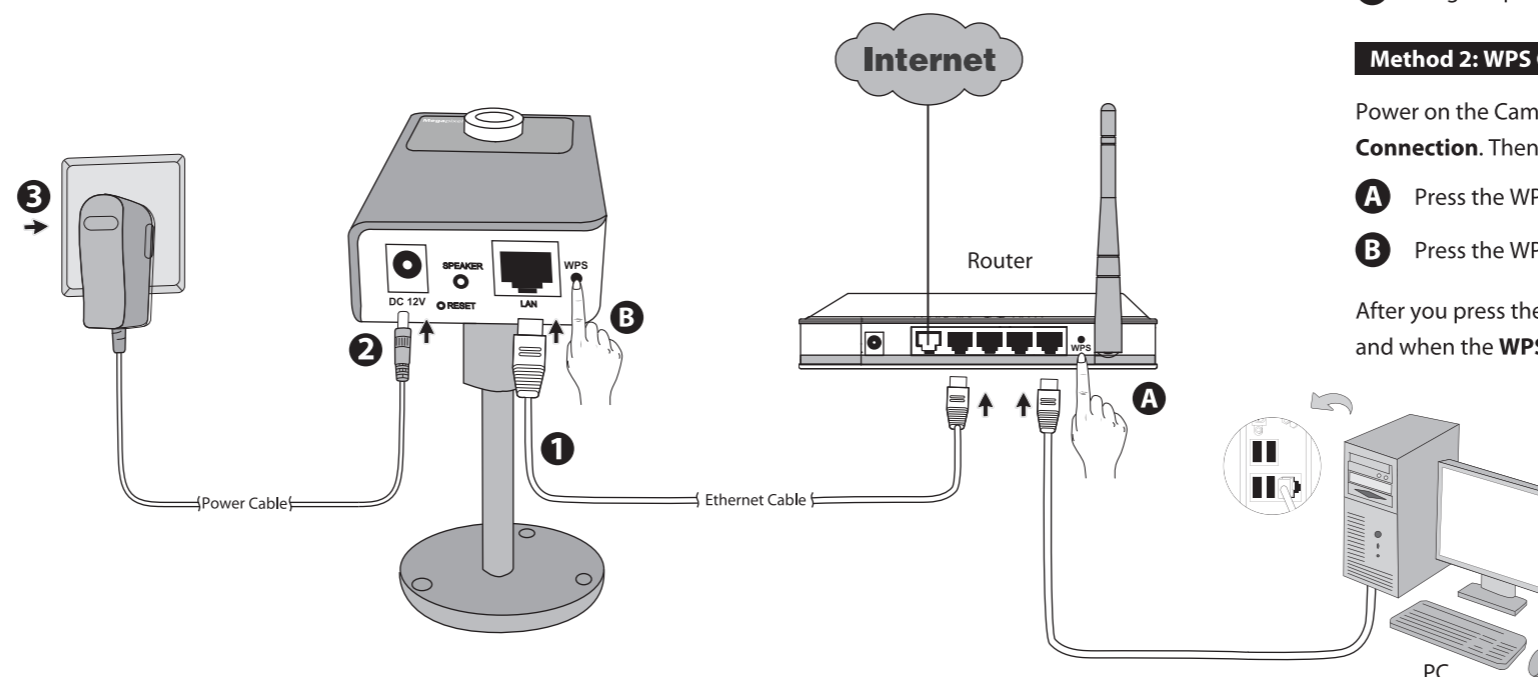

Method 1: Wired Connection

- 1 Connect the Camera to the LAN network (Router or Switch) via Ethernet cable.
- 2 Connect the power adapter cord to the DC In jack.
- 3 Plug the power adapter into the power outlet.

Method 2: WPS Connection

Power on the Camera and make sure that the Power LED is blue before **WPS Connection**. Then take the following steps.

- A Press the WPS button on the router supporting WPS for 2 seconds.
- B Press the WPS button on the Camera for 2 seconds within 2 minutes.

After you press the WPS button on the Camera, the Power LED will turn purple and flash, and when the **WPS Connection** is established successfully, it will return blue.



Before proceeding, confirm that your PC is connected to your router and can access the Internet.

Make sure that your router's DHCP feature is enabled. If not, please refer to your router's instruction to enable it.

4 Access the Camera (For Windows Web Browser)

The configuration is similar in Windows XP/Vista/7. Here we take Internet Explorer 6.0 in Windows XP for example.

1 Insert the provided Resource CD into your CD-ROM drive.

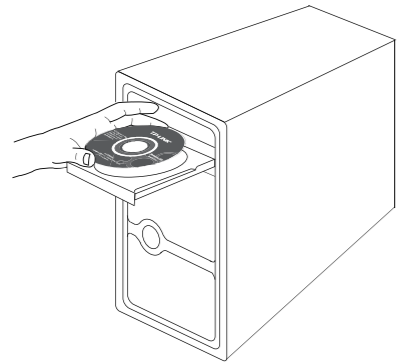

2 The Setup Wizard will automatically pop up, then click "Intelligent IP Installer".¹



3 The Intelligent IP Installer window will appear. Click "Next".

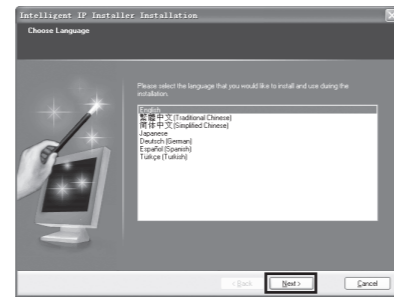

4 Select the optional program as needed. The default setting is highly recommended. Click "Next".

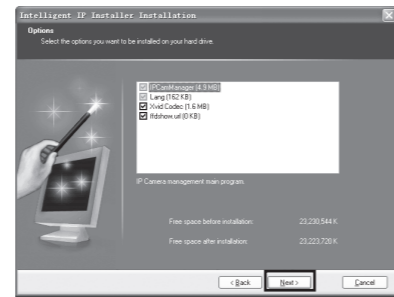

5 Click "Finish" to complete the setup. The icon of Intelligent IP Installer will show up on the computer's Desktop.

6 Click the icon of Intelligent IP Installer on the computer's Desktop.

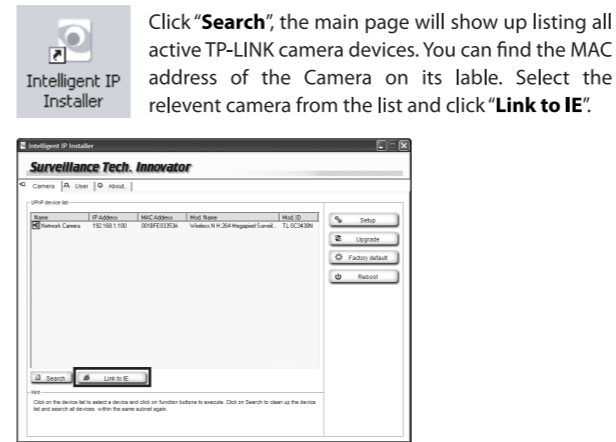

7 Enter User name and Password to log in to the IP Camera. (Default is admin / admin)



8 When accessing the IP Camera for the first time, a yellow information bar will appear below the address bar. Click the information bar, and select "Install ActiveX Control...". Click "Install" on the pop-up screen.²



9 Live video displays in the centre of your web browser.



- Note**
1. If the CD does not automatically run with the installation window appearing, find the CD drive in "My Computer" space and run it directly there.
 2. If the information bar does not show up, please refer to Appendix: Troubleshooting.

For advanced settings, please refer to the User Manual and Application Guide on Resource CD.

Access the Camera (For Mac Web Browser)

1 Click the icon of Safari.

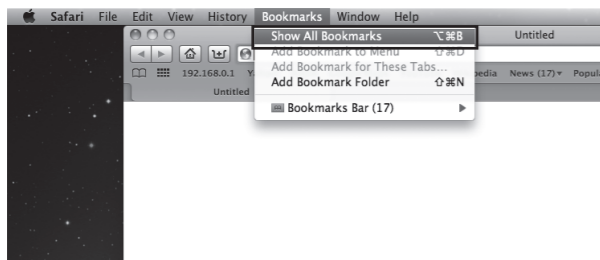
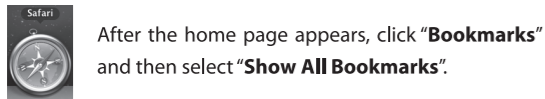

2 Click Bonjour on the left of the following screen. Double click the MAC address of the Camera in the bookmark list.

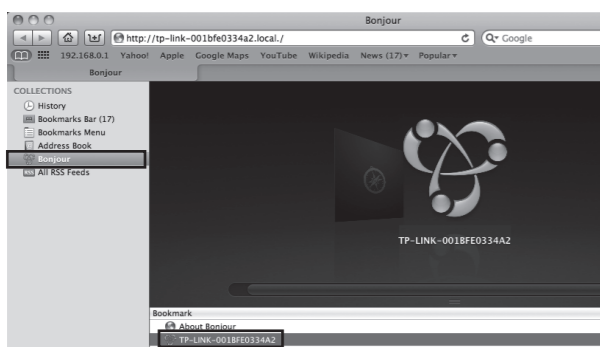

3 Enter Name and Password to log in to the IP Camera. (Default is admin / admin)

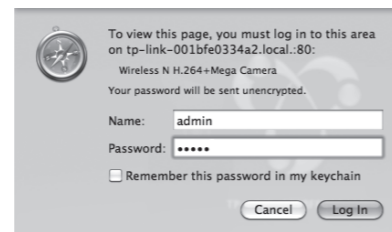

4 The monitor image will be displayed in your browser.



For advanced settings, please refer to the User Manual and Application Guide on Resource CD.

Appendix: Troubleshooting

1 What if the information bar does not show up?

- 1) Open IE browser. Click "Tools", then select "Internet Options..."
- 2) Click "Security" -> "Internet" -> "Custom Level...". Find the item "Download signed ActiveX controls" and check "Prompt". Click "OK".
- 3) Click "Security" -> "Local Intranet" -> "Custom Level...". Find the item "Download signed ActiveX controls" and check "Prompt". Click "OK".

2 What can I do if I forgot the login name and password?

Keep the Camera powered on, then press and hold the Reset button for more than 15 seconds. Afterwards release it, and the Camera will be restored to factory defaults after rebooting. Both the default name and password are admin.

3 If the image is blurry, what can I do?

Please adjust the IP Camera's focus by rotating the Lens.

4 Is the Remote Access available by using notebook or 3G mobile?

Yes, it is available. For detailed configuration, please refer to the Application Guide on Resource CD or FAQ on our website.

5 Does the Camera support NAS storage?

Yes, both TL-SC3430 and TL-SC3430N support NAS storage. For detailed configuration, please refer to the Application Guide on Resource CD.

6 Does the Camera support Safari, Firefox, and Chrome?

So far, in the above Explorers, only JPEG streaming of the Camera is available; most of the settings can be configured.

We are updating the firmware of the Camera for fluent video streaming. You can download the latest firmware from our website once the firmware is updated.

For detailed Troubleshooting and Technical Support contact, please log on to our Technical Support Website.

<http://www.tp-link.com/support/Support.asp>

Technical Support

- For more troubleshooting help, go to www.tp-link.com/support/faq.asp
 - To download the latest Firmware, Driver, Utility and User Guide, go to www.tp-link.com/support/download.asp
 - For all other technical support, please contact us by using the following details:
- | | |
|--|--|
| <p>Global Tel: +86 755 26504400 E-mail: support@tp-link.com Service time: 24hrs, 7days a week</p> <p>Singapore Tel: +65 62840493 E-mail: support.sg@tp-link.com Service time: 24hrs, 7days a week</p> <p>UK Tel: +44 (0) 845 147 0017 E-mail: support.uk@tp-link.com Service time: 24hrs, 7days a week</p> <p>Malaysia Tel: 1300 88 875465 (1300 88TPLINK) E-mail: support.my@tp-link.com Service time: 24 hrs a day, 7days a week</p> <p>USA/Canada Toll Free: +1 866 225 8139 E-mail: support.usa@tp-link.com Service time: 24hrs, 7days a week</p> <p>Turkey Tel: 444 19 25 (Turkish Service) E-mail: support.tr@tp-link.com Service time: 9:00 AM to 6:00 PM, 7days a week</p> <p>Brazilian (Portuguese Service) Toll Free: 0800-770-4337 E-mail: suporte.br@tp-link.com Service time: Monday to Saturday 08:00 AM to 08:00 PM</p> <p>Switzerland Tel: +41 (0)848 800998 (German service) E-mail: support.ch@tp-link.com Fee: 4-8 Rp/min, depending on rate of different time Service time: Monday to Friday 9:00 AM to 6:00 PM. GMT+1 or GMT+2 (Daylight Saving Time)</p> | <p>Italy Tel: +39 02 66987799 E-mail: support.it@tp-link.com Service time: 9:00 AM to 6:00 PM, from Monday to Friday</p> <p>Ukrainian Tel: +380 (44) 590-51-14 E-mail: support.ua@tp-link.com Service time: Monday to Friday 14:00 PM to 22:00 PM</p> <p>Australia & New Zealand Tel: AU 1300 87 5465 NZ 0800 87 5465 E-mail: support@tp-link.com.au Service time: 24hrs, 7 days a week</p> <p>Indonesia Tel: (+62) 021 6259 135 E-mail: support.id@tp-link.com Service time: Monday to Friday 9:00 -12:00 ; 13:00 -18:00 *Except public holidays</p> <p>Russian Federation Tel: 8 (495) 223-55-60 8 (800) 250-55-60 (toll-free call from any RF region) E-mail: support.ru@tp-link.com Service time: From 10:00 to 18:00 (Moscow time) * Except weekends and holidays in Russian Federation</p> <p>Germany / Austria Tel: +49 1805 875465 (German Service) / +49 1805 TPLINK E-mail: support.de@tp-link.com Fee: 0.14 EUR/min from the German fixed phone network and up to 0.42 EUR/min from mobile phone. Service Time: Monday to Friday 9:00 AM to 6:00 PM. GMT+1 or GMT+2 (Daylight Saving Time in Germany) * Except bank holidays in Hesse</p> |
|--|--|

TP-LINK TECHNOLOGIES CO., LTD. www.tp-link.com

Free Manuals Download Website

<http://myh66.com>

<http://usermanuals.us>

<http://www.somanuals.com>

<http://www.4manuals.cc>

<http://www.manual-lib.com>

<http://www.404manual.com>

<http://www.luxmanual.com>

<http://aubethermostatmanual.com>

Golf course search by state

<http://golfingnear.com>

Email search by domain

<http://emailbydomain.com>

Auto manuals search

<http://auto.somanuals.com>

TV manuals search

<http://tv.somanuals.com>