



3651 N Highway 89 • Chino Valley, AZ 86323
(928) 636-7080 • www.p-a-g.net

**TOYOTA TACOMA
(AUTO. & MANUAL TRANS., 2 &
4WD, EXT. & CREW CAB, W/O
O.E. TRAILER HITCH)
3" BODY LIFT
INSTALLATION INSTRUCTIONS
2005-2006 KIT# 5603***

***VEHICLES EQUIPPED WITH O.E. TRAILER
HITCH REQUIRE KIT# 5903**

⚠ WARNING

Installation of a Performance Automotive Group body lift kit will change the vehicle's center of gravity and handling characteristics both on- and off-road. You must drive the vehicle safely! Extreme care must be taken to prevent vehicle rollover or loss of control, which could result in serious injury or death. Avoid sudden sharp turns or abrupt maneuvers and always make sure all vehicle occupants have their seat belts fastened.

⚠ WARNING

Before you install this kit, read and understand all instructions, warnings, cautions, and notes in this instruction sheet and in the vehicle owner's manual.

⚠ CAUTION

Proper installation of this kit requires knowledge of the factory recommended procedures for removal and installation of original equipment components. We recommend that the factory shop manual and any special tools needed to service your vehicle be on hand during the installation. Installation of this kit without proper knowledge of the factory recommended procedures may affect the performance of these components and the safety of the vehicle. We strongly recommend that a certified mechanic familiar with the installation of similar components install this kit.

⚠ WARNING

DO NOT combine suspension, body, or other lift devices. Use of vehicle with combined lifts may result in unsafe and/or unexpected handling characteristics.

⚠ WARNING

This kit should only be installed on a vehicle that is in good working condition. Before you install the kit, thoroughly inspect the vehicle for corrosion or deformation of the sheet metal around the factory body mounts. If the vehicle is suspected to have been in a collision or misused, do not install this kit. Off-road use of your vehicle with this kit installed may increase the stress applied to the factory body mounts. We do not recommend that any vehicle with a body lift kit installed be involved in any extreme off-road maneuvers such as jumping. Failure to observe this warning may result in serious personal injury and/or severe damage to your vehicle.

⚠ WARNING

Many states and municipalities have laws restricting bumper heights and vehicle lifts. Consult state and local laws to determine if the changes you intend to make to the vehicle comply with the law.

⚠ WARNING

The installation of larger tires may reduce the effectiveness of the braking system.

⚠ WARNING

Always wear eye protection when operating power tools.

⚠ WARNING

Before you install this kit, block the vehicle tires to prevent the vehicle from rolling.

⚠ WARNING

Accidental deployment of the air bag can result in serious personal injury or death. To avoid accidental deployment during installation of the kit, the Supplemental Restraint System (SRS, or airbag) must remain deactivated. Do not allow anyone near the airbag during installation. Refer to the factory service manual or owner's manual for the recommended procedure to disable the SRS. After you install the kit, reactivate the SRS before driving the vehicle.

NOTE

Performance Automotive Group recommends using the Loctite® supplied in the kit on the threads of all kit nuts and bolts unless specified otherwise in these instructions.

Before Starting Installation

NOTE
Kit parts are prefaced by the word *kit* and appear in **bold** print.

1. Carefully read all warnings and instructions completely before beginning.
2. Verify all parts have been received in this kit by checking the parts list at the end of this document.

NOTE
If parts are missing from kit, please be prepared to provide the following information:

1. **Name** of purchase location
2. **Bar Code** on side of box
3. **Date** above bar code
4. **Date** inside box cover
5. **Inspector #** from inside box cover

3. **Only install this kit on the vehicle for which it is specified.** If anytime during the installation you encounter something different from what is outlined in the instructions, call technical support at (928) 636-7080.
4. Special tools needed:
 - a. Welder or access to a professional welding shop.
 - b. Die grinder or similar tool capable of cutting metal.
5. Park vehicle on a clean, dry, flat, level surface and block tires so vehicle cannot roll in either direction.

Engine Compartment

1. Disconnect both battery cables. Disconnect negative cable first, then positive cable.

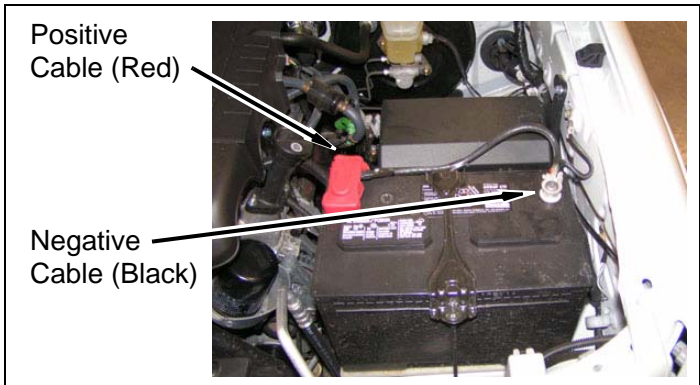

Inside Cab

1. Airbag Fuse

NOTE
The location of the airbag fuse may vary; check the owner's manual.

- a. Remove fuse cover.
- b. Remove airbag fuse.

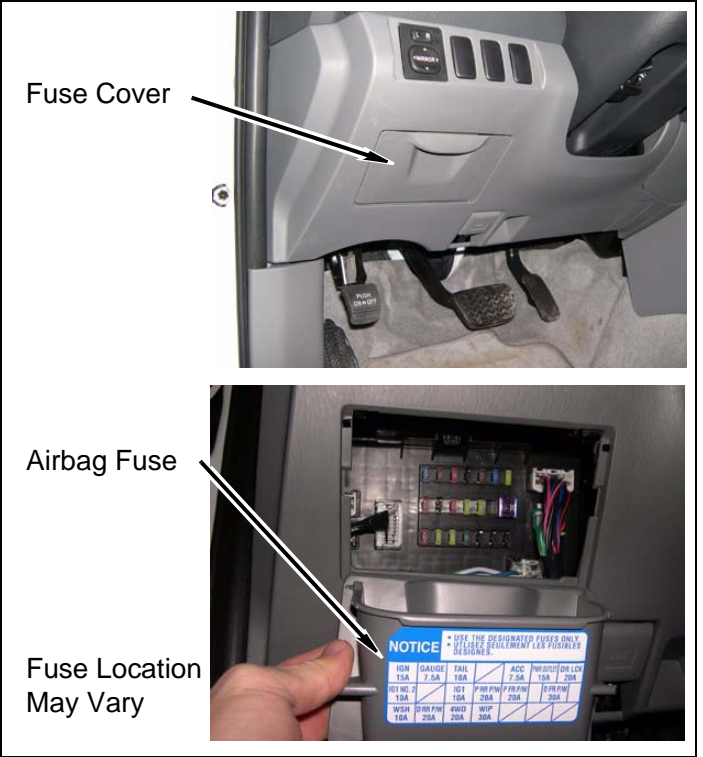

Prepare to Install Kit

Measurements

1. Measure and record distance between rear bumper and bed
 Driver Side _____ Passenger Side _____
2. Measure and record distance between cab and bed.
 Driver Side _____ Passenger Side _____

Front of Vehicle

1. Front bumper

- a. Remove wiring harnesses from fog lights, if equipped.

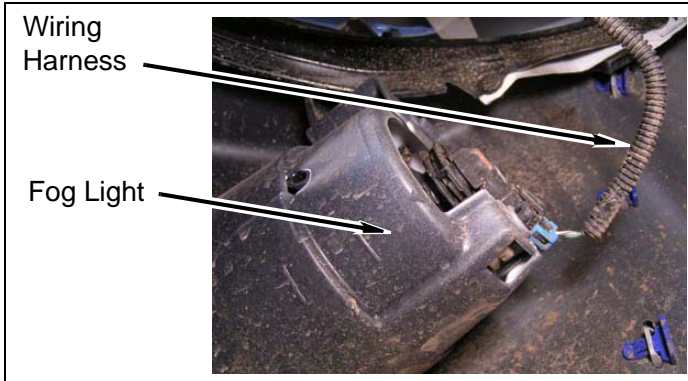

- b. Remove two pop-up clips, two bolts and grille from core support.

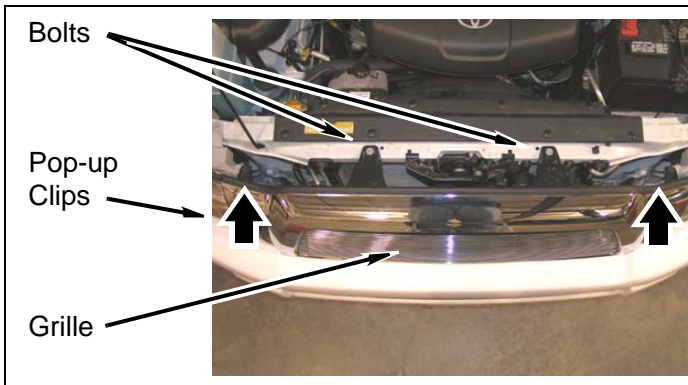

- c. Remove seven pop-up clips from front bumper.

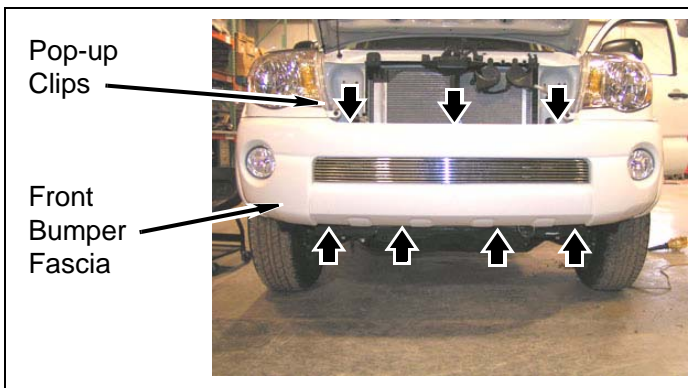

- d. Remove two pop-up clips from fender wells.

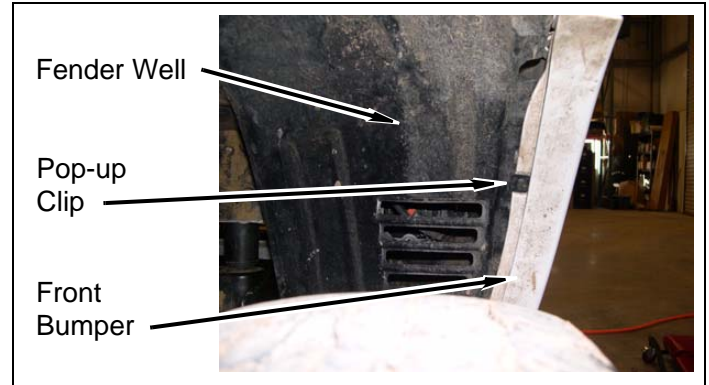

- e. Remove six screws and front bumper fascia from vehicle.

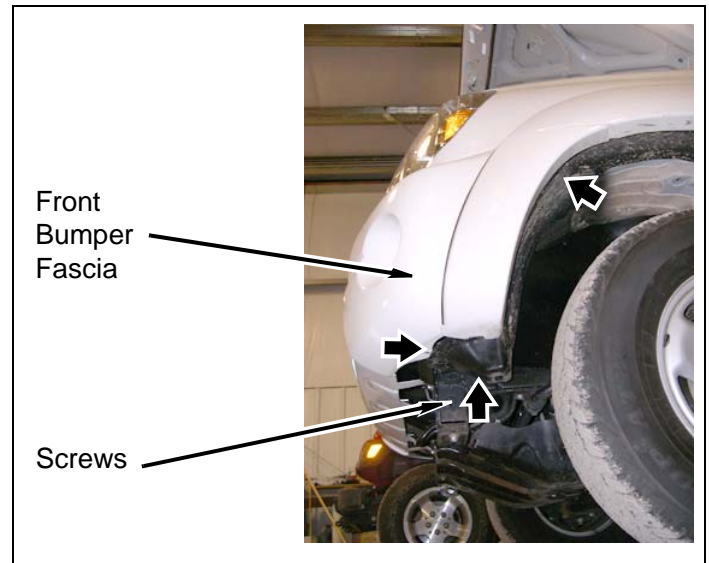

NOTE

Use caution when removing front bumper fascia from vehicle. Carefully pull outward from fenders on the sides of front bumper cover to loosen.

- f. Remove six nuts and front bumper from vehicle.

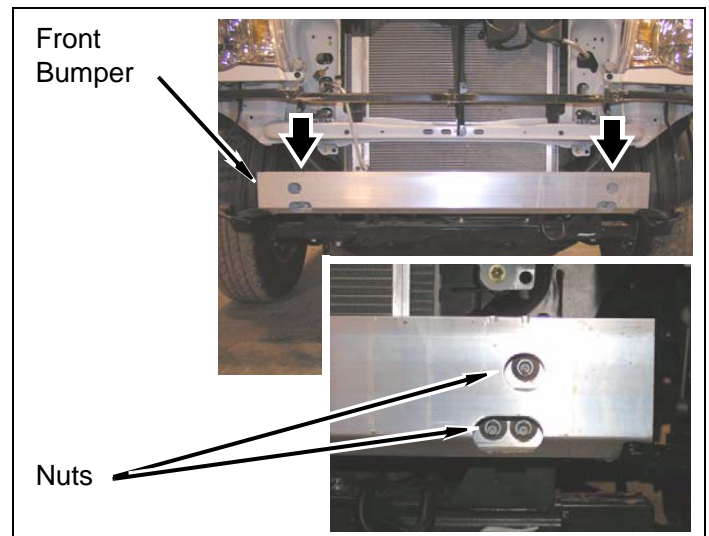

- g. Remove six nuts and two front bumper brackets from frame rails.

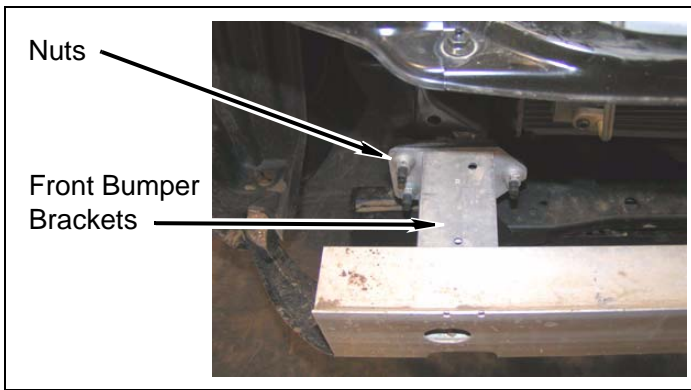

2. Automatic Transmission Cooler: (if equipped)

- a. Remove four bolts and allow automatic transmission cooler to hang loose from core support.

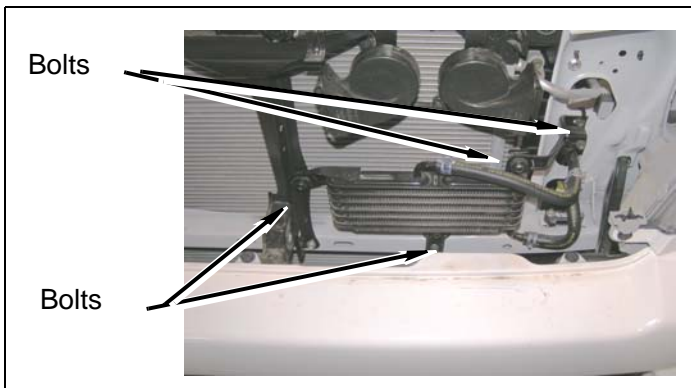

- b. Remove two bolts and automatic transmission cooler lines from lower core support.

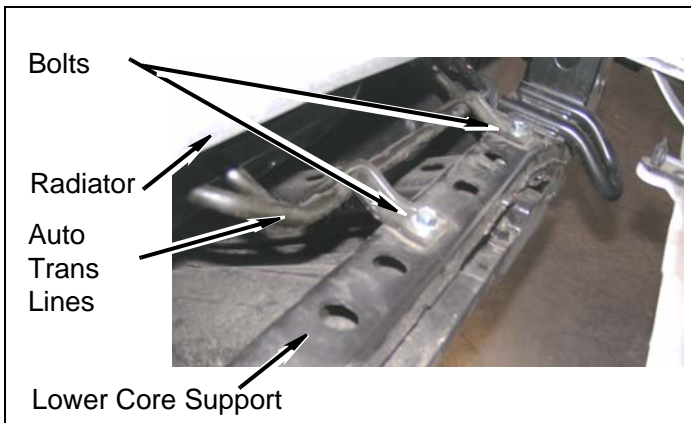

Engine Compartment

- 1. **6 cyl. models:** Loosen airbox clamp, two clips and remove airbox cover from engine.

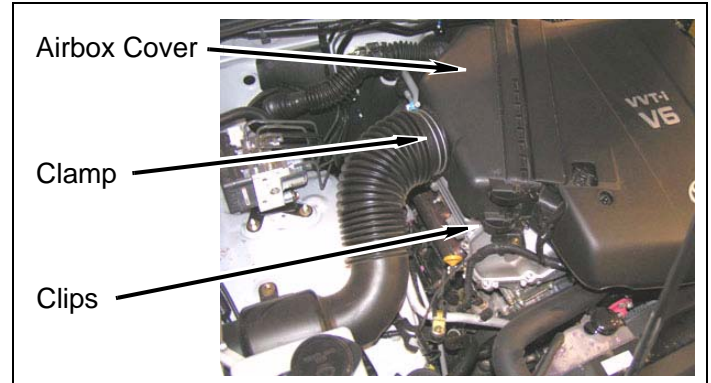

2. 6 cyl. models: AC Line

- a. Remove bolt and AC line bracket from body.

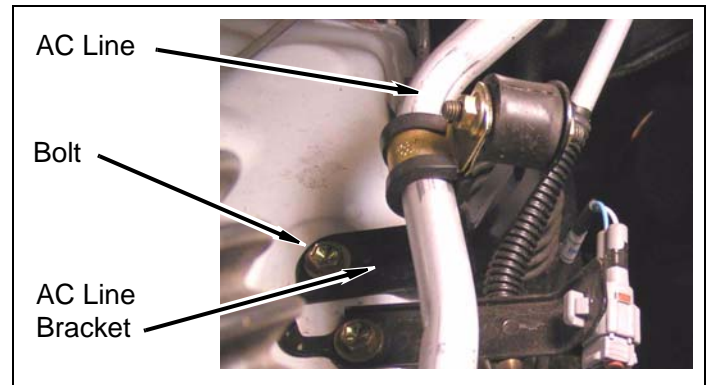

- b. Remove two nuts, clamp and rubber isolator from AC line and bracket.

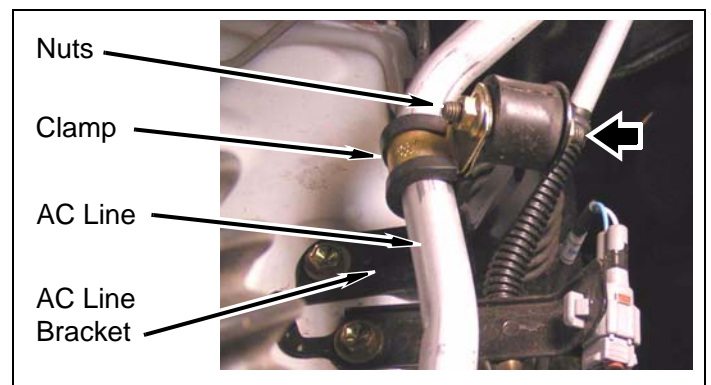

3. **6 cyl. models:** Remove power steering reservoir, three bolts and bracket from fender. DO NOT DISCONNECT power steering lines.

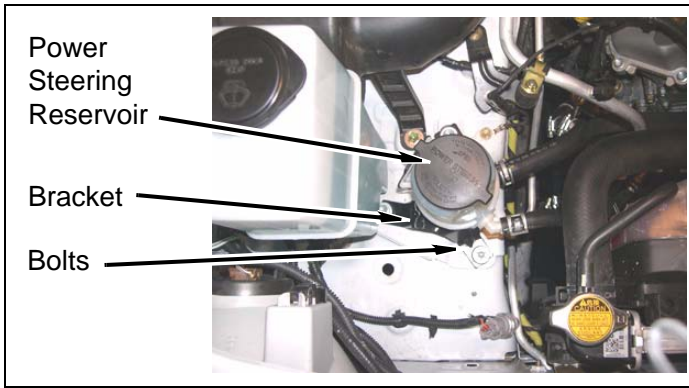

4. **4 cyl. models:** Loosen two engine intake clamps and remove engine intake hose.

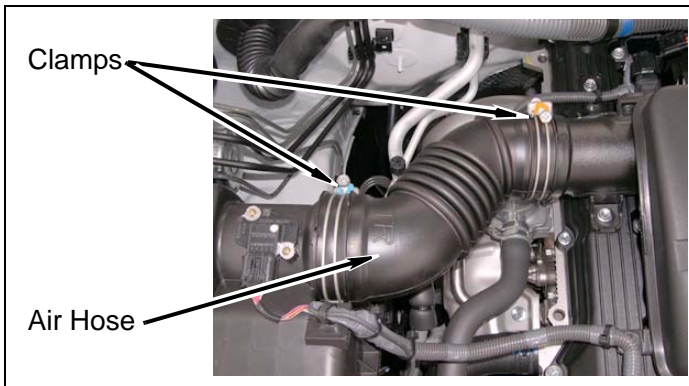

5. **4 cyl. models:** Remove bolt from passenger side AC line bracket.

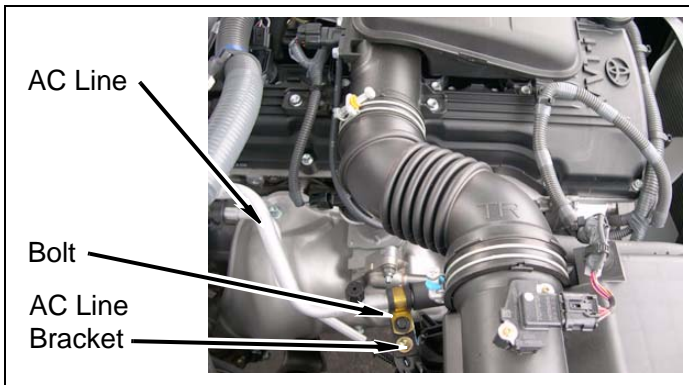

6. **4 cyl. models:** Remove nut and AC line from passenger side AC line bracket.

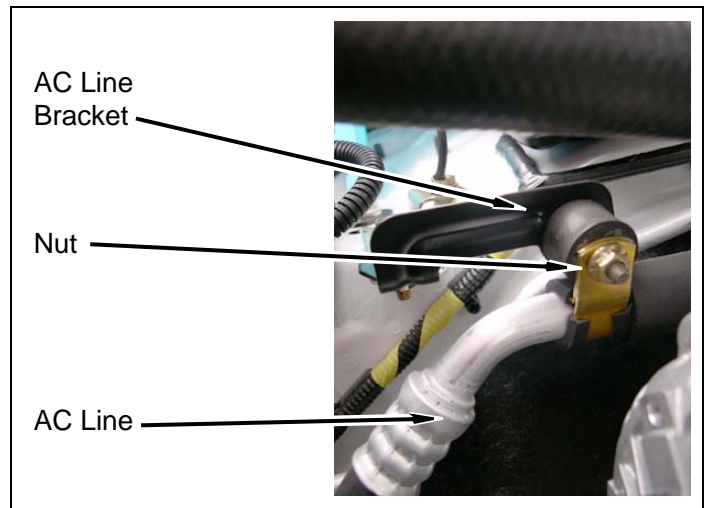

7. **4 cyl. models:** Remove lower AC line from two clips and passenger side body.

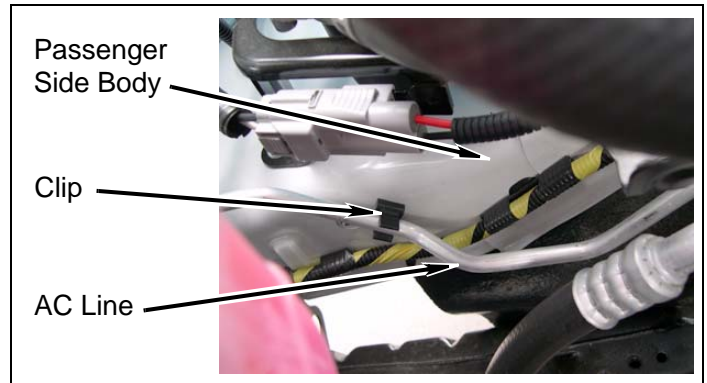

8. Remove vent tubes from driver side body bracket.

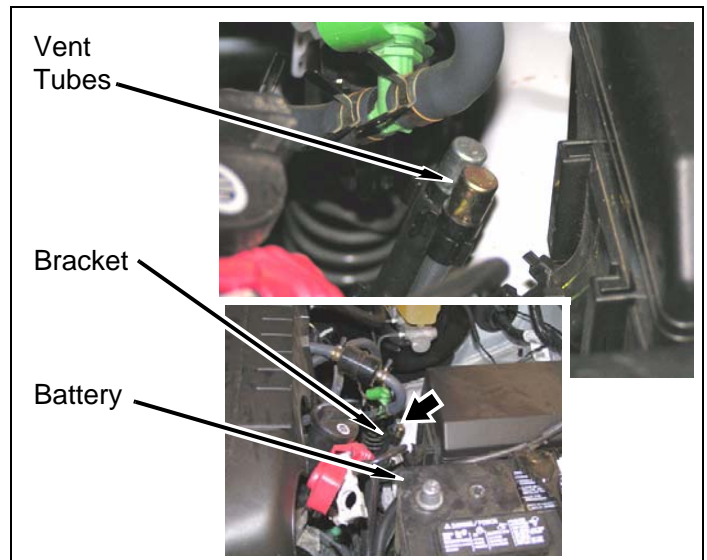

9. Remove heater hoses from clip on backside of engine.

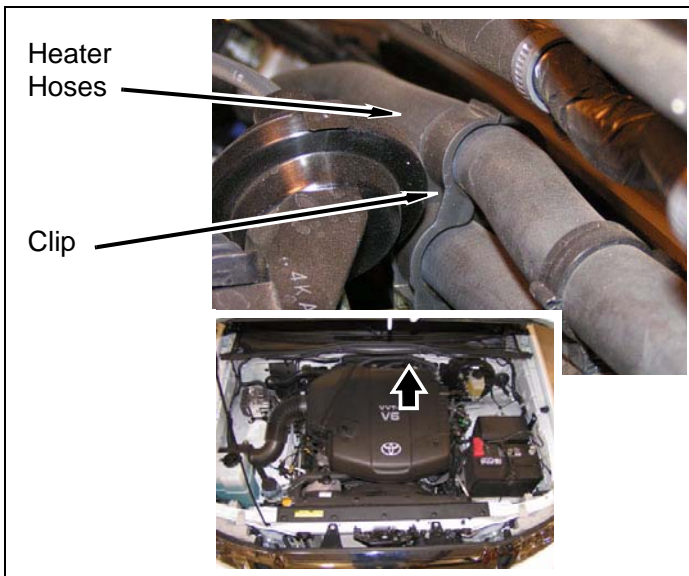

10. Remove wire harness clip from firewall and bracket.

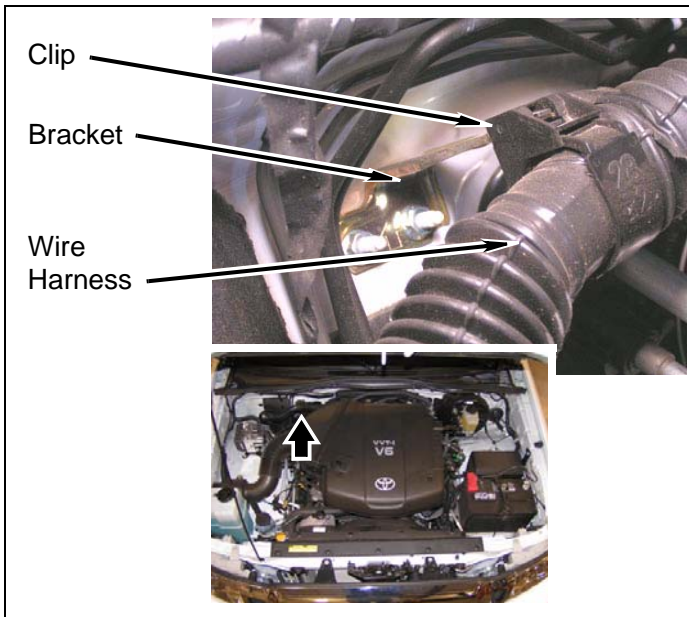

11. Remove ABS wire harnesses from driver and passenger side brackets.

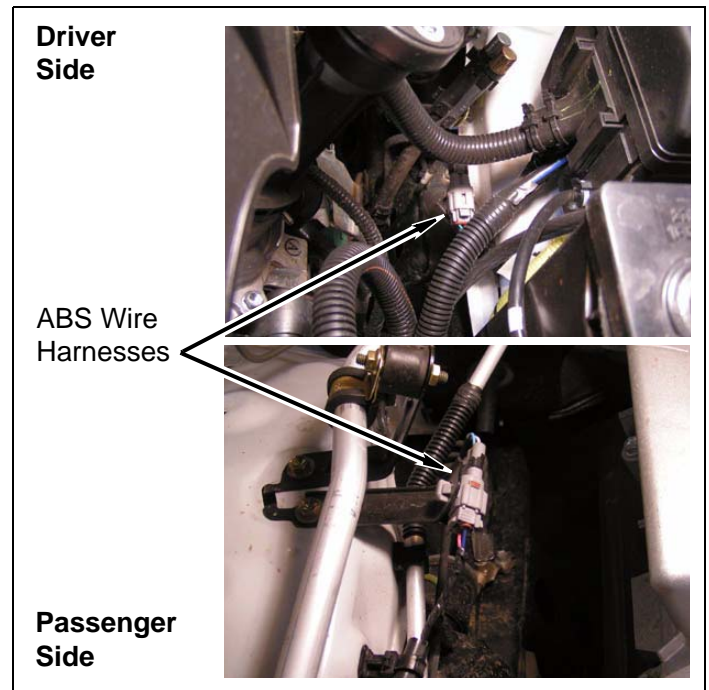

12. Remove wire harness and two clips from alternator bracket and driver side body bracket.

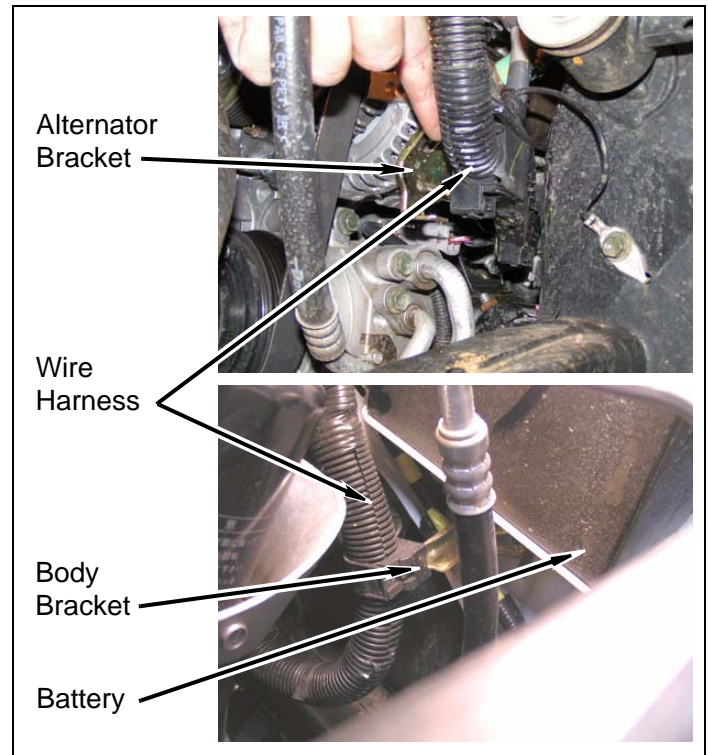

13. Radiator

- a. Remove nine pop-up clips and radiator cover from core support.

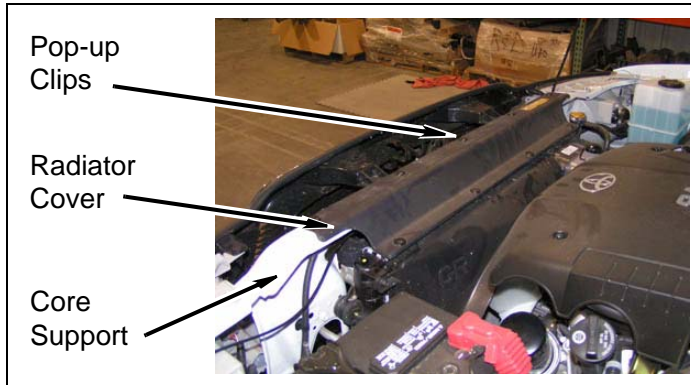

- b. Remove four bolts and radiator from core support. Allow radiator to hang on core support by tabs.

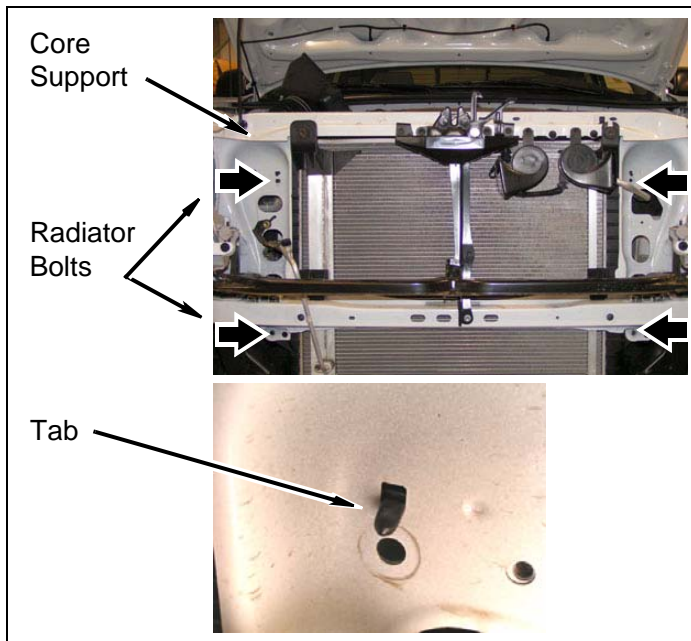

NOTE

Lower the radiator onto the frame prior to the lifting procedures.

14. Steering Shaft

⚠ WARNING

Accidental deployment of the air bag can result in serious personal injury or death. To avoid accidental deployment during installation of the lift kit, the Supplemental Restraint System (SRS, or airbag) must remain deactivated. Do not allow anyone near the airbag during installation. Refer to the factory service manual or owner's manual for the recommended procedure to disable the SRS. After kit installation, the SRS must be reactivated before driving the vehicle.

⚠ CAUTION

If the following step is not performed, the airbag clockspring could be damaged. Do not turn the steering wheel while the steering shaft is disconnected.

- a. Strap steering wheel to prevent accidental movement.
- b. Mark upper steering shaft in relation to coupler and lower steering shaft.

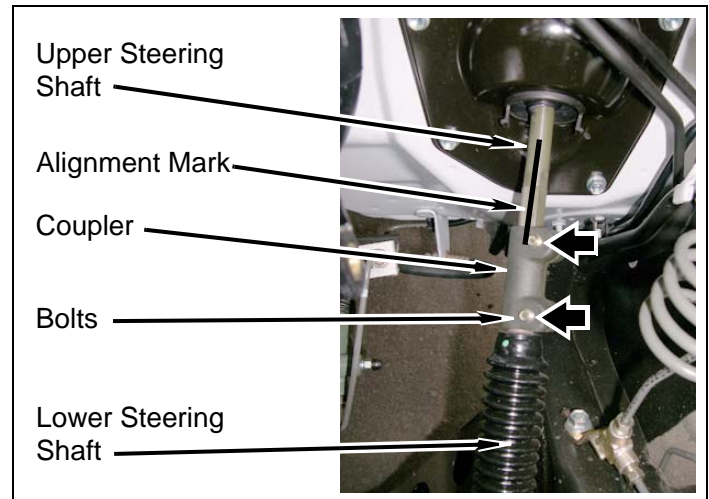

- c. Remove coupler bolts, slide coupler up onto upper steering shaft and disconnect steering shaft.
- d. Slide coupler down and off of upper steering shaft.
- e. Position steering coupler onto lower steering shaft.

Inside of Vehicle

1. Manual transmission

- a. Remove center console and shifter console interior panels.

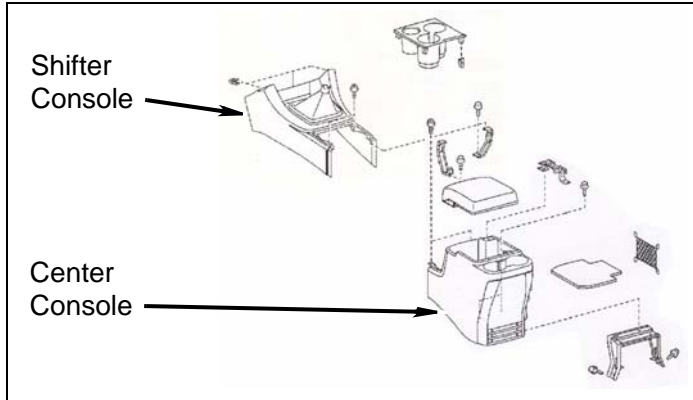

- b. Remove shift lever from vehicle.

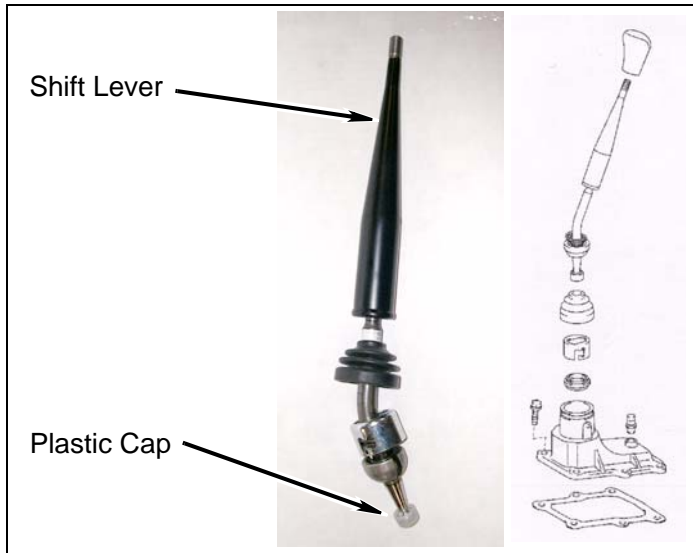

2. Front interior trim panels

- a. Remove driver and passenger door sill plates.



- b. Remove dead pedal.

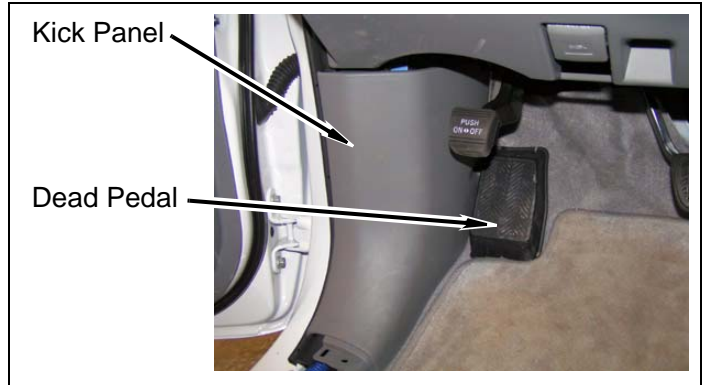

- c. Remove driver and passenger kick panels.

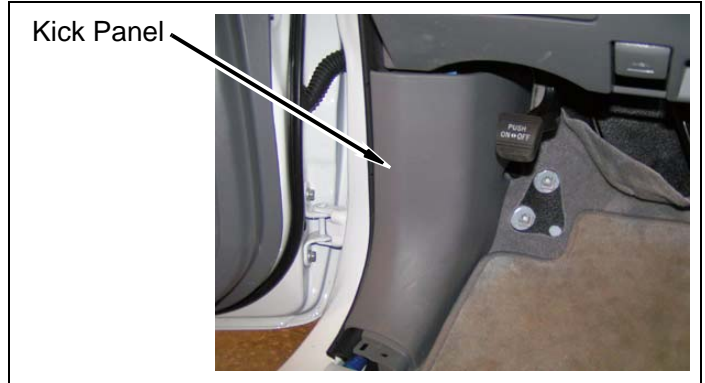

- d. Pull driver and passenger carpet back from corner and expose body mount bolt access cover.

- e. Remove driver and passenger body mount bolt access cover.

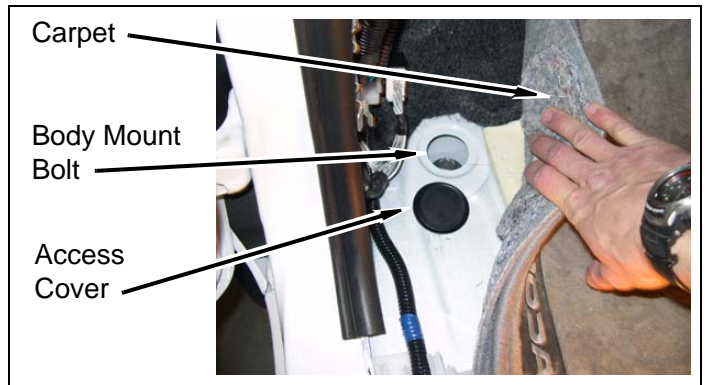

NOTE

Procedures may vary depending on cab model for access to rear body mount bolt access covers.

3. Extended cab models: Rear interior trim panels

a. Fold down rear seats.

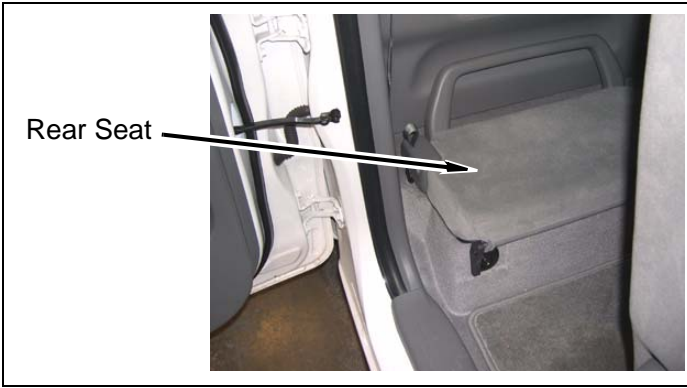

b. Open floor storage tray and remove jack.

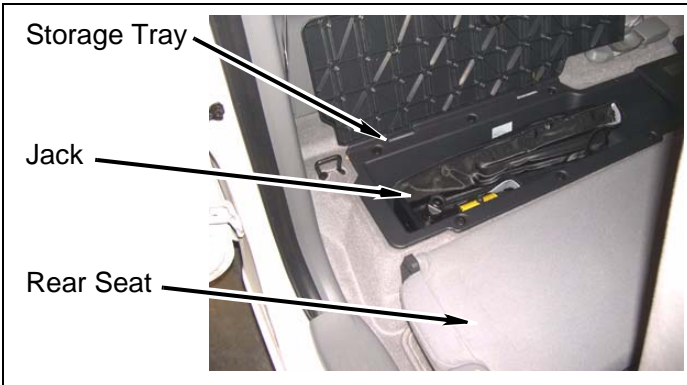

c. Remove pop-up clips and storage tray from vehicle.

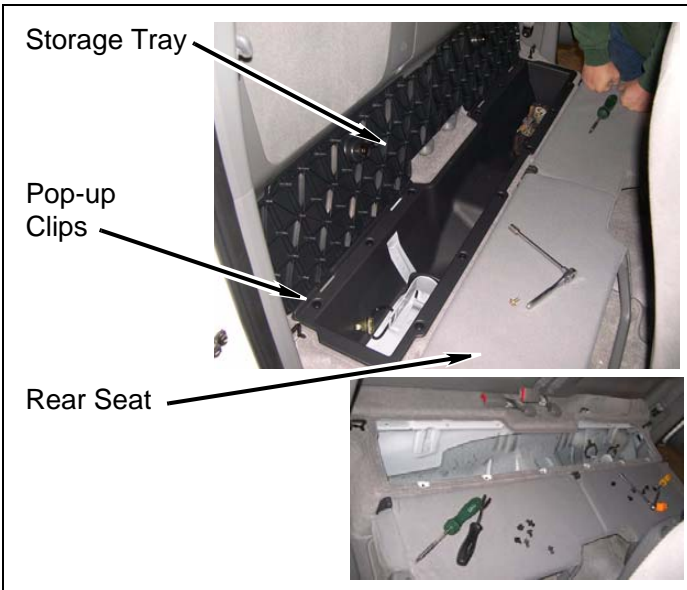

d. Pull carpet up to expose driver and passenger body mount access plates.

e. Remove four bolts, and driver and passenger body mount access plates.

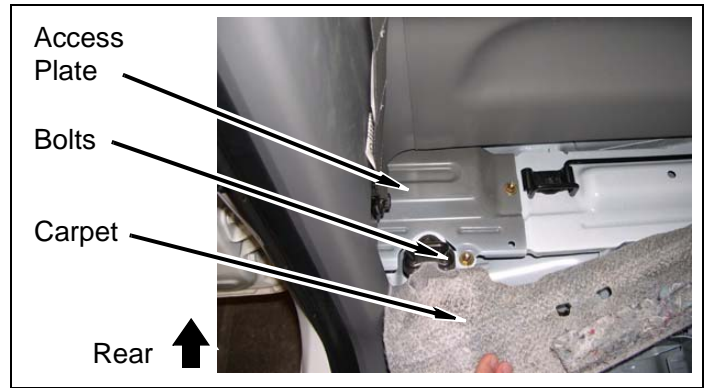

f. Remove driver and passenger body mount bolt access covers.

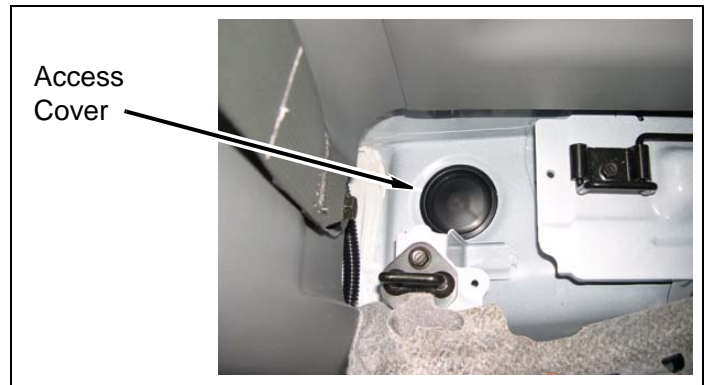

4. Crew cab models: Rear interior trim panels

a. Remove three headrests from seatbacks and fold seatbacks down.

b. Remove three bolts and pop-clips from driver side rear panel and cab.

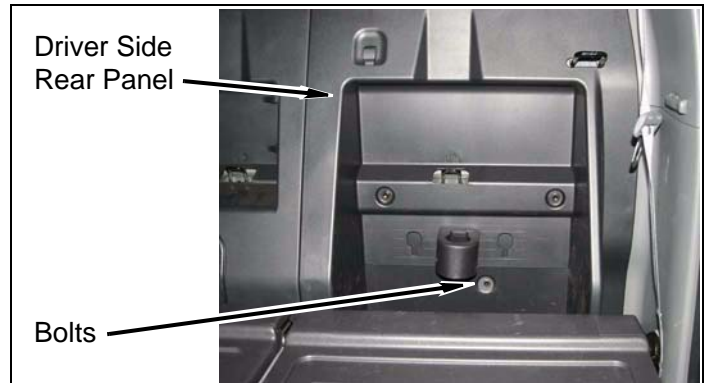

- c. Remove bolt and pop-clips from passenger side rear panel and cab.

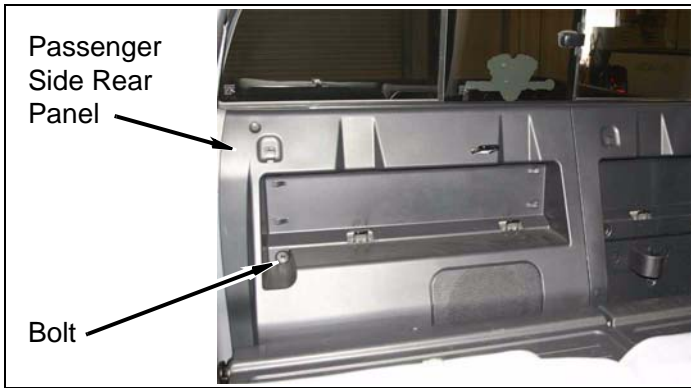

- d. Remove driver and passenger body mount bolt access covers.

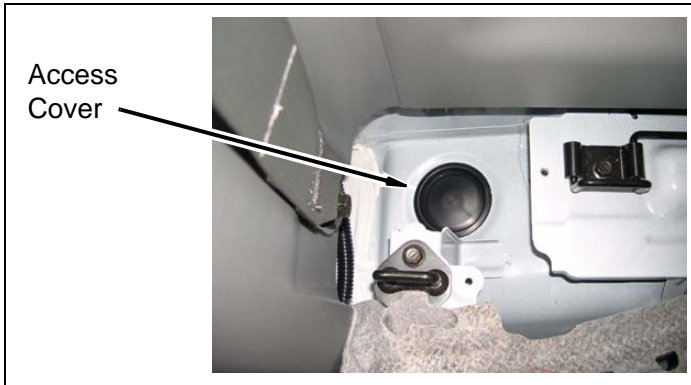

Underside of Vehicle

- 1. Remove all clips and two driver side engine guards from driver side wheel well.

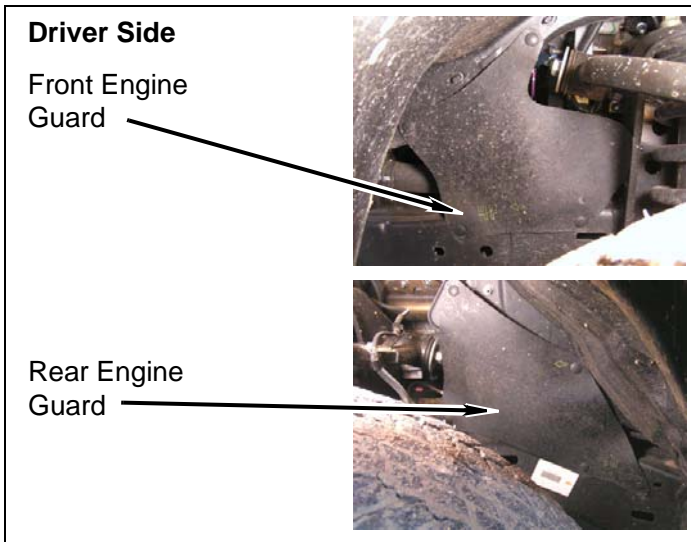

- 2. Repeat above step for passenger side.

- 3. Remove two bolts and brake line brackets from driver and passenger side frame rails.

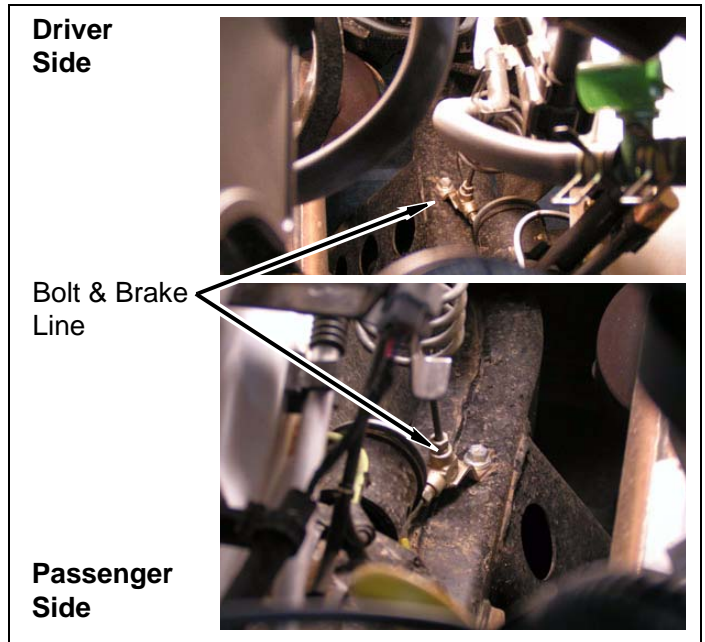

- 4. Remove two bolts and parking brake cable brackets from crossmember.

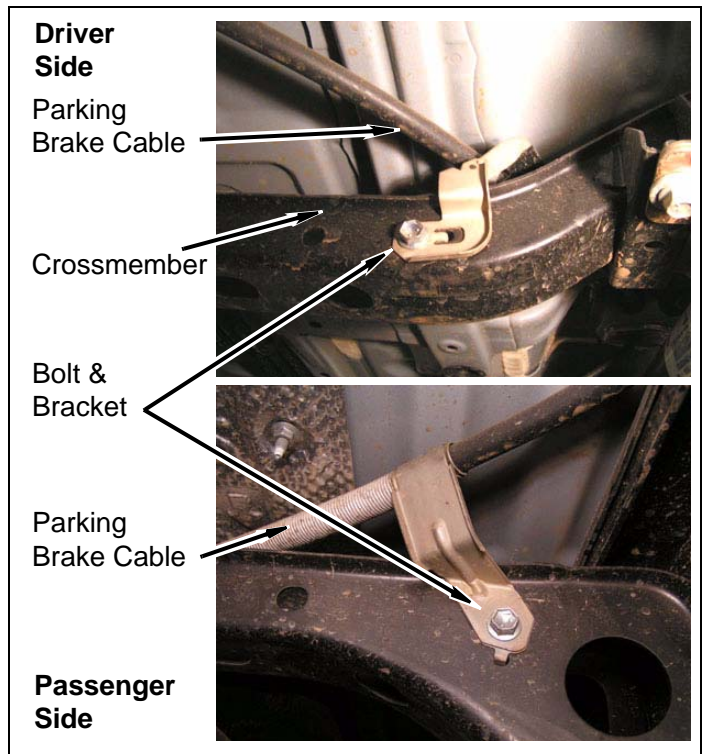

- Remove two nuts and fuel line brackets from driver side body.

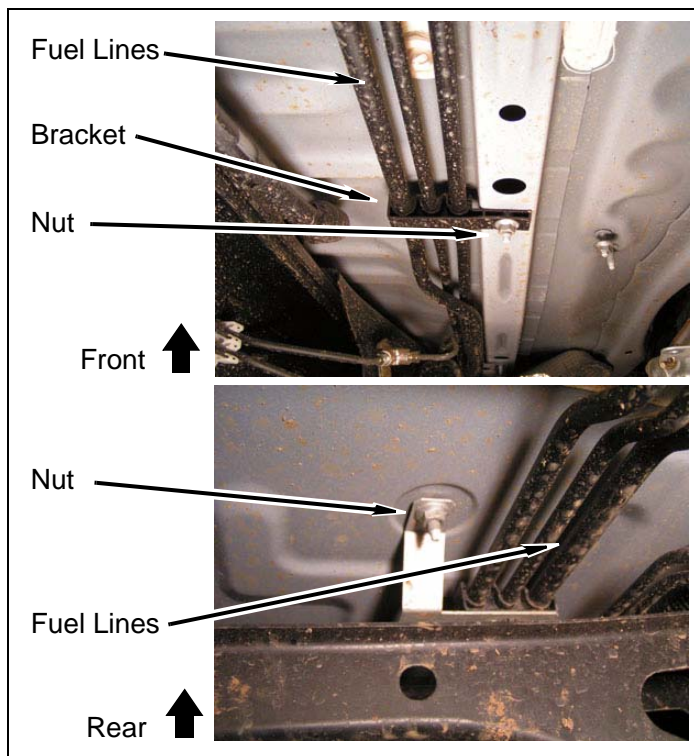

- Remove bolt and brake line bracket from driver side frame.

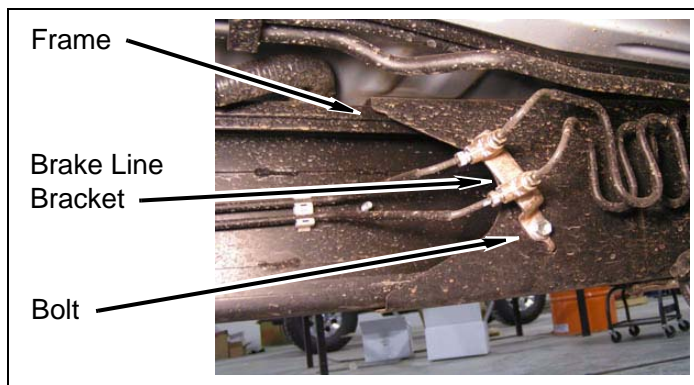

Rear of Vehicle

⚠ WARNING

Use extreme caution when working near the fuel lines and the fuel tank. Clean up spilled fuel immediately. A spark could cause an explosion or fire resulting in serious personal injury and property damage.

- Fuel filler
 - Remove fuel filler cap.

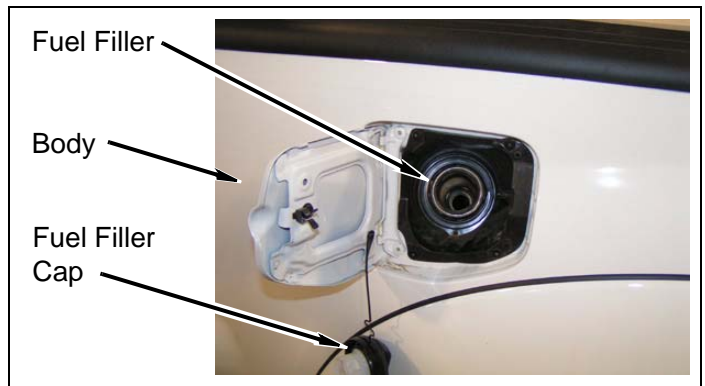

- Loosen two hose clamps and disconnect vent hose connector.

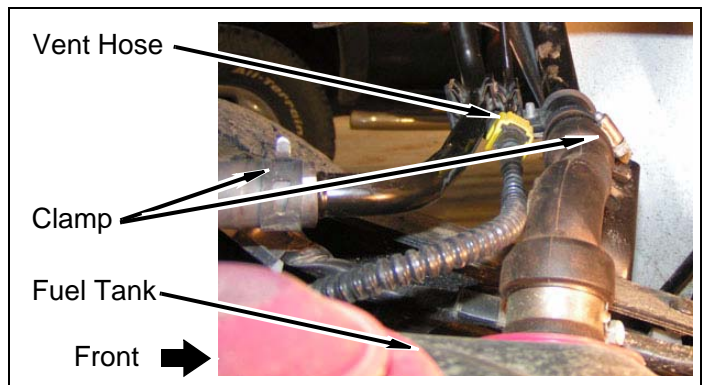

- Remove bolt and fuel filler from vehicle.

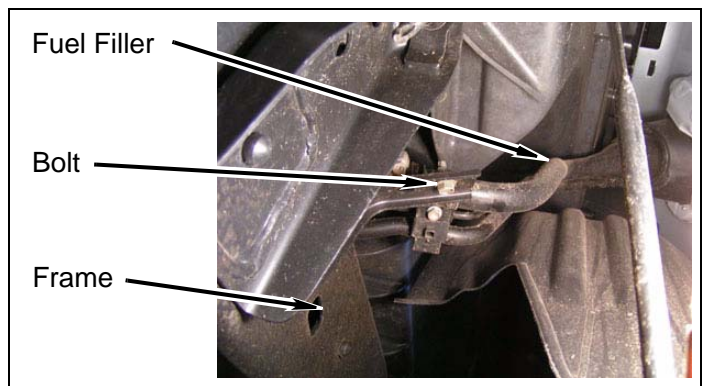

2. Rear bumper

- a. Remove rear bumper wire harness from driver and passenger frame.

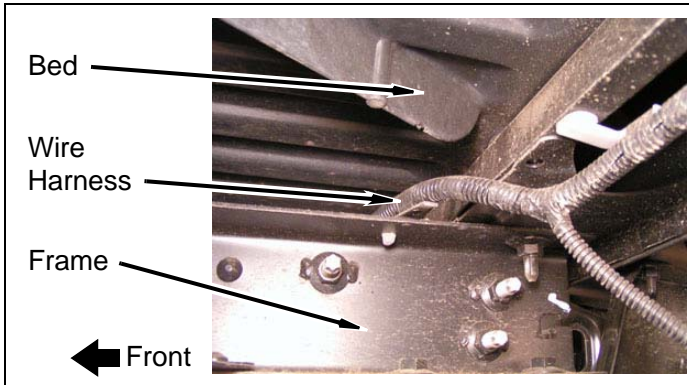

- b. Remove two license plate lights from rear bumper.

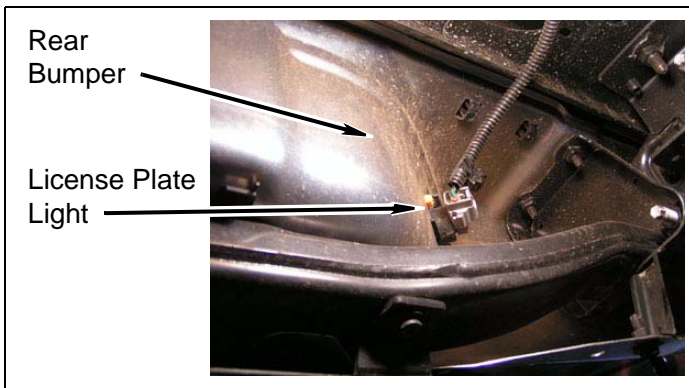

- c. **Without O.E. Trailer Hitch:** Remove six bolts and rear bumper from frame.

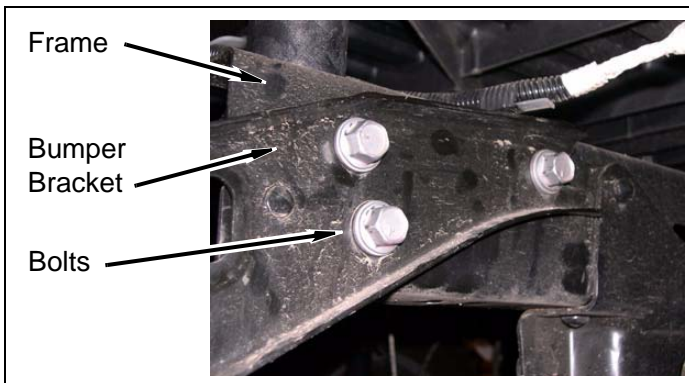

- d. **With O.E. Trailer Hitch:** Remove four bolts and rear bumper from O.E. trailer hitch brackets.

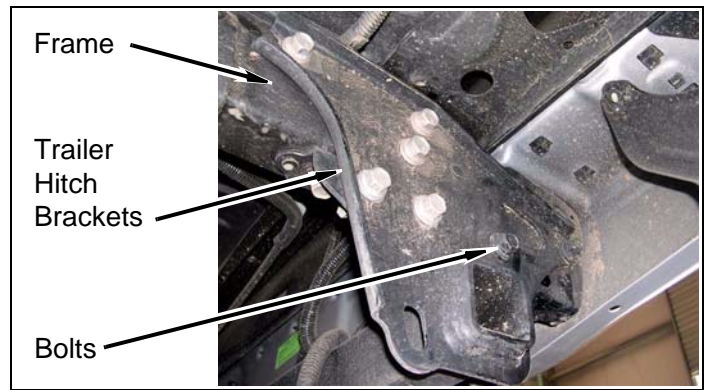

Install Kit

Cab

1. Lift cab

- a. Loosen, but **DO NOT REMOVE**, cab mounting bolts on driver side.

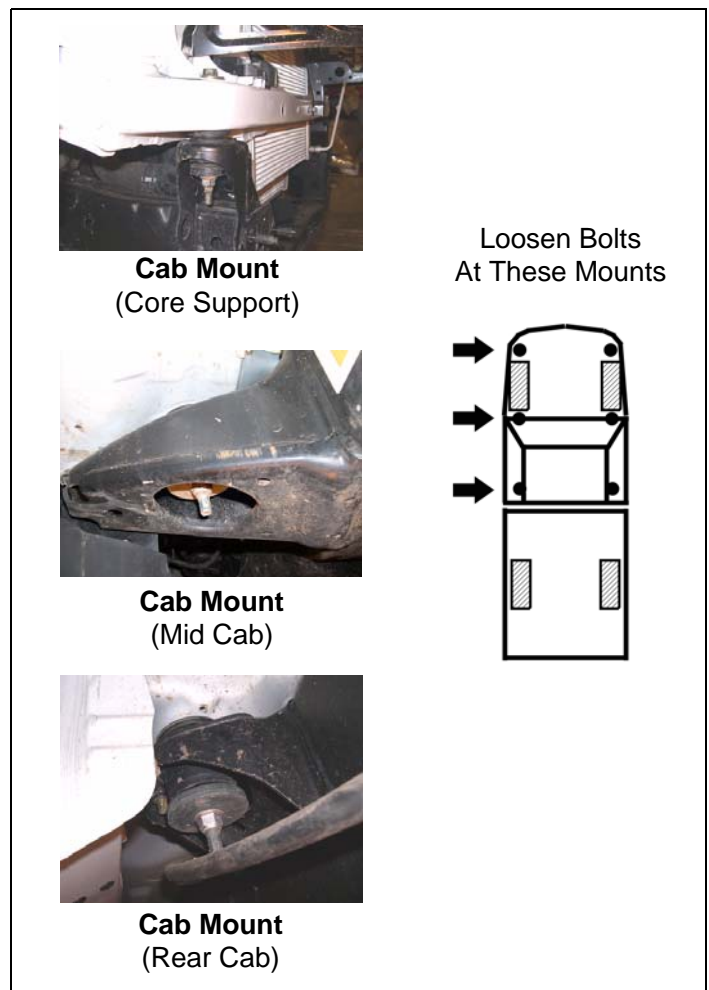

NOTE

The number of cab mounting bolts may vary with the length of the cab.

- b. Remove bolt, nut, and lower washer from each cab mount on passenger side.

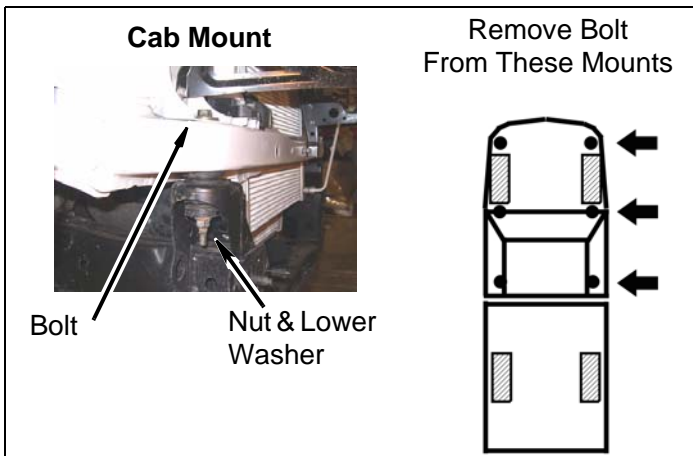

NOTE

The factory captive washers will be used with *kit bolts*.

- b. Position a hydraulic jack and a wood block under passenger side of cab (under the body seam). Slowly lift cab just enough to install a *kit block* on top of factory upper bushing.

WARNING

The *kit blocks* must be installed in addition to the factory upper and lower bushings. Installing the *kit blocks* without the factory upper and lower bushings could result in damage to the vehicle and/or serious personal injury.

WARNING

Use extreme caution when lifting body from frame. To prevent serious personal injury, ensure the lifting device is securely placed. Keep your hands out from between the body and frame.

CAUTION

Continually check hoses, wires, lines, etc. to be sure that everything is flexing properly and not binding, or damage to the vehicle could result. Be especially careful of the a/c hoses at the fire wall, the belt pulley, and at the core support. Ensure brake lines stretch while lifting. Bending the lines to gain ample slack may be necessary. Be extremely careful not to kink the lines.

- c. Install *kit block* (2" dia.) on upper bushings on front core support cab mount.

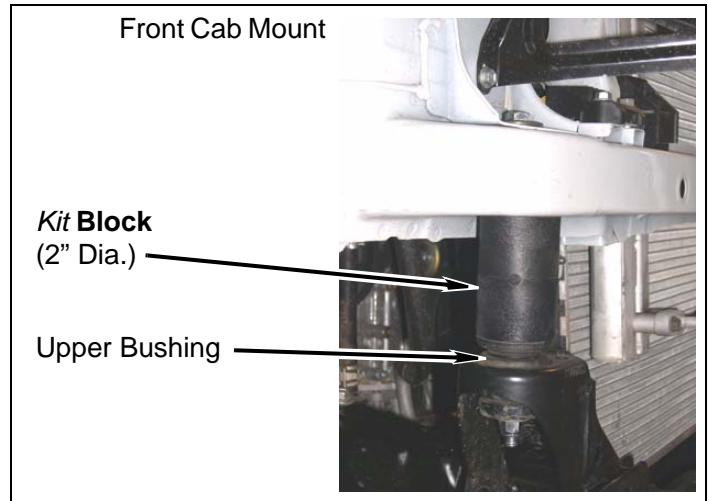

- d. Install *kit blocks* (3" dia.) on upper bushings on each remaining cab mount.

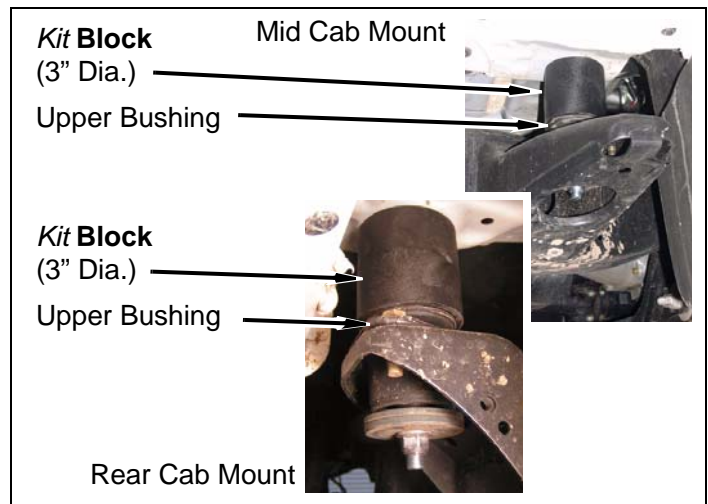

- e. Lower cab onto *kit blocks*.

2. Cab passenger side

- a. Remove captive washers from each factory cab mount bolt.

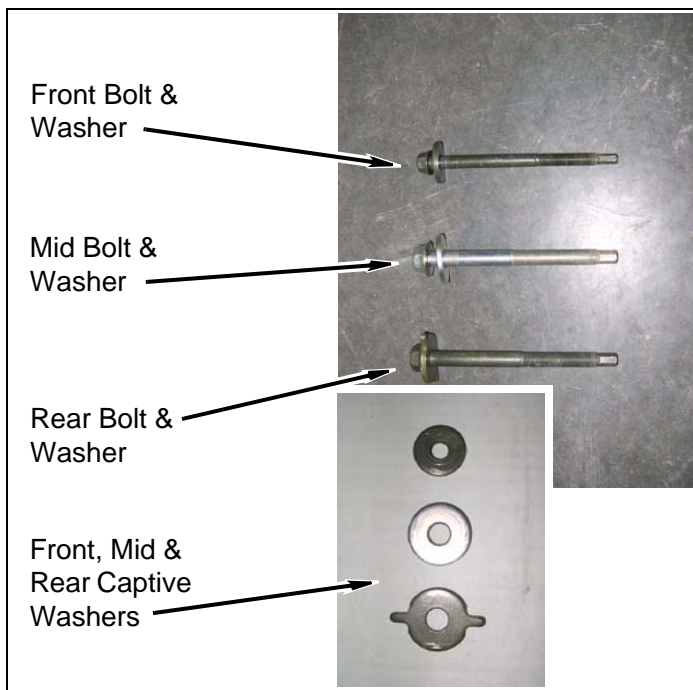

- f. Install factory front captive washer and a *kit bolt* (3/8" x 8") on core support cab mount. DO NOT TIGHTEN.

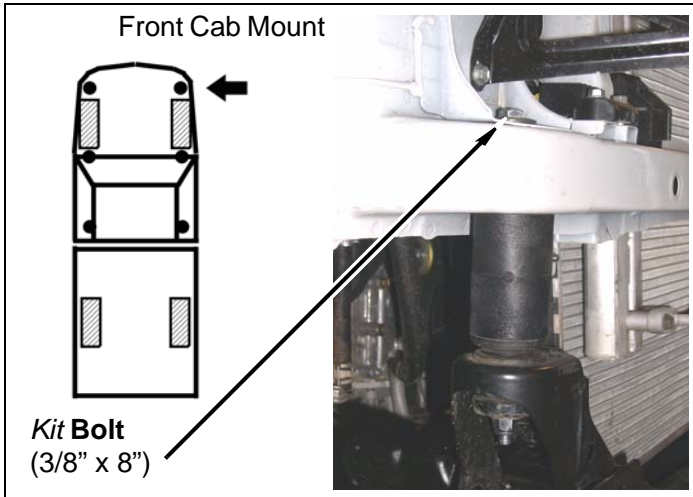

- g. Install factory mid captive washer and *kit bolt* (M12-1.75 x 200mm) on cab mount. DO NOT TIGHTEN.

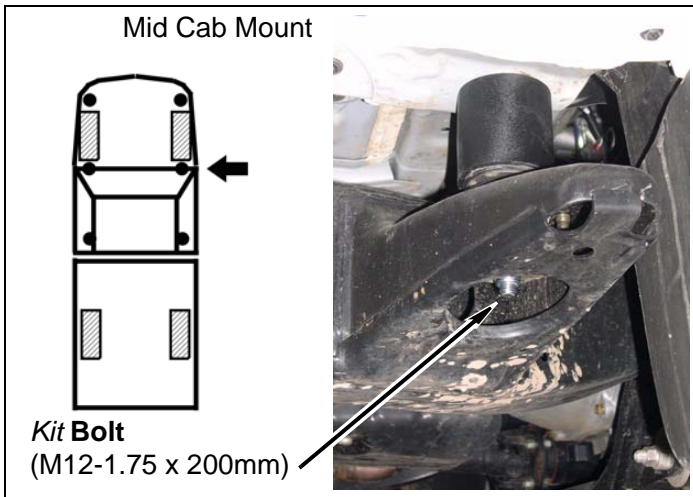

- h. Install factory rear captive washer and *kit bolt* (M12-1.25 x 210mm) on cab mount. DO NOT TIGHTEN.

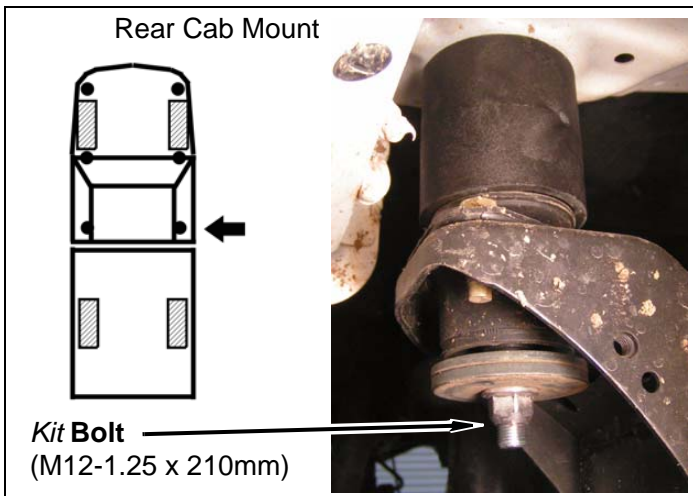

3. Cab driver side

- a. Repeat previous steps on driver side of cab.
- b. Set cab-to-bed spacing according to previous measurement.
- c. Remove front core support cab mount *kit bolts* (3/8" x 8") and apply a few drops of *kit Loctite*® to threads. Install *kit bolts*, factory captive washers, factory lower washers and *kit nuts* (3/8" Nylock). Tighten *kit bolts* to 55 ft. lbs.

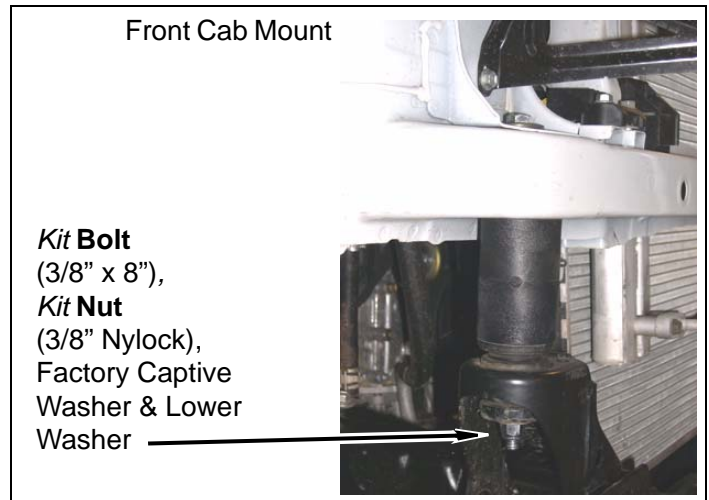

- d. Remove mid cab mount *kit bolts* (M12-1.75 x 200mm) and apply a few drops of *kit Loctite*® to threads. Install *kit bolts*, factory captive washers, factory lower washers and *kit nuts* (12mm Nylock). Tighten *kit bolts* to 55 ft. lbs.

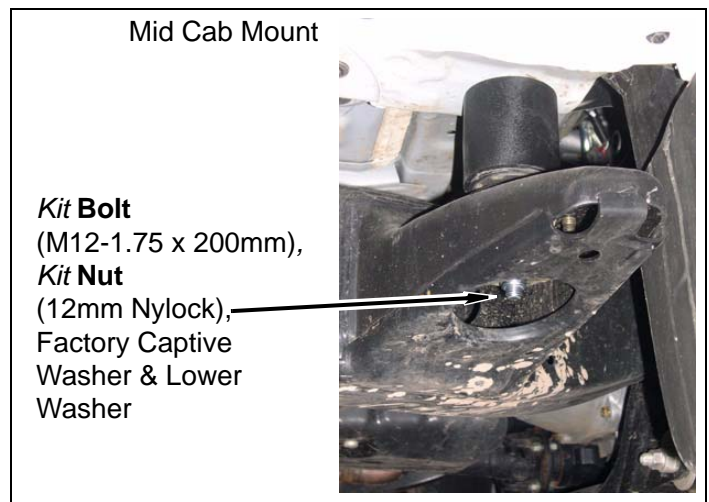

- e. Remove rear cab mount **kit bolts** (M12-1.25 x 210mm) and apply a few drops of **kit Loctite®** to threads. Install **kit bolts**, factory captive washers, factory lower washers and factory nuts. Tighten **kit bolts** to 55 ft. lbs.

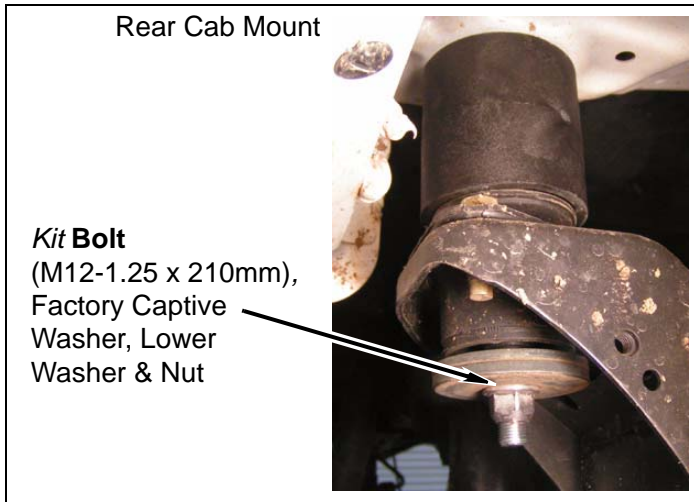

2. Remove bolt from each bed mount on passenger side.

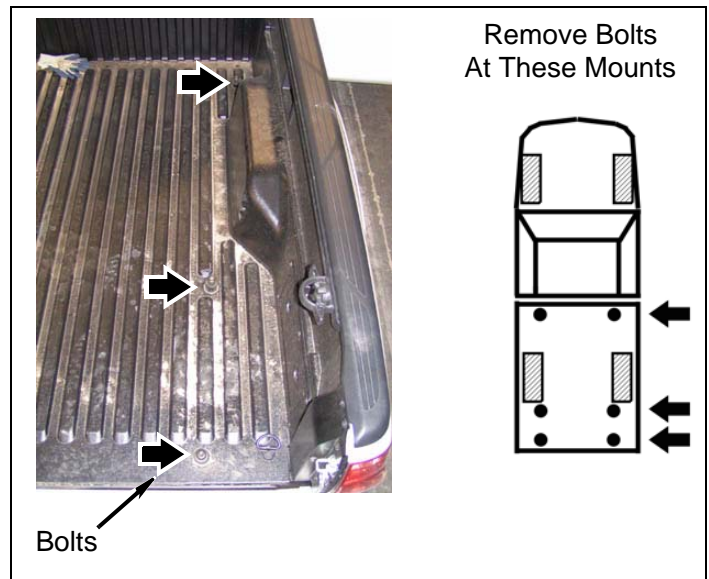

Bed

1. Lift bed
 - a. Loosen, but **DO NOT REMOVE**, bed mounting bolts on driver side.

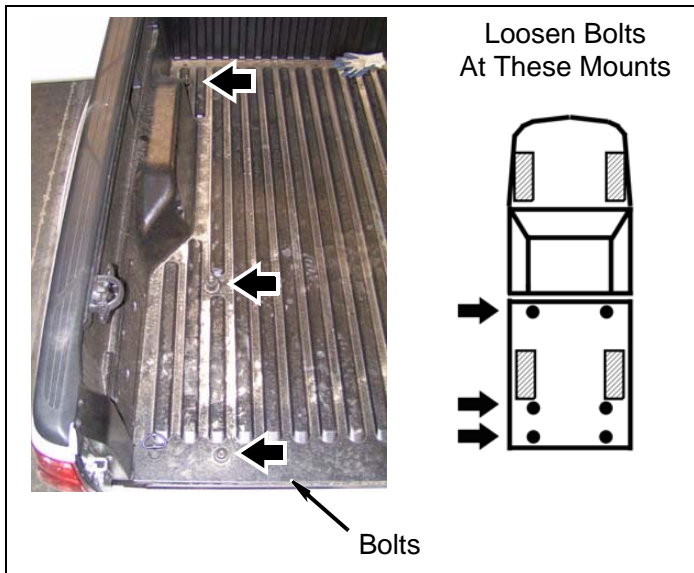

⚠ WARNING

Use extreme caution when lifting the bed from the frame. To prevent serious personal injury, ensure the lifting device is securely placed. Keep your hands out from between the bed and frame.

⚠ CAUTION

To prevent damage to the vehicle while lifting the bed, continually check hoses, wires, brake lines, etc. to ensure everything is flexing properly and not binding. Ensure clearance between bed and cab is maintained.

3. Bed passenger side

- a. Remove captive washers from each factory bed mount bolt.

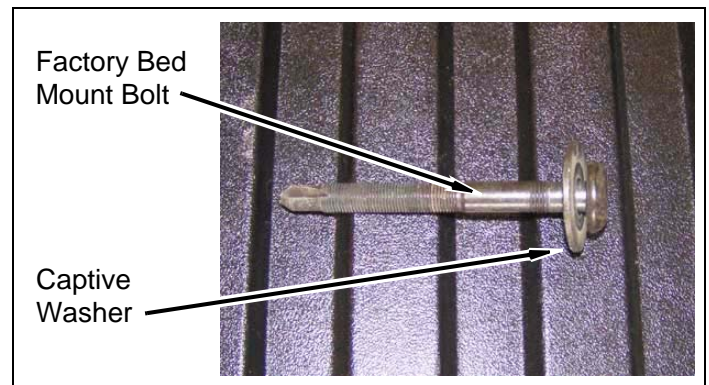

NOTE

The number of bed mounting bolts may vary with the length of the bed.

NOTE

The factory captive washers will be used with **kit bolts**.

- b. Using a hydraulic jack and a wood block, slowly lift passenger side of bed a little more than 3".

c. Install *kit blocks* (2" dia.) on frame mounts.

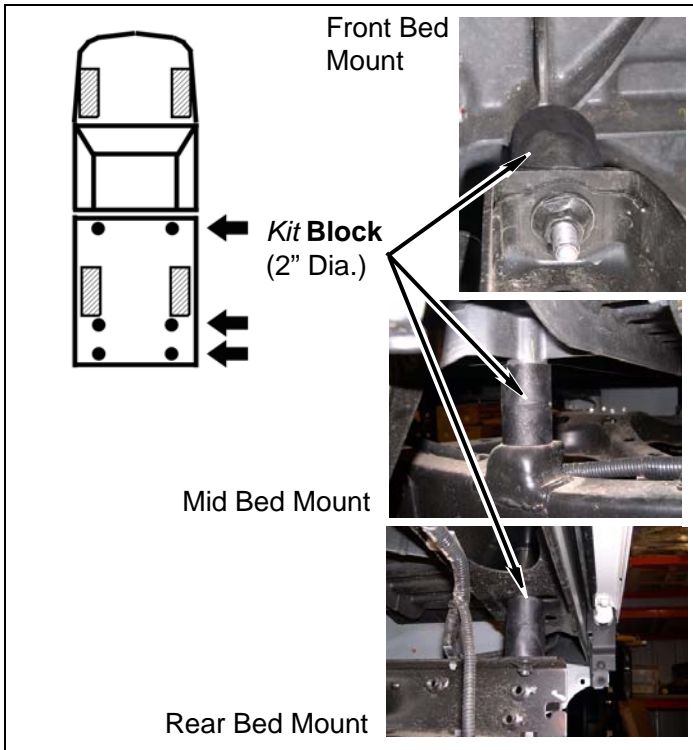

d. Lower bed onto *kit blocks*.

e. At front and mid bed mounts, install *kit bolts* (M12-1.25 x 160mm) and factory captive washers. DO NOT TIGHTEN.

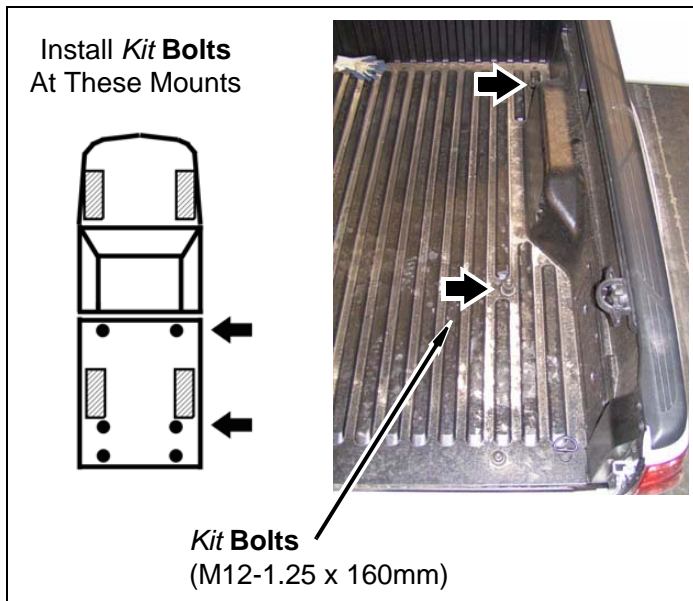

f. At rear bed mount, install *kit bolt* (M12-1.25 x 180mm) and factory captive washer. DO NOT TIGHTEN.

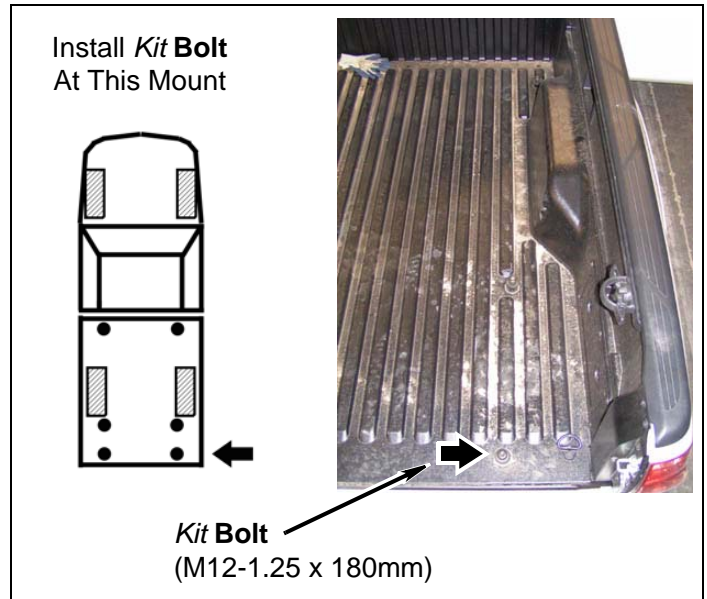

g. Repeat previous steps on driver side of bed.

h. Set bed-to-cab spacing according to previous measurement.

i. Remove each *kit bolt*, one at a time, and apply a few drops of *kit Loctite*® to threads. Install *kit bolt* with factory captive washer.

Rear of Vehicle

1. With O.E. Trailer Hitch: Rear bumper

⚠ WARNING

The following procedure is intended only to enhance the appearance of the vehicle. The rear bumper will no longer be rated for towing of any kind. Towing with the rear bumper after it has been lifted can result in death, serious personal injury, or damage to the vehicle. Towing after the bumper has been lifted should be accomplished using a rated Class III receiver type hitch.

NOTE

Rear bumper installation requires kit# 5903.

- a. Mark and cut driver and passenger O.E. trailer hitch brackets along white lines as shown below.

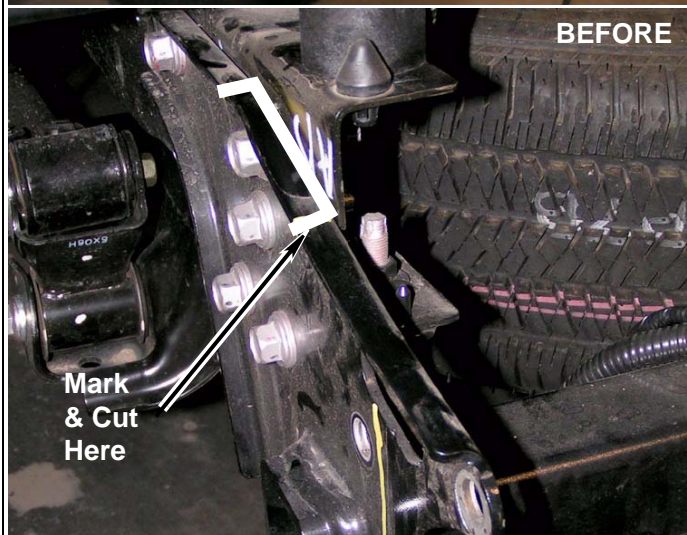
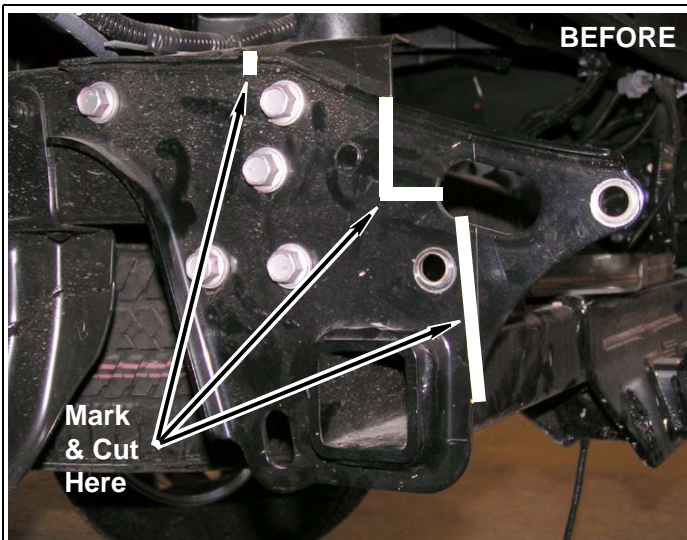

- b. Apply a small amount of *kit* **Loctite**® onto threads of two factory bolts and install *kit* **bracket** (rear bumper, passenger) and *kit* **bracket** (bumper, spacer) to passenger side bumper with two factory bolts. **DO NOT TIGHTEN.**

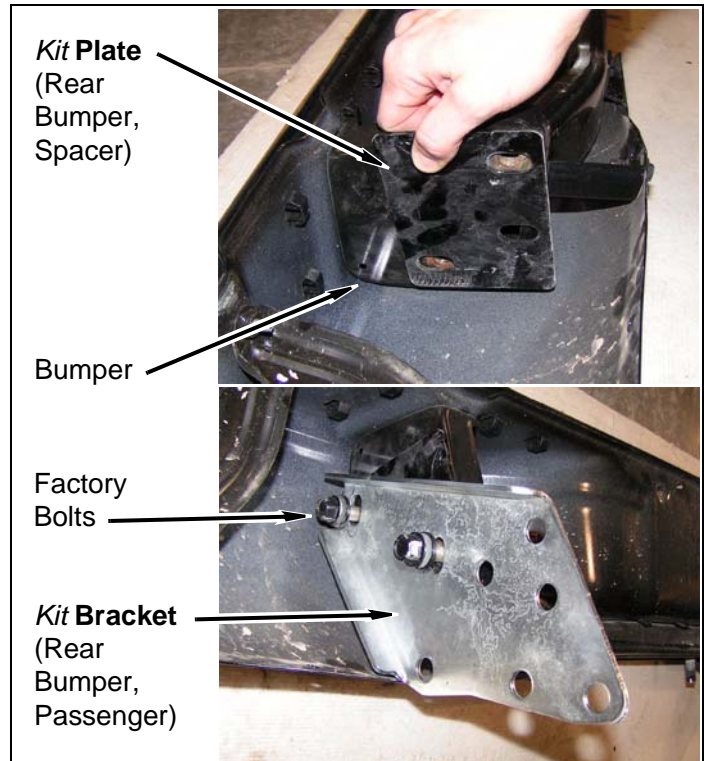

- c. Repeat above step for driver side.
 d. Remove eight factory bolts from O.E. trailer hitch and frame rails.

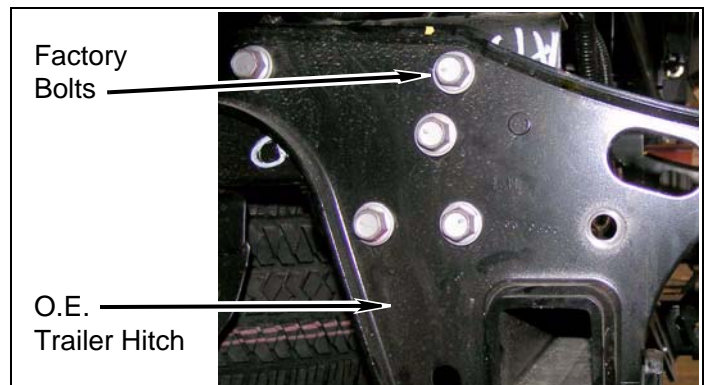

- e. Apply a small amount of *kit Loctite*® onto threads of eight factory bolts and install rear bumper and *kit brackets* (rear bumper) onto O.E. trailer hitch with eight factory bolts. DO NOT TIGHTEN.

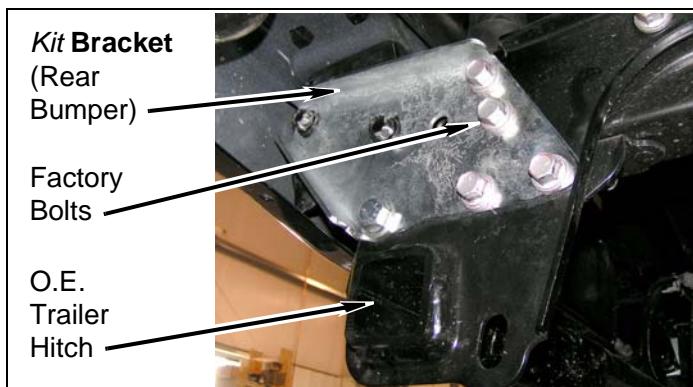

- f. Install two *kit brackets* (rear bumper) onto O.E. trailer hitch with two *kit bolts* (9/16" x 1-1/2"), four *kit washers* (9/16" SAE), and two *kit nuts* (9/16" stover). DO NOT TIGHTEN.

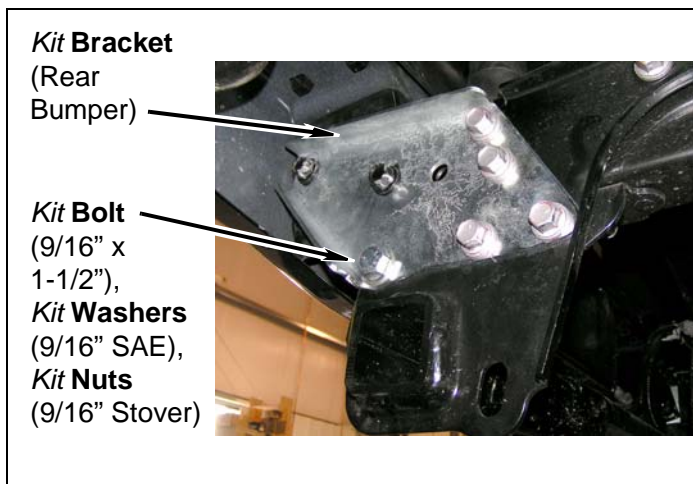

- g. Install *kit bracket* (rear bumper, middle) onto rear bumper with two factory bolts and nuts. DO NOT TIGHTEN.

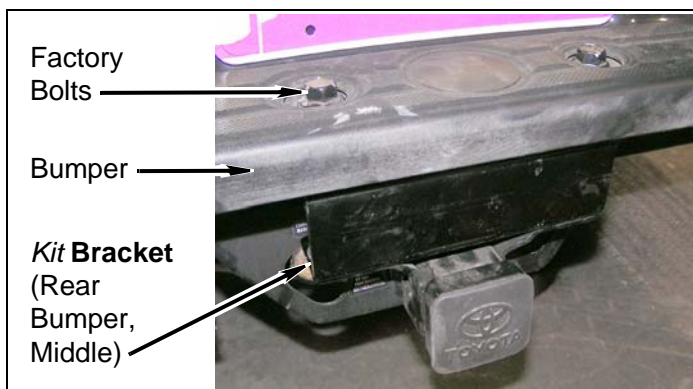

- h. Install *kit bracket* (rear bumper, middle) onto O.E. trailer hitch with two *kit bolts* (1/2" x 1"), four *kit washers* (1/2" SAE), and two *kit nuts* (1/2" stover). DO NOT TIGHTEN.

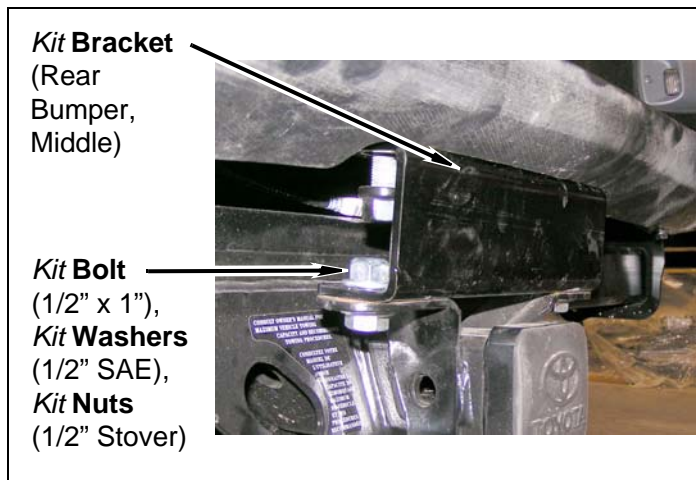

2. Without O.E. Trailer Hitch: Rear bumper

⚠ WARNING

The following procedure is intended only to enhance the appearance of the vehicle. The rear bumper will no longer be rated for towing of any kind. Towing with the rear bumper after it has been lifted can result in death, serious personal injury, or damage to the vehicle. Towing after the bumper has been lifted should be accomplished using a rated Class III receiver type hitch.

- Remove four bolts and two bumper brackets from bumper.
- Apply a small amount of *kit Loctite*® to threads of three factory bolts and install *kit bracket* (rear bumper, passenger) to passenger side frame. DO NOT TIGHTEN.

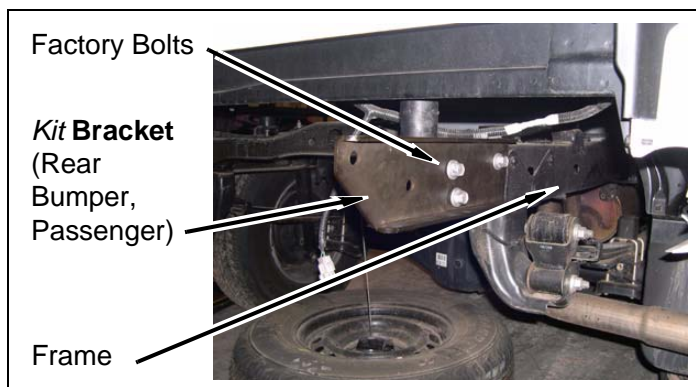

- Repeat above step for driver side.

- d. Apply a small amount of *kit Loctite*[®] to threads of four factory bolts and install rear bumper to *kit brackets* (rear bumper). DO NOT TIGHTEN.

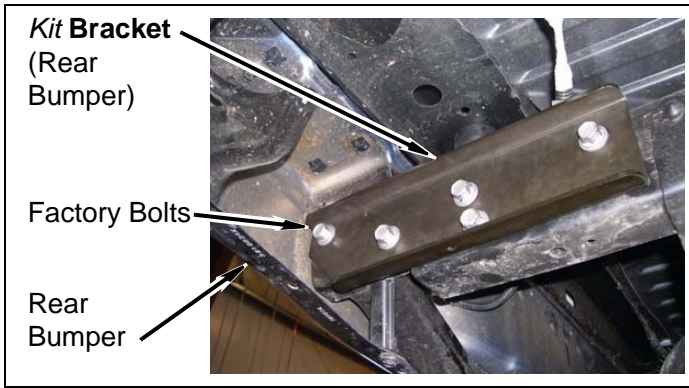

3. Install license plate lights on rear bumper.

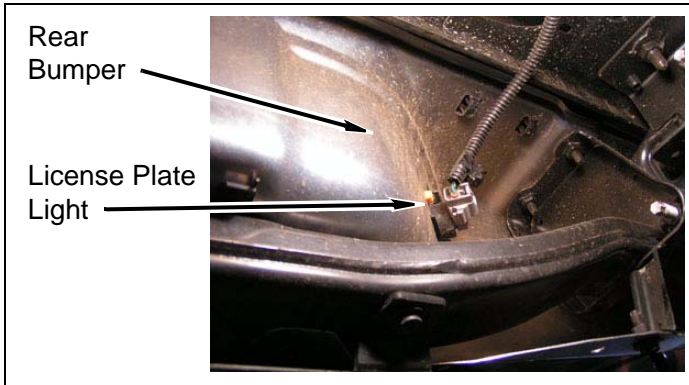

4. Install rear bumper wiring harness on frame, if possible.

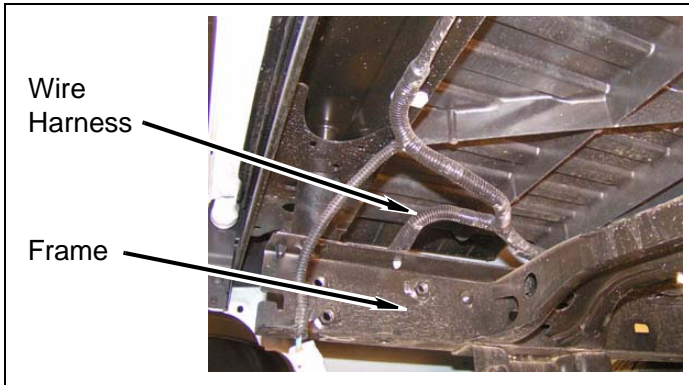

5. Install *kit tie* (zip) to rear crossmember and bumper wiring harness.

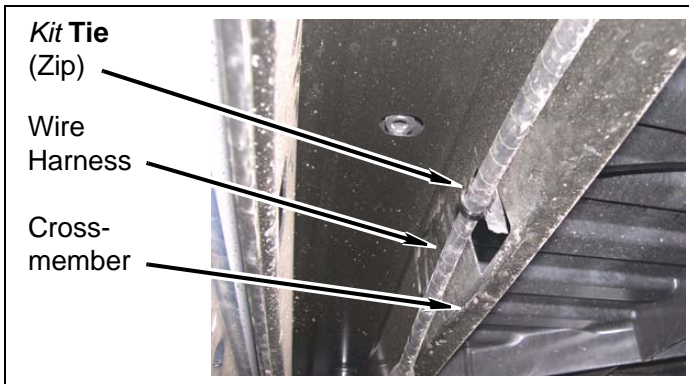

6. Set bumper to previous bed-to-bumper measurements.
7. TIGHTEN all rear bumper hardware.
8. Fuel filler

⚠ WARNING

Use extreme caution when working near the fuel lines and the fuel tank. Clean up spilled fuel immediately. A spark could cause an explosion or fire resulting in serious personal injury and property damage.

- a. Mark fuel filler tubes with cut and alignment lines.

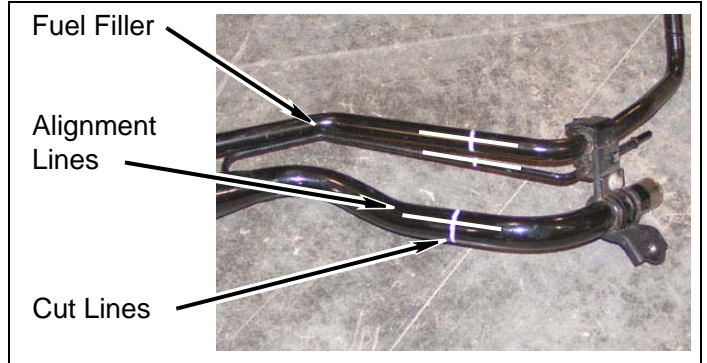

- b. Cut fuel filler on cut lines.

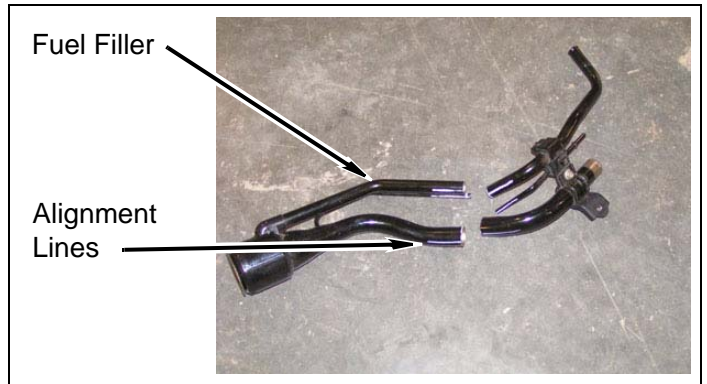

- c. Deburr edges of cut tubes.

- d. Install **kit extension** (1/4" x 6" hose) between cut breather tube on fuel filler with two **kit clamps** (#6 hose). DO NOT TIGHTEN.

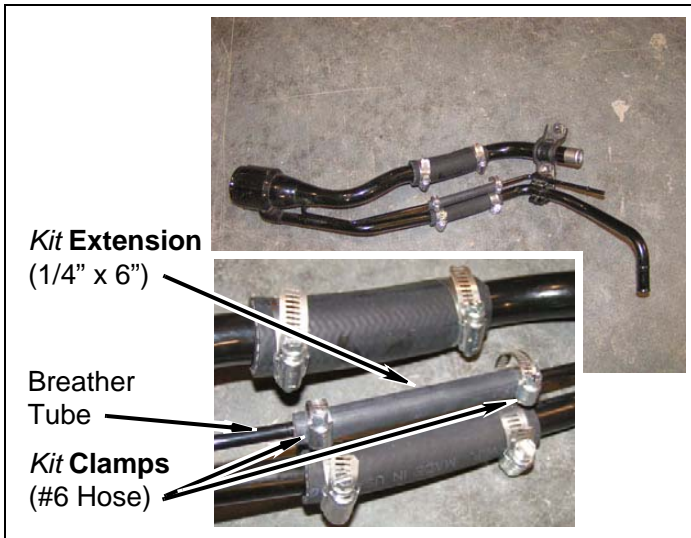

- e. Install **kit extension** (5/8" x 6" hose) between cut vent tube on fuel filler with two **kit clamps** (#10 hose). DO NOT TIGHTEN.

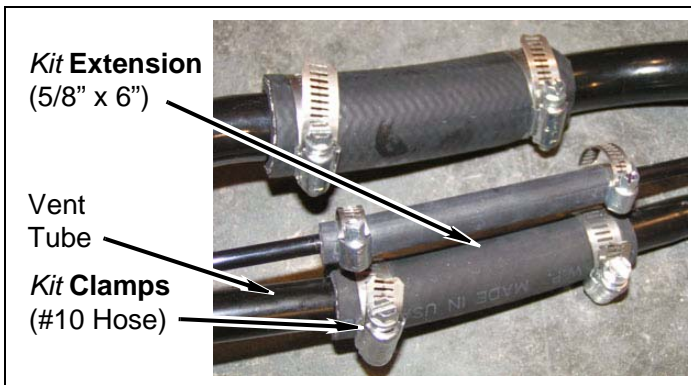

- f. Install **kit extension** (1" x 6" hose) between cut filler tube on fuel filler with two **kit clamps** (#20 hose). DO NOT TIGHTEN.

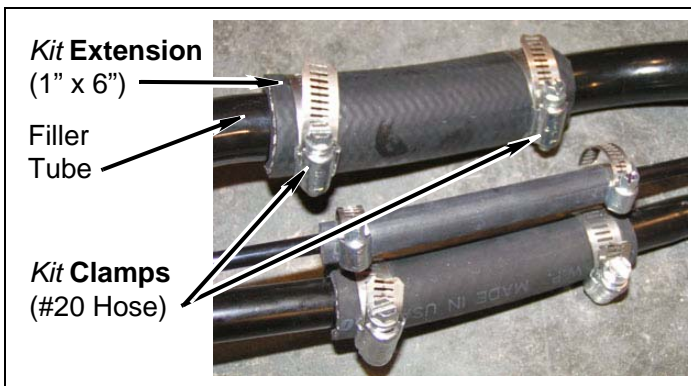

- g. Install fuel filler onto fuel tank with two factory hose clamps and factory clip. DO NOT TIGHTEN.

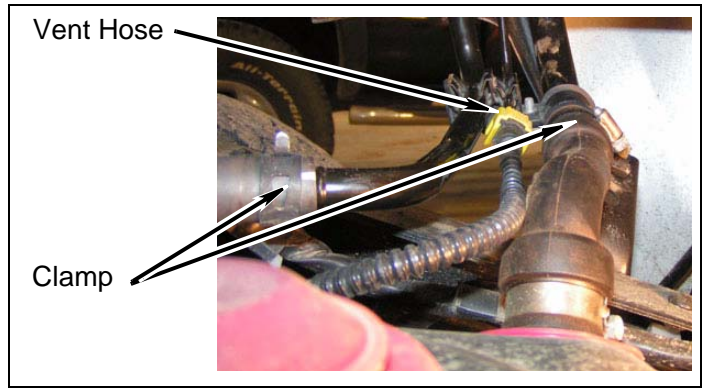

- h. Install factory bolt onto frame and fuel filler.

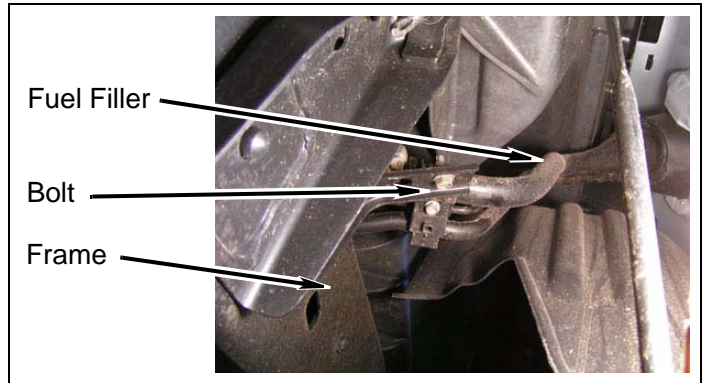

- i. Adjust fuel filler and/or **kit extensions** (hose) to body.

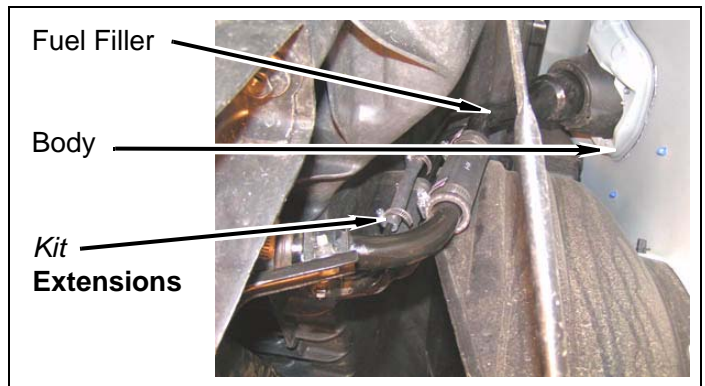

- j. TIGHTEN all hardware.

- k. Install fuel filler cap.

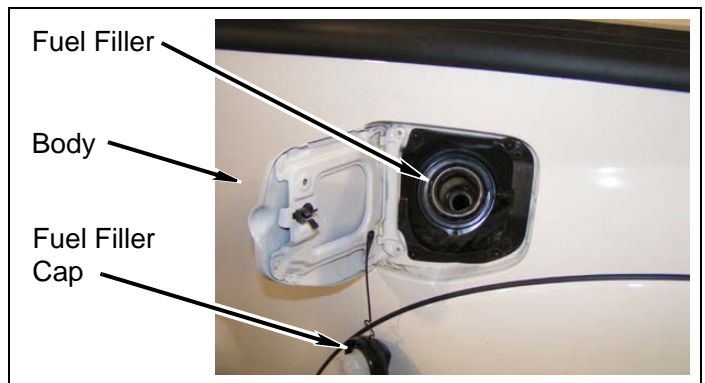

Underside of Vehicle

1. Parking brake cable

- a. Install **kit bracket** (3" w/ stud) to driver side crossmember with factory bolt.

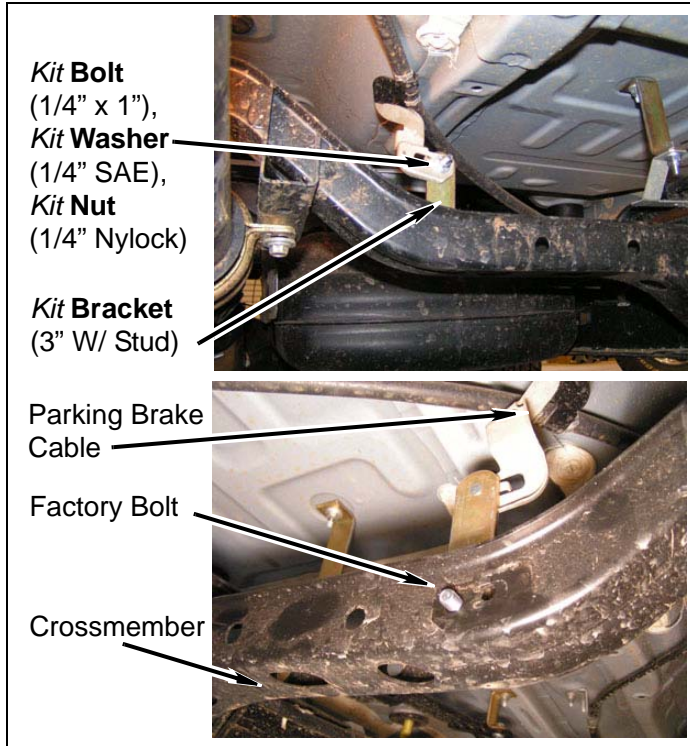

- b. Install driver side parking brake cable to **kit bracket** with **kit nut** (1/4" Nylock) and **kit washer** (1/4" SAE).
- c. Install **kit bracket** (3" w/ stud) to passenger side crossmember with factory bolt.

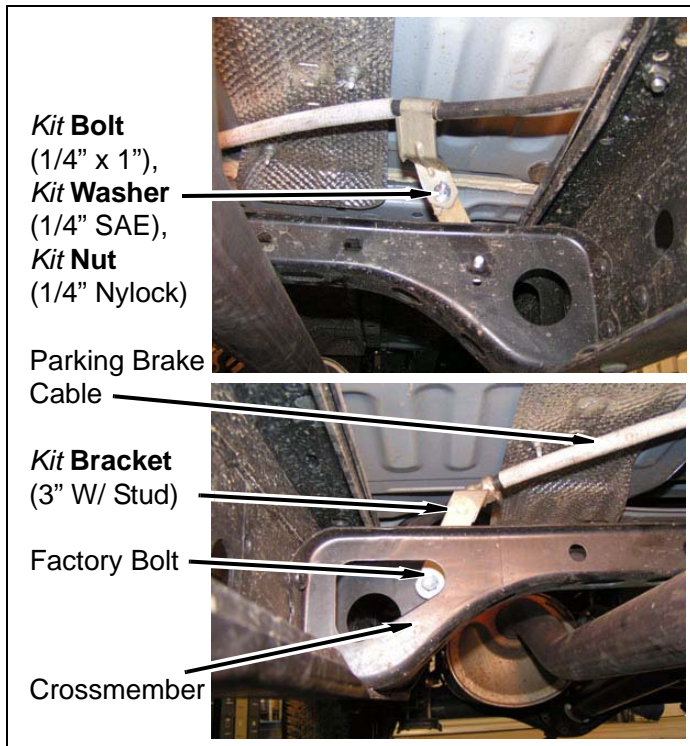

- d. Install passenger side parking brake cable to **kit bracket** with **kit nut** (1/4" Nylock) and **kit washer** (1/4" SAE).

2. Fuel lines

- a. Install **kit bracket** (2" stand off) to driver side stud with factory nut.

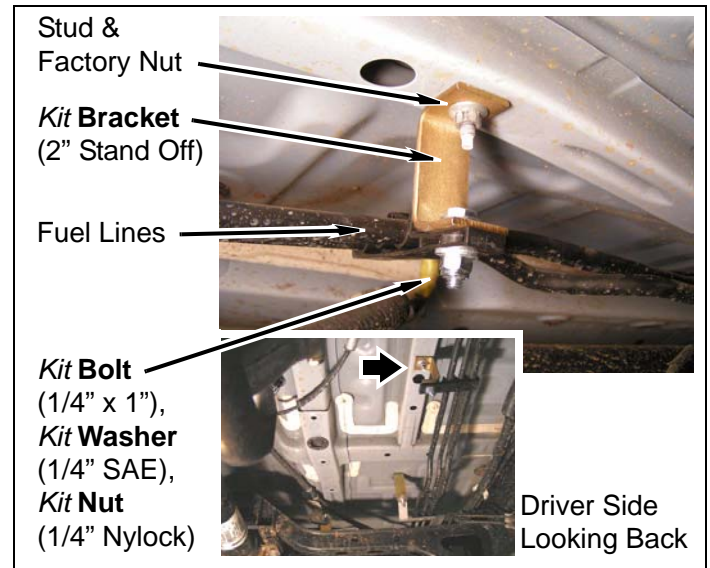

- b. Install fuel line bracket to **kit bracket** (2" stand off) with **kit bolt** (1/4" x 1"), two **kit washers** (1/4" SAE) and **kit nut** (1/4" Nylock).

- c. Install **kit bracket** (3" Z-shaped) to driver side stud with factory nut.

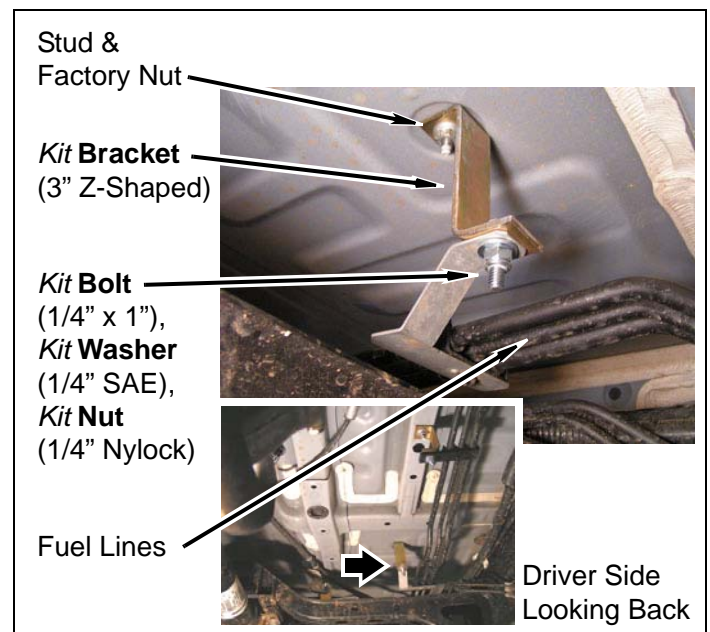

- d. Install fuel line bracket to **kit bracket** (3" Z-shaped) with **kit bolt** (1/4" x 1"), two **kit washers** (1/4" SAE) and **kit nut** (1/4" Nylock).

3. Carefully bend brake lines and install bolt and brake line bracket to frame.

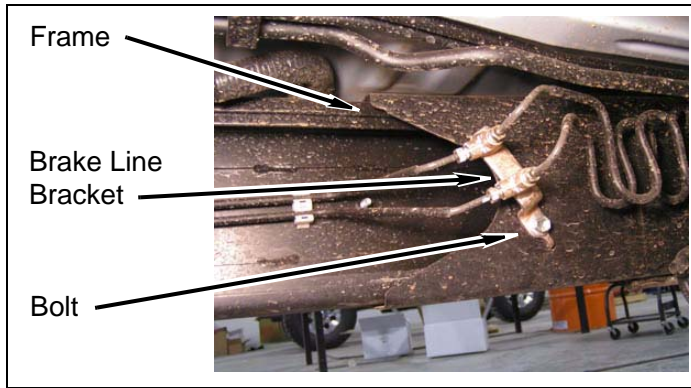

4. Brake lines

- a. Install **kit bracket** (2" Z-shaped) and factory bolt to driver side frame.

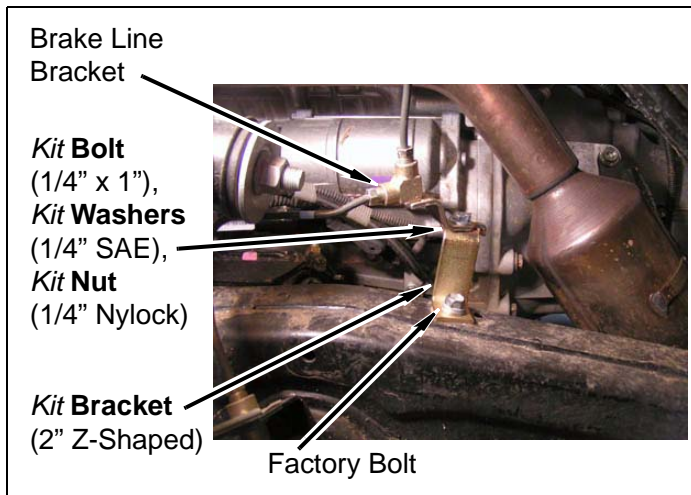

- b. Install brake line bracket to **kit bracket** (2" Z-shaped) with **kit bolt** (1/4" x 1"), two **kit washers** (1/4" SAE) and **kit nut** (1/4" Nylock).
- c. Repeat above steps for passenger side.

Inside of Vehicle

1. Extended cab models: Rear interior trim panels

- a. Install body mount access covers.

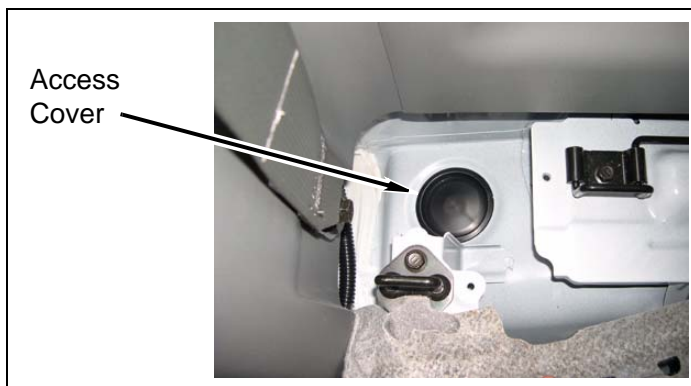

- b. Install driver and passenger body mount access plates and bolts.

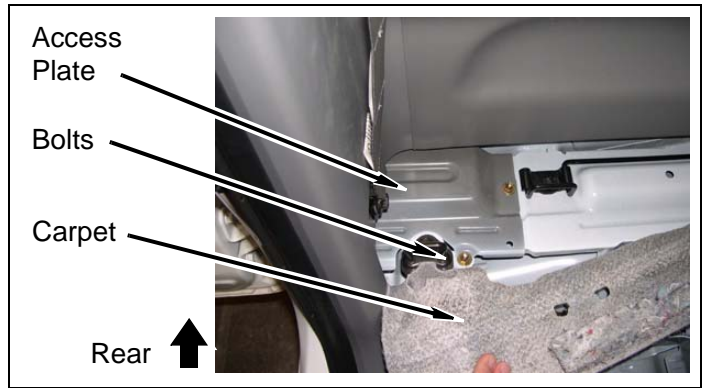

- c. Lay carpet down to cover driver and passenger body mount access plates.

- d. Install storage tray and pop-up clips to vehicle.

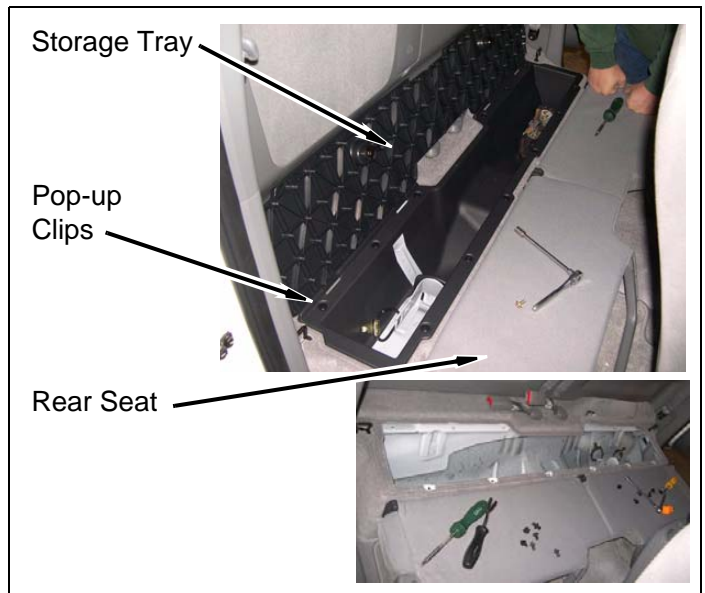

- e. Install jack into storage tray.

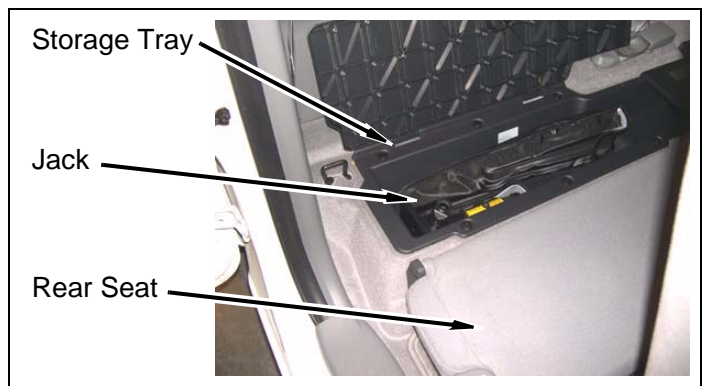

2. Crew cab models: Rear interior trim panels

- a. Install body mount access covers.

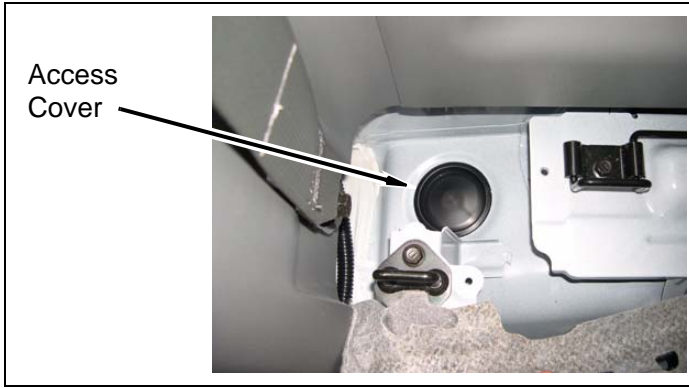

- b. Install passenger side rear panel onto cab with pop-clips and bolt.

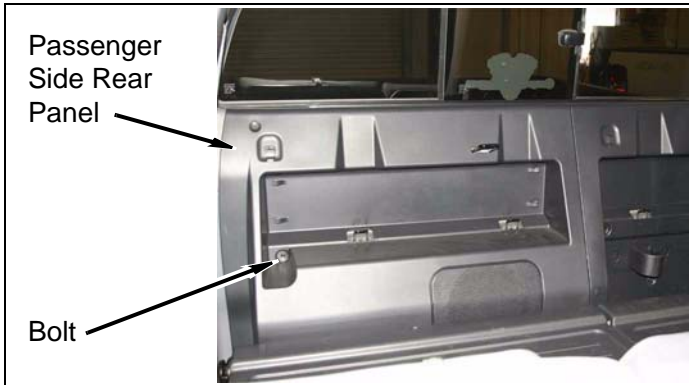

- c. Install driver side rear panel onto cab with pop-clips and three bolts.

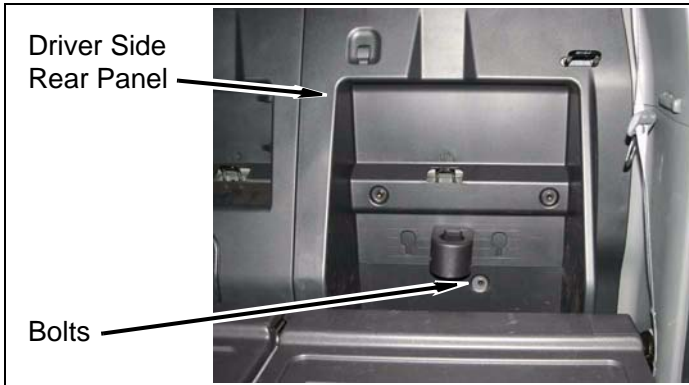

- d. Return seatbacks to upright position and install three headrests onto seatbacks.

3. Front interior trim panels

- a. Install driver and passenger body mount bolt access cover.

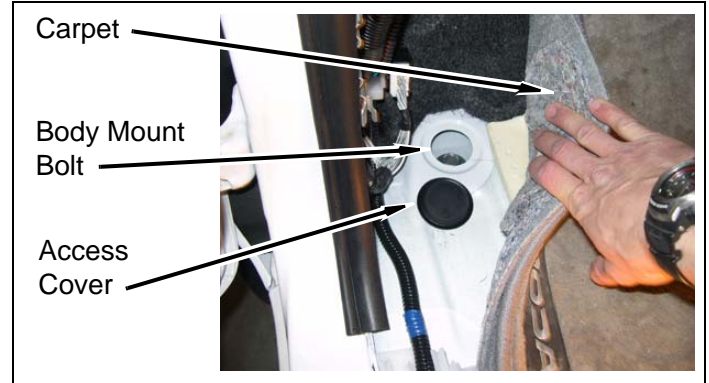

- b. Lay carpet down to cover driver and passenger body mount access covers.

- c. Install driver and passenger kick panels.

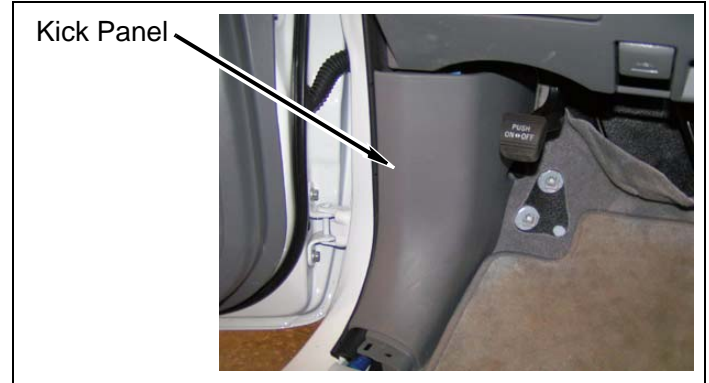

- d. Install dead pedal.

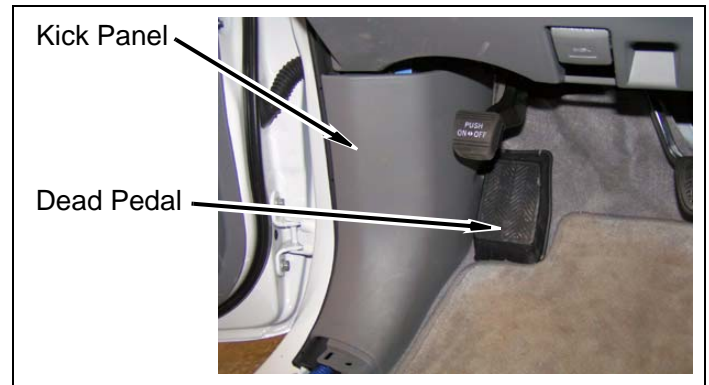

e. Install driver and passenger door sill plates.

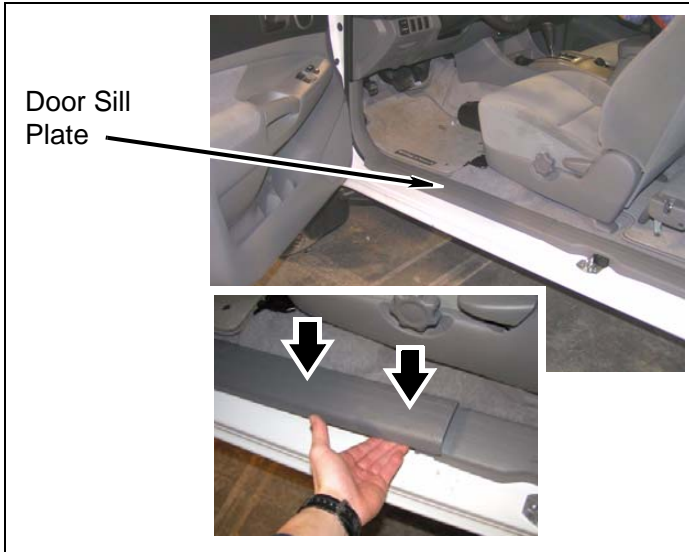

d. Position *kit extension* (manual shifter) between two cut pieces of shifter lever. Ensure alignment marks on each cut shifter lever piece are aligned and rubber boot is on shift lever.

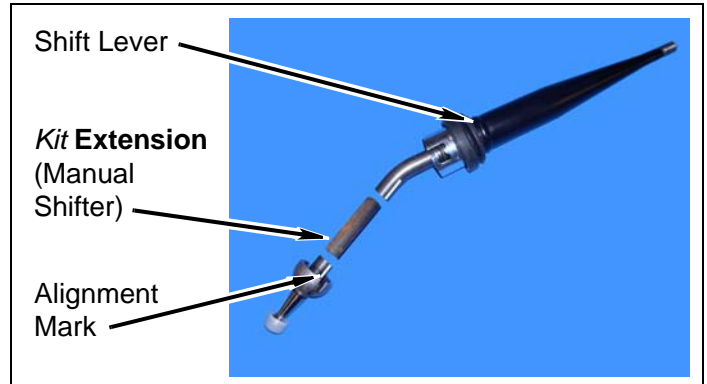

e. Weld *kit extension* (manual shifter) in place.

⚠ WARNING

Welding should be performed by a certified welder.

4. Manual transmission

a. Remove plastic cap from end of shift lever.

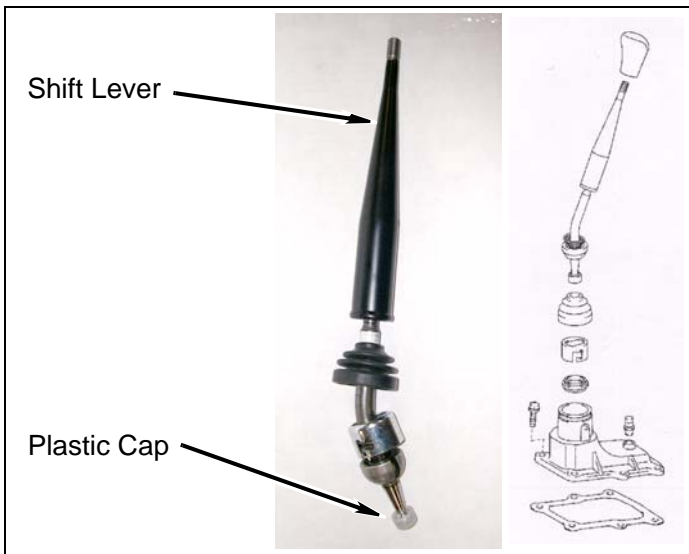

f. Grind off any excess welds.

g. Install plastic cap to end of shift lever.

h. Install shifter lever.

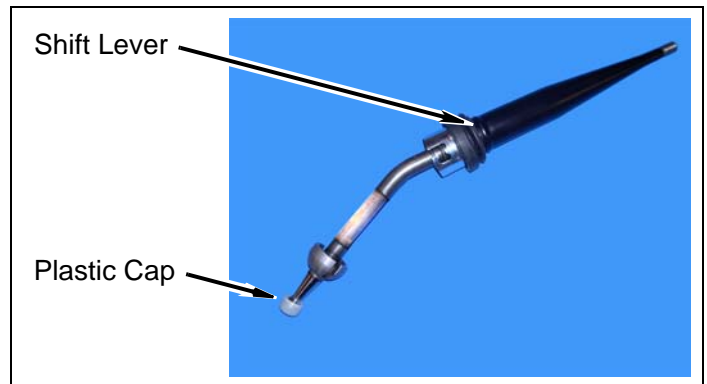

b. Mark alignment and cut lines on shifter lever below bend.

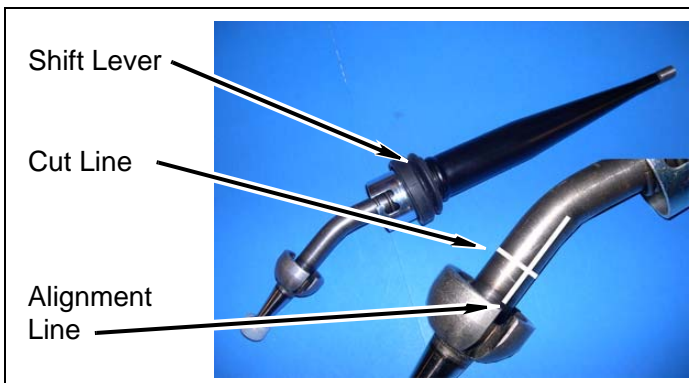

i. Install shift and center consoles.

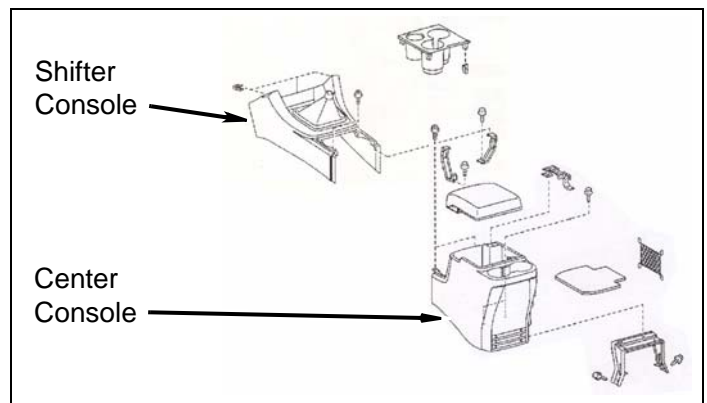

c. Cut shifter lever along marked cut line.

Engine Compartment

1. Steering shaft



⚠ WARNING

Verify the steering extension is securely installed as specified in the instructions. Failure to do so may cause steering malfunction, resulting in property damage or serious personal injury.

- a. Install upper steering shaft into **kit extension** (steering), ensuring marks on upper and lower steering shaft are aligned.

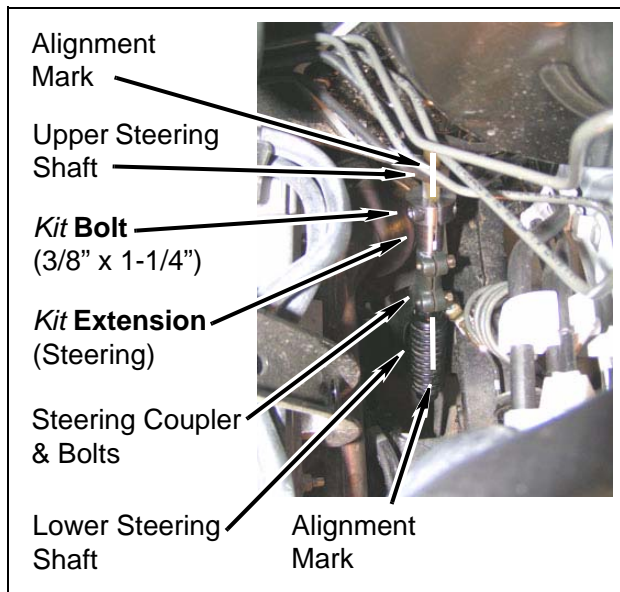

- b. Position **kit extension** (steering) into steering coupler. Ensure marks on upper and lower steering shaft are aligned.
- c. Apply a few drops of **kit Loctite®** to factory bolts and **kit bolt** (3/8" x 1-1/4").
- d. Install bolts and tighten to 33 lb.-ft.

2. Radiator

- a. Cut off tabs on upper radiator mounts.

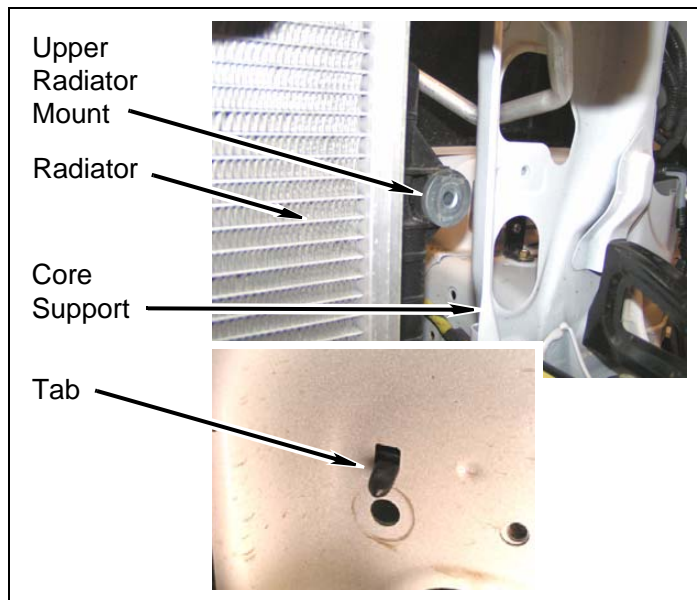

- b. Install four **kit brackets** (3" radiator) to radiator mounts with four factory bolts. **DO NOT TIGHTEN.**

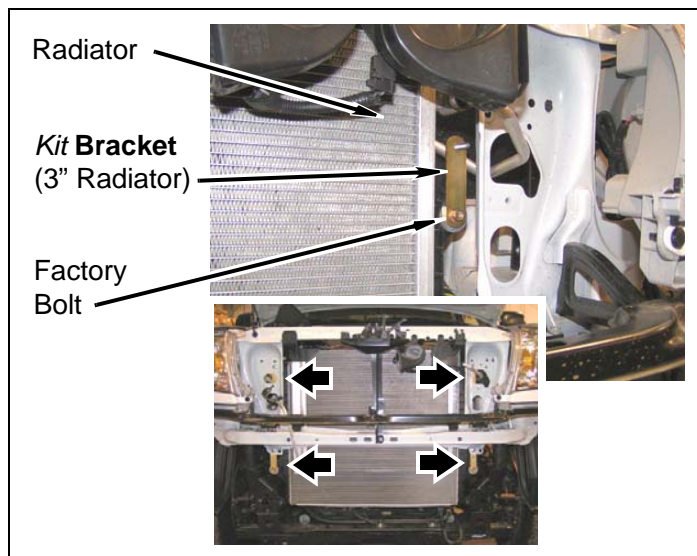

- c. Install radiator and four **kit brackets** to core support with four **kit washers** (1/4" SAE) and four **kit nuts** (1/4" Nylock). DO NOT TIGHTEN.

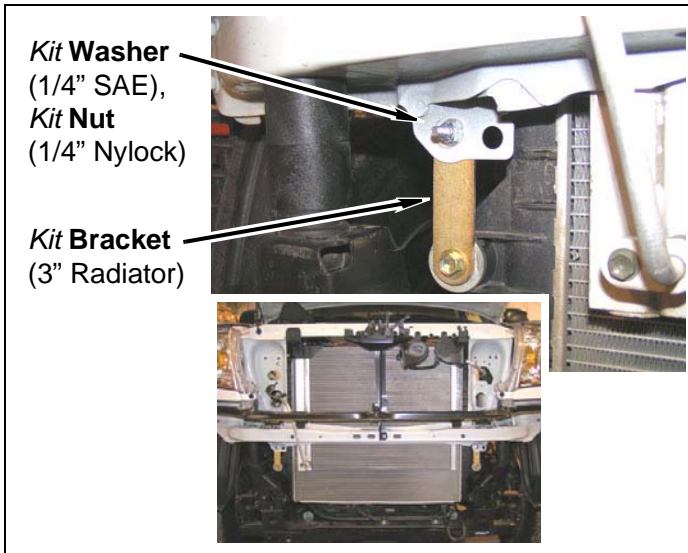

- d. Assemble **kit plates** (radiator block off) with **kit bolt** (1/4" x 1"), two **kit washers** (1/4" SAE) and **kit nut** (1/4" Nylock). DO NOT TIGHTEN.

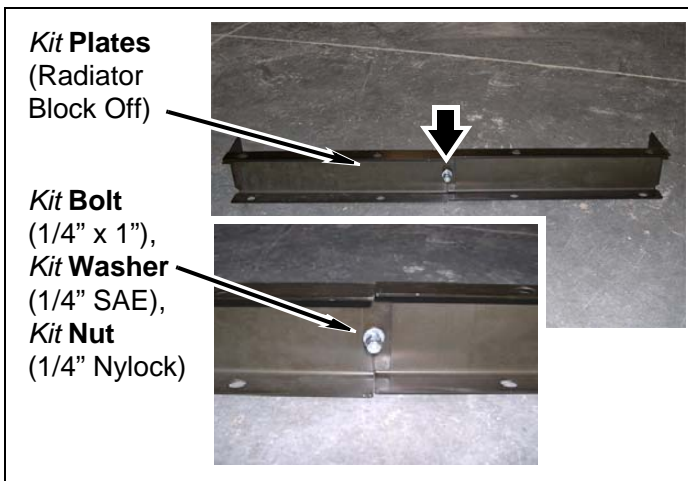

- e. Install **kit plates** (radiator block off) to radiator with four factory pop-up clips.

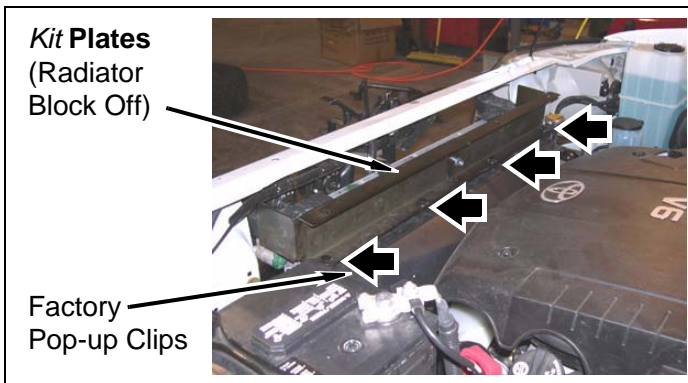

- f. Install radiator cover to core support with five factory pop-up clips.

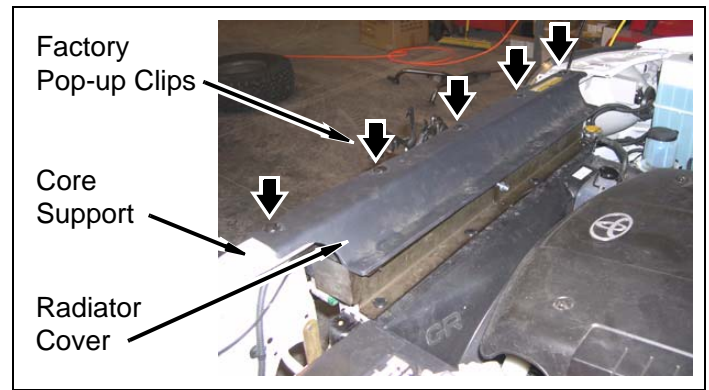

- g. Install radiator cover to **kit plates** (radiator block off) with four **kit clips** (push) and four **kit washers** (1/4" SAE).

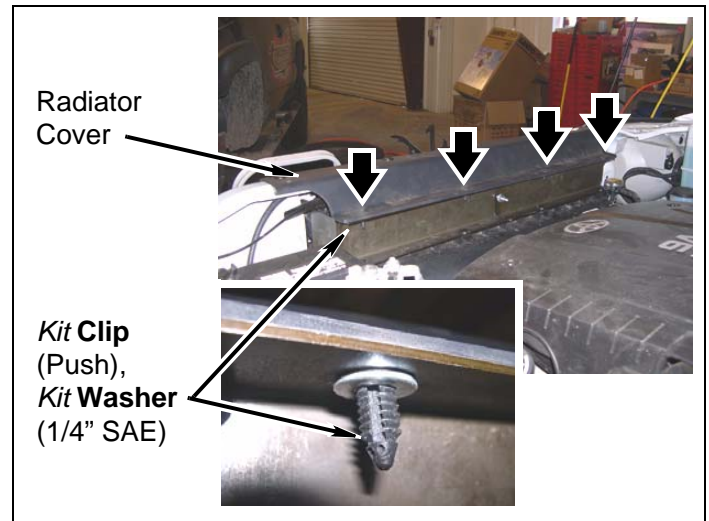

- h. Adjust radiator and ensure fan does not contact fan shroud.

- i. TIGHTEN all hardware.

3. Install wire harness and clips to alternator bracket and driver side body bracket. Adjust clips if necessary.

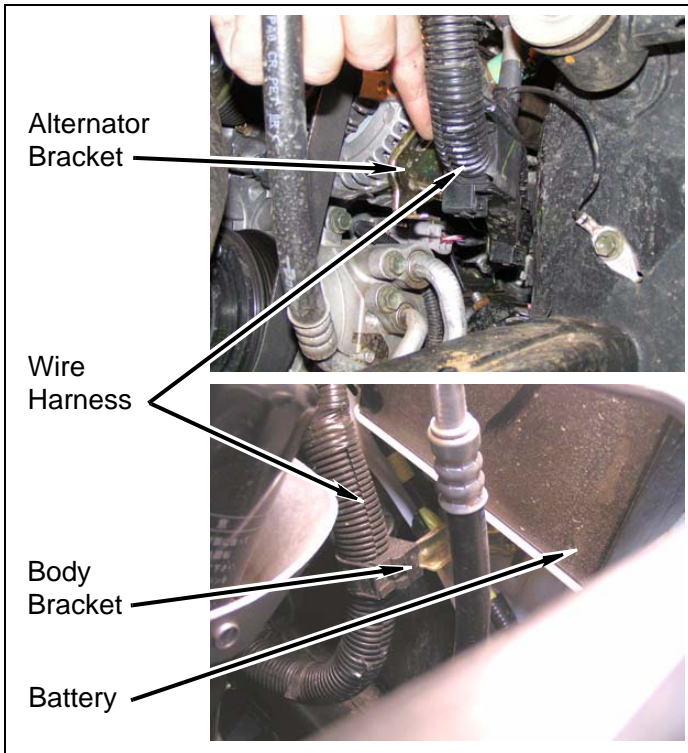

4. Install vent hoses to driver side body bracket with *kit tie* (zip).

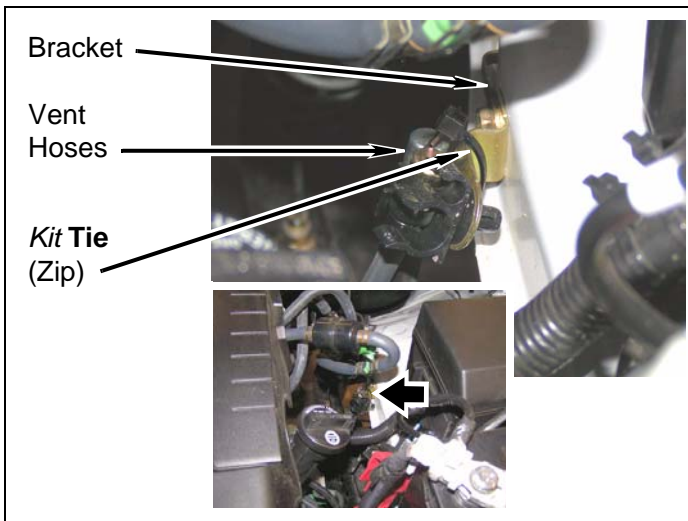

5. Install driver and passenger brake line wire harnesses to brackets with two *kit ties* (zip).

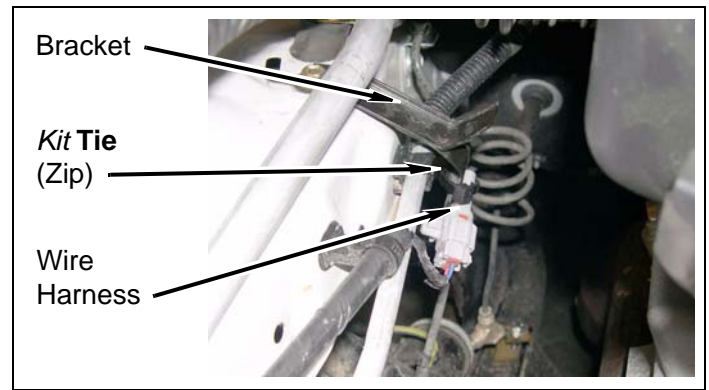

6. Install wire harness clip to firewall bracket.

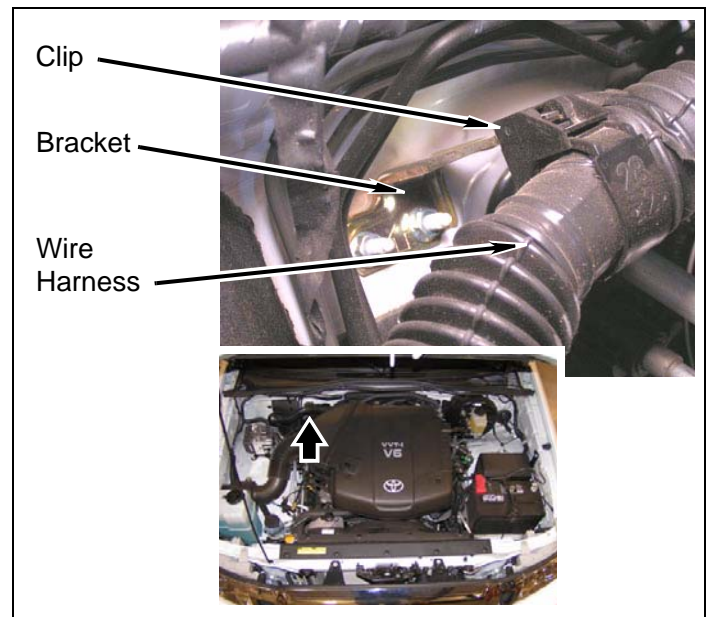

7. Install heater hoses on clip and backside of engine.

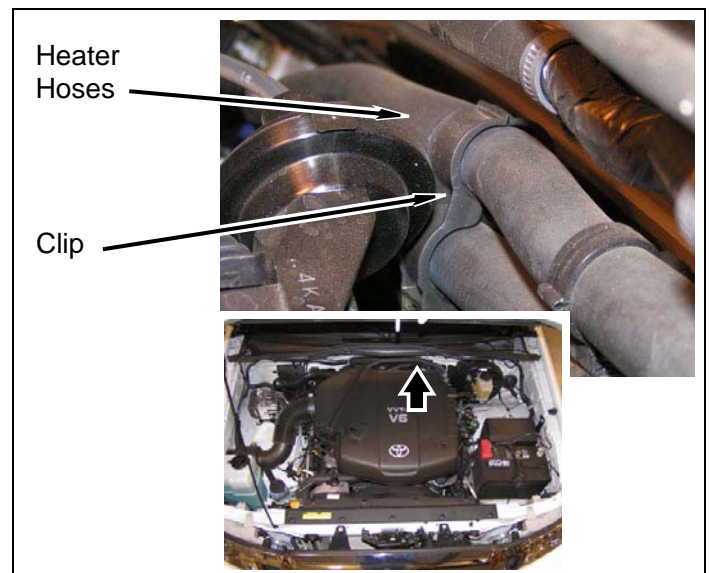

8. 6 cyl. models: Power steering reservoir

- a. Remove reservoir cap and drain contents into drain pan.
- b. Remove two clamps and power steering lines from reservoir.

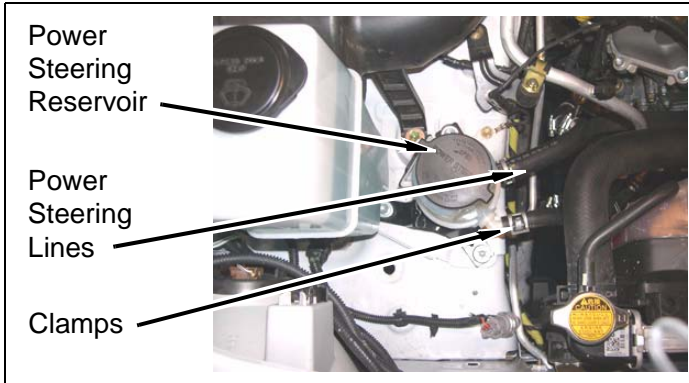

- c. Mark power steering lines.

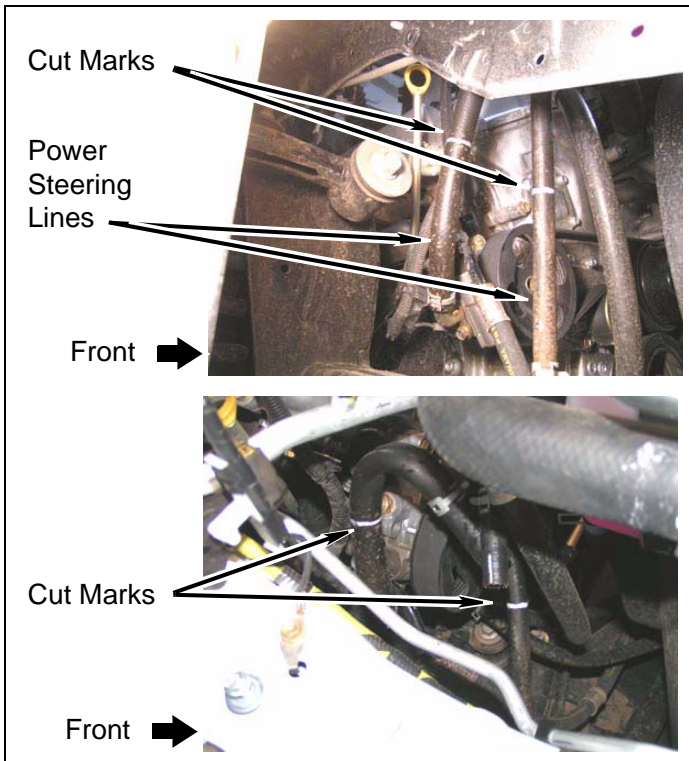

- d. Cut power steering lines along cut marks.
- e. Drain any remaining fluid from power steering lines into drain pan.

- f. Install **kit extension** (7/16" OD x 5" L) between cut power steering lines with two **kit clamps** (#6 hose). DO NOT TIGHTEN.

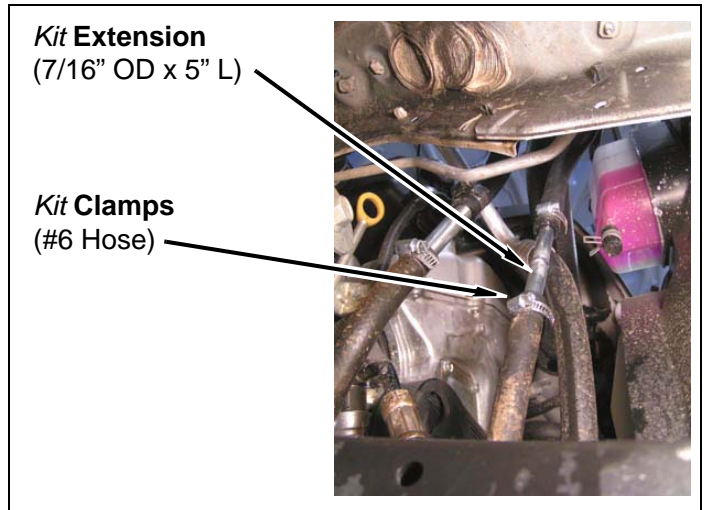

- g. Install **kit extension** (5/8" OD x 5" L) between cut power steering lines with two **kit clamps** (#10 hose). DO NOT TIGHTEN.

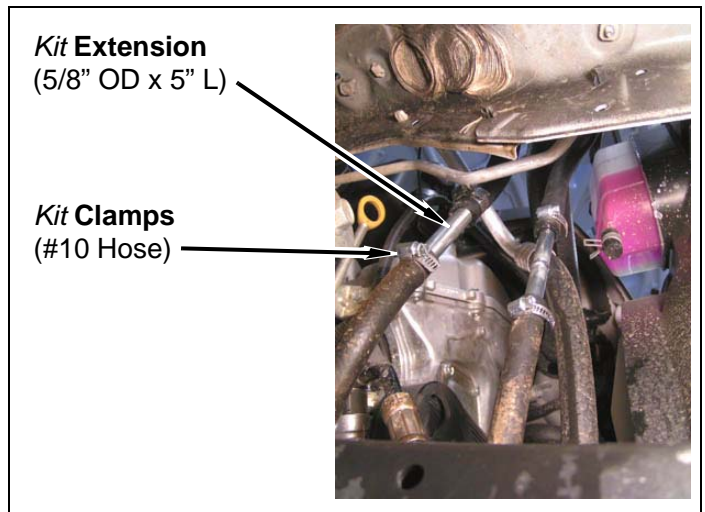

- h. Install power steering reservoir, lines, clamps, and three bolts onto vehicle.

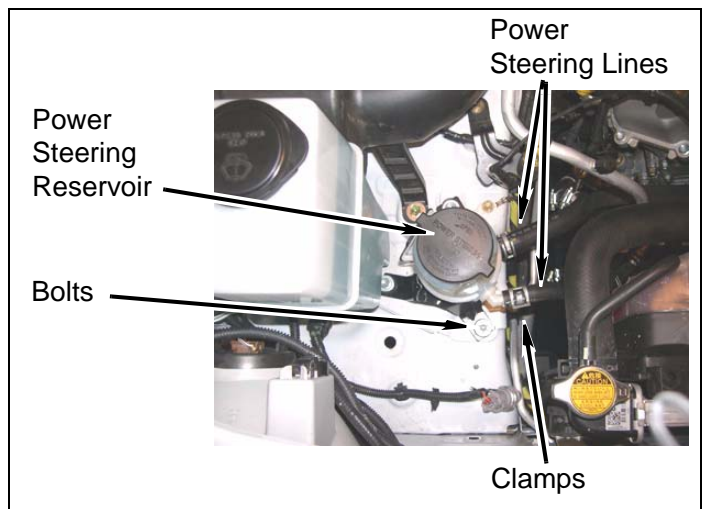

- i. Adjust hoses and tighten all hardware.

9. **4 cyl. models:** Power steering requires no modification.

10. **6 cyl. models:** AC Line

a. Install rubber isolator to body.

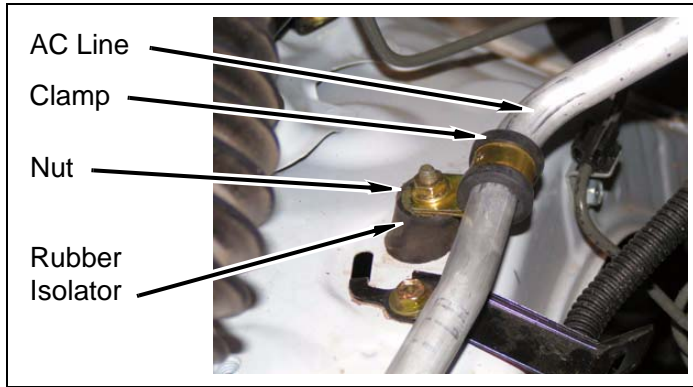

b. Install AC line and clamp onto rubber isolator with nut.

11. **4 cyl. models:** AC Line

a. Install **kit bracket** (3" Z-shaped) to passenger side AC line bracket with bolt.

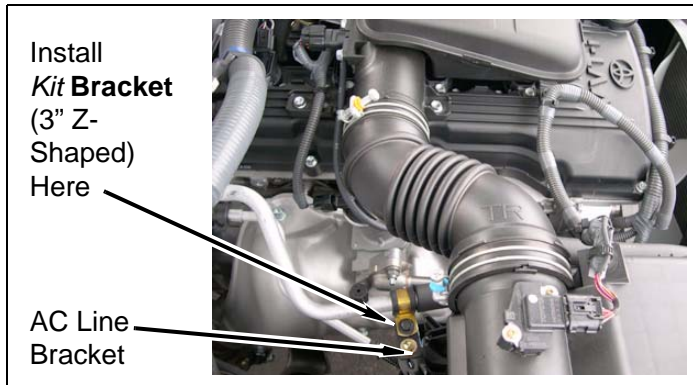

b. Install AC line to bottom of **kit bracket** (3" Z-shaped) with **kit bolt** (1/4" x 1"), two **kit washers** (1/4" SAE) and **kit nut** (1/4" Nylock).

c. Install **kit bracket** (3" w/ stud) to rubber isolator and passenger side AC line bracket with nut.

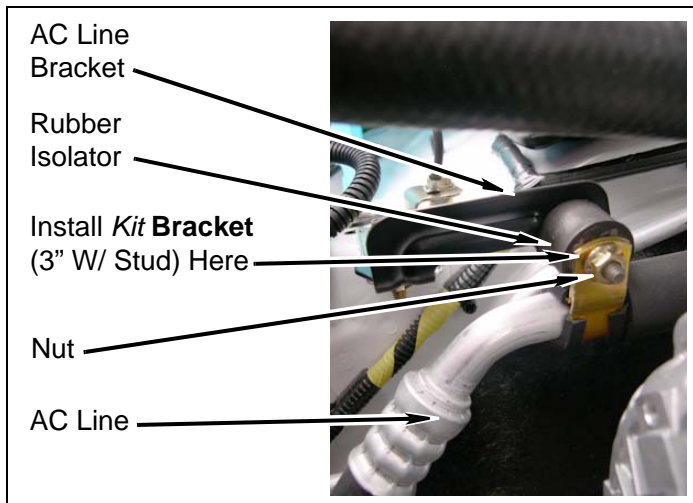

d. Install AC line to **kit bracket** (3" w/ stud) with **kit washer** (1/4" SAE) and **kit nut** (1/4" Nylock).

12. **6 cyl. models:** Install airbox cover to engine with two clips. Tighten clamp.

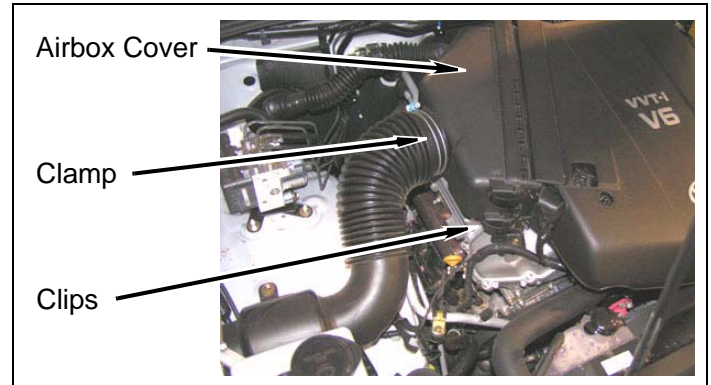

13. **4 cyl. models:** Install air hose to engine with two clamps.

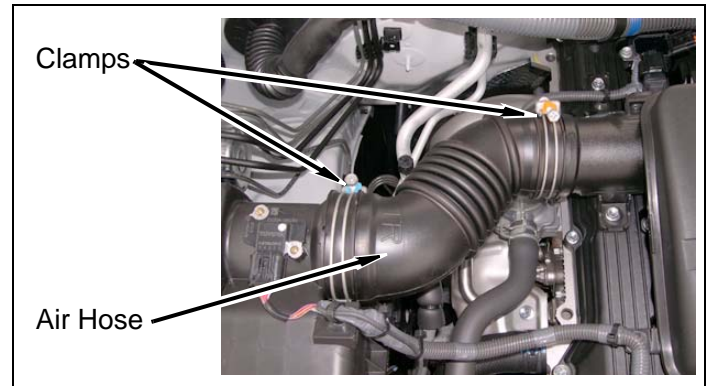

Front of Vehicle

1. **Automatic Transmission Cooler:** (if equipped)

NOTE

Parts to perform the automatic transmission modification are included in Kit# 5903. The automatic transmission cooler is a factory option with the tow package.

a. Cut short trans cooler line as shown.

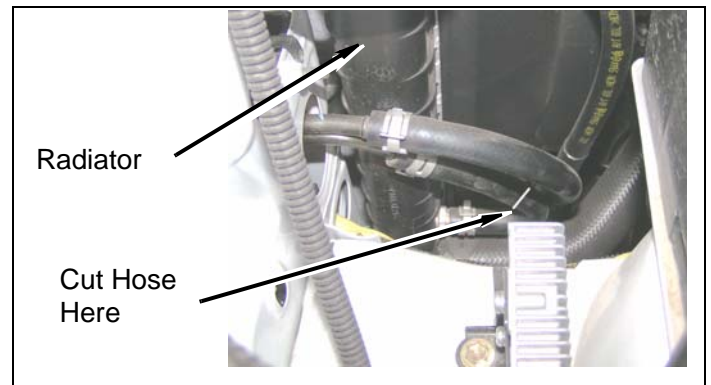

b. Insert **kit extension** (tube 7/16") into cut transmission cooler line with two **kit clamps** (#6 hose). **TIGHTEN** two **kit clamps** (#6 hose).

- c. Install two **kit extension** (sleeve), two **kit bolts** (8mm x 50mm), two **kit washers** (8mm flat), and automatic transmission cooler lines to lower core support.

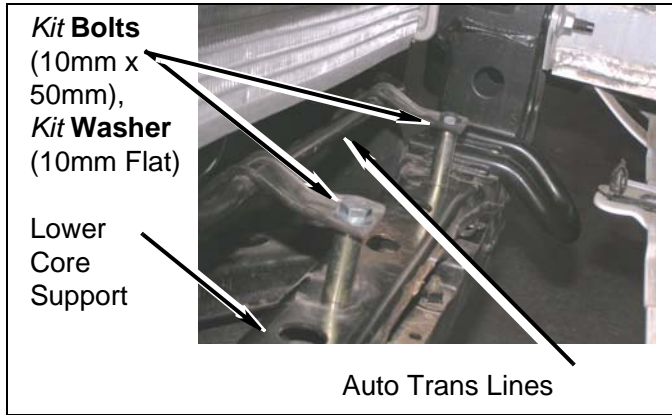

- d. Install automatic transmission cooler onto core support with four bolts.

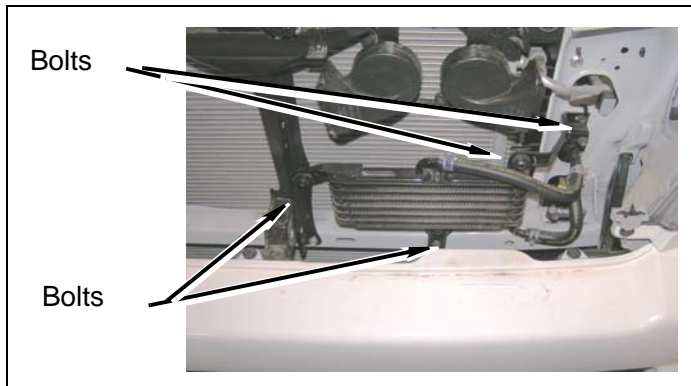

- b. Apply a small amount of **kit Loctite®** to six **kit bolts** (3/8" x 1") and install front bumper to **kit brackets** (front bumper) with twelve **kit washers** (3/8" USS) and six **kit nuts** (3/8" Nylock).

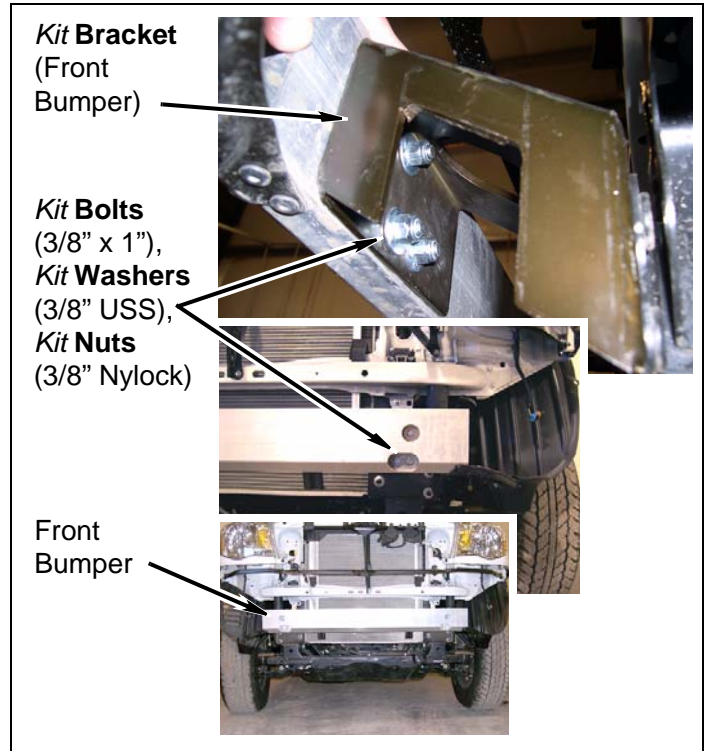

- c. Install front bumper cover to vehicle with six factory screws.

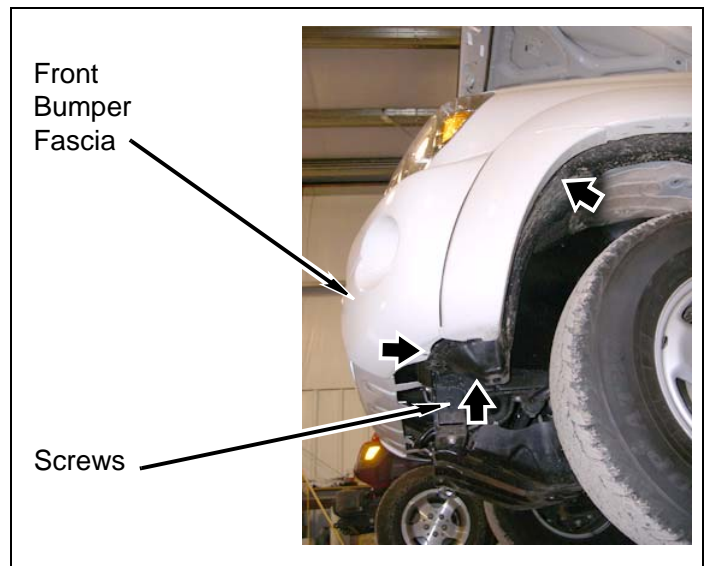

2. Front bumper

- a. Apply a small amount of **kit Loctite®** to six factory studs and install **kit brackets** (front bumper) to frame with six factory nuts.

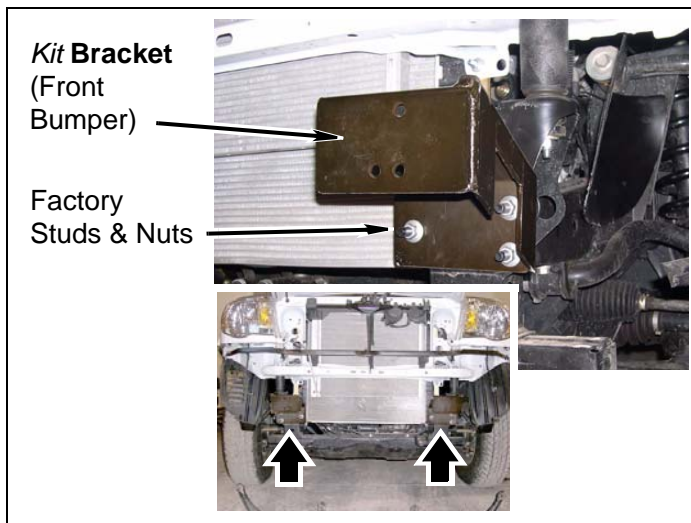

d. Install two pop-up clips to fender wells.

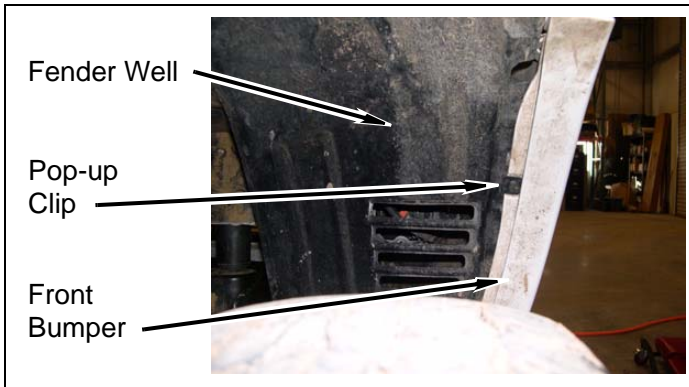

e. Install five pop-up clips to front bumper.

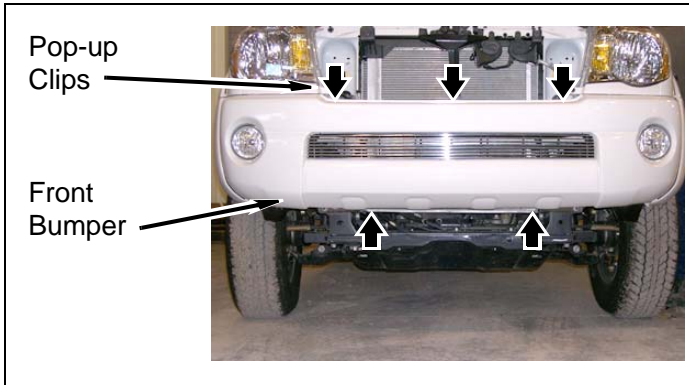

f. Install two pop-up clips, two bolts and grille to core support.

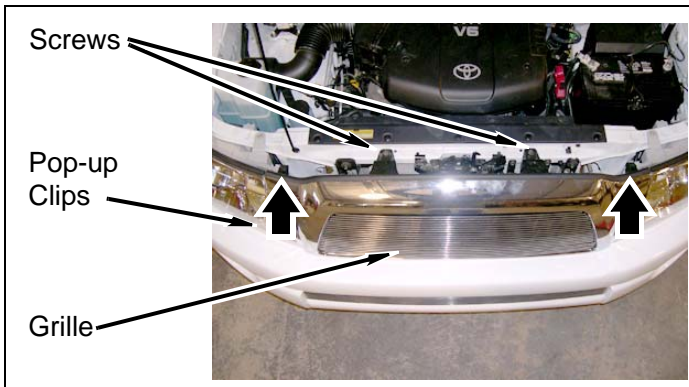

g. Install wiring harnesses to fog lights, if equipped.

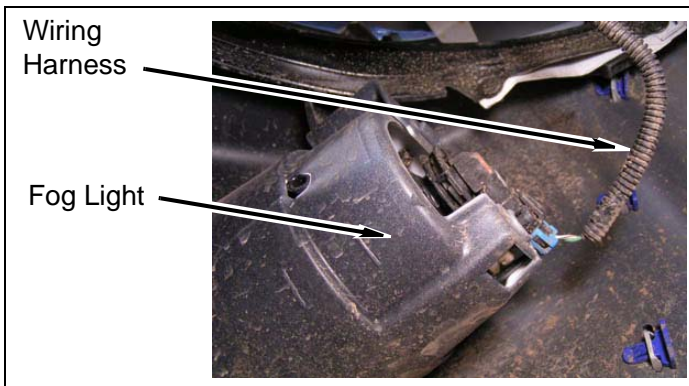

h. Adjust bumper and tighten all hardware.

After Completing Installation

Inside Cab

1. Install airbag fuse and fuse block cover.

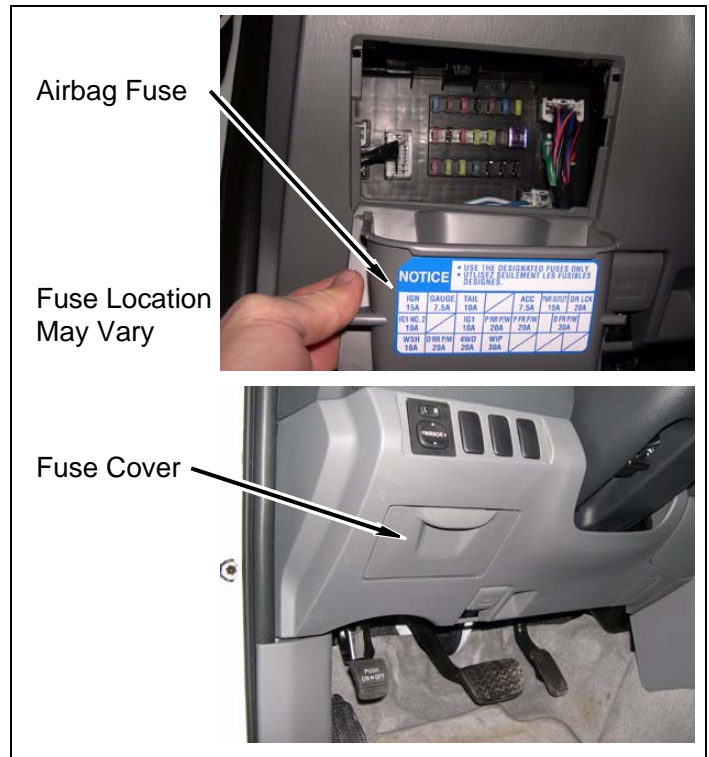

Engine Compartment

1. Connect both battery cables. Connect positive cable first, then negative cable.

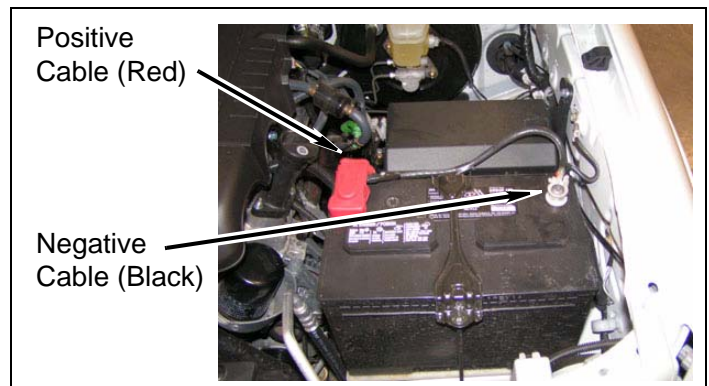

Miscellaneous

1. Apply **kit label** (warning) to dashboard in plain sight of all vehicle occupants.
2. Check all fasteners to ensure they are tight.
3. Ensure all wires, hoses, cables, etc. are properly connected and there is ample slack.
4. Fill and check power steering reservoir with fresh power steering fluid. Start engine and turn wheel several times in either direction. Shut off engine and recheck power steering reservoir. Add fluid, if necessary.

Dynamic Vehicle Check

1. Check steering in both directions to ensure that there is no bind. Check operation of clutch, brake system, and parking brake. Check operation of transmission and transfer case. Ensure there is full engagement in all gears and 4WD ranges. Check battery connections and electrical component operations. Test-drive vehicle..

⚠ WARNING

Retorque all fasteners after 500 miles and after off road use. All body lift components should be visually inspected and fasteners retorqued during routine vehicle servicing.

⚠ CAUTION

Performance Automotive Group does not recommend any particular wheel and tire combinations for use with its body lifts and cannot assume responsibility for the customer's choice of wheels and tires. Refer to your owner's manual for recommended tire sizes and warnings related to the use of oversized tires. Larger wheel and tire combinations increase stress and wear on steering and suspension components, which leads to increased maintenance and higher risk for component failure. Larger wheel and tire combinations also alter speedometer calibration, braking effectiveness, center of gravity, and handling characteristics. Consult an experienced local off road shop to find what wheel and tire combinations work best with your vehicle.

Accessories

The following accessories are also available:

Kit# 6337 - Gap Guards

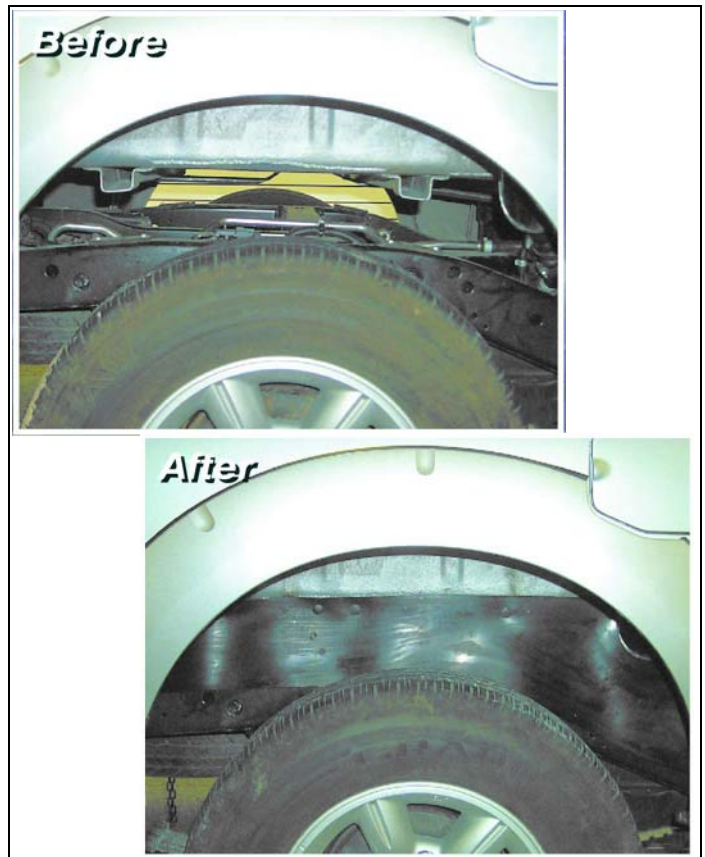

Kit Parts List

Qty.	Description
8	Block , 2" x 3" spacer
4	Block , 3" x 3" spacer
7	Bolt , 1/4"-20 x 1"
6	Bolt , 3/8"-16 x 1"
2	Bolt , 3/8"-16 x 8"
1	Bolt , 3/8"-24 x 1-1/4", socket head
4	Bolt , M12-1.25 x 160mm
2	Bolt , M12-1.25 x 180mm
2	Bolt , M12-1.25 x 210mm
2	Bolt , M12-1.75 x 200mm
1	Bracket , 2" stand off
2	Bracket , 2" Z-shaped
7	Bracket , 3" radiator w/ stud
2	Bracket , 3" Z-shaped
1	Bracket , front bumper, driver
1	Bracket , front bumper, passenger
1	Bracket , rear bumper, driver
1	Bracket , rear bumper, passenger
4	Clamp , #10 hose
2	Clamp , #20 hose
4	Clamp , #6 hose
4	Clip , push
1	Extension , 1" x 6" rubber hose
1	Extension , 1/4" x 6" rubber hose
1	Extension , 5/8" OD x 5" L metal
1	Extension , 5/8" x 3" manual shifter
1	Extension , 5/8" x 6" rubber hose
1	Extension , 7/16" OD x 5" L metal
1	Extension , steering
1	Instruction sheet
1	Label , logo
1	Label , warning
1	Loctite ®, 6mL tube
13	Nut , 1/4"-20 Nylock
2	Nut , 12mm Nylock
8	Nut , 3/8"-16 Nylock
1	Plate , radiator block off, driver
1	Plate , radiator block off, passenger
4	Tie , zip
24	Washer , 1/4" SAE
12	Washer , 3/8" USS

⚠ NOTE

Depending on the vehicle configuration (automatic or manual transmission, 2WD or 4WD, cab length, bed length, etc.), some parts may not be used.

Rev. 03, Copyright 06/06
Performance Automotive Group
www.p-a-g.net

Free Manuals Download Website

<http://myh66.com>

<http://usermanuals.us>

<http://www.somanuals.com>

<http://www.4manuals.cc>

<http://www.manual-lib.com>

<http://www.404manual.com>

<http://www.luxmanual.com>

<http://aubethermostatmanual.com>

Golf course search by state

<http://golfingnear.com>

Email search by domain

<http://emailbydomain.com>

Auto manuals search

<http://auto.somanuals.com>

TV manuals search

<http://tv.somanuals.com>