

Pocket Reference Guide

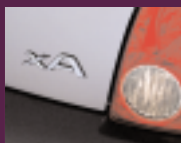

2005



XA

Introducing the new

2005 xA

This *Pocket Reference Guide* is a summary guide for basic vehicle operations. It contains brief descriptions of fundamental operations so you can locate and use the vehicle's main equipment quickly and easily.

The *Pocket Reference Guide* is not intended as a substitute for the *Owner's Manual* located in your vehicle's glove box. We strongly encourage you to review the *Owner's Manual* and supplementary manuals so you will have a better understanding of your vehicle's capabilities and limitations.

Your dealership and the entire staff of Scion, a marque of Toyota Motor Sales, U.S.A., Inc., wish you many years of satisfied driving in your new xA.

! A word about safe vehicle operations

This *Pocket Reference Guide* is not a full guide to xA operations. Every xA owner should review the *Owner's Manual* that accompanies this vehicle.

Pay special attention to the boxed information highlighted in yellow throughout the *Owner's Manual*. Each box contains safe operating instructions to help you avoid injury or equipment malfunction.

All information in this *Pocket Reference Guide* is current at the time of printing. Scion reserves the right to make changes at any time without notice.

TABLE OF CONTENTS

Item	Page no.
OVERVIEW	
Engine compartment	7
Fuel tank door opener	6
Hood release lever	6
Indicator symbols	4-5
Instrument cluster	4-5
Instrument panel	2-3
FEATURES/OPERATIONS	
Air conditioning/Heating system	14
Automatic transmission	8
Clock	13
Cup holders	11
Grocery bag hooks	10
Lights & turn signals	11
Parking brake	10
Seat adjustments-Front	9
Seat adjustments-Rear	9
Seats-Head restraints	9
Tilt steering wheel	10
Window wiper & washer-Rear	12
Windows-Power	13
Windshield wiper & washer-Front	12
SAFETY AND EMERGENCY FEATURES	
Airbag-Supplemental Restraint System	16
Doors-Child safety locks	15
Seat belts	15
Seat belts-Shoulder belt anchor	15
Spare tire & tools	17

OVERVIEW

Instrument panel

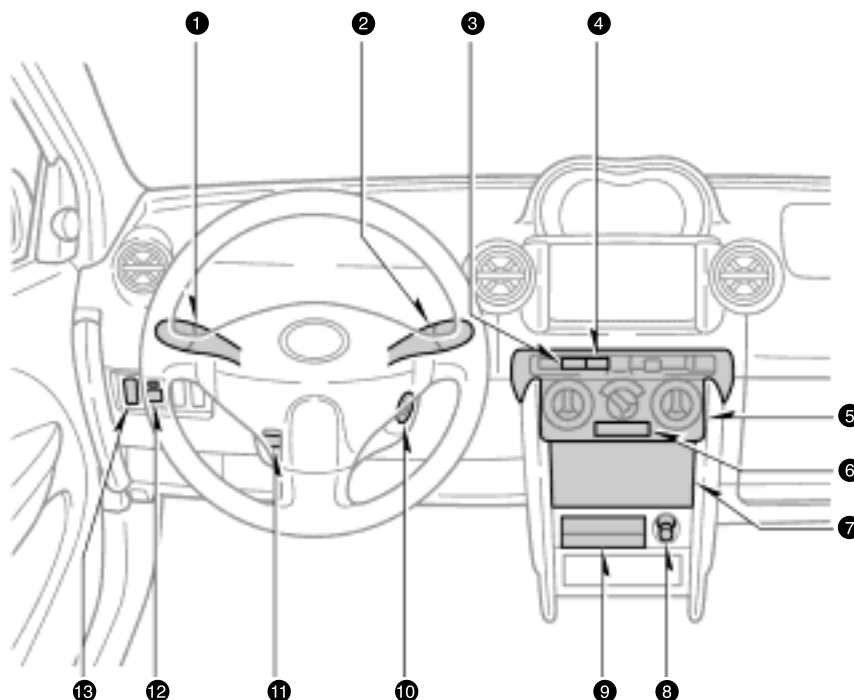

- ❶ Headlight and turn signal switches
- ❷ Wiper and washer switches
- ❸ Rear window defogger switch
- ❹ Emergency flasher switch
- ❺ Air conditioning/Heater controls
- ❻ Front passenger seat belt reminder light
- ❼ Auxiliary box

- ❽ Cigarette lighter
- ❾ Ashtray
- ❿ Ignition switch
- ⓫ Tilt steering lock release lever
- ⓬ Power rear view mirror control switch
- ⓭ Instrument panel light control dial

Instrument cluster

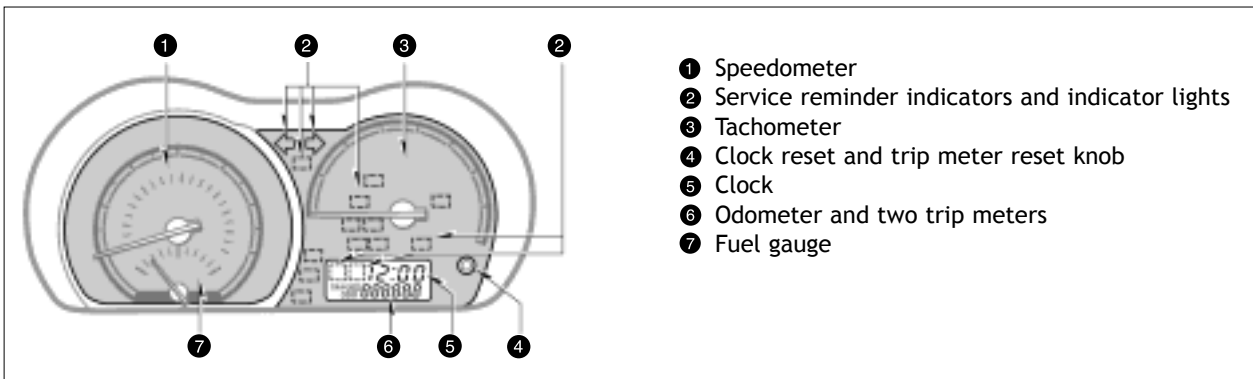

Indicator symbols

BRAKE	Brake system warning light ¹		Open door warning light ¹
	Driver's seat belt reminder light ¹		Airbag SRS warning light ¹
PASSENGER	Front passenger seat belt reminder light ¹		Low fuel level warning light ¹
	Battery warning light ¹		Turn signal indicator lights
MAINT REQD	Engine oil replacement reminder light		Headlight high beam indicator light
	Malfunction indicator light ¹		Overdrive-off indicator light
	Low engine oil pressure warning light ¹		
	Low engine coolant temperature indicator light		
	High engine coolant temperature warning light ¹		
ABS	Anti-lock brake system warning light ¹		

CAUTION

When the anti-lock brake system (ABS) function is in action, you may feel the brake pedal pulsating and hear a noise. In this situation, to let the anti-lock brake system work for you, just hold the brake pedal down more firmly. Do not pump the brake as this will result in reduced braking performance.

¹For details, refer to "Service reminder indicators and warning buzzers," Section 1-6, 2005 Owner's Manual.

Fuel tank door opener



To open the fuel tank door Pull up on the opener.

Hood release lever



To open the hood Pull the lever inside the vehicle.

Engine compartment

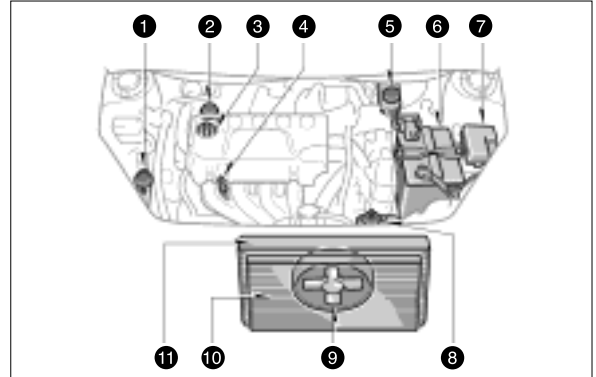

- ❶ Windshield washer fluid tank
- ❷ Power steering fluid reservoir
- ❸ Engine oil filler cap
- ❹ Engine oil level dipstick
- ❺ Brake fluid reservoir
- ❻ Battery
- ❼ Fuse block
- ❽ Engine coolant reservoir
- ❾ Electric cooling fan
- ❿ Condenser
- ⓫ Radiator

Note: Regularly scheduled maintenance, including oil changes, will help extend the life of your vehicle and maintain performance. Please refer to the "Owner's Warranty Information Booklet," or "Scheduled Maintenance Guide."

FEATURES/OPERATIONS

Automatic transmission

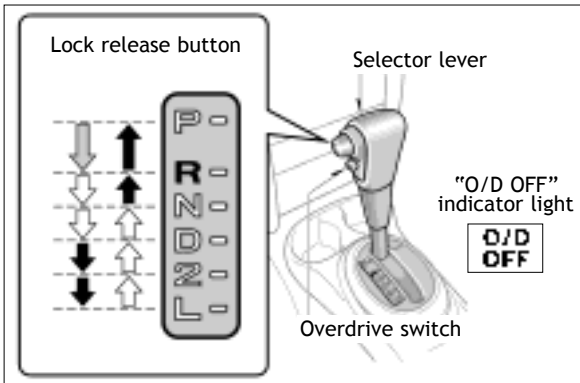

- P** Park Engine starting and key removal
- R** Reverse
- N** Neutral
- D** Drive (see “Overdrive switch” below)
- 2** Second gear Increased engine braking
- L** First gear Maximum engine braking

Lock release button

- ↓ With the brake pedal depressed, shift while holding the lock release button in (the ignition switch must be in the “ON” position).
- ↓↑ Shift while holding the lock release button in.
- ↓↑ Shift normally.

Overdrive switch

To turn “ON” or “OFF” Depress the overdrive switch to choose either three-speed (“OFF”) or four-speed (“ON”) operation. During normal driving conditions, always drive with overdrive “ON;” this allows the transmission to shift automatically into four-speed operation at higher speeds, increasing fuel economy. If the indicator light on the instrument cluster is illuminated, overdrive is “OFF.”

Seat adjustments-Front

Adjusting front seats



- ① Seat position adjusting lever
- ② Seatback angle adjusting lever

Seat adjustments-Rear

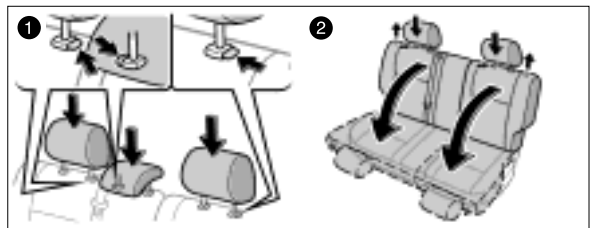

To fold rear seats

- ① Lower the head restraints.
- ② Pull the lock release button up and fold the seatback down.

Seats-Head restraints

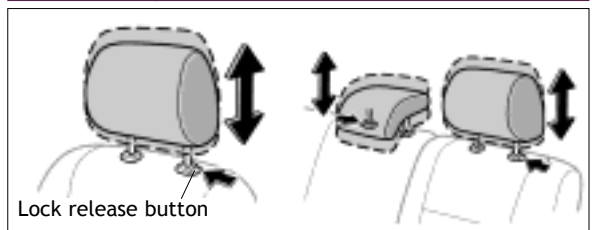

To raise Pull up the head restraint.

To lower Push down the head restraint while pressing the lock release button.

Tilt steering wheel

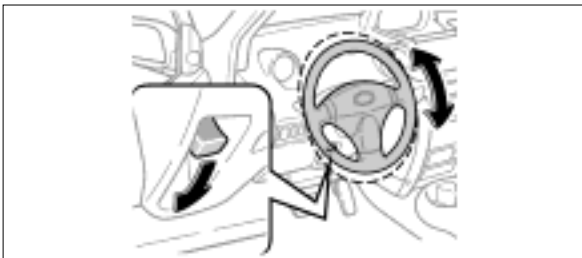

To change the steering wheel angle Hold the steering wheel, push the lock release lever down, tilt to desired angle, and return the lever to its original position.

Note: Do not attempt to adjust while the vehicle is in motion.

Parking brake

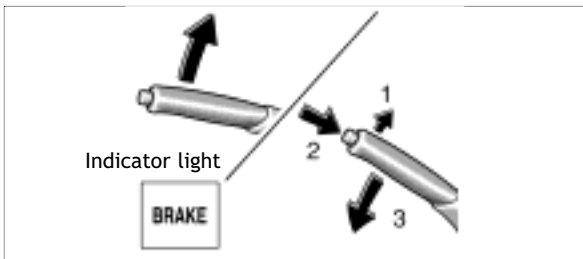

To set Pull the lever.

To release Pull the lever up slightly, press the lock release button, and lower.

Grocery bag hooks

Front seatbacks

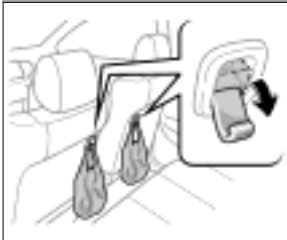

Luggage compartment



To use the hook Pull it down.

Refer to your *Owner's Manual* for more details.

Cup holders

Front



Rear



Lights & turn signals

Headlights

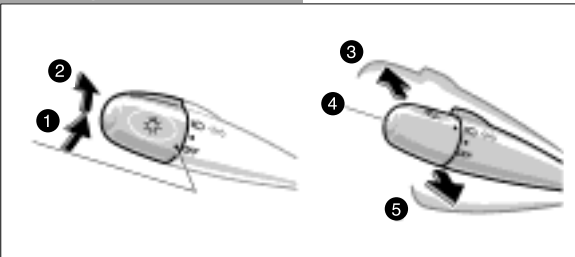

- 1 Parking, tail, license plate, side marker and instrument panel lights Twist the lever knob to position 1.
- 2 Headlights and all of the above Twist the lever knob to position 2.
- 3 High beams Push the lever.
- 4 Low beams
- 5 Headlight flasher Pull the lever.

Turn signals

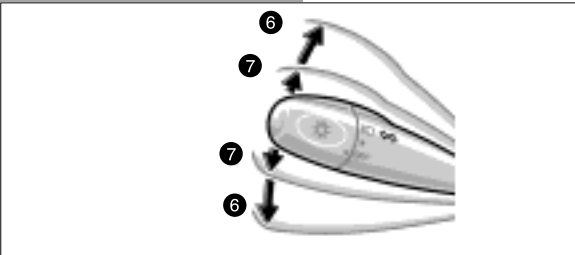

- 6 Right or left turn Push the lever up or down.
- 7 Lane change Move the lever up or down to position 7 and hold.

Windshield wiper & washer-Front

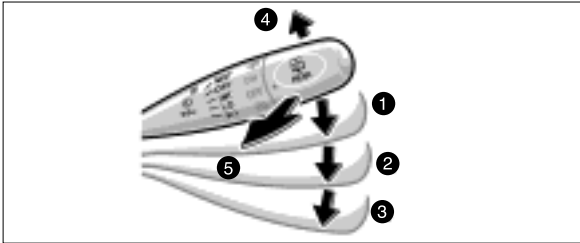

- ❶ Intermittent speed Push the lever down to position 1.
- ❷ Slow speed Push the lever down to position 2.
- ❸ Fast speed Push the lever down to position 3.
- ❹ Single wipe Push the lever up to position 4.
- ❺ Washer fluid Pull the lever toward you.

Window wiper & washer-Rear

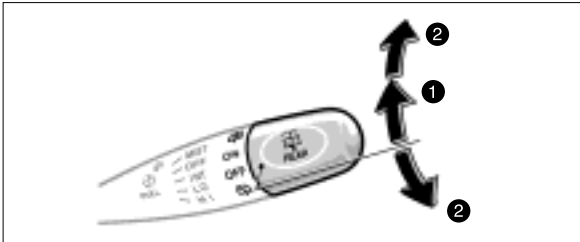

- ❶ Normal speed Twist the lever knob to position 1.
- ❷ Washer fluid Twist the lever knob upward or downward to position 2.

Windows-Power

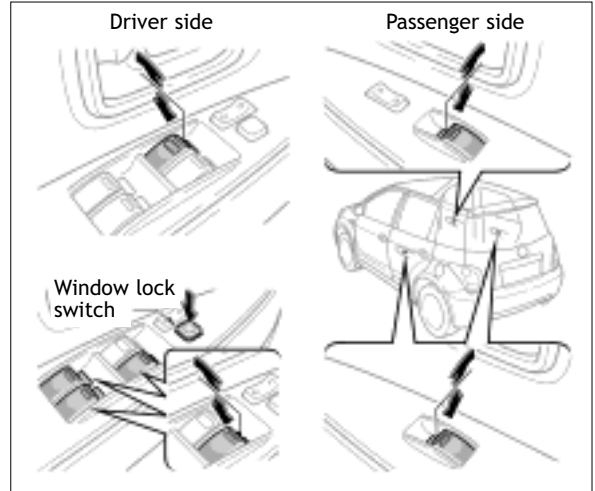

Window operation

To open or close Push down or pull up on the switch.
Driver side window only Push the switch completely down and release to fully open.

Window lock switch

Push the switch to deactivate the passenger windows.

Clock

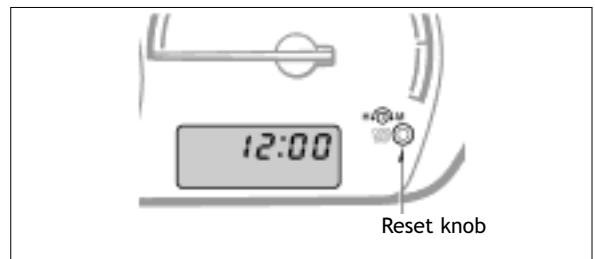

To reset the hour Turn the knob counterclockwise.
 To reset the minutes Turn the knob clockwise.

Refer to your *Owner's Manual* for more details.

Air conditioning/Heating system

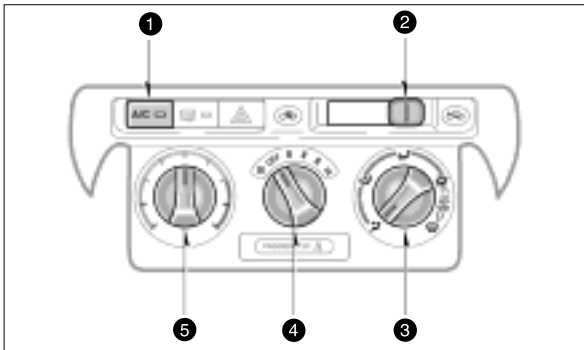

- ❶ "A/C" button Push to turn air conditioning on/off.
- ❷ Air intake selector Move the lever for fresh or recycled air.
- ❸ Air flow selector (See "To select air flow vents" below)
- ❹ Fan speed selector Turn right to increase, or left to decrease fan speed.
- ❺ Temperature selector Turn right to increase, or left to decrease the desired temperature inside the vehicle.

To select air flow vents

Turn the air flow selector to select one of the following:

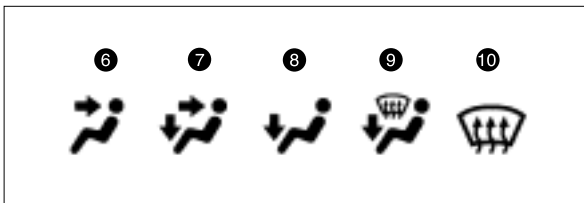

- ❻ Instrument panel vents
- ❼ Floor and panel vents
- ❽ Floor vents
- ❾ Floor and windshield vents
- ❿ Windshield vents

Refer to your *Owner's Manual* for more details.

SAFETY AND EMERGENCY FEATURES

Doors-Child safety locks

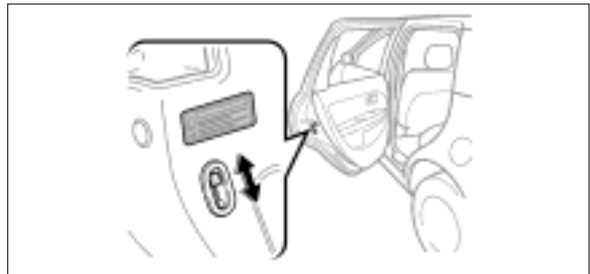

To lock Move the lever to "LOCK," allowing the door to be opened only from the outside.

Seat belts

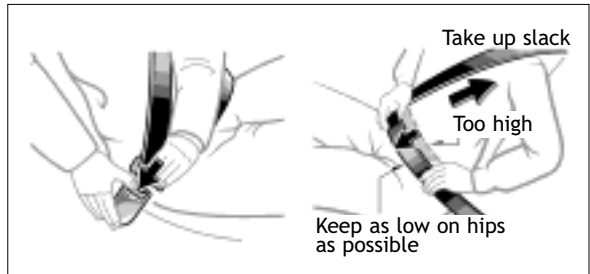

Refer to your *Owner's Manual* for more details.

To install a child restraint system Refer to your *Owner's Manual* for more details.

Seat belts-Shoulder belt anchor

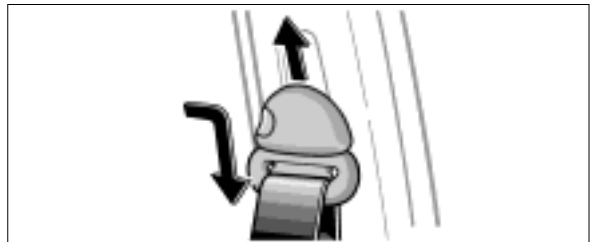

To raise Slide the anchor upward.
To lower Push the lock release button and slide the anchor downward.

Airbag-Supplemental Restraint System

The Airbag Supplemental Restraint System (SRS) front, side and side curtain* airbags are designed to help provide further protection for the driver, front passenger and rear outside passengers in addition to the primary safety protection provided by the seat belts.

Please read the caution boxes below, and refer to your *Owner's Manual* for more details.

CAUTION

- The driver and front passenger airbag Supplemental Restraint System (SRS) is designed only as a supplement to the primary protection of the seat belt systems of the driver and front passenger. The front seat occupants are particularly susceptible to injury if they do not wear their seat belts; when sudden braking or a collision occurs, they may be thrown forward. To obtain maximum protection in an accident, the driver and all passengers in the vehicle should always wear their seat belts when driving because serious injuries or death can result to unrestrained occupants. For instructions and precautions concerning the seat belt system, see "Seat belts" in the *Owner's Manual*.
- Scion strongly urges the use of a proper child restraint system on the rear seat that conforms to the size of the child. According to accident statistics, a child is safer when properly restrained in the rear seat than in the front seat.
- Never use a rear-facing child restraint system in the front seat. The force of the rapid inflation of the passenger airbag can cause severe injury or death to a child.
- Unless it is unavoidable, do not install a forward-facing child restraint system on the front seat. If you must install a forward-facing child restraint system on the front seat, move the seat as far back as possible.
- Make sure you have complied with all installation instructions provided by the child restraint manufacturer and the system is properly secured.

CAUTION

- The SRS side and side curtain airbags (optional) are designed to deploy in certain types of severe side impact collisions. In all other collisions, the side and side curtain airbags will not deploy. For instructions and precautions, see your *Owner's Manual*
- Do not lean against the side doors when the vehicle is in use. The side impact and side curtain airbags inflate with considerable speed and force. Death or serious injury could result.
- Do not modify, cover or replace the surface of the front seats. Such changes could disable the system or prevent the airbags from activating correctly, resulting in death or serious injury.

*If installed

Spare tire & tools

Tool location

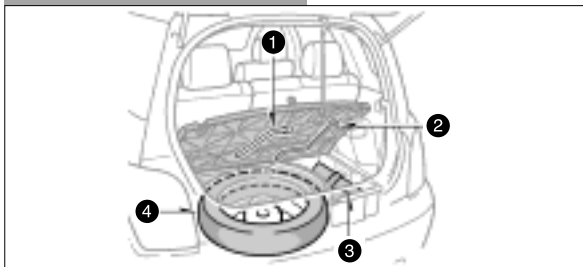

- 1 Wheel nut wrench
- 2 Jack handle
- 3 Tool bag
- 4 Spare tire

Removing the spare tire



To remove the spare tire

- 1 Remove the spare tire cover.
- 2 Loosen the bolt with spacer and remove it.

Refer to your *Owner's Manual* for tire changing procedures.

Scion Customer Assistance Center
1-866-70-Scion

Or visit our web site at
www.scion.com



Scion, a marque of Toyota Motor Sales, U.S.A., Inc.
00452-PRG05-XA

Free Manuals Download Website

<http://myh66.com>

<http://usermanuals.us>

<http://www.somanuals.com>

<http://www.4manuals.cc>

<http://www.manual-lib.com>

<http://www.404manual.com>

<http://www.luxmanual.com>

<http://aubethermostatmanual.com>

Golf course search by state

<http://golfingnear.com>

Email search by domain

<http://emailbydomain.com>

Auto manuals search

<http://auto.somanuals.com>

TV manuals search

<http://tv.somanuals.com>