

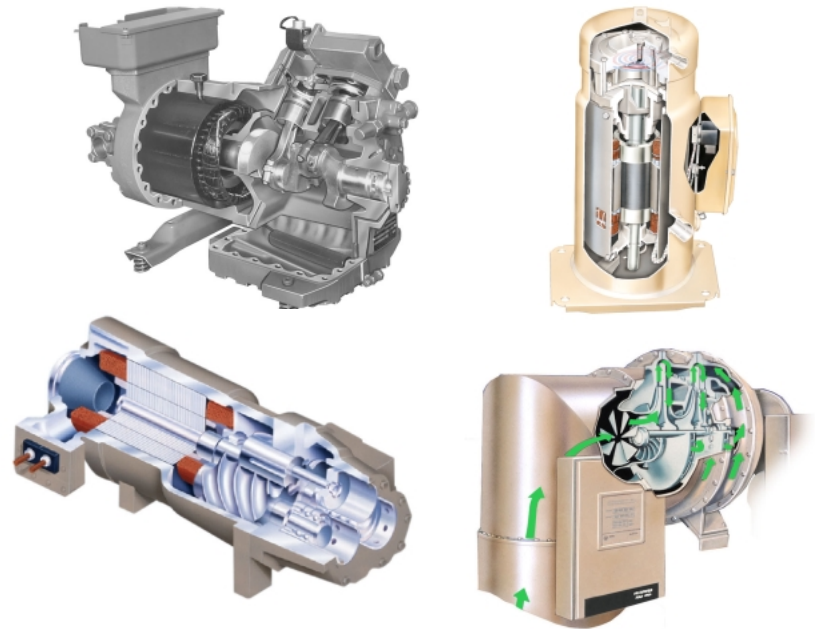

Air Conditioning Clinic

Refrigeration Compressors

One of the Fundamental Series



TRG-TRC004-EN



NO POSTAGE
NECESSARY
IF MAILED
IN THE
UNITED STATES

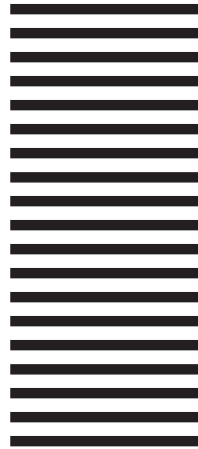

BUSINESS REPLY MAIL
FIRST-CLASS MAIL PERMIT NO. 11 LA CROSSE, WI

POSTAGE WILL BE PAID BY

THE TRANE COMPANY
Attn: Applications Engineering
3600 Pammel Creek Road
La Crosse WI 54601-9985



NO POSTAGE
NECESSARY
IF MAILED
IN THE
UNITED STATES

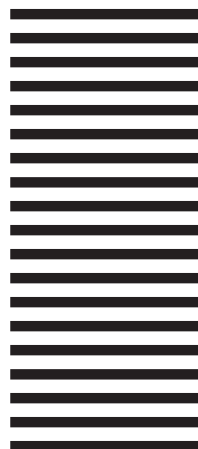

BUSINESS REPLY MAIL
FIRST-CLASS MAIL PERMIT NO. 11 LA CROSSE, WI

POSTAGE WILL BE PAID BY

THE TRANE COMPANY
Attn: Applications Engineering
3600 Pammel Creek Road
La Crosse WI 54601-9985



Crop to width of 7.75"

Perforation 0.75" from edge

Comment Card

We want to ensure that our educational materials meet your ever-changing resource development needs. Please take a moment to comment on the effectiveness of this Air Conditioning Clinic.

Refrigeration Compressors One of the Fundamental Series

TRG-TRC004-EN

Level of detail (circle one) Too basic Just right Too difficult

Rate this clinic from 1-Needs Improvement to 10-Excellent ...

	1	2	3	4	5	6	7	8	9	10
Content										
Booklet usefulness										
Slides/illustrations										
Presenter's ability										
Training environment										
Other comments?	_____									

About me ... Type of business _____
 Job function _____
 Optional: name _____
 phone _____
 address _____

Give the completed card to the presenter or drop it in the mail. Thank you!



TRANE

The Trane Company • Worldwide Applied Systems Group

3600 Pammel Creek Road • La Crosse, WI 54601-7599
 www.trane.com

An American-Standard Company

Perforation 5.5" from bottom/top

Response Card

We offer a variety of HVAC-related educational materials and technical references, as well as software tools that simplify system design/analysis and equipment selection. To receive information about any of these items, just complete this postage-paid card and drop it in the mail.

- Education materials** Air Conditioning Clinic series
 Engineered Systems Clinic series
 Trane Air Conditioning Manual
 Trane Systems Manual
- Software tools** Equipment Selection
 System design & analysis
- Periodicals** Engineers Newsletter
- Other?** _____

About me...
 Name _____
 Title _____
 Business type _____
 Phone/fax _____
 E-mail address _____
 Company _____
 Address _____

Thank you for your interest!



TRANE

The Trane Company • Worldwide Applied Systems Group
 3600 Pammel Creek Road • La Crosse, WI 54601-7599
 www.trane.com

An American-Standard Company



Refrigeration Compressors

One of the Fundamental Series

**A publication of
The Trane Company—
Worldwide Applied Systems Group**

Preface

Refrigeration Compressors

A Trane Air Conditioning Clinic

Figure 1

The Trane Company believes that it is incumbent on manufacturers to serve the industry by regularly disseminating information gathered through laboratory research, testing programs, and field experience.

The Trane Air Conditioning Clinic series is one means of knowledge sharing. It is intended to acquaint a nontechnical audience with various fundamental aspects of heating, ventilating, and air conditioning. We have taken special care to make the clinic as uncommercial and straightforward as possible.

Illustrations of Trane products only appear in cases where they help convey the message contained in the accompanying text.

This particular clinic introduces the concept of **refrigeration compressors**.

Contents

	Introduction	1
period one	Compressor Types	3
	Reciprocating Compressor	4
	Scroll Compressor	7
	Helical-Rotary (Screw) Compressor	10
	Centrifugal Compressor	13
period two	Compressor Capacity Control	18
	Cylinder Unloaders	19
	Cycling On and Off	24
	Slide Valve	26
	Inlet Vanes	27
	Variable Speed	29
period three	The Compressor in a System	30
	System-Level Control	30
	Preventing Evaporator Freeze-Up	33
period four	Review	38
	Quiz	43
	Answers	44
	Glossary	45



Introduction

notes

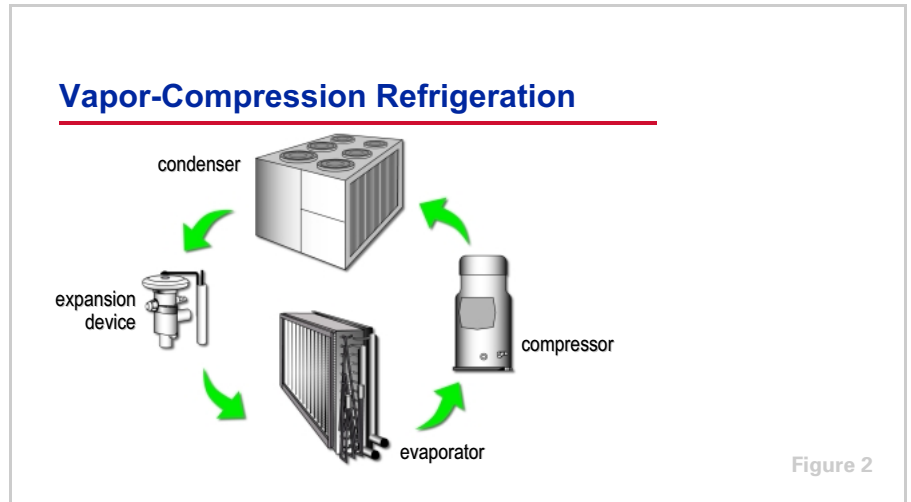

The purpose of the compressor in a refrigeration system is to raise the pressure of the refrigerant vapor from evaporator pressure to condensing pressure. It delivers the refrigerant vapor to the condenser at a pressure and temperature at which the condensing process can be readily accomplished, at the temperature of the air or other fluid used for condensing.

A review of the refrigeration cycle, using the pressure–enthalpy chart, will help to illustrate this point.

Introduction

notes

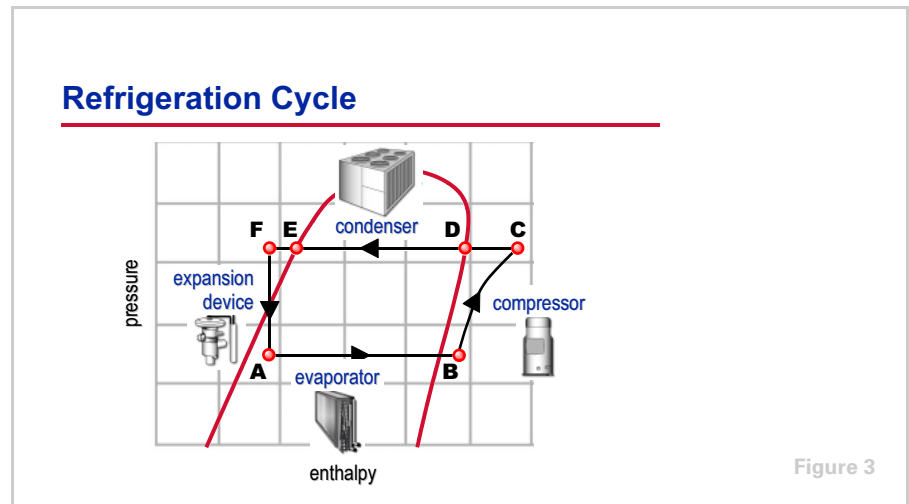

The **pressure–enthalpy (P–h) chart** plots the properties of a refrigerant: refrigerant pressure (vertical axis) versus enthalpy, or heat content (horizontal axis). A diagram of the basic vapor–compression refrigeration cycle can be superimposed on a pressure–enthalpy chart to demonstrate the function of each component in the system.

Refrigerant enters the evaporator in the form of a cool, low-pressure mixture of liquid and vapor (**A**). Heat is transferred from the relatively warm air or water to be cooled to the refrigerant, causing the liquid refrigerant to boil and in some cases superheat (**B**). The resulting vapor (**B**) is then pumped from the evaporator by the compressor, which increases the pressure and temperature of the refrigerant vapor. Notice that during the compression process (**B** to **C**), the heat content (enthalpy) of the vapor is increased. The mechanical energy used by the compressor to increase the pressure of the refrigerant vapor is converted to heat energy, called the heat of compression. This causes the temperature of the refrigerant to also rise as the pressure is increased.

The resulting hot, high-pressure refrigerant vapor (**C**) enters the condenser where heat is transferred to ambient air or water at a lower temperature. Inside the condenser, the refrigerant desuperheats (**C** to **D**), condenses into a liquid (**D** to **E**), and, in some cases, subcools (**E** to **F**). The refrigerant pressure inside the condenser is determined by the temperature of the air or water that is available as the condensing media.

This liquid refrigerant (**F**) then flows from the condenser to the expansion device. The expansion device creates a pressure drop that reduces the pressure of the refrigerant to that of the evaporator. At this low pressure, a small portion of the refrigerant boils (or flashes), cooling the remaining liquid refrigerant to the desired evaporator temperature (**A**). The cool mixture of liquid and vapor refrigerant travels to the evaporator to repeat the cycle.

period one

Compressor Types

notes

Refrigeration Compressors

period one

Compressor Types

Figure 4

This period is devoted to the discussion of the different types of compressors.

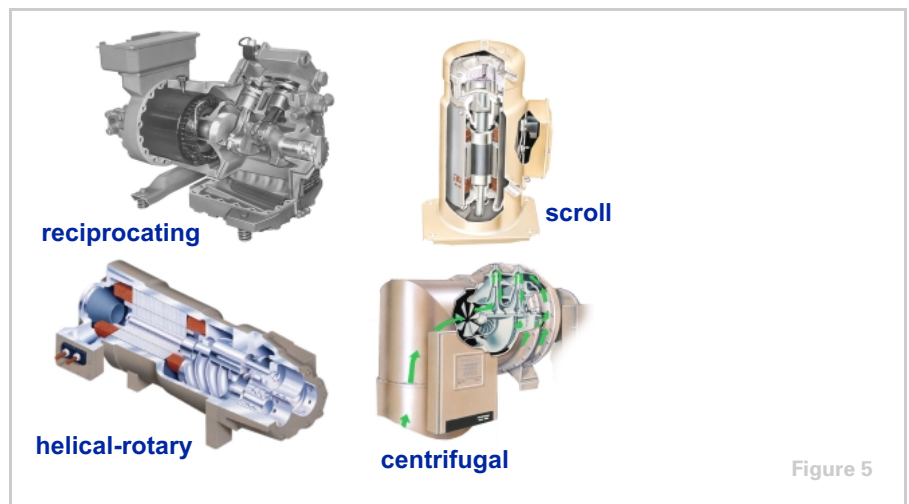

Figure 5

There are primarily four types of compressors used in the air-conditioning industry: reciprocating, scroll, helical-rotary (or screw), and centrifugal.

The traditional **reciprocating** compressor has been used in the industry for decades. It contains cylinders, pistons, rods, a crankshaft, and valves, similar to an automobile engine. Refrigerant is drawn into the cylinders on the downstroke of the piston and compressed on the upstroke.

Scroll and **helical-rotary** (or screw) compressors have become more common, replacing the reciprocating compressor in most applications due to their improved reliability and efficiency.

These three types of compressors (reciprocating, scroll, and helical-rotary) all work on the principle of trapping the refrigerant vapor and compressing it by

period one

Compressor Types

notes

gradually shrinking the volume of the refrigerant. Thus, they are called **positive-displacement** compressors.

In contrast, centrifugal compressors use the principle of **dynamic compression**, which involves converting energy from one form to another in order to increase the pressure and temperature of the refrigerant. The **centrifugal** compressor uses centrifugal force, generated by a rotating impeller, to compress the refrigerant vapor.

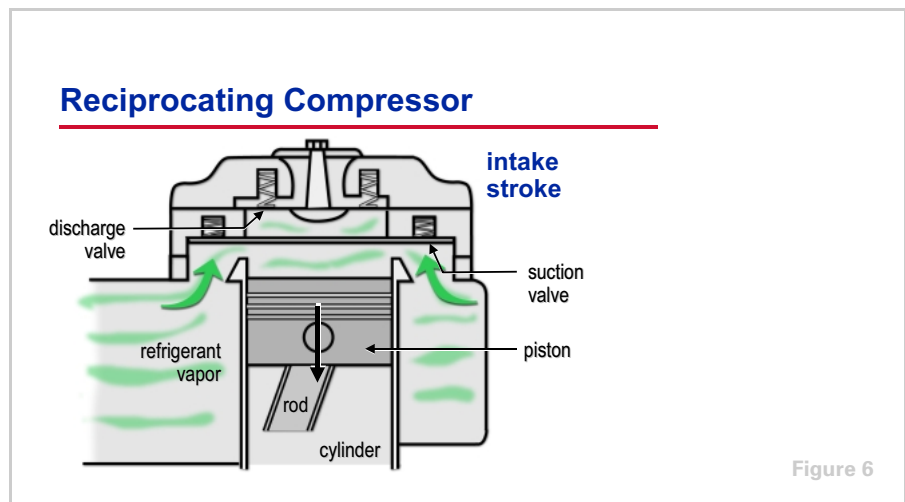

Reciprocating Compressor

The first type of compressor to be discussed is the **reciprocating compressor**. The principles of operation for all reciprocating compressors are fundamentally the same. The refrigerant vapor is compressed by a piston that is located inside a cylinder, similar to the engine in an automobile. A fine layer of oil prevents the refrigerant vapor from escaping through the mating surfaces. The piston is connected to the crankshaft by a rod. As the crankshaft rotates, it causes the piston to travel back and forth inside the cylinder. This motion is used to draw refrigerant vapor into the cylinder, compress it, and discharge it from the cylinder. A pair of valves, the suction valve and the discharge valve, are used to trap the refrigerant vapor within the cylinder during this process. In the example reciprocating compressor shown, the spring-actuated valves are O-shaped, allowing them to cover the valve openings around the outside of the cylinder while the piston travels through the middle.

During the **intake stroke** of the compressor, the piston travels away from the discharge valve and creates a vacuum effect, reducing the pressure within the cylinder to below suction pressure. Since the pressure within the cylinder is less than the pressure of the refrigerant at the suction side of the compressor, the suction valve is forced open and the refrigerant vapor is drawn into the cylinder.

period one
Compressor Types

notes

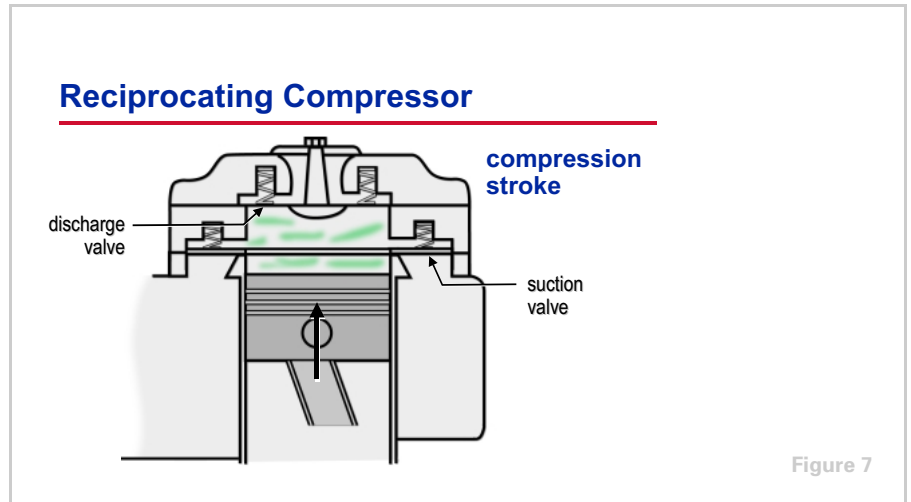

During the **compression stroke**, the piston reverses its direction and travels toward the discharge valve, compressing the refrigerant vapor and increasing the pressure within the cylinder. When the pressure inside the cylinder exceeds the suction pressure, the suction valve is forced closed, trapping the refrigerant vapor inside the cylinder.

As the piston continues to travel toward the discharge valve, the refrigerant vapor is compressed, increasing the pressure inside the cylinder.

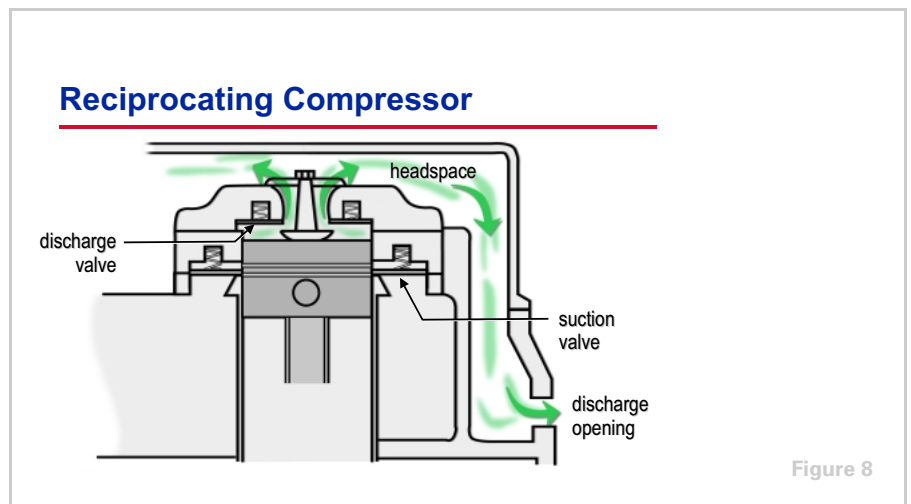

When the pressure within the cylinder exceeds the discharge (or head) pressure, the discharge valve is forced open, allowing the compressed refrigerant vapor to leave the cylinder. The compressed refrigerant travels through the headspace and leaves the compressor through the discharge opening.

period one
Compressor Types

notes

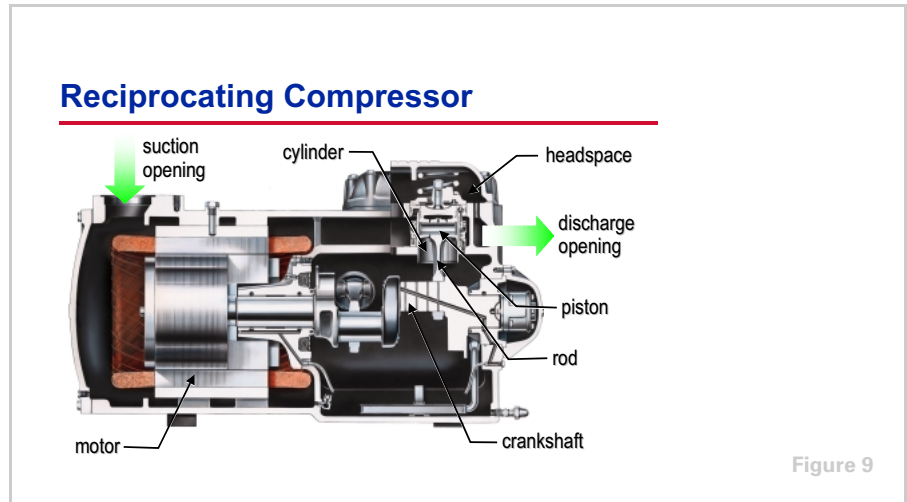

In the reciprocating compressor shown, the refrigerant vapor from the suction line enters the compressor through the suction opening. It then passes around and through the motor, cooling the motor, before it enters the cylinder to be compressed. The compressed refrigerant leaves the cylinder, travels through the headspace, and leaves the compressor through the discharge opening.

Most reciprocating compressors have multiple piston–cylinder pairs attached to a single crankshaft.

In the air-conditioning industry, reciprocating compressors were widely used in all types of refrigeration equipment. As mentioned earlier, however, scroll and helical-rotary compressors have become more common, replacing the reciprocating compressor in most of these applications because of their improved reliability and efficiency.

period one
Compressor Types

notes

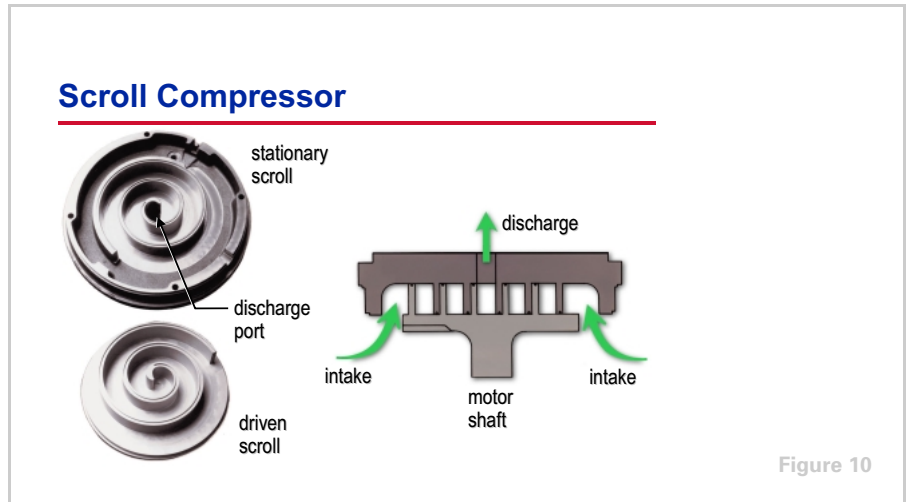

Scroll Compressor

Similar to the reciprocating compressor, the **scroll compressor** works on the principle of trapping the refrigerant vapor and compressing it by gradually shrinking the volume of the refrigerant. The scroll compressor uses two scroll configurations, mated face-to-face, to perform this compression process. The tips of the scrolls are fitted with seals that, along with a fine layer of oil, prevent the compressed refrigerant vapor from escaping through the mating surfaces.

The upper scroll, called the stationary scroll, contains a discharge port. The lower scroll, called the driven scroll, is connected to a motor by a shaft and bearing assembly. The refrigerant vapor enters through the outer edge of the scroll assembly and discharges through the port at the center of the stationary scroll.

period one
Compressor Types

notes

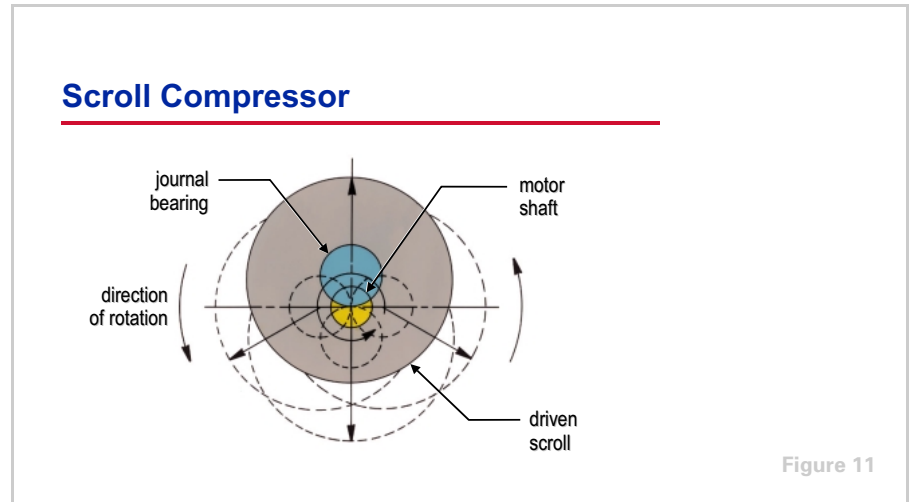

The center of the scroll journal bearing and the center of the motor shaft are offset. This offset imparts an orbiting motion to the driven scroll. Rotation of the motor shaft causes the scroll to orbit—not rotate—about the shaft center.

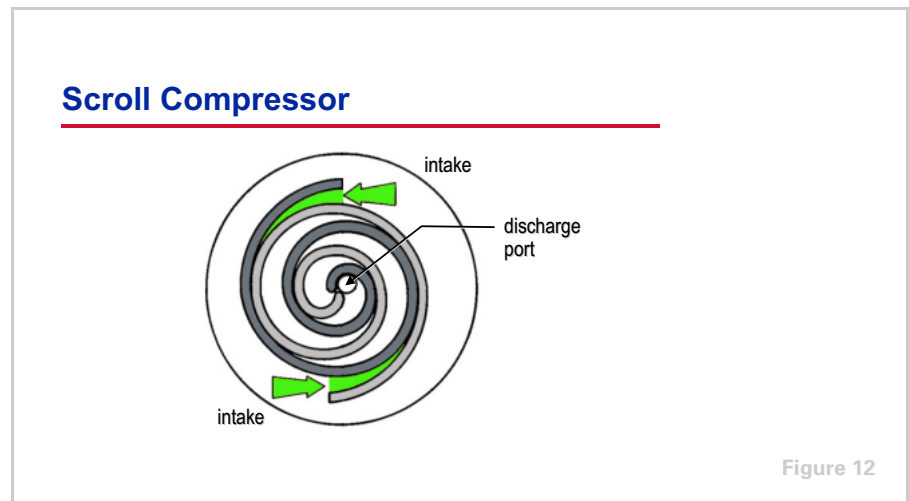

This orbiting motion causes the mated scrolls to form pockets of refrigerant vapor. As the orbiting motion continues, the relative movement between the orbiting scroll and the stationary scroll causes the pockets to move toward the discharge port at the center of the assembly, gradually decreasing the refrigerant volume and increasing the pressure.

Three revolutions of the motor shaft are required to complete the compression process.

period one

Compressor Types

notes

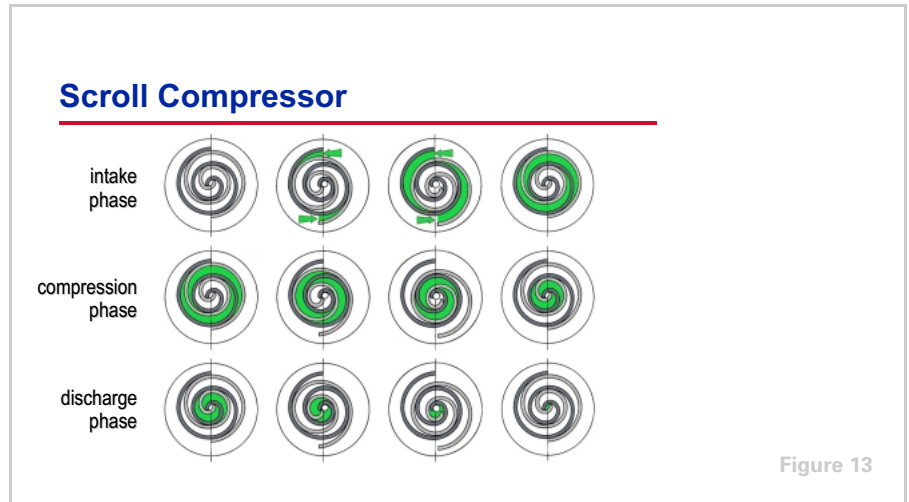

During the first full revolution of the shaft, or the **intake phase**, the edges of the scrolls separate, allowing the refrigerant vapor to enter the space between the two scrolls. By the completion of first revolution, the edges of the scrolls meet again, forming two closed pockets of refrigerant.

During the second full revolution, or the **compression phase**, the volume of each pocket is progressively reduced, increasing the pressure of the trapped refrigerant vapor. Completion of the second revolution produces near-maximum compression.

During the third full revolution, or the **discharge phase**, the interior edges of the scrolls separate, releasing the compressed refrigerant through the discharge port. At the completion of the revolution, the volume of each pocket is reduced to zero, forcing the remaining refrigerant vapor out of the scrolls.

Looking at the complete cycle, notice that these three phases—intake, compression, and discharge—occur simultaneously in an ongoing sequence. While one pair of these pockets is being formed, another pair is being compressed and a third pair is being discharged.

period one

Compressor Types

notes

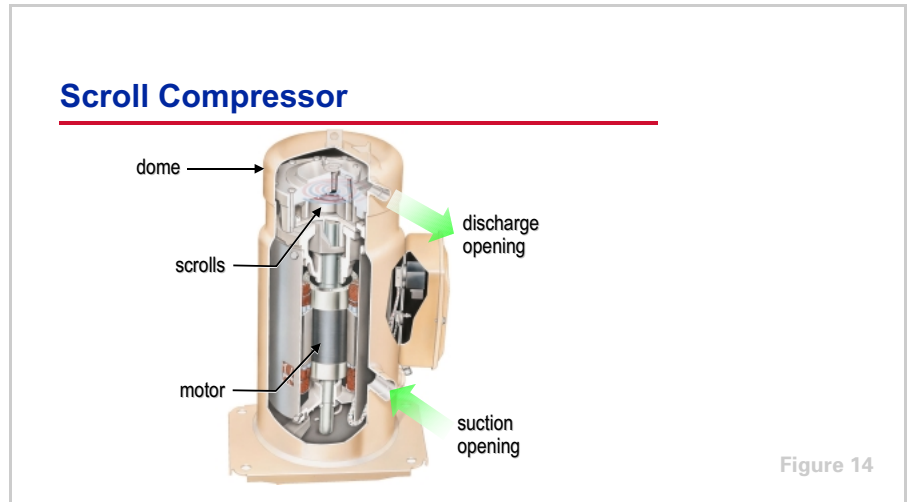

In this example scroll compressor, refrigerant vapor enters through the suction opening. The refrigerant then passes through a gap in the motor, cooling the motor, before entering the compressor housing. The refrigerant vapor is drawn into the scroll assembly where it is compressed, discharged into the dome, and finally discharged out of the compressor through the discharge opening.

In the air-conditioning industry, scroll compressors are widely used in heat pumps, rooftop units, split systems, self-contained units, and even small water chillers.

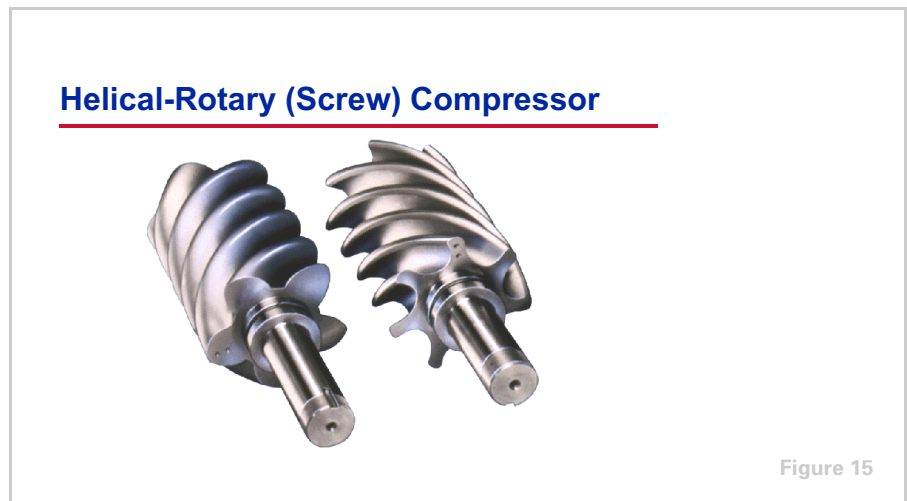

Helical-Rotary (Screw) Compressor

Similar to the scroll compressor, the **helical-rotary compressor** traps the refrigerant vapor and compresses it by gradually shrinking the volume of the refrigerant. This particular helical-rotary compressor design uses two mating screw-like **rotors** to perform the compression process.

period one
Compressor Types

notes

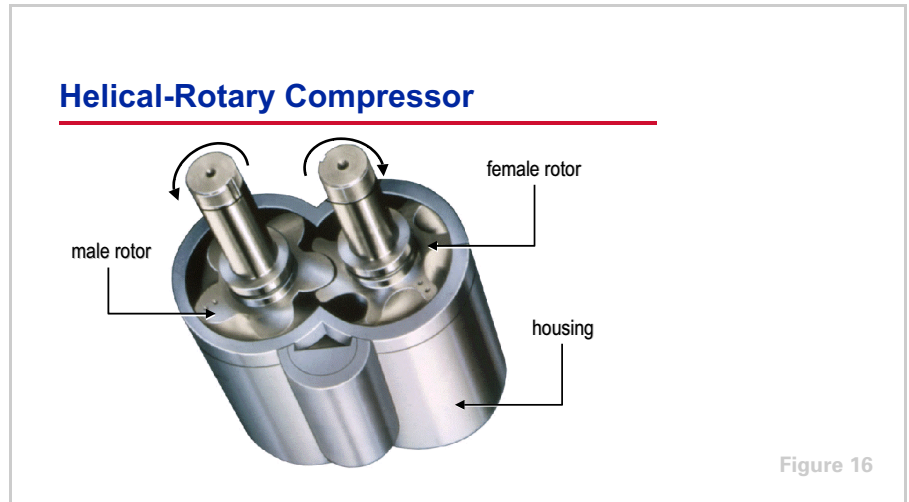

The rotors are meshed and fit, with very close tolerances, within the compressor housing. The gap between the two rotors is sealed with oil, preventing the compressed refrigerant vapor from escaping through the mating surfaces.

Only the male rotor is driven by the compressor motor. The lobes of the male rotor engage and drive the female rotor, causing the two parts to counter-rotate.

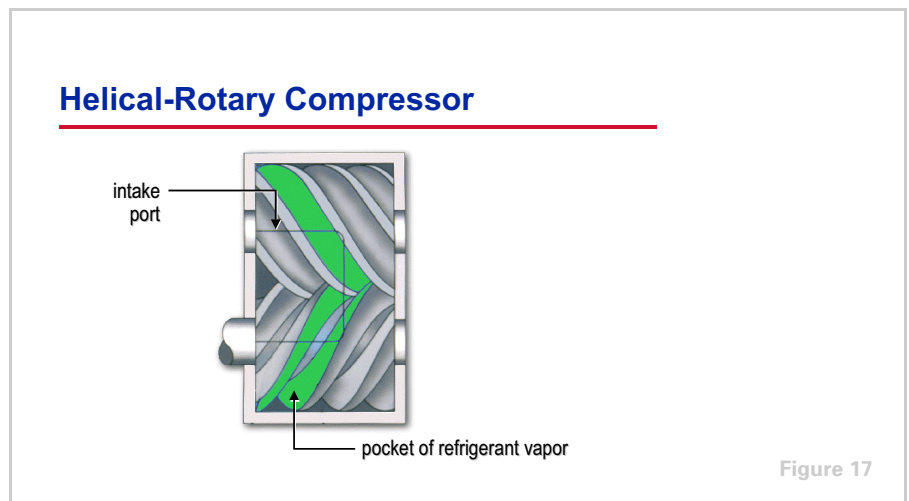

Refrigerant vapor enters the compressor housing through the **intake port** and fills the pockets formed by the lobes of the rotors. As the rotors turn, they push these pockets of refrigerant toward the discharge end of the compressor.

After the pockets of refrigerant travel past the intake port area, the vapor, still at suction pressure, is confined within the pockets by the compressor housing.

period one
Compressor Types

notes

Helical-Rotary Compressor

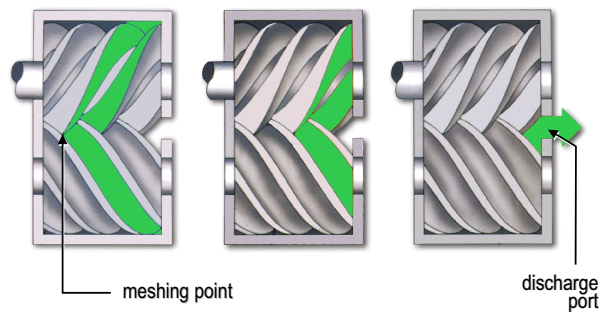

Figure 18

Viewing the compressor from the opposite side shows that continued rotation of the meshed rotor lobes drives the trapped refrigerant vapor (to the right), toward the discharge end of the compressor, ahead of the meshing point. This action progressively reduces the volume of the pockets, compressing the refrigerant.

Finally, when the pockets of refrigerant reach the **discharge port**, the compressed vapor is released and the rotors force the remaining refrigerant from the pockets.

Helical-Rotary Compressor

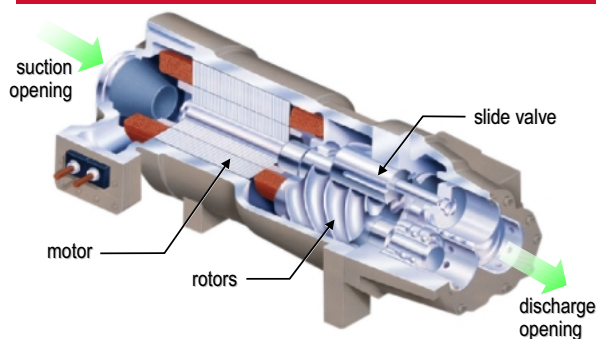

Figure 19

In this example helical-rotary compressor, refrigerant vapor is drawn into the compressor through the suction opening and passes through the motor, cooling it. The refrigerant vapor is drawn into the compressor rotors where it is compressed and discharged out of the compressor.

period one

Compressor Types

notes

In the air-conditioning industry, helical-rotary compressors are most commonly used in water chillers ranging from 70 to 450 tons [200 to 1,500 kW].

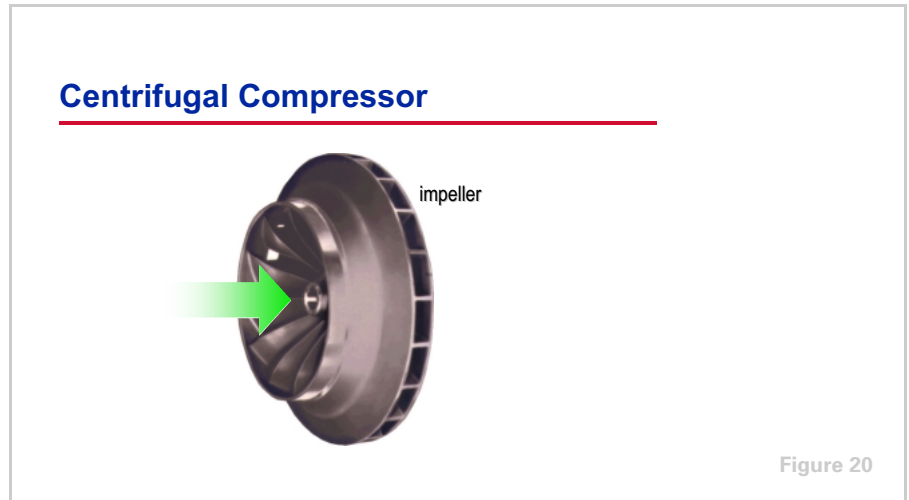

Centrifugal Compressor

The **centrifugal compressor** uses the principle of dynamic compression, which involves converting energy from one form to another, to increase the pressure and temperature of the refrigerant. It converts kinetic energy (velocity) to static energy (pressure).

The core component of a centrifugal compressor is the rotating **impeller**.

period one
Compressor Types

notes

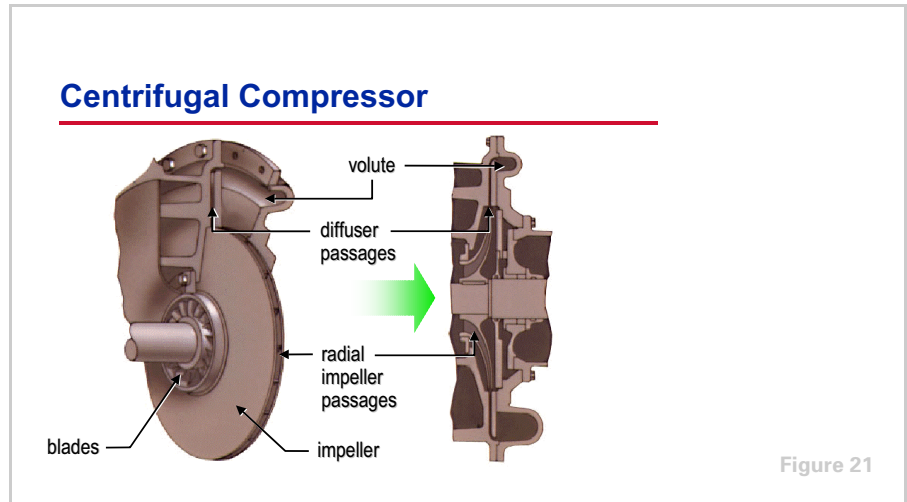

The center, or eye, of the impeller is fitted with blades that draw refrigerant vapor into **radial passages** that are internal to the impeller body. The rotation of the impeller causes the refrigerant vapor to accelerate within these passages, increasing its velocity and kinetic energy.

The accelerated refrigerant vapor leaves the impeller and enters the **diffuser passages**. These passages start out small and become larger as the refrigerant travels through them. As the size of the diffuser passage increases, the velocity, and therefore the kinetic energy, of the refrigerant decreases. The first law of thermodynamics states that energy is not destroyed—only converted from one form to another. Thus, the refrigerant's kinetic energy (velocity) is converted to static energy (or static pressure).

Refrigerant, now at a higher pressure, collects in a larger space around the perimeter of the compressor called the **volute**. The volute also becomes larger as the refrigerant travels through it. Again, as the size of the volute increases, the kinetic energy is converted to static pressure.

period one

Compressor Types

notes

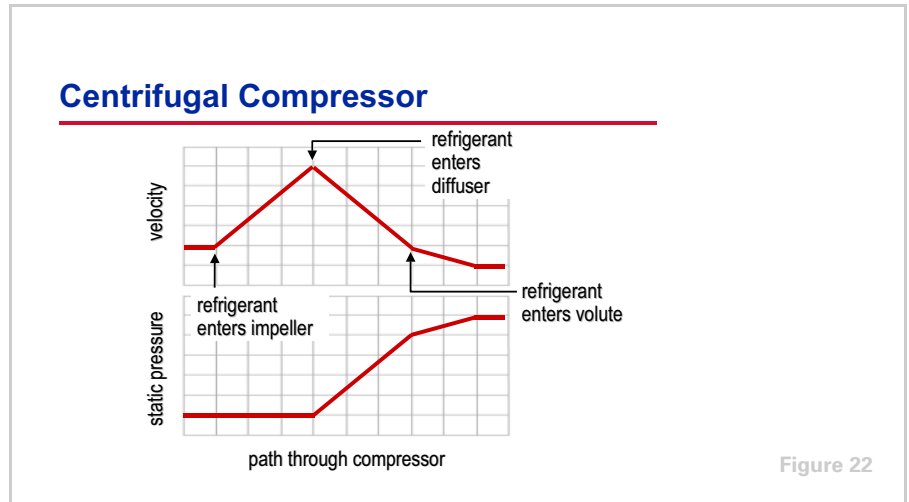

This chart plots the conversion of energy that takes place as the refrigerant passes through the centrifugal compressor. In the radial passages of the rotating impeller, the refrigerant vapor accelerates, increasing its velocity and kinetic energy. As the area increases in the diffuser passages, the velocity, and therefore the kinetic energy, of the refrigerant decreases. This reduction in kinetic energy (velocity) is offset by an increase in the refrigerant's static energy or static pressure. Finally, the high-pressure refrigerant collects in the volute around the perimeter of the compressor, where further energy conversion takes place.

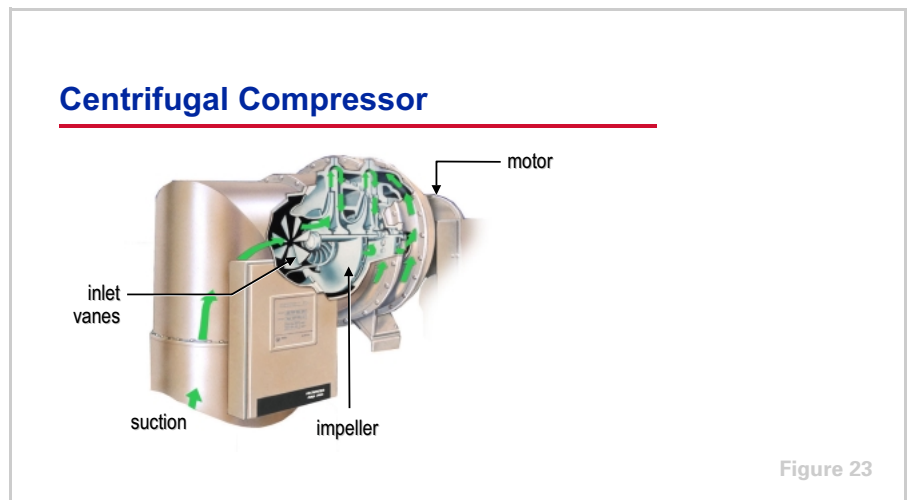

In this example centrifugal compressor, refrigerant vapor is drawn into the compressor and enters the center of impeller. This particular centrifugal compressor uses multiple impellers to perform the compression process in stages. The impellers rotate on a common shaft that is connected to the motor.

period one

Compressor Types

notes

In the air-conditioning industry, centrifugal compressors are most commonly used in prefabricated water chillers ranging from 100 to 3,000 tons [350 to 10,500 kW]. They are also used in field-assembled water chillers up to 8,500 tons [30,000 kW].

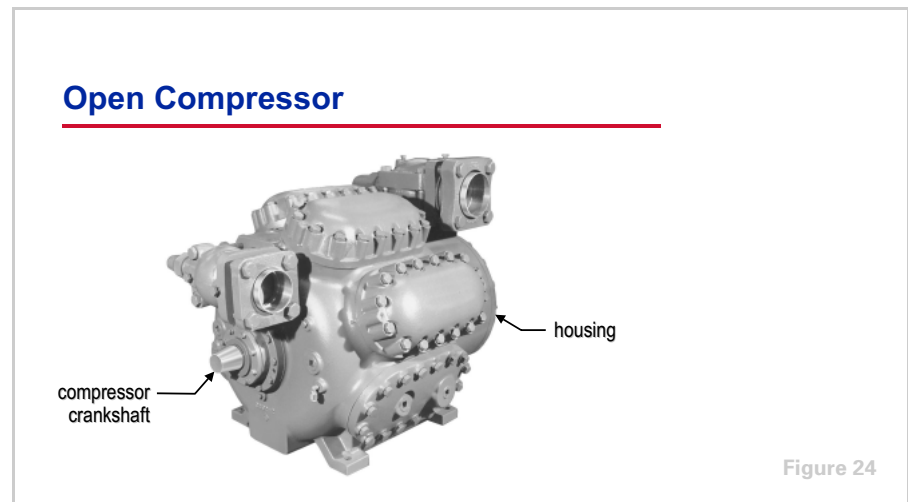

In addition to the different methods of compression, compressors can be classified as open, hermetic, and semihermetic. A reciprocating compressor will be used to explain these terms.

An **open compressor** is driven by an external power source, such as an electric motor, an engine, or a turbine. The motor is coupled to the compressor crankshaft by a flexible coupling. Since the shaft protrudes through the compressor housing, a seal is used to prevent refrigerant from leaking out of the compressor housing.

This motor is cooled by air that is drawn in from the surrounding space. The heat removed from the motor must still be rejected from the space, either by mechanical ventilation or, if the space is conditioned, by the building's cooling system.

period one

Compressor Types

notes

Hermetic Compressor

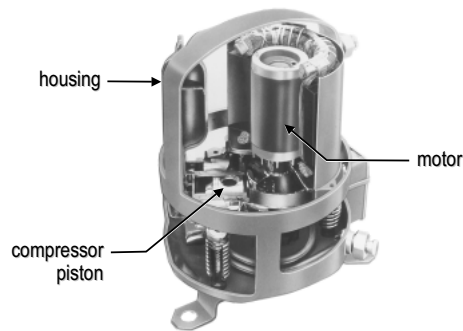

Figure 25

A **hermetic compressor**, on the other hand, seals the motor within the compressor housing. This motor is cooled by the refrigerant, either by refrigerant vapor that is being drawn into the compressor from the suction line or by liquid refrigerant that is being drawn from the liquid line. The heat from the motor is then rejected by the condenser.

Hermetic compressors eliminate the need for the shaft couplings and external shaft seals that are associated with open motors. The coupling needs precise alignment, and these seals are a prime source of oil and refrigerant leaks. On the other hand, if a motor burns out, a system with a hermetic compressor will require thorough cleaning, while a system with an open compressor will not.

Semihermetic Compressor

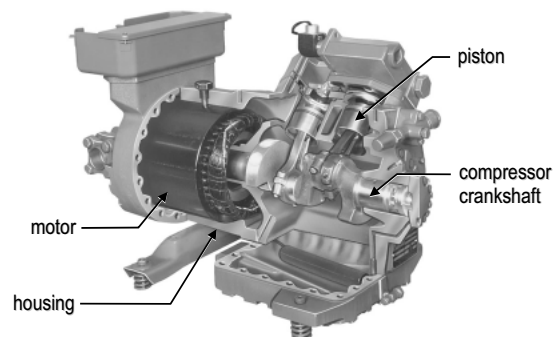

Figure 26

Similarly, the motor for a **semihermetic compressor** is also contained within the compressor housing and is cooled by the refrigerant. The term "semihermetic" means that the sealed housing is designed to be opened to repair or overhaul the compressor or motor.

period two

Compressor Capacity Control

notes

Refrigeration Compressors

period two

Compressor Capacity Control

Figure 27

The capacity of a compressor is defined by the volume of evaporated refrigerant that can be compressed within a given time period. The compressor needs a method of capacity control in order to match the ever-changing load on the system.

Methods of Compressor Unloading

▲ Reciprocating	Cylinder Unloaders
▲ Scroll	Cycle On and Off
▲ Helical-Rotary	Slide Valve
▲ Centrifugal	Inlet Vanes
	Variable Speed

Figure 28

Capacity control is commonly accomplished by unloading the compressor. The method used for unloading generally depends on the type of compressor.

Many reciprocating compressors use cylinder unloaders. Scroll compressors generally cycle on and off. Helical-rotary compressors use a slide valve or a similar unloading device. Centrifugal compressors typically use inlet vanes or a variable-speed drive in combination with inlet vanes. In addition, all four types of compressors could use variable speed to control their capacity.

period two

Compressor Capacity Control

notes

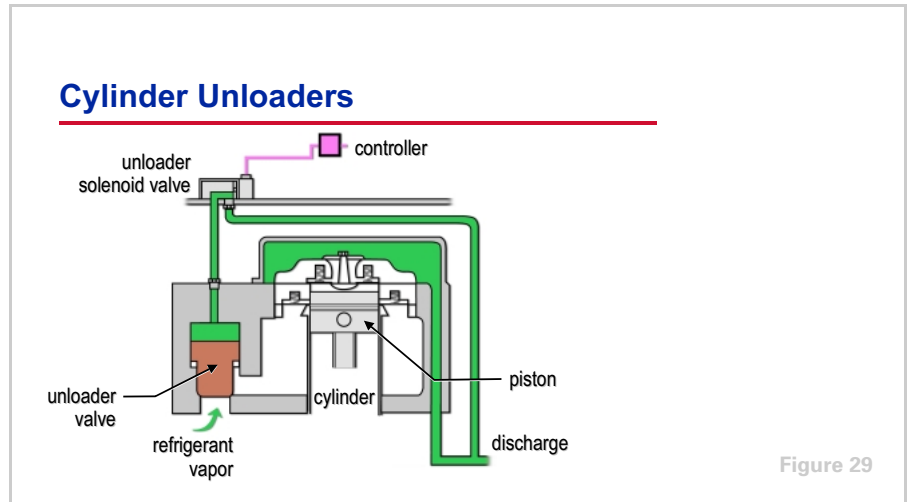

Cylinder Unloaders

Most large reciprocating compressors (above 10 tons [35 kW]) are fitted with **cylinder unloaders** that are used to match the compressor's refrigerant-pumping capacity with the falling evaporator load, by progressively deactivating piston-cylinder pairs.

The cylinder unloader shown in this example reciprocating compressor uses an electrically-actuated unloader valve to close the suction passage to the cylinder that is being unloaded.

In response to a decreasing load, an electronic controller sends a signal to open a solenoid valve. This solenoid valve diverts pressurized refrigerant vapor from the compressor discharge to the top of the unloader valve, causing the unloader valve to close and shut off the flow of refrigerant vapor into the cylinder. Even though the piston continues to travel back and forth inside this cylinder, it is no longer performing compression since it cannot take in any refrigerant vapor.

period two

Compressor Capacity Control

notes

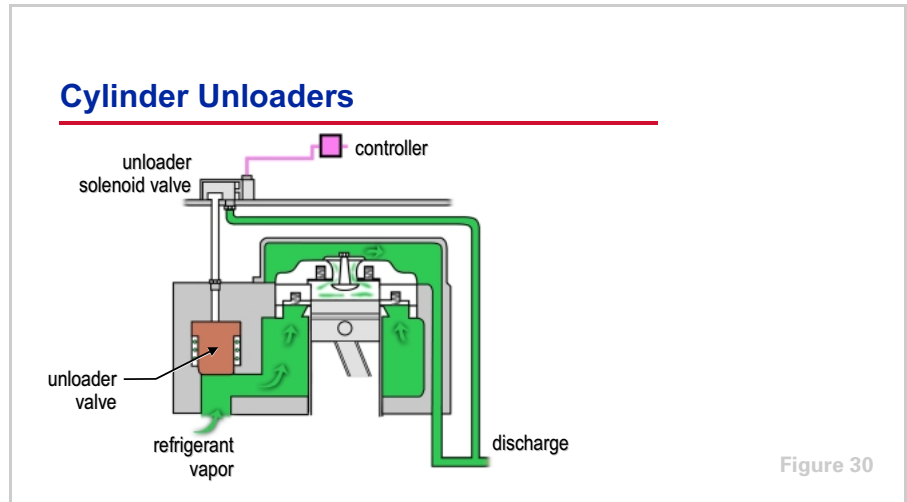

In response to an increasing load, the controller sends a signal to close the solenoid valve. This closes the port that allows the pressurized refrigerant vapor to travel to the top of the unloader valve. A controlled leakage rate around the unloader valve relieves the pressure, allowing the valve to open and refrigerant vapor to once again flow to the cylinder to be compressed.

Another type of cylinder unloader uses either pressure or electrically-actuated valving mechanisms to hold open the suction valve of the piston-cylinder pair. Since the suction valve is prevented from closing, no compression occurs in that cylinder and the discharge valve does not open. Still other types of cylinder unloaders divert the compressed refrigerant vapor back to the suction side of the compressor. In contrast to the cylinder unloaders shown, these other methods expend energy in moving refrigerant vapor during both the upward and downward piston strokes within the unloaded cylinders.

period two

Compressor Capacity Control

notes

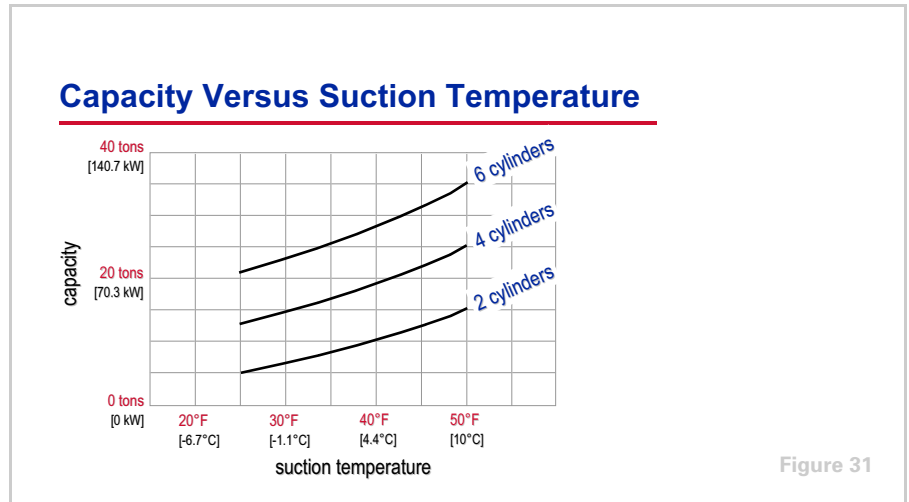

A plot of compressor capacity versus suction temperature (assuming a constant condensing temperature) reveals that the capacity of the compressor increases as the suction temperature increases. As the suction temperature, and, therefore, the suction pressure, increases, the refrigerant vapor becomes denser. A greater quantity of refrigerant can be compressed in a given compression cycle and the capacity of the compressor is higher.

For an example nominal-30-ton [105 kW] reciprocating compressor that has six cylinders, Figure 31 shows the capacity produced by the various stages of unloading. Four of the six cylinders are equipped with unloaders, and two cylinders are unloaded as a pair. The compressor, therefore, can operate with all six cylinders loaded, with four cylinders loaded, with only two cylinders loaded, or it can shut off. Again, these capacity curves assume the compressor is operating at a constant condensing (discharge) pressure.

period two

Compressor Capacity Control

notes

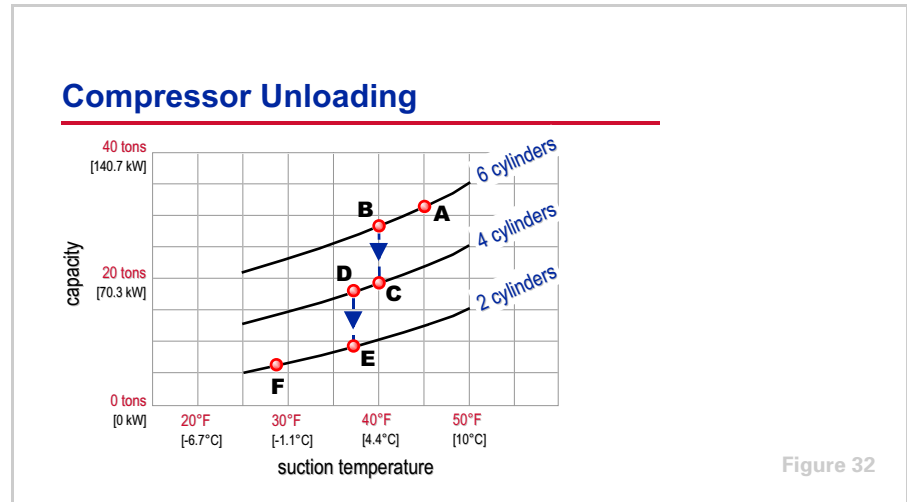

At design conditions, the capacities of the evaporator coil and compressor balance (**A**) at a suction temperature of 45°F [7.2°C] and a capacity of 31 tons [109 kW]. As the cooling load decreases below this balance point, assuming a constant condensing pressure, the compressor pumping capacity decreases with the falling suction temperature along the six-cylinder curve until it reaches **B**. Here, the compressor unloads the first set of two cylinders.

When the first set of two cylinders is unloaded, the compressor operates with only four active cylinders and the compressor capacity falls immediately to 19 tons [66.8 kW] along the four-cylinder curve (**C**). As the load continues to decrease, the capacity and suction temperature follow the four-cylinder curve until it reaches **D**. Here, the second set of two cylinders is unloaded, decreasing the compressor capacity to 9.5 tons [33.4 kW] along the two-cylinder curve (**E**).

As the load continues to decrease, the suction temperature reaches the minimum set point, 28°F [-2.2°C] in this example (**F**), and the two remaining cylinders are deactivated by shutting off the compressor. The minimum capacity of the compressor in this example is 7 tons [24.6 kW].

This illustrates how cylinder unloading extends the stable part-load range of a reciprocating compressor. The example compressor is able to perform over 77% of its capacity range (31 tons to 7 tons [109 kW to 24.6 kW]). An increasing load reverses the sequence.

period two

Compressor Capacity Control

notes

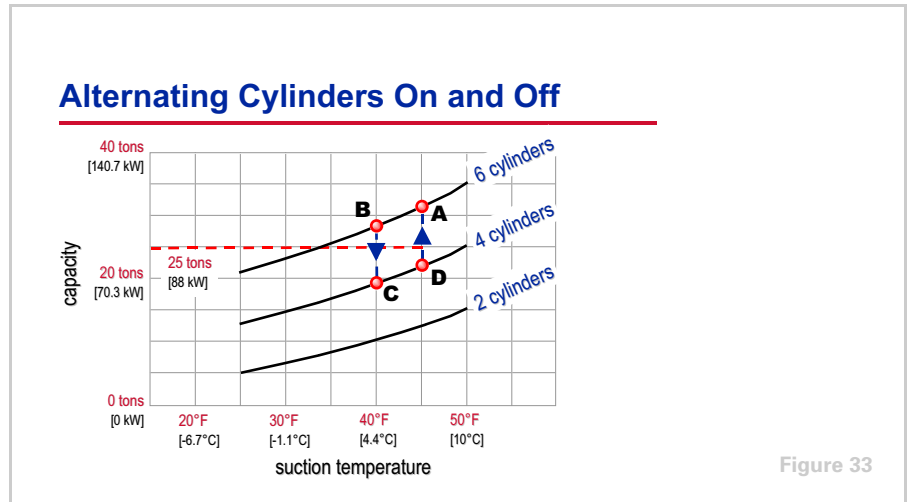

In the case of comfort-cooling applications, however, the load generally changes slowly in small intervals. For example, assume that the load decreases from 28 tons [98.5 kW] (**B**) to 25 tons [88 kW]. In response to the decreasing load, the compressor unloads to **C** on the four-cylinder capacity curve where it has a pumping capacity equivalent to 19 tons [66.8 kW]. The 25-ton [88-kW] evaporator load causes the suction temperature to rise and the capacity of the compressor increases toward **D**. When the load reaches **D** the compressor reloads the first set of two cylinders and the compressor capacity jumps to 31 tons [109 kW]. Because, at this point, the available compressor capacity exceeds the evaporator load, the suction temperature decreases toward **B** where the compressor is again unloaded to **C**.

From this example, it becomes obvious that the compressor and evaporator cannot reach a balance point while the evaporator load remains between these stages of compressor loading. This example compressor can produce a pumping capacity of 28 tons [98.5 kW] (**B**) with six cylinders loaded or 22 tons [77.4 kW] (**D**) with four cylinders loaded. It cannot exactly match the 25-ton [88-kW] evaporator load. As long as the evaporator load remains between the capacities produced by four and six cylinders, the compressor will alternate between the two stages of loading in an effort to produce an “average” capacity of 25 tons [88 kW].

Alternating between these stages of loading does not harm the reciprocating compressor. The only time it should be avoided is when the compressor must cycle between off and on to balance a load that is less than the minimum stage of compressor loading. Excessive starting and stopping of large reciprocating compressor motors is generally discouraged due to the mechanical wear on a motor of that size.

period two

Compressor Capacity Control

notes

Cycling On and Off

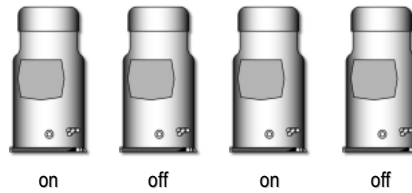

Figure 34

Cycling On and Off

Scroll compressors do not have valves or unloaders. A piece of equipment that uses scroll compressors generally unloads by using multiple compressors and turning them on and off, as needed, to satisfy the evaporator load.

Cycling Scroll Compressors

step	reciprocating		scroll	
	# of cylinders active	nominal capacity	# of compressors active	nominal capacity
1	2	10 tons [35 kW]	1	10 tons [35 kW]
2	4	20 tons [70 kW]	2	20 tons [70 kW]
3	6	30 tons [105 kW]	3	30 tons [105 kW]
4	8	40 tons [140 kW]	4	40 tons [140 kW]

Figure 35

Cycling multiple scroll compressors is very similar to the use of cylinder unloaders on a single reciprocating compressor. As an example, a large 40-ton [140.6-kW] reciprocating compressor may have eight cylinders with unloaders on six of them, allowing it to unload in equal steps of 10 tons [35.2 kW] each, with a minimum nominal capacity of 10 tons [35.2 kW].

A similar 40-ton [140.6-kW] unit using scroll compressors would include four separate 10-ton [35.2-kW] scroll compressors. Just as the reciprocating compressor unloads in equal intervals by unloading a pair of cylinders, the scroll compressor unit unloads in the same 10-ton [35.2-kW] intervals by shutting off individual compressors.

period two

Compressor Capacity Control

notes

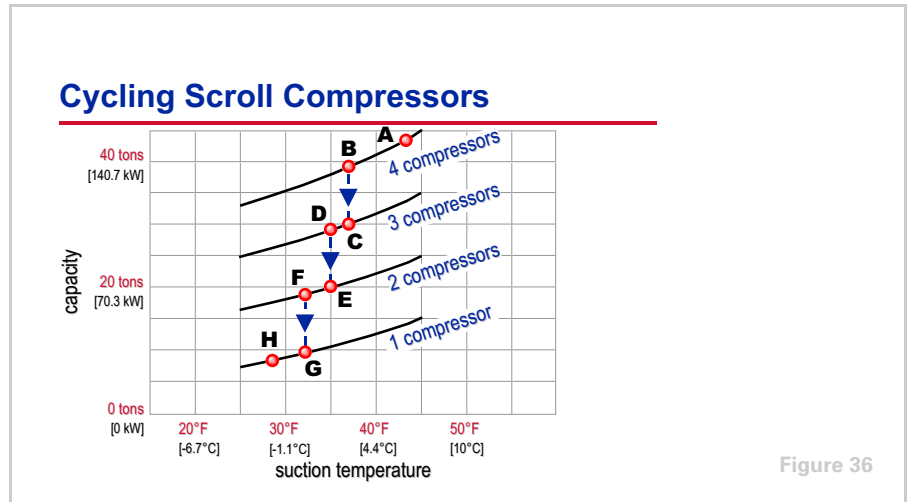

At design conditions, the capacities of the evaporator and this four-compressor unit balance at a suction temperature of 43°F [6.1°C] and a capacity of 44 tons [154.7 kW] (**A**). As the cooling load decreases below this balance point, assuming a constant condensing pressure, the capacity of the unit decreases with the falling suction temperature along the four-compressor curve until it reaches **B**. Here, the first scroll compressor is shut off and the capacity of the unit decreases immediately to 30 tons [105.5 kW] (**C**) along the three-compressor curve.

As the load continues to decrease, the individual compressors shut off in a similar manner until the suction temperature reaches a minimum set point and the final compressor is shut off. The minimum capacity of the four-compressor unit in this example is 8 tons [28.1 kW].

Excessive starting and stopping of scroll compressors is not a concern. The reciprocating compressor system on Figure 35 includes a single large compressor with a single large motor. In contrast, the scroll compressor system has four small compressors, each with its own small motor. These small motors are designed to cycle, just like those used with small reciprocating compressors.

period two

Compressor Capacity Control

notes

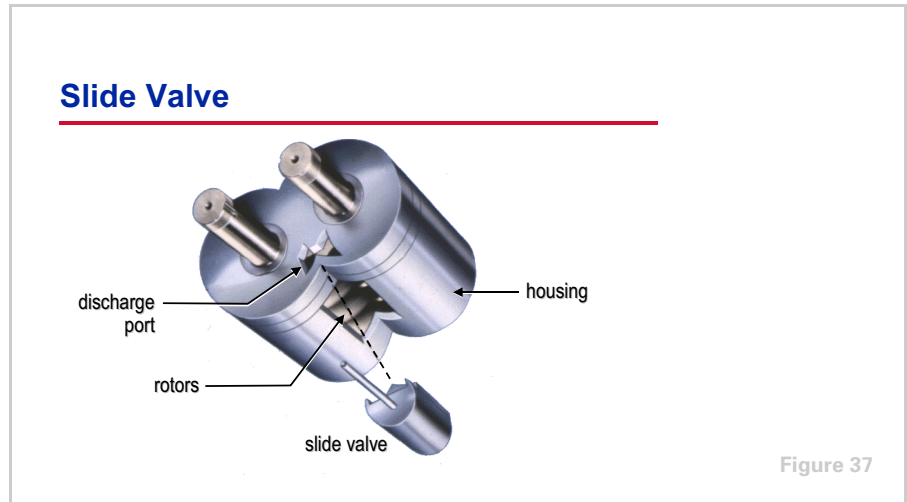

Slide Valve

The helical-rotary compressor used as the example in this clinic is unloaded using a **slide valve** that is an integral part of the compressor housing. Other helical-rotary compressor designs may use a variety of methods to vary capacity. Some of these methods are similar in function to the slide valve presented in this clinic. One major determining factor is whether the compressor is designed to unload in steps, like a reciprocating compressor, or if it has variable unloading.

The position of the slide valve along the rotors controls the volume of refrigerant vapor delivered by the compressor, by varying the amount of rotor length actually used for compression. By changing the position of the slide valve, the compressor is able to unload to exactly match the evaporator load, instead of unloading in steps like the reciprocating compressor discussed earlier.

period two

Compressor Capacity Control

notes

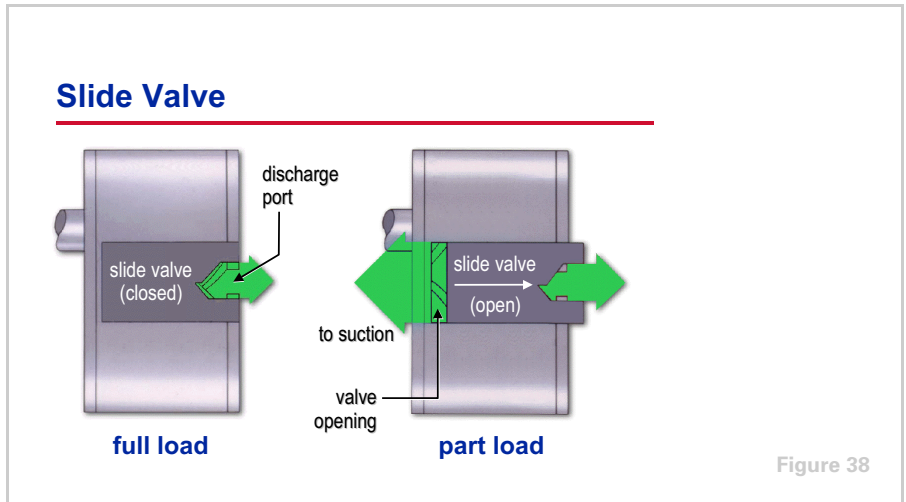

At full load, the slide valve is closed. The compressor pumps its maximum volume of refrigerant, discharging it through the discharge port.

As the load on the compressor decreases, the slide valve modulates toward the open position. The opening created by the valve movement allows refrigerant vapor to bypass from the rotor pockets back to the suction side of the compressor. This reduces the volume of vapor available for the compression process. It also reduces the amount of rotor length available for compression. In this manner, the volume of refrigerant that is pumped by the compressor is varied, unloading it to balance the existing load.

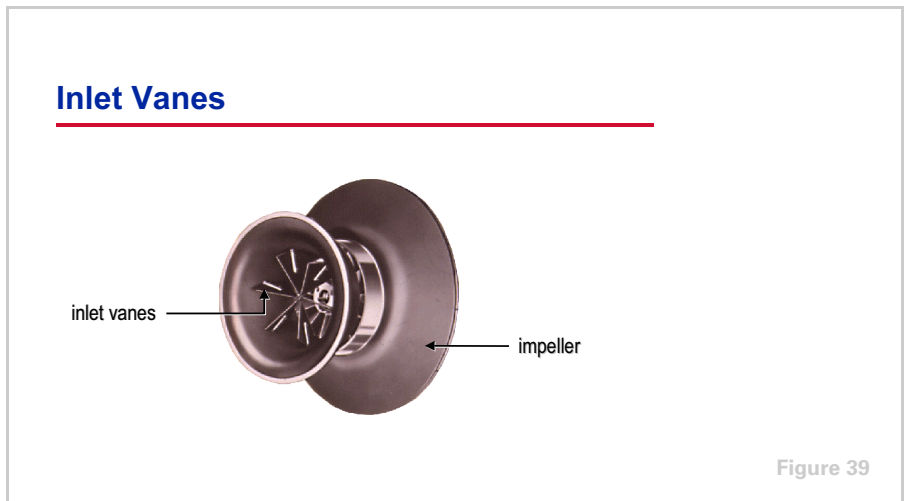

Inlet Vanes

A common method of modulating the capacity of a centrifugal compressor is to use a set of vanes installed at the inlet of the compressor impeller. While a survey of other centrifugal compressor designs shows that there are other

period two

Compressor Capacity Control

notes

methods of capacity control, many of them function in a manner similar to the inlet vanes presented in this section of the clinic.

Inlet vanes “preswirl” the refrigerant before it enters the impeller. By changing the refrigerant’s angle of entry, these vanes lessen the ability of the impeller to take in the refrigerant. As a result, the compressor’s refrigerant-pumping capacity decreases to balance with the evaporator load.

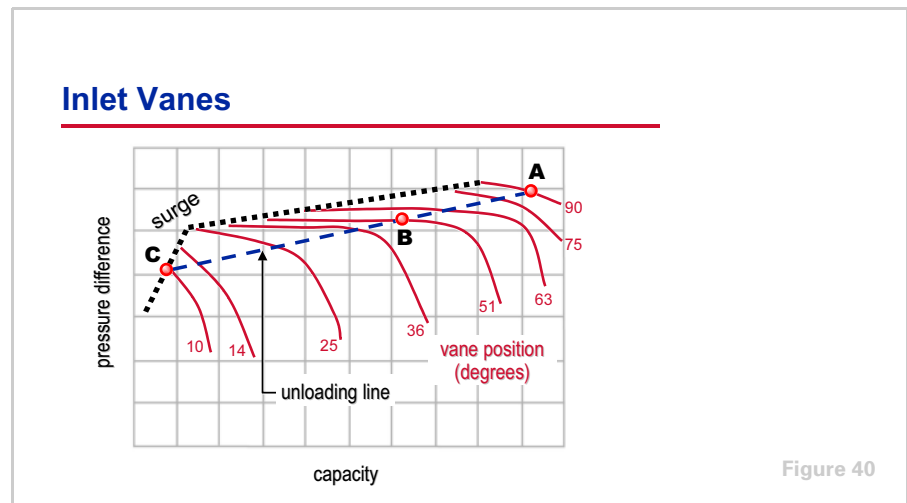

These curves represent the performance of a typical centrifugal compressor over a range of inlet vane positions. The pressure difference between the compressor inlet (evaporator) and outlet (condenser) is on the vertical axis and compressor capacity is on the horizontal axis. The surge region represents the conditions that cause unstable compressor operation.

As the load on the compressor decreases from the full-load operating point (**A**), the inlet vanes partially close, reducing the flow rate of refrigerant vapor and balancing the compressor capacity with the new load (**B**).

Less refrigerant, and therefore less heat, are transferred to the condenser. Since the available heat rejection capacity of the condenser is now greater than required, the refrigerant condenses at a lower temperature and pressure. This reduces the pressure difference between the evaporator and the condenser. Continuing along the unloading line, the compressor remains within its stable operating range until it reaches **C**.

Inlet vanes on a centrifugal compressor allow it to unload over a broad capacity range while preventing the compressor from operating in the surge region.

period two

Compressor Capacity Control

notes

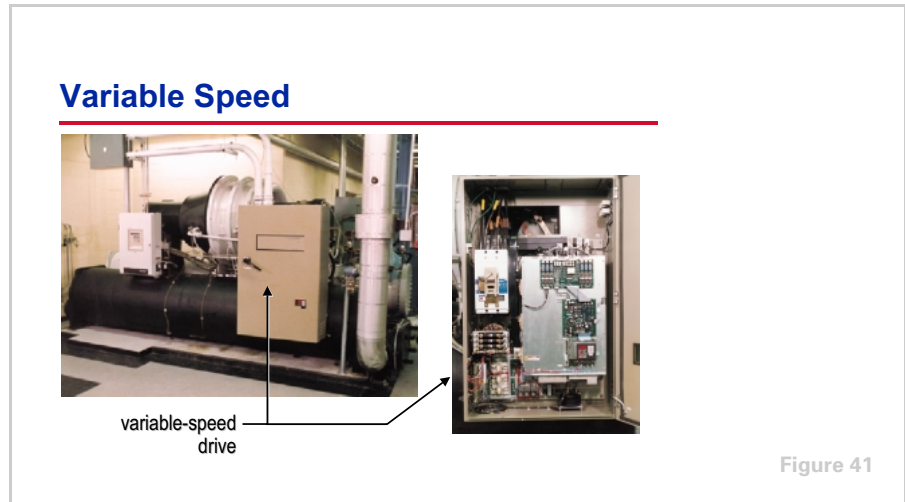

Variable Speed

Alternatively, the capacity of a compressor can be controlled by varying the rotational speed of the compressor motor. This is accomplished using a device called an **adjustable-frequency drive (AFD)** or **variable-speed drive**.

On a reciprocating compressor, this would vary the speed at which the crankshaft rotates, thus controlling the rate at which the piston travels back and forth inside the cylinder. On a scroll compressor, this would vary the speed at which the driven scroll rotates. If applied to a helical-rotary compressor, this would vary the speed at which the rotors rotate. Applied to a centrifugal compressor, this would vary the speed at which the impeller rotates.

Although variable-speed capacity control could be applied to all four types of compressors discussed in this clinic, it is most often applied to centrifugal compressors. Because speed variation reduces both the flow rate of refrigerant through the compressor and the pressure differential created by the compressor, it is used in conjunction with inlet vanes. This requires fairly complex control strategies to balance refrigerant flow rate, pressure differential, and load.

period three

The Compressor in a System

notes

Refrigeration Compressors

period three

The Compressor in a System

Figure 42

Period Two presented several methods used to control the capacity of a compressor. This next section considers the entire system in order to determine how the capacity of the compressor is controlled to maintain desired space conditions.

System-Level Control

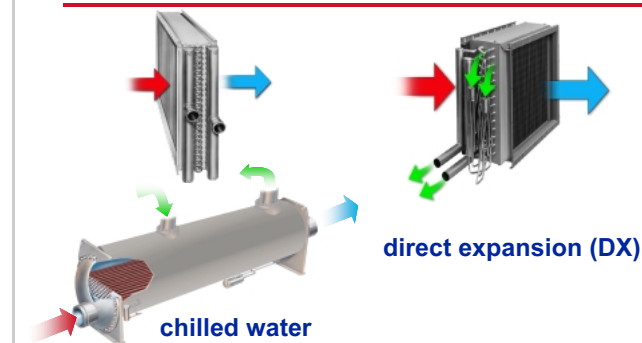

Figure 43

System-Level Control

The method of controlling compressor capacity to maintain desired space conditions depends on 1) whether the system is a chilled-water or a direct-expansion system, and 2) how the airside system responds to changes in space loads.

Generally, in air-conditioning applications, compressors will be applied in either a chilled-water or a direct-expansion (DX) system. A **chilled-water system** uses water as the cooling media. The refrigerant inside the evaporator absorbs heat from the water, and this water is pumped to coils in order to absorb heat

period three

The Compressor in a System

notes

from the air used for space conditioning. In contrast, the refrigerant inside the evaporator of a **direct-expansion (DX) system** absorbs heat directly from the air used for space conditioning.

The airside system responds to changing space loads by varying either the temperature or the quantity of air delivered to the conditioned space. A **constant-volume system** provides a constant quantity of variable-temperature air to maintain the desired conditions in a space. A **variable-air-volume (VAV) system**, however, maintains the desired space conditions by varying the quantity of constant-temperature air.

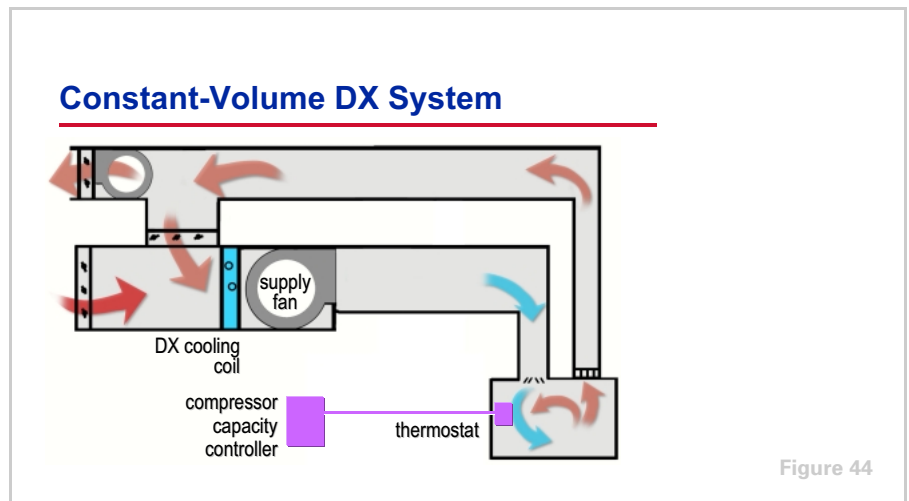

Again, a constant-volume system supplies the same quantity of air to the space and varies the temperature of this air to respond to changing loads.

In this example single-zone, constant-volume DX system, in order to respond to changing space loads, the capacity of the compressor is controlled by directly sensing space temperature. The compressor is loaded or unloaded based on how close the actual space temperature is to the set point temperature.

Loading and unloading the compressor results in a temperature change of the air leaving the evaporator coil.

period three

The Compressor in a System

notes

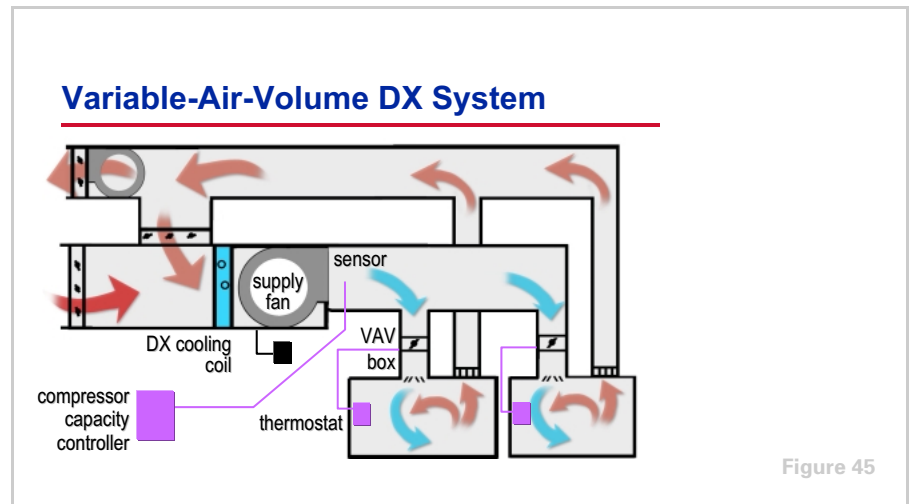

As mentioned previously, a VAV system varies the quantity of air supplied to the space in order to satisfy the load. The supply temperature is held constant in this system.

In a VAV DX system, the capacity of the compressor is controlled by sensing the temperature of the air being supplied to the system. The compressor is loaded or unloaded based on how close the actual supply air temperature is to the set point.

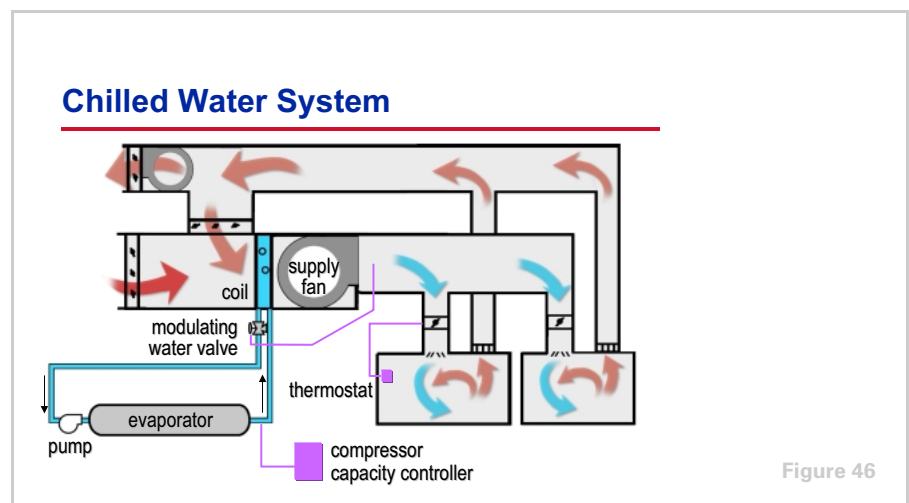

In contrast to the DX system examples shown previously, a chilled-water system responds to changing space loads by controlling the capacity of the chilled-water cooling coil. Although there are various methods of controlling the capacity of this coil, this discussion will assume the use of a modulating water valve.

period three

The Compressor in a System

notes

In a VAV chilled water system (shown in Figure 46), the capacity of the chilled-water coil is controlled to maintain the desired supply air temperature. By sensing the supply air temperature, a controller varies the flow of water through the coil by modulating the valve. Varying the water flow maintains the temperature of the air as the flow rate of the air changes to match the space load.

In a constant-volume chilled-water system, the capacity of the chilled-water coil is controlled by directly sensing space temperature and varying the flow of water through the coil by modulating the valve. Varying the water flow changes the temperature of the air leaving the coil to match the space load.

In either case, the capacity of the compressor is generally controlled by sensing the temperature of the water leaving the evaporator and comparing it to the set point.

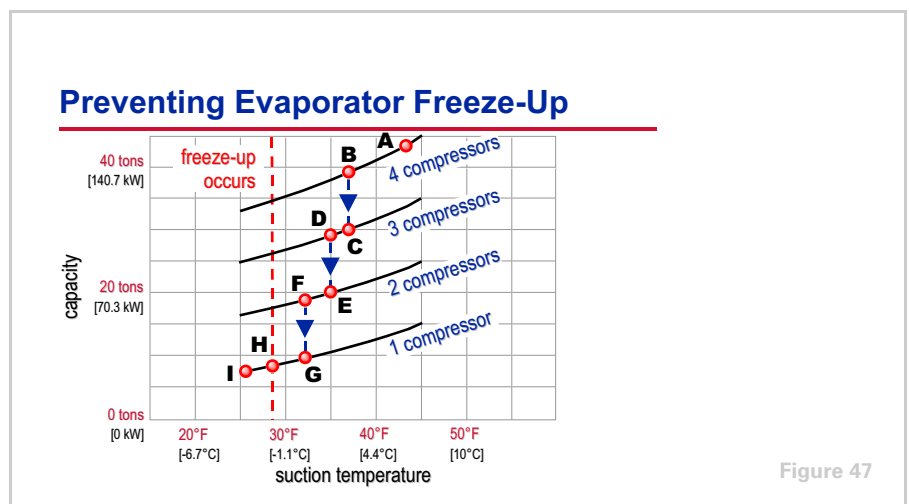

Preventing Evaporator Freeze-Up

In addition to unloading the compressor in order to match the ever-changing system load, a second system-related concern involves maintaining the suction temperature above the conditions where evaporator freeze-up may occur. This can be illustrated by returning to an earlier example. Assume that, in response to a decreasing load, the capacity of the 40-ton [105.5-kW] scroll-compressor unit is progressively reduced to a minimum of 8 tons [28.1 kW], corresponding to a suction temperature of 28°F [-2.2°C] (H). If the load on the evaporator decreases no further, the suction temperature is maintained within safe operating limits. However, if the system must be operated at loads below this minimum stage of unloading, the suction temperature may fall to the point (I) where evaporator freeze-up can occur.

In a direct-expansion (DX) application, where the refrigerant in the evaporator is cooling air, a suction temperature of approximately 28°F [-2.2°C] can cause the moisture that condenses out of the air to form frost on the surface of the evaporator coil. In a chilled-water application, where the refrigerant in the evaporator is cooling water, a suction temperature of approximately 30°F [-1.1°C] can cause the water to freeze inside the evaporator. (This minimum

period three

The Compressor in a System

notes

suction temperature for a specific application depends on the system operating conditions and the evaporator design.)

Evaporator freeze protection in a chilled-water application is accomplished by sensing the temperature of the water in the evaporator. If the water approaches 32°F [0°C], the compressor is shut off to protect the evaporator from freezing. Most chilled water-equipment includes this protection as part of the controls for the equipment.

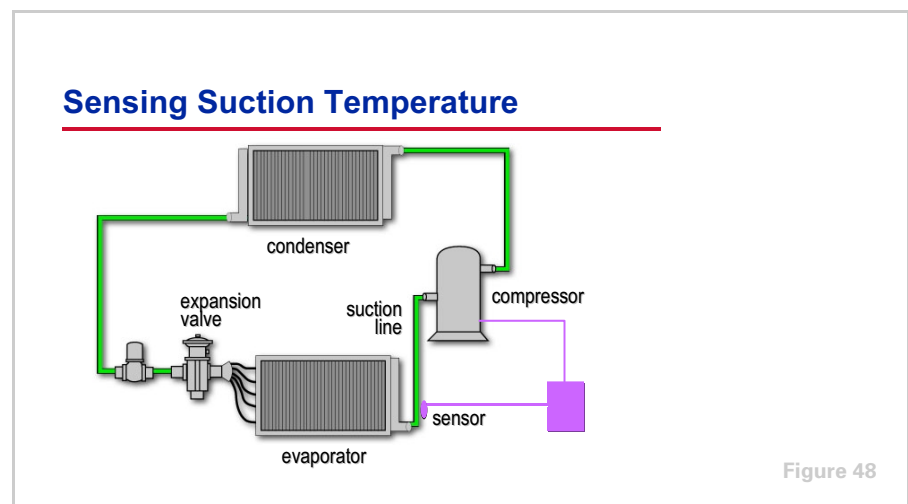

In a direct-expansion (DX) application, where the refrigerant in the evaporator is cooling air, frost protection can be accomplished in a number of ways. As mentioned, if the surface temperature of the coil gets too cold, the moisture that condenses out of the air can form frost on the surface of the coil. This “coil frosting” is detrimental to system performance and compressor reliability.

Historically, in DX air-conditioning applications, hot gas bypass, coil pressure regulators, and defrost cycles initiated by a timer, pressure sensor, or temperature sensor are a few of the methods that have been used to prevent evaporator frosting. This clinic will focus on two of these—a defrost cycle initiated by a temperature sensor and hot gas bypass.

A temperature sensor on the suction line leaving the evaporator is used to determine if the coil reaches a frosting condition. Compressors are turned off and the supply fan continues to run to de-ice the coil. Timers prevent the compressors from rapid cycling.

This control scheme (referred to by Trane as FROSTAT™) is especially well suited for equipment using scroll compressors, which are designed to start and stop much more often than large reciprocating compressors.

period three

The Compressor in a System

notes

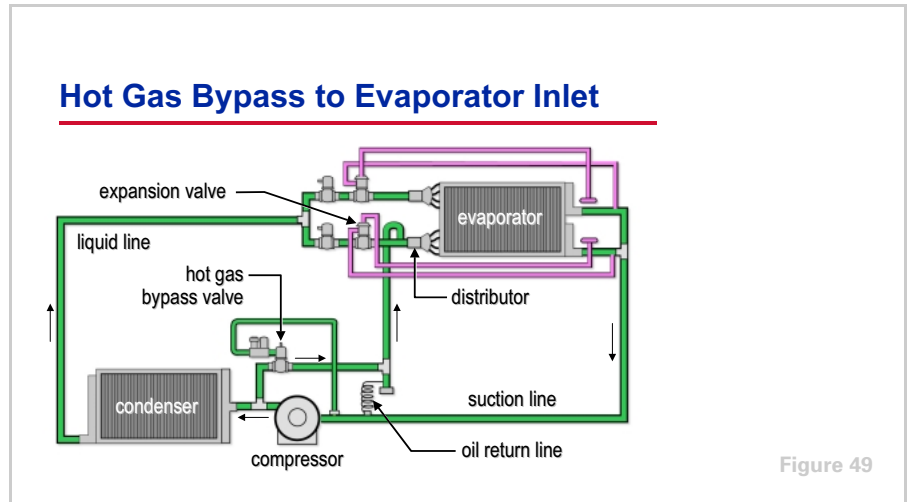

Hot gas bypass may be another solution for preventing evaporator frosting in DX applications. Hot gas bypass diverts hot, high-pressure refrigerant vapor from the discharge line to the low-pressure side of the refrigeration system. This added “false load” helps to maintain an acceptable suction pressure and temperature. Hot gas bypass, however, fails to reduce energy consumption because it does not allow the compressor to shut off at these low load conditions.

In a DX application, there are two bypass methods used. The first method bypasses refrigerant vapor from the compressor discharge line to the inlet of the evaporator coil. Sensing a decrease in suction pressure, a pressure-actuated valve opens to bypass hot refrigerant vapor from the compressor discharge line to the inlet of the evaporator coil, between the expansion valve and the liquid distributor. This increases the rate at which liquid refrigerant is boiled off within the evaporator coil and causes the temperature of the refrigerant leaving the coil to rise. Sensing this increased temperature, the expansion valve feeds additional refrigerant to the coil, increasing the suction pressure and temperature.

The principal advantage of hot gas bypass to the evaporator inlet is that the refrigerant velocity in the evaporator and suction line is higher at low loads. This promotes a uniform movement of oil through the evaporator coil and suction piping. When the evaporator is located above the compressor, as shown, the holdup of oil within the vertical hot-gas-bypass riser must be considered. Since the flow rate within the hot-gas-bypass line modulates over a wide range, no size of pipe can ensure adequate velocity to carry oil up the riser. Oil *will* collect at the base of the vertical riser when the bypass valve throttles to lower flow rates. This problem is commonly addressed by adding a small oil return line between the base of the riser and the suction line.

period three

The Compressor in a System

notes

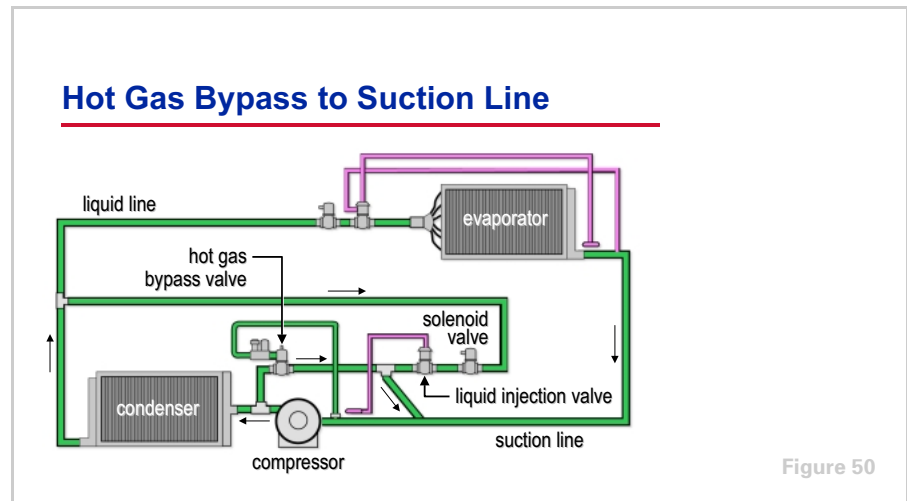

The second method bypasses refrigerant vapor from the compressor discharge line to the suction line. This method requires the service of an additional expansion valve, called a liquid injection valve. The remote bulb of this valve is attached to the suction line near the compressor. When reduced suction pressure causes the bypass valve to open, the expansion valve senses the resulting rise in suction temperature (superheat) at its remote bulb. A rising suction temperature causes this expansion valve to open, mixing liquid refrigerant with the hot, bypassed refrigerant vapor. The heat content of this refrigerant vapor causes the liquid refrigerant to evaporate, thus cooling the mixture. This increase in the refrigerant flow rate stabilizes the compressor suction pressure (temperature).

The principal advantage of hot gas bypass to the suction line is that the amount of refrigerant piping is generally less than the other method. A key disadvantage is that the refrigerant velocity in the evaporator and suction line drops very low when the bypass valve is open. This creates a problem of oil hanging up in the evaporator coil and suction piping. For this reason, this method is not acceptable in applications where the evaporator is located below the compressor.

When hot gas bypass is applied to a water chiller containing a direct-expansion evaporator, hot gas bypass to the evaporator inlet is always used. In a direct-expansion evaporator, liquid refrigerant flows through the tubes and water fills the surrounding shell. Oil holdup within the tubes can be a problem at part load when refrigerant velocity is reduced. The increased velocity brought about by bypassing to the evaporator inlet solves this problem for water chillers.

Finally, when hot gas bypass is applied to a system, the need for condensing pressure control must be considered. Sufficient condensing pressure must be available to ensure adequate refrigerant flow to produce a bypass load when the hot gas bypass valve is to be opened. If a decreasing load is accompanied by a corresponding reduction in condensing pressure, the hot-gas-bypass valve may not be capable of bypassing refrigerant vapor at the rate required to stabilize the suction temperature within reasonable limits. The result is that the

period three

The Compressor in a System

notes

suction temperature falls, and coil frosting or chiller freezing may occur. Since the hot-gas-bypass valve is sized to pass a given quantity of refrigerant vapor at a particular condensing–suction pressure difference, some means of maintaining the condensing pressure within limits must be provided. Various methods of controlling condensing pressure are discussed in the *Refrigeration System Components* clinic.

period four **Review**

notes

Refrigeration Compressors

period four
Review

Figure 51

We will now review the main concepts that were covered in this clinic on refrigeration compressors.

Review—Period One

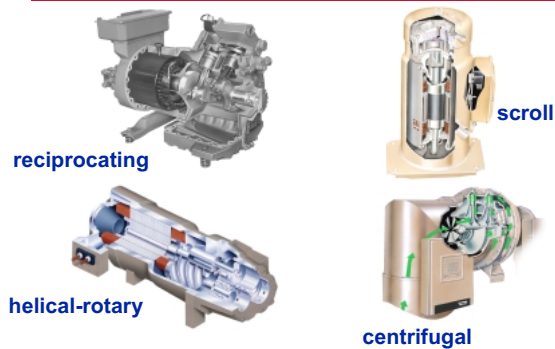

Figure 52

Period One introduced the four types of compressors commonly used in air-conditioning applications: reciprocating, scroll, helical-rotary (or screw), and centrifugal.

The first three types are called positive-displacement compressors. They work on the principle of trapping the refrigerant vapor and compressing it by gradually shrinking the volume of the refrigerant. Centrifugal compressors use the principle of dynamic compression, which involves converting energy from one form to another, to increase the pressure and temperature of the refrigerant.

period four

Review

notes

Review—Period Two

▲ Reciprocating	Cylinder Unloaders
▲ Scroll	Cycle On and Off
▲ Helical-Rotary	Slide Valve
▲ Centrifugal	Inlet Vanes
	Variable-Speed

Figure 53

Period Two reviewed various methods of varying compressor capacity. Reciprocating compressors typically use cylinder unloaders that match the compressor capacity to the evaporator load by deactivating piston–cylinder pairs.

Refrigeration systems using scroll compressors generally unload by using multiple compressors, cycling them on and off as needed to satisfy the evaporator load.

A common method of unloading a helical-rotary compressor is to use a slide valve that is an integral part of the compressor housing. By changing the position of the slide valve along the compressor rotors, the volume of refrigerant vapor being delivered by the compressor can be controlled to match the evaporator load.

Finally, centrifugal compressors generally use inlet vanes to “preswirl” the refrigerant before it enters the impeller, lessening the ability of the impeller to take in the refrigerant. As a result, the compressor’s refrigerant pumping capacity decreases to balance with the evaporator load.

Alternatively, the capacity of any of these types of compressors can be controlled by varying the rotational speed of the compressor motor. It is most often applied, however, to centrifugal compressors.

period four

Review

notes

Review—Period Three

▲ System-level control

- ◆ Constant-volume DX system
 - *Control by sensing space temperature*
- ◆ VAV DX system
 - *Control by sensing supply air temperature*
- ◆ Chilled water system
 - *Control by sensing temperature of water leaving evaporator*

▲ Preventing evaporator freeze-up

- ◆ Sensing suction temperature
- ◆ Hot gas bypass

Figure 54

Period Three considered the entire system and discussed how the capacity of the compressor is controlled to maintain desired space conditions.

In a constant-volume DX system, in order to respond to changing loads, the capacity of the compressor is controlled by directly sensing space temperature. In a VAV DX system, the capacity of the compressor is controlled by sensing the supply air temperature. In a chilled-water system, the capacity of the compressor is typically controlled by sensing the temperature of the water leaving the evaporator.

Period Three also discussed sensing suction temperature and hot gas bypass as methods for preventing evaporator freeze-up.

period four **Review**

notes

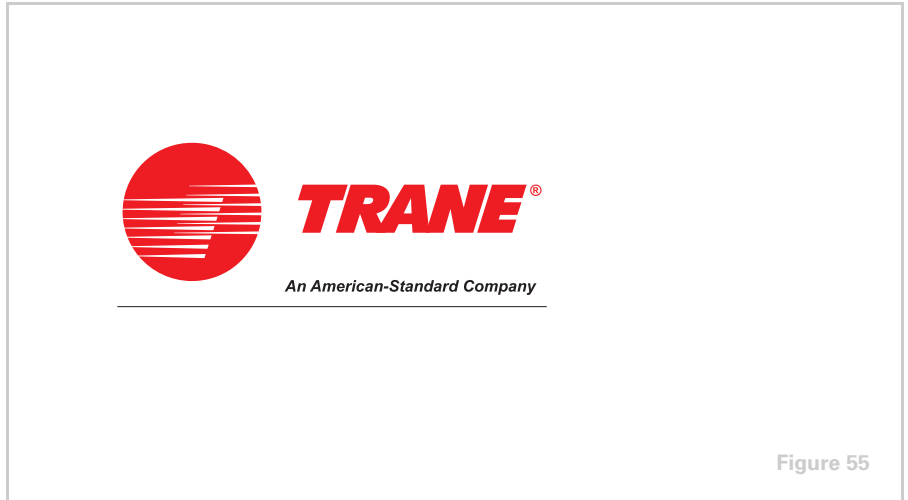

For more information, refer to the following references:

- *Trane Air Conditioning Manual*
- *Trane Reciprocating Refrigeration Manual*
- *Helical-Rotary Water Chillers* Air Conditioning Clinic (Trane literature order number TRG-TRC012-EN)
- *Centrifugal Water Chillers* Air Conditioning Clinic (Trane literature order number TRG-TRC010-EN)
- *Hot Gas Bypass Control* Applications Engineering Manual (Trane literature order number AM-CON10)
- *ASHRAE Handbook – Refrigeration*
- *ASHRAE Handbook – Systems and Equipment*

Visit the ASHRAE Bookstore at www.ashrae.org.

For more information on additional educational materials available from Trane, contact your local Trane office (request a copy of the Educational Materials catalog – Trane order number EM-ADV1) or visit our online bookstore at www.trane.com/bookstore/.



Quiz

Questions for Period 1

- 1** What is the purpose of the compressor in a refrigeration system?
- 2** List the four primary types of compressors used in air-conditioning applications.
- 3** What causes the suction valve to open on a reciprocating compressor?
- 4** True or False: The intake of refrigerant vapor in a scroll compressor occurs at the outer edge of the scroll assembly and discharge occurs through the port at the center of the scroll.
- 5** What is the term for the type of compressor that has the motor sealed within the compressor housing?

Questions for Period 2

- 6** Assuming a constant condensing temperature, does the capacity of a compressor increase or decrease as the suction temperature decreases?
- 7** What method of capacity control is commonly applied to scroll compressors?
- 8** What method of capacity control is commonly applied to centrifugal compressors?

Questions for Period 3

- 9** In a VAV DX system, the capacity of the compressor is typically controlled by sensing _____. (space temperature, supply air temperature, chilled-water supply temperature)
- 10** In a constant-volume chilled-water system, the capacity of the compressor is typically controlled by sensing _____. (space temperature, supply air temperature, chilled-water supply temperature)
- 11** In a constant-volume DX system, the capacity of the compressor is typically controlled by sensing _____. (space temperature, supply air temperature, chilled-water supply temperature)
- 12** What are the two common methods of preventing evaporator frosting in a direct-expansion (DX) system?

Answers

- 1** To elevate the pressure, and, therefore, the temperature, of the refrigerant vapor high enough that it can reject heat to air, or some other fluid, at normally available temperatures.
- 2** Reciprocating, scroll, helical-rotary (or screw), and centrifugal
- 3** During the intake stroke, the piston travels away from the discharge valve and creates a vacuum effect, reducing the pressure within the cylinder to below suction pressure. Since the pressure within the cylinder is less than the pressure of the refrigerant at the suction side of the compressor, the suction valve is forced open and the refrigerant vapor is drawn into the cylinder.
- 4** True
- 5** Hermetic or semihermetic
- 6** Decreases
- 7** Cycling individual scroll compressors on and off
- 8** Inlet vanes or variable-speed drive with inlet vanes
- 9** Supply air temperature
- 10** Chilled-water supply temperature
- 11** Space temperature
- 12** Sensing the suction temperature and hot gas bypass

Glossary

adjustable-frequency drive (AFD) A device used to vary the capacity of a compressor by varying the speed of the compressor motor.

ASHRAE American Society of Heating, Refrigerating and Air-Conditioning Engineers

centrifugal compressor A type of compressor that uses centrifugal force, generated by a rotating impeller, to compress the refrigerant vapor.

chilled water system Uses water as the cooling media. The refrigerant inside the evaporator absorbs heat from the water, and this water is pumped to coils in order to absorb heat from the air used for space conditioning.

compressor A mechanical device in the refrigeration system used to increase the pressure and temperature of the refrigerant vapor.

condenser A component of the refrigeration system where refrigerant vapor is converted to liquid as it rejects heat to air, water, or some other fluid.

constant-volume system A type of air-conditioning system that varies the temperature of a constant volume of air supplied to meet the changing load conditions of the space.

cycling The practice of turning a compressor on and off to match the system load.

cylinder unloader A device used to unload the capacity of a reciprocating compressor by either closing the suction passage to the cylinder, holding open the suction valve of a piston–cylinder pair, or diverting the compressed refrigerant vapor back to the suction side of the compressor.

diffuser passages Passages inside the centrifugal compressor that start out small and become larger as the refrigerant travels through them. As the size of the diffuser passages increases, the velocity, and therefore the kinetic energy, of the refrigerant decreases. This kinetic energy is converted to static energy or static pressure.

direct-expansion (DX) system Uses the refrigerant directly as the cooling media. The refrigerant inside the evaporator absorbs heat directly from the air used for space conditioning.

discharge line A pipe that transports refrigerant vapor from the compressor to the condenser in a mechanical refrigeration system.

dynamic compression A method of compression that involves converting energy from one form to another to increase the pressure and temperature of the refrigerant vapor.

enthalpy A measure of heat quantity, both sensible and latent, per pound [kg] of refrigerant.

Glossary

evaporator A component of the refrigeration system where cool, liquid refrigerant absorbs heat from air, water, or some other fluid, causing the refrigerant to boil.

expansion device A component of the refrigeration system used to reduce the pressure and temperature of the refrigerant to the evaporator conditions.

flash The process of liquid refrigerant being vaporized by a sudden reduction of pressure.

heat of compression The amount of heat added to the refrigerant vapor by the compressor during the process of raising the pressure of the refrigerant to condenser conditions.

helical-rotary compressor A type of compressor that uses two mated rotors to trap the refrigerant vapor and compress it by gradually shrinking the volume of the refrigerant.

hermetic compressor A type of compressor that has the motor sealed within the compressor housing. The motor is cooled by refrigerant.

hot gas bypass A method used to prevent evaporator freeze-up by diverting hot, high-pressure refrigerant vapor from the discharge line to the low-pressure side of the refrigeration system.

impeller The rotating component of a centrifugal compressor that draws refrigerant vapor into its internal passages and accelerates the refrigerant as it rotates, increasing its velocity and kinetic energy.

inlet vanes A device used to vary the capacity of a centrifugal compressor by “preswirling” the refrigerant in the direction of rotation before it enters the impeller, lessening its ability to take in the refrigerant vapor.

liquid line A pipe that transports refrigerant vapor from the condenser to the evaporator in a mechanical refrigeration system.

open compressor A type of compressor that is driven by an external power source, such as an electric motor or a turbine. The motor is coupled to the compressor crankshaft by a flexible coupling, and a seal is used to prevent refrigerant from leaking out of the compressor housing.

ported compressor A type of compressor where the refrigerant vapor enters and exits through ports—no valves are used.

positive-displacement compressor A class of compressors that works on the principle of trapping the refrigerant vapor and compressing it by gradually shrinking the volume of the refrigerant.

pressure–enthalpy chart A graphical representation of the properties of a refrigerant, plotting refrigerant pressure versus enthalpy.

Glossary

reciprocating compressor A type of compressor that uses a piston that travels up and down inside a cylinder to compress the refrigerant vapor.

refrigerant A substance used to absorb and transport heat for the purpose of cooling.

rotor The part of the helical-rotary compressor used to trap and compress the refrigerant vapor. The male and female rotors mesh together, forming pockets of refrigerant to move through the compressor.

scroll compressor A type of compressor that uses two opposing scrolls to trap the refrigerant vapor and compress it by gradually shrinking the volume of the refrigerant.

semihermetic compressor A type of compressor that has the motor sealed within the compressor housing. The sealed housing may be opened to repair or overhaul the compressor or motor.

slide valve The part of the helical-rotary compressor used to vary the flow rate of refrigerant vapor through it.

suction line A pipe that transports refrigerant vapor from the evaporator to the compressor in a mechanical refrigeration system.

variable-air-volume (VAV) system A type of air-conditioning system that varies the volume of constant temperature air supplied to meet the changing load conditions of the space.

variable-speed drive See adjustable-frequency drive.

volute A large space around the perimeter of a centrifugal compressor that collects refrigerant vapor after compression.



TRANE®

The Trane Company
Worldwide Applied Systems Group
3600 Pammel Creek Road
La Crosse, WI 54601-7599
www.trane.com

An American Standard Company

Literature Order Number TRG-TRC004-EN

File Number E/AV-FND-TRG-TRC004-0200-EN

Supersedes 2803-2-385 and 2803-13-587

Stocking Location Inland-La Crosse

Since The Trane Company has a policy of continuous product improvement, it reserves the right to change design and specifications without notice.

Free Manuals Download Website

<http://myh66.com>

<http://usermanuals.us>

<http://www.somanuals.com>

<http://www.4manuals.cc>

<http://www.manual-lib.com>

<http://www.404manual.com>

<http://www.luxmanual.com>

<http://aubethermostatmanual.com>

Golf course search by state

<http://golfingnear.com>

Email search by domain

<http://emailbydomain.com>

Auto manuals search

<http://auto.somanuals.com>

TV manuals search

<http://tv.somanuals.com>