

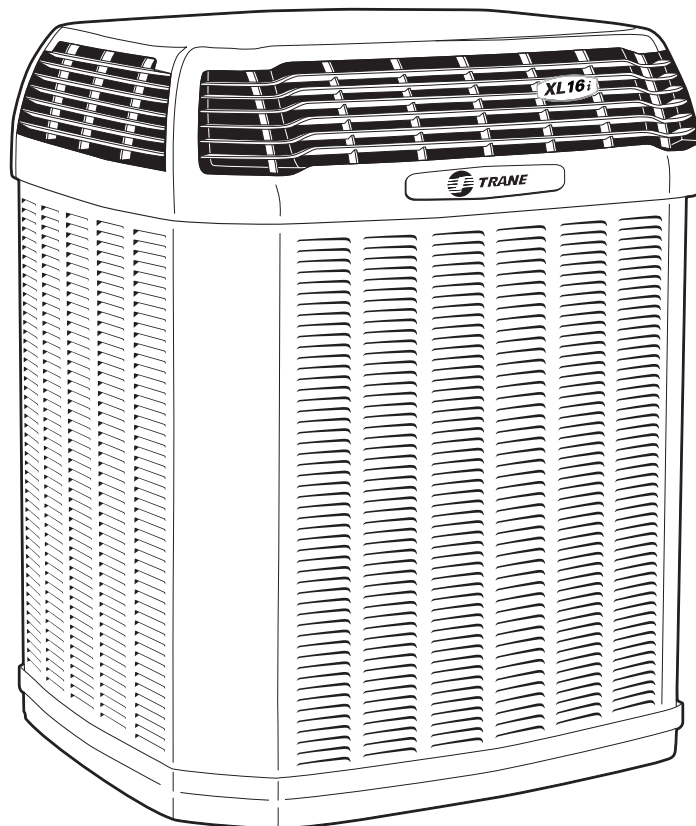

Split System Cooling Product Data

XL16i
4TTX6024, 036, 048 & 060E

2, 3, 4 & 5 Tons



PUB. NO. 22-1752-10



Features and Benefits

- **CLIMATUFF™** 2-stage scroll compressor
- Efficiency up to **18.50 SEER**
- All Aluminum **SPINE FIN™** coil
- **WEATHERGUARD™ II** top shields unit
- **DURATUFF™** weather proof and rust proof base
- **COMFORT "R"™** mode approved for better comfort indoors
- **QUICK-SESS™** cabinet, service access and refrigerant connections with full coil protection
- **WEATHERGUARD™** fasteners
- Glossy corrosion resistant finish tarpaulin gray cabinet with anthracite gray top
- Internal compressor high/low pressure & temperature protection
- Liquid line filter/drier
- Low sound with advanced variable speed fan motor
- Service valve cover
- R-410A refrigerant
- From 70 to 100% capacity modulation
- 100% run test in the factory
- Low ambient cooling to 55° as shipped
- **Extended warranties available**

Contents

Features and Benefits	2
General Data	4
Product Specifications	4
A-weighted Sound Power Level [dB(A)]	4
Accessory Description and Usage	5
AHRI Standard Capacity Rating Conditions	5
Model Nomenclature	6
Electrical Data	7
Dimensions	8
Mechanical Specifications	9



General Data

Product Specifications

Model No. ①	4TTX6024E1	4TTX6036E1	4TTX6048E1	4TTX6060E1
Electrical Data V/Ph/Hz ②	230/1/60	230/1/60	230/1/60	230/1/60
Min Cir Ampacity	14	22	29	39
Max Fuse Size (Amps)	20	35	50	60
Compressor	CLIMATUFF® - SCROLL	CLIMATUFF® - SCROLL	CLIMATUFF® - SCROLL	CLIMATUFF® - SCROLL
RL AMPS - LR AMPS	10.3 - 52	16.7 - 82	21.2 - 104	28.8 - 152.9
Outdoor Fan FL Amps	0.74	0.74	2.80	2.80
Fan HP	1/8	1/8	1/3	1/3
Fan Dia (inches)	27.6	27.6	27.6	27.6
Coil	Spine Fin™	Spine Fin™	Spine Fin™	Spine Fin™
Refrigerant R-410A	9/13-LB/OZ	9/13-LB/OZ	12/9-LB/OZ	12/9-LB/OZ
Line Size - (in.) O.D. Gas ③	5/8	3/4	7/8	1-1/8
Line Size - (in.) O.D. Liquid ③	3/8	3/8	3/8	3/8
Dimensions H x W x D (Crated)	53.4 x 35.1 x 38.7	57.4 x 35.1 x 38.7	57.4 x 35.1 x 38.7	57.4 x 35.1 x 38.7
Weight - Shipping	309	316	328	332
Weight - Net	261	266	291	295
Start Components	NO	NO	NO	NO
Sound Enclosure	NO	NO	NO	NO
Compressor Sump Heat	NO	NO	NO	NO
Optional Accessories: ④				
Rubber Isolator Kit	BAYISLT101	BAYISLT101	BAYISLT101	BAYISLT101
Snow Leg - Base & Cap 4" High	BAYLEGS002	BAYLEGS002	BAYLEGS002	BAYLEGS002
Snow Leg - 4" Extension	BAYLEGS003	BAYLEGS003	BAYLEGS003	BAYLEGS003
Hard Start Kit Scroll	BAYKSKT260	BAYKSKT260	BAYKSKT260	BAYKSKT260
Crankcase Heater Kit	BAYCCHT301	BAYCCHT301	BAYCCHT301	BAYCCHT301
Extreme Condition Mounting Kit	BAYECMT023	BAYECMT004	BAYECMT004	BAYECMT004
Vertical Discharge Air Kit Base 4	BAYVDTA003	BAYVDTA004	BAYVDTA004	BAYVDTA004
Auto Charge Solenoid Kit	BAYCAKT001	BAYCAKT001	BAYCAKT001	BAYCAKT001
Refrigerant Lineset ⑤	TAYREFLN9*	TAYREFLN7*	TAYREFLN3*	TAYREFLN4*

① Certified in accordance with the Air-Source Unitary Heat Pump Equipment certification program which is based on AHRI Standard 210/240.

② Calculated in accordance with N.E.C. Only use HACR circuit breakers or fuses.

③ Standard line lengths - 60'. Standard lift - 25' Suction and Liquid line.

For Greater lengths and lifts refer to refrigerant piping software Pub# 32-3312-0*. (*denotes latest revision)

④ For accessory description and usage, see page 5.

⑤ * = 15, 20, 25, 30, 40 and 50 foot lineset available.

A-weighted Sound Power Level [dB(A)]

MODEL	SOUND POWER LEVEL [dB(A)]	A-WEIGHTED FULL OCTAVE SOUND POWER LEVEL dB - [dB(A)]							
		63	125	250	500	1000	2000	4000	8000
4TTX6024E	72	43.7	52.6	54.3	62.4	60.4	57	54.1	46.6
4TTX6036E	72	38	50.4	56.8	60.4	59.8	57.2	55.2	49.2
4TTX6048E	73	44.2	50.4	58.9	63.1	63	57.4	53.6	47.4
4TTX6060E	74	42.2	53.8	57.8	66	65.7	57.7	58.4	51.7

Note: Rated in accordance with AHRI Standard 270-2008.

General Data

Accessory Description and Usage

Rubber Isolators — 5 rubber donuts to isolate condensing unit from mounting frame or pad. Use on any application where sound transmission needs to be minimized.

Extreme Conditions Mounting Kit — Bracket kits to securely mount condensing unit to a frame or pad without removing any panels. Use in areas with high winds, or on commercial rooftops, etc.

Low Ambient Cooling — For low ambient cooling below 55° see Application Guide APP-APG013-EN.

AHRI Standard Capacity Rating Conditions

AHRI STANDARD 210/240 RATING CONDITIONS —

- (A) Cooling 80°F DB, 67°F WB air entering indoor coil, 95°F DB air entering outdoor coil.
- (B) High Temperature Heating 47°F DB, 43°F WB air entering outdoor coil, 70°F DB air entering indoor coil.
- (C) Low Temperature Heating 17°F DB, 15°F WB air entering outdoor coil, 70°F DB air entering indoor coil.
- (D) Rated indoor airflow for heating is the same as for cooling.

AHRI STANDARD 270 RATING CONDITIONS — (Noise rating numbers are determined with the unit in cooling operation.) Standard Noise Rating number is at 95°F outdoor air.





Model Nomenclature

Outdoor Units

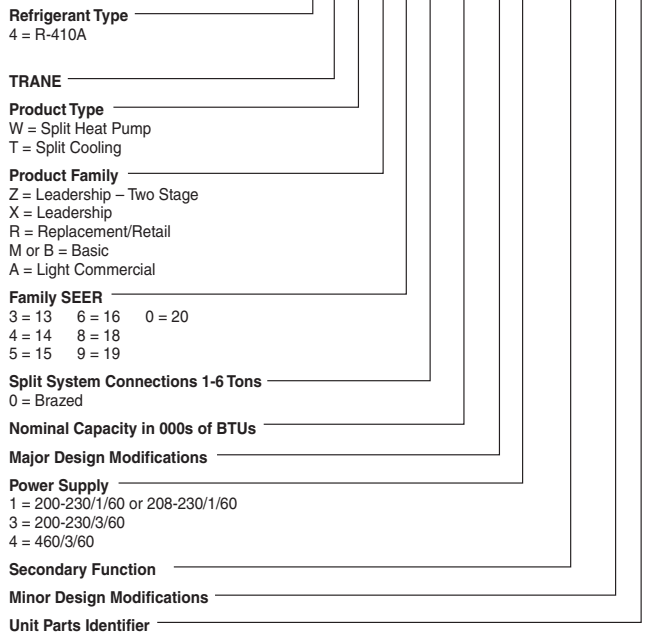

Gas Furnaces

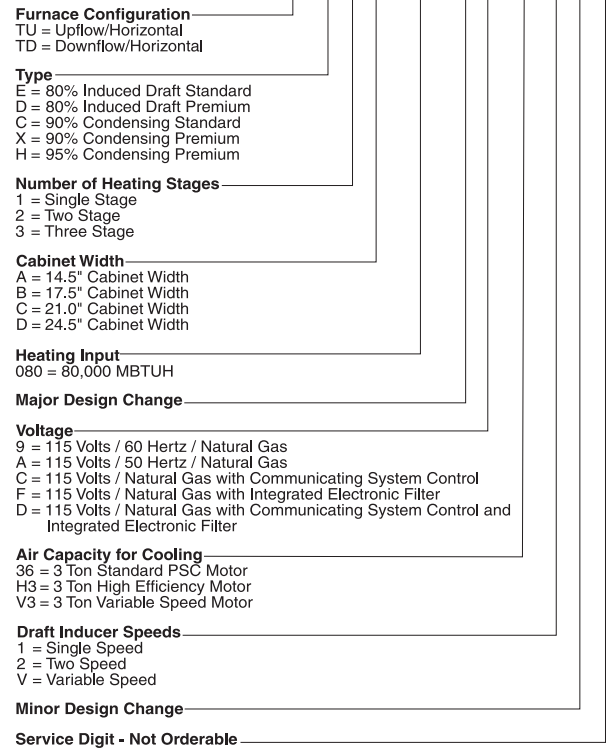

Air Handlers – Residential

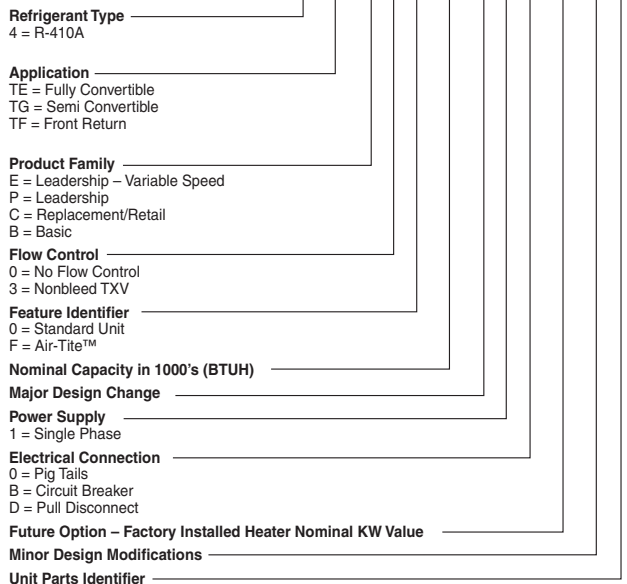

Coils – Residential

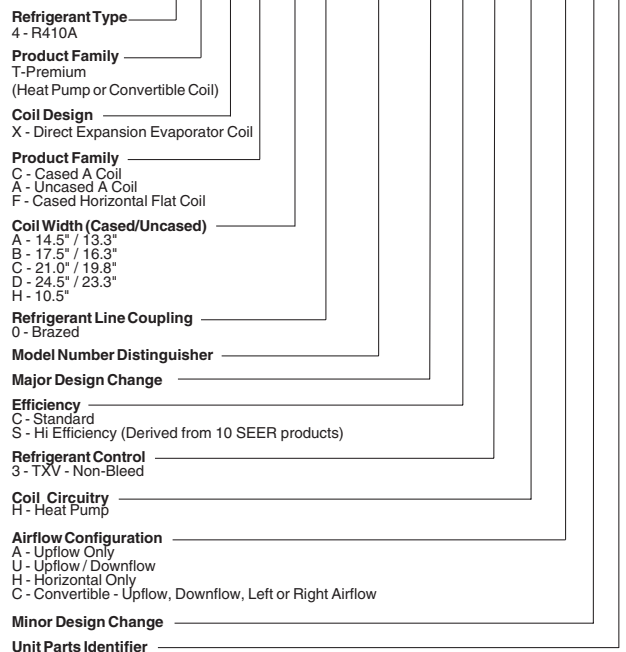

NOTE: There will be a phase-in of new model numbers for new air handlers over next 2 years.

Electrical Data

Schematic Diagrams

(SEE LEGEND)

4TTX6048E, 060E

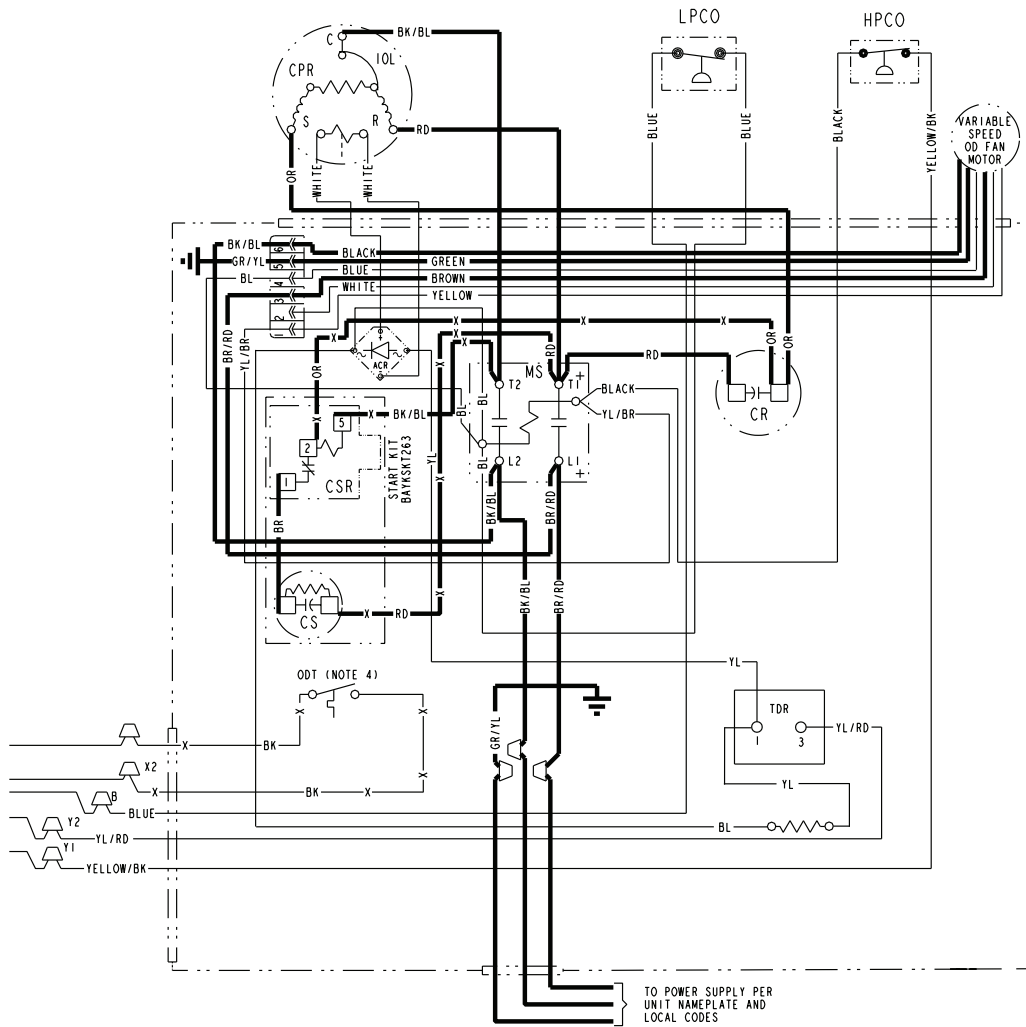

TO POWER SUPPLY PER UNIT NAMEPLATE AND LOCAL CODES

LEGEND-EQUIPMENT DIAGRAM



- | | |
|--------------------------------|---------------------------------------|
| 24 V. LINE V. } FACTORY WIRING | INTERNAL OVERLOAD PROTECTOR |
| 24 V. LINE V. } FIELD WIRING | PRESSURE ACTUATED SWITCH |
| GROUND | TEMP. ACTUATED SWITCH |
| JUNCTION | POL. PLUG FEMALE HOUSING (MALE TERM.) |
| WIRE NUT OR CONNECTOR | POL. PLUG MALE HOUSING (FEMALE TERM.) |
| COIL | RESISTOR OR HEATING ELEMENT |
| CAPACITOR | MOTOR WINDING |
| RELAY CONTACT (N.O.) | TERMINAL |
| RELAY CONTACT (N.C.) | |
| THERMISTOR | |





















PRINTED FROM DI56678 P02

Electrical Data

Schematic Diagrams

LEGEND

	COLOR OF WIRE				
BK/BL	BLACK WIRE WITH BLUE MARKER				
	COLOR OF MARKER				
BK	BLACK	OR	ORANGE	YL	YELLOW
BL	BLUE	RD	RED	GR	GREEN
BR	BROWN	WH	WHITE	PR	PURPLE

	24 V.	}	FACTORY WIRING
	LINE V.		
	24 V.	}	FIELD WIRING
	LINE V.		
	FIELD INSTALLED FACTORY WIRING		
	GROUND		
	JUNCTION		
	WIRE NUT OR CONNECTOR		
	COIL		
	CAPACITOR		
	RELAY CONTACT (N.O.)		
	RELAY CONTACT (N.C.)		
	THERMISTOR		
	INTERNAL OVERLOAD PROTECTOR		
	PRESSURE ACTUATED SWITCH		
	TEMP. ACTUATED SWITCH		
	POL. PLUG FEMALE HOUSING (MALE TERM.)		
	POL. PLUG MALE HOUSING (FEMALE TERM.)		
	RESISTOR OR HEATING ELEMENT		
	MOTOR WINDING		
	TERMINAL		

CA	COOLING ANTICIPATOR	LPCO	LOW PRESSURE CUTOUT SW.
CBS	COIL BOTTOM SENSOR	MS	COMPRESSOR MOTOR CONTACTOR
CF	FAN CAPACITOR	ODA	OUTDOOR ANTICIPATOR
CN	WIRE CONNECTOR	OFT	OUTDOOR FAN THERMOSTAT
CPR	COMPRESSOR	ODS	OUTDOOR TEMPERATURE SENSOR
CR	RUN CAPACITOR	ODT	OUTDOOR THERMOSTAT
CS	STARTING CAPACITOR	RHS	RESISTANCE HEAT SWITCH
CSR	CAPACITOR SWITCHING RELAY	SC	SWITCHOVER VALVE SOLENOID
DFC	DEFROST CONTROL	SM	SYSTEM "ON-OFF" SWITCH
F	INDOOR FAN RELAY	TDL	DISCHARGE LINE THERMOSTAT
HA	HEATING ANTICIPATOR	TNS	TRANSFORMER
HPCO	HIGH PRESSURE CUTOUT SW.	TS	HEATING-COOLING THERMOSTAT
IOL	INTERNAL OVERLOAD PROTECTOR	TSH	HEATING THERMOSTAT

Dimensions

4TTX6 Outline Drawing

Note: All dimensions are in MM (Inches).

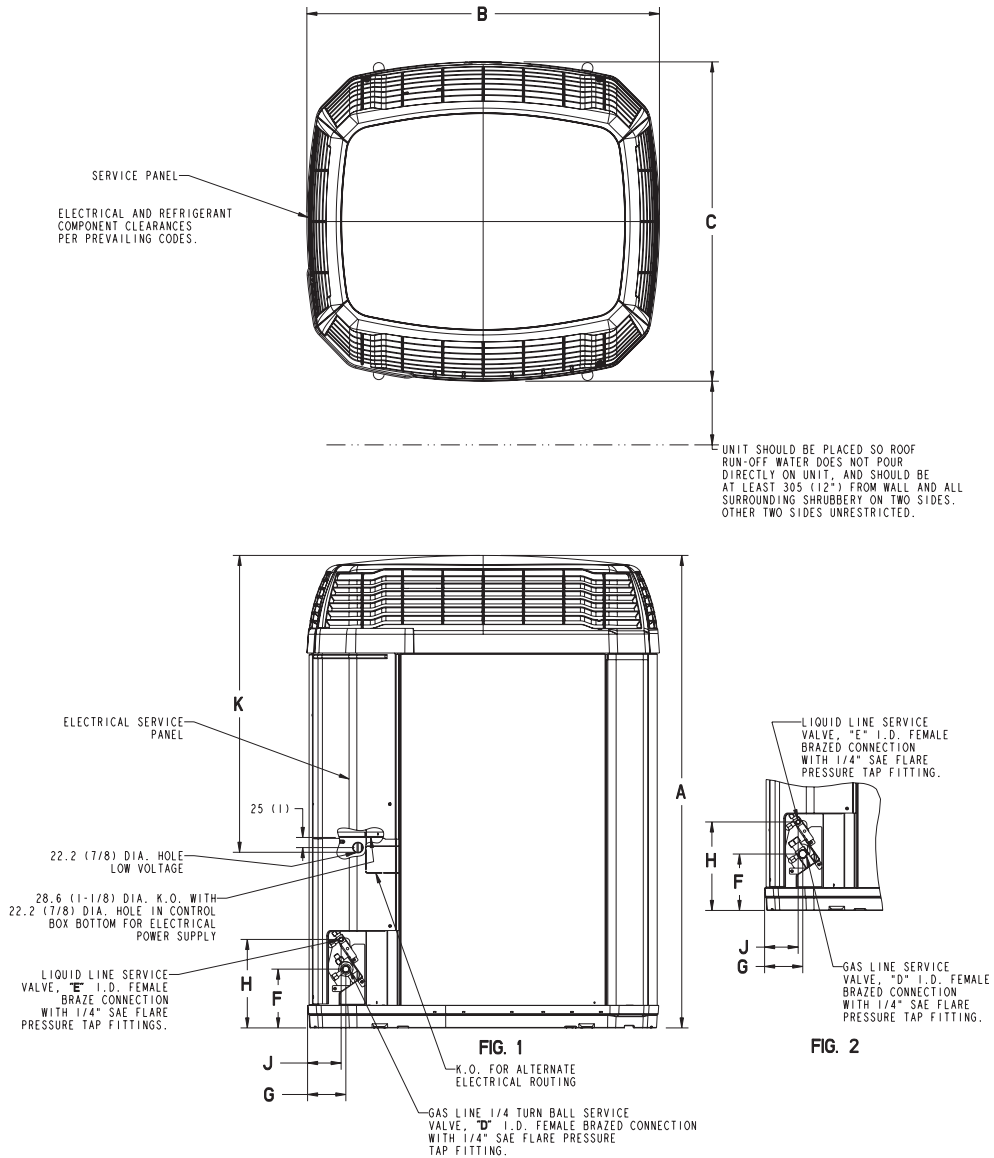

MODELS	BASE	A	B	C	D	E	F	G	H	J	K
4TTX6024E	4	1267 (49-7/8)	946 (37-1/4)	870 (34-1/4)	5/8	3/8	152 (6)	98 (3-7/8)	219 (8-5/8)	86 (3-3/8)	730 (28-3/4)
4TTX6036E	4	1369 (53-7/8)	946 (37-1/4)	870 (34-1/4)	3/4	3/8	152 (6)	98 (3-7/8)	219 (8-5/8)	86 (3-3/8)	1035 (40-3/4)
4TTX6048E	4	1369 (53-7/8)	946 (37-1/4)	870 (34-1/4)	7/8	3/8	152 (6)	98 (3-7/8)	219 (8-5/8)	86 (3-3/8)	730 (28-3/4)
4TTX6060E	4	1369 (53-7/8)	946 (37-1/4)	870 (34-1/4)	1-1/8	3/8	152 (6)	98 (3-7/8)	219 (8-5/8)	86 (3-3/8)	730 (28-3/4)



Mechanical Specifications

General

The 4TTX6 is fully charged from the factory for matched indoor section and up to 15 feet of piping. This unit is designed to operate at outdoor ambient temperatures as high as 115°F. Cooling capacities are matched with a wide selection of air handlers and furnace coils that are AHRI certified. The unit shall be certified to UL 1995. Exterior is designed for outdoor application.

Casing

Unit casing is constructed of heavy gauge, G60 galvanized steel and painted with a weather-resistant powder paint on all louvers and panels. Corrosion and weatherproof CMBP-G30 DuraTuff™ base.

Refrigerant Controls

Refrigeration system controls include condenser fan, compressor contactor and high pressure switch. High and low pressure controls are inherent to the compressor. A factory installed liquid line drier is standard.

Compressor

The Climatuff® 2-stage compressor features internal over temperature and pressure protection and hermetic motor. Other features include: roto lock suction and discharge refrigerant connections, centrifugal oil pump and modular plugs for electrical connections.

Condenser Coil

The outdoor coil provides low airflow resistance and efficient heat transfer. The coil is protected on all four sides by louvered panels.

Low Ambient Cooling

As manufactured, this unit has a cooling capability to 55°F. For low ambient cooling below 55° see Application Guide APP-APG013-EN.





Trane
www.trane.com

Trane has a policy of continuous product and product data improvement and it reserves the right to change design and specifications without notice.

Free Manuals Download Website

<http://myh66.com>

<http://usermanuals.us>

<http://www.somanuals.com>

<http://www.4manuals.cc>

<http://www.manual-lib.com>

<http://www.404manual.com>

<http://www.luxmanual.com>

<http://aubethermostatmanual.com>

Golf course search by state

<http://golfingnear.com>

Email search by domain

<http://emailbydomain.com>

Auto manuals search

<http://auto.somanuals.com>

TV manuals search

<http://tv.somanuals.com>