

**DAIKIN**

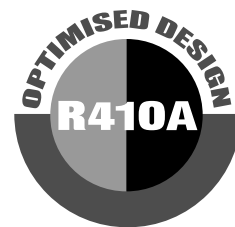

**INVERTER**

DAIKIN ROOM AIR CONDITIONER

**Operation Manual**

MODELS FTXS15DVJU

FTXS18DVJU

FTXS24DVJU

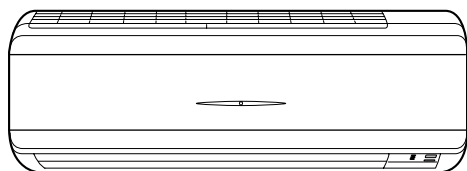

# CONTENTS

## READ BEFORE OPERATION

---

Safety precautions.....	2
Names of parts .....	4
Preparation Before Operation .....	7

## OPERATION

---

AUTO · DRY · COOL · HEAT · FAN Operation.....	10
Adjusting the Airflow Direction.....	12
POWERFUL Operation .....	14
OUTDOOR UNIT SILENT Operation .....	15
HOME LEAVE Operation .....	16
INTELLIGENT EYE Operation .....	18
TIMER Operation .....	20

## CARE

---

Care and Cleaning .....	22
-------------------------	----

## TROUBLE SHOOTING

---

Trouble Shooting .....	25
------------------------	----

# Safety precautions





- Keep this manual where the operator can easily find it.
- Read this manual carefully before starting the unit.
- For safety reason, the operator must read the following cautions carefully.
- This manual classifies precautions into WARNINGS and CAUTIONS. Be sure to follow all precautions below: they are all important for ensuring safety.

## **WARNING**

If you do not follow these instructions exactly, the unit may cause property damage, personal injury or loss of life.

## **CAUTION**

If you do not follow these instructions exactly, the unit may cause minor or moderate property damage or personal injury.



-  Never do.
-  Be sure to ground the air conditioner.
-  Never touch the air conditioner (including the remote controller) with a wet hand.
-  Be sure to follow the instructions.
-  Never cause the air conditioner (including the remote controller) to get wet.

## **WARNING**

- In order to avoid fire, explosion or injury, do not operate the unit when in a harmful environment, among which flammable or corrosive gases, are detected near the unit. 
- It is not good for health to expose your body to the airflow for a long time.
- Do not put your finger, a rod or other objects into the air outlet or inlet. As the fan is rotating at a high speed and could, cause injury. Always keep small children away from the unit during operation.
- Do not attempt to repair, relocate, modify or reinstall the air conditioner by yourself. Incorrect work or modifications could cause electric shocks, fire or other damage.  
For repairs and reinstallation, consult your Daikin dealer for advice and information.

- The refrigerant used in the air conditioner is safe. Although leaks should not occur, if for some reason any refrigerant happens to leak into the room, make sure it does not come in contact with any flame such as gas heaters, kerosene heaters or gas range. 
- If the air conditioner is not cooling (heating) properly, the refrigerant may be leaking, contact your authorized dealer or qualified service repairman.  
When making repairs which requires adding refrigerant, consult with your authorized dealer or qualified service repairman.
- Do not attempt to install the air conditioner by yourself. Improper installation could result in water leakage, electric shocks or fire. For installation, consult your authorized dealer or a qualified technician.
- If you detect any abnormal smell or fire, stop the operation and turn off the breaker in order to avoid electric shock, fire or injury. And call your authorized dealer for instructions.

## **CAUTION**

- The air conditioner must be grounded to the earth. Improper grounding may result in electric shocks. Do not connect the earth grounding wire to a gas pipe, water pipe, lightning rod, or a telephone ground line. Follow all local and state electrical codes. 
- Do not use this unit for cooling precision instruments, food, plants, animals or works of art. 
- Never expose little children, plants or animals directly to the airflow.
- Do not place appliances which produce an open flame in places exposed to the airflow from the unit or under the indoor unit. It may cause incomplete combustion of appliances or deformation of the indoor unit due to heat.
- Do not block air inlets or outlets. Impaired airflow may result in poor performance or equipment problems.
- Do not stand, sit, or place objects on the outdoor unit. To avoid injury, do not remove the fan guard.

- Do not place anything under the indoor or outdoor unit that must be kept away from moisture, such as electrical or electronic equipment. In certain conditions, moisture in the air may condense and drip.
- Check the unit stand and fittings for damage annually.
- Do not touch the air inlet and aluminum fins of outdoor unit. It may cause injury and/or damage the heat transfer surface.
- This appliance is NOT intended for use by young children or impaired persons without proper supervision.
- Young children should be supervised to ensure that they DO NOT play with or near the airflow of this appliance.
- Do not pull at the conduit or hang anything on it. Otherwise it will cause fire or electric shock.
- Do not touch the heat exchanger fins. Improper handling may result in injury.
- Do not turn off the power immediately after stopping operation. Always wait at least five minutes before turning off the power. Otherwise, water leakage and trouble may occur.

- 
- To avoid oxygen deficiency, ventilate the room sufficiently if equipment with a burner is used together with the air conditioner. 
  - To avoid personal injury or equipment damage be sure to stop the operation, turn the breaker off or pull out the supply cord before cleaning or servicing the unit. NOTE: More than one disconnect may be required to shut off all power.
  - Do not connect the air conditioner to a power supply different from the one specified. It may cause improper operation or fire.
  - Depending on the environment, state and local electrical codes, a ground fault circuit interrupter may be required. Improper grounding or lack of a ground fault circuit interrupter may result in electrical shock, injuries, or death.
  - Arrange the drain hose to ensure smooth drainage. Improper drainage may cause water damage to the building, or its furnishing.
  - Depending on the usage environment, water may leak from the air conditioner. If this happens, contact your Trane Dealer.
  - Safely dispose of the packing materials. Packing materials, such as nails and other metal or wooden parts, may cause stabs or other injuries. Tear apart and throw away plastic packaging bags so that children will not play with them. If children play with a plastic bag which was not torn apart, they face the risk of suffocation.
  - The remote controller should be installed in such away that children cannot play with it.

- 
- Do not operate the air conditioner with wet hands. 

- 
- Do not wash the indoor unit with excessive water, only use a slightly wet cloth. 
  - Do not place things such as vessels containing water or anything else on top of the unit. Water may penetrate into the unit and degrade electrical insulations, resulting in an electric shock.

### **Installation site**

- To install the air conditioner in the following types of environments, consult your authorized dealer.
  - Places with an oily ambient or where steam or soot occurs.
  - Salty environment such as coastal areas.
  - Places where sulfide gas occurs such as hot springs.
  - Places where snow may block the outdoor unit.

The drain from the outdoor unit must be discharged to a place of good drainage.

### **Consider nuisance to your neighbors from noises**

- For installation, choose a place as described below.
  - A place solid enough to bear the weight of the unit which does not amplify the operation noise or vibration.
  - A place from where the air discharged from the outdoor unit or the operation noise will not annoy your neighbors.

### **Electrical work**

- For power supply, be sure to use a separate power circuit dedicated to the air conditioner. Follow all local and state electrical codes.

### **System relocation**

- Relocating the air conditioner requires specialized knowledge and skills. Please consult your authorized dealer if relocation is necessary for moving or remodeling.

# Names of parts

## ■ Indoor Unit

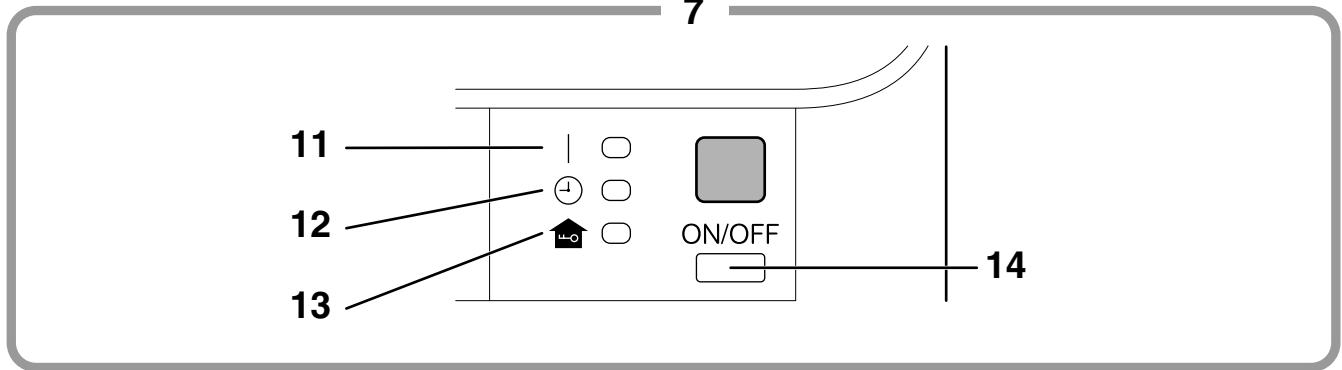
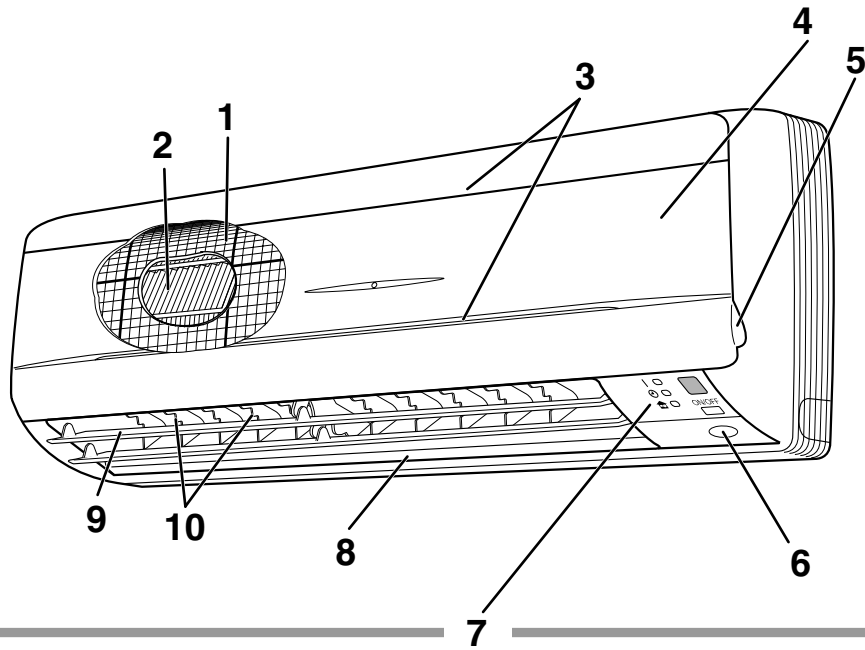

## ■ Main unit control panel

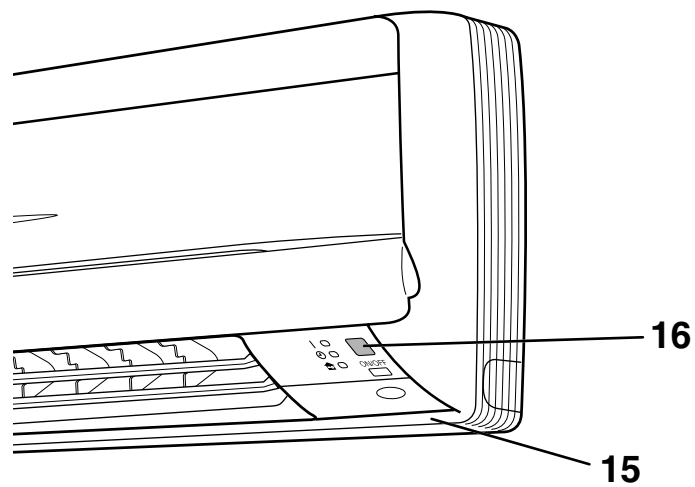

## ■ Outdoor Unit

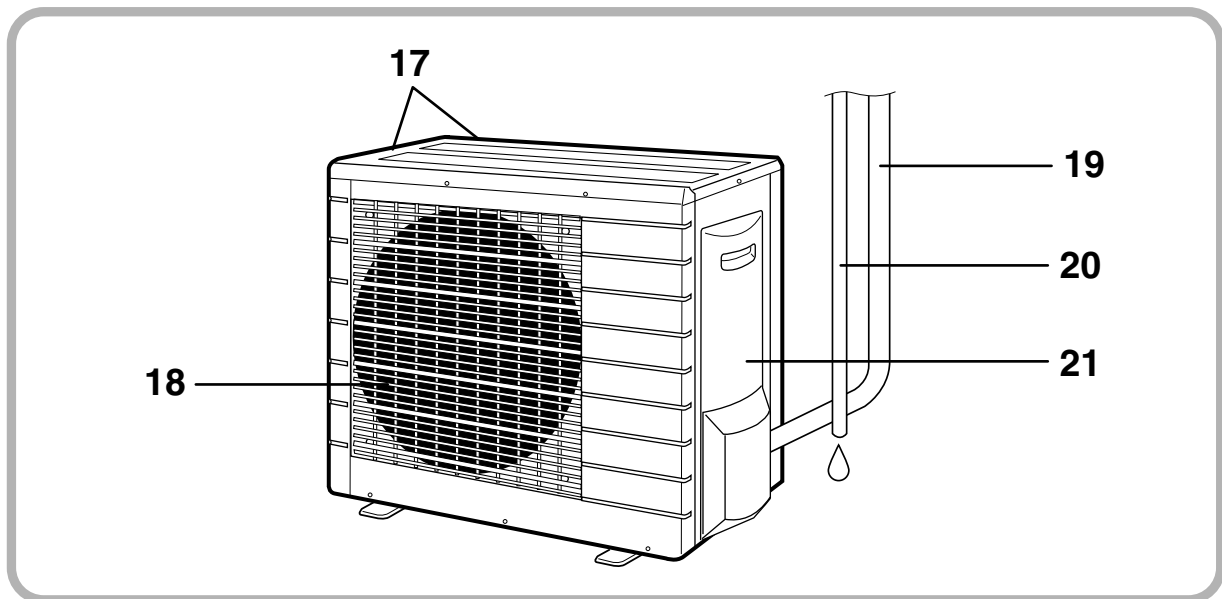

## ■ Indoor Unit

### 1. Air filter

### 2. Air-purifying filter with photo catalytic deodorizing function:

- These filters are attached to the inside of the air filters.

### 3. Air inlet

### 4. Front panel

### 5. Panel tab

### 6. INTELLIGENT EYE sensor:

- It detects the movements of people and automatically switches between normal operation and energy saving operation. (page 18.)

### 7. Display

### 8. Air outlet

### 9. Flaps (horizontal blades): (page 12.)

### 10. louvers (vertical blades):

- The louvers are inside of the air outlet. (page 13.)

### 11. Operation lamp (green)

### 12. TIMER lamp (yellow): (page 20.)

### 13. HOME LEAVE lamp (red):

- Lights up when you use HOME LEAVE Operation. (page 16.)

### 14. Indoor Unit ON/OFF switch:

- Push this switch once to start operation. Push once again to stop it.
- The operation mode refers to the following table.

Mode	Temperature setting	Airflow rate
AUTO	77°F	AUTO

- This switch is useful when the remote controller is missing.

### 15. Room temperature sensor:

- It senses the air temperature around the unit.

### 16. Signal receiver:

- It receives signals from the remote controller.
- When the unit receives a signal, you will hear a short beep.
  - Operation start ..... beep-beep
  - Settings changed..... beep
  - Operation stop..... beeeeeep

## ■ Outdoor Unit

17. Air inlet: (Back and side)

18. Air outlet

19. Refrigerant piping and inter-unit cable

20. Drain hose

21. Earth grounding terminal:

- It is inside of this cover.

Appearance of the outdoor unit may differ from some models.

## ■ Remote Controller

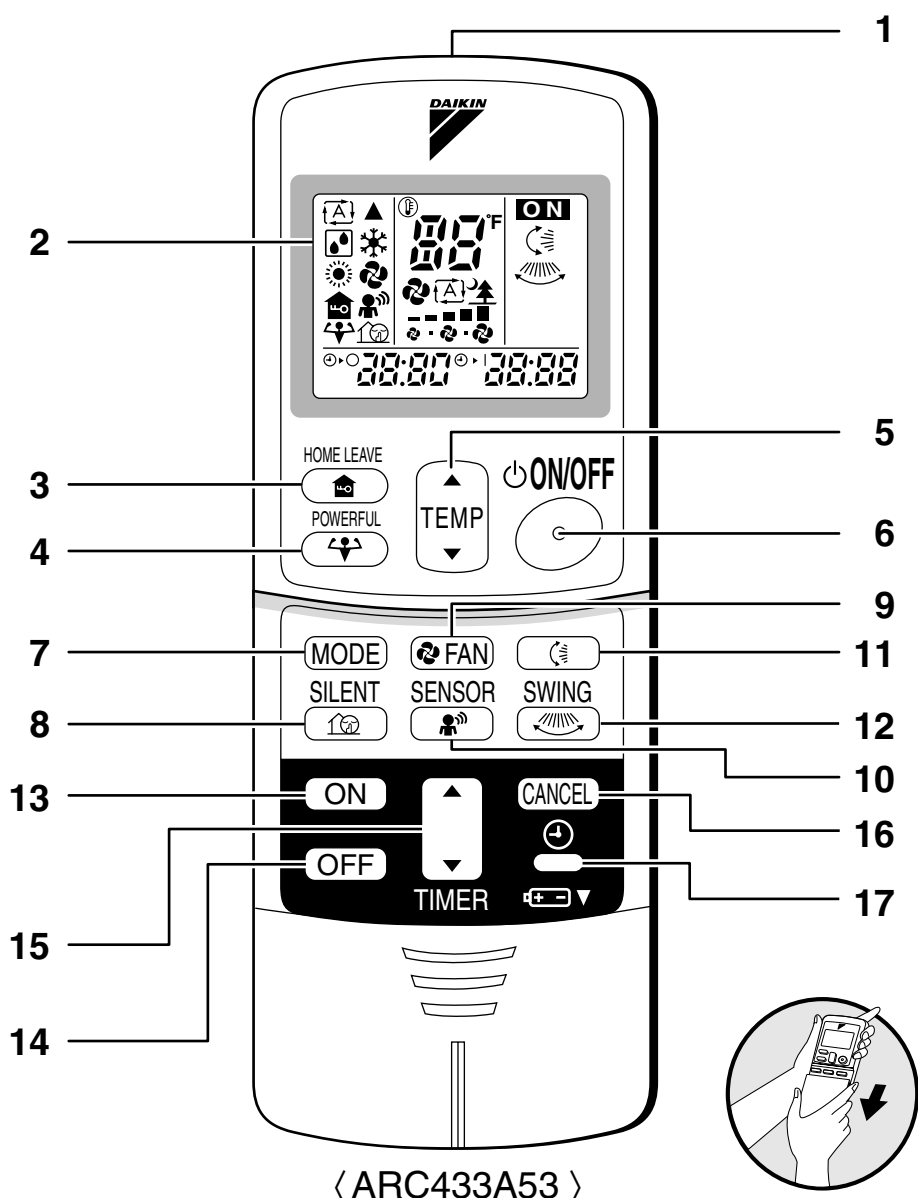

〈 ARC433A53 〉

### 1. Signal transmitter:

- It sends signals to the indoor unit.

### 2. Display:

- It displays the current settings.  
(In this illustration, each section is shown with all its displays ON for the purpose of explanation.)

### 3. HOME LEAVE button:

for HOME LEAVE operation (page 16.)

### 4. POWERFUL button: (Maximum operation)

for POWERFUL operation (page 14.)

### 5. TEMPERATURE adjustment buttons:

- It changes the temperature setting.

### 6. ON/OFF button:

- Press this button once to start operation.  
Press once again to stop it.

### 7. MODE selector button:

- It selects the operation mode.  
(AUTO/DRY/COOL/HEAT/FAN) (page 10.)

**8. SILENT button:** for OUTDOOR UNIT SILENT operation (page 15.)

### 9. FAN setting button:

- It selects the airflow rate setting.

**10. SENSOR button:** for INTELLIGENT EYE operation (page 18.)

**11. SWING button:** (page 12.)

- Flap (Horizontal blade)

**12. SWING button:** (page 12.)

- Louver (Vertical blades)

**13. ON TIMER button:** (page 21.)

**14. OFF TIMER button:** (page 20.)

**15. TIMER Setting button:**

- It changes the time setting.

**16. TIMER CANCEL button:**

- It cancels the timer setting.

**17. CLOCK button:** (page 9.)

# Preparation Before Operation

## ■ To set the batteries

1. Press  with a finger and slide the front cover to take it off.
2. Set two dry batteries (AAA).
3. Set the front cover as before.

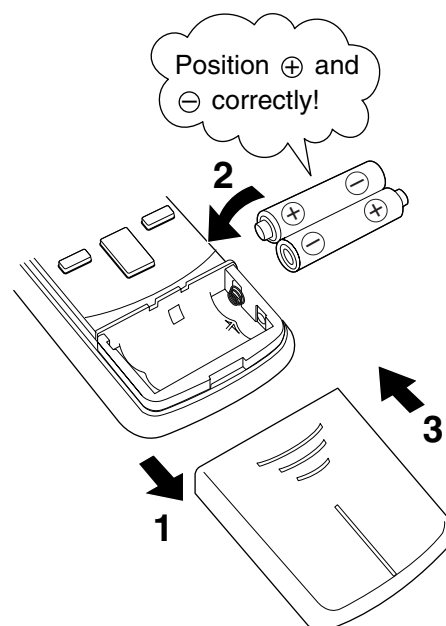

## ATTENTION

### ■ About batteries

- When replacing the batteries, use batteries of the same type, and replace the two old batteries together.
- When the system is not used for a long time, take the batteries out. In case the remote controller is not used for a long time remove all batteries in order to prevent liquid leak of the battery.
- We recommend replacing once a year, although if the remote controller display begins to fade or if reception deteriorates, please replace with new alkali batteries. Using manganese batteries reduces the lifespan.
- The attached batteries are provided for the initial use of the system. The usable period of the batteries may be short depending on the manufactured date of the air conditioner.
- Pressing two or more buttons simultaneously may cause the strange display of the Remote controller. The Remote controller is not malfunction. In this case take the batteries out and reset them.



# Preparation Before Operation

## ■ To operate the remote controller

- To use the remote controller, aim the transmitter at the indoor unit. If there is anything to block signals between the unit and the remote controller, such as a curtain, the unit will not operate.
- Do not drop the remote controller. Do not get it wet.
- The maximum distance for communication is about 23 Ft..

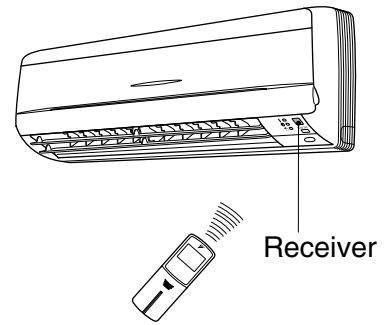

## ■ To fix the remote controller holder on the wall

1. Choose a place from where the signals reach the unit.
2. Fix the holder to a wall, a pillar, or similar location with the screws procured locally.
3. Place the remote controller in the remote controller holder.

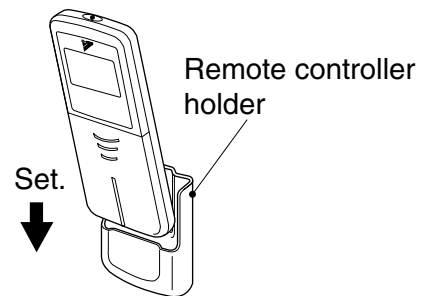

- To remove, pull it upwards.

## ATTENTION

### ■ About remote controller

- Do not put the remote controller in the following places.
  - In direct sunlight.
  - In vicinity of a heater.
- Dust on the signal transmitter or receiver will reduce the sensitivity. Wipe off dust with soft cloth.
- Signal communication may be disabled if an electronic-starter-type fluorescent lamp (such as inverter-type lamps) is in the room. Consult your authorized dealer if that is the case.
- If the remote controller signals happen to operate another appliance, move that appliance to somewhere else, or consult your authorized dealer.

## ■ To set the clock

### 1. Press “CLOCK button”.

0:00 is displayed.

⌚ blinks.

### 2. Press “TIMER setting button” to set the clock to the present time.

Holding down “▲” or “▼” button rapidly increases or decreases the time display.

### 3. Press “CLOCK button”.

⌚ blinks.

## ■ Turn the breaker ON

- Turning ON the breaker opens the flap, then closes it again. (This is a normal procedure.)

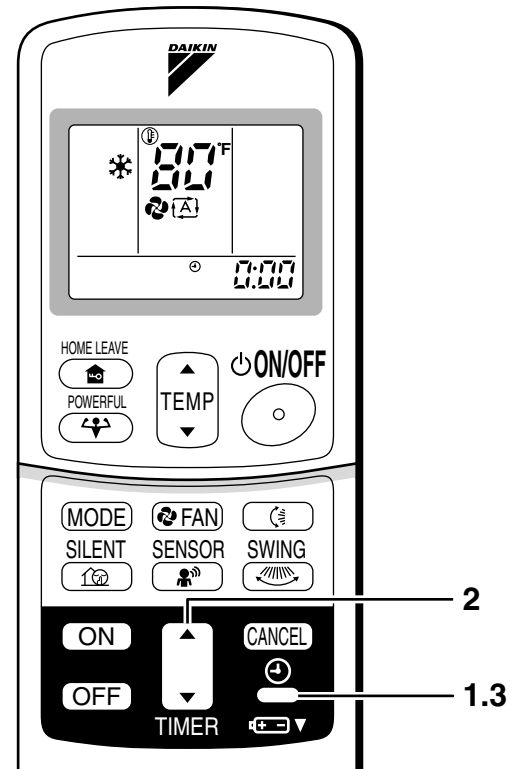

## NOTE

### ■ Tips for saving energy

- Be careful not to cool (heat) the room too much. Keeping the temperature setting at a moderate level helps save energy.
- Cover windows with a blind or a curtain. Blocking sunlight and air from outdoors increases the cooling (heating) effect.
- Clogged air filters cause inefficient operation and waste energy. Clean them once every two weeks.

#### Recommended temperature setting

For cooling: 78°F – 82°F  
For heating: 68°F – 75°F

### ■ Please note

- When the main power switch is turned on, some watts of electricity is being used even if the system is not operating. Turn off the main power supply switch for saving energy.
- If you are not going to use the air conditioner for a long period, for example in spring or autumn, turn the breaker OFF to save energy.
- Use the air conditioner in the following conditions.

Mode	Operating conditions	If operation is continued out of this range
COOL	Outdoor temperature: 14 to 115 °F Indoor temperature: 64 to 90 °F Indoor humidity: 80% max.	<ul style="list-style-type: none"> <li>• A safety device may work to stop the operation.</li> <li>• Condensation may occur on the indoor unit and drip.</li> </ul>
HEAT	Outdoor temperature: 5 to 64 °F Indoor temperature: 50 to 86 °F	<ul style="list-style-type: none"> <li>• A safety device may work to stop the operation.</li> </ul>
DRY	Outdoor temperature: 14 to 115 °F Indoor temperature: 64 to 90 °F Indoor humidity: 80% max.	<ul style="list-style-type: none"> <li>• A safety device may work to stop the operation.</li> <li>• Condensation may occur on the indoor unit and drip.</li> </ul>

- Operation outside this humidity or temperature range may cause a safety device to disable the system.

# AUTO · DRY · COOL · HEAT · FAN Operation

The air conditioner operates with the operation mode of your choice.

From the next time on, the air conditioner will operate with the same operation mode.

## ■ To start operation

### 1. Press “MODE selector button” and select a operation mode.

- Each pressing of the button advances the mode setting in sequence.

: AUTO

: DRY

: COOL

: HEAT

: FAN



### 2. Press “ON/OFF button” .

- The OPERATION lamp lights up.

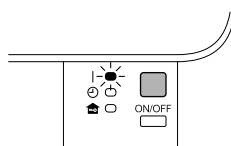

## ■ To stop operation

### 3. Press “ON/OFF button” again.

- Then OPERATION lamp goes off.

## ■ To change the temperature setting



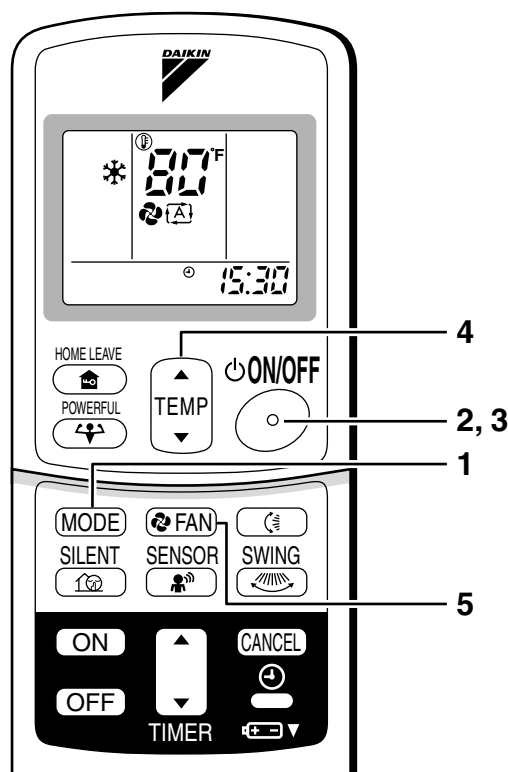

### 4. Press “TEMPERATURE adjustment button”

DRY or FAN mode	AUTO or COOL or HEAT mode
The temperature setting is not variable.	Press “▲” to raise the temperature and press “▼” to lower the temperature.
	Set to the temperature you like. 



## ■ To change the airflow rate setting

### 5. Press “FAN setting button”.

DRY mode	AUTO or COOL or HEAT or FAN mode
The airflow rate setting is not variable.	Five levels of airflow rate setting from “  ” to “  ” plus “  ” “  ” are available. 

- Indoor unit quiet operation

When the airflow is set to “”, the noise from the indoor unit will become quieter.

Use this when making the indoor unit quieter.

The unit might lose capacity when the airflow rate is set to a low level.

## NOTE

### ■ Note on HEAT operation

- Since this air conditioner heats the room by taking heat from outdoor air to indoors, the heating capacity becomes smaller in lower outdoor temperatures. If the heating effect is insufficient, it is recommended to use another heating appliance in combination with the air conditioner.
- The heat pump system heats the room by circulating hot air around all parts of the room. After the start of heating operation, it takes some time before the room gets warmer.
- In heating operation, frost may occur on the outdoor unit and lower the heating capacity. In that case, the system switches into defrosting operation to take away the frost.
- During defrosting operation, hot air does not flow out of indoor unit.

### ■ Note on DRY operation

- The computer chip works to rid the room of humidity while maintaining the temperature as much as possible. It automatically controls temperature and fan strength, so manual adjustment of these functions is unavailable.

### ■ Note on AUTO operation

- In AUTO operation, the system selects an appropriate operation mode (COOL or HEAT) based on the room temperature at the start of the operation.
- The system automatically reselects setting at a regular interval to bring the room temperature to user-setting level.
- If you do not like AUTO operation, you can manually select the operation mode and setting you like.



### ■ Note on airflow rate setting

- At smaller airflow rates, the cooling (heating) effect is also less.

# Adjusting the Airflow Direction

You can adjust the airflow direction to increase your comfort.

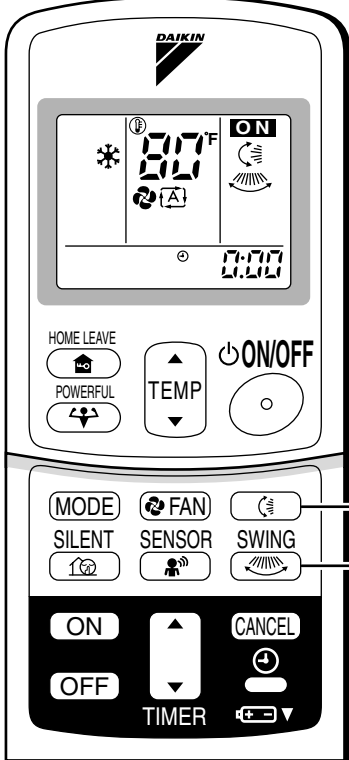
## ■ To adjust the horizontal blade (flap)

1. Press “SWING button 





The image shows a DAIKIN remote control panel. The LCD screen at the top displays a temperature of 20°F and a fan speed icon. Below the screen are several buttons: HOME LEAVE, POWERFUL, TEMP (with up/down arrows), ON/OFF, MODE, FAN, SILENT, SENSOR, and SWING. The SWING button is highlighted with a callout line labeled '1, 2'. Below the SWING button is another SWING button, also highlighted with a callout line labeled '3, 4'. The bottom section of the panel includes ON, OFF, CANCEL, and a TIMER section with up/down arrows and a battery icon.

## ■ To adjust the vertical blades (louvers)

3. Press “SWING button 

12

## ■ To 3-D Airflow

3. Press the “SWING button ” and the “SWING button ”:  
the “” and “” display will light up and the flap and louvers will move in turn.

## ■ To cancel 3-D Airflow

4. Press either the “SWING button ” or the “SWING button ”

## Notes on louvers angles

### ■ ATTENTION

- Always use a remote controller to adjust the louvers angles. Inside the air outlet, a fan is rotating at a high speed and may cause bodily injury if fan comes in contact with fingers.

## Notes on flap angle

- When “SWING button” is selected, the flaps swinging range depends on the operation mode. (See the figure.)

### Three-Dimensional (3-D) Airflow

- Using three-dimensional airflow circulates cold air, which tends to be collected at the bottom of the room, and hot air, which tends to collect near the ceiling, throughout the room, preventing areas of cold and hot developing.

### ■ ATTENTION

- Always use a remote controller to adjust the flaps angle. If you attempt to move it forcibly with hand when it is swinging, the mechanism may be broken.
- Be careful when adjusting the louvers. Inside the air outlet, fan is rotating at a high speed and may cause bodily injury if fan comes in contact with fingers.

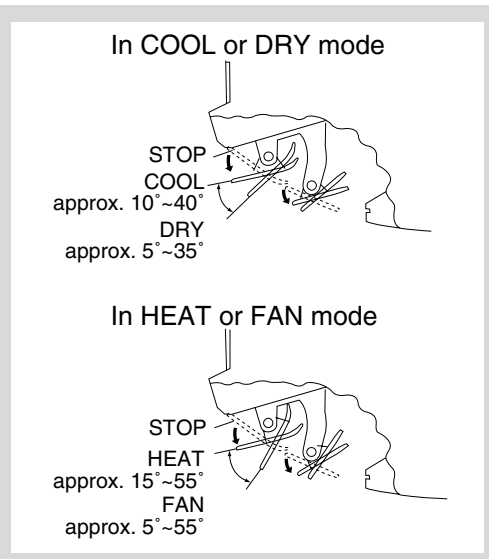

# POWERFUL Operation

POWERFUL operation quickly maximizes the cooling (heating) effect in any operation mode. You can get the maximum capacity .

## ■ To start POWERFUL operation

### 1. Press “POWERFUL button”.

- POWERFUL operation ends in 20 minutes.  
Then the system automatically operates again with the settings which were used before POWERFUL operation.
- When using POWERFUL operation, there are some functions which are not available.

## ■ To cancel POWERFUL operation

### 2. Press “POWERFUL button” again.

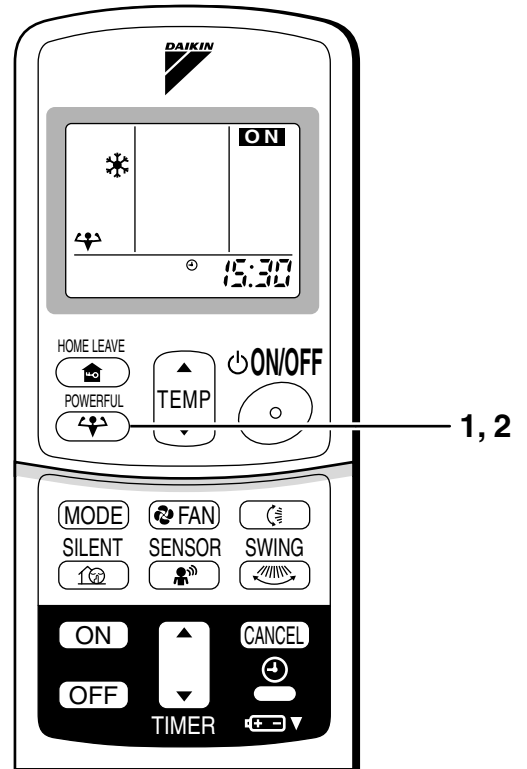

## NOTE

### ■ Notes on POWERFUL operation

- **In COOL and HEAT mode**  
To maximize the cooling (heating) effect, the capacity of outdoor unit must be increased and the airflow rate be fixed to the maximum setting.  
The temperature and airflow settings are not variable.
- **In DRY mode**  
The temperature setting is lowered by 4.5°F and the airflow rate is slightly increased.
- **In FAN mode**  
The airflow rate is fixed to the maximum setting.

# OUTDOOR UNIT SILENT Operation

OUTDOOR UNIT SILENT operation lowers the noise level of the outdoor unit by changing the fan speed on the outdoor unit. This function is convenient during night.

## ■ To start OUTDOOR UNIT SILENT operation

1. Press “SILENT button”.

## ■ To cancel OUTDOOR UNIT SILENT operation

2. Press “SILENT button” again.

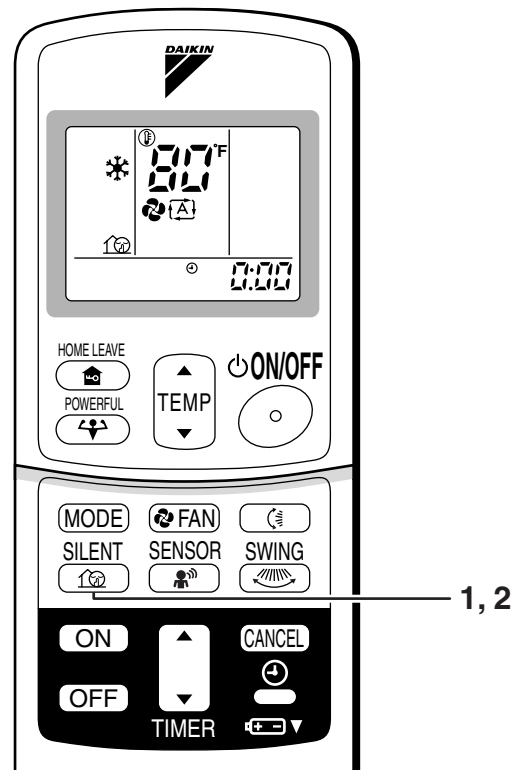

## NOTE

### ■ Note on OUTDOOR UNIT SILENT operation

- This function is available in COOL, HEAT, and AUTO modes. (This is not available in FAN and DRY mode.)
- POWERFUL operation and OUTDOOR UNIT SILENT operation cannot be used at the same time. Priority is given to POWERFUL operation.
- If operation is stopped using the remote controller or the main unit ON/OFF switch when using OUTDOOR UNIT SILENT operation, “” will remain on the remote controller display.



# HOME LEAVE Operation

HOME LEAVE operation is a function which allows you to record your preferred temperature and airflow rate settings.

## ■ To start HOME LEAVE operation

### 1. Press “HOME LEAVE button” .

- The HOME LEAVE lamp lights up.

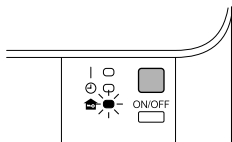

## ■ To cancel HOME LEAVE operation

### 2. Press “HOME LEAVE button” again.

- The HOME LEAVE lamp goes off.

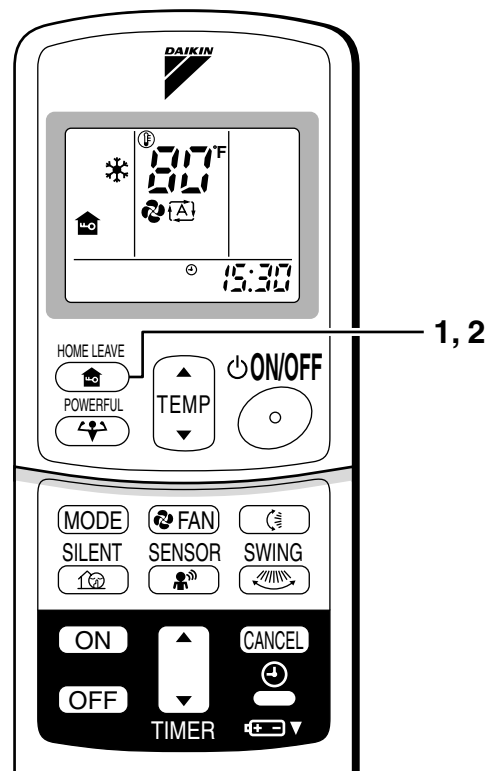

## Before using HOME LEAVE operation.

### ■ To set the temperature and airflow rate for HOME LEAVE operation

When using HOME LEAVE operation for the first time, please set the temperature and airflow rate for HOME LEAVE operation. Record your preferred temperature and airflow rate.

	Initial setting		Selectable range	
	temperature	Airflow rate	temperature	Airflow rate
Cooling	77°F	AUTO	64-90°F	5 step, AUTO and SILENT
Heating	77°F	AUTO	50-86°F	5 step, AUTO and SILENT

1. Press “HOME LEAVE button”. Make sure “” is displayed in the remote controller display.
2. Adjust the set temperature with “▲” or “▼” as you like.
3. Adjust the airflow rate with “FAN” setting button as you like.

Home leave operation will run with these settings the next time you use the unit. To change the recorded information, repeat steps 1 – 3.

## ■ What's the HOME LEAVE operation

Is there a set temperature and airflow rate which is most comfortable, a set temperature and airflow rate which you use the most? HOME LEAVE operation is a function that allows you to record your favorite set temperature and airflow rate. You can start your favorite operation mode simply by pressing the HOME LEAVE button on the remote controller. This function is convenient in the following situations.

## ■ Useful in these cases.

### 1. Use as an energy-saving mode

Set the temperature 2-3° higher (cooling) or lower (heating) than normal. Setting the fan speed to the lowest setting allows the unit to be used in energy-saving mode. Also convenient for use while you are out or sleeping.

#### • Every day before you leave the house...

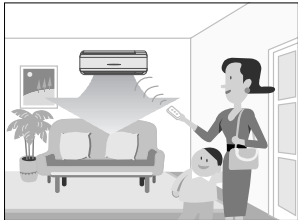

When you go out, push the "HOME LEAVE Operation" button, and the air conditioner will adjust capacity to reach the preset temperature for HOME LEAVE Operation.



When you return, you will be welcomed by a comfortably air conditioned room.

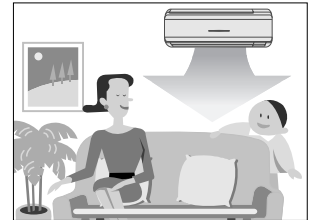

Push the "HOME LEAVE Operation" button again, and the air conditioner will adjust capacity to the set temperature for normal operation.

#### • Before bed...

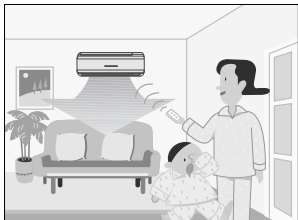

Set the unit to HOME LEAVE Operation before leaving the living room when going to bed.

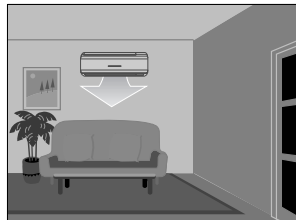

The unit will maintain the temperature in the room at a comfortable level while you sleep.

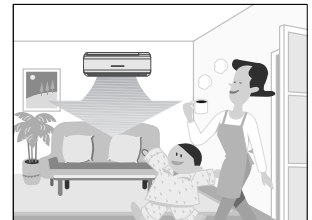

When you enter the living room in the morning, the temperature will be just right. Disengaging HOME LEAVE Operation will return the temperature to that set for normal operation. Even the coldest winters will pose no problem!

### 2. Use as a favorite mode

Once you record the temperature and airflow rate settings you most often use, you can retrieve them by pressing HOME LEAVE button. You do not have to go through troublesome remote control operations.

## NOTE

- Once the temperature and airflow rate for HOME LEAVE operation are set, those settings will be used whenever HOME LEAVE operation is used in the future. To change these settings, please refer to the "Before using HOME LEAVE operation" section above.
- HOME LEAVE operation is only available in COOL and HEAT mode. It cannot be used in AUTO, DRY, and FAN mode.
- HOME LEAVE operation runs in accordance with the previous operation mode (COOL or HEAT) before using HOME LEAVE operation.
- HOME LEAVE operation and POWERFUL operation cannot be used at the same time. Last button that was pressed has priority.
- The operation mode cannot be changed while HOME LEAVE operation is being used.
- When operation is shut off during HOME LEAVE operation, using the remote controller or the indoor unit ON/OFF switch, "HOME LEAVE" will remain on the remote controller display.

# INTELLIGENT EYE Operation

“INTELLIGENT EYE” is the infrared sensor which detects the human movement.

## ■ To start INTELLIGENT EYE operation

1. Press “SENSOR button”.

## ■ To cancel the INTELLIGENT EYE operation

2. Press “SENSOR button” again.

[EX.]

### When somebody is in the room

- Normal operation



### When nobody is in the room

- 20 min. after, start energy saving operation.



### When somebody is back in the room

- Back to normal operation.

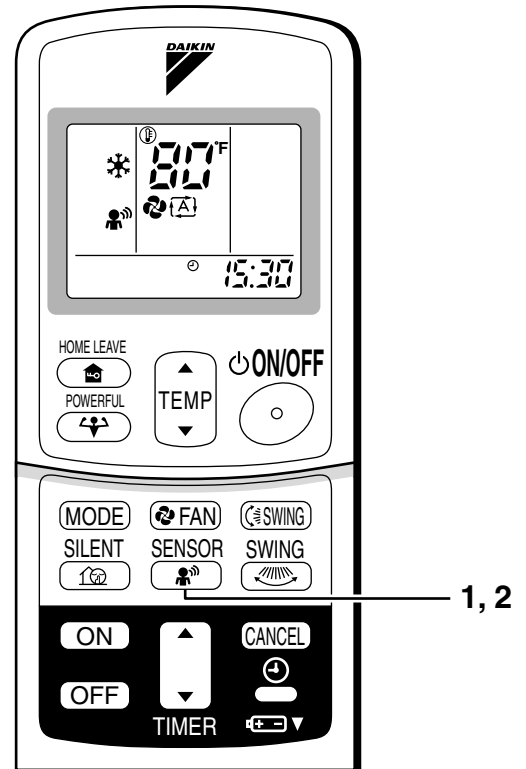

## “INTELLIGENT EYE” is useful for Energy Saving

### ■ Energy saving operation

- Change the temperature  $-3.6^{\circ}\text{F}$  in heating /  $+3.6^{\circ}\text{F}$  in cooling /  $+1.8^{\circ}\text{F}$  in dry mode from set temperature.
- Decrease the airflow rate slightly in fan operation. (In FAN mode only)

### Notes on “INTELLIGENT EYE”

- Application range is as follows.

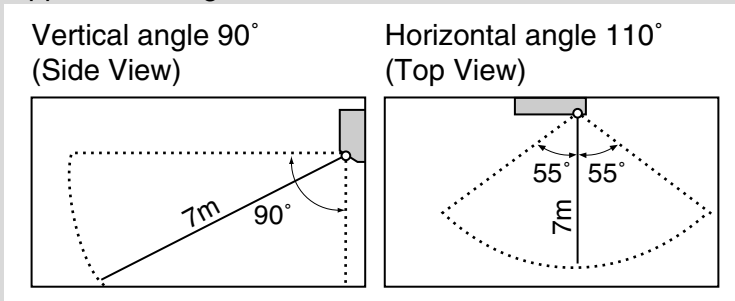

- Sensor may not detect moving objects further than 23Ft. away. (Check the application range)
- Sensor detection sensitivity changes according to indoor unit location, the speed of passersby, temperature range, etc.
- The sensor also mistakenly detects pets, sunlight, fluttering curtains and light reflected off of mirrors as passersby.
- INTELLIGENT EYE operation will not go on during powerful operation.
- Night set mode (page 20.) will not go on during your use of INTELLIGENT EYE operation.

### CAUTION

- Do not place large objects near the sensor.  
Also keep heating units or humidifiers outside the sensor's detection area. This sensor can detect objects it shouldn't as well as not detect objects it should.
- Do not hit or violently push the INTELLIGENT EYE sensor. This can lead to damage and malfunction.

# TIMER Operation

Timer functions are useful for automatically switching the air conditioner on or off at night or in the morning. You can also use OFF TIMER and ON TIMER in combination.

## ■ To use OFF TIMER operation

- Check that the clock is correct.  
If not, set the clock to the present time. (page 9.)

### 1. Press “OFF TIMER button”.

0:00 is displayed.

⊕-⊖ blinks.

### 2. Press “TIMER Setting button” until the time setting reaches the point you like.

- Every pressing of either button increases or decreases the time setting by 10 minutes. Holding down either button changes the setting rapidly.

### 3. Press “OFF TIMER button” again.

- The TIMER lamp lights up.

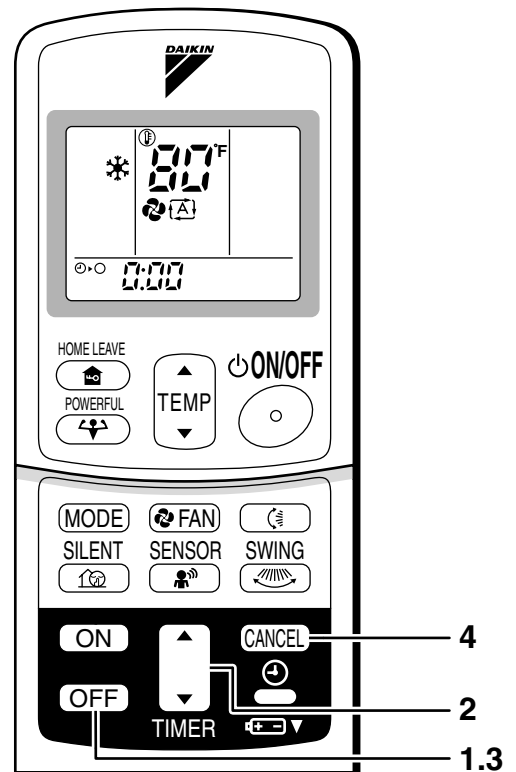
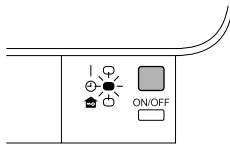

## ■ To cancel the OFF TIMER operation

### 4. Press “CANCEL button”.

- The TIMER lamp goes off.

## Notes

- When TIMER is set, the present time is not displayed.
- Once you set ON, OFF TIMER, the time setting is kept in the memory. (The memory is lost when remote controller batteries are replaced.)
- When operating the unit via the ON/OFF Timer, the actual length of operation may vary from the time entered by the user.

## ■ NIGHT SET MODE

When the OFF TIMER is set, the air conditioner automatically adjusts the temperature setting (1°F up in COOL, 3.6°F down in HEAT) to prevent excessive cooling (heating) for your pleasant sleep.

## ■ To use ON TIMER operation

- Check that the clock is correct. If not, set the clock to the present time. (page 9.)

### 1. Press “ON TIMER button”.

6:00 is displayed.

- The timer lamp blinks.

### 2. Press “TIMER Setting button” until the time setting reaches the point you like.

- Every pressing of either button increases or decreases the time setting by 10 minutes. Holding down either button changes the setting rapidly.

### 3. Press “ON TIMER button” again.

- The TIMER lamp lights up.

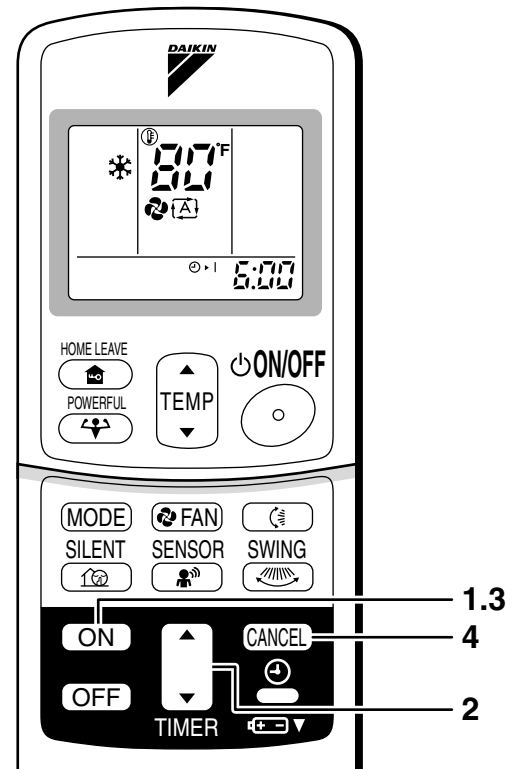
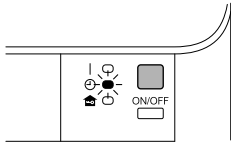

## ■ To cancel ON TIMER operation

### 4. Press “CANCEL button”.

- The TIMER lamp goes off.

## ■ To combine ON TIMER and OFF TIMER

- A sample setting for combining the two timers is shown below.

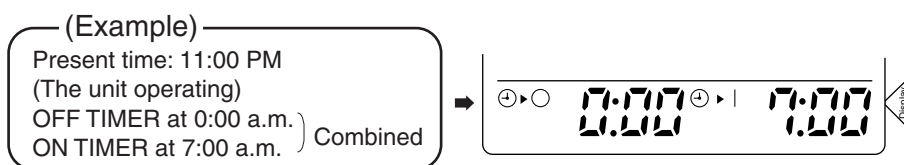

## ATTENTION

### ■ In the following cases, set the timer again.

- After a breaker has turned OFF.
- After a power failure.
- After replacing batteries in the remote controller.

# Care and Cleaning



**CAUTION** Before cleaning, be sure to stop the operation and turn the breaker OFF.

## Units

To avoid possible bodily injury, units should be shutdown or disconnected before any cleaning or servicing is attempted.

### ■ Indoor unit, Outdoor unit and Remote controller

1. Wipe them with dry soft cloth.

### ■ Front panel

1. Open the front panel.

- Hold the panel by the tabs on the two sides and lift it until it stops with a click.

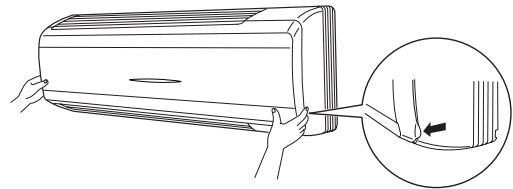

2. Remove the front panel.

- Open the front panel further while sliding it to either the left or right and pulling it toward you. This will disconnect the rotation dowel on one side. Then disconnect the rotation dowel on the other side in the same manner.

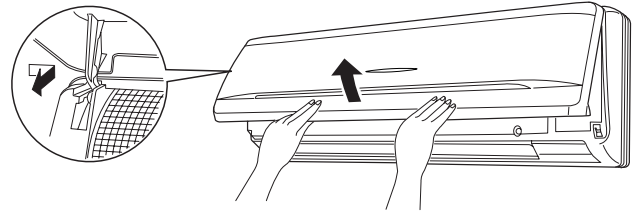

3. Clean the front panel

- Wipe it with a soft cloth soaked in water.
- Only neutral detergent may be used.
- In case of washing the panel with water, dry it with cloth, dry it up in the shade after washing.

4. Attach the front panel

- Align the rotation dowels on the left and right of the front panel with the slots, then push them all the way in.
- Close the front panel slowly. (Press the panel at both sides and the center.)

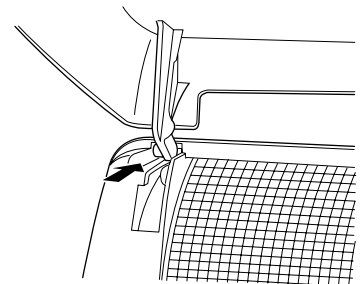

### CAUTION

- Don't touch the metal parts of the indoor unit. If you touch those parts, this may cause an injury.
- When removing or attaching the front panel, use a robust and stable stool and watch your steps carefully.
- When removing or attaching the front panel, support the panel securely with hand to prevent it from falling.
- For cleaning, do not use hot water above 104 °F, benzene, gasoline, thinner, nor other volatile oils, polishing compound, scrubbing brushes, nor other hand stuff.
- After cleaning, make sure that the front panel is securely fixed.

## Filters

### 1. Open the front panel. (page 22)

### 2. Pull out the air filters.

- Push a little upwards the tab at the center of each air filter, then pull it down.

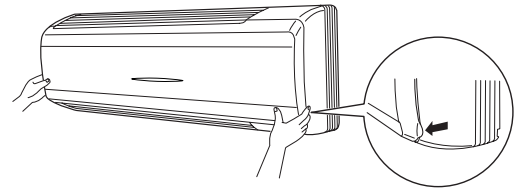

### 3. Take off the air-purifying filter with photo catalytic deodorizing function.

- Press the top of the air-cleaning filter onto the tabs (3 tabs at top). Then press the bottom of the filter up slightly, and press it onto the tabs (3 at bottom).

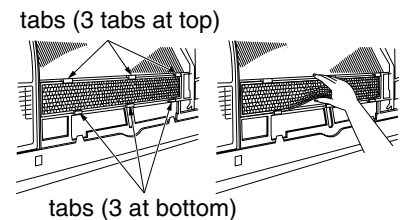
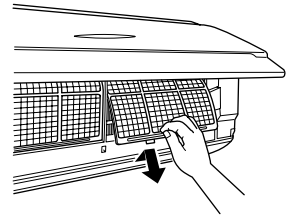

### 4. Clean or replace each filter.

See below.

### 5. Set the air filter and the air-purifying filter with photo catalytic deodorizing function as they were and close the front panel.

- Press the front panel at both sides and the center.

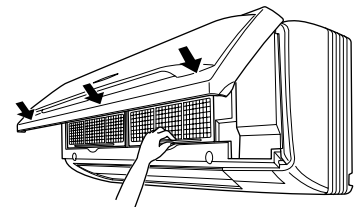

## ■ Air Filter

### 1. Wash the air filters with water or clean them with vacuum cleaner.

- If the dust does not come off easily, wash them with neutral detergent thinned with lukewarm water, then dry them up in the shade.
- It is recommended to clean the air filters every two weeks.

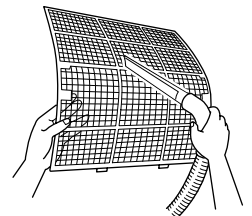

## ■ Air-purifying filter with photo catalytic deodorizing function. (gray)

The Air-purifying filter with photo catalytic deodorizing function can be renewed by washing it with water once every 6 months. We recommend replacing it once every 3 years.

### [ Maintenance ]

1. Remove dust with a vacuum cleaner and wash lightly with water.
2. If it is very dirty, soak it for 10 to 15 minutes in water mixed with a neutral cleaning agent.
3. After washing, shake off remaining water and dry in the shade.
4. Since the material is made out of paper, do not wring out the filter when removing water from it.

### [ Replacement ]

### 1. Remove the tabs on the filter frame and replace with a new filter.

- Dispose of the old filter as flammable waste.



## Check

Check that the base, stand and other fittings of the outdoor unit are not decayed or corroded. Check the units to ensure they are level and secure.

Check that nothing blocks the air inlets and the outlets of the indoor unit and the outdoor unit.

Check that the water drains smoothly out of the drain hose during COOL or DRY operation.

- If no drain water is seen, water may be leaking from the indoor unit. Stop operation and consult your authorized dealer.

## ■ Before a long idle period

### 1. Operate the “FAN only” for several hours on a warm day to dry out the inside.

- Press “MODE” button and select “FAN” operation.
- Press “ON/OFF” button and start operation.

### 2. After operation stops, turn off the electrical circuit breaker for the room air conditioner.

### 3. Remove and clean the air filters. Reinstall filters after cleaning.

### 4. Take out batteries from the remote controller.

## NOTE

- Operation with dirty filters:  
(1) cannot deodorize the air.                      (2) cannot clean the air.  
(3) results in poor heating or cooling.        (4) may cause odor.
- To order air-purifying filter with photo catalytic deodorizing function contact your authorized dealer where you bought the air conditioner.
- Dispose of old filters as required by local codes.

Item	Part No.
Air-purifying filter with photo catalytic deodorizing function. (without frame) 1 set	KAF952A42

# Trouble Shooting

## Conditions that appear to be abnormal but are not operational problems.

The following cases are not abnormal problems and you may just continue using it.

Case	Explanation
<b>Operation does not start quickly.</b> <ul style="list-style-type: none"> <li>• When ON/OFF button was pressed soon after operation was stopped.</li> <li>• When the mode was reselected.</li> </ul>	<ul style="list-style-type: none"> <li>• This is to protect the air conditioner. You should wait for about 3 minutes.</li> </ul>
<b>Hot air does not flow out soon after the start of heating operation.</b>	<ul style="list-style-type: none"> <li>• The air conditioner is warming up. You should wait for 1 to 4 minutes. (The system is designed to start discharging air only after it has reached a certain temperature.)</li> </ul>
<b>The heating operation stops suddenly and a flowing sound is heard.</b>	<ul style="list-style-type: none"> <li>• The system is taking away the frost on the outdoor unit. You should wait for about 3 to 8 minutes.</li> </ul>
<b>The outdoor unit emits water or steam.</b>	<ul style="list-style-type: none"> <li>■ In HEAT mode <ul style="list-style-type: none"> <li>• The frost on the outdoor unit melts into water or steam when the air conditioner is in defrost operation.</li> </ul> </li> <li>■ In COOL or DRY mode <ul style="list-style-type: none"> <li>• Moisture in the air condenses into water on the cool surface of outdoor unit piping and drips.</li> </ul> </li> </ul>
<b>Mists come out of the indoor unit.</b>	<ul style="list-style-type: none"> <li>■ This happens when the air in the room is cooled into mist by the cold airflow during cooling operation.</li> </ul>
<b>The indoor unit gives out odor.</b>	<ul style="list-style-type: none"> <li>■ This happens when smells of the room, furniture, or cigarettes are absorbed into the unit and discharged with the airflow. (If this happens, we recommend you to have the indoor unit washed by a technician. Consult your authorized dealer where you bought the air conditioner.)</li> </ul>
<b>The outdoor fan rotates while the air conditioner is not in operation.</b>	<ul style="list-style-type: none"> <li>■ After operation is stopped: <ul style="list-style-type: none"> <li>• The outdoor fan continues rotating for another 60 seconds for system protection.</li> </ul> </li> <li>■ While the air conditioner is not in operation: <ul style="list-style-type: none"> <li>• When the outdoor temperature is very high, the out door fan starts rotating for system protection.</li> </ul> </li> </ul>
<b>The operation stopped suddenly. (OPERATION lamp is on)</b>	<ul style="list-style-type: none"> <li>■ For system protection, the air conditioner may stop operating on a sudden large voltage fluctuation. It automatically resumes operation in about 3 minutes.</li> </ul>

**Check again.**

Please check again before calling a repair person.

<b>Case</b>	<b>Check</b>
<b>The air conditioner does not operate.</b> <b>(OPERATION lamp is off)</b>	<ul style="list-style-type: none"> <li>• Has a breaker been turned OFF or a fuse blown?</li> <li>• Is there a power failure?</li> <li>• Are fresh batteries installed in the remote controller?</li> <li>• Is the timer setting correct?</li> </ul>
<b>Cooling (Heating) effect is poor.</b>	<ul style="list-style-type: none"> <li>• Are the air filters clean?</li> <li>• Is anything blocking the air inlet or the outlet of the indoor and the outdoor units?</li> <li>• Is the temperature setting appropriate?</li> <li>• Are the windows and doors closed?</li> <li>• Are the airflow rate and the air direction set appropriately?</li> </ul>
<b>Operation stops suddenly.</b> <b>(OPERATION lamp flashes.)</b>	<ul style="list-style-type: none"> <li>• Are the air filters clean?</li> <li>• Is there anything blocking the air inlet or the outlet of the indoor and the outdoor units?</li> </ul> <p>Turn the electrical breaker off, clean the air filters or remove obstacles away from inlet and outlet. Then turn the breaker ON again and try operating the air conditioner with the remote controller. If the lamp still blinks, call your authorized dealer where you bought the air conditioner.</p>
<b>An abnormal functioning happens during operation.</b>	<ul style="list-style-type: none"> <li>• The air conditioner may malfunction with lightning or radio waves. Turn the circuit breaker OFF, to reset unit. Then turn it ON again and try operating the air conditioner with the remote controller.</li> </ul>

**Call your authorized dealer immediately.**

 **WARNING**

- When an abnormality (such as a burning smell) occurs, stop operation and turn the circuit breaker OFF. Continued operation in an abnormal condition may result in troubles, electric shocks or fire. Consult your authorized dealer where you bought the air conditioner.
- Do not attempt to repair or modify the air conditioner by yourself. Work performed by untrained persons could result in electric shocks, personal injury, fire, or additional damage to equipment. Consult your authorized dealer where you bought the air conditioner.

If one of the following symptoms takes place, call your authorized dealer immediately.

- **The power cord is abnormally hot or damaged.**
- **An abnormal sound is heard during operation.**
- **The safety breaker, a fuse, or the ground leakage breaker cuts off the operation frequently.**
- **A switch or a button often fails to work properly.**
- **There is a burning smell.**
- **Water leaks from the indoor unit.**



Turn the breaker OFF and call your authorized dealer.

■ **After a power failure**  
The air conditioner automatically resumes operation in about 3 minutes. You should just wait for a while.

■ **Lightning**  
If lightning may strike the neighboring area, stop operation and turn the breaker OFF for system protection.

## Disposal requirements

Dismantling of the unit, treatment of the refrigerant, oil and eventual other parts, should be done in accordance with the relevant local and national regulations. Contact your authorized dealer for assistance.

**We recommend periodical maintenance**

In certain operating conditions, the inside of the air conditioner may get foul after several seasons of use, resulting in poor performance. It is recommended to have periodical maintenance by a specialist aside from regular cleaning by the user. For specialist maintenance, contact your authorized dealer where you bought the air conditioner.

The maintenance cost must be born by the user.

## Fault diagnosis

### FAULT DIAGNOSIS BY REMOTE CONTROLLER

In the ARC433A series, the temperature display sections on the main unit indicate corresponding codes.

1. When the **TIMER CANCEL** button is held down for 5 seconds, a “00” indication flashes on the temperature display section.

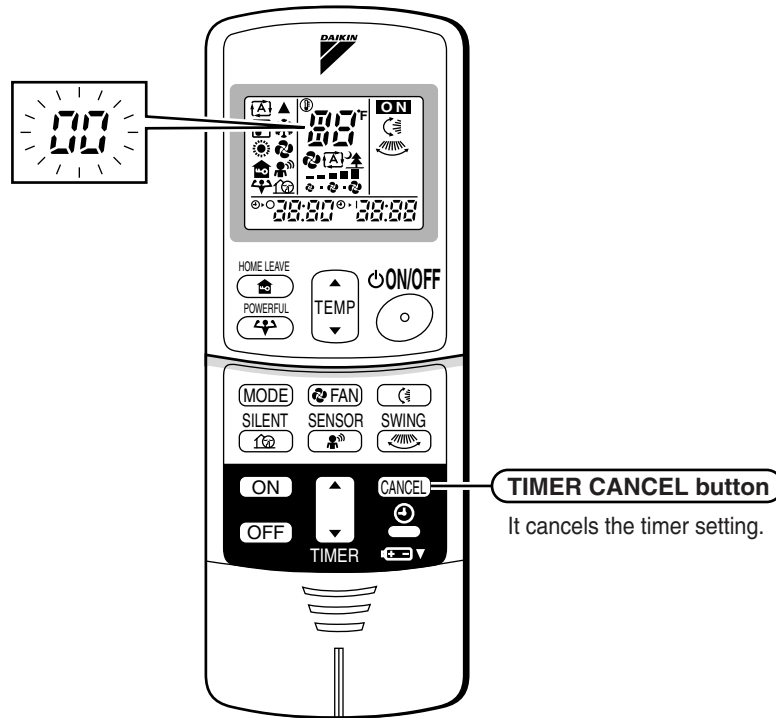

2. Press the **TIMER CANCEL** button repeatedly until a continuous beep is produced.

- The code indication changes as shown below, and notifies with a long beep.

	CODE	MEANING
SYSTEM	00	NORMAL
	U0	REFRIGERANT SHORTAGE
	U2	DROP VOLTAGE OR MAIN CIRCUIT OVERVOLTAGE
	U4	FAILURE OF TRANSMISSION (BETWEEN INDOOR UNIT AND OUTDOOR UNIT)
INDOOR UNIT	A1	INDOOR PCB DEFECTIVENESS
	A5	HIGH PRESSURE CONTROL OR FREEZE-UP PROTECTOR
	A6	FAN MOTOR FAULT
	C4	FAULTY HEAT EXCHANGER TEMPERATURE SENSOR
	C9	FAULTY SUCTION AIR TEMPERATURE SENSOR
OUTDOOR UNIT	EA	COOLING-HEATING SWITCHING ERROR
	E5	OL STARTED
	E6	FAULTY COMPRESSOR START UP
	E7	DC FAN MOTOR FAULT
	E8	OPERATION HALT DUE TO DETECTION OF INPUT OVER CURRENT
	F3	HIGH TEMPERATURE DISCHARGE PIPE CONTROL
	H6	OPERATION HALT DUE TO FAULTY POSITION DETECTION SENSOR
	H8	CT ABNORMALITY
	H9	FAULTY SUCTION AIR TEMPERATURE SENSOR
	J3	FAULTY DISCHARGE PIPE TEMPERATURE SENSOR
	J6	FAULTY HEAT EXCHANGER TEMPERATURE SENSOR
	L4	HIGH TEMPERATURE AT INVERTER CIRCUIT HEATSINK
	L5	OUTPUT OVERCURRENT
P4	FAULTY INVERTER CIRCUIT HEATSINK TEMPERATURE SENSOR	

## NOTE

1. A short beep and two consecutive beeps indicate non-corresponding codes.
2. To cancel the code display, hold the **TIMER CANCEL** button down for 5 seconds. The code display also cancel itself if the button is not pressed for 1 minute.

# **DAIKIN INDUSTRIES, LTD.**

Head office:

Umeda Center Bldg., 4-12, Nakazaki-Nishi 2-chome,  
Kita-ku, Osaka, 530-8323 Japan

Tokyo office:

JR Shinagawa East Bldg., 18-1, Konan  
2-chome, Minato-ku, Tokyo, 108-0075 Japan  
<http://www.daikin.com/global/>

## Free Manuals Download Website

<http://myh66.com>

<http://usermanuals.us>

<http://www.somanuals.com>

<http://www.4manuals.cc>

<http://www.manual-lib.com>

<http://www.404manual.com>

<http://www.luxmanual.com>

<http://aubethermostatmanual.com>

Golf course search by state

<http://golfingnear.com>

Email search by domain

<http://emailbydomain.com>

Auto manuals search

<http://auto.somanuals.com>

TV manuals search

<http://tv.somanuals.com>