



# BACnet<sup>®</sup> Option Module Instruction Manual

---

## TR200



---

November 2009

BAS-SVX24B-EN

# Table of Contents

<b>Safety</b> .....	1-1
Copyright, limitation of liability and revision rights .....	1-1
High Voltage Warning.....	1-3
Before Commencing Repair Work.....	1-8
Special Conditions.....	1-8
<b>Introduction</b> .....	2-1
Introduction.....	2-1
<b>How to Install</b> .....	3-1
The BACnet Option.....	3-1
System Specifications.....	3-5
<b>How to Configure the System</b> .....	4-1
Configuring BACnet.....	4-1
BIBBs.....	4-2
Example of a simple set-up of BACnet.....	4-3
<b>How to Control the Adjustable Frequency Drive</b> .....	5-1
Network Adjustable Frequency Drive Control Inputs and Outputs.....	5-2
Adjustable Frequency Drive Feedback to Network.....	5-15
<b>Parameters</b> .....	6-1
Parameter Overview.....	6-1
Parameter Description.....	6-2
<b>Troubleshooting</b> .....	7-1
Alarm, Warning and Extended Status Word.....	7-1
Alarm Words.....	7-2
Warning Words.....	7-3



LED Status..... 7-4

# Safety

## Copyright, limitation of liability and revision rights

This publication contains information proprietary to Trane. By accepting and using this manual, the user agrees that the information contained herein will be used solely for operating equipment from Trane or equipment from other vendors provided that such equipment is intended for communication with Trane equipment over a serial communication link. This publication is protected under the copyright laws of most countries.

Trane does not warrant that a software program produced according to the guidelines provided in this manual will function properly in every physical, hardware or software environment.

Although Trane has tested and reviewed the documentation within this manual, Trane makes no warranty or representation, neither expressed nor implied, with respect to this documentation, including its quality, performance, or fitness for a particular purpose.

In no event shall Trane be liable for direct, indirect, special, incidental, or consequential damages arising out of the use, or the inability to use information contained in this manual, even if advised of the possibility of such damages. In particular, Trane is not responsible for any costs, including but not limited to those incurred as a result of lost profits or revenue, loss or damage of equipment, loss of computer programs, loss of data, the costs to substitute these, or any claims by third parties.

Trane reserves the right to revise this publication at any time and to make changes to its contents without prior notice or any obligation to notify former or present users of such revisions or changes.

## Warnings, Cautions and Notices

Note that warnings, cautions and notices appear at appropriate intervals throughout this manual. Warnings are provided to alert installing contractors to potential hazards that could result in personal injury or death. Cautions are designed to alert personnel to hazardous situations that could result in personal injury, while notices indicate a situation that could result in equipment or property damage-only accidents.

Your personal safety and the proper operation of this machine depend upon the strict observance of these precautions.

Warnings, Cautions and Notices appear at appropriate sections throughout this literature. Read these carefully.

### **WARNING**

Indicates a potentially hazardous situation which, if not avoided, could result in death or serious injury.

### **CAUTION**

Indicates a potentially hazardous situation which, if not avoided, could result in minor or moderate injury. It could also be used to alert against unsafe practices.

### **NOTE**

Indicates a situation that could result in equipment or property damage-only accidents.

#### Note

Indicates something important to be noted by the reader.



Indicates default setting

## High Voltage Warning

### WARNING

The voltage of the adjustable frequency drive is dangerous whenever it is connected to line power. Incorrect installation of the motor or adjustable frequency drive could result in death, serious injury or damage to the equipment. Consequently, it is essential to comply with the instructions in this manual as well as local and national rules and safety regulations.

## Safety Note

### WARNING

The voltage of the adjustable frequency drive is dangerous whenever connected to line power. Incorrect installation of the motor, adjustable frequency drive or serial communication bus could result in death, serious personal injury or damage to the equipment. Consequently, the instructions in this manual, as well as national and local rules and safety regulations, must be complied with.

### WARNING

Failure to follow instructions below could result in death or serious injury.

#### **Safety Regulations**

1. The adjustable frequency drive must be disconnected from line power if repair work is to be carried out. Make sure that the line power supply has been disconnected and that the necessary time has passed before removing motor and line power plugs.
2. The [STOP/RESET] key on the keypad of the adjustable frequency drive does not disconnect the equipment from line power and is thus not to be used as a safety switch.
3. Correct protective grounding of the equipment must be established, the user must be protected against supply voltage, and the motor must be protected against overload in accordance with applicable national and local regulations.
4. The ground leakage currents are higher than 3.5 mA.
5. Protection against motor overload is set by par.1-90 [Motor Thermal Protection](#). If this function is desired, set par.1-90 [Motor Thermal Protection](#) to data value [ETR trip] (default value) or data value [ETR warning]. Note: The function is initialized at 1.16 x rated motor current and rated motor frequency. For the North American market: The ETR functions provide class 20 motor overload protection in accordance with NEC.
6. Do not remove the plugs for the motor and line power supply while the adjustable frequency drive is connected to line power. Make sure that the line power supply has been disconnected and that the necessary time has passed before removing motor and line power plugs.
7. Please note that the adjustable frequency drive has more voltage inputs than L1, L2 and L3, when load sharing (linking of DC intermediate circuit) and external 24 Vdc have been installed. Make sure that all voltage inputs have been disconnected and that the necessary time has passed before commencing repair work.

## Installation at high altitudes

### WARNING

Installation at high altitude:

380–500 V, enclosure A, B and C: At altitudes above 6,561 ft [2 km], please contact Trane regarding PELV/Class II.

380–500 V, enclosure D, E and F: At altitudes above 9,842 ft [3 km], please contact Trane regarding PELV/Class II.

If the drive is to be installed over 6,561 ft [2 km] altitude, then the PELV specifications are not fulfilled anymore, i.e., the distances between components and critical parts become too small. To maintain the clearance for functional insulation anyway, the risk for overvoltage must be reduced by means of external protective devices or some kind of galvanic isolation. De-rating should also be taken into consideration, since cooling the drive is more difficult at high altitude.

Please contact Trane in such cases.

Failure to follow recommendations could result in death or serious injury.

### WARNING

Warning against Unintended Start

1. The motor can be brought to a stop by means of digital commands, bus commands, references or a local stop, while the adjustable frequency drive is connected to line power. If personal safety considerations make it necessary to ensure that no unintended start occurs, these stop functions are not sufficient.
2. While parameters are being changed, the motor may start. Consequently, the stop key [STOP/RESET] must always be activated, following which data can be modified.
3. A motor that has been stopped may start if faults occur in the electronics of the adjustable frequency drive, or if a temporary overload or a fault in the supply line power or the motor connection ceases.

Consequently, disconnect all electric power, including remote disconnects before servicing. Follow proper lockout/tagout procedures to ensure the power cannot be inadvertently energized. Failure to follow recommendations could result in death or serious injury.

### WARNING

Touching the electrical parts could result in death or serious injury - even after the equipment has been disconnected from line power.

Also make sure that other voltage inputs have been disconnected, such as external 24 VDC, load sharing (linkage of DC intermediate circuit), as well as the motor connection for kinetic backup. Refer to the Instruction Manual for further safety guidelines.

Failure to follow recommendations could result in death or serious injury.

### WARNING

The adjustable frequency drive DC link capacitors remain charged after power has been disconnected. To avoid an electrical shock hazard, disconnect the adjustable frequency drive from line power before carrying out maintenance. Wait at least as follows before doing service on the adjustable frequency drive:

Failure to follow recommendations could result in death or serious injury.

Voltage (V)	Min. Waiting Time (Minutes)				
	4	15	20	30	40
200 - 240	1.5-5 hp [1.1-3.7 kW]	7.5-60 hp [5.5 -45 kW]			
380 - 480	1.5-10 hp [1.1-7.5 kW]	15-125 hp [11-90 kW]	150-350 hp [110-250 kW]		450-1350 hp [315-1000 kW]
525-600	1.5-10 hp [1.1-7.5 kW]	15-125 hp [11-90 kW]			
525-690		15-125 hp [11-90 kW]	60-550 hp [45-400 kW]	600-1875 hp [450-1400 kW]	

Be aware that there may be high voltage on the DC link even when the LEDs are turned off.



## Safety Precautions

### WARNING

The voltage of the adjustable frequency drive is dangerous whenever connected to line power. Incorrect installation of the motor, adjustable frequency drive or serial communication bus could cause death, serious personal injury or damage to the equipment. Consequently, the instructions in this manual, as well as national and local rules and safety regulations, must be complied with.

### WARNING

#### Safety Regulations

1. The line power supply to the adjustable frequency drive must be disconnected whenever repair work is to be carried out. Make sure that the line power supply has been disconnected and that the necessary time has elapsed before removing motor and line power supply plugs.
2. The [OFF] button on the control panel of the adjustable frequency driver does not disconnect the line power supply and consequently it must not be used as a safety switch.
3. The equipment must be properly grounded, the user must be protected against supply voltage and the motor must be protected against overload in accordance with applicable national and local regulations.
4. The ground leakage current exceeds 3.5 mA.
5. Protection against motor overload is not included in the factory setting. If this function is desired, set par. 1-90 [Motor Thermal Protection](#) to data value ETR trip 1 [4] or data value ETR warning 1 [3].
6. Do not remove the plugs for the motor and line power supply while the adjustable frequency drive is connected to line power. Make sure that the line power supply has been disconnected and that the necessary time has elapsed before removing motor and line power plugs.
7. Please note that the adjustable frequency drive has more voltage sources than L1, L2 and L3, when load sharing (linking of DC intermediate circuit) or external 24 V DC are installed. Make sure that all voltage sources have been disconnected and that the necessary time has elapsed before commencing repair work.

Failure to follow recommendations could result in death or serious injury.

### WARNING

#### Warning against unintended start

1. The motor can be brought to a stop by means of digital commands, bus commands, references or a local stop, while the adjustable frequency drive is connected to line power. If personal safety considerations (e.g., risk of personal injury caused by contact with moving machine parts following an unintentional start) make it necessary to ensure that no unintended start occurs, these stop functions are not sufficient. In such cases, the line power supply must be disconnected or the **Safe Stop** function must be activated.
2. The motor may start while setting the parameters. If this means that personal safety may be compromised (e.g., personal injury caused by contact with moving machine parts), motor starting must be prevented, for instance by use of the **Safe Stop** function or secure disconnection of the motor connection.
3. A motor that has been stopped with the line power supply connected, may start if faults occur in the electronics of the adjustable frequency drive, through temporary overload or if a fault in the power supply grid or motor connection is remedied. If unintended start must be prevented for personal safety reasons (e.g., risk of injury caused by contact with moving machine parts), the normal stop functions of the adjustable frequency drive are not sufficient. In such cases, the line power supply must be disconnected or the **Safe Stop** function must be activated.

Consequently, disconnect all electric power, including remote disconnects before servicing. Follow proper lockout/tagout procedures to ensure the power cannot be inadvertently energized. Failure to follow recommendations could result in death or serious injury.

Disconnect all electric power, including remote disconnects before servicing. Follow proper lockout/tagout procedures to ensure the power cannot be inadvertently energized. Failure to follow recommendations could result in death or serious injury.

1. Control signals from, or internally within, the adjustable frequency drive may in rare cases be activated in error, be delayed or fail to occur entirely. When used in situations where safety is critical, e.g., when controlling the electromagnetic brake function of a hoist application, these control signals must not be relied on exclusively.

Note

When using the *Safe Stop* function, always follow the instructions in the *Safe Stop* section of the Design Guide.

## WARNING

Disconnect all electric power, including remote disconnects. Follow proper lockout/tagout procedures to ensure the power cannot be inadvertently energized. Use an appropriate voltmeter to verify that the unit is discharged. Failure to disconnect power and ensure unit is discharged before servicing could result in death or serious injury.

Also make sure that other voltage inputs have been disconnected, such as external 24 V DC, load sharing (linkage of DC intermediate circuit), as well as the motor connection for kinetic backup.

Systems where adjustable frequency drives are installed must, if necessary, be equipped with additional monitoring and protective devices according to the valid safety regulations, e.g., law on mechanical tools, regulations for the prevention of accidents, etc. Modifications on the adjustable frequency drives by means of the operating software are allowed.

Failure to follow recommendations could result in death or serious injury.

Hoisting applications:

The adjustable frequency drive functions for controlling mechanical brakes cannot be considered as a primary safety circuit. There must always be a redundancy for controlling external brakes.

## Protection Mode

Once a hardware limit on motor current or DC link voltage is exceeded, the drive will enter "Protection mode". "Protection mode" means a change of the PWM modulation strategy and a low switching frequency to minimize losses. This continues 10 sec after the last fault and increases the reliability and the robustness of the drive while re-establishing full control of the motor.

In hoist applications, "Protection mode" is not usable because the drive will usually not be able to leave this mode again, and therefore it will extend the time before activating the brake – which is not recommended.

"Protection mode" can be disabled by setting par.14-26 [Trip Delay at Inverter Fault](#) to zero, which means that the drive will trip immediately if one of the hardware limits is exceeded.

Note

It is recommended to disable protection mode in hoisting applications (par.14-26 [Trip Delay at Inverter Fault](#) = 0).

## Before Commencing Repair Work

### **WARNING**

#### Hazardous Voltage!

1. Disconnect the adjustable frequency drive from line power.
2. Disconnect DC bus terminals 88 and 89
3. Wait at least the time mentioned above in the section General Warning.
4. Remove motor cable

Failure to follow recommendations could result in death or serious injury.

## Special Conditions

### **Electrical ratings:**

The rating indicated on the nameplate of the adjustable frequency drive is based on a typical 3-phase line power supply within the specified voltage, current and temperature ranges, which are expected to be used in most applications.

The adjustable frequency drives also support other special applications, which affect the electrical ratings of the adjustable frequency drive.

Special conditions that affect the electrical ratings might be:

- Single phase applications.
- High temperature applications that require derating of the electrical ratings.
- Marine applications with more severe environmental conditions.

Other applications might also affect the electrical ratings.

Consult the relevant sections in this manual and in the for information about the electrical ratings.

### **Installation requirements:**

The overall electrical safety of the adjustable frequency drive requires special installation considerations regarding:

- Fuses and circuit breakers for overcurrent and short-circuit protection
- Selection of power cables (line power, motor, brake, load sharing and relay)
- Grid configuration (grounded delta transformer leg, IT, TN, etc.)
- Safety of low-voltage ports (PELV conditions).

Consult the relevant clauses in these instructions and in the for information about the installation requirements.

# Introduction

## Introduction

### About this Manual

First time users can obtain the most essential information for quick installation and set-up in these chapters:

- Introduction
- How to Install
- How to Configure the System
- Application Example

For more detailed information including the full range of set-up options and diagnosis tools, refer to the chapters:

- How to Control the TR200
- How to Access TR200 Parameters
- Parameters
- Troubleshooting

## Technical Overview

BACnet (Building Automation and Control Network) is an open data communications protocol, American National Standard (ANSI/ASHRAE 135-1995). BACnet provides a means by which computer-based control equipment from different manufacturers can work together. BACnet is designed to handle many types of building controls, including HVAC, lighting, security, fire, access control, maintenance and waste management. BACnet permits flexibility for expansion and different equipment combinations.

Conformance Classes, Function Groups and the PICS: Evaluating the capabilities of a BACnet device is potentially a formidable task, given the great choice of objects, properties and services, which can be implemented, as well as the fact that it is not necessary for every BACnet device to have a full BACnet implementation in order to carry out its task. ASHRAE's BACnet Committee recognized this problem and responded with aids to evaluation in the form of "Conformance Classes", "Function Groups" and the "Protocol Implementation Conformance Statement" (PICS).

The BACnet protocol defines six levels of conformance classes, each of which specifies the minimum subset of services implemented on the device. The lowest level, Conformance Class 1, requires only that the BACnet device contain a device object and that it be able to execute (respond to) a ReadProperty service request. Each successive conformance class level adds service requests that must be executable by the device, as well as the service requests it must be able to initiate. Conformance Class 6 requires 21 types of service requests (of the 32 overall) to be implemented, of which 20 must be initiatable and 17 executable. Conformance class thus provides a measure of the device's ability to communicate.

Function groups specify a combination of objects and services necessary to carry out certain building automation functions. They are specified independently of conformance class, though the implementation of some of the function groups automatically confers some conformance class higher than 1.

**Background information**

Protocol name:	BACnet
Technology developer:	ASHRAE
Year introduced:	1995
Governing standards:	ANSI/ASHRAE Standard 135-2004, ISO 16484-5
Openness:	Open specification

**Physical characteristics**

Network topology:	Bus
Physical media:	Shielded twisted pair
Max. Distance at low speed:	3937 ft [1200 m]

**Transport mechanism**

Communication methods:	Master/slave
Baud Rates Supported:	9600, 19200, 38400, 76800
Termination:	120 ohm

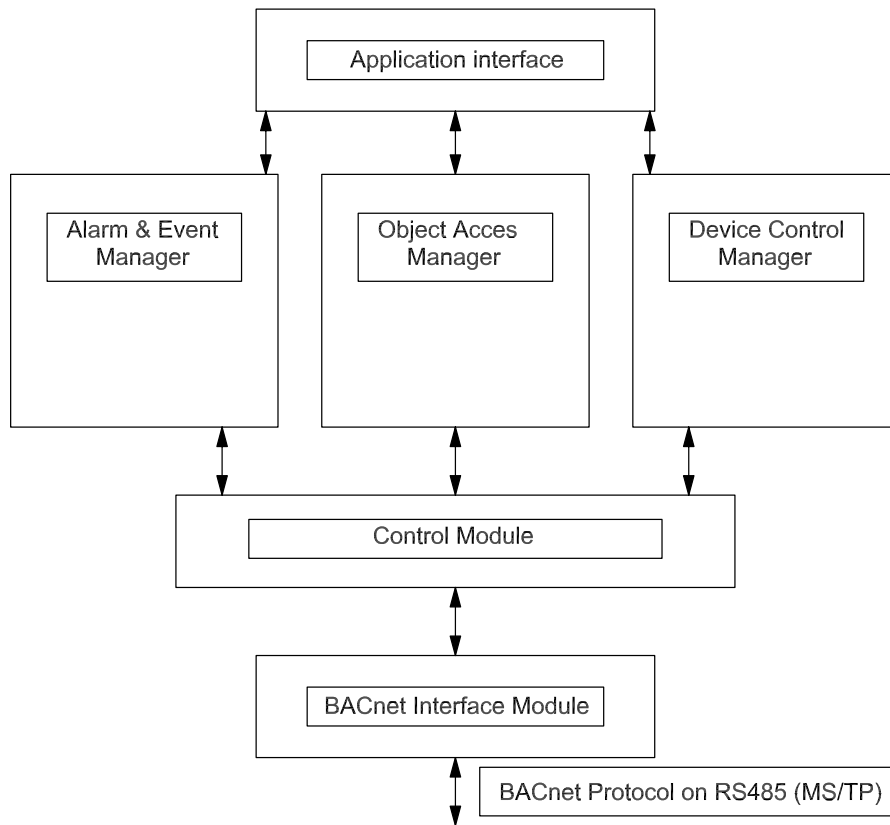

130BAG69.10

## Assumptions

This manual assumes you are using a Trane BACnet Option Card in conjunction with a Trane TR200 series adjustable frequency drive. It is also assumed that your master is a BMS or PC equipped with a serial communication card supporting all the BACnet communication services required by your application, and that all requirements stipulated in the BACnet standard, as well as those pertaining to the Variable Frequency Drive are strictly observed as well as all limitations therein fully respected.

## Background Knowledge

The Trane BACnet Option Card is designed to communicate with any master complying with the BACnet standard. Familiarity with the PC or PLC used as a master in the system is assumed. Issues regarding hardware or software produced by other manufacturers are beyond the scope of this manual and are not the responsibility of Trane.

If you have questions regarding set-up of master-to-master communication or communication to a non-Trane slave, consult the appropriate manuals.

## Available Literature for TR200

- The Instruction Manual provides the necessary information for getting the drive up and running.
- Instruction Manual TR200 High Power
- The Design Guide contains all the technical information about the drive and customer design and applications.
- The Programming Guide provides information on how to program and includes complete parameter descriptions.

x = Revision number

yy = Language code

Trane technical literature is available in print from your local Trane Sales Office or online at: [www.trane.com/vfd](http://www.trane.com/vfd)

## Abbreviations

ACI	Acyclical Control Interval	PCD	Process Data
AOC	Application Orientated Controller	PCA	Parameter Characteristics
AV	Analog Variable	PCV	Parameter-Characteristics-Value
BMS	Building Management System	PDU	Protocol Data Unit
BV	Binary Variable	PELV	Protected Extra Low Voltage
CAN	Controller Area Network	PLC	Programmable Logic Control
CTW	Control Word	PNU	Parameter Number
EE-PROM	Electrical Erasable Programmable Read Only Memory	PVA	Parameter Value
EIA	Electronic Industries Association: Specifies of the EIA Standard RS 485-A	RC	Request/Response Characteristics
EMC	Electromagnetic Compatibility	STW	Status Word
FDL	Serial Communication Bus Data link Layer		
FDT	Field Device Tool		
IND	Sub index		
I/O	Input/Output		
ISO	International Standards Organization		
LCD	Liquid Crystal Display		
keypad	Local Control Panel		
LED	Light Emitting Diode		
MAV	Main Actual Value		
MOC	Motion Orientated Controller		
MRV	Main Reference Value		
PC	Personal Computer		

# How to Install

## The BACnet Option

### Installation of the Option

Items required to install a serial communication bus option in the adjustable frequency drive:

- The serial communication bus option
- Serial communication bus option adaptor frame for the adjustable frequency drive. This frame is deeper than the standard frame, to allow space for the serial communication bus option beneath.
- Cable holders

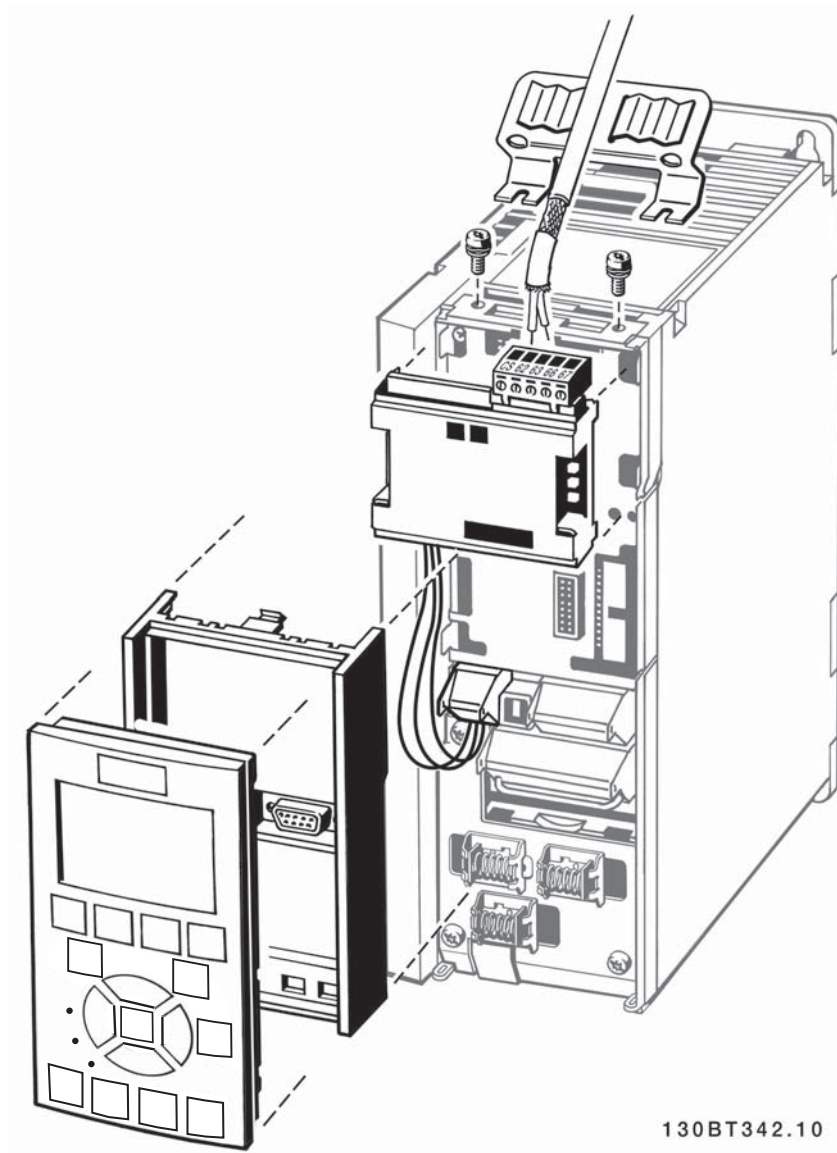



## Instructions:

- Remove the keypad panel from the adjustable frequency drive.
- Remove the frame located beneath and discard.
- Push the option into place. Two positions are possible, with cable terminal facing either up or down. The cable up position is often most suitable when several adjustable frequency drives are installed side by side in a rack, as this position permits shorter cable lengths.
- Push the serial communication bus option adaptor frame for the adjustable frequency drive into place.
- Remove the plug for the Drive port and connect the plug that is connected to the BACnet option
- Replace the keypad panel.
- Attach cable.
- Fasten the cable in place using cable holders. The adjustable frequency drive top surface has pre-drilled threaded holes for attaching the cable holders to the unit.

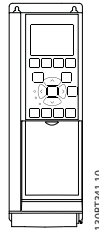

## Cabling

### Cable lengths and number of nodes

The maximum cable length allowable in one segment is dependent on the transmission speed. The total cable length includes drop cables if any. A drop cable is the connection from the main bus cable to each node. If a T-connection is used, permissible cable length and maximum number of nodes/drives are 1, 2, 3 and 4 bus segments.

Drop cable connection (i.e., T-connection) beyond the cable lengths indicated is not recommended, due to the increased risk of reflection occurring. Instead, Trane recommends direct connection of the adjustable frequency drive.

Note that a repeater is a node in both of the two segments it connects. The number of adjustable frequency drives is based on a single master system. If there are two or more masters (e.g., PC tools, routers), the number of adjustable frequency drives must be reduced correspondingly.

<b>Network topology</b>	<b>Maximum cable length</b>
Free topology without repeater	1640 ft [500 m]
Free topology with one repeater	3280 ft [1000 m]
Free topology maximum device-to-device	1640 ft [500 m]
Bus topology single terminated	1640 ft [500 m]
Bus topology double terminated without repeater	8858 ft [2700 m]
Bus topology double terminated with one repeater	17716 ft [5400 m]
Bus topology maximum stub length	9.8 ft [3 m]

The length statements in the tables above are valid for bus cable with the following properties:

- Impedance: 135 to 165 Ohm at a measuring frequency from 3 to 20 MHz
- Resistance: <110 Ohm/km
- Capacitance: <30 pF/m
- Damping: max. 9 dB over the whole wire length
- Cross section: max. 0.00053 in<sup>2</sup> [0.34 mm<sup>2</sup>], corresponding to AWG 22
- Cable type: twisted in pairs, 1 x 2, or 2 x 2, or 1 x 4 wires
- Shielding: Copper-braided shield or braided shield and foil shield

Use of the same cable type throughout the entire segment is recommended to avoid impedance mismatch.

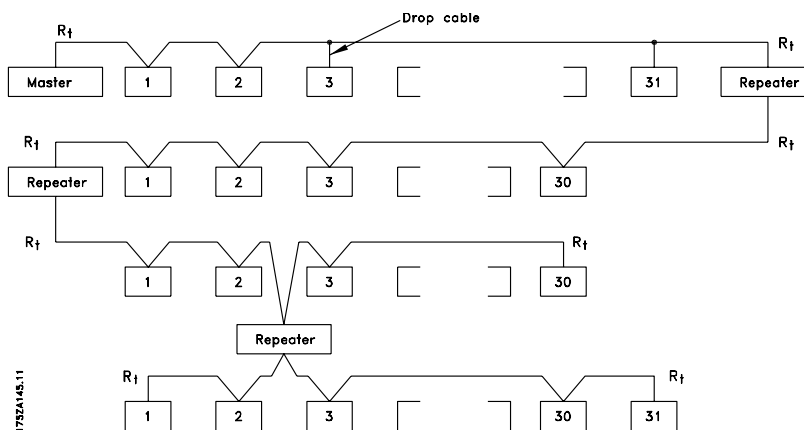

## Network Termination

### Connecting the Bus Line

Connect the BACnet Option Card to the bus line via terminals 62, 63 and 66. Terminal 62 is marked red and Terminal 63 is marked green. These two are the RS485 lines. Terminal 66 the signal ground for the RS485 transmitter.

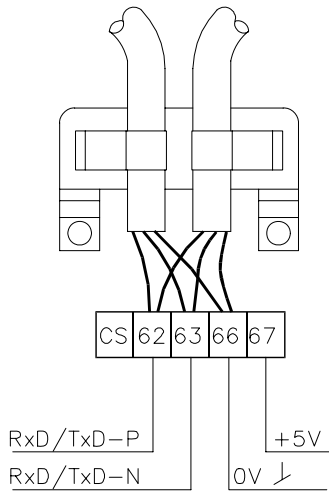

130BA671.10

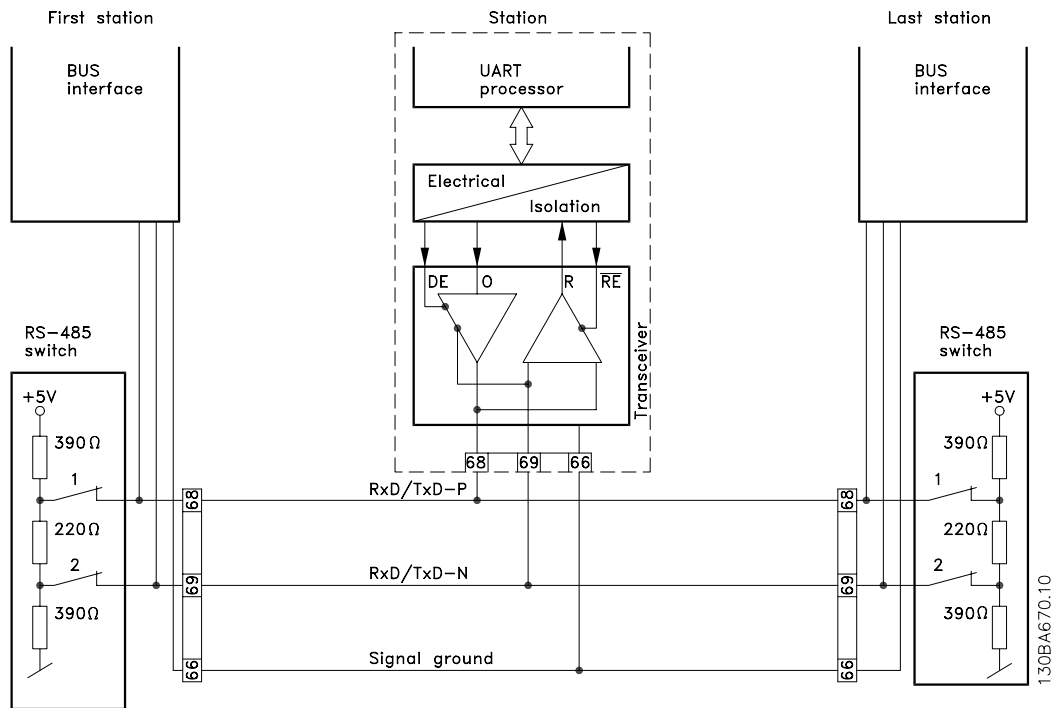

130BA670.10

### Maximum Cable Lengths

Maximum total bus cable length: 4000 ft [1200 m]

## Cable Routing

The BACnet communication cable must be kept away from motor and brake resistor cables to avoid coupling of high frequency noise from one cable to the other. Normally a distance of 7.9 in (200 mm) is sufficient, but maintaining the greatest possible distance between cables is generally recommended, especially where cables run in parallel over long distances.

When crossing is unavoidable, the BACnet cable must cross motor and brake resistor cables at an angle of 90 degrees.

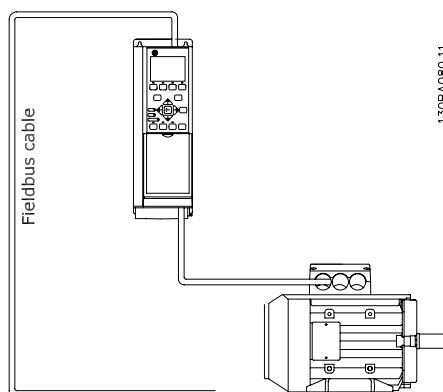

## System Specifications

### EMC Precautions

The following EMC precautions are recommended to achieve interference-free operation of the BACnet network. Additional EMC information is available in the *TR200 Drive Design Guide*. Also consult the BACnet master manual for further installation guidelines.

### NOTE

Ensure compliance with relevant national and local regulations, for example in protective ground connection.

### Connection of the Cable Shield

It is recommended to connect the shield to ground at both ends of the bus cable. This ensures the optimum resistance towards EMC noise. The shield of the BACnet cable must always be connected to ground at both ends, meaning the shield must be connected to ground in all stations connected to the BACnet network. It is very important to have a low impedance ground connection of the shield, also at high frequencies. This can be obtained by connecting the surface of the shield to ground, for example by means of a cable clamp or a conductive cable connector. The TR200 Series has various clamps and brackets to enable a proper ground connection of the BACnet cable shield.



### Ground Connection

It is important that all stations connected to the BACnet network are connected to the same ground potential. The ground connection must have low HF (high frequency) impedance. This can be achieved by connecting a large surface area of the cabinet to ground, for example by mounting the TR200 series on a conductive rear plate. Particularly when there are long distances between the stations in a BACnet network, it may be necessary to use additional potential equalizing cables, connecting the individual stations to the same ground potential. The use of repeaters with galvanic isolation or fiber optic can improve the EMC performance and reduce ground loop current.

# How to Configure the System

## Configuring BACnet

### Initialization Procedure

The Initialization Procedure is explained by the flow chart given below:

### Initialization Parameter

#### General Settings

<b>Name</b>	<b>Par. Number</b>	<b>Default Value</b>	<b>Setting for BACnet</b>
Control Site	8-01	Digital and control word	Digital and control word
Control word source	8-02	Drive RS-485	Drive RS-485
ControlWord Timeout time	8-03	1.0 sec	1.0 sec
ControlWord Timeout Function	8-04	Off	Off
End of Timeout Function	8-05	Resume set-up	Resume set-up
Reset ControlWord Timeout	8-06	Do not reset	Do not reset
Diagnosis	8-07	Set-up	Don't care
ControlWord Profile	8-10	Drive Profile	Drive Profile

#### Drive Port Settings

<b>Name</b>	<b>Par. Number</b>	<b>Default Value</b>	<b>Setting for BACnet</b>
Protocol	8-30	Drive	Drive Option
Address	8-31	1	1
Baud Rate	8-32	9600 baud	9600 baud
Minimum Response Delay	8-35	10 ms	10 ms
Max Response Delay	8-36	5000 ms	5000 ms

Table 4. 1: 1) Please see also section: Parameter Overview >Parameter List.

### Digital/Bus settings

Name	Par. Number	Default Value	Setting for BACnet
Coasting Select	8-50	Logic-or	Logic-or
Quick Stop Select	8-51	Logic-or	Logic-or
DC Brake Select	8-52	Logic-or	Logic-or
Start Select	8-53	Logic-or	Logic-or
Reversing Select	8-54	Logic-or	Logic-or
Set-up Select	8-55	Logic-or	Logic-or
Preset reference Select	8-56	Logic-or	Logic-or

### BACnet settings

Name	Par. Number	Default Value	Setting for BACnet
BACnet device instance	8-71	1	1
MS/TP Max Masters	8-73	127	Depent on the Number of Masters in the system
"I am" Service	8-74	At power-up	At power-up
Initialization Password	8-75	"admin"	"admin"

### Control Word Timeout Function

par.8-03 [Control Timeout Time](#) and par.8-04 [Control Timeout Function](#) are not enabled in this version of the BACnet option.

### BIBBs

#### Bibb's

- ReadProperty Service
- ReadPropertyMultiple Service
- WriteProperty Service
- WritePropertyMultiple Service
- ConfirmedEventNotification Service
- UnconfirmedEventNotification Service
- GetEventInformation Service
- AcknowledgeAlarm Service
- ReinitializeDevice Service
- DeviceCommunicationControl Service
- I-Have Service
- Who-Has Service
- Who-Is Service
- I-am Service
- TimeSynchronization

## Example of a simple set-up of BACnet

This example shows the necessary steps to set up the TR200 BACnet interface with the following system requirements:

- MS/TP running at 38,400 baud
- MAC address 20 for the TR200
- BACnet Device Instance 0 1025
- Highest number of a master stack is 35
- Start/stop of drive from BACnet only
- Reference from BACnet
- Read status of drive (actual speed)

Set the following parameters:

<b>Name</b>	<b>Par. number</b>	<b>Value</b>
Protocol	8-30	Drive option [9]
Address	8-31	20
Drive Port Baud Rate	8-32	38,400 Baud [4]
Coasting Select	8-50	Bus [1]
BACnet device instance	8-70	1025
MS/TP Max Masters	8-72	35

After the parameters have been set according to the table above, the drive has to be unpowered and repowered before the changes take effect. When the adjustable frequency drive is detected by the BMS, the drive can be controlled by BV:1, which will start the motor if set to [1]. Setting AV:0 will set the speed reference of the drive. The actual speed can be monitored via AV:1. See also *Analog Input and Output Objects* section.





## How to Configure the System

---

# How to Control the Adjustable Frequency Drive

## Reference Handling

Select the adjustable frequency drive configuration mode in par.1-00 [Configuration Mode](#).

- [0] Open-loop
- [3] Closed-loop

## Open-loop

For open-loop operation, the reference represents the desired output speed of the adjustable frequency drive. The speed reference value:

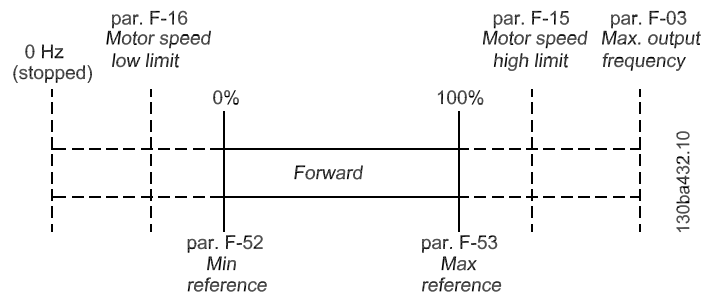

## Closed-loop

For closed-loop operation, the reference represents the setpoint.

## NOTE

In closed-loop operation, par.3-02 [Minimum Reference](#) and par.4-12 [Motor Speed Low Limit \[Hz\]](#) must be set to 0 Hz. Set the par.4-14 [Motor Speed High Limit \[Hz\]](#) to a value greater than the setting in par.3-03 [Maximum Reference](#).

## Network Adjustable Frequency Drive Control Inputs and Outputs

### Analog Input and Output Objects

Control the adjustable frequency drive from the BACnet network using 'objects'. The various types of 'objects' and their descriptions are shown in the following tables.

Object ID	Object Name	Read/Write	Changeable Description	Non-volatile RAM Store	Drive Par.	Alarm notification	Triggers bus timeout
AI:0	Analog Input 53	R	Yes	No	16-62	Yes	NO
AI:1	Analog Input 54	R	Yes	No	16-64	Yes	NO
AI:2	Analog In X30/11	R	Yes	No	16-75	Yes	NO
AI:3	Analog In X30/12	R	Yes	No	16-76	Yes	NO
AI:4	Analog Input X42/1	R	Yes	No	18-30	Yes	NO
AI:5	Analog Input X42/3	R	Yes	No	18-31	Yes	NO
AI:6	Analog Input X42/5	R	Yes	No	18-32	Yes	NO

Table 5. 1: Analog inputs

Object ID	Object Name	Read/Write	Changeable Description	Non-volatile RAM Store	Linked to TR200Parameter	Alarm notification	Triggers Bus Timeout
AO:0	Terminal 42 Output Bus Control	W/R	Yes	No	6-53	No	Yes
AO:1	Pulse out #27 Bus Control	W/R	Yes	No	5-93	No	Yes
AO:2	Pulse out #29 Bus Control	W/R	Yes	No	5-95	No	Yes
AO:3	Analog Out X30/8 [mA]	W/R	Yes	No	6-63	No	Yes
AO:4	Analog Output X42/7[V]	W/R	Yes	No	26-43	No	Yes
AO:5	Analog Output X42/9[V]	W/R	Yes	No	26-53	No	Yes
AO:6	Analog Output X42/11[V]	W/R	Yes	No	26-63	No	Yes

Table 5. 2: Analog outputs

Object ID	Object Name	Read/Write	Changeable Description	Non-volatile RAM Store	TR200Parameter	Alarm notification	Triggers Bus Timeout
AV:0	Reference	W/R	Yes	No	MRV	No	Yes
AV:1	Speed Act. Value	W/R	Yes	No	MAV	Yes	Yes
AV:2	Bus Feedback1	W/R	Yes	No	8-94	No	Yes
AV:3	Bus Feedback2	W/R	Yes	No	8-95	No	Yes
AV:4	Bus Feedback3	W/R	Yes	No	8-96	No	Yes
AV:5	Motor Voltage	Read	Yes	No	16-12	Yes	No
AV:6	Motor Current	Read	Yes	No	16-14	Yes	No
AV:7	Motor Torque %	Read	Yes	No	16-22	Yes	No
AV:8	DC Link Voltage	Read	Yes	No	16-30	Yes	No
AV:9	Motor Thermal	Read	Yes	No	16-18	Yes	No
AV:10	Heatsink Temperature	Read	Yes	No	16-34	Yes	No
AV:11	Inverter Thermal	Read	Yes	No	16-35	Yes	No
AV:12	Operating Hours	Read	No	No	15-00	No	No
AV:13	Running Hours	Read	No	No	15-01	No	No
AV:14	KWh Counter	Read	No	No	15-02	No	No
AV:15	Power [KW]	Read	No	No	16-10	No	No
AV:16	PID Start Speed [Hz]	W/R	No	TR200	20-83	No	No
AV:17	PID Proportional Gain	W/R	No	TR200	20-93	No	No
AV:18	PID Integral Time (Sec)	W/R	No	TR200	20-94	No	No
AV:19	PID Differential Time (Sec)	W/R	No	TR200	20-95	No	No
AV:20	PID Dif. Gain Limit	W/R	No	TR200	20-96	No	No
AV:21	On Reference Bandwidth	W/R	No	TR200	20-84	No	No
AV:22	Ext. 1 Setpoint	W/R	No	TR200	21-15	No	No
AV:23	Ext. 1 Reference [Unit]	W/R	No	TR200	21-17	No	No
AV:24	Ext. 1 Feedback [Unit]	W/R	No	TR200	21-18	No	No
AV:25	Ext. 1 Proportional Gain	W/R	No	TR200	21-21	No	No
AV:26	Reserved	W/R	No	Na			
AV:27	Ext. 1 Integral Time (Sec)	W/R	No	TR200	21-22	No	No
AV:28	Ext. 1 Differential Time (Sec)	W/R	No	TR200	21-23	No	No
AV:29	Ext. 1 Dif. Gain Limit	W/R	No	TR200	21-24	No	No
AV:30	Reserved	W/R	No	Na			

Table 5. 3: Analog values



## How to Control the Adjustable Frequency Drive

Object ID	Object Name	Read/Write	Changeable Description	Non-volatile RAM Store	TR200 Parameter	Alarm notification	Triggers Bus Timeout
AV:31	Ext. 2 Setpoint	W/R	No	TR200	21-35	No	No
AV:32	Ext. 2 Reference [Unit]	W/R	No	TR200	21-37	No	No
AV:33	Ext. 2 Feedback [Unit]	W/R	No	TR200	21-38	No	No
AV:34	Ext. 2 Proportional Gain	W/R	No	TR200	21-41	No	No
AV:35	Ext. 2 Integral Time (Sec)	W/R	No	TR200	21-42	No	No
AV:36	Ext. 2 Differential Time	W/R	No	TR200	21-43	No	No
AV:37	Ext. 2 Dif. Gain	W/R	No	TR200	21-44	No	No
AV:38	Ext. 3 Setpoint	W/R	No	TR200	21-55	No	No
AV:39	Ext. 3 Reference [Unit]	W/R	No	TR200	21-57	No	No
AV:40	Ext. 3 Feedback [Unit]	W/R	No	TR200	21-58	No	No
AV:41	Ext. 3 Proportional Gain	W/R	No	TR200	21-61	No	No
AV:42	Ext. 3 Integral Time (Sec)	W/R	No	TR200	21-62	No	No
AV:43	Ext. 3 Differential Time (Sec)	W/R	No	TR200	21-63	No	No
AV:44	Ext. 3 Dif. Gain Limit	W/R	No	TR200	21-64	No	No
AV:45	Running Bypass	Read	No	No	31-11	No	No

Table 5. 4: Analog values cont.

**Binary Input and Output Objects**

<b>Object ID</b>	<b>Object Name</b>	<b>Read/Write</b>	<b>Changeable Description</b>	<b>Non-volatile RAM Store</b>	<b>Drive Par.</b>	<b>Alarm notification</b>	<b>Triggers Bus Timeout</b>
Bl:0	Digital Input 33	Read	No	No	16-60/00	No	No
Bl:1	Digital Input 32	Read	No	No	16-60/01	No	No
Bl:2	Digital Input 29	Read	No	No	16-60/02	No	No
Bl:3	Digital Input 27	Read	No	No	16-60/03	No	No
Bl:4	Digital Input 19	Read	No	No	16-60/04	No	No
Bl:5	Digital Input 18	Read	No	No	16-60/05	No	No
Bl:6	Digital Input 37	Read	No	No	16-60/06	No	No
Bl:7	Digital Input X30/2	Read	No	No	16-60/07	No	No
Bl:8	Digital Input X30/3	Read	No	No	16-60/08	No	No
Bl:9	Digital Input X30/4	Read	No	No	16-60/09	No	No
Bl:10	Digital Input P 1660/10*	Read	No	No	16-60/10	No	No
Bl:11	Digital Input P 1660/11*	Read	No	No	16-60/11	No	No
Bl:12	Digital Input P 1660/12*	Read	No	No	16-60/12	No	No
Bl:13	Digital Input P 1660/13*	Read	No	No	16-60/13	No	No
Bl:14	Digital Input P 1660/14*	Read	No	No	16-60/14	No	No
Bl:15	Digital Input P 1660/15*	Read	No	No	16-60/15	No	No

Table 5. 5: Binary inputs

Bl: 7 - Bl: 19 values are only available if the option is installed.

\*) Reserved for future options!



## How to Control the Adjustable Frequency Drive

Object ID	Object Name	Read/Write	Changeable Description	Non-volatile RAM Store	Drive Par.	Alarm notification	Triggers Bus Timeout
BO:0	Digital Output 27	W/R	No	No	5-90/00	No	Yes
BO:1	Digital Output 29	W/R	No	No	5-90/01	No	Yes
BO:2	GPIO Output Term X30/6	W/R	No	No	5-90/02	No	Yes
BO:3	GPIO Output Term X30/7	W/R	No	No	5-90/03	No	Yes
BO:4	Relay 1 Output	W/R	No	No	5-90/04	No	Yes
BO:5	Relay 2 Output	W/R	No	No	5-90/05	No	Yes
BO:6	Option B Relay 1 Output	W/R	No	No	5-90/06	No	Yes
BO:7	Option B Relay 2 Output	W/R	No	No	5-90/07	No	Yes
BO:8	Option B Relay 3 Output	W/R	No	No	5-90/08	No	Yes
BO:9	Reserved Output P 590/9	W/R	No	No	5-90/09	No	Yes
BO:10	Reserved Output P 590/10*	W/R	No	No	5-90/10	No	Yes
BO:11	Reserved Output P 590/11*	W/R	No	No	5-90/11	No	Yes
BO:12	Reserved Output P 590/12*	W/R	No	No	5-90/12	No	Yes
BO:13	Reserved output P 590/13*	W/R	No	No	5-90/13	No	Yes
BO:14	Reserved Output P 590/14*	W/R	No	No	5-90/14	No	Yes
BO:15	Reserved Output P 590/15*	W/R	No	No	5-90/15	No	Yes
BO:16	Option C Relay 1 Output	W/R	No	No	5-90/16	No	Yes
BO:17	Option C Relay 2 Output	W/R	No	No	5-90/17	No	Yes
BO:18	Option C Relay 3 Output	W/R	No	No	5-90/18	No	Yes
BO:19	Option C Relay 4 Output	W/R	No	No	5-90/19	No	Yes
BO:20	Option C Relay 5 Output	W/R	No	No	5-90/20	No	Yes
BO:21	Option C Relay 6 Output	W/R	No	No	5-90/21	No	Yes
BO:22	Option C Relay 7 Output	W/R	No	No	5-90/22	No	Yes
BO:23	Option C Relay 8 Output	W/R	No	No	5-90/23	No	Yes
BO:24	Reserved Output P 590/24*	W/R	No	No	5-90/24	No	Yes
BO:25	Reserved Output P 590/25*	W/R	No	No	5-90/25	No	Yes

Table 5. 6: Binary outputs

\*) Reserved for future options!

<b>Object ID</b>	<b>Object Name</b>	<b>Read/Write</b>	<b>Changeable Description</b>	<b>Non-volatile RAM Store</b>	<b>Drive Par.</b>	<b>Alarm notification</b>	<b>Triggers Bus Timeout</b>
BO:30	Reserved Output P 590/30*	W/R	No	No	5-90/30	No	Yes
BO:31	Reserved Output P 590/31*	W/R	No	No	5-90/31	No	Yes
BO:36	Reserved Output P 590/26*	W/R	No	No	5-90/26	No	Yes
BO:37	Reserved Output P 590/27*	W/R	No	No	5-90/27	No	Yes
BO:38	Reserved Output P 590/28*	W/R	No	No	5-90/28	No	Yes
BO:39	Reserved Output P 590/29*	W/R	No	No	5-90/29	No	Yes

Table 5. 7: Binay outputs cont.

\*) Reserved for future options!



## How to Control the Adjustable Frequency Drive

Object ID	Object Name	Read / Write	Changeable Description	Non-volatile RAM Store	Drive Par.	Alarm notification	Triggers Bus Timeout
BV:0	Com. Fault	R	No	NA	BACnet option	Yes	No
BV:1	Start	W/R	No	No	CTW	No	Yes
BV:2	Coasting	W/R	No	No	CTW, Bit 3 =0	No	Yes
BV:3	CW/CCW	W/R	No	No	CTW bit 15=1	No	Yes
BV:4	Jog	W/R	No	No	CTW bit 0 =1	No	Yes
BV:5	Reset	W	No	No	CTW bit 07 = 1	No	Yes
BV:6	Reset Kwh Counter	W	No	No	P15-06	No	NO
BV:7	Reset Running Hours Counter	W	No	No	P15-07	No	NO
BV:10	Drive Ready	R	No	NA	STW Bit 01	No	No
BV:11	Reverse	R	No	NA	STW Bit 15	No	No
BV:12	Speed = Reference	R	No	NA	STW Bit 08	No	No
BV:13	Bus Control	R	No	NA	STW Bit 09	No	No
BV:14	Tripped	R	No	NA	STW Bit 03	Yes	No
BV:15	Triplock	R	No	NA	STW Bit 06	Yes	No
BV:16 -20	Reserved	R	No				
BV:21	ECB Test Mode	R	No	NA	31-10/00	No	No
BV:22	ECB Drive mode	R	No	NA	31-10/01	No	No
BV:23	ECB Aut. Bypass Enable	R	No	NA	31-10/02	No	No
BV:24	ECB Bypass Mode	R	No	NA	31-10/03	No	No
BV:25	ECB State	R	No	NA	31-10/05	Yes	No
BV:26	ECB Overload Trip	R	No	NA	31-10/06	Yes	No
BV:27	M2 Fault	R	No	NA	31-10/07	Yes	No
BV:28	M3 Fault	R	No	NA	31-10/08	Yes	No
BV:29	ECB External Interlock	R	No	NA	31-10/09	Yes	No
BV:30	ECB Manual Override	R	No	NA	31-10/10	No	No
BV:31	Reserved	R	No				

Table 5. 8: Binary values

## How to Control the Adjustable Frequency Drive

Object ID	Object Name	Read / Write	Changeable Description	Non-volatile RAM Store	Drive Par.	Alarm notification	Triggers Bus Timeout
BV:40	Brake Check	R	No	NA	16-90/00	Yes	
BV:41	Pwr. Card Temp	R	No	NA	16-90/01	Yes	
BV:42	Ground Fault	R	No	NA	16-90/02	Yes	
BV:43	Ctrl.Card Temp	R	No	NA	16-90/03	Yes	
BV:44	Ctrl. Word TO	R	No	NA	16-90/04	Yes	
BV:45	Overcurrent	R	No	NA	16-90/05	Yes	
BV:46	Torque Limit	R	No	NA	16-90/06	Yes	
BV:47	Motor TH Over	R	No	NA	16-90/07	Yes	
BV:48	Motor TH Over	R	No	NA	16-90/08	Yes	
BV:49	Inverter Overld.	R	No	NA	16-90/09	Yes	
BV:50	DC undervolt	R	No	NA	16-90/10	Yes	
BV:51	DC overvolt	R	No	NA	16-90/11	Yes	
BV:52	Short Circuit	R	No	NA	16-90/12	Yes	
BV:53	Soft-charge fault	R	No	NA	16-90/13	Yes	
BV:54	Line Power Fault	R	No	NA	16-90/14	Yes	
BV:55	AMA Not OK	R	No	NA	16-90/15	Yes	
BV:56	Live Zero Error	R	No	NA	16-90/16	Yes	
BV:57	Internal Fault	R	No	NA	16-90/17	Yes	
BV:58	Brake Overload	R	No	NA	16-90/18	Yes	
BV:59	U Phase Loss	R	No	NA	16-90/19	Yes	
BV:60	V Phase Loss	R	No	NA	16-90/20	Yes	
BV:61	W Phase Loss	R	No	NA	16-90/21	Yes	
BV:62	Serial Communication Bus Fault	R	No	NA	16-90/22	Yes	
BV:63	24 V Supply Low	R	No	NA	16-90/23	Yes	
BV:64	Line Power Fault	R	No	NA	16-90/24	Yes	
BV:65	1.8 V Supply Low	R	No	NA	16-90/25	Yes	
BV:66	Brake Failure	R	No	NA	16-90/26	Yes	
BV:67	Brake IGBT	R	No	NA	16-90/27	Yes	
BV:68	Option Changed	R	No	NA	16-90/28	Yes	
BV:69	Drive Initialized	R	No	NA	16-90/29	Yes	
BV:70	Safe Stop	R	No	NA	16-90/30	Yes	
BV:71	Brake Low	R	No	NA	16-90/31	Yes	
BV:72	Service Trip P 1691/0	R	No	NA	16-91/00	Yes	
BV:73	Service Trip P 1691/1	R	No	NA	16-91/01	Yes	
BV:74	Service Trip P 1691/2	R	No	NA	16-91/02	Yes	
BV:75	Service Trip P 1691/3	R	No	NA	16-91/03	Yes	
BV:76	Service Trip P 1691/4	R	No	NA	16-91/04	Yes	
BV:77	No Flow	R	No	NA	16-91/05	Yes	
BV:78	Dry Pump	R	No	NA	16-91/06	Yes	
BV:79	Curve End	R	No	NA	16-91/07	Yes	

Table 5. 9: Binary values cont.



## How to Control the Adjustable Frequency Drive

Object ID	Object Name	Read / Write	Changeable Description	Non-volatile RAM Store	Drive Par.	Alarm notification	Triggers Bus Timeout
BV:80	Broken Belt	R	No	NA	16-91/08	Yes	
BV:81	Discharge High	R	No	NA	16-91/08	Yes	
BV:82	Start Fault	R	No	NA	16-91/10	Yes	
BV:83	Speed Limit	R	No	NA	16-91/11	Yes	
BV:84	State Fault P 1691/12	R	No	NA	16-91/12	Yes	
BV:85	State Fault P 1691/13	R	No	NA	16-91/13	Yes	
BV:86	State Fault P 1691/14	R	No	NA	16-91/14	Yes	
BV:87	State Fault P 1691/15	R	No	NA	16-91/15	Yes	
BV:88	KTY Temperature Error	R	No	NA	16-91/16	Yes	
BV:89	Drive Fan Error	R	No	NA	16-91/17	Yes	
BV:90	ECB Error	R	No	NA	16-91/18	Yes	
BV:91	Alarm 1692/19	R	No	NA	16-91/19	Yes	
BV:92	Alarm 1692/20	R	No	NA	16-91/20	Yes	
BV:93	Alarm 1692/21	R	No	NA	16-91/21	Yes	
BV:94	Alarm 1692/22	R	No	NA	16-91/22	Yes	
BV:95	Alarm 1692/23	R	No	NA	16-91/23	Yes	
BV:96	Alarm 1692/24	R	No	NA	16-91/24	Yes	
BV:97	Alarm 1692/25	R	No	NA	16-91/25	Yes	
BV:98	Alarm 1692/26	R	No	NA	16-91/26	Yes	
BV:99	Alarm 1692/27	R	No	NA	16-91/27	Yes	
BV:100	Alarm 1692/28	R	No	NA	16-91/28	Yes	
BV:101	Alarm 1692/29	R	No	NA	16-91/29	Yes	
BV:102	Alarm 1692/30	R	No	NA	16-91/30	Yes	
BV:103	Alarm 1692/31	R	No	NA	16-91/31	Yes	
BV:104	Brake Check	R	No	NA	16-92/00	Yes	
BV:105	Pwr. Card Temp	R	No	NA	16-92/01	Yes	
BV:106	Ground Fault	R	No	NA	16-92/02	Yes	
BV:107	Ctrl. Card Temp	R	No	NA	16-92/03	Yes	
BV:108	Ctrl. Word TO	R	No	NA	16-92/04	Yes	
BV:109	Overcurrent	R	No	NA	16-92/05	Yes	
BV:110	Torque Limit	R	No	NA	16-92/06	Yes	
BV:111	Motor Th Over	R	No	NA	16-92/07	Yes	
BV:112	Motor ETR Over	R	No	NA	16-92/08	Yes	
BV:113	Inverter Overld.	R	No	NA	16-92/09	Yes	
BV:114	DC undervolt	R	No	NA	16-92/10	Yes	
BV:115	DC overvolt	R	No	NA	16-92/11	Yes	
BV:116	DC Voltage Low	R	No	NA	16-92/12	Yes	
BV:117	DC Voltage high	R	No	NA	16-92/13	Yes	
BV:118	Line ph. loss	R	No	NA	16-92/14	Yes	
BV:119	No Motor	R	No	NA	16-92/15	Yes	
BV:120	Live Zero Error	R	No	NA	16-92/16	Yes	

Table 5. 10: Binary values cont.

Object ID	Object Name	Read / Write	Changeable Description	Non-volatile RAM Store	Drive Par.	Alarm notification	Triggers Bus Timeout
BV:121	10V low	R	No	NA	16-92/17	Yes	
BV:122	Brake Overload	R	No	NA	16-92/18	Yes	
BV:123	Brake Resistor	R	No	NA	16-92/19	Yes	
BV:124	Brake IGBT	R	No	NA	16-92/20	Yes	
BV:125	Speed Limit	R	No	NA	16-92/21	Yes	
BV:126	Serial Communication Bus Fault	R	No	NA	16-92/22	Yes	
BV:127	24V Supply Low	R	No	NA	16-92/23	Yes	
BV:128	Line failure	R	No	NA	16-92/24	Yes	
BV:129	Current Limit	R	No	NA	16-92/25	Yes	
BV:130	Low Temp	R	No	NA	16-92/26	Yes	
BV:131	Voltage Limit	R	No	NA	16-92/27	Yes	
BV:132	Encoder loss	R	No	NA	16-92/28	Yes	
BV:133	Output Freq. Limit	R	No	NA	16-92/29	Yes	
BV:134	Safe Stop	R	No	NA	16-92/30	Yes	
BV:135	Ext. Status	R	No	NA	16-92/31	Yes	
BV:136	Start Delayed	R	No	NA	16-93/00	Yes	
BV:137	Stop Delayed	R	No	NA	16-93/01	Yes	
BV:138	Clock Failure	R	No	NA	16-93/02	Yes	
BV:139	Fire Mode was Active	R	No	NA	16-93/03	Yes	
BV:140	Reserved, P1693/04	R	No	NA	16-93/04	Yes	
BV:141	No Flow	R	No	NA	16-93/05	Yes	
BV:142	Dry Pump	R	No	NA	16-93/06	Yes	
BV:143	End of Curve	R	No	NA	16-93/07	Yes	
BV:144	Belt Broken	R	No	NA	16-93/08	Yes	
BV:145	Discharge High	R	No	NA	16-93/09	Yes	
BV:146	Reserved, P1693/10	R	No	NA	16-93/10	Yes	
BV:147	Reserved, P1693/11	R	No	NA	16-93/11	Yes	
BV:148	Reserved, P1693/12	R	No	NA	16-93/12	Yes	
BV:149	Reserved, P1693/13	R	No	NA	16-93/13	Yes	
BV:150	Reserved, P1693/14	R	No	NA	16-93/14	Yes	
BV:151	Reserved, P1693/15	R	No	NA	16-93/15	Yes	
BV:152	Reserved, P1693/16	R	No	NA	16-93/16	Yes	
BV:153	KTY Temperature	R	No	NA	16-93/17	Yes	
BV:154	Drive Fan Failure	R	No	NA	16-93/18	Yes	
BV:155	ECB Failure	R	No	NA	16-93/19	Yes	

Table 5. 11: Binary values cont.



## How to Control the Adjustable Frequency Drive

Object ID	Object Name	Read / Write	Changeable Description	Non-volatile RAM Store	Drive Par.	Alarm notification	Triggers Bus Timeout
BV:156	Reserved, P 1693/20	R	No	NA	16-93/20	Yes	
BV:157	Reserved, P 1693/21	R	No	NA	16-93/21	Yes	
BV:158	Reserved, P 1693/22	R	No	NA	16-93/22	Yes	
BV:159	Reserved, P 1693/23	R	No	NA	16-93/23	Yes	
BV:160	Reserved, P 1693/24	R	No	NA	16-93/24	Yes	
BV:161	Reserved, P 1693/25	R	No	NA	16-93/25	Yes	
BV:162	Reserved, P 1693/26	R	No	NA	16-93/26	Yes	
BV:163	Reserved, P 1693/27	R	No	NA	16-93/27	Yes	
BV:164	Reserved, P 1693/28	R	No	NA	16-93/28	Yes	
BV:165	Reserved, P 1693/29	R	No	NA	16-93/29	Yes	
BV:166	PTC Temperature	R	No	NA	16-93/30	Yes	
BV:167	Reserved, P 1693/31	R	No	NA	16-93/31	Yes	
BV:168	Ramping Active	R	No	NA	16-94/00	No	
BV:169	AMA Running	R	No	NA	16-94/01	No	
BV:170	Start CW/CCW	R	No	NA	16-94/02	No	
BV:171	Slowdown	R	No	NA	16-94/03	No	
BV:172	Catch Up	R	No	NA	16-94/04	No	
BV:173	Feedback High	R	No	NA	16-94/05	No	
BV:174	Feedback Low	R	No	NA	16-94/06	No	
BV:175	Output Current High	R	No	NA	16-94/07	No	
BV:176	Output Current Low	R	No	NA	16-94/08	No	
BV:177	Output Freq High	R	No	NA	16-94/09	No	
BV:178	Output Freq Low	R	No	NA	16-94/10	No	
BV:178	Brake Check OK	R	No	NA	16-94/11	No	
BV:180	Brake Max	R	No	NA	16-94/12	No	

Table 5. 12: Binary values cont.

Object ID	Object Name	Read / Write	Changeable Description	Non-volatile RAM Store	Drive Par.	Alarm notification	Triggers Bus Timeout
BV:181	Braking	R	No	NA	16-94/13	No	
BV:182	Out of Speed range	R	No	NA	16-94/14	No	
BV:183	OVC Active	R	No	NA	16-94/15	No	
BV:184	AC Brake	R	No	NA	16-94/16	No	
BV:185	Password Time-lock	R	No	NA	16-94/17	No	
BV:186	Password Status	R	No	NA	16-94/18	No	
BV:187	Reference High	R	No	NA	16-94/19	No	
BV:188	Reference Low	R	No	NA	16-94/20	No	
BV:189	Reference Site	R	No	NA	16-94/21	No	
BV:190	Reserved, 16-94/22	R	No	NA	16-94/22	No	
BV:191	Reserved, 16-94/23	R	No	NA	16-94/23	No	
BV:192	Reserved, 16-94/24	R	No	NA	16-94/24	No	
BV:193	Reserved, 16-94/25	R	No	NA	16-94/25	No	
BV:194	Reserved, 16-94/26	R	No	NA	16-94/26	No	
BV:195	Reserved, 16-94/27	R	No	NA	16-94/27	No	
BV:196	Reserved, 16-94/28	R	No	NA	16-94/28	No	
BV:197	Reserved, 16-94/29	R	No	NA	16-94/29	No	
BV:198	Reserved, 16-94/30	R	No	NA	16-94/30	No	
BV:199	Reserved, 16-94/31	R	No	NA	16-94/31	No	

Table 5. 13: Binary values cont.

## Multi-state Input and Output Objects

### Multi-state Variable

Object ID	Object Name	Read/ Write	Changeable Description	Non-volatile RAM Store	Drive Par.	Alarm notification	Triggers Bus Timeout
MSV:0	SL LC Controller State	R	No	Non	16-38	No	No
MSV:1	Set-up selection	W/R	No	Non	Bit 13 & 14 in CTW	No	No



## How to Control the Adjustable Frequency Drive

### Mailbox variable

Object ID	Object Name	Read/Write	Changeable Description	Non-volatile RAM Store	Drive Par.	Alarm notification	Triggers Bus Timeout
MBV:0	Mailbox Write	W/R	No	Non	PCV part of the send drive message	No	No
MBV:1	Mailbox Read	R	No	Non	PCV part of the receive drive message	No	No

### Real Time Clock Variable

The adjustable frequency drive has a built-in real-time clock. The standard real-time clock has no battery backup function (for real-time clock battery backup, selected TR200 option modules are available), which will lead to a time stop if the drive is unpowered. Some BACnet Masters can be programmed to send out the date and time as a broadcast message on a regular basis. The BACnet will update the real-time clock of the drive if it receives this type of message: "Message".

---

## Adjustable Frequency Drive Feedback to Network

The BACnet option provides several output variables (NVOs) to the network, containing important adjustable frequency drive, motor and I/O feedback data. The BACnet option transmits bound network variables only and sends feedback data when there is a change in value.

Influence of the digital input terminals upon the drive control mode, par.8-50 [Coasting Select](#) to par.8-56 [Preset Reference Select](#)

The influence of the digital input terminals upon control of the adjustable frequency drive can be programmed in par.8-50 [Coasting Select](#) to par.8-56 [Preset Reference Select](#).

### NOTE

par.8-01 [Control Site](#) overrides the settings in *parameters 8-50 to 8-56* and Terminal 37, Safe Stop overrides any parameter.

Each of the digital input signals can be programmed to logic AND, logic OR, or to have no relation to the corresponding bit in the control word. In this way, a specific control command, i.e., stop / coast, can be initiated by the serial communication bus only, serial communication bus AND Digital Input, or serial communication bus OR digital input terminal.

### CAUTION

In order to control the adjustable frequency drive via BACnet, par.8-50 [Coasting Select](#) must be set to either Bus [1], or to Logic AND [2] and par.8-01 [Control Site](#) must be set to Digital and ctrl. word [0] or Controlword only [2].

More detailed information and examples of logical relationship options are provided in the *Troubleshooting* chapter.





## How to Control the Adjustable Frequency Drive

### Object / Property Support Matrix

The following table summarizes the object types and properties supported:

Property	Device	Binary input	Binary output	Binary value	Analog input	Analog output	Analog value	Multi-stage value	File	Event notification class
Object identifier	X	X	X	X	X	X	X	X	X	X
Object Name	X	X	X	X	X	X	X	X	X	X
Object Type	X	X	X	X	X	X	X	X	X	X
System Status	X									
Vendor Name	X									
Vendor Identifier	X									
Model Name	X									
Firmware Revision	X									
Appl. Software Revision	X									
Location	X									
Description	X	X	X	X	X	X	X	X	X	X
Protocol Version	X									
Protocol Revision	X									
Services Supported	X									
Object Types Supported	X									
Object List	X									
Max. APDU Length	X									
Segmentation Support	X									
Local Time	X									
Local Date	X									
APDU Timeout	X									
Number APDU Retries	X									
Max Master	X									
Max Info Frames	X									
Device Address Binding	X									
Database Revision	X									

**Object / Property Support Matrix, continued..**

Property	Device	Binary input	Binary output	Binary value	Analog input	Analog output	Analog value	Multi-stage value	File	Event notification class
Present Value		X	X	X	X	X	X			
Status Flags		X	X	X	X	X	X			
Event State		X	X	X	X	X	X			
Reliability		X	X	X	X	X	X			
Out-of-Service		X	X	X	X	X	X			
Number of States								X		
State Text								X		
Units					X	X	X			
Time Delay					X		X			
Notification Class					X		X			
High Limit					X		X			
Low Limit					X		X			
Deadband					X		X			
Limit Enable					X		X			
Event Enable					X		X			
Acked Transitions					X		X			
Notify Type					X		X			
Event Time Stamp					X		X			
Priority Array			X	X*		X	??	X		
Priority										X
ACK Required										X
Recipient List										X
# of Notification Class										X
Relinquish Default			X	X*		X	??	X		
Polarity		X	X							
Active Text		X	X	X						
Inactive Text		X	X	X						
File type									X	
File size									X	
Modification Date									X	
Archive									X	
Read Only									X	
File Access Method									X	
*For commandable values only										



# How to Control the Adjustable Frequency Drive

---

# Parameters

## Parameter Overview

### Parameter List

Nr.	Title	Default value	Range	Conversion index	Data type
8-01	Control Site	Dig. and ctrl. word [0]	[0 - 2]	-	5
8-02	Control Source	Drive RS485 [0]	[0 - 4]	-	5
8-03	Control Timeout Time	1 s	0.1–18000	- 1	7
8-04	Control Timeout Function	Off [0]	[0 - 10]	-	5
8-05	End-of-timeout Function	Hold set-up [0]	[0 - 1]	-	5
8-06	Reset Control Timeout	Do not reset [0]	[0 - 1]	-	5
8-07	Diagnosis Trigger	Disable [0]	[0 - 3]	-	5
8-10	Control Profile	Drive profile [0]	[0 - x]	-	5
8-30	Protocol	Drive			
8-31	Address	1	[0 – 255]		
8-32	Baudrate	38,400	[0 – 7]		
8-33	Parity/Stop Bits	No Parity, 1 Stop Bit			
8-35	Minimum Response Delay	10mS			
8-36	Max Response Delay	5000mS			
8-37	Max Inter-Char Delay	25.00mS			
8-50	Coasting Select	Logic OR [3]	[0 - 3]	-	5
8-52	DC Brake Select	Logic OR [3]	[0 - 3]	-	5
8-53	Start Select	Logic OR [3]	[0 - 3]	-	5
8-54	Reversing Select	Logic OR [3]	[0 - 3]	-	5
8-55	Set-up Select	Logic OR [3]	[0 - 3]	-	5
8-56	Preset Reference Select	Logic OR [3]	[0 - 3]	-	5
8-70	BACnet Device Instance	1	[1-4194304]	-	
8-72	MS/TP Max Masters	127	[1-127]	-	
8-73	MS/TP Max Info Frames				
8-74	“I am” Service	Once at power-up [0]	[0-1]	-	
8-75	Initialization Password	“admin”	String[19]		

Table 6. 1: BACnet specific parameter list

Please refer to the *TR200 Drive Instruction Manual, MG. 12.HX.YY* for a comprehensive parameter list or to the *TR200 Drive Programming Guide, MG. 12.JX.YY* for detailed descriptions of parameters.

## Parameter Description

### 8-\*\* Comm. and Options

Parameter group for configuring communications and options.

#### 8-01 Control Site

Option:

Function:

The setting in this parameter overrides the settings in par.8-50 [Coasting Select](#) to par.8-56 [Preset Reference Select](#).

[0] *	Digital and ctrl. word	Control by using both digital input and control word.
[1]	Digital only	Control by using digital inputs only.
[2]	Control word only	Control by using control word only.

#### 8-02 Control Source

Option:

Function:

Select the source of the control word: one of two serial interfaces or four installed options. During initial power-up, the adjustable frequency drive automatically sets this parameter to *Option A* [3] if it detects a valid serial communication bus option installed in slot A. If the option is removed, the adjustable frequency drive detects a change in the configuration, sets par.8-02 [Control Source](#) back to default setting *Adjustable Frequency Drive Port*, and the adjustable frequency drive then trips. If an option is installed after initial power-up, the setting of par.8-02 [Control Source](#) will not change but the adjustable frequency drive will trip and display: Alarm 67 *Option Changed*.

[0]	None
[1]	FC RS-485
[2]	FC USB
[3] *	Option A
[4]	Option B
[5]	Option C0
[6]	Option C1
[30]	External Can

NOTE: This parameter cannot be adjusted while the motor is running.

#### 8-03 Control Timeout Time

Range:

Function:

60.0 s\* [1.0 - 18000.0 s]

Enter the maximum time expected to pass between the reception of two consecutive messages. If this time is exceeded, it indicates that the serial communication has stopped. The function selected in par.8-04 [Control Timeout Function](#) *Control Timeout Function* will then be carried out.

In LonWorks, the following variables will trigger the Control Word Time parameter:

- nviStartStop
- nviReset Fault

nviControlWord  
 nviDrvSpeedStpt  
 nviRefPcnt  
 nviRefHz

#### 8-04 Control Timeout Function

Option:

Function:

Select the timeout function. The timeout function is activated when the control word fails to be updated within the time period specified in par. 8-03 [Control Timeout Time](#). Choice [20] only appears after setting the Metasys N2 protocol.

- [0] \* Off
- [1] Freeze output
- [2] Stop
- [3] Jogging
- [4] Max. speed
- [5] Stop and trip
- [7] Select setup 1
- [8] Select setup 2
- [9] Select setup 3
- [10] Select setup 4
- [20] N2 Override Release

In LonWorks, the timeout function is also activated when the following SNVTs fail to be updated within the time period specified in par.8-03 [Control Timeout Time](#):

nviStartStop	nviDrvSpeedStpt
nviReset Fault	nviRefPcnt
nviControlWord	nviRefHz

#### 8-05 End-of-Timeout Function

Option:

Function:

Select the action after receiving a valid control word following a timeout. This parameter is active only when par.8-04 [Control Timeout Function](#) is set to [Set-up 1-4].

- [0] Hold set-up  
Retains the set-up selected in par.8-04 [Control Timeout Function](#) and displays a warning, until par.8-06 [Reset Control Timeout](#) toggles. Then the adjustable frequency drive resumes its original set-up.
- [1] \* Resume set-up  
Resumes the set-up active prior to the timeout.

### 8-06 Reset Control Timeout

Option:	Function:
	This parameter is active only when the choice <i>Hold set-up</i> [0] has been selected in par.8-05 <a href="#">End-of-Timeout Function</a> .
[0] * Do not reset	Retains the set-up specified in par.8-04 <a href="#">Control Timeout Function</a> , [Select set-up 1-4] following a control timeout.
[1] Do reset	Returns the adjustable frequency drive to the original set-up following a control word timeout. When the value is set to <i>Do reset</i> [1], the adjustable frequency drive performs the reset and then immediately reverts to the <i>Do not reset</i> [0] setting.

### 8-07 Diagnosis Trigger

Option:	Function:
	This parameter has no function for LonWorks.
[0] * Disable	
[1] Trigger on alarms	
[2] Trigger alarm/warn.	

### 8-10 Control Profile

Option:	Function:
	Select the interpretation of the control and status words corresponding to the installed serial communication bus. Only the selections valid for the serial communication bus installed in slot A will be visible in the keypad display.
[0] * FC profile	
[1] PROFIdrive profile	
[5] ODVA	
[7] CANopen DSP 402	

### 8-30 Protocol

Option:	Function:
	Protocol selection for the integrated FC (standard) Port (RS485) on the control card. Parameter group 8-7* is only visible when Adjustable Frequency Drive Option [9] is chosen.
[0] * FC	Communication according to the FC protocol as described in the TR200 <i>Design Guide, RS 485 Installation and Set-up</i> .
[1] FC MC	Same as <i>FC</i> [0] but to be used when downloading SW to the adjustable frequency drive or uploading dll file (covering information regarding parameters available in the adjustable frequency drive and their inter-dependencies) to Trane Drive Utility, TDU.
[2] Modbus RTU	Communication according to the Modbus RTU protocol as described in the TR200 <i>Design Guide, RS 485 Installation and Set-up</i> .
[3] Metasys N2	Communication protocol. The N2 software protocol is designed to be general in nature in order to accommodate the unique properties each

device may have. Please see separate manual *TR200 MetasysMG. 12.NX.YY.*

[4]

[9]	FC Option	<p>To be used when a gateway is connected to the integrated RS 485 port, e.g., the BACnet gateway.</p> <p>The following changes will take place:</p> <ul style="list-style-type: none"> <li>-The address for the adjustable frequency drive port will be set to 1 and par.8-31 <a href="#">Address</a>, is now used to set the address for the gateway on the network, e.g., BACnet.</li> <li>-Baud rate for the Drive port will be set to a fixed value (115,200 Baud) and par.8-32 <a href="#">Baud Rate</a> is now used to set the baud rate for the network port (e.g., BACnet) on the gateway.</li> </ul>
-----	-----------	--

[20]

NOTE: Further details can be found in the Metasys manual.

### 8-31 Address

Range:	Function:
1. N/A* [1. - 126. N/A]	Enter the address for the adjustable frequency drive (standard) port. Valid range: 1–126.

### 8-32 Baud Rate

Option:	Function:
	Baud rate selection depends on Protocol selection in par.8-30 <a href="#">Protocol</a> .

- [0] 2400 Baud
- [1] 4800 Baud
- [2] 9600 Baud
- [3] 19200 Baud
- [4] \* 38400 Baud
- [5] 57600 Baud
- [6] 76800 Baud
- [7] 115200 Baud

Default refers to the FC Protocol.

### 8-33 Parity / Stop Bits

Option:	Function:
	Parity and Stop Bits for the protocol par.8-30 <a href="#">Protocol</a> using the Adjustable Frequency Drive Port. For some of the protocols, not all options will be visible. Default depends on the protocol selected.

- [0] \* Even Parity, 1 Stop Bit
- [1] Odd Parity, 1 Stop Bit
- [2] No Parity, 1 Stop Bit
- [3] No Parity, 2 Stop Bits



**8-35 Minimum Response Delay**

Range:	Function:
10. ms* [5. - 10000. ms]	Specify the minimum delay time between receiving a request and transmitting a response. This is used for overcoming modem turnaround delays.

**8-36 Max Response Delay**

Range:	Function:
10001. [11. - 10001. ms] ms*	Specify the maximum permissible delay time between transmitting a request and receiving a response. Exceeding this delay time will cause control word timeout.

**8-37 Max Inter-Char Delay**

Range:	Function:
25.00 [0.00 - 35.00 ms] ms*	Specify the maximum permissible time interval between receiving two bytes. This parameter activates timeout if transmission is interrupted.

**8-50 Coasting Select**

Option:	Function:
	Select control of the coasting function via the terminals (digital input) and/or via the bus.
[0] Digital input	Activates Start command via a digital input.
[1] Bus	Activates Start command via the serial communication port or serial communication option.
[2] Logic AND	Activates Start command via the serial communication bus/serial communication port, AND additionally via one of the digital inputs.
[3] * Logic OR	Activates Start command via the serial communication bus/serial communication port OR via one of the digital inputs.

NOTE: This parameter is active only when par.8-01 [Control Site](#) is set to [0] *Digital and control word*.

**8-52 DC Brake Select**

Option:	Function:
	Select control of the DC brake via the terminals (digital input) and/or via the serial communication bus.
[0] Digital input	Activates Start command via a digital input.
[1] Bus	Activates Start command via the serial communication port or serial communication option.
[2] Logic AND	Activates Start command via the serial communication bus/serial communication port, AND additionally via one of the digital inputs.
[3] * Logic OR	Activates Start command via the serial communication bus/serial communication port OR via one of the digital inputs.

NOTE: This parameter is active only when par.8-01 [Control Site](#) is set to [0] *Digital and control word*.

### 8-53 Start Select

Option:	Function:
	Select control of the adjustable frequency drive start function via the terminals (digital input) and/or via the serial communication bus.
[0] Digital input	Activates Start command via a digital input.
[1] Bus	Activates Start command via the serial communication port or serial communication option.
[2] Logic AND	Activates Start command via the serial communication bus/serial communication port, AND additionally via one of the digital inputs.
[3] * Logic OR	Activates Start command via the serial communication bus/serial communication port OR via one of the digital inputs.

NOTE: This parameter is active only when par.8-01 [Control Site](#) is set to [0] *Digital and control word*.

### 8-54 Reverse Select

Option:	Function:
	Select control of the adjustable frequency drive reverse function via the terminals (digital input) and/or via the serial communication bus.
[0] * Digital input	Activates Reverse command via a digital input.
[1] Bus	Activates Reverse command via the serial communication port or serial communication option.
[2] Logic AND	Activates Reverse command via the serial communication bus/serial communication port, AND additionally via one of the digital inputs.
[3] Logic OR	Activates Reverse command via the serial communication bus/serial communication port OR via one of the digital inputs.

NOTE: This parameter is active only when par.8-01 [Control Site](#) is set to [0] *Digital and control word*.

### 8-55 Set-up Select

Option:	Function:
	Select control of the adjustable frequency drive set-up selection via the terminals (digital input) and/or via the serial communication bus.
[0] Digital input	Activates the set-up selection via a digital input.
[1] Bus	Activates the set-up selection via the serial communication port or serial communication option.
[2] Logic AND	Activates the set-up selection via the serial communication bus/serial communication port, AND additionally via one of the digital inputs.
[3] * Logic OR	Activate the set-up selection via the serial communication bus/serial communication port OR via one of the digital inputs.

NOTE: This parameter is active only when par.8-01 [Control Site](#) is set to [0] *Digital and control word*.

**8-56 Preset Reference Select**

Option:	Function:
	Select control of the adjustable frequency drive Preset Reference selection via the terminals (digital input) and/or via the serial communication bus.
[0] Digital input	Activates Preset Reference selection via a digital input.
[1] Bus	Activates Preset Reference selection via the serial communication port or serial communication option.
[2] Logic AND	Activates Preset Reference selection via the serial communication bus/ serial communication port, AND additionally via one of the digital inputs.
[3] * Logic OR	Activates the Preset Reference selection via the serial communication bus/serial communication port OR via one of the digital inputs.

NOTE: This parameter is active only when par.8-01 [Control Site](#) is set to [0] *Digital and control word*.

**8-70 BACnet Device Instance**

Range:	Function:
1 N/A* [0 - 4194304 N/A]	Enter a unique ID number for the BACnet device.

NOTE: This parameter is active only when par.8-30 [Protocol](#) is set to [9] *Drive Option*.

**8-72 MS/TP Max Masters**

Range:	Function:
127 N/A* [0 - 127 N/A]	Define the address of the master which holds the highest address in this network. Decreasing this value optimizes polling for the token.

NOTE: This parameter is active only when par.8-30 [Protocol](#) is set to [9] *Option*.

**8-73 MS/TP Max Info Frames**

Range:	Function:
1 N/A* [1 - 65534 N/A]	Define how many info/data frames the device is allowed to send while holding the token.

NOTE: This parameter is active only when par.8-30 [Protocol](#) is set to [9] *Option*.

**8-74 "Startup I am"**

Option:	Function:
[0] *	
[1]	Choose whether the device should send the "I-Am" service message only at power-up or continuously with an interval of approx. 1 min.

NOTE: This parameter is active only when par.8-30 [Protocol](#) is set to [9] *Option*.

**8-75 Initialization Password**

Range:	Function:
0 N/A* [0 - 0 N/A]	Enter the password needed for execution of Drive Re-initialization from BACnet.

NOTE: This parameter is active only when par.8-30 [Protocol](#) is set to [9] *Drive Option*.

# Troubleshooting

## Alarm, Warning and Extended Status Word

### Alarm and Warning Messages

#### General

There is a clear distinction between alarms and warnings. In the event of an alarm, the adjustable frequency drive will enter a fault condition. After the cause for the alarm has been cleared, the master must acknowledge the alarm message in order to start operation of the adjustable frequency drive again. A warning, on the other hand, may appear when a warning condition arises, then disappear when conditions return to normal without interfering with the process.

Alarm Word and Warning Word are shown on the display in Hex format. If there is more than one warning or alarm, a sum of all warnings or alarms will be shown. Warning Word and Alarm Word are displayed in par. 16-90 to 16-95. For more information on the individual alarms and warnings, please refer to: TR200 *Design Guide*.

#### Warnings

All warnings within the adjustable frequency drive are represented by a single bit within a warning word. A warning word is always an action parameter. Bit status FALSE [0] means no warning, while bit status TRUE [1] means warning. Each bit status has a corresponding text string message. In addition to the Warning Word message, the master will also be notified via a change to bit 7 in the status word.

#### Alarms

Following an alarm message the adjustable frequency drive will enter a fault condition. Only after the fault has been rectified and the master has acknowledged the alarm message by setting bit 3 in the Control Word, can the adjustable frequency drive resume operation. All alarms within the TR200 are represented by a single bit within an alarm word. An alarm word is always an action parameter. Bit status FALSE [0] means no alarm, while bit status TRUE [1] means alarm.

**Alarm Words**

 Alarm word, par.16-90 [Alarm Word](#)

<b>Bit (Hex)</b>	<b>Alarm Word (par.16-90 Alarm Word)</b>
00000001	Brake check
00000002	Power card overtemperature
00000004	Ground fault
00000008	Ctrl. card overtemperature
00000010	Control word timeout
00000020	Overcurrent
00000040	Torque limit
00000080	Motor thermistor overtemp.
00000100	Motor ETR overtemperature
00000200	Inverter overloaded
00000400	DC link undervoltage
00000800	DC link overvoltage
00001000	Short circuit
00002000	Soft-charge fault
00004000	Line phase loss
00008000	AMA not OK
00010000	Live zero error
00020000	Internal fault
00040000	Brake overload
00080000	Motor phase U is missing
00100000	Motor phase V is missing
00200000	Motor phase W is missing
00400000	Serial communication bus fault
00800000	24 V supply fault
01000000	Line failure
02000000	1.8 V supply fault
04000000	Brake resistor short circuit
08000000	Brake chopper fault
10000000	Option change
20000000	Drive initialized
40000000	Safe Stop
80000000	Not used

 Alarm word 2, par.16-91 [Alarm word 2](#)

<b>Bit (Hex)</b>	<b>Alarm Word 2 (par.16-91 Alarm word 2)</b>
00000001	Service Trip, read / Write
00000002	Reserved
00000004	Service Trip, Typecode / Spare part
00000008	Reserved
00000010	Reserved
00000020	No Flow
00000040	Dry Pump
00000080	End of Curve
00000100	Broken Belt
00000200	Not used
00000400	Not used
00000800	Reserved
00001000	Reserved
00002000	Reserved
00004000	Reserved
00008000	Reserved
00010000	Reserved
00020000	Not used
00040000	Fans error
00080000	ECB error
00100000	Reserved
00200000	Reserved
00400000	Reserved
00800000	Reserved
01000000	Reserved
02000000	Reserved
04000000	Reserved
08000000	Reserved
10000000	Reserved
20000000	Reserved
40000000	Reserved
80000000	Reserved

## Warning Words

Warning word , par.16-92 [Warning Word](#)

<b>Bit (Hex)</b>	<b>Warning Word (par.16-92 <a href="#">Warning Word</a>)</b>
00000001	Brake check
00000002	Power card overtemperature
00000004	Ground fault
00000008	Ctrl. card overtemperature
00000010	Control word timeout
00000020	Overcurrent
00000040	Torque limit
00000080	Motor thermistor overtemp.
00000100	Motor ETR overtemperature
00000200	Inverter overloaded
00000400	DC link undervoltage
00000800	DC link overvoltage
00001000	DC link voltage low
00002000	DC link voltage high
00004000	Line phase loss
00008000	No motor
00010000	Live zero error
00020000	10 V low
00040000	Brake resistor power limit
00080000	Brake resistor short circuit
00100000	Brake chopper fault
00200000	Speed limit
00400000	Serial Communication Bus comm. fault
00800000	24 V supply fault
01000000	Line failure
02000000	Current limit
04000000	Low temperature
08000000	Voltage limit
10000000	Encoder loss
20000000	Output frequency limit
40000000	Not used
80000000	Not used





Warning word 2, par.16-93 [Warning word 2](#)

<b>Bit (Hex)</b>	<b>Warning Word 2 (par.16-93 <a href="#">Warning word 2</a>)</b>
00000001	Start Delayed
00000002	Stop Delayed
00000004	Clock Failure
00000008	Reserved
00000010	Reserved
00000020	No Flow
00000040	Dry Pump
00000080	End of Curve
00000100	Broken Belt
00000200	Not used
00000400	Reserved
00000800	Reserved
00001000	Reserved
00002000	Reserved
00004000	Reserved
00008000	Reserved
00010000	Reserved
00020000	Not used
00040000	Fans warning
00080000	ECB warning
00100000	Reserved
00200000	Reserved
00400000	Reserved
00800000	Reserved
01000000	Reserved
02000000	Reserved
04000000	Reserved
08000000	Reserved
10000000	Reserved
20000000	Reserved
40000000	Reserved
80000000	Reserved





## LED Status

Check the LEDs. The two bi-color LEDs on the BACnet card indicate the status of BACnet communication.

### LED 1: Net Status

Phases	Status	Bi-color LED
Power On.	Hardware Not OK	Red 
	Self test	Green  n
Running	Module OK	Green  n
	Recoverable fault	Red  n
Data exchange	Device communicating.	Green  n

### LED 2: Module Status

Phases	Status	Bi-color LED
Power On.	Unrecoverable fault drive is not responding on internal bus	Red 
	Self test configuration takes place	Green  n
Running	Module OK	Green  n
	Recoverable fault <ul style="list-style-type: none"> <li>• Configuration not OK, e.g, P830</li> <li>• Drive tripped</li> </ul>	Red  n



[www.trane.com](http://www.trane.com)

For more information, contact your local Trane office or e-mail us at [comfort@trane.com](mailto:comfort@trane.com)

---

Literature Order Number	BAS-SVX24B-EN
Date	November 2009
Supersedes	BAS-SVX24A

---

Trane has a policy of continuous product and product data improvement and reserves the right to change design and specifications without notice.

130R0451

MG12L122



Rev. 2009-06-18



## Free Manuals Download Website

<http://myh66.com>

<http://usermanuals.us>

<http://www.somanuals.com>

<http://www.4manuals.cc>

<http://www.manual-lib.com>

<http://www.404manual.com>

<http://www.luxmanual.com>

<http://aubethermostatmanual.com>

Golf course search by state

<http://golfingnear.com>

Email search by domain

<http://emailbydomain.com>

Auto manuals search

<http://auto.somanuals.com>

TV manuals search

<http://tv.somanuals.com>