



TRANE[®]

FURN-PRC001-EN

Upflow/Horizontal Right or Upflow/Horizontal Left Induced Draft Gas Furnace

XR 80

TUD040,060,080,100,120,140C

**Single-Stage Fan Assisted
Combustion System**

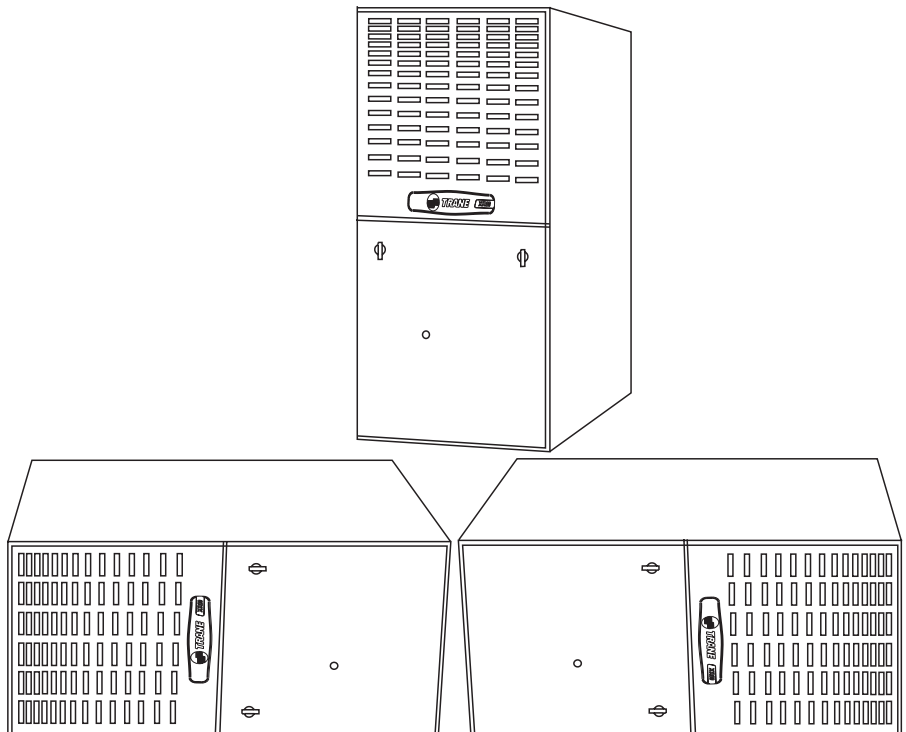

PUB. NO. 22-1640-06-0702 (EN)



General Features

Natural Gas Models

Central Heating furnace designs are certified by the American and Canadian Gas Associations for both natural and L.P. gas. Limit setting and rating data were established and approved under standard rating conditions using American National Standards Institute standards.

Safe Operation

The Integrated System Control has solid state devices, which continuously monitor for presence of flame, when the system is in the heating mode of operation. Dual solenoid combination gas valve and regulator provide extra safety.

Quick Heating

Durable, cycle tested, heavy gauge **aluminized steel heat exchanger** quickly transfers heat to provide warm conditioned air to the structure.

Burners

Multi-port In-shot burners will give years of quiet and efficient service. All models can be converted to **L.P. gas**.

Integrated System Control

Exclusively designed operational program provides total control of furnace limit sensors, blowers, gas valve, flame control and includes self diagnostics for ease of service. Also contains connection points for E.A.C./humidifier.

Air Delivery

The 4-speed, direct drive blower motor, has sufficient airflow for most heating and cooling requirements, will switch from heating to cooling speeds on demand from room thermostat. The blower door safety switch will prevent or terminate furnace operation when the blower door is removed.

Styling

Heavy gauge steel and "wrap-around" cabinet construction is used in the cabinet with baked-on enamel finish for strength and beauty. The heat exchanger section of the cabinet is completely lined with foil faced fiberglass insulation. This results in quiet and efficient operation due to the excellent acoustical and insulating qualities of fiberglass.

Features And General Operation

The XR 80 High Efficiency Gas Furnaces employ an adaptive Hot Surface Ignition system, which eliminates the waste of a constant burning pilot. The integrated system control lights the main burners upon a demand for heat from the room thermostat. Complete front service access.

- a. Low energy power venter.
- b. Vent proving pressure switch.

Contents

General Features	2
Features and Benefits	4
Standard Equipment	4
Optional Equipment	5
General Data	6
TUD040C924K	6
TUD040C930K	6
TUD060C924K	6
TUD060C936K	6
TUD080C924K	7
TUD080C936K	7
TUD080C948K	7
TUD080C960K	7
TUD100C936K	8
TUD100C945K	8
TUD100C948K	8
TUD100C960K	8
TUD100C972K	9
TUD120C954K	9
TUD120C960K	9
TUD140C960K	9
Performance Data	10
Field Wiring	12
Twinning Field Wiring	13
Dimensions	14
Electrical Data	15



Features and Benefits

XR 80 Upflow/Horizontal Right Or Left Standard Equipment

- Power supply 115/1/60
- Multi-port In-shot burners
- Integrated solid state control with self diagnostics
- Silicon Nitride hot surface igniter with adaptive heat up
- Complete front service access
- Heavy guage aluminized steel heat exchanger
- Slide out blower assembly
- Blower door safety switch
- Direct drive, 4-speed motor
- Cleanable high velocity filters
- Optional L.P. conversion kit
- Common vent
- Alternate bottom/left/right return air
- Hinged blower door
- Perfect Fit door latches
- Gasketed blower door
- Internal filter rack
- Cleanable high velocity filters
- Standard filter sizes
- Single wire twinning
- Selectable cooling fan off delay
- Left-right gas connection
- Optional L.P. conversion kit
- Common vent capability
- 24 volt fuse
- Manual reset flame roll out switches
- Insulated blower door
- Insulated blower compartment
- Accessory hook-up capability - Hum and EAC
- Blower door safety switch
- Left/right gas connection
- 24 volt fuse
- Manual reset burner box limit
- **Non-prorated 20-year heat exchanger limited warranty**
- **5-year limited parts warranty**



Features and Benefits

Optional Equipment

Thermostat	BAYSTAT388 []
Thermostat, Heating/Cooling Single Stage (Mounts Horizontally)	AY28X092 []
Thermostat, Heating/Cooling Single Stage (Mounts Vertically)	BAYSTAT305 []
Thermostat, Electronic Programmable 1-Stage Heating/1-Stage Cooling	TAYSTAT300C []
Propane Conversion Kit	BAYLPKT210A []
Electronic Air Filter, "Perfect Fit" Super Efficiency (14-1/2" Wide Gas Furnace)	TFE145A9FR1 []
Electronic Air Filter, "Perfect Fit" Super Efficiency (17-1/2" Wide Gas Furnace)	TFE175A9FR1 []
Electronic Air Filter, "Perfect Fit" Super Efficiency (21" Wide Gas Furnace)	TFE210A9FR1 []
Electronic Air Filter, "Perfect Fit" Super Efficiency (24-1/2" Wide Gas Furnace)	TFE245A9FR1 []
Electronic Air Filter, "Perfect Fit" High Efficiency (14-1/2" Wide Gas Furnace)	TFM145A9FR1 []
Electronic Air Filter, "Perfect Fit" High Efficiency (17-1/2" Wide Gas Furnace)	TFM175A9FR1 []
Electronic Air Filter, "Perfect Fit" High Efficiency (21" Wide Gas Furnace)	TFM210A9FR1 []
Electronic Air Filter, "Perfect Fit" High Efficiency (24-1/2" Wide Gas Furnace)	TFM245A9FR1 []
Electronic Air Filter, "Perfect Fit" Standard Efficiency (17-1/2" Wide Gas Furnace)	TFP175A9FR01 []
Electronic Air Filter, "Perfect Fit" Standard Efficiency (21" Wide Gas Furnace)	TFP210A9FR01 []
Electronic Air Filter, "Perfect Fit" Standard Efficiency (24-1/2" Wide Gas Furnace)	TFP245A9FR01 []
Coil Enclosure (14-1/2" Wide Cabinets)	BAYCLE1400C []
Coil Enclosure (17-1/2" Wide Cabinets)	BAYCLE1700C []
Coil Enclosure (21" Wide Cabinets)	BAYCLE2100C []
Coil Enclosure (24-1/2" Wide Cabinets)	BAYCLE2400C []
High Altitude Pressure Switch Kit	BAYHALT248 []
Masonry Chimney Vent Kit	BAYVENT800B []
Filter Rack Kit	BAYRACK960A []



General Data

Product Specifications ^①

MODEL	TUD040C924K	TUD040C930K	TUD060C924K	TUD060C936K
TYPE	Upflow / Horizontal	Upflow / Horizontal	Upflow / Horizontal	Upflow / Horizontal
RATINGS ^②				
Input BTUH	40,000	40,000	60,000	60,000
Capacity BTUH (ICS) ^③	32,000	32,000	47,000	47,000
AFUE	80.0	80.0	80.0	80.0
Temp. rise (Min.-Max.) °F.	30 - 60	30 - 60	35 - 65	30 - 60
BLOWER DRIVE	DIRECT	DIRECT	DIRECT	DIRECT
Diameter - Width (In.)	10 x 6	10 x 6	10 x 6	10 x 7
No. Used	1	1	1	1
Speeds (No.)	4	4	4	4
CFM vs. in. w.g.	See Fan Performance Table	See Fan Performance Table	See Fan Performance Table	See Fan Performance Table
Motor HP	1/5	1/3	1/5	1/3
R.P.M.	1080	1075	1080	1075
Volts / Ph / Hz	115/1/60	115/1/60	115/1/60	115/1/60
COMBUSTION FAN - Type	Centrifugal	Centrifugal	Centrifugal	Centrifugal
Drive - No. Speeds	Direct - 1	Direct - 1	Direct - 1	Direct - 1
Motor HP - RPM	1/50 - 3000	1/50 - 3000	1/50 - 3000	1/50 - 3000
Volts / Ph / Hz	115/1/60	115/1/60	115/1/60	115/1/60
FLA	1.0	1.0	1.0	1.0
FILTER — Furnished?	Yes	Yes	Yes	Yes
Type Recommended	High Velocity	High Velocity	High Velocity	High Velocity
Hi Vel. (No.-Size-Thk.)	1 - 17x25 - 1in.	1 - 17x25 - 1in.	1 - 17x25 - 1in.	1 - 17x25 - 1in.
VENT — Size (in.)	4 Round	4 Round	4 Round	4 Round
HEAT EXCHANGER				
Type -Fired	Aluminized Steel - Type I	Aluminized Steel - Type I	Aluminized Steel - Type I	Aluminized Steel - Type I
-Unfired				
Gauge (Fired)	20	20	20	20
ORIFICES — Main				
Nat. Gas Qty. — Drill Size	2 — 45	2 — 45	3 — 45	3 — 45
L.P. Gas Qty. — Drill Size	2 — 56	2 — 56	3 — 56	3 — 56
GAS VALVE	Redundant - Single Stage	Redundant - Single Stage	Redundant - Single Stage	Redundant - Single Stage
PILOT SAFETY DEVICE				
Type	Hot Surface Ignition	Hot Surface Ignition	Hot Surface Ignition	Hot Surface Ignition
BURNERS — Type	Multi-port In-shot	Multi-port In-shot	Multi-port In-shot	Multi-port In-shot
Number	2	2	3	3
POWER CONN. — V / Ph / Hz ^④	115/1/60	115/1/60	115/1/60	115/1/60
Ampacity (In Amps)	6.3	6.3	10.4	10.4
Max. Overcurrent Protection (Amps)	15	15	15	15
PIPE CONN. SIZE (IN.)	1/2	1/2	1/2	1/2
DIMENSIONS	H x W x D	H x W x D	H x W x D	H x W x D
Crated (In.)	41-3/4 x 16-1/2 x 30-1/2	41-3/4 x 16-1/2 x 30-1/2	41-3/4 x 16-1/2 x 30-1/2	41-3/4 x 16-1/2 x 30-1/2
WEIGHT				
Shipping (Lbs.) / Net (Lbs)	119 / 110	122 / 113	124 / 115	127 / 118

① Central Furnace heating designs are certified by AGA and CSA.

② For U.S. applications, above input ratings (BTUH) are up to 2,000 feet, derate 4% per 1,000 feet for elevations above 2,000 feet above sea level. For Canadian applications, above input ratings (BTUH) are up to 4,500 feet, derate 4% per 1,000 feet for elevations above 4,500 feet above sea level.

③ Based on U.S. government standard tests.

④ The above wiring specifications are in accordance with National Electrical Code; however, installations must comply with local codes.



General Data

Product Specifications ^①

MODEL	TUD080C924K	TUD080C936K	TUD080C948K	TUD080C960K
TYPE	Upflow / Horizontal	Upflow / Horizontal	Upflow / Horizontal	Upflow / Horizontal
RATINGS ^②				
Input BTUH	80,000	80,000	80,000	80,000
Capacity BTUH (ICS) ^③	64,000	63,000	64,000	64,000
AFUE	80.0	80.0	80.0	80.0
Temp. rise (Min.-Max.) °F.	50 - 80	30 - 60	30 - 60	25 - 55
BLOWER DRIVE	DIRECT	DIRECT	DIRECT	DIRECT
Diameter - Width (In.)	9 x 7	10 x 7	10 x 8	11 x 10
No. Used	1	1	1	1
Speeds (No.)	4	4	4	4
CFM vs. in. w.g.	See Fan Performance Table	See Fan Performance Table	See Fan Performance Table	See Fan Performance Table
Motor HP	1/5	1/3	1/3	3/4
R.P.M.	1080	1075	1075	1100
Volts / Ph / Hz	115/1/60	115/1/60	115/1/60	115/1/60
COMBUSTION FAN - Type	Centrifugal	Centrifugal	Centrifugal	Centrifugal
Drive - No. Speeds	Direct - 1	Direct - 1	Direct - 1	Direct - 1
Motor HP - RPM	1/50 - 3000	1/50 - 3000	1/50 - 3000	1/50 - 3000
Volts / Ph / Hz	115/1/60	115/1/60	115/1/60	115/1/60
FLA	1.0	1.0	1.0	1.0
FILTER — Furnished?	Yes	Yes	Yes	Yes
Type Recommended	High Velocity	High Velocity	High Velocity	High Velocity
Hi Vel. (No.-Size-Thk.)	1 - 17x25 - 1in.	1 - 17x25 - 1in.	1 - 17x25 - 1in.	1 - 20x25 - 1in.
VENT — Size (in.)	4 Round	4 Round	4 Round	4 Round
HEAT EXCHANGER				
Type -Fired	Aluminized Steel - Type I	Aluminized Steel - Type I	Aluminized Steel - Type I	Aluminized Steel - Type I
-Unfired				
Gauge (Fired)	20	20	20	20
ORIFICES — Main				
Nat. Gas. Qty. — Drill Size	4 — 45	4 — 45	4 — 45	4 — 45
L.P. Gas Qty. — Drill Size	4 — 56	4 — 56	4 — 56	4 — 56
GAS VALVE	Redundant - Single Stage	Redundant - Single Stage	Redundant - Single Stage	Redundant - Single Stage
PILOT SAFETY DEVICE				
Type	Hot Surface Ignition	Hot Surface Ignition	Hot Surface Ignition	Hot Surface Ignition
BURNERS — Type	Multi-port In-shot	Multi-port In-shot	Multi-port In-shot	Multi-port In-shot
Number	4	4	4	4
POWER CONN. — V / Ph / Hz ^④	115/1/60	115/1/60	115/1/60	115/1/60
Ampacity (In Amps)	10.4	10.4	9.1	13.8
Max. Overcurrent Protection (Amps)	15	15	15	15
PIPE CONN. SIZE (IN.)	1/2	1/2	1/2	1/2
DIMENSIONS	H x W x D	H x W x D	H x W x D	H x W x D
Crated (In.)	41-3/4 x 19-1/2 x 30-1/2	41-3/4 x 19-1/2 x 30-1/2	41-3/4 x 19-1/2 x 30-1/2	41-3/4 x 23 x 30-1/2
WEIGHT				
Shipping (Lbs.) / Net (Lbs)	139 / 129	142 / 132	142 / 132	162 / 151

① Central Furnace heating designs are certified by AGA and CSA.

② For U.S. applications, above input ratings (BTUH) are up to 2,000 feet, derate 4% per 1,000 feet for elevations above 2,000 feet above sea level. For Canadian applications, above input ratings (BTUH) are up to 4,500 feet, derate 4% per 1,000 feet for elevations above 4,500 feet above sea level.

③ Based on U.S. government standard tests.

④ The above wiring specifications are in accordance with National Electrical Code; however, installations must comply with local codes.



General Data

Product Specifications ^①

MODEL	TUD100C936K	TUD100C945K	TUD100C948K	TUD100C960K
TYPE	Upflow / Horizontal	Upflow / Horizontal	Upflow / Horizontal	Upflow / Horizontal
RATINGS ^②				
Input BTUH	100,000	100,000	100,000	100,000
Capacity BTUH (ICS) ^③	79,000	79,000	79,000	79,000
AFUE	80.0	80.0	80.0	80.0
Temp. rise (Min.-Max.) °F.	40 - 70	35 - 65	35 - 65	30 - 60
BLOWER DRIVE	DIRECT	DIRECT	DIRECT	DIRECT
Diameter - Width (In.)	10 x 7	10 x 8	10 x 8	11 x 10
No. Used	1	1	1	1
Speeds (No.)	4	4	4	4
CFM vs. in. w.g.	See Fan Performance Table	See Fan Performance Table	See Fan Performance Table	See Fan Performance Table
Motor HP	1/3	1/3	1/2	1/2
R.P.M.	1075	1075	1075	1075
Volts / Ph / Hz	115/1/60	115/1/60	115/1/60	115/1/60
COMBUSTION FAN - Type	Centrifugal	Centrifugal	Centrifugal	Centrifugal
Drive - No. Speeds	Direct - 1	Direct - 1	Direct - 1	Direct - 1
Motor HP - RPM	1/50 - 3000	1/50 - 3000	1/50 - 3000	1/50 - 3000
Volts / Ph / Hz	115/1/60	115/1/60	115/1/60	115/1/60
FLA	1.0	1.0	1.0	1.0
FILTER — Furnished?	Yes	Yes	Yes	Yes
Type Recommended	High Velocity	High Velocity	High Velocity	High Velocity
Hi Vel. (No.-Size-Thk.)	1 - 17x25 - 1in.	1 - 17x25 - 1in.	1 - 20x25 - 1in.	1 - 20x25 - 1in.
VENT — Size (in.)	4 Round	4 Round	4 Round	4 Round
HEAT EXCHANGER				
Type -Fired	Aluminized Steel - Type I	Aluminized Steel - Type I	Aluminized Steel - Type I	Aluminized Steel - Type I
-Unfired				
Gauge (Fired)	20	20	20	20
ORIFICES — Main				
Nat. Gas Qty. — Drill Size	5 — 45	5 — 45	5 — 45	5 — 45
L.P. Gas Qty. — Drill Size	5 — 56	5 — 56	5 — 56	5 — 56
GAS VALVE	Redundant - Single Stage	Redundant - Single Stage	Redundant - Single Stage	Redundant - Single Stage
PILOT SAFETY DEVICE				
Type	Hot Surface Ignition	Hot Surface Ignition	Hot Surface Ignition	Hot Surface Ignition
BURNERS — Type	Multi-port In-shot	Multi-port In-shot	Multi-port In-shot	Multi-port In-shot
Number	5	5	5	5
POWER CONN. — V / Ph / Hz ^④	115/1/60	115/1/60	115/1/60	115/1/60
Ampacity (In Amps)	10.4	10.4	12.0	12.8
Max. Overcurrent Protection (Amps)	15	15	15	15
PIPE CONN. SIZE (IN.)	1/2	1/2	1/2	1/2
DIMENSIONS	H x W x D	H x W x D	H x W x D	H x W x D
Crated (In.)	41-3/4 x 19-1/2 x 30-1/2	41-3/4 x 19-1/2 x 30-1/2	41-3/4 x 23 x 30-1/2	41-3/4 x 23 x 30-1/2
WEIGHT				
Shipping (Lbs.) / Net (Lbs)	151 / 141	153 / 143	162 / 151	162 / 151

① Central Furnace heating designs are certified by AGA and CSA.

② For U.S. applications, above input ratings (BTUH) are up to 2,000 feet, derate 4% per 1,000 feet for elevations above 2,000 feet above sea level. For Canadian applications, above input ratings (BTUH) are up to 4,500 feet, derate 4% per 1,000 feet for elevations above 4,500 feet above sea level.

③ Based on U.S. government standard tests.

④ The above wiring specifications are in accordance with National Electrical Code; however, installations must comply with local codes.



General Data

Product Specifications ^①

MODEL	TUD100C972K	TUD120C954K	TUD120C960K	TUD140C960K
TYPE	Upflow / Horizontal	Upflow / Horizontal	Upflow / Horizontal	Upflow / Horizontal
RATINGS ^②				
Input BTUH	100,000	120,000	120,000	140,000
Capacity BTUH (ICS) ^③	80000	96,000	96,000	111,000
AFUE	80.0	80.0	80.0	80.0
Temp. rise (Min.-Max.) °F.	30 - 60	35 - 65	30 - 60	40 - 70
BLOWER DRIVE	DIRECT	DIRECT	DIRECT	DIRECT
Diameter - Width (In.)	11 x 10	11 x 10	11 x 10	11 x 10
No. Used	1	1	1	1
Speeds (No.)	4	4	4	4
CFM vs. in. w.g.	See Fan Performance Table	See Fan Performance Table	See Fan Performance Table	See Fan Performance Table
Motor HP	3/4	1/2	1/2	3/4
R.P.M.	1100	1075	1075	1075
Volts / Ph / Hz	115/1/60	115/1/60	115/1/60	115/1/60
COMBUSTION FAN - Type	Centrifugal	Centrifugal	Centrifugal	Centrifugal
Drive - No. Speeds	Direct - 1	Direct - 1	Direct - 1	Direct - 1
Motor HP - RPM	1/50 - 3000	1/50 - 3000	1/50 - 3000	1/50 - 3000
Volts / Ph / Hz	115/1/60	115/1/60	115/1/60	115/1/60
FLA	1.0	1.0	1.0	1.0
FILTER — Furnished?	Yes	Yes	Yes	Yes
Type Recommended	High Velocity	High Velocity	High Velocity	High Velocity
Hi Vel. (No.-Size-Thk.)	1 - 24x25 - 1in.	1 - 20x25 - 1in.	1 - 24x25 - 1in.	1 - 24x25 - 1in.
VENT — Size (in.)	4 Round	4 Round	4 Round	4 Round
HEAT EXCHANGER				
Type -Fired	Aluminized Steel - Type I	Aluminized Steel - Type I	Aluminized Steel - Type I	Aluminized Steel - Type I
-Unfired				
Gauge (Fired)	20	20	20	20
ORIFICES — Main				
Nat. Gas. Qty. — Drill Size	5 — 45	6 — 45	6 — 45	7 — 45
L.P. Gas Qty. — Drill Size	5 — 56	6 — 56	6 — 56	7 — 56
GAS VALVE	Redundant - Single Stage	Redundant - Single Stage	Redundant - Single Stage	Redundant - Single Stage
PILOT SAFETY DEVICE				
Type	Hot Surface Ignition	Hot Surface Ignition	Hot Surface Ignition	Hot Surface Ignition
BURNERS — Type	Multi-port In-shot	Multi-port In-shot	Multi-port In-shot	Multi-port In-shot
Number	5	6	6	7
POWER CONN. — V / Ph / Hz ^④	115/1/60	115/1/60	115/1/60	115/1/60
Ampacity (In Amps)	13.1	12.8	12.8	13.1
Max. Overcurrent Protection (Amps)	15	15	15	15
PIPE CONN. SIZE (IN.)	1/2	1/2	1/2	1/2
DIMENSIONS	H x W x D	H x W x D	H x W x D	H x W x D
Crated (In.)	41-3/4 x 26-1/2 x 30-1/2	41-3/4 x 23 x 30-1/2	41-3/4 x 26-1/2 x 30-1/2	41-3/4 x 26-1/2 x 30-1/2
WEIGHT				
Shipping (Lbs.) / Net (Lbs)	175 / 163	176 / 164	186 / 174	193 / 181

① Central Furnace heating designs are certified by AGA and CSA.

② For U.S. applications, above input ratings (BTUH) are up to 2,000 feet, derate 4% per 1,000 feet for elevations above 2,000 feet above sea level. For Canadian applications, above input ratings (BTUH) are up to 4,500 feet, derate 4% per 1,000 feet for elevations above 4,500 feet above sea level.

③ Based on U.S. government standard tests.

④ The above wiring specifications are in accordance with National Electrical Code; however, installations must comply with local codes.



Performance Data

FURNACE AIRFLOW (CFM) VS. STATIC PRESSURE (ins. w.g.)										
MODEL	SPEED TAP	0.10	0.20	0.30	0.40	0.50	0.60	0.70	0.80	0.90
TUD040C924K	4 - HIGH - Black	1018	1004	982	950	910	860	802	763	660
	3 - MED.-HIGH - Blue	847	832	809	779	742	697	644	585	517
	2 - MED.-LOW - Yellow	716	701	678	648	610	585	512	452	384
	1 - LOW - Red	617	599	575	544	507	463	413	357	294
TUD040C930K	4 - HIGH - Black	1307	1262	1211	1164	1092	1023	949	869	783
	3 - MED.-HIGH - Blue	1172	1140	1100	1053	996	937	867	791	707
	2 - MED.-LOW - Yellow	1030	1007	976	938	893	840	779	712	636
	1 - LOW - Red	892	876	856	893	789	744	691	630	561
TUD060C924K	4 - HIGH - Black	1013	997	973	941	901	852	796	731	659
	3 - MED.-HIGH - Blue	835	821	800	771	734	689	636	575	506
	2 - MED.-LOW - Yellow	712	702	683	655	617	571	516	452	379
	1 - LOW - Red	611	596	573	543	505	459	406	345	277
TUD060C936K	4 - HIGH - Black	1426	1389	1345	1298	1236	1171	1099	1020	934
	3 - MED.-HIGH - Blue	1243	1225	1197	1160	1113	1057	991	916	831
	2 - MED.-LOW - Yellow	1042	1039	1027	1005	973	931	879	817	745
	1 - LOW - Red	900	903	895	877	848	809	760	700	629
TUD080C924K	4 - HIGH - Black	1115	1094	1060	1014	956	886	803	708	600
	3 - MED.-HIGH - Blue	919	912	891	857	809	747	671	582	478
	2 - MED.-LOW - Yellow	772	767	750	722	681	629	565	489	401
	1 - LOW - Red	643	655	648	622	577	512	428	325	203
TUD080C936K	4 - HIGH - Black	1393	1384	1364	1335	1296	1247	1189	1120	1042
	3 - MED.-HIGH - Blue	1210	1209	1198	1177	1147	1107	1058	999	930
	2 - MED.-LOW - Yellow	1046	1052	1047	1033	1008	963	928	873	808
	1 - LOW - Red	900	903	895	888	869	842	808	766	717
TUD080C948K	4 - HIGH - Black	1839	1821	1796	1756	1710	1641	1573	1480	1392
	3 - MED.-HIGH - Blue	1323	1325	1329	1319	1308	1275	1246	1201	1165
	2 - MED.-LOW - Yellow	1092	1090	1091	1083	1076	1059	1040	1005	970
	1 - LOW - Red	788	783	780	768	758	737	719	647	630
TUD080C960K	4 - HIGH - Black	2308	2281	2254	2209	2163	2095	2026	1950	1873
	3 - MED.-HIGH - Blue	2006	1997	1987	1960	1933	1888	1842	1780	1718
	2 - MED.-LOW - Yellow	1690	1691	1691	1683	1674	1651	1627	1556	1485
	1 - LOW - Red	1437	1437	1437	1434	1431	1418	1404	1369	1334
TUD100C936K	4 - HIGH - Black	1476	1464	1441	1408	1363	1307	1241	1163	1074
	3 - MED.-HIGH - Blue	1249	1257	1252	1234	1203	1158	1101	1030	946
	2 - MED.-LOW - Yellow	1020	1046	1058	1050	1028	990	936	866	780
	1 - LOW - Red	873	887	890	883	864	834	794	742	680
TUD100C945K	4 - HIGH - Black	1771	1731	1355	1624	1556	1479	1392	1296	1191
	3 - MED.-HIGH - Blue	1375	1371	1328	1328	1289	1238	1176	1102	1016
	2 - MED.-LOW - Yellow	1127	1141	1124	1124	1094	1049	989	914	825
	1 - LOW - Red	780	815	829	822	796	749	681	593	485
TUD100C948K	4 - HIGH - Black	1880	1846	1799	1740	1669	1595	1489	1381	1260
	3 - MED.-HIGH - Blue	1662	1635	1598	1551	1493	1424	1345	1256	1157
	2 - MED.-LOW - Yellow	1428	1421	1402	1370	1326	1269	1199	1117	1022
	1 - LOW - Red	1208	1215	1210	1193	1164	1124	1073	1009	935
TUD100C960K	4 - HIGH - Black	2181	2143	2104	2053	2001	1929	1856	1766	1676
	3 - MED.-HIGH - Blue	1908	1888	1868	1834	1800	1745	1690	1631	1572
	2 - MED.-LOW - Yellow	1621	1609	1597	1582	1567	1533	1498	1438	1377
	1 - LOW - Red	1443	1419	1395	1381	1367	1335	1302	1256	1209



Performance Data

FURNACE AIRFLOW (CFM) VS. STATIC PRESSURE (ins. w.g.)										
MODEL	SPEED TAP	0.10	0.20	0.30	0.40	0.50	0.60	0.70	0.80	0.90
TUD100C972K BOTTOM AND LEFT SIDE RETURN	4 - HIGH - Black 3 - MED.-HIGH - Blue 2 - MED.-LOW - Yellow 1 - LOW - Red	2484	2458	2432	2387	2342	2275	2208	2125	2041
						SEE NOTE 1				
TUD100C972K	4 - HIGH - Black 3 - MED.-HIGH - Blue 2 - MED.-LOW - Yellow 1 - LOW - Red	2447 2097 1753 1459	2401 2088 1750 1456	2356 2079 1748 1453	2303 2053 1732 1443	2249 2028 1716 1434	2173 1970 1690 1407	2097 1912 1665 1380	1994 1831 1594 1335	1892 1750 1523 1289
TUD120C954K	4 - HIGH - Black 3 - MED.-HIGH - Blue 2 - MED.-LOW - Yellow 1 - LOW - Red	2162 1889 1654 1427	2130 1881 1643 1421	2097 1873 1631 1414	2067 1839 1619 1400	2037 1805 1606 1386	1976 1776 1572 1357	1914 1746 1538 1327	1833 1670 1483 1285	1752 1593 1428 1243
TUD120C960K	4 - HIGH - Black 3 - MED.-HIGH - Blue 2 - MED.-LOW - Yellow 1 - LOW - Red	2135 1906 1646 1423	2101 18814 1632 1415	2066 1856 1617 1407	2036 1817 1596 1391	2005 1777 1575 1375	1923 1724 1535 1338	1840 1671 1494 1300	1750 1602 1427 1246	1659 1533 1360 1192
TUD140C960K	4 - HIGH - Black 3 - MED.-HIGH - Blue 2 - MED.-LOW - Yellow 1 - LOW - Red	2462 2128 1755 1450	2407 2112 1746 1446	2351 2096 1736 1442	2284 2054 1719 1427	2216 2011 1702 1411	2143 1949 1656 1383	2069 1887 1609 1354	1989 1797 1564 1298	1908 1706 1518 1241

Note 1: High speed CFM is based on bottom and left side return option for this model. Medium High, Medium Low, and Low speed taps for this model do not have improved airflow with the addition of side return.

CFM VS. TEMPERATURE RISE																					
MODEL	Cubic Feet Per Minute (CFM)																				
	500	600	700	800	900	1000	1100	1200	1300	1400	1500	1600	1700	1800	1900	2000	2100	2200	2300	2400	
TUD040C924K	59	49	42	37	33	30															
TUD040C930K	59	49	42	37	33																
TUD060C924K			63	56	49	44															
TUD060C936K				56	49	44	40	37	34	32											
TUD080C924K				74	66	59	54														
TUD080C936K					59	54	49	46	42												
TUD080C948K					59	54	49	46	42	40	37	35	33								
TUD080C960K						54	49	46	42	40	37	35	33	31	30	28	27	26			
TUD100C936K							67	62	57	53	49										
TUD100C945K								62	57	53	49	46	44	41							
TUD100C948K							67	62	57	53	49	46	44	41	39	37					
TUD100C960K								62	57	53	49	46	44	41	39	37	35	34	32	31	
TUD100C972K								62	57	53	49	46	44	41	39	37	35	34	32	31	
TUD120C954K										63	59	56	52	49	47	44	42	40			
TUD120C960K											59	56	52	49	47	44	42	40			
TUD140C960K												69	65	61	58	55	52	49	47	45	

Field Wiring

Field Wiring Diagram For Heating Only

NOTES

1. BE SURE POWER SUPPLY AGREES WITH EQUIPMENT NAMEPLATE(S).
2. LOW VOLTAGE (24V.) WIRING TO BE NO. 18 A.W.G. MIN.
3. GROUNDING OF EQUIPMENT MUST COMPLY WITH LOCAL CODES.
4. SET THERMOSTAT HEAT ANTICIPATOR PER UNIT WIRING DIAGRAM.
5. 24V COMMON CONNECTION MAY BE REQUIRED FOR USE WITH ELECTRONIC THERMOSTATS.

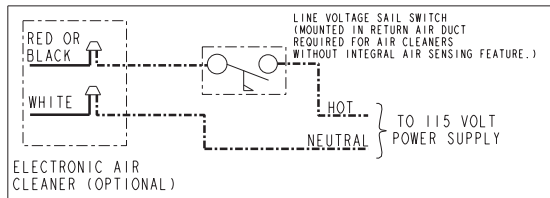
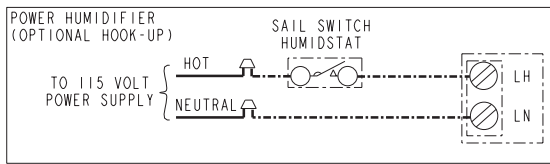

INTER-COMPONENT WIRING

----- 24 V. } FIELD
 ----- LINE V. } WIRING

===== 24 V. } FACTORY
 ===== LINE V. } WIRING

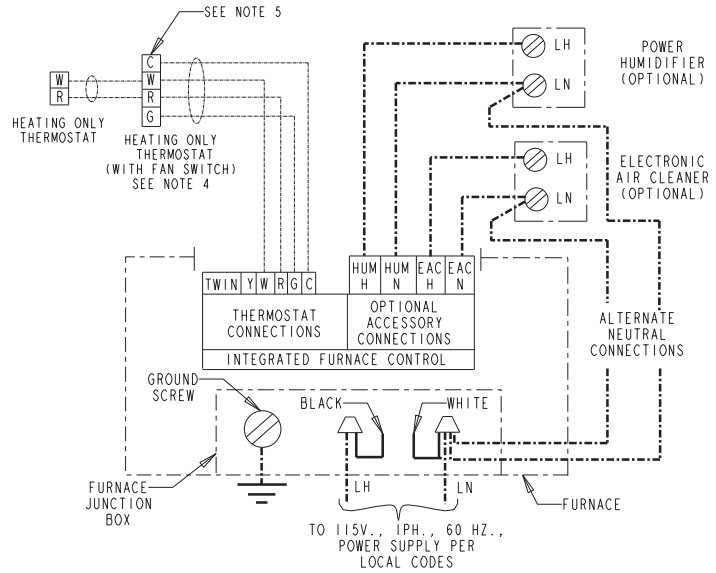

From Dwg. 21B341437 Rev. 1

Field Wiring Diagram For Single Stage Heating/Cooling (Outdoor Section Without Transformer)

NOTES

1. BE SURE POWER SUPPLY AGREES WITH EQUIPMENT NAMEPLATE(S).
2. LOW VOLTAGE (24V.) WIRING TO BE NO. 18 A.W.G. MIN.
3. GROUNDING OF EQUIPMENT MUST COMPLY WITH LOCAL CODES.
4. SET THERMOSTAT HEAT ANTICIPATOR PER UNIT WIRING DIAGRAM.
5. THE "Y" TERMINAL FROM THE THERMOSTAT MUST BE WIRED TO THE "Y" TERMINAL OF THE FURNACE CONTROL FOR PROPER BLOWER OPERATION DURING COOLING.
6. 24V COMMON CONNECTION MAY BE REQUIRED FOR USE WITH ELECTRONIC THERMOSTATS.

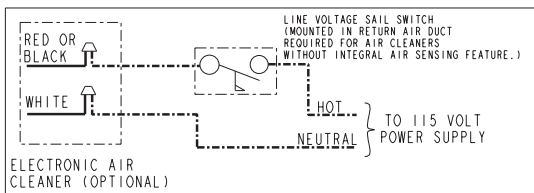
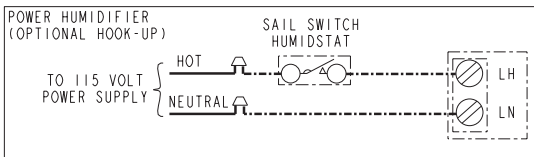

INTER-COMPONENT WIRING

----- 24 V. } FIELD
 ----- LINE V. } WIRING

===== 24 V. } FACTORY
 ===== LINE V. } WIRING

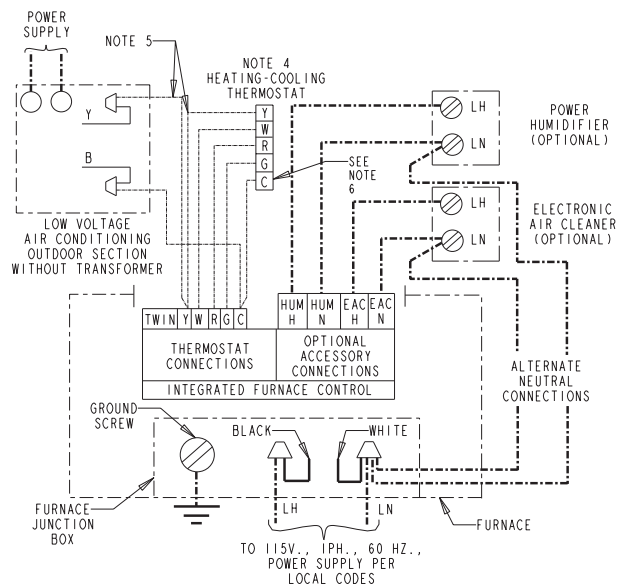

From Dwg. 21B341436 Rev. 1

Twinning Field Wiring

**TWINNING CONNECTION DIAGRAM
FOR TWINNING 1 STAGE FURNACES
WITH SINGLE WIRE TWINNING FEATURE
1 STAGE HEATING ONLY THERMOSTAT**

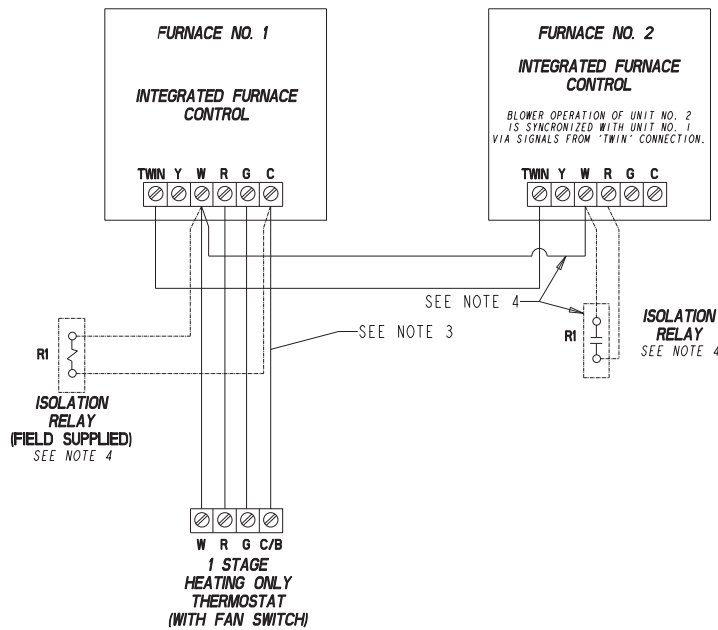

NOTES:

- 1.) BOTH FURNACES MUST BE POWERED FROM THE SAME 115V. LEG OF CIRCUIT PANEL.
- 2.) INSURE 24V. FURNACE TRANSFORMERS ARE IN PHASE. PRIOR TO COMPLETING CONNECTIONS, CHECK VOLTAGE BETWEEN 'R' TERMINALS OF EACH FURNACE. IF VOLTAGE IS GREATER THAN 10V., REVERSE THE BL AND RD SECONDARY LEADS ON ONE OF THE FURNACE TRANSFORMERS.
- 3.) CONNECTION MAY BE REQUIRED FOR ELECTRONIC THERMOSTAT.
- 4.) IF CURRENT EXCEEDS THERMOSTAT CURRENT RATING, USE ISOLATION RELAYS ('RI') AS SHOWN. (DO NOT CONNECT W TO W) ISOLATION RELAY NOT NEEDED IF THE THERMOSTAT CONTACTS ARE RATED AT 1.0A. OR ABOVE.

----- ALTERNATE WIRING CONFIGURATION SEE NOTE 4.

From Dwg. 21B341422 Rev. 1

**TWINNING CONNECTION DIAGRAM
FOR TWINNING 1 STAGE FURNACES
WITH SINGLE WIRE TWINNING FEATURE
1 STAGE HEAT / 1 STAGE COOLING THERMOSTAT**

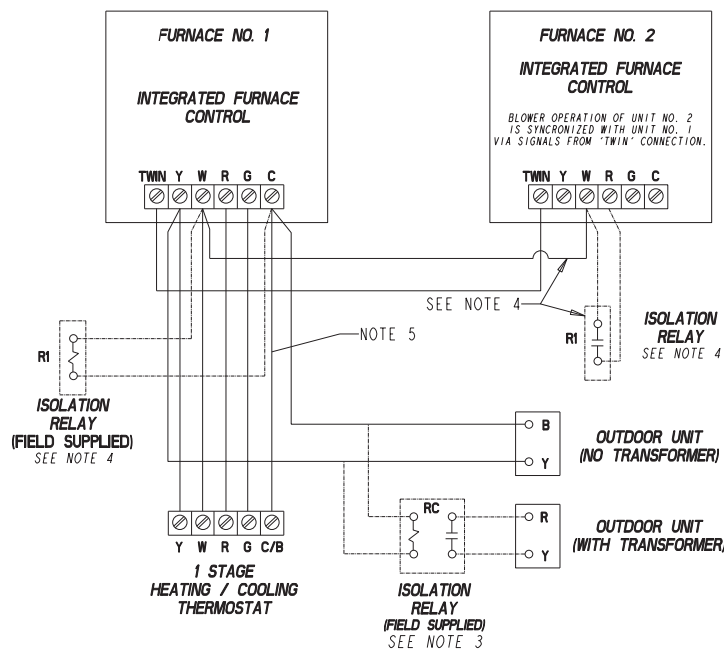

NOTES:

- 1.) BOTH FURNACES MUST BE POWERED FROM THE SAME 115V. LEG OF CIRCUIT PANEL.
- 2.) INSURE 24V. FURNACE TRANSFORMERS ARE IN PHASE. PRIOR TO COMPLETING CONNECTIONS, CHECK VOLTAGE BETWEEN 'R' TERMINALS OF EACH FURNACE. IF VOLTAGE IS GREATER THAN 10V., REVERSE THE BL AND RD SECONDARY LEADS ON ONE OF THE FURNACE TRANSFORMERS.
- 3.) IF OUTDOOR UNIT HAS A 24V. TRANSFORMER, AN ISOLATION RELAY MUST BE INSTALLED. (FIELD SUPPLIED - USE PILOT DUTY RELAY ('RC'), SUCH AS RLY0975.) SEE ALT. CONNECTION.
- 4.) IF CURRENT EXCEEDS THERMOSTAT CURRENT RATING, USE ISOLATION RELAYS ('RI') AS SHOWN. (DO NOT CONNECT W TO W) ISOLATION RELAY NOT NEEDED IF THE THERMOSTAT CONTACTS ARE RATED AT 1.0A. OR ABOVE.
- 5.) CONNECTION MAY BE REQUIRED FOR ELECTRONIC THERMOSTATS.

----- ALTERNATE WIRING CONFIGURATION SEE NOTE 4.

From Dwg. 21B341423 Rev. 1

TUD-C Outline Drawing

(All dimensions are in inches)

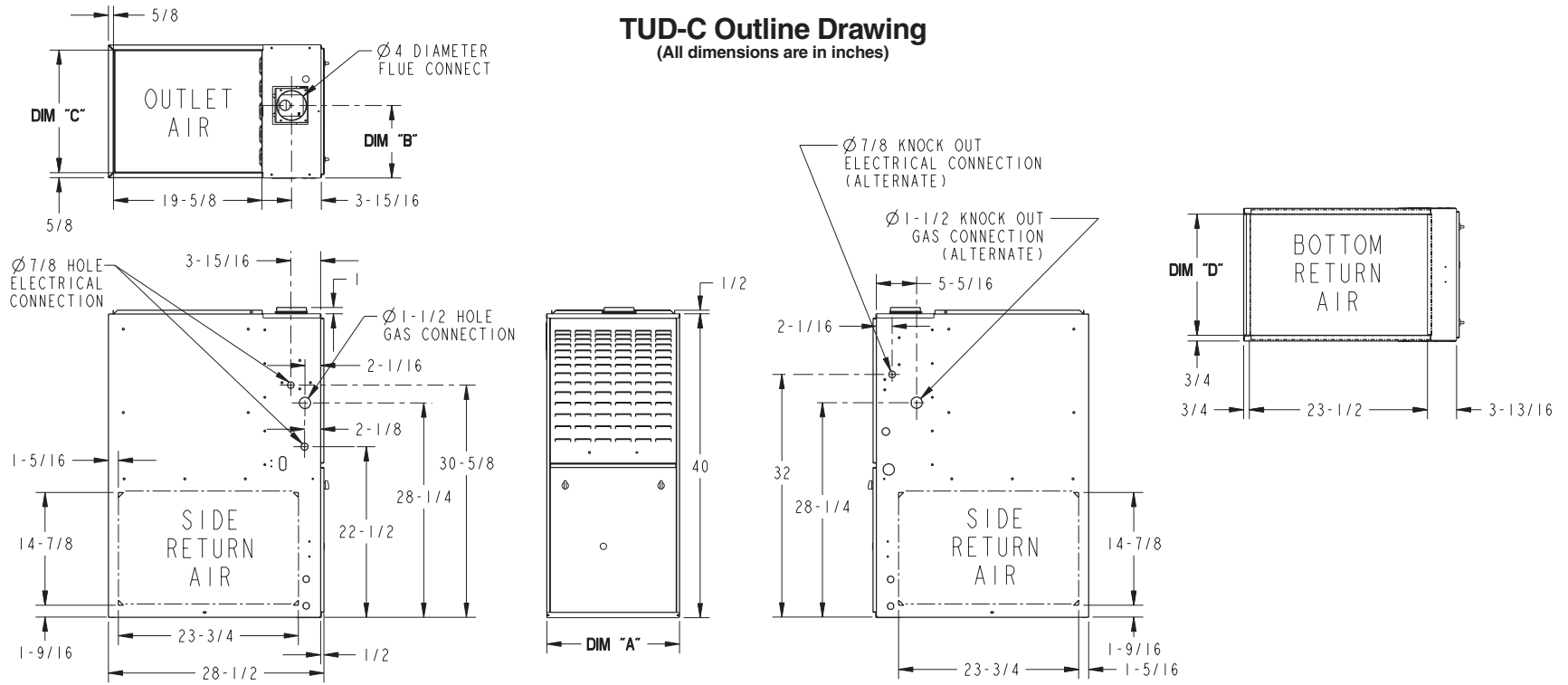

MODEL	DIM "A"	DIM "B"	DIM "C"	DIM "D"
*UD040C924**				
*UD040C930**				
*UD060C924**	14-1/2"	9-5/8"	13-1/4"	13"
*UD060C936**				
*UD080C924**				
*UD080C936**				
*UD080C948**				
*UD100C936**	17-1/2"	9-5/8"	16-1/4"	16"
*UD100C945**				
*UD100C945**				
*UD080C960**				
*UD100C948**				
*UD100C960**	21"	13-1/16"	19-3/4"	19-1/2"
*UD120C954**				
*UD100C972**				
*UD120C960**	24-1/2"	15-5/16"	23-1/4"	23"
*UD140C960**				

* PREFIX LETTER MAY BE "A" OR "T"
 ** SUFFIX LETTERS MAY BE "K" (O THROUGH 9)

MINIMUM CLEARANCE TO COMBUSTIBLE MATERIALS			
<u>UPFLOW CLOSET</u>			
LEFT SIDE	0 IN.	FRONT	3 IN. (SEE NOTE 1)
RIGHT SIDE	+0 IN.	BACK	0 IN.
FLUE	#6 IN.	TOP	1 IN.
<u>HORIZONTAL CLOSET (SEE NOTE 2)</u>			
TOP	+2 IN.	BACK	3 IN.
FLUE	#6 IN.	SIDES	1 IN.
FRONT	18 IN.	(SEE NOTE 1)	
<u>HORIZONTAL ALCOVE (SEE NOTE 2)</u>			
TOP	+1 IN.	BACK	0 IN.
FLUE	#6 IN.	SIDES	0 IN.
FRONT	18 IN.		
# - MAY BE 1" WHEN TYPE B-1 VENT IS USED + - FOR 14-1/2" CABINETS 3" WHEN SINGLE WALL VENT PIPE IS USED. WHEN 14-1/2" CABINETS (ALL *UD040C-, *UD040R-, *UD060C-, AND *UD060R936) ARE INSTALLED IN A HORIZONTAL POSITION AND A SINGLE WALL VENT PIPE IS USED, A 6 INCH CLEARANCE MUST BE SUPPLIED BETWEEN THE VENT PIPE AND COMBUSTIBLE FLOORING.			
<u>NOTES:</u>			
1) MINIMUM CLEARANCE TO FRONT ON *UD140R960 AND *UD140C960 IS 6 INCHES.			
2) MAY BE INSTALLED ON COMBUSTIBLE FLOOR WHEN TYPE B-1 VENT IS USED.			

From Dwg. 21C341699 Rev. 1

Electrical Data

Schematic Diagrams for Gas Furnaces

LEGEND-EQUIPMENT DIAGRAM

- 24 V. LINE V. } FACTORY WIRING
- - - 24 V. LINE V. } FIELD WIRING
- ⊥ EARTH GROUND
- ⊥ CHASSIS GROUND
- JUNCTION
- WIRE NUT OR CONNECTOR
- ⊂ COIL
- ⊂ CAPACITOR
- ⊂ TRANSFORMER
- ⊂ CONNECTOR
- ⊂ TEMP. ACTUATED SWITCH
- ⊂ PRESS. ACTUATED SWITCH
- ⊂ DOOR SWITCH
- ⊂ MANUAL RESET TEMP ACTUATED SWITCH
- ⊂ FUSIBLE LINK
- TERMINAL
- TERMINAL BOARD
- ⊂ COLOR OF WIRE
BK/BL BLACK WIRE WITH BLUE MARKER
- ⊂ COLOR OF MARKER
BK BLACK OR ORANGE YL YELLOW
BL BLUE RD RED GR GREEN
BR BROWN WH WHITE PR PURPLE
- GV GAS VALVE
- CF FAN CAPACITOR
- GND GROUND
- L LINE
- LVTB LOW VOLTAGE TERMINAL BOARD
- MTR MOTOR
- N NEUTRAL
- TCO HIGH TEMPERATURE LIMIT SWITCH
- TNS TRANSFORMER
- B/C COMMON
- PS PRES. SWITCH
- HLI HIGH LIMIT INPUT
- HLO HIGH LIMIT OUTPUT
- FP FLAME SENSOR PROBE
- MV GAS VALVE
- TR 24V AC TRANS. COMMON SIDE
- TH 24V AC TRANS. HOT SIDE
- R REDUNDANT
- ⊂ INTERNAL THERMAL PROTECTION

UD-C

TABLE A SPEED TAPS FOR I. D. FAN MOTOR			
MODELS	HEAT 'A'	PARK 'B'	PARK 'C'
•UD040C924K	YL	RD	BL
•UD040C930K	RD	BL	YL
•UD060C924K	BL	RD	YL
•UD060C936K	YL	RD	BL
•UD080C924K	BL	RD	YL
•UD080C936K	BL	RD	YL
•UD080C948K	BL	RD	YL
•UD080C960K	RD	BL	YL
•UD100C936K	BL	RD	YL
•UD100C945K	BL	RD	YL
•UD100C948K	BL	RD	YL
•UD100C960K	YL	BL	RD
•UD100C972K	RD	YL	BL
•UD120C954K	BL	RD	YL
•UD120C960K	BL	RD	YL
•UD140C960K	BL	RD	YL

(1) RED - LOW
(2) YELLOW - MED. LOW
(3) BLUE - MED. HIGH
(4) BLACK - HIGH

* MAY BE PREFIX "A" OR "T"

115 VOLT 60 HZ. 1PH. POWER SUPPLY
PER LOCAL CODES

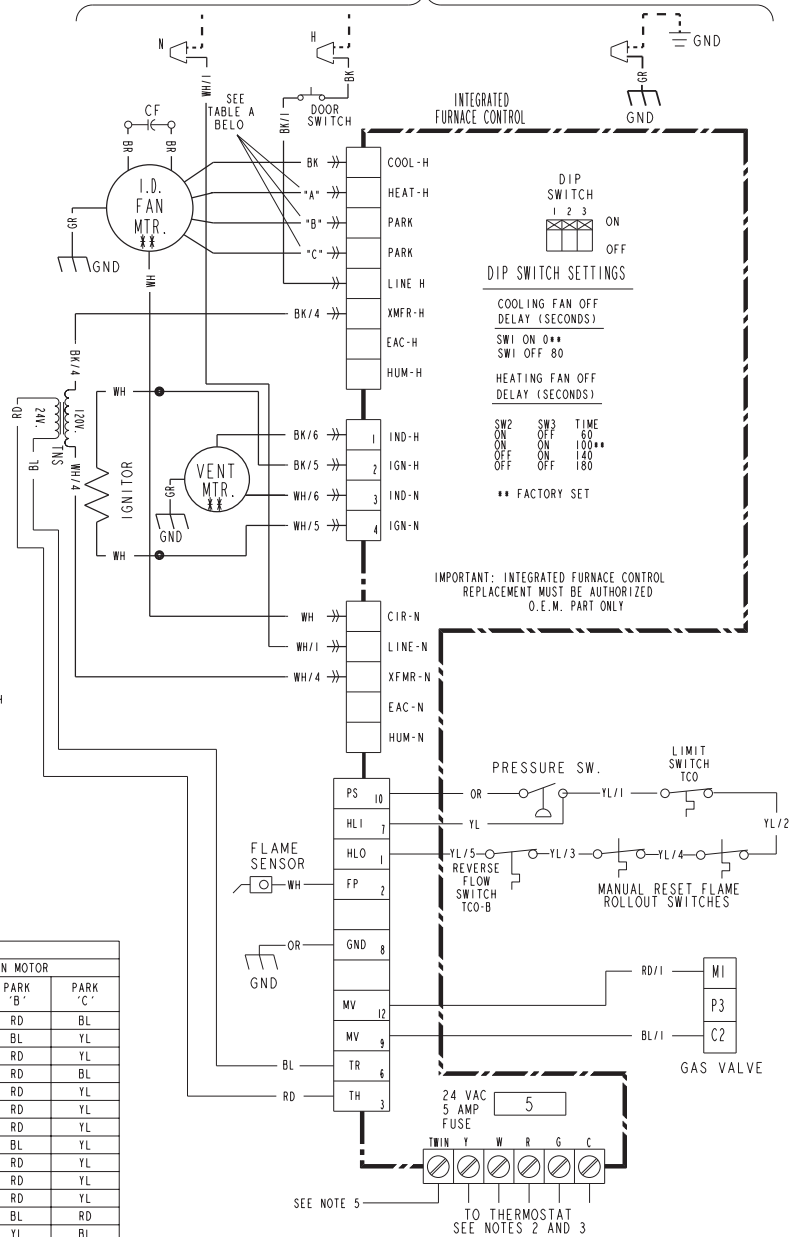

NOTES:

1. IF ANY OF THE ORIGINAL WIRE AS SUPPLIED WITH THE FURNACE MUST BE REPLACED, IT MUST BE REPLACED WITH WIRING MATERIAL HAVING A TEMPERATURE RATING OF AT LEAST 105 °C.
2. THERMOSTAT HEAT ANTICIPATOR SETTING: .38 AMPS.
3. FOR PROPER OPERATION OF COOLING FAN SPEED, "Y" TERMINAL MUST BE CONNECTED TO ROOM THERMOSTAT.
4. THESE TERMINALS PROVIDE 120V POWER FOR CONNECTION OF ELECTRONIC AIR CLEANER AND HUMIDIFIER. MAX. LOAD 1.0 AMPS EACH.
5. WHEN TWINNING TWO FURNACES, BOTH UNITS MUST BE CONNECTED TO THE SAME 115VAC PHASE. CONNECT THE TWO UNITS 'TWIN' TERMINALS WITH 14 TO 22AWG. WIRE.



TRANE[®]

Trane
A business of
American Standard Companies
www.trane.com

Literature Order Number	FURN-PRC001-EN	P.I.
File Number	—	
Supersedes	TUD-D-1 3/98	
Stocking Location	PI Louisville & Webb/Mason-Houston	7/02

Trane has a policy of continuous product and product data improvement and it reserves the right to change design and specifications without notice.

Free Manuals Download Website

<http://myh66.com>

<http://usermanuals.us>

<http://www.somanuals.com>

<http://www.4manuals.cc>

<http://www.manual-lib.com>

<http://www.404manual.com>

<http://www.luxmanual.com>

<http://aubethermostatmanual.com>

Golf course search by state

<http://golfingnear.com>

Email search by domain

<http://emailbydomain.com>

Auto manuals search

<http://auto.somanuals.com>

TV manuals search

<http://tv.somanuals.com>